

EL SOLUCIONARIO

EL SOLUCIONARIO

<http://www.elsolucionario.blogspot.com>



LIBROS UNIVERISTARIOS
Y SOLUCIONARIOS DE
MUCHOS DE ESTOS LIBROS

LOS SOLUCIONARIOS
CONTIENEN TODOS LOS
EJERCICIOS DEL LIBRO
RESUELTOS Y EXPLICADOS
DE FORMA CLARA

VISITANOS PARA
DESARGALOS GRATIS.

Chapter 1

INTRODUCTION AND BASIC CONCEPTS

Thermodynamics and Heat Transfer

1-1C Thermodynamics deals with the amount of heat transfer as a system undergoes a process from one equilibrium state to another. Heat transfer, on the other hand, deals with the rate of heat transfer as well as the temperature distribution within the system at a specified time.

1-2C (a) The driving force for heat transfer is the temperature difference. (b) The driving force for electric current flow is the electric potential difference (voltage). (a) The driving force for fluid flow is the pressure difference.

1-3C The caloric theory is based on the assumption that heat is a fluid-like substance called the "caloric" which is a massless, colorless, odorless substance. It was abandoned in the middle of the nineteenth century after it was shown that there is no such thing as the caloric.

1-4C The *rating* problems deal with the determination of the *heat transfer rate* for an existing system at a specified temperature difference. The *sizing* problems deal with the determination of the *size* of a system in order to transfer heat at a *specified rate* for a *specified temperature difference*.

1-5C The experimental approach (testing and taking measurements) has the advantage of dealing with the actual physical system, and getting a physical value within the limits of experimental error. However, this approach is expensive, time consuming, and often impractical. The analytical approach (analysis or calculations) has the advantage that it is fast and inexpensive, but the results obtained are subject to the accuracy of the assumptions and idealizations made in the analysis.

1-6C Modeling makes it possible to predict the course of an event before it actually occurs, or to study various aspects of an event mathematically without actually running expensive and time-consuming experiments. When preparing a mathematical model, all the variables that affect the phenomena are identified, reasonable assumptions and approximations are made, and the interdependence of these variables are studied. The relevant physical laws and principles are invoked, and the problem is formulated mathematically. Finally, the problem is solved using an appropriate approach, and the results are interpreted.

1-7C The right choice between a crude and complex model is usually the *simplest* model which yields *adequate* results. Preparing very accurate but complex models is not necessarily a better choice since such models are not much use to an analyst if they are very difficult and time consuming to solve. At the minimum, the model should reflect the essential features of the physical problem it represents.

Heat and Other Forms of Energy

1-8C The rate of heat transfer per unit surface area is called heat flux \dot{q} . It is related to the rate of heat transfer by $\dot{Q} = \int_A \dot{q} dA$.

1-9C Energy can be transferred by heat, work, and mass. An energy transfer is heat transfer when its driving force is temperature difference.

1-10C Thermal energy is the sensible and latent forms of internal energy, and it is referred to as heat in daily life.

1-11C For the constant pressure case. This is because the heat transfer to an ideal gas is $mc_p\Delta T$ at constant pressure and $mc_v\Delta T$ at constant volume, and c_p is always greater than c_v .

1-12 A cylindrical resistor on a circuit board dissipates 0.8 W of power. The amount of heat dissipated in 24 h, the heat flux, and the fraction of heat dissipated from the top and bottom surfaces are to be determined.

Assumptions Heat is transferred uniformly from all surfaces.

Analysis (a) The amount of heat this resistor dissipates during a 24-hour period is

$$Q = \dot{Q}\Delta t = (0.8 \text{ W})(24 \text{ h}) = \mathbf{19.2 \text{ Wh}} = \mathbf{69.1 \text{ kJ}} \quad (\text{since } 1 \text{ Wh} = 3600 \text{ Ws} = 3.6 \text{ kJ})$$

(b) The heat flux on the surface of the resistor is

$$A_s = 2 \frac{\pi D^2}{4} + \pi DL = 2 \frac{\pi (0.4 \text{ cm})^2}{4} + \pi (0.4 \text{ cm})(2 \text{ cm}) = 0.251 + 2.513 = 2.764 \text{ cm}^2$$

$$\dot{q}_s = \frac{\dot{Q}}{A_s} = \frac{0.80 \text{ W}}{2.764 \text{ cm}^2} = \mathbf{0.289 \text{ W/cm}^2}$$

(c) Assuming the heat transfer coefficient to be uniform, heat transfer is proportional to the surface area. Then the fraction of heat dissipated from the top and bottom surfaces of the resistor becomes

$$\frac{Q_{\text{top-base}}}{Q_{\text{total}}} = \frac{A_{\text{top-base}}}{A_{\text{total}}} = \frac{0.251}{2.764} = \mathbf{0.091} \text{ or } (9.1\%)$$

Discussion Heat transfer from the top and bottom surfaces is small relative to that transferred from the side surface.

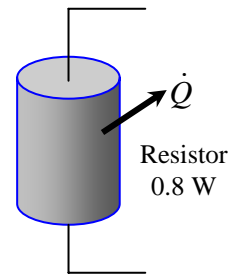

1-13E A logic chip in a computer dissipates 3 W of power. The amount heat dissipated in 8 h and the heat flux on the surface of the chip are to be determined.

Assumptions Heat transfer from the surface is uniform.

Analysis (a) The amount of heat the chip dissipates during an 8-hour period is

$$Q = \dot{Q}\Delta t = (3 \text{ W})(8 \text{ h}) = 24 \text{ Wh} = \mathbf{0.024 \text{ kWh}}$$

(b) The heat flux on the surface of the chip is

$$\dot{q} = \frac{\dot{Q}}{A} = \frac{3 \text{ W}}{0.08 \text{ in}^2} = \mathbf{37.5 \text{ W/in}^2}$$

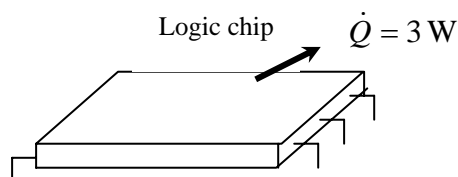

1-14 The filament of a 150 W incandescent lamp is 5 cm long and has a diameter of 0.5 mm. The heat flux on the surface of the filament, the heat flux on the surface of the glass bulb, and the annual electricity cost of the bulb are to be determined.

Assumptions Heat transfer from the surface of the filament and the bulb of the lamp is uniform.

Analysis (a) The heat transfer surface area and the heat flux on the surface of the filament are

$$A_s = \pi DL = \pi(0.05 \text{ cm})(5 \text{ cm}) = 0.785 \text{ cm}^2$$

$$\dot{q}_s = \frac{\dot{Q}}{A_s} = \frac{150 \text{ W}}{0.785 \text{ cm}^2} = 191 \text{ W/cm}^2 = \mathbf{1.91 \times 10^6 \text{ W/m}^2}$$

(b) The heat flux on the surface of glass bulb is

$$A_s = \pi D^2 = \pi(8 \text{ cm})^2 = 201.1 \text{ cm}^2$$

$$\dot{q}_s = \frac{\dot{Q}}{A_s} = \frac{150 \text{ W}}{201.1 \text{ cm}^2} = 0.75 \text{ W/cm}^2 = \mathbf{7500 \text{ W/m}^2}$$

(c) The amount and cost of electrical energy consumed during a one-year period is

$$\text{Electricity Consumption} = \dot{Q}\Delta t = (0.15 \text{ kW})(365 \times 8 \text{ h/yr}) = 438 \text{ kWh/yr}$$

$$\text{Annual Cost} = (438 \text{ kWh/yr})(\$0.08 / \text{kWh}) = \mathbf{\$35.04/\text{yr}}$$

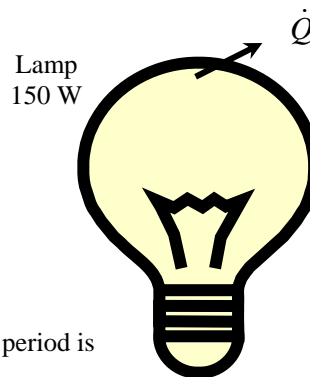

1-15 A 1200 W iron is left on the ironing board with its base exposed to the air. The amount of heat the iron dissipates in 2 h, the heat flux on the surface of the iron base, and the cost of the electricity are to be determined.

Assumptions Heat transfer from the surface is uniform.

Analysis (a) The amount of heat the iron dissipates during a 2-h period is

$$Q = \dot{Q}\Delta t = (1.2 \text{ kW})(2 \text{ h}) = \mathbf{2.4 \text{ kWh}}$$

(b) The heat flux on the surface of the iron base is

$$\dot{Q}_{\text{base}} = (0.85)(1200 \text{ W}) = 1020 \text{ W}$$

$$\dot{q} = \frac{\dot{Q}_{\text{base}}}{A_{\text{base}}} = \frac{1020 \text{ W}}{0.015 \text{ m}^2} = \mathbf{68,000 \text{ W/m}^2}$$

(c) The cost of electricity consumed during this period is

$$\text{Cost of electricity} = (2.4 \text{ kWh}) \times (\$0.07 / \text{kWh}) = \mathbf{\$0.17}$$

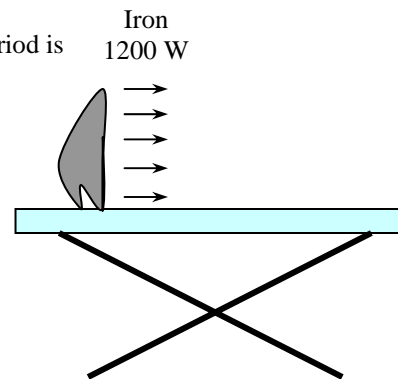

1-16 A 15 cm × 20 cm circuit board houses 120 closely spaced 0.12 W logic chips. The amount of heat dissipated in 10 h and the heat flux on the surface of the circuit board are to be determined.

Assumptions **1** Heat transfer from the back surface of the board is negligible. **2** Heat transfer from the front surface is uniform.

Analysis (a) The amount of heat this circuit board dissipates during a 10-h period is

$$\dot{Q} = (120)(0.12 \text{ W}) = 14.4 \text{ W}$$

$$Q = \dot{Q}\Delta t = (0.0144 \text{ kW})(10 \text{ h}) = \mathbf{0.144 \text{ kWh}}$$

(b) The heat flux on the surface of the circuit board is

$$A_s = (0.15 \text{ m})(0.2 \text{ m}) = 0.03 \text{ m}^2$$

$$\dot{q}_s = \frac{\dot{Q}}{A_s} = \frac{14.4 \text{ W}}{0.03 \text{ m}^2} = \mathbf{480 \text{ W/m}^2}$$

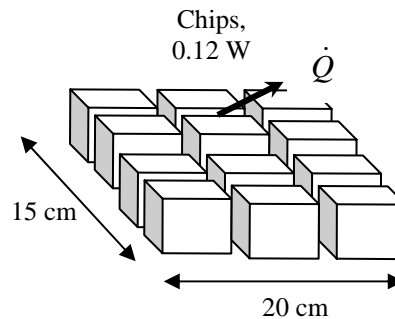

1-17 An aluminum ball is to be heated from 80°C to 200°C. The amount of heat that needs to be transferred to the aluminum ball is to be determined.

Assumptions The properties of the aluminum ball are constant.

Properties The average density and specific heat of aluminum are given to be $\rho = 2700 \text{ kg/m}^3$ and $c_p = 0.90 \text{ kJ/kg}\cdot^\circ\text{C}$.

Analysis The amount of energy added to the ball is simply the change in its internal energy, and is determined from

$$E_{\text{transfer}} = \Delta U = mc_p(T_2 - T_1)$$

where

$$m = \rho V = \frac{\pi}{6} \rho D^3 = \frac{\pi}{6} (2700 \text{ kg/m}^3)(0.15 \text{ m})^3 = 4.77 \text{ kg}$$

Substituting,

$$E_{\text{transfer}} = (4.77 \text{ kg})(0.90 \text{ kJ/kg}\cdot^\circ\text{C})(200 - 80)^\circ\text{C} = \mathbf{515 \text{ kJ}}$$

Therefore, 515 kJ of energy (heat or work such as electrical energy) needs to be transferred to the aluminum ball to heat it to 200°C.

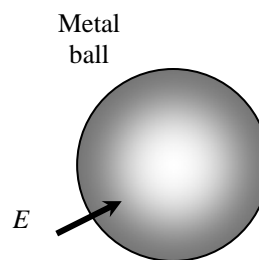

1-18 The body temperature of a man rises from 37°C to 39°C during strenuous exercise. The resulting increase in the thermal energy content of the body is to be determined.

Assumptions The body temperature changes uniformly.

Properties The average specific heat of the human body is given to be 3.6 kJ/kg·°C.

Analysis The change in the sensible internal energy content of the body as a result of the body temperature rising 2°C during strenuous exercise is

$$\Delta U = mc_p \Delta T = (80 \text{ kg})(3.6 \text{ kJ/kg}\cdot^\circ\text{C})(2^\circ\text{C}) = \mathbf{576 \text{ kJ}}$$

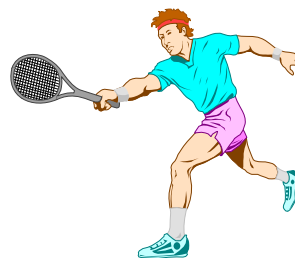

1-19 An electrically heated house maintained at 22°C experiences infiltration losses at a rate of 0.7 ACH. The amount of energy loss from the house due to infiltration per day and its cost are to be determined.

Assumptions 1 Air as an ideal gas with a constant specific heats at room temperature. **2** The volume occupied by the furniture and other belongings is negligible. **3** The house is maintained at a constant temperature and pressure at all times. **4** The infiltrating air exfiltrates at the indoors temperature of 22°C.

Properties The specific heat of air at room temperature is $c_p = 1.007 \text{ kJ/kg}\cdot^\circ\text{C}$.

Analysis The volume of the air in the house is

$$V = (\text{floor space})(\text{height}) = (200 \text{ m}^2)(3 \text{ m}) = 600 \text{ m}^3$$

Noting that the infiltration rate is 0.7 ACH (air changes per hour) and thus the air in the house is completely replaced by the outdoor air $0.7 \times 24 = 16.8$ times per day, the mass flow rate of air through the house due to infiltration is

$$\begin{aligned} \dot{m}_{\text{air}} &= \frac{P_o \dot{V}_{\text{air}}}{RT_o} = \frac{P_o (\text{ACH} \times V_{\text{house}})}{RT_o} \\ &= \frac{(89.6 \text{ kPa})(16.8 \times 600 \text{ m}^3 / \text{day})}{(0.287 \text{ kPa} \cdot \text{m}^3 / \text{kg} \cdot \text{K})(5 + 273.15 \text{ K})} = 11,314 \text{ kg/day} \end{aligned}$$

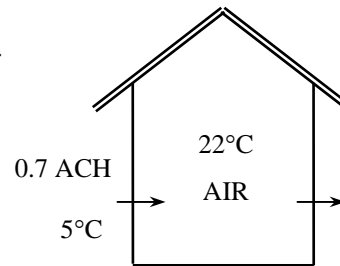

Noting that outdoor air enters at 5°C and leaves at 22°C, the energy loss of this house per day is

$$\begin{aligned} \dot{Q}_{\text{infiltration}} &= \dot{m}_{\text{air}} c_p (T_{\text{indoors}} - T_{\text{outdoors}}) \\ &= (11,314 \text{ kg/day})(1.007 \text{ kJ/kg}\cdot^\circ\text{C})(22 - 5)^\circ\text{C} = 193,681 \text{ kJ/day} = \mathbf{53.8 \text{ kWh/day}} \end{aligned}$$

At a unit cost of \$0.082/kWh, the cost of this electrical energy lost by infiltration is

$$\text{Energy Cost} = (\text{Energy used})(\text{Unit cost of energy}) = (53.8 \text{ kWh/day})(\$0.082/\text{kWh}) = \mathbf{\$4.41/\text{day}}$$

1-20 A house is heated from 10°C to 22°C by an electric heater, and some air escapes through the cracks as the heated air in the house expands at constant pressure. The amount of heat transfer to the air and its cost are to be determined.

Assumptions 1 Air as an ideal gas with a constant specific heats at room temperature. **2** The volume occupied by the furniture and other belongings is negligible. **3** The pressure in the house remains constant at all times. **4** Heat loss from the house to the outdoors is negligible during heating. **5** The air leaks out at 22°C.

Properties The specific heat of air at room temperature is $c_p = 1.007 \text{ kJ/kg}\cdot^\circ\text{C}$.

Analysis The volume and mass of the air in the house are

$$V = (\text{floor space})(\text{height}) = (200 \text{ m}^2)(3 \text{ m}) = 600 \text{ m}^3$$

$$m = \frac{PV}{RT} = \frac{(101.3 \text{ kPa})(600 \text{ m}^3)}{(0.287 \text{ kPa}\cdot\text{m}^3/\text{kg}\cdot\text{K})(10 + 273.15 \text{ K})} = 747.9 \text{ kg}$$

Noting that the pressure in the house remains constant during heating, the amount of heat that must be transferred to the air in the house as it is heated from 10 to 22°C is determined to be

$$Q = mc_p(T_2 - T_1) = (747.9 \text{ kg})(1.007 \text{ kJ/kg}\cdot^\circ\text{C})(22 - 10)^\circ\text{C} = \mathbf{9038 \text{ kJ}}$$

Noting that 1 kWh = 3600 kJ, the cost of this electrical energy at a unit cost of \$0.075/kWh is

$$\text{Energy Cost} = (\text{Energy used})(\text{Unit cost of energy}) = (9038 / 3600 \text{ kWh})(\$0.075/\text{kWh}) = \mathbf{\$0.19}$$

Therefore, it will cost the homeowner about 19 cents to raise the temperature in his house from 10 to 22°C.

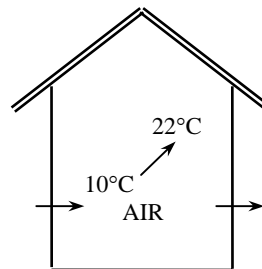

1-21E A water heater is initially filled with water at 45°F. The amount of energy that needs to be transferred to the water to raise its temperature to 120°F is to be determined.

Assumptions 1 Water is an incompressible substance with constant specific heats at room temperature. **2** No water flows in or out of the tank during heating.

Properties The density and specific heat of water are given to be 62 lbm/ft³ and 1.0 Btu/lbm·°F.

Analysis The mass of water in the tank is

$$m = \rho V = (62 \text{ lbm/ft}^3)(60 \text{ gal}) \left(\frac{1 \text{ ft}^3}{7.48 \text{ gal}} \right) = 497.3 \text{ lbm}$$

Then, the amount of heat that must be transferred to the water in the tank as it is heated from 45 to 120°F is determined to be

$$Q = mc_p(T_2 - T_1) = (497.3 \text{ lbm})(1.0 \text{ Btu/lbm}\cdot^\circ\text{F})(120 - 45)^\circ\text{F} = \mathbf{37,300 \text{ Btu}}$$



Energy Balance

1-22C Warmer. Because energy is added to the room air in the form of electrical work.

1-23C Warmer. If we take the room that contains the refrigerator as our system, we will see that electrical work is supplied to this room to run the refrigerator, which is eventually dissipated to the room as waste heat.

1-24 Two identical cars have a head-on collision on a road, and come to a complete rest after the crash. The average temperature rise of the remains of the cars immediately after the crash is to be determined.

Assumptions 1 No heat is transferred from the cars. **2** All the kinetic energy of cars is converted to thermal energy.

Properties The average specific heat of the cars is given to be $0.45 \text{ kJ/kg}\cdot^\circ\text{C}$.

Analysis We take both cars as the system. This is a *closed system* since it involves a fixed amount of mass (no mass transfer). Under the stated assumptions, the energy balance on the system can be expressed as

$$\underbrace{E_{in} - E_{out}}_{\substack{\text{Net energy transfer} \\ \text{by heat, work, and mass}}} = \underbrace{\Delta E_{\text{system}}}_{\substack{\text{Change in internal, kinetic,} \\ \text{potential, etc. energies}}}$$

$$0 = \Delta U_{\text{cars}} + \Delta \text{KE}_{\text{cars}}$$

$$0 = (mc_p \Delta T)_{\text{cars}} + [m(0 - V^2) / 2]_{\text{cars}}$$

That is, the decrease in the kinetic energy of the cars must be equal to the increase in their internal energy. Solving for the velocity and substituting the given quantities, the temperature rise of the cars becomes

$$\Delta T = \frac{mV^2 / 2}{mc_p} = \frac{V^2 / 2}{c_p} = \frac{(90,000 / 3600 \text{ m/s})^2 / 2}{0.45 \text{ kJ/kg}\cdot^\circ\text{C}} \left(\frac{1 \text{ kJ/kg}}{1000 \text{ m}^2/\text{s}^2} \right) = \mathbf{0.69^\circ\text{C}}$$

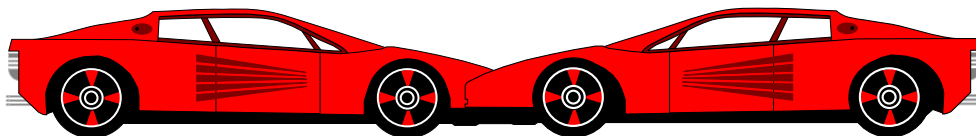

1-25 A classroom is to be air-conditioned using window air-conditioning units. The cooling load is due to people, lights, and heat transfer through the walls and the windows. The number of 5-kW window air conditioning units required is to be determined.

Assumptions There are no heat dissipating equipment (such as computers, TVs, or ranges) in the room.

Analysis The total cooling load of the room is determined from

$$\dot{Q}_{\text{cooling}} = \dot{Q}_{\text{lights}} + \dot{Q}_{\text{people}} + \dot{Q}_{\text{heatgain}}$$

where

$$\dot{Q}_{\text{lights}} = 10 \times 100 \text{ W} = 1 \text{ kW}$$

$$\dot{Q}_{\text{people}} = 40 \times 360 \text{ kJ/h} = 14,400 \text{ kJ/h} = 4 \text{ kW}$$

$$\dot{Q}_{\text{heatgain}} = 15,000 \text{ kJ/h} = 4.17 \text{ kW}$$

Substituting, $\dot{Q}_{\text{cooling}} = 1 + 4 + 4.17 = 9.17 \text{ kW}$

Thus the number of air-conditioning units required is

$$\frac{9.17 \text{ kW}}{5 \text{ kW/unit}} = 1.83 \longrightarrow \mathbf{2 \text{ units}}$$

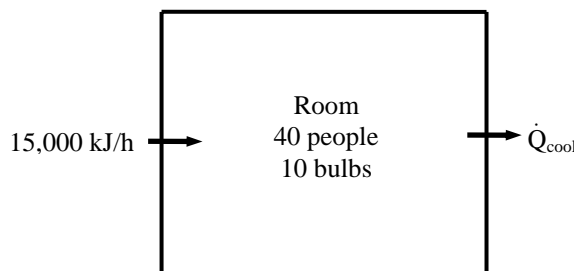

1-26 A resistance heater is to raise the air temperature in the room from 7 to 25°C within 15 min. The required power rating of the resistance heater is to be determined.

Assumptions 1 Air is an ideal gas since it is at a high temperature and low pressure relative to its critical point values of -141°C and 3.77 MPa. **2** The kinetic and potential energy changes are negligible, $\Delta ke \cong \Delta pe \cong 0$. **3** Constant specific heats at room temperature can be used for air. This assumption results in negligible error in heating and air-conditioning applications. **4** Heat losses from the room are negligible.

Properties The gas constant of air is $R = 0.287 \text{ kPa}\cdot\text{m}^3/\text{kg}\cdot\text{K}$ (Table A-1). Also, $c_p = 1.007 \text{ kJ/kg}\cdot\text{K}$ for air at room temperature (Table A-15).

Analysis We observe that the pressure in the room remains constant during this process. Therefore, some air will leak out as the air expands. However, we can take the air to be a closed system by considering the air in the room to have undergone a constant pressure expansion process. The energy balance for this steady-flow system can be expressed as

$$\underbrace{E_{in} - E_{out}}_{\text{Net energy transfer by heat, work, and mass}} = \underbrace{\Delta E_{\text{system}}}_{\text{Change in internal, kinetic, potential, etc. energies}}$$

$$W_{e,in} - W_b = \Delta U$$

$$W_{e,in} = \Delta H = m(h_2 - h_1) \cong mc_p(T_2 - T_1)$$

or $\dot{W}_{e,in} \Delta t = mc_{p,avg}(T_2 - T_1)$

The mass of air is

$$\mathcal{V} = 4 \times 5 \times 6 = 120 \text{ m}^3$$

$$m = \frac{P_1 \mathcal{V}}{RT_1} = \frac{(100 \text{ kPa})(120 \text{ m}^3)}{(0.287 \text{ kPa}\cdot\text{m}^3/\text{kg}\cdot\text{K})(280 \text{ K})} = 149.3 \text{ kg}$$

Using c_p value at room temperature, the power rating of the heater becomes

$$\dot{W}_{e,in} = (149.3 \text{ kg})(1.007 \text{ kJ/kg}\cdot^\circ\text{C})(25 - 7)^\circ\text{C}/(15 \times 60 \text{ s}) = \mathbf{3.01 \text{ kW}}$$

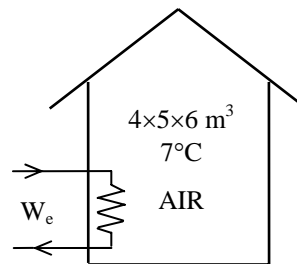

1-27 A room is heated by the radiator, and the warm air is distributed by a fan. Heat is lost from the room. The time it takes for the air temperature to rise to 20°C is to be determined.

Assumptions **1** Air is an ideal gas since it is at a high temperature and low pressure relative to its critical point values of -141°C and 3.77 MPa. **2** The kinetic and potential energy changes are negligible, $\Delta ke \cong \Delta pe \cong 0$. **3** Constant specific heats at room temperature can be used for air. This assumption results in negligible error in heating and air-conditioning applications. **4** The local atmospheric pressure is 100 kPa.

Properties The gas constant of air is $R = 0.287 \text{ kPa}\cdot\text{m}^3/\text{kg}\cdot\text{K}$ (Table A-1). Also, $c_p = 1.007 \text{ kJ/kg}\cdot\text{K}$ and $c_v = 0.720 \text{ kJ/kg}\cdot\text{K}$ for air at room temperature (Table A-15).

Analysis We take the air in the room as the system. This is a *closed system* since no mass crosses the system boundary during the process. We observe that the pressure in the room remains constant during this process. Therefore, some air will leak out as the air expands. However we can take the air to be a closed system by considering the air in the room to have undergone a constant pressure process. The energy balance for this system can be expressed as

$$\underbrace{E_{in} - E_{out}}_{\substack{\text{Net energy transfer} \\ \text{by heat, work, and mass}}} = \underbrace{\Delta E_{\text{system}}}_{\substack{\text{Change in internal, kinetic,} \\ \text{potential, etc. energies}}}$$

$$Q_{in} + W_{e,in} - W_b - Q_{out} = \Delta U$$

$$(\dot{Q}_{in} + \dot{W}_{e,in} - \dot{Q}_{out})\Delta t = \Delta H = m(h_2 - h_1) \cong mc_p(T_2 - T_1)$$

The mass of air is

$$V = 4 \times 5 \times 7 = 140 \text{ m}^3$$

$$m = \frac{P_1 V}{RT_1} = \frac{(100 \text{ kPa})(140 \text{ m}^3)}{(0.287 \text{ kPa}\cdot\text{m}^3/\text{kg}\cdot\text{K})(283 \text{ K})} = 172.4 \text{ kg}$$

Using the c_p value at room temperature,

$$[(12,500 - 5000)/3600 \text{ kJ/s} + 0.1 \text{ kJ/s}]\Delta t = (172.4 \text{ kg})(1.007 \text{ kJ/kg}\cdot\text{K})(20 - 10)^\circ\text{C}$$

It yields

$$\Delta t = \mathbf{795 \text{ s} = 13.3 \text{ min}}$$

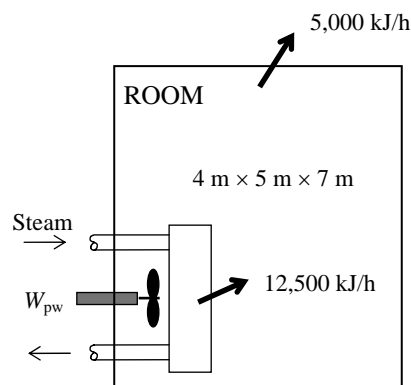

1-28 A student living in a room turns his 150-W fan on in the morning. The temperature in the room when she comes back 10 h later is to be determined.

Assumptions 1 Air is an ideal gas since it is at a high temperature and low pressure relative to its critical point values of -141°C and 3.77 MPa . **2** The kinetic and potential energy changes are negligible, $\Delta ke \cong \Delta pe \cong 0$. **3** Constant specific heats at room temperature can be used for air. This assumption results in negligible error in heating and air-conditioning applications. **4** All the doors and windows are tightly closed, and heat transfer through the walls and the windows is disregarded.

Properties The gas constant of air is $R = 0.287\text{ kPa}\cdot\text{m}^3/\text{kg}\cdot\text{K}$ (Table A-1). Also, $c_p = 1.007\text{ kJ}/\text{kg}\cdot\text{K}$ for air at room temperature (Table A-15) and $c_v = c_p - R = 0.720\text{ kJ}/\text{kg}\cdot\text{K}$.

Analysis We take the room as the system. This is a *closed system* since the doors and the windows are said to be tightly closed, and thus no mass crosses the system boundary during the process. The energy balance for this system can be expressed as

$$\underbrace{E_{in} - E_{out}}_{\substack{\text{Net energy transfer} \\ \text{by heat, work, and mass}}} = \underbrace{\Delta E_{\text{system}}}_{\substack{\text{Change in internal, kinetic,} \\ \text{potential, etc. energies}}}$$

$$W_{e,in} = \Delta U$$

$$W_{e,in} = m(u_2 - u_1) \cong mc_v(T_2 - T_1)$$

The mass of air is

$$\mathcal{V} = 4 \times 6 \times 6 = 144\text{ m}^3$$

$$m = \frac{P_1 \mathcal{V}}{RT_1} = \frac{(100\text{ kPa})(144\text{ m}^3)}{(0.287\text{ kPa}\cdot\text{m}^3/\text{kg}\cdot\text{K})(288\text{ K})} = 174.2\text{ kg}$$

The electrical work done by the fan is

$$W_e = \dot{W}_e \Delta t = (0.15\text{ kJ/s})(10 \times 3600\text{ s}) = 5400\text{ kJ}$$

Substituting and using c_v value at room temperature,

$$5400\text{ kJ} = (174.2\text{ kg})(0.720\text{ kJ}/\text{kg}\cdot^{\circ}\text{C})(T_2 - 15)^{\circ}\text{C} \rightarrow T_2 = \mathbf{58.1^{\circ}\text{C}}$$

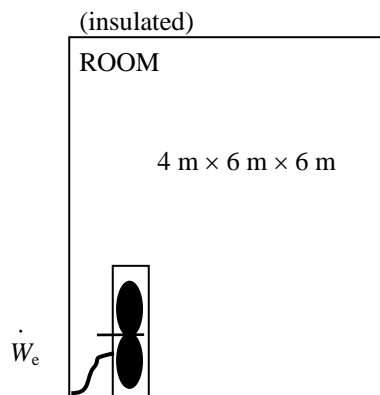

1-29 It is observed that the air temperature in a room heated by electric baseboard heaters remains constant even though the heater operates continuously when the heat losses from the room amount to $7000\text{ kJ}/\text{h}$. The power rating of the heater is to be determined.

Assumptions 1 Air is an ideal gas since it is at a high temperature and low pressure relative to its critical point values of -141°C and 3.77 MPa . **2** The kinetic and potential energy changes are negligible, $\Delta ke \cong \Delta pe \cong 0$. **3** The temperature of the room remains constant during this process.

Analysis We take the room as the system. The energy balance in this case reduces to

$$\underbrace{E_{in} - E_{out}}_{\substack{\text{Net energy transfer} \\ \text{by heat, work, and mass}}} = \underbrace{\Delta E_{\text{system}}}_{\substack{\text{Change in internal, kinetic,} \\ \text{potential, etc. energies}}}$$

$$W_{e,in} - Q_{out} = \Delta U = 0$$

$$W_{e,in} = Q_{out}$$

since $\Delta U = mc_v \Delta T = 0$ for isothermal processes of ideal gases. Thus,

$$\dot{W}_{e,in} = \dot{Q}_{out} = 7000\text{ kJ}/\text{h} \left(\frac{1\text{ kW}}{3600\text{ kJ}/\text{h}} \right) = \mathbf{1.94\text{ kW}}$$

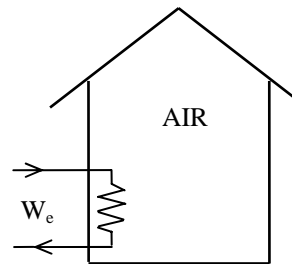

1-30 A room is heated by an electrical resistance heater placed in a short duct in the room in 15 min while the room is losing heat to the outside, and a 300-W fan circulates the air steadily through the heater duct. The power rating of the electric heater and the temperature rise of air in the duct are to be determined.

Assumptions 1 Air is an ideal gas since it is at a high temperature and low pressure relative to its critical point values of -141°C and 3.77 MPa . **2** The kinetic and potential energy changes are negligible, $\Delta ke \cong \Delta pe \cong 0$. **3** Constant specific heats at room temperature can be used for air. This assumption results in negligible error in heating and air-conditioning applications. **3** Heat loss from the duct is negligible. **4** The house is air-tight and thus no air is leaking in or out of the room.

Properties The gas constant of air is $R = 0.287\text{ kPa}\cdot\text{m}^3/\text{kg}\cdot\text{K}$ (Table A-1). Also, $c_p = 1.007\text{ kJ/kg}\cdot\text{K}$ for air at room temperature (Table A-15) and $c_v = c_p - R = 0.720\text{ kJ/kg}\cdot\text{K}$.

Analysis (a) We first take the air in the room as the system. This is a constant volume *closed system* since no mass crosses the system boundary. The energy balance for the room can be expressed as

$$\underbrace{E_{in} - E_{out}}_{\substack{\text{Net energy transfer} \\ \text{by heat, work, and mass}}} = \underbrace{\Delta E_{\text{system}}}_{\substack{\text{Change in internal, kinetic,} \\ \text{potential, etc. energies}}}$$

$$W_{e,\text{in}} + W_{\text{fan},\text{in}} - Q_{\text{out}} = \Delta U$$

$$(\dot{W}_{e,\text{in}} + \dot{W}_{\text{fan},\text{in}} - \dot{Q}_{\text{out}})\Delta t = m(u_2 - u_1) \cong mc_v(T_2 - T_1)$$

The total mass of air in the room is

$$\mathcal{V} = 5 \times 6 \times 8\text{ m}^3 = 240\text{ m}^3$$

$$m = \frac{P_1 \mathcal{V}}{RT_1} = \frac{(98\text{ kPa})(240\text{ m}^3)}{(0.287\text{ kPa}\cdot\text{m}^3/\text{kg}\cdot\text{K})(288\text{ K})} = 284.6\text{ kg}$$

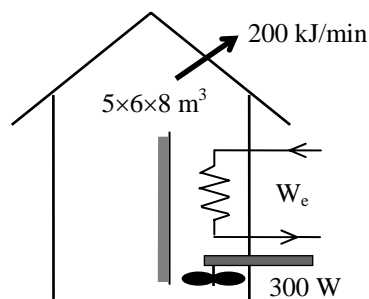

Then the power rating of the electric heater is determined to be

$$\dot{W}_{e,\text{in}} = \dot{Q}_{\text{out}} - \dot{W}_{\text{fan},\text{in}} + mc_v(T_2 - T_1) / \Delta t$$

$$= (200/60\text{ kJ/s}) - (0.3\text{ kJ/s}) + (284.6\text{ kg})(0.720\text{ kJ/kg}\cdot^{\circ}\text{C})(25 - 15^{\circ}\text{C}) / (18 \times 60\text{ s}) = \mathbf{4.93\text{ kW}}$$

(b) The temperature rise that the air experiences each time it passes through the heater is determined by applying the energy balance to the duct,

$$\dot{E}_{in} = \dot{E}_{out}$$

$$\dot{W}_{e,\text{in}} + \dot{W}_{\text{fan},\text{in}} + \dot{m}h_1 = \dot{Q}_{\text{out}} + \dot{m}h_2 \quad (\text{since } \Delta ke \cong \Delta pe \cong 0)$$

$$\dot{W}_{e,\text{in}} + \dot{W}_{\text{fan},\text{in}} = \dot{m}\Delta h = \dot{m}c_p\Delta T$$

Thus,

$$\Delta T = \frac{\dot{W}_{e,\text{in}} + \dot{W}_{\text{fan},\text{in}}}{\dot{m}c_p} = \frac{(4.93 + 0.3)\text{ kJ/s}}{(50/60\text{ kg/s})(1.007\text{ kJ/kg}\cdot\text{K})} = \mathbf{6.2^{\circ}\text{C}}$$

1-31 The resistance heating element of an electrically heated house is placed in a duct. The air is moved by a fan, and heat is lost through the walls of the duct. The power rating of the electric resistance heater is to be determined.

Assumptions 1 Air is an ideal gas since it is at a high temperature and low pressure relative to its critical point values of -141°C and 3.77 MPa . **2** The kinetic and potential energy changes are negligible, $\Delta ke \cong \Delta pe \cong 0$. **3** Constant specific heats at room temperature can be used for air. This assumption results in negligible error in heating and air-conditioning applications.

Properties The specific heat of air at room temperature is $c_p = 1.007\text{ kJ/kg}\cdot^{\circ}\text{C}$ (Table A-15).

Analysis We take the heating duct as the system. This is a *control volume* since mass crosses the system boundary during the process. We observe that this is a steady-flow process since there is no change with time at any point and thus $\Delta m_{\text{CV}} = 0$ and $\Delta E_{\text{CV}} = 0$. Also, there is only one inlet and one exit and thus $\dot{m}_1 = \dot{m}_2 = \dot{m}$. The energy balance for this steady-flow system can be expressed in the rate form as

$$\underbrace{\dot{E}_{in} - \dot{E}_{out}}_{\text{Rate of net energy transfer by heat, work, and mass}} = \underbrace{\Delta \dot{E}_{\text{system}}}_{\text{Rate of change in internal, kinetic, potential, etc. energies}} \stackrel{\text{no (steady)}}{=} 0 \rightarrow \dot{E}_{in} = \dot{E}_{out}$$

$$\dot{W}_{e,\text{in}} + \dot{W}_{\text{fan},\text{in}} + \dot{m}h_1 = \dot{Q}_{\text{out}} + \dot{m}h_2 \quad (\text{since } \Delta ke \cong \Delta pe \cong 0)$$

$$\dot{W}_{e,\text{in}} = \dot{Q}_{\text{out}} - \dot{W}_{\text{fan},\text{in}} + \dot{m}c_p(T_2 - T_1)$$

Substituting, the power rating of the heating element is determined to be

$$\begin{aligned} \dot{W}_{e,\text{in}} &= (0.25\text{ kW}) - (0.3\text{ kW}) + (0.6\text{ kg/s})(1.007\text{ kJ/kg}\cdot^{\circ}\text{C})(5^{\circ}\text{C}) \\ &= \mathbf{2.97\text{ kW}} \end{aligned}$$

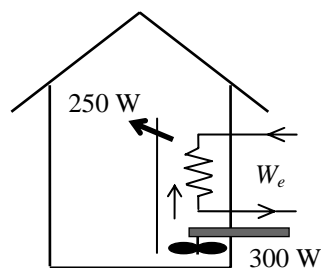

1-32 Air is moved through the resistance heaters in a 1200-W hair dryer by a fan. The volume flow rate of air at the inlet and the velocity of the air at the exit are to be determined.

Assumptions 1 Air is an ideal gas since it is at a high temperature and low pressure relative to its critical point values of -141°C and 3.77 MPa . **2** The kinetic and potential energy changes are negligible, $\Delta ke \cong \Delta pe \cong 0$. **3** Constant specific heats at room temperature can be used for air. **4** The power consumed by the fan and the heat losses through the walls of the hair dryer are negligible.

Properties The gas constant of air is $R = 0.287\text{ kPa}\cdot\text{m}^3/\text{kg}\cdot\text{K}$ (Table A-1). Also, $c_p = 1.007\text{ kJ/kg}\cdot\text{K}$ for air at room temperature (Table A-15).

Analysis (a) We take the hair dryer as the system. This is a *control volume* since mass crosses the system boundary during the process. We observe that this is a steady-flow process since there is no change with time at any point and thus $\Delta m_{\text{CV}} = 0$ and $\Delta E_{\text{CV}} = 0$, and there is only one inlet and one exit and thus $\dot{m}_1 = \dot{m}_2 = \dot{m}$. The energy balance for this steady-flow system can be expressed in the rate form as

$$\underbrace{\dot{E}_{\text{in}} - \dot{E}_{\text{out}}}_{\text{Rate of net energy transfer by heat, work, and mass}} = \underbrace{\dot{\Delta E}_{\text{system}}}_{\text{Rate of change in internal, kinetic, potential, etc. energies}} \stackrel{\text{steady}}{=} 0 \rightarrow \dot{E}_{\text{in}} = \dot{E}_{\text{out}}$$

$$\dot{W}_{\text{e,in}} + \dot{W}_{\text{fan,in}} + \dot{m}h_1 = \dot{Q}_{\text{out}} + \dot{m}h_2 \quad (\text{since } \Delta ke \cong \Delta pe \cong 0)$$

$$\dot{W}_{\text{e,in}} = \dot{m}c_p(T_2 - T_1)$$

Thus,

$$\dot{m} = \frac{\dot{W}_{\text{e,in}}}{c_p(T_2 - T_1)} = \frac{1.2\text{ kJ/s}}{(1.007\text{ kJ/kg}\cdot^{\circ}\text{C})(47 - 22)^{\circ}\text{C}} = 0.04767\text{ kg/s}$$

Then,

$$\nu_1 = \frac{RT_1}{P_1} = \frac{(0.287\text{ kPa}\cdot\text{m}^3/\text{kg}\cdot\text{K})(295\text{ K})}{100\text{ kPa}} = 0.8467\text{ m}^3/\text{kg}$$

$$\dot{V}_1 = \dot{m}\nu_1 = (0.04767\text{ kg/s})(0.8467\text{ m}^3/\text{kg}) = \mathbf{0.0404\text{ m}^3/\text{s}}$$

(b) The exit velocity of air is determined from the conservation of mass equation,

$$\nu_2 = \frac{RT_2}{P_2} = \frac{(0.287\text{ kPa}\cdot\text{m}^3/\text{kg}\cdot\text{K})(320\text{ K})}{100\text{ kPa}} = 0.9184\text{ m}^3/\text{kg}$$

$$\dot{m} = \frac{1}{\nu_2} A_2 V_2 \longrightarrow V_2 = \frac{\dot{m}\nu_2}{A_2} = \frac{(0.04767\text{ kg/s})(0.9184\text{ m}^3/\text{kg})}{60 \times 10^{-4}\text{ m}^2} = \mathbf{7.30\text{ m/s}}$$

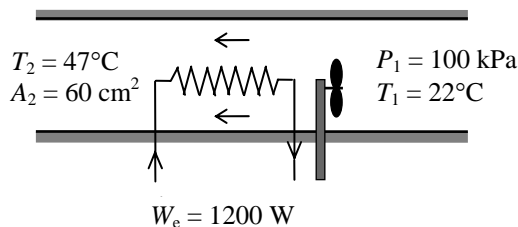

1-33 The ducts of an air heating system pass through an unheated area, resulting in a temperature drop of the air in the duct. The rate of heat loss from the air to the cold environment is to be determined.

Assumptions **1** Air is an ideal gas since it is at a high temperature and low pressure relative to its critical point values of -141°C and 3.77 MPa . **2** The kinetic and potential energy changes are negligible, $\Delta ke \cong \Delta pe \cong 0$. **3** Constant specific heats at room temperature can be used for air. This assumption results in negligible error in heating and air-conditioning applications.

Properties The specific heat of air at room temperature is $c_p = 1.007\text{ kJ/kg}\cdot^{\circ}\text{C}$ (Table A-15).

Analysis We take the heating duct as the system. This is a *control volume* since mass crosses the system boundary during the process. We *observe* that this is a steady-flow process since there is no change with time at any point and thus $\Delta m_{\text{CV}} = 0$ and $\Delta E_{\text{CV}} = 0$. Also, there is only one inlet and one exit and thus $\dot{m}_1 = \dot{m}_2 = \dot{m}$. The energy balance for this steady-flow system can be expressed in the rate form as

$$\underbrace{\dot{E}_{in} - \dot{E}_{out}}_{\text{Rate of net energy transfer by heat, work, and mass}} = \underbrace{\Delta \dot{E}_{\text{system}}}_{\text{Rate of change in internal, kinetic, potential, etc. energies}} \stackrel{\text{no (steady)}}{=} 0 \rightarrow \dot{E}_{in} = \dot{E}_{out}$$

$$\dot{m}h_1 = \dot{Q}_{out} + \dot{m}h_2 \quad (\text{since } \Delta ke \cong \Delta pe \cong 0)$$

$$\dot{Q}_{out} = \dot{m}c_p(T_1 - T_2)$$

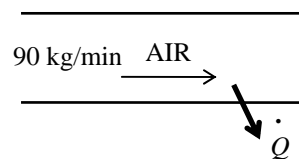

Substituting,

$$\dot{Q}_{out} = \dot{m}c_p\Delta T = (90\text{ kg/min})(1.007\text{ kJ/kg}\cdot^{\circ}\text{C})(3^{\circ}\text{C}) = \mathbf{272\text{ kJ/min}}$$

1-34E Air gains heat as it flows through the duct of an air-conditioning system. The velocity of the air at the duct inlet and the temperature of the air at the exit are to be determined.

Assumptions 1 Air is an ideal gas since it is at a high temperature and low pressure relative to its critical point values of -222°F and 548 psia . **2** The kinetic and potential energy changes are negligible, $\Delta ke \cong \Delta pe \cong 0$. **3** Constant specific heats at room temperature can be used for air. This assumption results in negligible error in heating and air-conditioning applications.

Properties The gas constant of air is $R = 0.3704\text{ psia}\cdot\text{ft}^3/\text{lbm}\cdot\text{R}$ (Table A-1E). Also, $c_p = 0.240\text{ Btu}/\text{lbm}\cdot\text{R}$ for air at room temperature (Table A-15E).

Analysis We take the air-conditioning duct as the system. This is a *control volume* since mass crosses the system boundary during the process. We *observe* that this is a steady-flow process since there is no change with time at any point and thus $\Delta m_{CV} = 0$ and $\Delta E_{CV} = 0$, there is only one inlet and one exit and thus $\dot{m}_1 = \dot{m}_2 = \dot{m}$, and heat is lost from the system. The energy balance for this steady-flow system can be expressed in the rate form as

$$\underbrace{\dot{E}_{in} - \dot{E}_{out}}_{\text{Rate of net energy transfer by heat, work, and mass}} = \underbrace{\Delta \dot{E}_{\text{system}}}_{\text{Rate of change in internal, kinetic, potential, etc. energies}} \stackrel{\text{no (steady)}}{=} 0 \rightarrow \dot{E}_{in} = \dot{E}_{out}$$

$$\dot{Q}_{in} + \dot{m}h_1 = \dot{m}h_2 \quad (\text{since } \Delta ke \cong \Delta pe \cong 0)$$

$$\dot{Q}_{in} = \dot{m}c_p(T_2 - T_1)$$

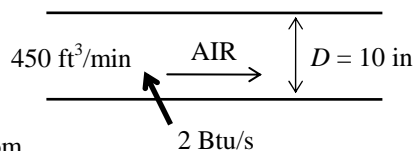

(a) The inlet velocity of air through the duct is determined from

$$V_1 = \frac{\dot{V}_1}{A_1} = \frac{\dot{V}_1}{\pi r^2} = \frac{450\text{ ft}^3/\text{min}}{\pi(5/12\text{ ft})^2} = \mathbf{825\text{ ft/min}}$$

(b) The mass flow rate of air becomes

$$\nu_1 = \frac{RT_1}{P_1} = \frac{(0.3704\text{ psia}\cdot\text{ft}^3/\text{lbm}\cdot\text{R})(510\text{ R})}{15\text{ psia}} = 12.6\text{ ft}^3/\text{lbm}$$

$$\dot{m} = \frac{\dot{V}_1}{\nu_1} = \frac{450\text{ ft}^3/\text{min}}{12.6\text{ ft}^3/\text{lbm}} = 35.7\text{ lbm/min} = 0.595\text{ lbm/s}$$

Then the exit temperature of air is determined to be

$$T_2 = T_1 + \frac{\dot{Q}_{in}}{\dot{m}c_p} = 50^{\circ}\text{F} + \frac{2\text{ Btu/s}}{(0.595\text{ lbm/s})(0.240\text{ Btu}/\text{lbm}\cdot^{\circ}\text{F})} = \mathbf{64.0^{\circ}\text{F}}$$

1-35 Water is heated in an insulated tube by an electric resistance heater. The mass flow rate of water through the heater is to be determined.

Assumptions 1 Water is an incompressible substance with a constant specific heat. **2** The kinetic and potential energy changes are negligible, $\Delta ke \cong \Delta pe \cong 0$. **3** Heat loss from the insulated tube is negligible.

Properties The specific heat of water at room temperature is $c_p = 4.18 \text{ kJ/kg}\cdot^\circ\text{C}$.

Analysis We take the tube as the system. This is a *control volume* since mass crosses the system boundary during the process. We *observe* that this is a steady-flow process since there is no change with time at any point and thus $\Delta m_{CV} = 0$ and $\Delta E_{CV} = 0$, there is only one inlet and one exit and thus $\dot{m}_1 = \dot{m}_2 = \dot{m}$, and the tube is insulated. The energy balance for this steady-flow system can be expressed in the rate form as

$$\underbrace{\dot{E}_{in} - \dot{E}_{out}}_{\text{Rate of net energy transfer by heat, work, and mass}} = \underbrace{\Delta \dot{E}_{system} \overset{\approx 0 \text{ (steady)}}{}}_{\text{Rate of change in internal, kinetic, potential, etc. energies}} = 0 \rightarrow \dot{E}_{in} = \dot{E}_{out}$$

$$\dot{W}_{e,in} + \dot{m}h_1 = \dot{m}h_2 \quad (\text{since } \Delta ke \cong \Delta pe \cong 0)$$

$$\dot{W}_{e,in} = \dot{m}c_p(T_2 - T_1)$$

Thus,

$$\dot{m} = \frac{\dot{W}_{e,in}}{c_p(T_2 - T_1)} = \frac{7 \text{ kJ/s}}{(4.18 \text{ kJ/kg}\cdot^\circ\text{C})(70 - 15)^\circ\text{C}} = \mathbf{0.0304 \text{ kg/s}}$$

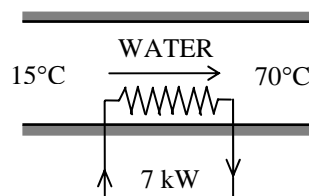

Heat Transfer Mechanisms

1-36C The house with the lower rate of heat transfer through the walls will be more energy efficient. Heat conduction is proportional to thermal conductivity (which is 0.72 W/m.°C for brick and 0.17 W/m.°C for wood, Table 1-1) and inversely proportional to thickness. The wood house is more energy efficient since the wood wall is twice as thick but it has about one-fourth the conductivity of brick wall.

1-37C The thermal conductivity of a material is the rate of heat transfer through a unit thickness of the material per unit area and per unit temperature difference. The thermal conductivity of a material is a measure of how fast heat will be conducted in that material.

1-38C The mechanisms of heat transfer are conduction, convection and radiation. Conduction is the transfer of energy from the more energetic particles of a substance to the adjacent less energetic ones as a result of interactions between the particles. Convection is the mode of energy transfer between a solid surface and the adjacent liquid or gas which is in motion, and it involves combined effects of conduction and fluid motion. Radiation is energy emitted by matter in the form of electromagnetic waves (or photons) as a result of the changes in the electronic configurations of the atoms or molecules.

1-39C In solids, conduction is due to the combination of the vibrations of the molecules in a lattice and the energy transport by free electrons. In gases and liquids, it is due to the collisions of the molecules during their random motion.

1-40C The parameters that effect the rate of heat conduction through a windowless wall are the geometry and surface area of wall, its thickness, the material of the wall, and the temperature difference across the wall.

1-41C Conduction is expressed by Fourier's law of conduction as $\dot{Q}_{\text{cond}} = -kA \frac{dT}{dx}$ where dT/dx is the temperature gradient, k is the thermal conductivity, and A is the area which is normal to the direction of heat transfer.

Convection is expressed by Newton's law of cooling as $\dot{Q}_{\text{conv}} = hA_s(T_s - T_\infty)$ where h is the convection heat transfer coefficient, A_s is the surface area through which convection heat transfer takes place, T_s is the surface temperature and T_∞ is the temperature of the fluid sufficiently far from the surface.

Radiation is expressed by Stefan-Boltzman law as $\dot{Q}_{\text{rad}} = \varepsilon\sigma A_s(T_s^4 - T_{\text{surr}}^4)$ where ε is the emissivity of surface, A_s is the surface area, T_s is the surface temperature, T_{surr} is the average surrounding surface temperature and $\sigma = 5.67 \times 10^{-8} \text{ W/m}^2 \cdot \text{K}^4$ is the Stefan-Boltzman constant.

1-42C Convection involves fluid motion, conduction does not. In a solid we can have only conduction.

1-43C No. It is purely by radiation.

1-44C In forced convection the fluid is forced to move by external means such as a fan, pump, or the wind. The fluid motion in natural convection is due to buoyancy effects only.

1-45C Emissivity is the ratio of the radiation emitted by a surface to the radiation emitted by a blackbody at the same temperature. Absorptivity is the fraction of radiation incident on a surface that is absorbed by the surface. The Kirchhoff's law of radiation states that the emissivity and the absorptivity of a surface are equal at the same temperature and wavelength.

1-46C A blackbody is an idealized body which emits the maximum amount of radiation at a given temperature and which absorbs all the radiation incident on it. Real bodies emit and absorb less radiation than a blackbody at the same temperature.

1-47C No. Such a definition will imply that doubling the thickness will double the heat transfer rate. The equivalent but "more correct" unit of thermal conductivity is $\text{W}\cdot\text{m}/\text{m}^2\cdot^\circ\text{C}$ that indicates product of heat transfer rate and thickness per unit surface area per unit temperature difference.

1-48C In a typical house, heat loss through the wall with glass window will be larger since the glass is much thinner than a wall, and its thermal conductivity is higher than the average conductivity of a wall.

1-49C Diamond is a better heat conductor.

1-50C The rate of heat transfer through both walls can be expressed as

$$\dot{Q}_{\text{wood}} = k_{\text{wood}} A \frac{T_1 - T_2}{L_{\text{wood}}} = (0.16 \text{ W/m}\cdot^\circ\text{C}) A \frac{T_1 - T_2}{0.1 \text{ m}} = 1.6A(T_1 - T_2)$$

$$\dot{Q}_{\text{brick}} = k_{\text{brick}} A \frac{T_1 - T_2}{L_{\text{brick}}} = (0.72 \text{ W/m}\cdot^\circ\text{C}) A \frac{T_1 - T_2}{0.25 \text{ m}} = 2.88A(T_1 - T_2)$$

where thermal conductivities are obtained from Table A-5. Therefore, heat transfer through the brick wall will be larger despite its higher thickness.

1-51C The thermal conductivity of gases is proportional to the square root of absolute temperature. The thermal conductivity of most liquids, however, decreases with increasing temperature, with water being a notable exception.

1-52C Superinsulations are obtained by using layers of highly reflective sheets separated by glass fibers in an evacuated space. Radiation heat transfer between two surfaces is inversely proportional to the number of sheets used and thus heat loss by radiation will be very low by using this highly reflective sheets. At the same time, evacuating the space between the layers forms a vacuum under 0.000001 atm pressure which minimize conduction or convection through the air space between the layers.

1-53C Most ordinary insulations are obtained by mixing fibers, powders, or flakes of insulating materials with air. Heat transfer through such insulations is by conduction through the solid material, and conduction or convection through the air space as well as radiation. Such systems are characterized by apparent thermal conductivity instead of the ordinary thermal conductivity in order to incorporate these convection and radiation effects.

1-54C The thermal conductivity of an alloy of two metals will most likely be less than the thermal conductivities of both metals.

1-55 The inner and outer surfaces of a brick wall are maintained at specified temperatures. The rate of heat transfer through the wall is to be determined.

Assumptions **1** Steady operating conditions exist since the surface temperatures of the wall remain constant at the specified values. **2** Thermal properties of the wall are constant.

Properties The thermal conductivity of the wall is given to be $k = 0.69 \text{ W/m}\cdot\text{C}$.

Analysis Under steady conditions, the rate of heat transfer through the wall is

$$\dot{Q}_{\text{cond}} = kA \frac{\Delta T}{L} = (0.69 \text{ W/m}\cdot\text{C})(4 \times 7 \text{ m}^2) \frac{(20 - 5)\text{C}}{0.3 \text{ m}} = \mathbf{966 \text{ W}}$$

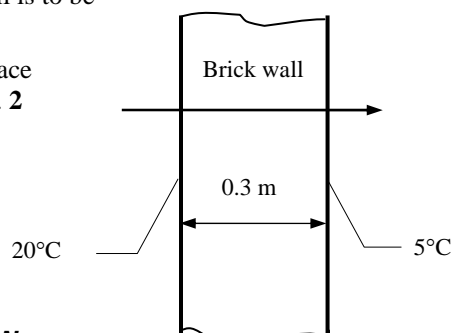

1-56 The inner and outer surfaces of a window glass are maintained at specified temperatures. The amount of heat transfer through the glass in 5 h is to be determined.

Assumptions **1** Steady operating conditions exist since the surface temperatures of the glass remain constant at the specified values. **2** Thermal properties of the glass are constant.

Properties The thermal conductivity of the glass is given to be $k = 0.78 \text{ W/m}\cdot\text{C}$.

Analysis Under steady conditions, the rate of heat transfer through the glass by conduction is

$$\dot{Q}_{\text{cond}} = kA \frac{\Delta T}{L} = (0.78 \text{ W/m}\cdot\text{C})(2 \times 2 \text{ m}^2) \frac{(10 - 3)\text{C}}{0.005 \text{ m}} = 4368 \text{ W}$$

Then the amount of heat transfer over a period of 5 h becomes

$$Q = \dot{Q}_{\text{cond}} \Delta t = (4.368 \text{ kJ/s})(5 \times 3600 \text{ s}) = \mathbf{78,620 \text{ kJ}}$$

If the thickness of the glass doubled to 1 cm, then the amount of heat transfer will go down by half to **39,310 kJ**.

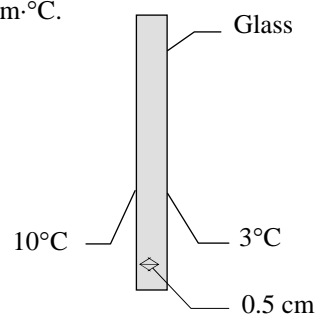

1-57 EES Prob. 1-56 is reconsidered. The amount of heat loss through the glass as a function of the window glass thickness is to be plotted.

Analysis The problem is solved using EES, and the solution is given below.

"GIVEN"

L=0.005 [m]
 A=2*2 [m^2]
 T_1=10 [C]
 T_2=3 [C]
 k=0.78 [W/m-C]
 time=5*3600 [s]

"ANALYSIS"

$Q_{\text{dot_cond}} = k \cdot A \cdot (T_1 - T_2) / L$
 $Q_{\text{cond}} = Q_{\text{dot_cond}} \cdot \text{time} \cdot \text{Convert}(\text{J}, \text{kJ})$

L [m]	Q _{cond} [kJ]
0.001	393120
0.002	196560
0.003	131040
0.004	98280
0.005	78624
0.006	65520
0.007	56160
0.008	49140
0.009	43680
0.01	39312

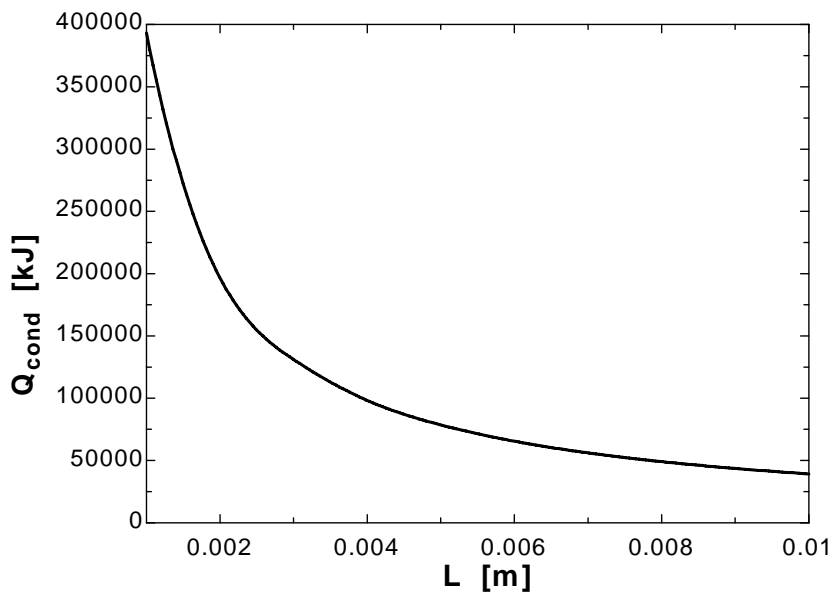

1-58 Heat is transferred steadily to boiling water in the pan through its bottom. The inner surface temperature of the bottom of the pan is given. The temperature of the outer surface is to be determined.

Assumptions 1 Steady operating conditions exist since the surface temperatures of the pan remain constant at the specified values. **2** Thermal properties of the aluminum pan are constant.

Properties The thermal conductivity of the aluminum is given to be $k = 237 \text{ W/m}\cdot^\circ\text{C}$.

Analysis The heat transfer area is

$$A = \pi r^2 = \pi (0.075 \text{ m})^2 = 0.0177 \text{ m}^2$$

Under steady conditions, the rate of heat transfer through the bottom of the pan by conduction is

$$\dot{Q} = kA \frac{\Delta T}{L} = kA \frac{T_2 - T_1}{L}$$

Substituting,

$$800 \text{ W} = (237 \text{ W/m}\cdot^\circ\text{C})(0.0177 \text{ m}^2) \frac{T_2 - 105^\circ\text{C}}{0.004 \text{ m}}$$

which gives

$$T_2 = \mathbf{105.76^\circ\text{C}}$$

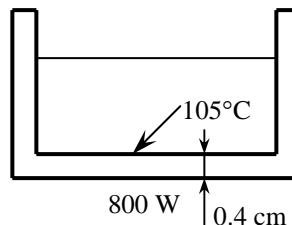

1-59E The inner and outer surface temperatures of the wall of an electrically heated home during a winter night are measured. The rate of heat loss through the wall that night and its cost are to be determined.

Assumptions 1 Steady operating conditions exist since the surface temperatures of the wall remain constant at the specified values during the entire night. **2** Thermal properties of the wall are constant.

Properties The thermal conductivity of the brick wall is given to be $k = 0.42 \text{ Btu/h}\cdot\text{ft}\cdot^\circ\text{F}$.

Analysis (a) Noting that the heat transfer through the wall is by conduction and the surface area of the wall is $A = 20 \text{ ft} \times 10 \text{ ft} = 200 \text{ ft}^2$, the steady rate of heat transfer through the wall can be determined from

$$\dot{Q} = kA \frac{T_1 - T_2}{L} = (0.42 \text{ Btu/h}\cdot\text{ft}\cdot^\circ\text{F})(200 \text{ ft}^2) \frac{(62 - 25)^\circ\text{F}}{1 \text{ ft}} = \mathbf{3108 \text{ Btu/h}}$$

or 0.911 kW since $1 \text{ kW} = 3412 \text{ Btu/h}$.

(b) The amount of heat lost during an 8 hour period and its cost are

$$Q = \dot{Q}\Delta t = (0.911 \text{ kW})(8 \text{ h}) = 7.288 \text{ kWh}$$

$$\begin{aligned} \text{Cost} &= (\text{Amount of energy})(\text{Unit cost of energy}) \\ &= (7.288 \text{ kWh})(\$0.07/\text{kWh}) \\ &= \mathbf{\$0.51} \end{aligned}$$

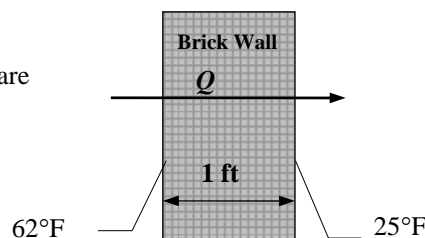

Therefore, the cost of the heat loss through the wall to the home owner that night is \$0.51.

1-60 The thermal conductivity of a material is to be determined by ensuring one-dimensional heat conduction, and by measuring temperatures when steady operating conditions are reached.

Assumptions 1 Steady operating conditions exist since the temperature readings do not change with time.

2 Heat losses through the lateral surfaces of the apparatus are negligible since those surfaces are well-insulated, and thus the entire heat generated by the heater is conducted through the samples. **3** The apparatus possesses thermal symmetry.

Analysis The electrical power consumed by the heater and converted to heat is

$$\dot{W}_e = VI = (110 \text{ V})(0.6 \text{ A}) = 66 \text{ W}$$

The rate of heat flow through each sample is

$$\dot{Q} = \frac{\dot{W}_e}{2} = \frac{66 \text{ W}}{2} = 33 \text{ W}$$

Then the thermal conductivity of the sample becomes

$$A = \frac{\pi D^2}{4} = \frac{\pi(0.04 \text{ m})^2}{4} = 0.001257 \text{ m}^2$$

$$\dot{Q} = kA \frac{\Delta T}{L} \longrightarrow k = \frac{\dot{Q}L}{A\Delta T} = \frac{(33 \text{ W})(0.03 \text{ m})}{(0.001257 \text{ m}^2)(10^\circ\text{C})} = \mathbf{78.8 \text{ W/m}\cdot^\circ\text{C}}$$

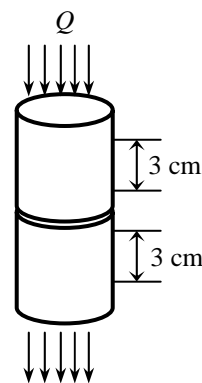

1-61 The thermal conductivity of a material is to be determined by ensuring one-dimensional heat conduction, and by measuring temperatures when steady operating conditions are reached.

Assumptions 1 Steady operating conditions exist since the temperature readings do not change with time.

2 Heat losses through the lateral surfaces of the apparatus are negligible since those surfaces are well-insulated, and thus the entire heat generated by the heater is conducted through the samples. **3** The apparatus possesses thermal symmetry.

Analysis For each sample we have

$$\dot{Q} = 25 / 2 = 12.5 \text{ W}$$

$$A = (0.1 \text{ m})(0.1 \text{ m}) = 0.01 \text{ m}^2$$

$$\Delta T = 82 - 74 = 8^\circ\text{C}$$

Then the thermal conductivity of the material becomes

$$\dot{Q} = kA \frac{\Delta T}{L} \longrightarrow k = \frac{\dot{Q}L}{A\Delta T} = \frac{(12.5 \text{ W})(0.005 \text{ m})}{(0.01 \text{ m}^2)(8^\circ\text{C})} = \mathbf{0.781 \text{ W/m}\cdot^\circ\text{C}}$$

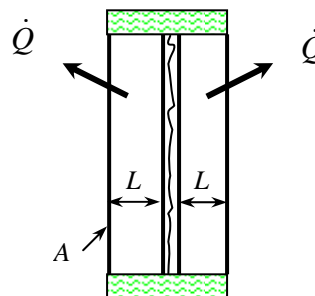

1-62 The thermal conductivity of a material is to be determined by ensuring one-dimensional heat conduction, and by measuring temperatures when steady operating conditions are reached.

Assumptions 1 Steady operating conditions exist since the temperature readings do not change with time. **2** Heat losses through the lateral surfaces of the apparatus are negligible since those surfaces are well-insulated, and thus the entire heat generated by the heater is conducted through the samples. **3** The apparatus possesses thermal symmetry.

Analysis For each sample we have

$$\dot{Q} = 20 / 2 = 10 \text{ W}$$

$$A = (0.1 \text{ m})(0.1 \text{ m}) = 0.01 \text{ m}^2$$

$$\Delta T = 82 - 74 = 8^\circ\text{C}$$

Then the thermal conductivity of the material becomes

$$\dot{Q} = kA \frac{\Delta T}{L} \longrightarrow k = \frac{\dot{Q}L}{A\Delta T} = \frac{(10 \text{ W})(0.005 \text{ m})}{(0.01 \text{ m}^2)(8^\circ\text{C})} = \mathbf{0.625 \text{ W/m}\cdot^\circ\text{C}}$$

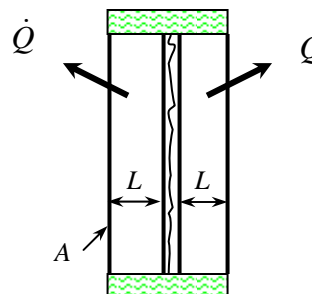

1-63 The thermal conductivity of a refrigerator door is to be determined by measuring the surface temperatures and heat flux when steady operating conditions are reached.

Assumptions 1 Steady operating conditions exist when measurements are taken. **2** Heat transfer through the door is one dimensional since the thickness of the door is small relative to other dimensions.

Analysis The thermal conductivity of the door material is determined directly from Fourier's relation to be

$$\dot{q} = k \frac{\Delta T}{L} \longrightarrow k = \frac{\dot{q}L}{\Delta T} = \frac{(25 \text{ W/m}^2)(0.03 \text{ m})}{(15 - 7)^\circ\text{C}} = \mathbf{0.09375 \text{ W/m}\cdot^\circ\text{C}}$$

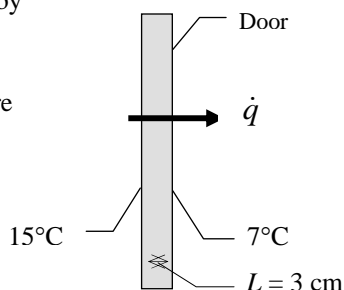

1-64 The rate of radiation heat transfer between a person and the surrounding surfaces at specified temperatures is to be determined in summer and in winter.

Assumptions 1 Steady operating conditions exist. **2** Heat transfer by convection is not considered. **3** The person is completely surrounded by the interior surfaces of the room. **4** The surrounding surfaces are at a uniform temperature.

Properties The emissivity of a person is given to be $\epsilon = 0.95$

Analysis Noting that the person is completely enclosed by the surrounding surfaces, the net rates of radiation heat transfer from the body to the surrounding walls, ceiling, and the floor in both cases are:

(a) Summer: $T_{\text{surr}} = 23 + 273 = 296 \text{ K}$

$$\begin{aligned} \dot{Q}_{\text{rad}} &= \epsilon \sigma A_s (T_s^4 - T_{\text{surr}}^4) \\ &= (0.95)(5.67 \times 10^{-8} \text{ W/m}^2 \cdot \text{K}^4)(1.6 \text{ m}^2)[(32 + 273)^4 - (296 \text{ K})^4] \text{ K}^4 \\ &= \mathbf{84.2 \text{ W}} \end{aligned}$$

(b) Winter: $T_{\text{surr}} = 12 + 273 = 285 \text{ K}$

$$\begin{aligned} \dot{Q}_{\text{rad}} &= \epsilon \sigma A_s (T_s^4 - T_{\text{surr}}^4) \\ &= (0.95)(5.67 \times 10^{-8} \text{ W/m}^2 \cdot \text{K}^4)(1.6 \text{ m}^2)[(32 + 273)^4 - (285 \text{ K})^4] \text{ K}^4 \\ &= \mathbf{177.2 \text{ W}} \end{aligned}$$

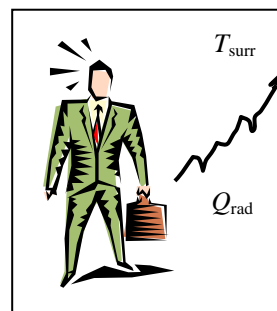

Discussion Note that the radiation heat transfer from the person more than doubles in winter.

1-65 EES Prob. 1-64 is reconsidered. The rate of radiation heat transfer in winter as a function of the temperature of the inner surface of the room is to be plotted.

Analysis The problem is solved using EES, and the solution is given below.

"GIVEN"

$T_{\infty}=(20+273)$ [K]
 $T_{\text{surr,winter}}=(12+273)$ [K]
 $T_{\text{surr,summer}}=(23+273)$ [K]
 $A=1.6$ [m²]
 $\epsilon=0.95$
 $T_s=(32+273)$ [K]

"ANALYSIS"

$\sigma=5.67\text{E-}8$ [W/m²-K⁴] "Stefan-Boltzman constant"
 $\dot{Q}_{\text{rad,summer}}=\epsilon\sigma A(T_s^4-T_{\text{surr,summer}}^4)$
 $\dot{Q}_{\text{rad,winter}}=\epsilon\sigma A(T_s^4-T_{\text{surr,winter}}^4)$

$T_{\text{surr,winter}}$ [K]	$\dot{Q}_{\text{rad,winter}}$ [W]
281	208.5
282	200.8
283	193
284	185.1
285	177.2
286	169.2
287	161.1
288	152.9
289	144.6
290	136.2
291	127.8

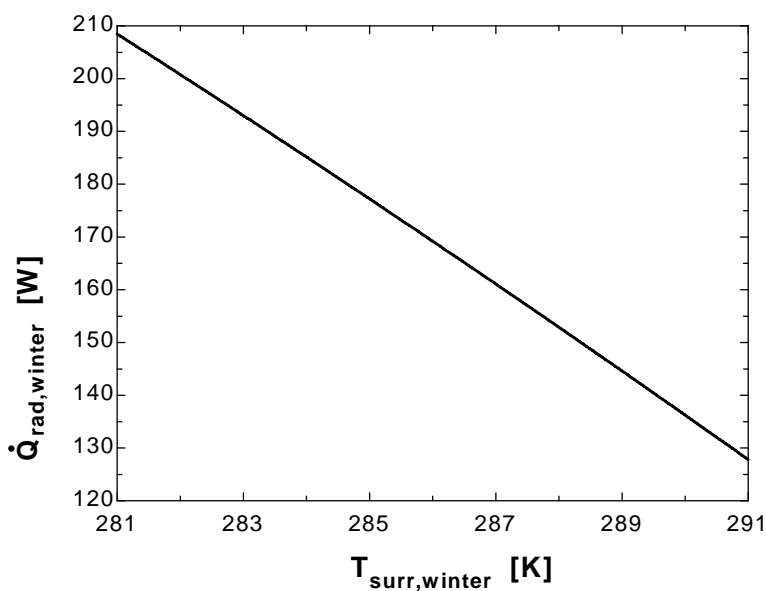

1-66 A person is standing in a room at a specified temperature. The rate of heat transfer between a person and the surrounding air by convection is to be determined.

Assumptions **1** Steady operating conditions exist. **2** Heat transfer by radiation is not considered. **3** The environment is at a uniform temperature.

Analysis The heat transfer surface area of the person is

$$A_s = \pi DL = \pi(0.3 \text{ m})(1.70 \text{ m}) = 1.602 \text{ m}^2$$

Under steady conditions, the rate of heat transfer by convection is

$$\dot{Q}_{\text{conv}} = hA_s \Delta T = (20 \text{ W/m}^2 \cdot ^\circ\text{C})(1.602 \text{ m}^2)(34 - 18)^\circ\text{C} = \mathbf{513 \text{ W}}$$

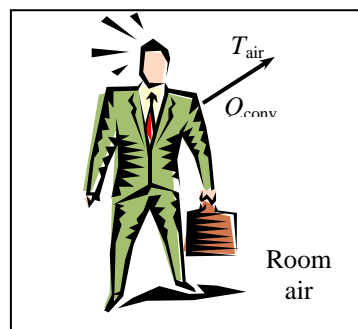

1-67 Hot air is blown over a flat surface at a specified temperature. The rate of heat transfer from the air to the plate is to be determined.

Assumptions **1** Steady operating conditions exist. **2** Heat transfer by radiation is not considered. **3** The convection heat transfer coefficient is constant and uniform over the surface.

Analysis Under steady conditions, the rate of heat transfer by convection is

$$\dot{Q}_{\text{conv}} = hA_s \Delta T = (55 \text{ W/m}^2 \cdot ^\circ\text{C})(2 \times 4 \text{ m}^2)(80 - 30)^\circ\text{C} = \mathbf{22,000 \text{ W}}$$

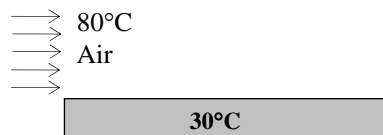

1-68 EES Prob. 1-67 is reconsidered. The rate of heat transfer as a function of the heat transfer coefficient is to be plotted.

Analysis The problem is solved using EES, and the solution is given below.

"GIVEN"

$$T_{\text{infinity}}=80 \text{ [C]}$$

$$A=2*4 \text{ [m}^2\text{]}$$

$$T_s=30 \text{ [C]}$$

$$h=55 \text{ [W/m}^2\text{-C]}$$

"ANALYSIS"

$$\dot{Q}_{\text{conv}}=h*A*(T_{\text{infinity}}-T_s)$$

$h \text{ [W/m}^2\text{-C]}$	$\dot{Q}_{\text{conv}} \text{ [W]}$
20	8000
30	12000
40	16000
50	20000
60	24000
70	28000
80	32000
90	36000
100	40000

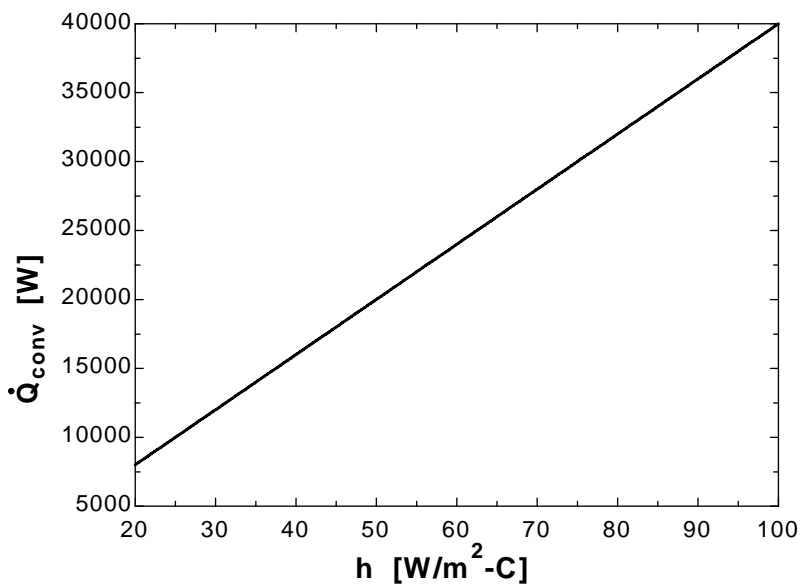

1-69 The heat generated in the circuitry on the surface of a 3-W silicon chip is conducted to the ceramic substrate. The temperature difference across the chip in steady operation is to be determined.

Assumptions 1 Steady operating conditions exist. 2 Thermal properties of the chip are constant.

Properties The thermal conductivity of the silicon chip is given to be $k = 130 \text{ W/m}\cdot\text{C}$.

Analysis The temperature difference between the front and back surfaces of the chip is

$$A = (0.006 \text{ m})(0.006 \text{ m}) = 0.000036 \text{ m}^2$$

$$\dot{Q} = kA \frac{\Delta T}{L}$$

$$\Delta T = \frac{\dot{Q}L}{kA} = \frac{(3 \text{ W})(0.0005 \text{ m})}{(130 \text{ W/m}\cdot\text{C})(0.000036 \text{ m}^2)} = \mathbf{0.32^\circ\text{C}}$$

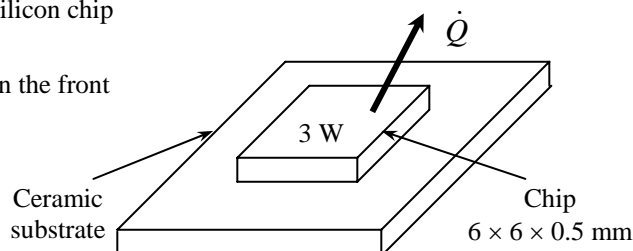

1-70 An electric resistance heating element is immersed in water initially at 20°C . The time it will take for this heater to raise the water temperature to 80°C as well as the convection heat transfer coefficients at the beginning and at the end of the heating process are to be determined.

Assumptions 1 Steady operating conditions exist and thus the rate of heat loss from the wire equals the rate of heat generation in the wire as a result of resistance heating. 2 Thermal properties of water are constant. 3 Heat losses from the water in the tank are negligible.

Properties The specific heat of water at room temperature is $c = 4.18 \text{ kJ/kg}\cdot\text{C}$ (Table A-9).

Analysis When steady operating conditions are reached, we have $\dot{Q} = \dot{E}_{\text{generated}} = 800 \text{ W}$. This is also equal to the rate of heat gain by water. Noting that this is the only mechanism of energy transfer, the time it takes to raise the water temperature from 20°C to 80°C is determined to be

$$Q_{\text{in}} = mc(T_2 - T_1)$$

$$\dot{Q}_{\text{in}} \Delta t = mc(T_2 - T_1)$$

$$\Delta t = \frac{mc(T_2 - T_1)}{\dot{Q}_{\text{in}}} = \frac{(75 \text{ kg})(4180 \text{ J/kg}\cdot\text{C})(80 - 20)^\circ\text{C}}{800 \text{ J/s}} = 23,510 \text{ s} = \mathbf{6.53 \text{ h}}$$

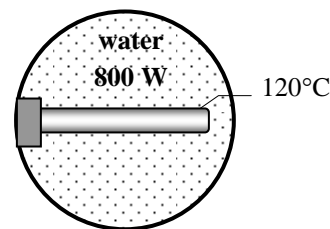

The surface area of the wire is

$$A_s = \pi DL = \pi(0.005 \text{ m})(0.4 \text{ m}) = 0.00628 \text{ m}^2$$

The Newton's law of cooling for convection heat transfer is expressed as $\dot{Q} = hA_s(T_s - T_\infty)$. Disregarding any heat transfer by radiation and thus assuming all the heat loss from the wire to occur by convection, the convection heat transfer coefficients at the beginning and at the end of the process are determined to be

$$h_1 = \frac{\dot{Q}}{A_s(T_s - T_{\infty 1})} = \frac{800 \text{ W}}{(0.00628 \text{ m}^2)(120 - 20)^\circ\text{C}} = \mathbf{1274 \text{ W/m}^2 \cdot \text{C}}$$

$$h_2 = \frac{\dot{Q}}{A_s(T_s - T_{\infty 2})} = \frac{800 \text{ W}}{(0.00628 \text{ m}^2)(120 - 80)^\circ\text{C}} = \mathbf{3185 \text{ W/m}^2 \cdot \text{C}}$$

Discussion Note that a larger heat transfer coefficient is needed to dissipate heat through a smaller temperature difference for a specified heat transfer rate.

1-71 A hot water pipe at 80°C is losing heat to the surrounding air at 5°C by natural convection with a heat transfer coefficient of $25\text{ W/m}^2\cdot^{\circ}\text{C}$. The rate of heat loss from the pipe by convection is to be determined.

Assumptions **1** Steady operating conditions exist. **2** Heat transfer by radiation is not considered. **3** The convection heat transfer coefficient is constant and uniform over the surface.

Analysis The heat transfer surface area is

$$A_s = \pi DL = \pi(0.05\text{ m})(10\text{ m}) = 1.571\text{ m}^2$$

Under steady conditions, the rate of heat transfer by convection is

$$\dot{Q}_{\text{conv}} = hA_s\Delta T = (25\text{ W/m}^2\cdot^{\circ}\text{C})(1.571\text{ m}^2)(80 - 5)^{\circ}\text{C} = \mathbf{2945\text{ W}}$$

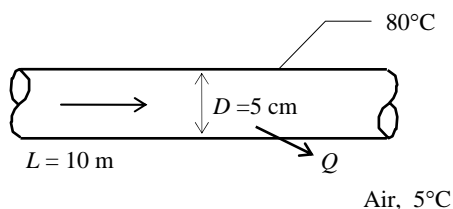

1-72 A hollow spherical iron container is filled with iced water at 0°C . The rate of heat loss from the sphere and the rate at which ice melts in the container are to be determined.

Assumptions **1** Steady operating conditions exist since the surface temperatures of the wall remain constant at the specified values. **2** Heat transfer through the shell is one-dimensional. **3** Thermal properties of the iron shell are constant. **4** The inner surface of the shell is at the same temperature as the iced water, 0°C .

Properties The thermal conductivity of iron is $k = 80.2\text{ W/m}\cdot^{\circ}\text{C}$ (Table A-3). The heat of fusion of water is given to be 333.7 kJ/kg .

Analysis This spherical shell can be approximated as a plate of thickness 0.4 cm and area

$$A = \pi D^2 = \pi(0.2\text{ m})^2 = 0.126\text{ m}^2$$

Then the rate of heat transfer through the shell by conduction is

$$\dot{Q}_{\text{cond}} = kA \frac{\Delta T}{L} = (80.2\text{ W/m}\cdot^{\circ}\text{C})(0.126\text{ m}^2) \frac{(5 - 0)^{\circ}\text{C}}{0.004\text{ m}} = 12,632\text{ W}$$

Considering that it takes 333.7 kJ of energy to melt 1 kg of ice at 0°C , the rate at which ice melts in the container can be determined from

$$\dot{m}_{\text{ice}} = \frac{\dot{Q}}{h_{if}} = \frac{12.632\text{ kJ/s}}{333.7\text{ kJ/kg}} = \mathbf{0.038\text{ kg/s}}$$

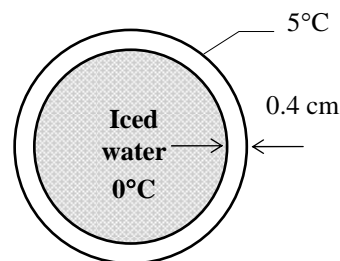

Discussion We should point out that this result is slightly in error for approximating a curved wall as a plain wall. The error in this case is very small because of the large diameter to thickness ratio. For better accuracy, we could use the inner surface area ($D = 19.2\text{ cm}$) or the mean surface area ($D = 19.6\text{ cm}$) in the calculations.

1-73 EES Prob. 1-72 is reconsidered. The rate at which ice melts as a function of the container thickness is to be plotted.

Analysis The problem is solved using EES, and the solution is given below.

"GIVEN"

D=0.2 [m]

L=0.4 [cm]

T_1=0 [C]

T_2=5 [C]

"PROPERTIES"

h_if=333.7 [kJ/kg]

k=k_('Iron', 25)

"ANALYSIS"

A=pi*D^2

Q_dot_cond=k*A*(T_2-T_1)/(L*Convert(cm, m))

m_dot_ice=(Q_dot_cond*Convert(W, kW))/h_if

L [cm]	m _{ice} [kg/s]
0.2	0.07574
0.4	0.03787
0.6	0.02525
0.8	0.01894
1	0.01515
1.2	0.01262
1.4	0.01082
1.6	0.009468
1.8	0.008416
2	0.007574

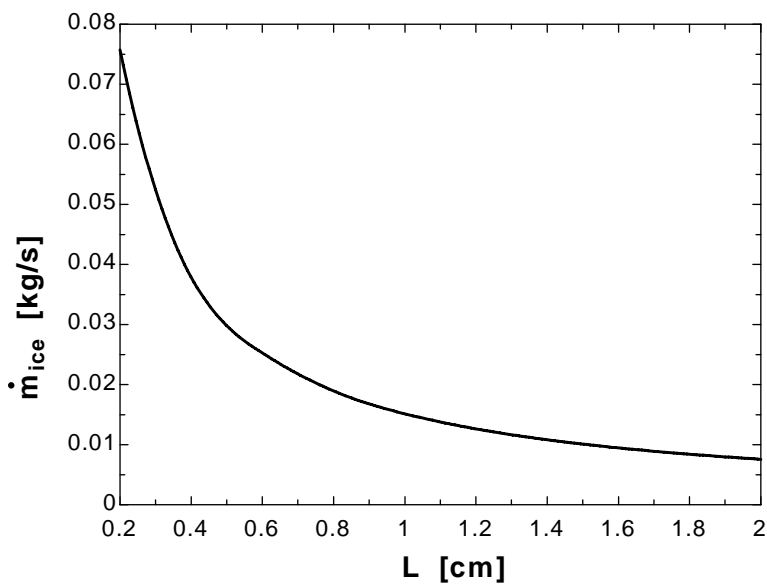

1-74E The inner and outer glasses of a double pane window with a 0.5-in air space are at specified temperatures. The rate of heat transfer through the window is to be determined

Assumptions 1 Steady operating conditions exist since the surface temperatures of the glass remain constant at the specified values. 2 Heat transfer through the window is one-dimensional. 3 Thermal properties of the air are constant.

Properties The thermal conductivity of air at the average temperature of $(60+48)/2 = 54^\circ\text{F}$ is $k = 0.01419 \text{ Btu/h}\cdot\text{ft}\cdot^\circ\text{F}$ (Table A-15E).

Analysis The area of the window and the rate of heat loss through it are

$$A = (4 \text{ ft}) \times (4 \text{ ft}) = 16 \text{ m}^2$$

$$\dot{Q} = kA \frac{T_1 - T_2}{L} = (0.01419 \text{ Btu/h}\cdot\text{ft}\cdot^\circ\text{F})(16 \text{ ft}^2) \frac{(60 - 48)^\circ\text{F}}{0.25/12 \text{ ft}} = \mathbf{131 \text{ Btu/h}}$$

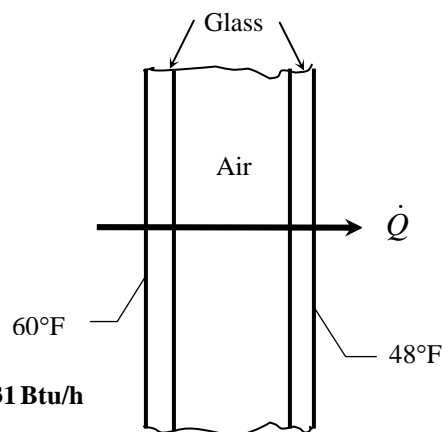

1-75 Two surfaces of a flat plate are maintained at specified temperatures, and the rate of heat transfer through the plate is measured. The thermal conductivity of the plate material is to be determined.

Assumptions 1 Steady operating conditions exist since the surface temperatures of the plate remain constant at the specified values. 2 Heat transfer through the plate is one-dimensional. 3 Thermal properties of the plate are constant.

Analysis The thermal conductivity is determined directly from the steady one-dimensional heat conduction relation to be

$$\dot{Q} = kA \frac{T_1 - T_2}{L} \rightarrow k = \frac{(\dot{Q}/A)L}{(T_1 - T_2)} = \frac{(500 \text{ W/m}^2)(0.02 \text{ m})}{(80 - 0)^\circ\text{C}} = \mathbf{0.125 \text{ W/m}\cdot^\circ\text{C}}$$

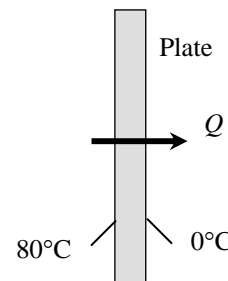

1-76 Four power transistors are mounted on a thin vertical aluminum plate that is cooled by a fan. The temperature of the aluminum plate is to be determined.

Assumptions 1 Steady operating conditions exist. 2 The entire plate is nearly isothermal. 3 Thermal properties of the wall are constant. 4 The exposed surface area of the transistor can be taken to be equal to its base area. 5 Heat transfer by radiation is disregarded. 6 The convection heat transfer coefficient is constant and uniform over the surface.

Analysis The total rate of heat dissipation from the aluminum plate and the total heat transfer area are

$$\dot{Q} = 4 \times 15 \text{ W} = 60 \text{ W}$$

$$A_s = (0.22 \text{ m})(0.22 \text{ m}) = 0.0484 \text{ m}^2$$

Disregarding any radiation effects, the temperature of the aluminum plate is determined to be

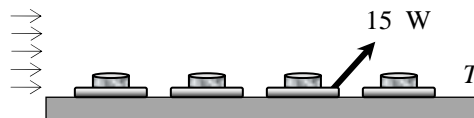

$$\dot{Q} = hA_s(T_s - T_\infty) \rightarrow T_s = T_\infty + \frac{\dot{Q}}{hA_s} = 25^\circ\text{C} + \frac{60 \text{ W}}{(25 \text{ W/m}^2 \cdot ^\circ\text{C})(0.0484 \text{ m}^2)} = \mathbf{74.6^\circ\text{C}}$$

1-77 A styrofoam ice chest is initially filled with 40 kg of ice at 0°C. The time it takes for the ice in the chest to melt completely is to be determined.

Assumptions **1** Steady operating conditions exist. **2** The inner and outer surface temperatures of the ice chest remain constant at 0°C and 8°C, respectively, at all times. **3** Thermal properties of the chest are constant. **4** Heat transfer from the base of the ice chest is negligible.

Properties The thermal conductivity of the styrofoam is given to be $k = 0.033 \text{ W/m}\cdot\text{°C}$. The heat of fusion of ice at 0°C is 333.7 kJ/kg.

Analysis Disregarding any heat loss through the bottom of the ice chest and using the average thicknesses, the total heat transfer area becomes

$$A = (40 - 3)(40 - 3) + 4 \times (40 - 3)(30 - 3) = 5365 \text{ cm}^2 = 0.5365 \text{ m}^2$$

The rate of heat transfer to the ice chest becomes

$$\dot{Q} = kA \frac{\Delta T}{L} = (0.033 \text{ W/m}\cdot\text{°C})(0.5365 \text{ m}^2) \frac{(8 - 0)\text{°C}}{0.03 \text{ m}} = 4.72 \text{ W}$$

The total amount of heat needed to melt the ice completely is

$$Q = mh_{if} = (28 \text{ kg})(333.7 \text{ kJ/kg}) = 9344 \text{ kJ}$$

Then transferring this much heat to the cooler to melt the ice completely will take

$$\Delta t = \frac{Q}{\dot{Q}} = \frac{9344,000 \text{ J}}{4.72 \text{ J/s}} = 1.98 \times 10^6 \text{ s} = \mathbf{22.9 \text{ days}}$$

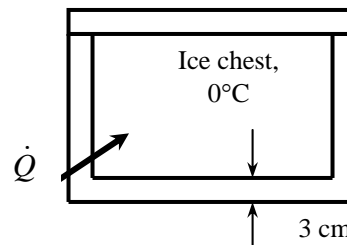

1-78 A transistor mounted on a circuit board is cooled by air flowing over it. The transistor case temperature is not to exceed 70°C when the air temperature is 55°C. The amount of power this transistor can dissipate safely is to be determined.

Assumptions **1** Steady operating conditions exist. **2** Heat transfer by radiation is disregarded. **3** The convection heat transfer coefficient is constant and uniform over the surface. **4** Heat transfer from the base of the transistor is negligible.

Analysis Disregarding the base area, the total heat transfer area of the transistor is

$$\begin{aligned} A_s &= \pi DL + \pi D^2 / 4 \\ &= \pi(0.6 \text{ cm})(0.4 \text{ cm}) + \pi(0.6 \text{ cm})^2 / 4 = 1.037 \text{ cm}^2 \\ &= 1.037 \times 10^{-4} \text{ m}^2 \end{aligned}$$

Then the rate of heat transfer from the power transistor at specified conditions is

$$\dot{Q} = hA_s(T_s - T_\infty) = (30 \text{ W/m}^2 \cdot \text{°C})(1.037 \times 10^{-4} \text{ m}^2)(70 - 55)\text{°C} = \mathbf{0.047 \text{ W}}$$

Therefore, the amount of power this transistor can dissipate safely is 0.047 W.

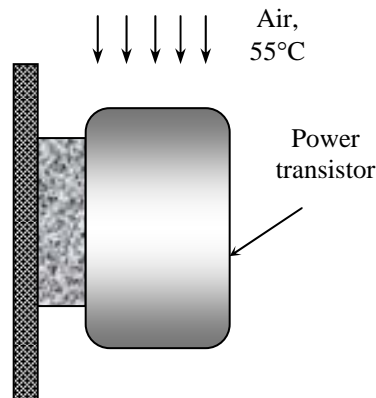

1-79 EES Prob. 1-78 is reconsidered. The amount of power the transistor can dissipate safely as a function of the maximum case temperature is to be plotted.

Analysis The problem is solved using EES, and the solution is given below.

"GIVEN"

$$L=0.004 \text{ [m]}$$

$$D=0.006 \text{ [m]}$$

$$h=30 \text{ [W/m}^2\text{-C]}$$

$$T_{\text{infinity}}=55 \text{ [C]}$$

$$T_{\text{case_max}}=70 \text{ [C]}$$

"ANALYSIS"

$$A=\pi*D*L+\pi*D^2/4$$

$$Q_{\text{dot}}=h*A*(T_{\text{case_max}}-T_{\text{infinity}})$$

$T_{\text{case,max}} \text{ [C]}$	$Q \text{ [W]}$
60	0.01555
62.5	0.02333
65	0.0311
67.5	0.03888
70	0.04665
72.5	0.05443
75	0.0622
77.5	0.06998
80	0.07775
82.5	0.08553
85	0.09331
87.5	0.1011
90	0.1089

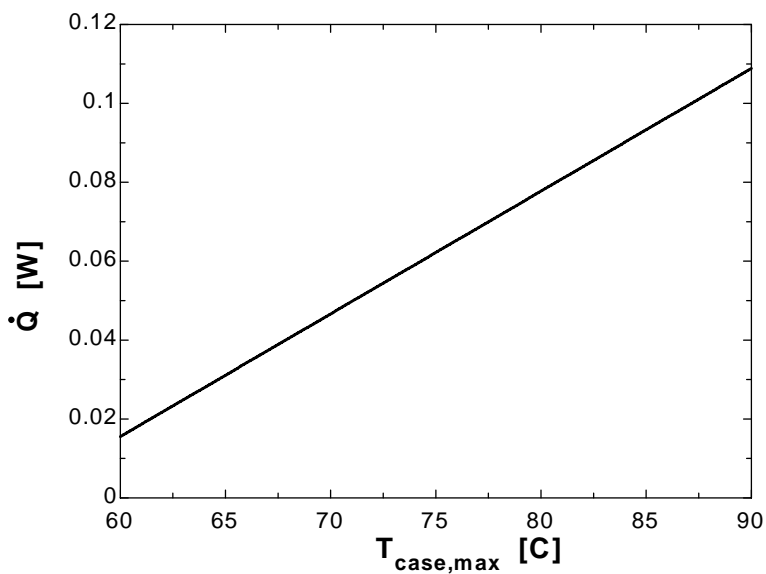

1-80E A 200-ft long section of a steam pipe passes through an open space at a specified temperature. The rate of heat loss from the steam pipe and the annual cost of this energy lost are to be determined.

Assumptions 1 Steady operating conditions exist. 2 Heat transfer by radiation is disregarded. 3 The convection heat transfer coefficient is constant and uniform over the surface.

Analysis (a) The rate of heat loss from the steam pipe is

$$A_s = \pi DL = \pi(4/12 \text{ ft})(200 \text{ ft}) = 209.4 \text{ ft}^2$$

$$\begin{aligned}\dot{Q}_{\text{pipe}} &= hA_s(T_s - T_{\text{air}}) = (6 \text{ Btu/h} \cdot \text{ft}^2 \cdot ^\circ\text{F})(209.4 \text{ ft}^2)(280 - 50)^\circ\text{F} \\ &= \mathbf{289,000 \text{ Btu/h}}\end{aligned}$$

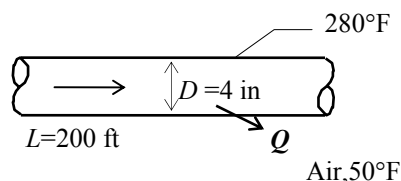

(b) The amount of heat loss per year is

$$Q = \dot{Q}\Delta t = (289,000 \text{ Btu/h})(365 \times 24 \text{ h/yr}) = 2.531 \times 10^9 \text{ Btu/yr}$$

The amount of gas consumption per year in the furnace that has an efficiency of 86% is

$$\text{Annual Energy Loss} = \frac{2.531 \times 10^9 \text{ Btu/yr}}{0.86} \left(\frac{1 \text{ therm}}{100,000 \text{ Btu}} \right) = 29,435 \text{ therms/yr}$$

Then the annual cost of the energy lost becomes

$$\begin{aligned}\text{Energy cost} &= (\text{Annual energy loss})(\text{Unit cost of energy}) \\ &= (29,435 \text{ therms/yr})(\$1.10 / \text{therm}) = \mathbf{\$32,380/\text{yr}}\end{aligned}$$

1-81 A 4-m diameter spherical tank filled with liquid nitrogen at 1 atm and -196°C is exposed to convection with ambient air. The rate of evaporation of liquid nitrogen in the tank as a result of the heat transfer from the ambient air is to be determined.

Assumptions 1 Steady operating conditions exist. 2 Heat transfer by radiation is disregarded. 3 The convection heat transfer coefficient is constant and uniform over the surface. 4 The temperature of the thin-shelled spherical tank is nearly equal to the temperature of the nitrogen inside.

Properties The heat of vaporization and density of liquid nitrogen at 1 atm are given to be 198 kJ/kg and 810 kg/m^3 , respectively.

Analysis The rate of heat transfer to the nitrogen tank is

$$A_s = \pi D^2 = \pi(4 \text{ m})^2 = 50.27 \text{ m}^2$$

$$\begin{aligned}\dot{Q} &= hA_s(T_s - T_{\text{air}}) = (25 \text{ W/m}^2 \cdot ^\circ\text{C})(50.27 \text{ m}^2)[20 - (-196)]^\circ\text{C} \\ &= \mathbf{271,430 \text{ W}}\end{aligned}$$

Then the rate of evaporation of liquid nitrogen in the tank is determined to be

$$\dot{Q} = \dot{m}h_{fg} \longrightarrow \dot{m} = \frac{\dot{Q}}{h_{fg}} = \frac{271.430 \text{ kJ/s}}{198 \text{ kJ/kg}} = \mathbf{1.37 \text{ kg/s}}$$

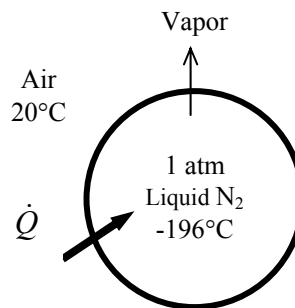

1-82 A 4-m diameter spherical tank filled with liquid oxygen at 1 atm and -183°C is exposed to convection with ambient air. The rate of evaporation of liquid oxygen in the tank as a result of the heat transfer from the ambient air is to be determined.

Assumptions **1** Steady operating conditions exist. **2** Heat transfer by radiation is disregarded. **3** The convection heat transfer coefficient is constant and uniform over the surface. **4** The temperature of the thin-shelled spherical tank is nearly equal to the temperature of the oxygen inside.

Properties The heat of vaporization and density of liquid oxygen at 1 atm are given to be 213 kJ/kg and 1140 kg/m^3 , respectively.

Analysis The rate of heat transfer to the oxygen tank is

$$A_s = \pi D^2 = \pi(4\text{ m})^2 = 50.27\text{ m}^2$$

$$\begin{aligned}\dot{Q} &= hA_s(T_s - T_{\text{air}}) = (25\text{ W/m}^2 \cdot ^{\circ}\text{C})(50.27\text{ m}^2)[20 - (-183)]^{\circ}\text{C} \\ &= \mathbf{255,120\text{ W}}\end{aligned}$$

Then the rate of evaporation of liquid oxygen in the tank is determined to be

$$\dot{Q} = \dot{m}h_{fg} \longrightarrow \dot{m} = \frac{\dot{Q}}{h_{fg}} = \frac{255.120\text{ kJ/s}}{213\text{ kJ/kg}} = \mathbf{1.20\text{ kg/s}}$$

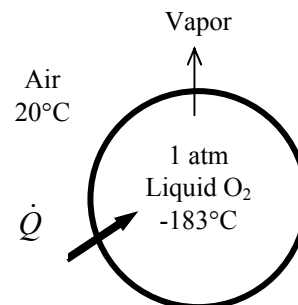

1-83 EES Prob. 1-81 is reconsidered. The rate of evaporation of liquid nitrogen as a function of the ambient air temperature is to be plotted.

Analysis The problem is solved using EES, and the solution is given below.

"GIVEN"

D=4 [m]
 T_s=-196 [C]
 T_air=20 [C]
 h=25 [W/m^2-C]

"PROPERTIES"

h_fg=198 [kJ/kg]

"ANALYSIS"

A=pi*D^2
 Q_dot=h*A*(T_air-T_s)
 m_dot_evap=(Q_dot*Convert(J/s, kJ/s))/h_fg

T _{air} [C]	m _{evap} [kg/s]
0	1.244
2.5	1.26
5	1.276
7.5	1.292
10	1.307
12.5	1.323
15	1.339
17.5	1.355
20	1.371
22.5	1.387
25	1.403
27.5	1.418
30	1.434
32.5	1.45
35	1.466

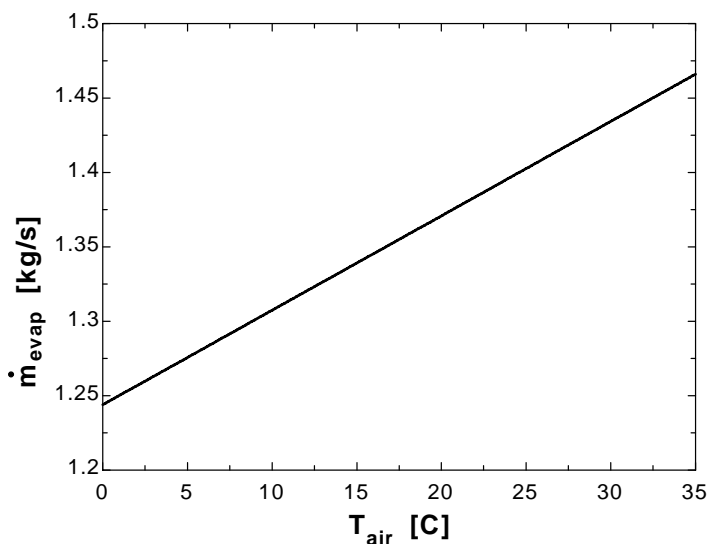

1-84 A person with a specified surface temperature is subjected to radiation heat transfer in a room at specified wall temperatures. The rate of radiation heat loss from the person is to be determined.

Assumptions **1** Steady operating conditions exist. **2** Heat transfer by convection is disregarded. **3** The emissivity of the person is constant and uniform over the exposed surface.

Properties The average emissivity of the person is given to be 0.5.

Analysis Noting that the person is completely enclosed by the surrounding surfaces, the net rates of radiation heat transfer from the body to the surrounding walls, ceiling, and the floor in both cases are

(a) $T_{\text{surr}} = 300 \text{ K}$

$$\begin{aligned}\dot{Q}_{\text{rad}} &= \varepsilon \sigma A_s (T_s^4 - T_{\text{surr}}^4) \\ &= (0.5)(5.67 \times 10^{-8} \text{ W/m}^2 \cdot \text{K}^4)(1.7 \text{ m}^2)[(32 + 273)^4 - (300 \text{ K})^4] \text{ K}^4 \\ &= \mathbf{26.7 \text{ W}}\end{aligned}$$

(b) $T_{\text{surr}} = 280 \text{ K}$

$$\begin{aligned}\dot{Q}_{\text{rad}} &= \varepsilon \sigma A_s (T_s^4 - T_{\text{surr}}^4) \\ &= (0.5)(5.67 \times 10^{-8} \text{ W/m}^2 \cdot \text{K}^4)(1.7 \text{ m}^2)[(32 + 273)^4 - (280 \text{ K})^4] \text{ K}^4 \\ &= \mathbf{121 \text{ W}}\end{aligned}$$

Discussion Note that the radiation heat transfer goes up by more than 4 times as the temperature of the surrounding surfaces drops from 300 K to 280 K.

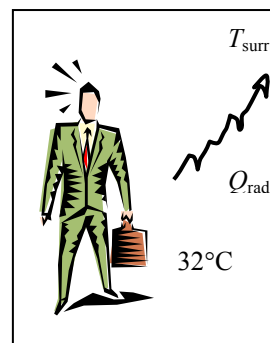

1-85 A circuit board houses 80 closely spaced logic chips on one side, each dissipating 0.06 W. All the heat generated in the chips is conducted across the circuit board. The temperature difference between the two sides of the circuit board is to be determined.

Assumptions **1** Steady operating conditions exist. **2** Thermal properties of the board are constant. **3** All the heat generated in the chips is conducted across the circuit board.

Properties The effective thermal conductivity of the board is given to be $k = 16 \text{ W/m} \cdot ^\circ\text{C}$.

Analysis The total rate of heat dissipated by the chips is

$$\dot{Q} = 80 \times (0.06 \text{ W}) = 4.8 \text{ W}$$

Then the temperature difference between the front and back surfaces of the board is

$$A = (0.12 \text{ m})(0.18 \text{ m}) = 0.0216 \text{ m}^2$$

$$\dot{Q} = kA \frac{\Delta T}{L} \longrightarrow \Delta T = \frac{\dot{Q}L}{kA} = \frac{(4.8 \text{ W})(0.003 \text{ m})}{(16 \text{ W/m} \cdot ^\circ\text{C})(0.0216 \text{ m}^2)} = \mathbf{0.042^\circ\text{C}}$$

Discussion Note that the circuit board is nearly isothermal.

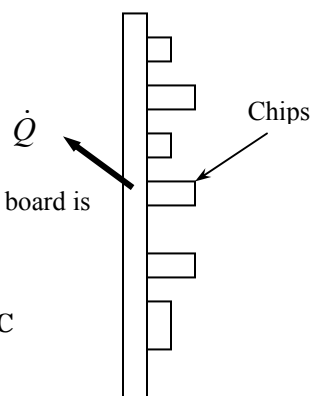

1-86 A sealed electronic box dissipating a total of 100 W of power is placed in a vacuum chamber. If this box is to be cooled by radiation alone and the outer surface temperature of the box is not to exceed 55°C, the temperature the surrounding surfaces must be kept is to be determined.

Assumptions **1** Steady operating conditions exist. **2** Heat transfer by convection is disregarded. **3** The emissivity of the box is constant and uniform over the exposed surface. **4** Heat transfer from the bottom surface of the box to the stand is negligible.

Properties The emissivity of the outer surface of the box is given to be 0.95.

Analysis Disregarding the base area, the total heat transfer area of the electronic box is

$$A_s = (0.4 \text{ m})(0.4 \text{ m}) + 4 \times (0.2 \text{ m})(0.4 \text{ m}) = 0.48 \text{ m}^2$$

The radiation heat transfer from the box can be expressed as

$$\dot{Q}_{\text{rad}} = \varepsilon \sigma A_s (T_s^4 - T_{\text{surr}}^4)$$

$$100 \text{ W} = (0.95)(5.67 \times 10^{-8} \text{ W/m}^2 \cdot \text{K}^4)(0.48 \text{ m}^2) [(55 + 273 \text{ K})^4 - T_{\text{surr}}^4]$$

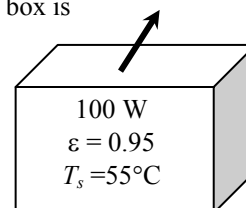

which gives $T_{\text{surr}} = 296.3 \text{ K} = 23.3^\circ\text{C}$. Therefore, the temperature of the surrounding surfaces must be less than 23.3°C.

1-87E Using the conversion factors between W and Btu/h, m and ft, and K and R, the Stefan-Boltzmann constant $\sigma = 5.67 \times 10^{-8} \text{ W/m}^2 \cdot \text{K}^4$ is to be expressed in the English unit, $\text{Btu/h} \cdot \text{ft}^2 \cdot \text{R}^4$.

Analysis The conversion factors for W, m, and K are given in conversion tables to be

$$1 \text{ W} = 3.41214 \text{ Btu/h}$$

$$1 \text{ m} = 3.2808 \text{ ft}$$

$$1 \text{ K} = 1.8 \text{ R}$$

Substituting gives the Stefan-Boltzmann constant in the desired units,

$$\sigma = 5.67 \text{ W/m}^2 \cdot \text{K}^4 = 5.67 \times \frac{3.41214 \text{ Btu/h}}{(3.2808 \text{ ft})^2 (1.8 \text{ R})^4} = \mathbf{0.171 \text{ Btu/h} \cdot \text{ft}^2 \cdot \text{R}^4}$$

1-88E Using the conversion factors between W and Btu/h, m and ft, and °C and °F, the convection coefficient in SI units is to be expressed in $\text{Btu/h} \cdot \text{ft}^2 \cdot ^\circ\text{F}$.

Analysis The conversion factors for W and m are straightforward, and are given in conversion tables to be

$$1 \text{ W} = 3.41214 \text{ Btu/h}$$

$$1 \text{ m} = 3.2808 \text{ ft}$$

The proper conversion factor between °C into °F in this case is

$$1^\circ\text{C} = 1.8^\circ\text{F}$$

since the °C in the unit $\text{W/m}^2 \cdot ^\circ\text{C}$ represents *per °C change in temperature*, and 1°C change in temperature corresponds to a change of 1.8°F. Substituting, we get

$$1 \text{ W/m}^2 \cdot ^\circ\text{C} = \frac{3.41214 \text{ Btu/h}}{(3.2808 \text{ ft})^2 (1.8^\circ\text{F})} = 0.1761 \text{ Btu/h} \cdot \text{ft}^2 \cdot ^\circ\text{F}$$

which is the desired conversion factor. Therefore, the given convection heat transfer coefficient in English units is

$$h = 14 \text{ W/m}^2 \cdot ^\circ\text{C} = 14 \times 0.1761 \text{ Btu/h} \cdot \text{ft}^2 \cdot ^\circ\text{F} = \mathbf{2.47 \text{ Btu/h} \cdot \text{ft}^2 \cdot ^\circ\text{F}}$$

1-89 A cylindrical sample of a material is used to determine its thermal conductivity. The temperatures measured along the sample are tabulated. The variation of temperature along the sample is to be plotted and the thermal conductivity of the sample material is to be calculated.

Assumptions 1 Steady operating conditions exist. 2 Heat transfer is one-dimensional (axial direction).

Analysis The following table gives the results of the calculations. The plot of temperatures is also given below. A sample calculation for the thermal conductivity is as follows:

$$A = \frac{\pi D^2}{4} = \frac{\pi(0.025 \text{ m})^2}{4} = 0.00049 \text{ m}^2$$

$$k_{12} = \frac{\dot{Q}L}{A(T_1 - T_2)}$$

$$= \frac{(83.45 \text{ W})(0.010 \text{ m})}{(0.00049 \text{ m}^2)(6.13^\circ\text{C})} = 277.8 \text{ W/m}\cdot^\circ\text{C}$$

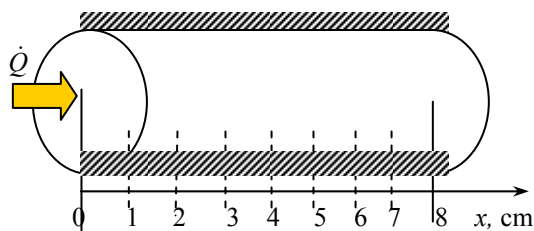

Distance from left face, cm	Temperature, °C	Temperature difference (°C)	Thermal conductivity (W/m·°C)
0	T ₁ = 89.38	T ₁ -T ₂ = 6.13	277.8
1	T ₂ = 83.25	T ₂ -T ₃ = 4.97	342.7
2	T ₃ = 78.28	T ₃ -T ₄ = 4.18	407.4
3	T ₄ = 74.10	T ₄ -T ₅ = 5.85	291.1
4	T ₅ = 68.25	T ₅ -T ₆ = 4.52	376.8
5	T ₆ =63.73	T ₆ -T ₇ = 14.08	120.9
6	T ₇ = 49.65	T ₇ -T ₈ = 5.25	324.4
7	T ₈ = 44.40	T ₈ -T ₉ = 4.40	387.1
8	T ₉ = 40.00	T ₁ -T ₂ = 6.13	277.8

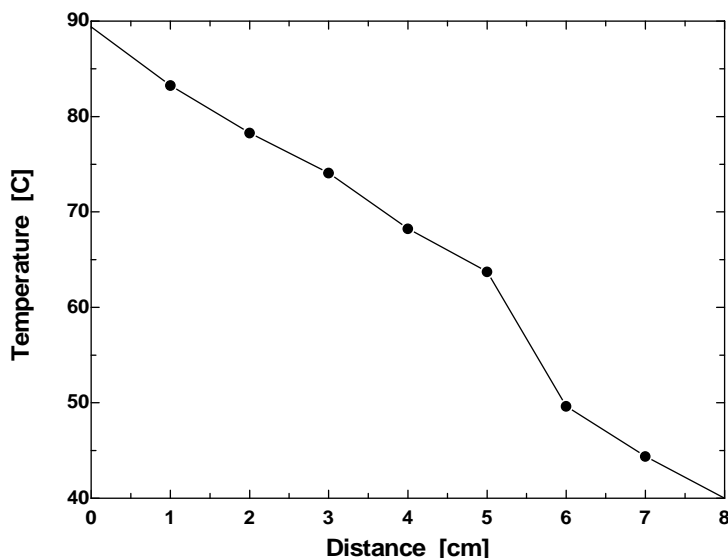

Discussion It is observed from the calculations in the table and the plot of temperatures that the temperature reading corresponding to the calculated thermal conductivity of 120.9 is probably not right, and it should be discarded.

1-90 An aircraft flying under icing conditions is considered. The temperature of the wings to prevent ice from forming on them is to be determined.

Assumptions **1** Steady operating conditions exist. **2** Heat transfer coefficient is constant.

Properties The heat of fusion and the density of ice are given to be 333.7 kJ/kg and 920 kg/m³, respectively.

Analysis The temperature of the wings to prevent ice from forming on them is determined to be

$$T_{\text{wing}} = T_{\text{ice}} + \frac{\rho V h_{if}}{h} = 0^{\circ}\text{C} + \frac{(920 \text{ kg/m}^3)(0.001/60 \text{ m/s})(333,700 \text{ J/kg})}{150 \text{ W/m}^2 \cdot ^{\circ}\text{C}} = \mathbf{34.1^{\circ}\text{C}}$$

Simultaneous Heat Transfer Mechanisms

1-91C All three modes of heat transfer can not occur simultaneously in a medium. A medium may involve two of them simultaneously.

1-92C (a) Conduction and convection: No. (b) Conduction and radiation: Yes. Example: A hot surface on the ceiling. (c) Convection and radiation: Yes. Example: Heat transfer from the human body.

1-93C The human body loses heat by convection, radiation, and evaporation in both summer and winter. In summer, we can keep cool by dressing lightly, staying in cooler environments, turning a fan on, avoiding humid places and direct exposure to the sun. In winter, we can keep warm by dressing heavily, staying in a warmer environment, and avoiding drafts.

1-94C The fan increases the air motion around the body and thus the convection heat transfer coefficient, which increases the rate of heat transfer from the body by convection and evaporation. In rooms with high ceilings, ceiling fans are used in winter to force the warm air at the top downward to increase the air temperature at the body level. This is usually done by forcing the air up which hits the ceiling and moves downward in a gently manner to avoid drafts.

1-95 The total rate of heat transfer from a person by both convection and radiation to the surrounding air and surfaces at specified temperatures is to be determined.

Assumptions 1 Steady operating conditions exist. **2** The person is completely surrounded by the interior surfaces of the room. **3** The surrounding surfaces are at the same temperature as the air in the room. **4** Heat conduction to the floor through the feet is negligible. **5** The convection coefficient is constant and uniform over the entire surface of the person.

Properties The emissivity of a person is given to be $\varepsilon = 0.9$.

Analysis The person is completely enclosed by the surrounding surfaces, and he or she will lose heat to the surrounding air by convection and to the surrounding surfaces by radiation. The total rate of heat loss from the person is determined from

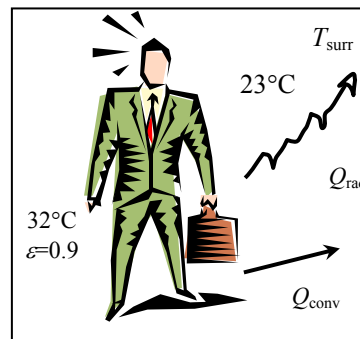

$$\dot{Q}_{\text{rad}} = \varepsilon \sigma A_s (T_s^4 - T_{\text{surr}}^4) = (0.90)(5.67 \times 10^{-8} \text{ W/m}^2 \cdot \text{K}^4)(1.7 \text{ m}^2)[(32 + 273)^4 - (23 + 273)^4] \text{ K}^4 = 84.8 \text{ W}$$

$$\dot{Q}_{\text{conv}} = h A_s \Delta T = (5 \text{ W/m}^2 \cdot \text{K})(1.7 \text{ m}^2)(32 - 23)^\circ\text{C} = 76.5 \text{ W}$$

$$\text{And } \dot{Q}_{\text{total}} = \dot{Q}_{\text{conv}} + \dot{Q}_{\text{rad}} = 84.8 + 76.5 = \mathbf{161.3 \text{ W}}$$

Discussion Note that heat transfer from the person by evaporation, which is of comparable magnitude, is not considered in this problem.

1-96 Two large plates at specified temperatures are held parallel to each other. The rate of heat transfer between the plates is to be determined for the cases of still air, evacuation, regular insulation, and super insulation between the plates.

Assumptions 1 Steady operating conditions exist since the plate temperatures remain constant. **2** Heat transfer is one-dimensional since the plates are large. **3** The surfaces are black and thus $\varepsilon = 1$. **4** There are no convection currents in the air space between the plates.

Properties The thermal conductivities are $k = 0.00015 \text{ W/m} \cdot ^\circ\text{C}$ for super insulation, $k = 0.01979 \text{ W/m} \cdot ^\circ\text{C}$ at -50°C (Table A-15) for air, and $k = 0.036 \text{ W/m} \cdot ^\circ\text{C}$ for fiberglass insulation (Table A-6).

Analysis (a) Disregarding any natural convection currents, the rates of conduction and radiation heat transfer

$$\dot{Q}_{\text{cond}} = kA \frac{T_1 - T_2}{L} = (0.01979 \text{ W/m}^2 \cdot ^\circ\text{C})(1 \text{ m}^2) \frac{(290 - 150) \text{ K}}{0.02 \text{ m}} = 139 \text{ W}$$

$$\begin{aligned} \dot{Q}_{\text{rad}} &= \varepsilon \sigma A_s (T_1^4 - T_2^4) \\ &= 1(5.67 \times 10^{-8} \text{ W/m}^2 \cdot \text{K}^4)(1 \text{ m}^2)[(290 \text{ K})^4 - (150 \text{ K})^4] = 372 \text{ W} \end{aligned}$$

$$\dot{Q}_{\text{total}} = \dot{Q}_{\text{cond}} + \dot{Q}_{\text{rad}} = 139 + 372 = \mathbf{511 \text{ W}}$$

(b) When the air space between the plates is evacuated, there will be radiation heat transfer only. Therefore,

$$\dot{Q}_{\text{total}} = \dot{Q}_{\text{rad}} = \mathbf{372 \text{ W}}$$

(c) In this case there will be conduction heat transfer through the fiberglass insulation only,

$$\dot{Q}_{\text{total}} = \dot{Q}_{\text{cond}} = kA \frac{T_1 - T_2}{L} = (0.036 \text{ W/m} \cdot ^\circ\text{C})(1 \text{ m}^2) \frac{(290 - 150) \text{ K}}{0.02 \text{ m}} = \mathbf{252 \text{ W}}$$

(d) In the case of superinsulation, the rate of heat transfer will be

$$\dot{Q}_{\text{total}} = \dot{Q}_{\text{cond}} = kA \frac{T_1 - T_2}{L} = (0.00015 \text{ W/m} \cdot ^\circ\text{C})(1 \text{ m}^2) \frac{(290 - 150) \text{ K}}{0.02 \text{ m}} = \mathbf{1.05 \text{ W}}$$

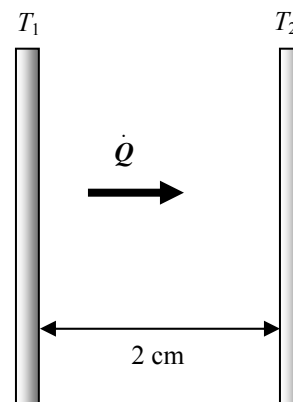

Discussion Note that superinsulators are very effective in reducing heat transfer between two surfaces.

1-97 The outer surface of a wall is exposed to solar radiation. The effective thermal conductivity of the wall is to be determined.

Assumptions 1 Steady operating conditions exist. 2 The heat transfer coefficient is constant and uniform over the surface.

Properties Both the solar absorptivity and emissivity of the wall surface are given to be 0.8.

Analysis The heat transfer through the wall by conduction is equal to net heat transfer to the outer wall surface:

$$\begin{aligned} \dot{q}_{\text{cond}} &= \dot{q}_{\text{conv}} + \dot{q}_{\text{rad}} + \dot{q}_{\text{solar}} \\ k \frac{T_2 - T_1}{L} &= h(T_o - T_2) + \varepsilon\sigma(T_{\text{surr}}^4 - T_2^4) + \alpha_s q_{\text{solar}} \\ k \frac{(44 - 27)^\circ\text{C}}{0.25 \text{ m}} &= (8 \text{ W/m}^2 \cdot ^\circ\text{C})(40 - 44)^\circ\text{C} + (0.8)(5.67 \times 10^{-8} \text{ W/m}^2 \cdot \text{K}^4) \left[(40 + 273 \text{ K})^4 - (44 + 273 \text{ K})^4 \right] \\ &\quad + (0.8)(150 \text{ W/m}^2) \end{aligned}$$

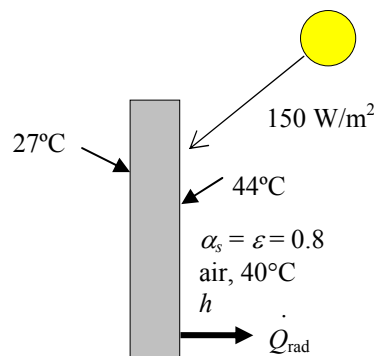

Solving for k gives

$$k = \mathbf{0.961 \text{ W/m} \cdot ^\circ\text{C}}$$

1-98 The convection heat transfer coefficient for heat transfer from an electrically heated wire to air is to be determined by measuring temperatures when steady operating conditions are reached and the electric power consumed.

Assumptions 1 Steady operating conditions exist since the temperature readings do not change with time. 2 Radiation heat transfer is negligible.

Analysis In steady operation, the rate of heat loss from the wire equals the rate of heat generation in the wire as a result of resistance heating. That is,

$$\dot{Q} = \dot{E}_{\text{generated}} = \mathbf{VI} = (110 \text{ V})(3 \text{ A}) = 330 \text{ W}$$

The surface area of the wire is

$$A_s = \pi DL = \pi(0.002 \text{ m})(1.4 \text{ m}) = 0.00880 \text{ m}^2$$

The Newton's law of cooling for convection heat transfer is expressed as

$$\dot{Q} = hA_s(T_s - T_\infty)$$

Disregarding any heat transfer by radiation, the convection heat transfer coefficient is determined to be

$$h = \frac{\dot{Q}}{A_s(T_1 - T_\infty)} = \frac{330 \text{ W}}{(0.00880 \text{ m}^2)(240 - 20)^\circ\text{C}} = \mathbf{170.5 \text{ W/m}^2 \cdot ^\circ\text{C}}$$

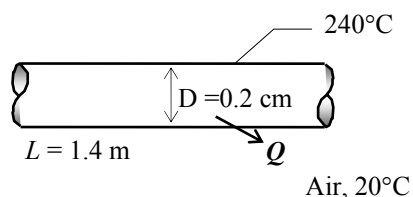

Discussion If the temperature of the surrounding surfaces is equal to the air temperature in the room, the value obtained above actually represents the combined convection and radiation heat transfer coefficient.

1-99 EES Prob. 1-98 is reconsidered. The convection heat transfer coefficient as a function of the wire surface temperature is to be plotted.

Analysis The problem is solved using EES, and the solution is given below.

"GIVEN"

L=1.4 [m]
 D=0.002 [m]
 T_infinity=20 [C]
 T_s=240 [C]
 V=110 [Volt]
 I=3 [Ampere]

"ANALYSIS"

Q_dot=V*I
 A=pi*D*L
 Q_dot=h*A*(T_s-T_infinity)

T _s [C]	h [W/m ² .C]
100	468.9
120	375.2
140	312.6
160	268
180	234.5
200	208.4
220	187.6
240	170.5
260	156.3
280	144.3
300	134

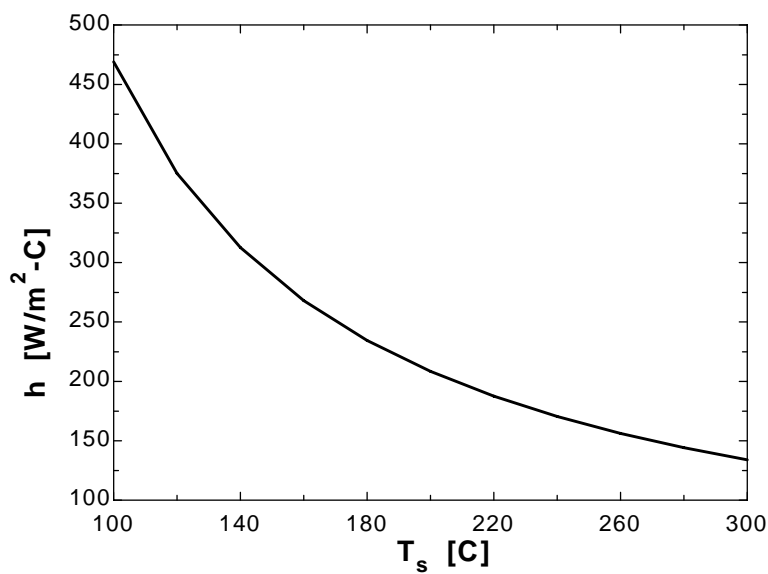

1-100E A spherical ball whose surface is maintained at a temperature of 170°F is suspended in the middle of a room at 70°F. The total rate of heat transfer from the ball is to be determined.

Assumptions 1 Steady operating conditions exist since the ball surface and the surrounding air and surfaces remain at constant temperatures. **2** The thermal properties of the ball and the convection heat transfer coefficient are constant and uniform.

Properties The emissivity of the ball surface is given to be $\varepsilon = 0.8$.

Analysis The heat transfer surface area is

$$A_s = \pi D^2 = \pi(2/12 \text{ ft})^2 = 0.08727 \text{ ft}^2$$

Under steady conditions, the rates of convection and radiation heat transfer are

$$\dot{Q}_{\text{conv}} = hA_s \Delta T = (15 \text{ Btu/h} \cdot \text{ft}^2 \cdot ^\circ\text{F})(0.08727 \text{ ft}^2)(170 - 70)^\circ\text{F} = 130.9 \text{ Btu/h}$$

$$\begin{aligned} \dot{Q}_{\text{rad}} &= \varepsilon \sigma A_s (T_s^4 - T_o^4) \\ &= 0.8(0.08727 \text{ ft}^2)(0.1714 \times 10^{-8} \text{ Btu/h} \cdot \text{ft}^2 \cdot \text{R}^4)[(170 + 460 \text{ R})^4 - (70 + 460 \text{ R})^4] \\ &= 9.4 \text{ Btu/h} \end{aligned}$$

Therefore, $\dot{Q}_{\text{total}} = \dot{Q}_{\text{conv}} + \dot{Q}_{\text{rad}} = 130.9 + 9.4 = \mathbf{140.3 \text{ Btu/h}}$

Discussion Note that heat loss by convection is several times that of heat loss by radiation. The radiation heat loss can further be reduced by coating the ball with a low-emissivity material.

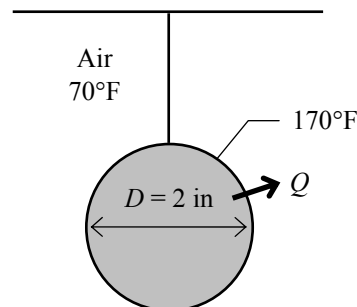

1-101 A 1000-W iron is left on the iron board with its base exposed to the air at 20°C. The temperature of the base of the iron is to be determined in steady operation.

Assumptions 1 Steady operating conditions exist. **2** The thermal properties of the iron base and the convection heat transfer coefficient are constant and uniform. **3** The temperature of the surrounding surfaces is the same as the temperature of the surrounding air.

Properties The emissivity of the base surface is given to be $\varepsilon = 0.6$.

Analysis At steady conditions, the 1000 W energy supplied to the iron will be dissipated to the surroundings by convection and radiation heat transfer. Therefore,

$$\dot{Q}_{\text{total}} = \dot{Q}_{\text{conv}} + \dot{Q}_{\text{rad}} = 1000 \text{ W}$$

where $\dot{Q}_{\text{conv}} = hA_s \Delta T = (35 \text{ W/m}^2 \cdot \text{K})(0.02 \text{ m}^2)(T_s - 293 \text{ K}) = 0.7(T_s - 293 \text{ K})$

and $\dot{Q}_{\text{rad}} = \varepsilon \sigma A_s (T_s^4 - T_o^4) = 0.6(0.02 \text{ m}^2)(5.67 \times 10^{-8} \text{ W/m}^2 \cdot \text{K}^4)[T_s^4 - (293 \text{ K})^4]$
 $= 0.06804 \times 10^{-8} [T_s^4 - (293 \text{ K})^4]$

Substituting, $1000 \text{ W} = 0.7(T_s - 293 \text{ K}) + 0.06804 \times 10^{-8} [T_s^4 - (293 \text{ K})^4]$

Solving by trial and error gives

$$T_s = \mathbf{947 \text{ K} = 674^\circ\text{C}}$$

Discussion We note that the iron will dissipate all the energy it receives by convection and radiation when its surface temperature reaches 947 K.

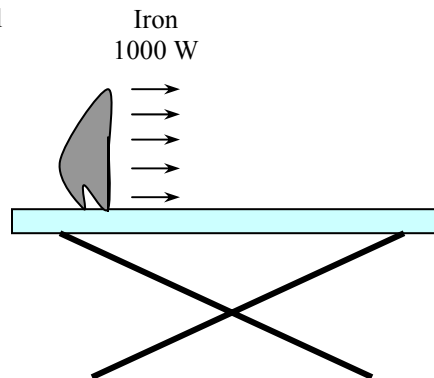

1-102 A spacecraft in space absorbs solar radiation while losing heat to deep space by thermal radiation. The surface temperature of the spacecraft is to be determined when steady conditions are reached.

Assumptions 1 Steady operating conditions exist since the surface temperatures of the wall remain constant at the specified values. **2** Thermal properties of the wall are constant.

Properties The outer surface of a spacecraft has an emissivity of 0.8 and an absorptivity of 0.3.

Analysis When the heat loss from the outer surface of the spacecraft by radiation equals the solar radiation absorbed, the surface temperature can be determined from

$$\dot{Q}_{\text{solar absorbed}} = \dot{Q}_{\text{rad}}$$

$$\alpha \dot{Q}_{\text{solar}} = \varepsilon \sigma A_s (T_s^4 - T_{\text{space}}^4)$$

$$0.3 \times A_s \times (950 \text{ W/m}^2) = 0.8 \times A_s \times (5.67 \times 10^{-8} \text{ W/m}^2 \cdot \text{K}^4) [T_s^4 - (0 \text{ K})^4]$$

Canceling the surface area A and solving for T_s gives

$$T_s = \mathbf{281.5 \text{ K}}$$

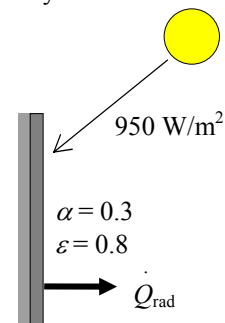

1-103 A spherical tank located outdoors is used to store iced water at 0°C . The rate of heat transfer to the iced water in the tank and the amount of ice at 0°C that melts during a 24-h period are to be determined.

Assumptions 1 Steady operating conditions exist since the surface temperatures of the wall remain constant at the specified values. **2** Thermal properties of the tank and the convection heat transfer coefficient is constant and uniform. **3** The average surrounding surface temperature for radiation exchange is 15°C . **4** The thermal resistance of the tank is negligible, and the entire steel tank is at 0°C .

Properties The heat of fusion of water at atmospheric pressure is $h_{if} = 333.7 \text{ kJ/kg}$. The emissivity of the outer surface of the tank is 0.75.

Analysis (a) The outer surface area of the spherical tank is

$$A_s = \pi D^2 = \pi (3.02 \text{ m})^2 = 28.65 \text{ m}^2$$

Then the rates of heat transfer to the tank by convection and radiation become

$$\dot{Q}_{\text{conv}} = h A_s (T_\infty - T_s) = (30 \text{ W/m}^2 \cdot ^\circ\text{C})(28.65 \text{ m}^2)(25 - 0)^\circ\text{C} = 21,488 \text{ W}$$

$$\dot{Q}_{\text{rad}} = \varepsilon A_s \sigma (T_{\text{surr}}^4 - T_s^4) = (0.75)(28.65 \text{ m}^2)(5.67 \times 10^{-8} \text{ W/m}^2 \cdot \text{K}^4) [(288 \text{ K})^4 - (273 \text{ K})^4] = 1614 \text{ W}$$

$$\dot{Q}_{\text{total}} = \dot{Q}_{\text{conv}} + \dot{Q}_{\text{rad}} = 21,488 + 1614 = 23,102 \text{ W} = \mathbf{23.1 \text{ kW}}$$

(b) The amount of heat transfer during a 24-hour period is

$$Q = \dot{Q} \Delta t = (23.102 \text{ kJ/s})(24 \times 3600 \text{ s}) = 1,996,000 \text{ kJ}$$

Then the amount of ice that melts during this period becomes

$$Q = m h_{if} \longrightarrow m = \frac{Q}{h_{if}} = \frac{1,996,000 \text{ kJ}}{333.7 \text{ kJ/kg}} = \mathbf{5980 \text{ kg}}$$

Discussion The amount of ice that melts can be reduced to a small fraction by insulating the tank.

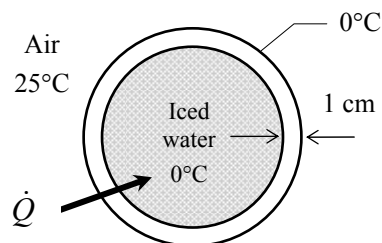

1-104 The roof of a house with a gas furnace consists of a 15-cm thick concrete that is losing heat to the outdoors by radiation and convection. The rate of heat transfer through the roof and the money lost through the roof that night during a 14 hour period are to be determined.

Assumptions 1 Steady operating conditions exist. 2 The emissivity and thermal conductivity of the roof are constant.

Properties The thermal conductivity of the concrete is given to be $k = 2 \text{ W/m}\cdot\text{°C}$. The emissivity of the outer surface of the roof is given to be 0.9.

Analysis In steady operation, heat transfer from the outer surface of the roof to the surroundings by convection and radiation must be equal to the heat transfer through the roof by conduction. That is,

$$\dot{Q} = \dot{Q}_{\text{roof, cond}} = \dot{Q}_{\text{roof to surroundings, conv+rad}}$$

The inner surface temperature of the roof is given to be $T_{s,\text{in}} = 15^\circ\text{C}$. Letting $T_{s,\text{out}}$ denote the outer surface temperatures of the roof, the energy balance above can be expressed as

$$\dot{Q} = kA \frac{T_{s,\text{in}} - T_{s,\text{out}}}{L} = h_o A (T_{s,\text{out}} - T_{\text{surr}}) + \varepsilon A \sigma (T_{s,\text{out}}^4 - T_{\text{surr}}^4)$$

$$\begin{aligned} \dot{Q} &= (2 \text{ W/m}\cdot\text{°C})(300 \text{ m}^2) \frac{15^\circ\text{C} - T_{s,\text{out}}}{0.15 \text{ m}} \\ &= (15 \text{ W/m}^2\cdot\text{°C})(300 \text{ m}^2)(T_{s,\text{out}} - 10)^\circ\text{C} \\ &\quad + (0.9)(300 \text{ m}^2)(5.67 \times 10^{-8} \text{ W/m}^2\cdot\text{K}^4) \left[(T_{s,\text{out}} + 273 \text{ K})^4 - (255 \text{ K})^4 \right] \end{aligned}$$

Solving the equations above using an equation solver (or by trial and error) gives

$$\dot{Q} = \mathbf{25,450 \text{ W}} \text{ and } T_{s,\text{out}} = \mathbf{8.64^\circ\text{C}}$$

Then the amount of natural gas consumption during a 16-hour period is

$$E_{\text{gas}} = \frac{Q_{\text{total}}}{0.85} = \frac{\dot{Q}\Delta t}{0.85} = \frac{(25.450 \text{ kJ/s})(14 \times 3600 \text{ s})}{0.85} \left(\frac{1 \text{ therm}}{105,500 \text{ kJ}} \right) = 14.3 \text{ therms}$$

Finally, the money lost through the roof during that period is

$$\text{Money lost} = (14.3 \text{ therms})(\$0.60 / \text{therm}) = \mathbf{\$8.58}$$

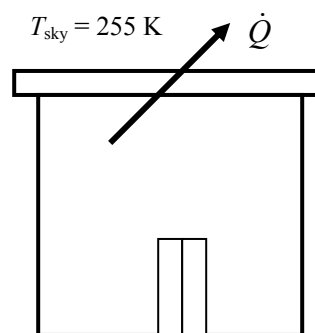

1-105E A flat plate solar collector is placed horizontally on the roof of a house. The rate of heat loss from the collector by convection and radiation during a calm day are to be determined.

Assumptions 1 Steady operating conditions exist. 2 The emissivity and convection heat transfer coefficient are constant and uniform. 3 The exposed surface, ambient, and sky temperatures remain constant.

Properties The emissivity of the outer surface of the collector is given to be 0.9.

Analysis The exposed surface area of the collector is

$$A_s = (5 \text{ ft})(15 \text{ ft}) = 75 \text{ ft}^2$$

Noting that the exposed surface temperature of the collector is 100°F , the total rate of heat loss from the collector to the environment by convection and radiation becomes

$$\dot{Q}_{\text{conv}} = hA_s(T_\infty - T_s) = (2.5 \text{ Btu/h}\cdot\text{ft}^2\cdot\text{°F})(75 \text{ ft}^2)(100 - 70)^\circ\text{F} = 5625 \text{ Btu/h}$$

$$\begin{aligned} \dot{Q}_{\text{rad}} &= \varepsilon A_s \sigma (T_{\text{surr}}^4 - T_s^4) = (0.9)(75 \text{ ft}^2)(0.1714 \times 10^{-8} \text{ Btu/h}\cdot\text{ft}^2\cdot\text{R}^4) [(100 + 460 \text{ R})^4 - (50 + 460 \text{ R})^4] \\ &= 3551 \text{ Btu/h} \end{aligned}$$

$$\text{and } \dot{Q}_{\text{total}} = \dot{Q}_{\text{conv}} + \dot{Q}_{\text{rad}} = 5625 + 3551 = \mathbf{9176 \text{ Btu/h}}$$

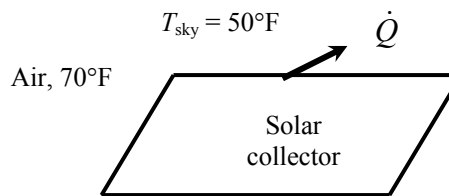

Problem Solving Techniques and EES

1-106C Despite the convenience and capability the engineering software packages offer, they are still just tools, and they will not replace the traditional engineering courses. They will simply cause a shift in emphasis in the course material from mathematics to physics. They are of great value in engineering practice, however, as engineers today rely on software packages for solving large and complex problems in a short time, and perform optimization studies efficiently.

1-107 EES Determine a positive real root of the following equation using EES:

$$2x^3 - 10x^{0.5} - 3x = -3$$

Solution by EES Software (Copy the following lines and paste on a blank EES screen to verify solution):

$$2*x^3-10*x^{0.5}-3*x = -3$$

Answer: $x = 2.063$ (using an initial guess of $x=2$)

1-108 EES Solve the following system of 2 equations with 2 unknowns using EES:

$$x^3 - y^2 = 7.75$$

$$3xy + y = 3.5$$

Solution by EES Software (Copy the following lines and paste on a blank EES screen to verify solution):

$$x^3-y^2=7.75$$

$$3*x*y+y=3.5$$

Answer: $x = 2, y = 0.5$

1-109 EES Solve the following system of 3 equations with 3 unknowns using EES:

$$2x - y + z = 5$$

$$3x^2 + 2y = z + 2$$

$$xy + 2z = 8$$

Solution by EES Software (Copy the following lines and paste on a blank EES screen to verify solution):

$$2*x-y+z=5$$

$$3*x^2+2*y=z+2$$

$$x*y+2*z=8$$

Answer: $x = 1.141, y = 0.8159, z = 3.535$

1-110 EES Solve the following system of 3 equations with 3 unknowns using EES:

$$x^2y - z = 1$$

$$x - 3y^{0.5} + xz = -2$$

$$x + y - z = 2$$

Solution by EES Software (Copy the following lines and paste on a blank EES screen to verify solution):

$$x^2*y-z=1$$

$$x-3*y^{0.5}+x*z=-2$$

$$x+y-z=2$$

Answer: $x = 1, y = 1, z = 0$

Special Topic: Thermal Comfort

1-111C The metabolism refers to the burning of foods such as carbohydrates, fat, and protein in order to perform the necessary bodily functions. The metabolic rate for an average man ranges from 108 W while reading, writing, typing, or listening to a lecture in a classroom in a seated position to 1250 W at age 20 (730 at age 70) during strenuous exercise. The corresponding rates for women are about 30 percent lower. Maximum metabolic rates of trained athletes can exceed 2000 W. We are interested in metabolic rate of the occupants of a building when we deal with heating and air conditioning because the metabolic rate represents the rate at which a body generates heat and dissipates it to the room. This body heat contributes to the heating in winter, but it adds to the cooling load of the building in summer.

1-112C The metabolic rate is proportional to the size of the body, and the metabolic rate of women, in general, is lower than that of men because of their smaller size. Clothing serves as insulation, and the thicker the clothing, the lower the environmental temperature that feels comfortable.

1-113C Asymmetric thermal radiation is caused by the *cold surfaces* of large windows, uninsulated walls, or cold products on one side, and the *warm surfaces* of gas or electric radiant heating panels on the walls or ceiling, solar heated masonry walls or ceilings on the other. Asymmetric radiation causes discomfort by exposing different sides of the body to surfaces at different temperatures and thus to different rates of heat loss or gain by radiation. A person whose left side is exposed to a cold window, for example, will feel like heat is being drained from that side of his or her body.

1-114C (a) Draft causes undesired local cooling of the human body by exposing parts of the body to high heat transfer coefficients. (b) Direct contact with *cold floor surfaces* causes localized discomfort in the feet by excessive heat loss by conduction, dropping the temperature of the bottom of the feet to uncomfortable levels.

1-115C Stratification is the formation of vertical still air layers in a room at difference temperatures, with highest temperatures occurring near the ceiling. It is likely to occur at places with high ceilings. It causes discomfort by exposing the head and the feet to different temperatures. This effect can be prevented or minimized by using destratification fans (ceiling fans running in reverse).

1-116C It is necessary to ventilate buildings to provide adequate fresh air and to get rid of excess carbon dioxide, contaminants, odors, and humidity. Ventilation increases the energy consumption for heating in winter by replacing the warm indoors air by the colder outdoors air. Ventilation also increases the energy consumption for cooling in summer by replacing the cold indoors air by the warm outdoors air. It is not a good idea to keep the bathroom fans on all the time since they will waste energy by expelling conditioned air (warm in winter and cool in summer) by the unconditioned outdoor air.

Review Problems

1-117 A standing man is subjected to high winds and thus high convection coefficients. The rate of heat loss from this man by convection in still air at 20°C, in windy air, and the wind-chill factor are to be determined.

Assumptions 1 A standing man can be modeled as a 30-cm diameter, 170-cm long vertical cylinder with both the top and bottom surfaces insulated. **2** The exposed surface temperature of the person and the convection heat transfer coefficient is constant and uniform. **3** Heat loss by radiation is negligible.

Analysis The heat transfer surface area of the person is

$$A_s = \pi DL = \pi(0.3 \text{ m})(1.70 \text{ m}) = 1.60 \text{ m}^2$$

The rate of heat loss from this man by convection in still air is

$$Q_{\text{still air}} = hA_s\Delta T = (15 \text{ W/m}^2\cdot\text{C})(1.60 \text{ m}^2)(34 - 20)^\circ\text{C} = \mathbf{336 \text{ W}}$$

In windy air it would be

$$Q_{\text{windy air}} = hA_s\Delta T = (50 \text{ W/m}^2\cdot\text{C})(1.60 \text{ m}^2)(34 - 20)^\circ\text{C} = \mathbf{1120 \text{ W}}$$

To lose heat at this rate in still air, the air temperature must be

$$1120 \text{ W} = (hA_s\Delta T)_{\text{still air}} = (15 \text{ W/m}^2\cdot\text{C})(1.60 \text{ m}^2)(34 - T_{\text{effective}})^\circ\text{C}$$

which gives

$$T_{\text{effective}} = -12.7^\circ\text{C}$$

That is, the windy air at 20°C feels as cold as still air at -12.7°C as a result of the wind-chill effect. Therefore, the wind-chill factor in this case is

$$F_{\text{wind-chill}} = 20 - (-12.7) = \mathbf{32.7^\circ\text{C}}$$



Windy weather

1-118 The backside of the thin metal plate is insulated and the front side is exposed to solar radiation. The surface temperature of the plate is to be determined when it stabilizes.

Assumptions 1 Steady operating conditions exist. **2** Heat transfer through the insulated side of the plate is negligible. **3** The heat transfer coefficient is constant and uniform over the plate. **4** Radiation heat transfer is negligible.

Properties The solar absorptivity of the plate is given to be $\alpha = 0.7$.

Analysis When the heat loss from the plate by convection equals the solar radiation absorbed, the surface temperature of the plate can be determined from

$$\begin{aligned}\dot{Q}_{\text{solarabsorbed}} &= \dot{Q}_{\text{conv}} \\ \alpha \dot{Q}_{\text{solar}} &= hA_s(T_s - T_o) \\ 0.7 \times A \times 550 \text{ W/m}^2 &= (25 \text{ W/m}^2 \cdot ^\circ\text{C})A_s(T_s - 10)\end{aligned}$$

Canceling the surface area A_s and solving for T_s gives

$$T_s = \mathbf{25.4^\circ\text{C}}$$

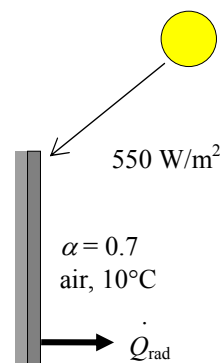

1-119 A room is to be heated by 1 ton of hot water contained in a tank placed in the room. The minimum initial temperature of the water is to be determined if it to meet the heating requirements of this room for a 24-h period.

Assumptions 1 Water is an incompressible substance with constant specific heats. **2** Air is an ideal gas with constant specific heats. **3** The energy stored in the container itself is negligible relative to the energy stored in water. **4** The room is maintained at 20°C at all times. **5** The hot water is to meet the heating requirements of this room for a 24-h period.

Properties The specific heat of water at room temperature is $c = 4.18 \text{ kJ/kg}\cdot^\circ\text{C}$ (Table A-9).

Analysis Heat loss from the room during a 24-h period is

$$Q_{\text{loss}} = (10,000 \text{ kJ/h})(24 \text{ h}) = 240,000 \text{ kJ}$$

Taking the contents of the room, including the water, as our system, the energy balance can be written as

$$\underbrace{E_{\text{in}} - E_{\text{out}}}_{\text{Net energy transfer by heat, work, and mass}} = \underbrace{\Delta E_{\text{system}}}_{\text{Change in internal, kinetic, potential, etc. energies}} \rightarrow -Q_{\text{out}} = \Delta U = (\Delta U)_{\text{water}} + (\Delta U)_{\text{air}} \approx 0$$

or

$$-Q_{\text{out}} = [mc(T_2 - T_1)]_{\text{water}}$$

Substituting,

$$-240,000 \text{ kJ} = (1000 \text{ kg})(4.18 \text{ kJ/kg}\cdot^\circ\text{C})(20 - T_1)$$

It gives

$$T_1 = \mathbf{77.4^\circ\text{C}}$$

where T_1 is the temperature of the water when it is first brought into the room.

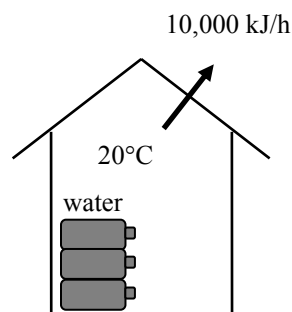

1-120 The base surface of a cubical furnace is surrounded by black surfaces at a specified temperature. The net rate of radiation heat transfer to the base surface from the top and side surfaces is to be determined.

Assumptions **1** Steady operating conditions exist. **2** The top and side surfaces of the furnace closely approximate black surfaces. **3** The properties of the surfaces are constant.

Properties The emissivity of the base surface is $\varepsilon = 0.7$.

Analysis The base surface is completely surrounded by the top and side surfaces. Then using the radiation relation for a surface completely surrounded by another large (or black) surface, the net rate of radiation heat transfer from the top and side surfaces to the base is determined to be

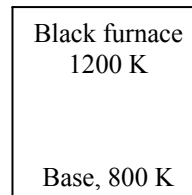

$$\begin{aligned}\dot{Q}_{\text{rad,base}} &= \varepsilon A \sigma (T_{\text{base}}^4 - T_{\text{surr}}^4) \\ &= (0.7)(3 \times 3 \text{ m}^2)(5.67 \times 10^{-8} \text{ W/m}^2 \cdot \text{K}^4)[(1200 \text{ K})^4 - (800 \text{ K})^4] \\ &= 594,400 \text{ W} = \mathbf{594 \text{ kW}}\end{aligned}$$

1-121 A refrigerator consumes 600 W of power when operating, and its motor remains on for 5 min and then off for 15 min periodically. The average thermal conductivity of the refrigerator walls and the annual cost of operating this refrigerator are to be determined.

Assumptions **1** Quasi-steady operating conditions exist. **2** The inner and outer surface temperatures of the refrigerator remain constant.

Analysis The total surface area of the refrigerator where heat transfer takes place is

$$A_{\text{total}} = 2[(1.8 \times 1.2) + (1.8 \times 0.8) + (1.2 \times 0.8)] = 9.12 \text{ m}^2$$

Since the refrigerator has a COP of 1.5, the rate of heat removal from the refrigerated space, which is equal to the rate of heat gain in steady operation, is

$$\dot{Q} = \dot{W}_e \times \text{COP} = (600 \text{ W}) \times 1.5 = 900 \text{ W}$$

But the refrigerator operates a quarter of the time (5 min on, 15 min off). Therefore, the average rate of heat gain is

$$\dot{Q}_{\text{ave}} = \dot{Q} / 4 = (900 \text{ W}) / 4 = 225 \text{ W}$$

Then the thermal conductivity of refrigerator walls is determined to be

$$\dot{Q}_{\text{ave}} = kA \frac{\Delta T_{\text{ave}}}{L} \longrightarrow k = \frac{\dot{Q}_{\text{ave}} L}{A \Delta T_{\text{ave}}} = \frac{(225 \text{ W})(0.03 \text{ m})}{(9.12 \text{ m}^2)(17 - 6)^\circ\text{C}} = \mathbf{0.0673 \text{ W/m} \cdot ^\circ\text{C}}$$

The total number of hours this refrigerator remains on per year is

$$\Delta t = 365 \times 24 / 4 = 2190 \text{ h}$$

Then the total amount of electricity consumed during a one-year period and the annual cost of operating this refrigerator are

$$\begin{aligned}\text{Annual Electricity Usage} &= \dot{W}_e \Delta t = (0.6 \text{ kW})(2190 \text{ h/yr}) = 1314 \text{ kWh/yr} \\ \text{Annual cost} &= (1314 \text{ kWh/yr})(\$0.08 / \text{kWh}) = \mathbf{\$105.1/\text{yr}}\end{aligned}$$

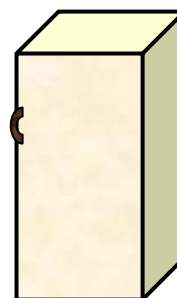

1-122 Engine valves are to be heated in a heat treatment section. The amount of heat transfer, the average rate of heat transfer, the average heat flux, and the number of valves that can be heat treated daily are to be determined.

Assumptions Constant properties given in the problem can be used.

Properties The average specific heat and density of valves are given to be $c_p = 440 \text{ J/kg}\cdot^\circ\text{C}$ and $\rho = 7840 \text{ kg/m}^3$.

Analysis (a) The amount of heat transferred to the valve is simply the change in its internal energy, and is determined from

$$Q = \Delta U = mc_p(T_2 - T_1) \\ = (0.0788 \text{ kg})(0.440 \text{ kJ/kg}\cdot^\circ\text{C})(800 - 40)^\circ\text{C} = \mathbf{26.35 \text{ kJ}}$$

(b) The average rate of heat transfer can be determined from

$$\dot{Q}_{\text{avg}} = \frac{Q}{\Delta t} = \frac{26.35 \text{ kJ}}{5 \times 60 \text{ s}} = 0.0878 \text{ kW} = \mathbf{87.8 \text{ W}}$$

(c) The average heat flux is determined from

$$\dot{q}_{\text{ave}} = \frac{\dot{Q}_{\text{avg}}}{A_s} = \frac{\dot{Q}_{\text{avg}}}{2\pi DL} = \frac{87.8 \text{ W}}{2\pi(0.008 \text{ m})(0.1 \text{ m})} = \mathbf{1.75 \times 10^4 \text{ W/m}^2}$$

(d) The number of valves that can be heat treated daily is

$$\text{Number of valves} = \frac{(10 \times 60 \text{ min})(25 \text{ valves})}{5 \text{ min}} = \mathbf{3000 \text{ valves}}$$

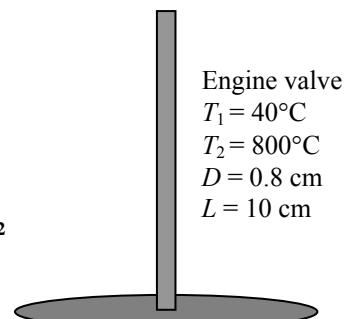

1-123 The glass cover of a flat plate solar collector with specified inner and outer surface temperatures is considered. The fraction of heat lost from the glass cover by radiation is to be determined.

Assumptions 1 Steady operating conditions exist since the surface temperatures of the glass remain constant at the specified values. 2 Thermal properties of the glass are constant.

Properties The thermal conductivity of the glass is given to be $k = 0.7 \text{ W/m}\cdot^\circ\text{C}$.

Analysis Under steady conditions, the rate of heat transfer through the glass by conduction is

$$\dot{Q}_{\text{cond}} = kA \frac{\Delta T}{L} = (0.7 \text{ W/m}\cdot^\circ\text{C})(2.5 \text{ m}^2) \frac{(28 - 25)^\circ\text{C}}{0.006 \text{ m}} = 875 \text{ W}$$

The rate of heat transfer from the glass by convection is

$$\dot{Q}_{\text{conv}} = hA\Delta T = (10 \text{ W/m}^2\cdot^\circ\text{C})(2.5 \text{ m}^2)(25 - 15)^\circ\text{C} = 250 \text{ W}$$

Under steady conditions, the heat transferred through the cover by conduction should be transferred from the outer surface by convection and radiation. That is,

$$\dot{Q}_{\text{rad}} = \dot{Q}_{\text{cond}} - \dot{Q}_{\text{conv}} = 875 - 250 = 625 \text{ W}$$

Then the fraction of heat transferred by radiation becomes

$$f = \frac{\dot{Q}_{\text{rad}}}{\dot{Q}_{\text{cond}}} = \frac{625}{875} = \mathbf{0.714} \quad (\text{or } 71.4\%)$$

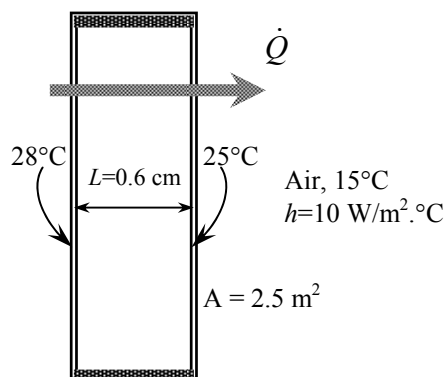

1-124 The range of U-factors for windows are given. The range for the rate of heat loss through the window of a house is to be determined.

Assumptions **1** Steady operating conditions exist. **2** Heat losses associated with the infiltration of air through the cracks/openings are not considered.

Analysis The rate of heat transfer through the window can be determined from

$$\dot{Q}_{\text{window}} = U_{\text{overall}} A_{\text{window}} (T_i - T_o)$$

where T_i and T_o are the indoor and outdoor air temperatures, respectively, U_{overall} is the U-factor (the overall heat transfer coefficient) of the window, and A_{window} is the window area. Substituting,

Maximum heat loss: $\dot{Q}_{\text{window, max}} = (6.25 \text{ W/m}^2 \cdot ^\circ\text{C})(1.2 \times 1.8 \text{ m}^2)[20 - (-8)]^\circ\text{C} = \mathbf{378 \text{ W}}$

Minimum heat loss: $\dot{Q}_{\text{window, min}} = (1.25 \text{ W/m}^2 \cdot ^\circ\text{C})(1.2 \times 1.8 \text{ m}^2)[20 - (-8)]^\circ\text{C} = \mathbf{76 \text{ W}}$

Discussion Note that the rate of heat loss through windows of identical size may differ by a factor of 5, depending on how the windows are constructed.

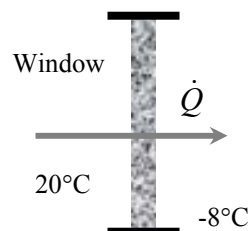

1-125 EES Prob. 1-124 is reconsidered. The rate of heat loss through the window as a function of the U -factor is to be plotted.

Analysis The problem is solved using EES, and the solution is given below.

"GIVEN"

$$A=1.2*1.8 \text{ [m}^2\text{]}$$

$$T_1=20 \text{ [C]}$$

$$T_2=-8 \text{ [C]}$$

$$U=1.25 \text{ [W/m}^2\text{-C]}$$

"ANALYSIS"

$$\dot{Q}_{\text{window}}=U*A*(T_1-T_2)$$

U [W/m ² .C]	Q _{window} [W]
1.25	75.6
1.75	105.8
2.25	136.1
2.75	166.3
3.25	196.6
3.75	226.8
4.25	257
4.75	287.3
5.25	317.5
5.75	347.8
6.25	378

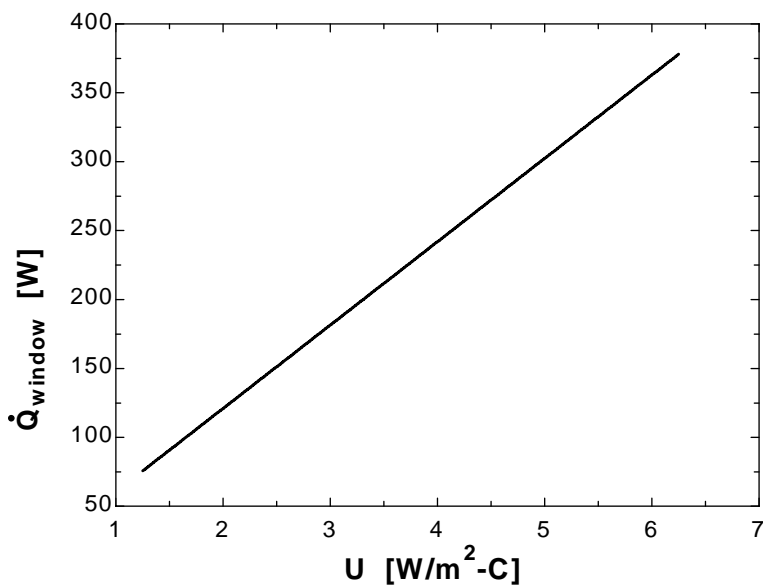

1-126 The windows of a house in Atlanta are of double door type with wood frames and metal spacers. The average rate of heat loss through the windows in winter is to be determined.

Assumptions 1 Steady operating conditions exist. 2 Heat losses associated with the infiltration of air through the cracks/openings are not considered.

Analysis The rate of heat transfer through the window can be determined from

$$\dot{Q}_{\text{window, avg}} = U_{\text{overall}} A_{\text{window}} (T_i - T_o)$$

where T_i and T_o are the indoor and outdoor air temperatures, respectively, U_{overall} is the U -factor (the overall heat transfer coefficient) of the window, and A_{window} is the window area. Substituting,

$$\dot{Q}_{\text{window, avg}} = (2.50 \text{ W/m}^2 \cdot ^\circ\text{C})(20 \text{ m}^2)(22 - 11.3)^\circ\text{C} = \mathbf{535 \text{ W}}$$

Discussion This is the “average” rate of heat transfer through the window in winter in the absence of any infiltration.

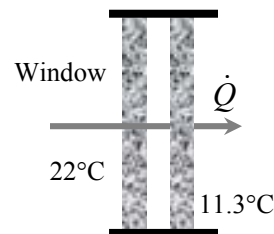

1-127 Boiling experiments are conducted by heating water at 1 atm pressure with an electric resistance wire, and measuring the power consumed by the wire as well as temperatures. The boiling heat transfer coefficient is to be determined.

Assumptions 1 Steady operating conditions exist. 2 Heat losses from the water container are negligible.

Analysis The heat transfer area of the heater wire is

$$A = \pi DL = \pi(0.002 \text{ m})(0.50 \text{ m}) = 0.003142 \text{ m}^2$$

Noting that 4100 W of electric power is consumed when the heater surface temperature is 130°C, the boiling heat transfer coefficient is determined from Newton's law of cooling $\dot{Q} = hA(T_s - T_{\text{sat}})$ to be

$$h = \frac{\dot{Q}}{A(T_s - T_{\text{sat}})} = \frac{4100 \text{ W}}{(0.003142 \text{ m}^2)(130 - 100)^\circ\text{C}} = \mathbf{43,500 \text{ W/m}^2 \cdot ^\circ\text{C}}$$

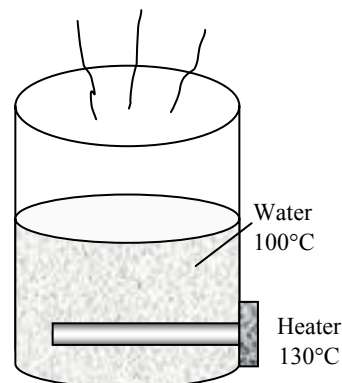

1-128 An electric heater placed in a room consumes 500 W power when its surfaces are at 120°C. The surface temperature when the heater consumes 700 W is to be determined without and with the consideration of radiation.

Assumptions 1 Steady operating conditions exist. 2 The temperature is uniform over the surface.

Analysis (a) Neglecting radiation, the convection heat transfer coefficient is determined from

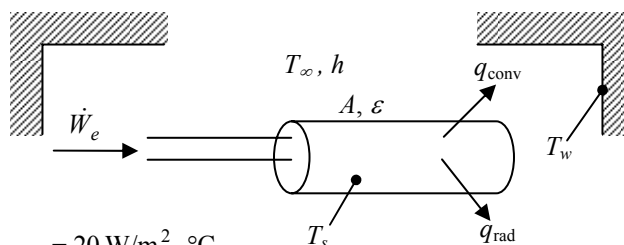

$$h = \frac{\dot{Q}}{A(T_s - T_\infty)} = \frac{500 \text{ W}}{(0.25 \text{ m}^2)(120 - 20)^\circ\text{C}} = 20 \text{ W/m}^2 \cdot ^\circ\text{C}$$

The surface temperature when the heater consumes 700 W is

$$T_s = T_\infty + \frac{\dot{Q}}{hA} = 20^\circ\text{C} + \frac{700 \text{ W}}{(20 \text{ W/m}^2 \cdot ^\circ\text{C})(0.25 \text{ m}^2)} = \mathbf{160^\circ\text{C}}$$

(b) Considering radiation, the convection heat transfer coefficient is determined from

$$\begin{aligned} h &= \frac{\dot{Q} - \varepsilon A \sigma (T_s^4 - T_{\text{surr}}^4)}{A(T_s - T_\infty)} \\ &= \frac{500 \text{ W} - (0.75)(0.25 \text{ m}^2)(5.67 \times 10^{-8} \text{ W/m}^2 \cdot \text{K}^4)[(393 \text{ K})^4 - (283 \text{ K})^4]}{(0.25 \text{ m}^2)(120 - 20)^\circ\text{C}} = 12.58 \text{ W/m}^2 \cdot ^\circ\text{C} \end{aligned}$$

Then the surface temperature becomes

$$\begin{aligned} \dot{Q} &= hA(T_s - T_\infty) + \varepsilon A \sigma (T_s^4 - T_{\text{surr}}^4) \\ 700 &= (12.58)(0.25)(T_s - 293) + (0.75)(0.25)(5.67 \times 10^{-8})[T_s^4 - (283 \text{ K})^4] \\ T_s &= 425.9 \text{ K} = \mathbf{152.9^\circ\text{C}} \end{aligned}$$

Discussion Neglecting radiation changed T_s by more than 7°C, so assumption is not correct in this case.

1-129 An ice skating rink is located in a room is considered. The refrigeration load of the system and the time it takes to melt 3 mm of ice are to be determined.

Assumptions **1** Steady operating conditions exist in part (a). **2** The surface is insulated on the back side in part (b).

Properties The heat of fusion and the density of ice are given to be 333.7 kJ/kg and 920 kg/m³, respectively.

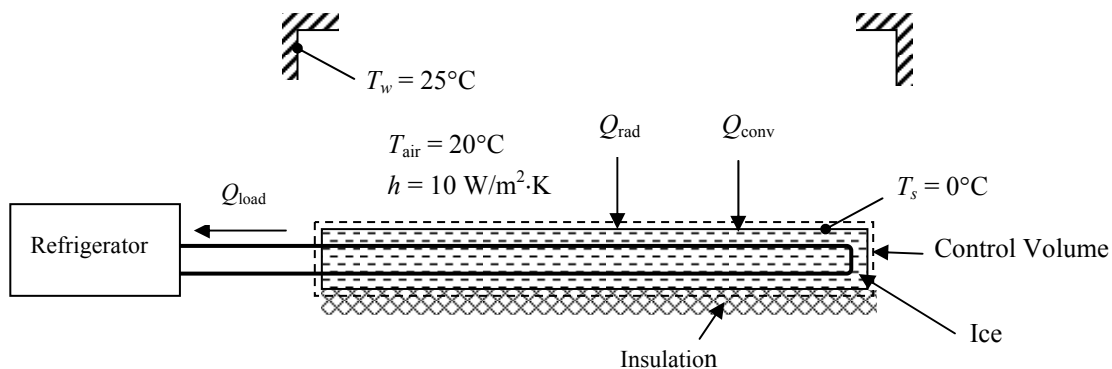

Analysis (a) The refrigeration load is determined from

$$\begin{aligned}\dot{Q}_{\text{load}} &= hA(T_{\text{air}} - T_s) + \varepsilon A\sigma(T_w^4 - T_s^4) \\ &= (10)(40 \times 12)(20 - 0) + (0.95)(40 \times 12)(5.67 \times 10^{-8})[298^4 - 273^4] = \mathbf{156,300 \text{ W}}\end{aligned}$$

(b) The time it takes to melt 3 mm of ice is determined from

$$t = \frac{LW\delta\rho h_{if}}{\dot{Q}_{\text{load}}} = \frac{(40 \times 12 \text{ m}^2)(0.003 \text{ m})(920 \text{ kg/m}^3)(333.7 \times 10^3 \text{ J/kg})}{156,300 \text{ J/s}} = 2831 \text{ s} = \mathbf{47.2 \text{ min}}$$

Fundamentals of Engineering (FE) Exam Problems

1-130 Which equation below is used to determine the heat flux for conduction?

- (a) $-kA \frac{dT}{dx}$ (b) $-k \text{ grad}T$ (c) $h(T_2 - T_1)$ (d) $\varepsilon\sigma T^4$ (e) None of them

Answer (b) $-k \text{ grad}T$

1-131 Which equation below is used to determine the heat flux for convection?

- (a) $-kA \frac{dT}{dx}$ (b) $-k \text{ grad}T$ (c) $h(T_2 - T_1)$ (d) $\varepsilon\sigma T^4$ (e) None of them

Answer (c) $h(T_2 - T_1)$

1-132 Which equation below is used to determine the heat flux emitted by thermal radiation from a surface?

- (a) $-kA \frac{dT}{dx}$ (b) $-k \text{ grad}T$ (c) $h(T_2 - T_1)$ (d) $\varepsilon\sigma T^4$ (e) None of them

Answer (d) $\varepsilon\sigma T^4$

1-133 A 1-kW electric resistance heater in a room is turned on and kept on for 50 minutes. The amount of energy transferred to the room by the heater is

- (a) 1 kJ (b) 50 kJ (c) 3000 kJ (d) 3600 kJ (e) 6000 kJ

Answer (c) 3000 kJ

Solution Solved by EES Software. Solutions can be verified by copying-and-pasting the following lines on a blank EES screen.

```
We= 1 [kJ/s]
time=50*60 [s]
We_total=We*time [kJ]
```

"Wrong Solutions:"

```
W1_Etotal=We*time/60 "using minutes instead of s"
W2_Etotal=We "ignoring time"
```

1-134 A hot 16 cm × 16 cm × 16 cm cubical iron block is cooled at an average rate of 80 W. The heat flux is

- (a) 195 W/m² (b) 521 W/m² (c) 3125 W/m² (d) 7100 W/m² (e) 19,500 W/m²

Answer (b) 521 W/m²

Solution Solved by EES Software. Solutions can be verified by copying-and-pasting the following lines on a blank EES screen.

```
a=0.16 [m]
Q_dot=80 [W]
A_s=6*a^2
q=Q_dot/A_s
```

"Some Wrong Solutions with Common Mistakes"

```
W1_q=Q_dot/a^2 "Using wrong equation for area"
W2_q=Q_dot/a^3 "Using volume instead of area"
```

1-135 A 2-kW electric resistance heater submerged in 30-kg water is turned on and kept on for 10 min. During the process, 500 kJ of heat is lost from the water. The temperature rise of water is

- (a) 5.6°C (b) 9.6°C (c) 13.6°C (d) 23.3°C (e) 42.5°C

Answer (a) 5.6°C

Solution Solved by EES Software. Solutions can be verified by copying-and-pasting the following lines on a blank EES screen.

```
C=4.18 [kJ/kg-K]
m=30 [kg]
Q_loss=500 [kJ]
time=10*60 [s]
W_e=2 [kJ/s]
```

"Applying energy balance $E_{in}-E_{out}=dE_{system}$ gives"

```
time*W_e-Q_loss = dU_system
dU_system=m*C*DELTAT
```

"Some Wrong Solutions with Common Mistakes:"

```
time*W_e = m*C*W1_T "Ignoring heat loss"
time*W_e+Q_loss = m*C*W2_T "Adding heat loss instead of subtracting"
time*W_e-Q_loss = m*1.0*W3_T "Using specific heat of air or not using specific heat"
```

1-136 Eggs with a mass of 0.15 kg per egg and a specific heat of 3.32 kJ/kg·°C are cooled from 32°C to 10°C at a rate of 300 eggs per minute. The rate of heat removal from the eggs is

- (a) 11 kW (b) 80 kW (c) 25 kW (d) 657 kW (e) 55 kW

Answer (e) 55 kW

Solution Solved by EES Software. Solutions can be verified by copying-and-pasting the following lines on a blank EES screen.

```
C=3.32 [kJ/kg-K]
m_egg=0.15 [kg]
T1=32 [C]
T2=10 [C]
n=300 "eggs/min"
m=n*m_egg/60 "kg/s"
```

```
"Applying energy balance E_in-E_out=dE_system gives"
"-E_out = dU_system"
Qout=m*C*(T1-T2) "kJ/s"
```

```
"Some Wrong Solutions with Common Mistakes:"
W1_Qout = m*C*T1 "Using T1 only"
W2_Qout = m_egg*C*(T1-T2) "Using one egg only"
W3_Qout = m*C*T2 "Using T2 only"
W4_Qout=m_egg*C*(T1-T2)*60 "Finding kJ/min"
```

1-137 Steel balls at 140°C with a specific heat of 0.50 kJ/kg·°C are quenched in an oil bath to an average temperature of 85°C at a rate of 35 balls per minute. If the average mass of steel balls is 1.2 kg, the rate of heat transfer from the balls to the oil is

- (a) 33 kJ/s (b) 1980 kJ/s (c) 49 kJ/s (d) 30 kJ/s (e) 19 kJ/s

Answer (e) 19 kJ/s

Solution Solved by EES Software. Solutions can be verified by copying-and-pasting the following lines on a blank EES screen.

```
c=0.50 [kJ/kg-K]
m1=1.2 [kg]
T1=140 [C]
T2=85 [C]
n=35 "balls/min"
m=n*m1/60 "kg/s"
```

```
"Applying energy balance E_in-E_out=dE_system gives"
"-E_out = dU_system"
Qout=m*c*(T1-T2) "kJ/s"
```

```
"Some Wrong Solutions with Common Mistakes:"
W1_Qout = m*c*T1 "Using T1 only"
W2_Qout = m1*c*(T1-T2) "Using one egg only"
W3_Qout = m*c*T2 "Using T2 only"
W4_Qout=m1*c*(T1-T2)*60 "Finding kJ/min"
```

1-138 A cold bottled drink ($m = 2.5$ kg, $C_p = 4200$ J/kg·°C) at 5°C is left on a table in a room. The average temperature of the drink is observed to rise to 15°C in 30 minutes. The average rate of heat transfer to the drink is

- (a) 23 W (b) 29 W (c) 58 W (d) 88 W (e) 122 W

Answer: 58 W

Solution Solved by EES Software. Solutions can be verified by copying-and-pasting the following lines on a blank EES screen.

```
c=4200 [J/kg-K]
m=2.5 [kg]
T1=5 [C]
T2=15 [C]
time = 30*60 [s]
"Applying energy balance E_in-E_out=dE_system gives"
Q=m*c*(T2-T1)
Qave=Q/time
```

"Some Wrong Solutions with Common Mistakes:"

```
W1_Qave = m*c*T1/time "Using T1 only"
W2_Qave = c*(T2-T1)/time "Not using mass"
W3_Qave = m*c*T2/time "Using T2 only"
```

1-139 Water enters a pipe at 20°C at a rate of 0.25 kg/s and is heated to 60°C. The rate of heat transfer to the water is

- (a) 10 kW (b) 20.9 kW (c) 41.8 kW (d) 62.7 kW (e) 167.2 kW

Answer (c) 41.8 kW

Solution Solved by EES Software. Solutions can be verified by copying-and-pasting the following lines on a blank EES screen.

```
T_in=20 [C]
T_out=60 [C]
m_dot=0.25 [kg/s]
c_p=4.18 [kJ/kg-C]
Q_dot=m_dot*c_p*(T_out-T_in)
```

"Some Wrong Solutions with Common Mistakes"

```
W1_Q_dot=m_dot*(T_out-T_in) "Not using specific heat"
W2_Q_dot=c_p*(T_out-T_in) "Not using mass flow rate"
W3_Q_dot=m_dot*c_p*T_out "Using exit temperature instead of temperature change"
```

1-140 Air enters a 12-m-long, 7-cm-diameter pipe at 50°C at a rate of 0.06 kg/s. The air is cooled at an average rate of 400 W per m² surface area of the pipe. The air temperature at the exit of the pipe is

- (a) 4.3°C (b) 17.5°C (c) 32.5°C (d) 43.4°C (e) 45.8°C

Answer (c) 32.5°C

Solution Solved by EES Software. Solutions can be verified by copying-and-pasting the following lines on a blank EES screen.

```
L=12 [m]
D=0.07 [m]
T1=50 [C]
m_dot=0.06 [kg/s]
q=400 [W/m^2]
```

```
A=pi*D*L
Q_dot=q*A
c_p=1007 [J/kg-C] "Table A-15"
Q_dot=m_dot*c_p*(T1-T2)
```

"Some Wrong Solutions with Common Mistakes"

```
q=m_dot*c_p*(T1-W1_T2) "Using heat flux, q instead of rate of heat transfer, Q_dot"
Q_dot=m_dot*4180*(T1-W2_T2) "Using specific heat of water"
Q_dot=m_dot*c_p*W3_T2 "Using exit temperature instead of temperature change"
```

1-141 Heat is lost steadily through a 0.5-cm thick 2 m × 3 m window glass whose thermal conductivity is 0.7 W/m·°C. The inner and outer surface temperatures of the glass are measured to be 12°C to 9°C. The rate of heat loss by conduction through the glass is

- (a) 420 W (b) 5040 W (c) 17,600 W (d) 1256 W (e) 2520 W

Answer (e) 2520 W

Solution Solved by EES Software. Solutions can be verified by copying-and-pasting the following lines on a blank EES screen.

```
A=3*2 [m^2]
L=0.005 [m]
T1=12 [C]
T2=9 [C]
k=0.7 [W/m-C]
Q=k*A*(T1-T2)/L
```

"Some Wrong Solutions with Common Mistakes:"

```
W1_Q=k*(T1-T2)/L "Not using area"
W2_Q=k*2*A*(T1-T2)/L "Using areas of both surfaces"
W3_Q=k*A*(T1+T2)/L "Adding temperatures instead of subtracting"
W4_Q=k*A*L*(T1-T2) "Multiplying by thickness instead of dividing by it"
```

1-142 The East wall of an electrically heated house is 6 m long, 3 m high, and 0.35 m thick, and it has an effective thermal conductivity of 0.7 W/m·°C. If the inner and outer surface temperatures of wall are 15°C and 6°C, the rate of heat loss through the wall is

- (a) 324 W (b) 40 W (c) 756 W (d) 648 W (e) 1390 W

Answer (a) 324 W

Solution Solved by EES Software. Solutions can be verified by copying-and-pasting the following lines on a blank EES screen.

```
A=3*6 [m^2]
L=0.35 [m]
k=0.7 [W/m-C]
T1=15 [C]
T2=6 [C]
Q_cond=k*A*(T1-T2)/L
```

"Wrong Solutions:"

```
W1_Q=k*(T1-T2)/L "Not using area"
W2_Q=k*2*A*(T1-T2)/L "Using areas of both surfaces"
W3_Q=k*A*(T1+T2)/L "Adding temperatures instead of subtracting"
W4_Q=k*A*L*(T1-T2) "Multiplying by thickness instead of dividing by it"
```

1-143 Steady heat conduction occurs through a 0.3-m thick 9 m by 3 m composite wall at a rate of 1.2 kW. If the inner and outer surface temperatures of the wall are 15°C and 7°C, the effective thermal conductivity of the wall is

- (a) 0.61 W/m·°C (b) 0.83 W/m·°C (c) 1.7 W/m·°C (d) 2.2 W/m·°C (e) 5.1 W/m·°C

Answer (c) 1.7 W/m·°C

Solution Solved by EES Software. Solutions can be verified by copying-and-pasting the following lines on a blank EES screen.

```
A=9*3 [m^2]
L=0.3 [m]
T1=15 [C]
T2=7 [C]
Q=1200 [W]
Q=k*A*(T1-T2)/L
```

"Wrong Solutions:"

```
Q=W1_k*(T1-T2)/L "Not using area"
Q=W2_k*2*A*(T1-T2)/L "Using areas of both surfaces"
Q=W3_k*A*(T1+T2)/L "Adding temperatures instead of subtracting"
Q=W4_k*A*L*(T1-T2) "Multiplying by thickness instead of dividing by it"
```

1-144 Heat is lost through a brick wall ($k = 0.72 \text{ W/m}\cdot\text{C}$), which is 4 m long, 3 m wide, and 25 cm thick at a rate of 500 W. If the inner surface of the wall is at 22°C , the temperature at the midplane of the wall is

- (a) 0°C (b) 7.5°C (c) 11.0°C (d) 14.8°C (e) 22°C

Answer (d) 14.8°C

Solution Solved by EES Software. Solutions can be verified by copying-and-pasting the following lines on a blank EES screen.

```
k=0.72 [W/m-C]
Length=4 [m]
Width=3 [m]
L=0.25 [m]
Q_dot=500 [W]
T1=22 [C]
```

```
A=Length*Width
Q_dot=k*A*(T1-T_middle)/(0.5*L)
```

"Some Wrong Solutions with Common Mistakes"

```
Q_dot=k*A*(T1-W1_T_middle)/L "Using L instead of 0.5L"
W2_T_middle=T1/2 "Just taking the half of the given temperature"
```

1-145 Consider two different materials, A and B. The ratio of thermal conductivities is $k_A/k_B = 13$, the ratio of the densities is $\rho_A/\rho_B = 0.045$, and the ratio of specific heats is $c_{p,A}/c_{p,B} = 16.9$. The ratio of the thermal diffusivities α_A/α_B is

- (a) 4882 (b) 17.1 (c) 0.06 (d) 0.1 (e) 0.03

Answer (b) 17.1

Solution Solved by EES Software. Solutions can be verified by copying-and-pasting the following lines on a blank EES screen.

```
k_A\k_B=13
rho_A\rho_B=0.045
c_p_A\c_p_B=16.9
```

```
"From the definition of thermal diffusivity, alpha = k/(rho*c-p)"
alpha_A\alpha_B=k_A\k_B*(1/rho_A\rho_B)*(1/c_p_A\c_p_B)
```

"Some Wrong Solutions with Common Mistakes"

```
W1_alpha_A\alpha_B=k_A\k_B*rho_A\rho_B*(1/c_p_A\c_p_B) "Not inverting density ratio"
W2_alpha_A\alpha_B=k_A\k_B*(1/rho_A\rho_B)*c_p_A\c_p_B "Not inverting specific heat ratio"
W3_alpha_A\alpha_B=1/(k_A\k_B)*(1/rho_A\rho_B)*(1/c_p_A\c_p_B) "Inverting conductivity ratio"
W4_alpha_A\alpha_B=1/(k_A\k_B*(1/rho_A\rho_B)*(1/c_p_A\c_p_B)) "Taking the inverse of result"
```

1-146 A 10-cm high and 20-cm wide circuit board houses on its surface 100 closely spaced chips, each generating heat at a rate of 0.08 W and transferring it by convection and radiation to the surrounding medium at 40°C. Heat transfer from the back surface of the board is negligible. If the combined convection and radiation heat transfer coefficient on the surface of the board is 22 W/m²·°C, the average surface temperature of the chips is

- (a) 72.4°C (b) 66.5°C (c) 40.4°C (d) 58.2°C (e) 49.1°C

Answer (d) 58.2°C

Solution Solved by EES Software. Solutions can be verified by copying-and-pasting the following lines on a blank EES screen.

```
A=0.1*0.2 [m^2]
Q= 100*0.08 [W]
Tair=40 [C]
h=22 [W/m^2-C]
Q= h*A*(Ts-Tair)
```

"Wrong Solutions:"

```
Q= h*(W1_Ts-Tair) "Not using area"
Q= h*2*A*(W2_Ts-Tair) "Using both sides of surfaces"
Q= h*A*(W3_Ts+Tair) "Adding temperatures instead of subtracting"
Q/100= h*A*(W4_Ts-Tair) "Considering 1 chip only"
```

1-147 A 40-cm-long, 0.4-cm-diameter electric resistance wire submerged in water is used to determine the convection heat transfer coefficient in water during boiling at 1 atm pressure. The surface temperature of the wire is measured to be 114°C when a wattmeter indicates the electric power consumption to be 7.6 kW. The heat transfer coefficient is

- (a) 108 kW/m²·°C (b) 13.3 kW/m²·°C (c) 68.1 kW/m²·°C (d) 0.76 kW/m²·°C
(e) 256 kW/m²·°C

Answer (a) 108 kW/m²·°C

Solution Solved by EES Software. Solutions can be verified by copying-and-pasting the following lines on a blank EES screen.

```
L=0.4 [m]
D=0.004 [m]
A=pi*D*L [m^2]
We=7.6 [kW]
Ts=114 [C]
Tf=100 [C] "Boiling temperature of water at 1 atm"
We= h*A*(Ts-Tf)
```

"Wrong Solutions:"

```
We= W1_h*(Ts-Tf) "Not using area"
We= W2_h*(L*pi*D^2/4)*(Ts-Tf) "Using volume instead of area"
We= W3_h*A*Ts "Using Ts instead of temp difference"
```

1-148 A 10 cm × 12 cm × 14 cm rectangular prism object made of hardwood ($\rho = 721 \text{ kg/m}^3$, $c_p = 1.26 \text{ kJ/kg}\cdot^\circ\text{C}$) is cooled from 100°C to the room temperature of 20°C in 54 minutes. The approximate heat transfer coefficient during this process is

- (a) 0.47 W/m²·°C (b) 5.5 W/m²·°C (c) 8 W/m²·°C (d) 11 W/m²·°C (e) 17,830 W/m²·°C

Answer (d) 11 W/m²·°C

Solution Solved by EES Software. Solutions can be verified by copying-and-pasting the following lines on a blank EES screen.

```
a=0.10 [m]
b=0.12 [m]
c=0.14 [m]
rho=721 [kg/m^3]
c_p=1260 [J/kg-C]
T1=100 [C]
T2=20 [C]
time=54*60 [s]
V=a*b*c
m=rho*V
Q=m*c_p*(T1-T2)
Q_dot=Q/time
T_ave=1/2*(T1+T2)
T_infinity=T2
A_s=2*a*b+2*a*c+2*b*c
Q_dot=h*A_s*(T_ave-T_infinity)
```

"Some Wrong Solutions with Common Mistakes"

$Q_dot=W1_h*A_s*(T1-T2)$ "Using T1 instead of T_ave"

$Q_dot=W2_h*(T1-T2)$ "Not using A"

$Q=W3_h*A_s*(T1-T2)$ "Using Q instead of Q_dot "

1-149 A 30-cm diameter black ball at 120°C is suspended in air, and is losing heat to the surrounding air at 25°C by convection with a heat transfer coefficient of 12 W/m²·°C, and by radiation to the surrounding surfaces at 15°C. The total rate of heat transfer from the black ball is

- (a) 322 W (b) 595 W (c) 234 W (d) 472 W (e) 2100 W

Answer: 595 W

Solution Solved by EES Software. Solutions can be verified by copying-and-pasting the following lines on a blank EES screen.

```
sigma=5.67E-8 [W/m^2-K^4]
eps=1
D=0.3 [m]
A=pi*D^2
h_conv=12 [W/m^2-C]
Ts=120 [C]
Tf=25 [C]
Tsur=15 [C]
Q_conv=h_conv*A*(Ts-Tf)
Q_rad=eps*sigma*A*((Ts+273)^4-(Tsur+273)^4)
Q_total=Q_conv+Q_rad
```

"Wrong Solutions:"

W1_Ql=Q_conv "Ignoring radiation"

W2_Q=Q_rad "ignoring convection"

W3_Q=Q_conv+eps*sigma*A*(Ts^4-Tsur^4) "Using C in radiation calculations"

W4_Q=Q_total/A "not using area"

1-150 A 3-m² black surface at 140°C is losing heat to the surrounding air at 35°C by convection with a heat transfer coefficient of 16 W/m²·°C, and by radiation to the surrounding surfaces at 15°C. The total rate of heat loss from the surface is

- (a) 5105 W (b) 2940 W (c) 3779 W (d) 8819 W (e) 5040 W

Answer: (d) 8819 W

Solution Solved by EES Software. Solutions can be verified by copying-and-pasting the following lines on a blank EES screen.

```
sigma=5.67E-8 [W/m^2-K^4]
eps=1
A=3 [m^2]
h_conv=16 [W/m^2-C]
Ts=140 [C]
Tf=35 [C]
Tsur=15 [C]
Q_conv=h_conv*A*(Ts-Tf)
Q_rad=eps*sigma*A*((Ts+273)^4-(Tsur+273)^4)
Q_total=Q_conv+Q_rad
```

"Some Wrong Solutions with Common Mistakes:"

W1_Ql=Q_conv "Ignoring radiation"

W2_Q=Q_rad "ignoring convection"

W3_Q=Q_conv+eps*sigma*A*(Ts^4-Tsur^4) "Using C in radiation calculations"

W4_Q=Q_total/A "not using area"

1-151 A person's head can be approximated as a 25-cm diameter sphere at 35°C with an emissivity of 0.95. Heat is lost from the head to the surrounding air at 25°C by convection with a heat transfer coefficient of 11 W/m²·°C, and by radiation to the surrounding surfaces at 10°C. Disregarding the neck, determine the total rate of heat loss from the head.

- (a) 22 W (b) 27 W (c) 49 W (d) 172 W (e) 249 W

Answer: 49 W

Solution Solved by EES Software. Solutions can be verified by copying-and-pasting the following lines on a blank EES screen.

```
sigma=5.67E-8 [W/m^2-K^4]
eps=0.95
D=0.25 [m]
A=pi*D^2
h_conv=11 [W/m^2-C]
Ts=35 [C]
Tf=25 [C]
Tsurr=10 [C]
Q_conv=h_conv*A*(Ts-Tf)
Q_rad=eps*sigma*A*((Ts+273)^4-(Tsurr+273)^4)
Q_total=Q_conv+Q_rad
"Wrong Solutions:"
W1_Ql=Q_conv "Ignoring radiation"
W2_Q=Q_rad "ignoring convection"
W3_Q=Q_conv+eps*sigma*A*(Ts^4-Tsurr^4) "Using C in radiation calculations"
W4_Q=Q_total/A "not using area"
```

1-152 A 30-cm-long, 0.5-cm-diameter electric resistance wire is used to determine the convection heat transfer coefficient in air at 25°C experimentally. The surface temperature of the wire is measured to be 230°C when the electric power consumption is 180 W. If the radiation heat loss from the wire is calculated to be 60 W, the convection heat transfer coefficient is

- (a) 186 W/m²·°C (b) 158 W/m²·°C (c) 124 W/m²·°C (d) 248 W/m²·°C (e) 390 W/m²·°C

Answer (c) 124 W/m²·°C

Solution Solved by EES Software. Solutions can be verified by copying-and-pasting the following lines on a blank EES screen.

```
L=0.3 [m]
D=0.005 [m]
A=pi*D*L
We=180 [W]
Ts=230 [C]
Tf=25 [C]
Qrad = 60
We- Qrad = h*A*(Ts-Tf)
"Some Wrong Solutions with Common Mistakes:"
We- Qrad = W1_h*(Ts-Tf) "Not using area"
We- Qrad = W2_h*(L*D)*(Ts-Tf) "Using D*L for area"
We+ Qrad = W3_h*A*(Ts-Tf) "Adding Q_rad instead of subtracting"
We= W4_h*A*(Ts-Tf) "Disregarding Q_rad"
```

1-153 A room is heated by a 1.2 kW electric resistance heater whose wires have a diameter of 4 mm and a total length of 3.4 m. The air in the room is at 23°C and the interior surfaces of the room are at 17°C. The convection heat transfer coefficient on the surface of the wires is 8 W/m²·°C. If the rates of heat transfer from the wires to the room by convection and by radiation are equal, the surface temperature of the wires is

- (a) 3534°C (b) 1778°C (c) 1772°C (d) 98°C (e) 25°C

Answer (b) 1778°C

Solution Solved by EES Software. Solutions can be verified by copying-and-pasting the following lines on a blank EES screen.

```
D=0.004 [m]
L=3.4 [m]
W_dot_e=1200 [W]
T_infinity=23 [C]
T_surr=17 [C]
h=8 [W/m^2-C]
```

```
A=pi*D*L
Q_dot_conv=W_dot_e/2
Q_dot_conv=h*A*(T_s-T_infinity)
```

"Some Wrong Solutions with Common Mistakes"

```
Q_dot_conv=h*A*(W1_T_s-T_surr) "Using T_surr instead of T_infinity"
Q_dot_conv/1000=h*A*(W2_T_s-T_infinity) "Using kW unit for the rate of heat transfer"
Q_dot_conv=h*(W3_T_s-T_infinity) "Not using surface area of the wires"
W_dot_e=h*A*(W4_T_s-T_infinity) "Using total heat transfer"
```

1-154 A person standing in a room loses heat to the air in the room by convection and to the surrounding surfaces by radiation. Both the air in the room and the surrounding surfaces are at 20°C. The exposed surfaces of the person is 1.5 m² and has an average temperature of 32°C, and an emissivity of 0.90. If the rates of heat transfer from the person by convection and by radiation are equal, the combined heat transfer coefficient is

- (a) 0.008 W/m²·°C (b) 3.0 W/m²·°C (c) 5.5 W/m²·°C (d) 8.3 W/m²·°C (e) 10.9 W/m²·°C

Answer (e) 10.9 W/m²·°C

Solution Solved by EES Software. Solutions can be verified by copying-and-pasting the following lines on a blank EES screen.

```
T_infinity=20 [C]
T_surr=20 [C]
T_s=32 [C]
A=1.5 [m^2]
epsilon=0.90
```

```
sigma=5.67E-8 [W/m^2-K^4]
Q_dot_rad=epsilon*A*sigma*((T_s+273)^4-(T_surr+273)^4)
Q_dot_total=2*Q_dot_rad
Q_dot_total=h_combined*A*(T_s-T_infinity)
```

"Some Wrong Solutions with Common Mistakes"

Q_dot_rad=W1_h_combined*A*(T_s-T_infinity) "Using radiation heat transfer instead of total heat transfer"

Q_dot_rad_1=epsilon*A*sigma*(T_s^4-T_surr^4) "Using C unit for temperature in radiation calculation"

2*Q_dot_rad_1=W2_h_combined*A*(T_s-T_infinity)

1-155 While driving down a highway early in the evening, the air flow over an automobile establishes an overall heat transfer coefficient of 25 W/m²·K. The passenger cabin of this automobile exposes 8 m² of surface to the moving ambient air. On a day when the ambient temperature is 33°C, how much cooling must the air conditioning system supply to maintain a temperature of 20°C in the passenger cabin?

- (a) 0.65 MW (b) 1.4 MW (c) 2.6 MW (d) 3.5 MW (e) 0.94 MW

Answer (c) 2.6 MW

Solution Solved by EES Software. Solutions can be verified by copying-and-pasting the following lines on a blank EES screen.

```
h=25 [W/m^2-C]
A=8 [m^2]
T_1=33 [C]
T_2=20 [C]
Q=h*A*(T_2-T_1)
```

1-156 On a still clear night, the sky appears to be a blackbody with an equivalent temperature of 250 K. What is the air temperature when a strawberry field cools to 0°C and freezes if the heat transfer coefficient between the plants and the air is 6 W/m²·°C because of a light breeze and the plants have an emissivity of 0.9?

- (a) 14°C (b) 7°C (c) 3°C (d) 0°C (e) -3°C

Answer (a) 14°C

Solution Solved by EES Software. Solutions can be verified by copying-and-pasting the following lines on a blank EES screen.

```
e=0.9
h=6 [W/m^2-K]
T_1=273 [K]
T_2=250 [K]
h*(T-T_1)=e*sigma#*(T_1^4-T_2^4)
```

1-157 Over 90 percent of the energy dissipated by an incandescent light bulb is in the form of heat, not light. What is the temperature of a vacuum-enclosed tungsten filament with an exposed surface area of 2.03 cm² in a 100 W incandescent light bulb? The emissivity of tungsten at the anticipated high temperatures is about 0.35. Note that the light bulb consumes 100 W of electrical energy, and dissipates all of it by radiation.

- (a) 1870 K (b) 2230 K (c) 2640 K (d) 3120 K (e) 2980 K

Answer (b) 2230 K

Solution Solved by EES Software. Solutions can be verified by copying-and-pasting the following lines on a blank EES screen.

```
e =0.35
Q=100 [W]
A=2.03E-4 [m^2]
Q=e*A*sigma#*T^4
```

1-158 Commercial surface coating processes often use infrared lamps to speed the curing of the coating. A 2-mm-thick, teflon ($k = 0.45 \text{ W/m}\cdot\text{K}$) coating is applied to a $4 \text{ m} \times 4 \text{ m}$ surface using this process. Once the coating reaches steady-state, the temperature of its two surfaces are 50°C and 45°C . What is the minimum rate at which power must be supplied to the infrared lamps steadily?

- (a) 18 kW (b) 20 kW (c) 22 kW (d) 24 kW (e) 26 kW

Answer (a) 18 kW

Solution Solved by EES Software. Solutions can be verified by copying-and-pasting the following lines on a blank EES screen.

```
k=0.45 [W/m-K]
A=16 [m^2]
t=0.002 [m]
dT=5 [C]
Q=k*A*dT/t
```

1-159 . . . 1-161 Design and Essay Problems



Chapter 2

HEAT CONDUCTION EQUATION

Introduction

2-1C Heat transfer is a *vector* quantity since it has direction as well as magnitude. Therefore, we must specify both direction and magnitude in order to describe heat transfer completely at a point. Temperature, on the other hand, is a scalar quantity.

2-2C The term *steady* implies *no change with time* at any point within the medium while *transient* implies *variation with time or time dependence*. Therefore, the temperature or heat flux remains unchanged with time during steady heat transfer through a medium at any location although both quantities may vary from one location to another. During transient heat transfer, the temperature and heat flux may vary with time as well as location. Heat transfer is one-dimensional if it occurs primarily in one direction. It is two-dimensional if heat transfer in the third dimension is negligible.

2-3C Heat transfer to a canned drink can be modeled as two-dimensional since temperature differences (and thus heat transfer) will exist in the radial and axial directions (but there will be symmetry about the center line and no heat transfer in the azimuthal direction. This would be a transient heat transfer process since the temperature at any point within the drink will change with time during heating. Also, we would use the cylindrical coordinate system to solve this problem since a cylinder is best described in cylindrical coordinates. Also, we would place the origin somewhere on the center line, possibly at the center of the bottom surface.

2-4C Heat transfer to a potato in an oven can be modeled as one-dimensional since temperature differences (and thus heat transfer) will exist in the radial direction only because of symmetry about the center point. This would be a transient heat transfer process since the temperature at any point within the potato will change with time during cooking. Also, we would use the spherical coordinate system to solve this problem since the entire outer surface of a spherical body can be described by a constant value of the radius in spherical coordinates. We would place the origin at the center of the potato.

2-5C Assuming the egg to be round, heat transfer to an egg in boiling water can be modeled as one-dimensional since temperature differences (and thus heat transfer) will primarily exist in the radial direction only because of symmetry about the center point. This would be a transient heat transfer process since the temperature at any point within the egg will change with time during cooking. Also, we would use the spherical coordinate system to solve this problem since the entire outer surface of a spherical body can be described by a constant value of the radius in spherical coordinates. We would place the origin at the center of the egg.

2-6C Heat transfer to a hot dog can be modeled as two-dimensional since temperature differences (and thus heat transfer) will exist in the radial and axial directions (but there will be symmetry about the center line and no heat transfer in the azimuthal direction. This would be a transient heat transfer process since the temperature at any point within the hot dog will change with time during cooking. Also, we would use the cylindrical coordinate system to solve this problem since a cylinder is best described in cylindrical coordinates. Also, we would place the origin somewhere on the center line, possibly at the center of the hot dog. Heat transfer in a very long hot dog could be considered to be one-dimensional in preliminary calculations.

2-7C Heat transfer to a roast beef in an oven would be transient since the temperature at any point within the roast will change with time during cooking. Also, by approximating the roast as a spherical object, this heat transfer process can be modeled as one-dimensional since temperature differences (and thus heat transfer) will primarily exist in the radial direction because of symmetry about the center point.

2-8C Heat loss from a hot water tank in a house to the surrounding medium can be considered to be a steady heat transfer problem. Also, it can be considered to be two-dimensional since temperature differences (and thus heat transfer) will exist in the radial and axial directions (but there will be symmetry about the center line and no heat transfer in the azimuthal direction.)

2-9C Yes, the heat flux vector at a point P on an isothermal surface of a medium has to be perpendicular to the surface at that point.

2-10C Isotropic materials have the same properties in all directions, and we do not need to be concerned about the variation of properties with direction for such materials. The properties of anisotropic materials such as the fibrous or composite materials, however, may change with direction.

2-11C In heat conduction analysis, the conversion of electrical, chemical, or nuclear energy into heat (or thermal) energy in solids is called heat generation.

2-12C The phrase “thermal energy generation” is equivalent to “heat generation,” and they are used interchangeably. They imply the conversion of some other form of energy into thermal energy. The phrase “energy generation,” however, is vague since the form of energy generated is not clear.

2-13 Heat transfer through the walls, door, and the top and bottom sections of an oven is transient in nature since the thermal conditions in the kitchen and the oven, in general, change with time. However, we would analyze this problem as a steady heat transfer problem under the worst anticipated conditions such as the highest temperature setting for the oven, and the anticipated lowest temperature in the kitchen (the so called “design” conditions). If the heating element of the oven is large enough to keep the oven at the desired temperature setting under the presumed worst conditions, then it is large enough to do so under all conditions by cycling on and off.

Heat transfer from the oven is three-dimensional in nature since heat will be entering through all six sides of the oven. However, heat transfer through any wall or floor takes place in the direction normal to the surface, and thus it can be analyzed as being one-dimensional. Therefore, this problem can be simplified greatly by considering the heat transfer as being one-dimensional at each of the four sides as well as the top and bottom sections, and then by adding the calculated values of heat transfers at each surface.

2-14E The power consumed by the resistance wire of an iron is given. The heat generation and the heat flux are to be determined.

Assumptions Heat is generated uniformly in the resistance wire.

Analysis A 1000 W iron will convert electrical energy into heat in the wire at a rate of 1000 W. Therefore, the rate of heat generation in a resistance wire is simply equal to the power rating of a resistance heater. Then the rate of heat generation in the wire per unit volume is determined by dividing the total rate of heat generation by the volume of the wire to be

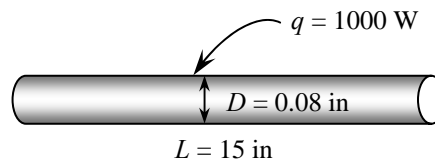

$$\dot{e}_{\text{gen}} = \frac{\dot{E}_{\text{gen}}}{V_{\text{wire}}} = \frac{\dot{E}_{\text{gen}}}{(\pi D^2 / 4)L} = \frac{1000 \text{ W}}{[\pi(0.08 / 12 \text{ ft})^2 / 4](15 / 12 \text{ ft})} \left(\frac{3.412 \text{ Btu/h}}{1 \text{ W}} \right) = 7.820 \times 10^7 \text{ Btu/h} \cdot \text{ft}^3$$

Similarly, heat flux on the outer surface of the wire as a result of this heat generation is determined by dividing the total rate of heat generation by the surface area of the wire to be

$$\dot{q} = \frac{\dot{E}_{\text{gen}}}{A_{\text{wire}}} = \frac{\dot{E}_{\text{gen}}}{\pi DL} = \frac{1000 \text{ W}}{\pi(0.08 / 12 \text{ ft})(15 / 12 \text{ ft})} \left(\frac{3.412 \text{ Btu/h}}{1 \text{ W}} \right) = 1.303 \times 10^5 \text{ Btu/h} \cdot \text{ft}^2$$

Discussion Note that heat generation is expressed per unit volume in $\text{Btu/h} \cdot \text{ft}^3$ whereas heat flux is expressed per unit surface area in $\text{Btu/h} \cdot \text{ft}^2$.

2-15E EES Prob. 2-14E is reconsidered. The surface heat flux as a function of wire diameter is to be plotted.

Analysis The problem is solved using EES, and the solution is given below.

"GIVEN"

$$E_{\dot{}}=1000 \text{ [W]}$$

$$L=15 \text{ [in]}$$

$$D=0.08 \text{ [in]}$$

"ANALYSIS"

$$g_{\dot{}}=E_{\dot{}}/V_{\text{wire}}*\text{Convert}(\text{W}, \text{Btu/h})$$

$$V_{\text{wire}}=\pi*D^2/4*L*\text{Convert}(\text{in}^3, \text{ft}^3)$$

$$q_{\dot{}}=E_{\dot{}}/A_{\text{wire}}*\text{Convert}(\text{W}, \text{Btu/h})$$

$$A_{\text{wire}}=\pi*D*L*\text{Convert}(\text{in}^2, \text{ft}^2)$$

D [in]	q [Btu/h.ft ²]
0.02	521370
0.04	260685
0.06	173790
0.08	130342
0.1	104274
0.12	86895
0.14	74481
0.16	65171
0.18	57930
0.2	52137

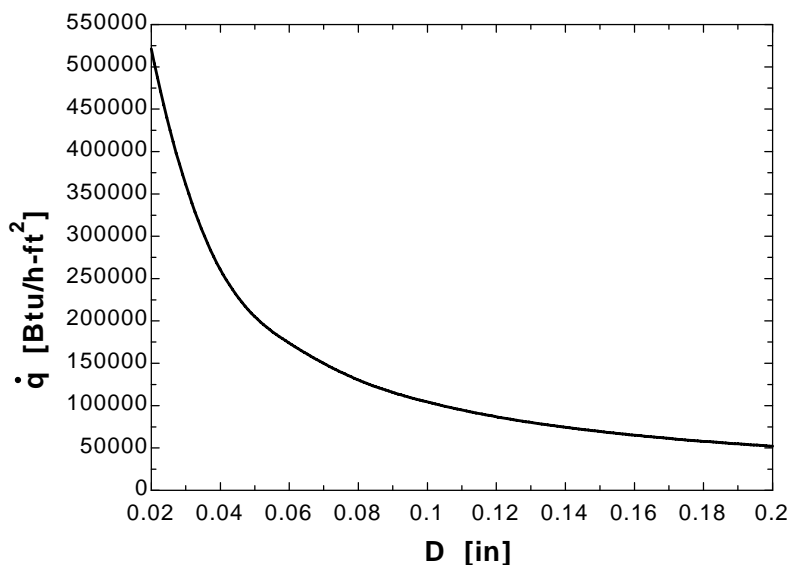

2-16 A certain thermopile used for heat flux meters is considered. The minimum heat flux this meter can detect is to be determined.

Assumptions 1 Steady operating conditions exist.

Properties The thermal conductivity of kapton is given to be 0.345 W/m·K.

Analysis The minimum heat flux can be determined from

$$\dot{q} = k \frac{\Delta T}{L} = (0.345 \text{ W/m} \cdot ^\circ\text{C}) \frac{0.1^\circ\text{C}}{0.002 \text{ m}} = \mathbf{17.3 \text{ W/m}^2}$$

2-17 The rate of heat generation per unit volume in the uranium rods is given. The total rate of heat generation in each rod is to be determined.

Assumptions Heat is generated uniformly in the uranium rods.

Analysis The total rate of heat generation in the rod is determined by multiplying the rate of heat generation per unit volume by the volume of the rod

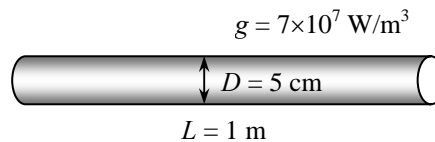

$$\dot{E}_{\text{gen}} = \dot{e}_{\text{gen}} \mathcal{V}_{\text{rod}} = \dot{e}_{\text{gen}} (\pi D^2 / 4) L = (7 \times 10^7 \text{ W/m}^3) [\pi (0.05 \text{ m})^2 / 4] (1 \text{ m}) = 1.374 \times 10^5 \text{ W} = \mathbf{137 \text{ kW}}$$

2-18 The variation of the absorption of solar energy in a solar pond with depth is given. A relation for the total rate of heat generation in a water layer at the top of the pond is to be determined.

Assumptions Absorption of solar radiation by water is modeled as heat generation.

Analysis The total rate of heat generation in a water layer of surface area A and thickness L at the top of the pond is determined by integration to be

$$\dot{E}_{\text{gen}} = \int_{\mathcal{V}} \dot{e}_{\text{gen}} d\mathcal{V} = \int_{x=0}^L \dot{e}_0 e^{-bx} (A dx) = A \dot{e}_0 \left. \frac{e^{-bx}}{-b} \right|_0^L = \frac{\mathbf{A \dot{e}_0 (1 - e^{-bL})}}{\mathbf{b}}$$

2-19 The rate of heat generation per unit volume in a stainless steel plate is given. The heat flux on the surface of the plate is to be determined.

Assumptions Heat is generated uniformly in steel plate.

Analysis We consider a unit surface area of 1 m^2 . The total rate of heat generation in this section of the plate is

$$\dot{E}_{\text{gen}} = \dot{e}_{\text{gen}} \mathcal{V}_{\text{plate}} = \dot{e}_{\text{gen}} (A \times L) = (5 \times 10^6 \text{ W/m}^3) (1 \text{ m}^2) (0.03 \text{ m}) = 1.5 \times 10^5 \text{ W}$$

Noting that this heat will be dissipated from both sides of the plate, the heat flux on either surface of the plate becomes

$$\dot{q} = \frac{\dot{E}_{\text{gen}}}{A_{\text{plate}}} = \frac{1.5 \times 10^5 \text{ W}}{2 \times 1 \text{ m}^2} = 75,000 \text{ W/m}^2 = \mathbf{75 \text{ kW/m}^2}$$

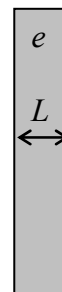

Heat Conduction Equation

2-20 The one-dimensional transient heat conduction equation for a plane wall with constant thermal conductivity and heat generation is $\frac{\partial^2 T}{\partial x^2} + \frac{\dot{e}_{\text{gen}}}{k} = \frac{1}{\alpha} \frac{\partial T}{\partial t}$. Here T is the temperature, x is the space variable, \dot{e}_{gen} is the heat generation per unit volume, k is the thermal conductivity, α is the thermal diffusivity, and t is the time.

2-21 The one-dimensional transient heat conduction equation for a plane wall with constant thermal conductivity and heat generation is $\frac{1}{r} \frac{\partial}{\partial r} \left(r \frac{\partial T}{\partial r} \right) + \frac{\dot{e}_{\text{gen}}}{k} = \frac{1}{\alpha} \frac{\partial T}{\partial t}$. Here T is the temperature, r is the space variable, \dot{e}_{gen} is the heat generation per unit volume, k is the thermal conductivity, α is the thermal diffusivity, and t is the time.

2-22 We consider a thin element of thickness Δx in a large plane wall (see Fig. 2-13 in the text). The density of the wall is ρ , the specific heat is c , and the area of the wall normal to the direction of heat transfer is A . In the absence of any heat generation, an *energy balance* on this thin element of thickness Δx during a small time interval Δt can be expressed as

$$\dot{Q}_x - \dot{Q}_{x+\Delta x} = \frac{\Delta E_{\text{element}}}{\Delta t}$$

where

$$\Delta E_{\text{element}} = E_{t+\Delta t} - E_t = mc(T_{t+\Delta t} - T_t) = \rho c A \Delta x (T_{t+\Delta t} - T_t)$$

Substituting,

$$\dot{Q}_x - \dot{Q}_{x+\Delta x} = \rho c A \Delta x \frac{T_{t+\Delta t} - T_t}{\Delta t}$$

Dividing by $A \Delta x$ gives

$$-\frac{1}{A} \frac{\dot{Q}_{x+\Delta x} - \dot{Q}_x}{\Delta x} = \rho c \frac{T_{t+\Delta t} - T_t}{\Delta t}$$

Taking the limit as $\Delta x \rightarrow 0$ and $\Delta t \rightarrow 0$ yields

$$\frac{1}{A} \frac{\partial}{\partial x} \left(kA \frac{\partial T}{\partial x} \right) = \rho c \frac{\partial T}{\partial t}$$

since from the definition of the derivative and Fourier's law of heat conduction,

$$\lim_{\Delta x \rightarrow 0} \frac{\dot{Q}_{x+\Delta x} - \dot{Q}_x}{\Delta x} = \frac{\partial \dot{Q}}{\partial x} = \frac{\partial}{\partial x} \left(-kA \frac{\partial T}{\partial x} \right)$$

Noting that the area A of a plane wall is constant, the one-dimensional transient heat conduction equation in a plane wall with constant thermal conductivity k becomes

$$\frac{\partial^2 T}{\partial x^2} = \frac{1}{\alpha} \frac{\partial T}{\partial t}$$

where the property $\alpha = k / \rho c$ is the thermal diffusivity of the material.

2-23 We consider a thin cylindrical shell element of thickness Δr in a long cylinder (see Fig. 2-15 in the text). The density of the cylinder is ρ , the specific heat is c , and the length is L . The area of the cylinder normal to the direction of heat transfer at any location is $A = 2\pi rL$ where r is the value of the radius at that location. Note that the heat transfer area A depends on r in this case, and thus it varies with location. An *energy balance* on this thin cylindrical shell element of thickness Δr during a small time interval Δt can be expressed as

$$\dot{Q}_r - \dot{Q}_{r+\Delta r} + \dot{E}_{\text{element}} = \frac{\Delta E_{\text{element}}}{\Delta t}$$

where

$$\Delta E_{\text{element}} = E_{t+\Delta t} - E_t = mc(T_{t+\Delta t} - T_t) = \rho c A \Delta r (T_{t+\Delta t} - T_t)$$

$$\dot{E}_{\text{element}} = \dot{e}_{\text{gen}} \mathbf{V}_{\text{element}} = \dot{e}_{\text{gen}} A \Delta r$$

Substituting,

$$\dot{Q}_r - \dot{Q}_{r+\Delta r} + \dot{e}_{\text{gen}} A \Delta r = \rho c A \Delta r \frac{T_{t+\Delta t} - T_t}{\Delta t}$$

where $A = 2\pi rL$. Dividing the equation above by $A \Delta r$ gives

$$-\frac{1}{A} \frac{\dot{Q}_{r+\Delta r} - \dot{Q}_r}{\Delta r} + \dot{e}_{\text{gen}} = \rho c \frac{T_{t+\Delta t} - T_t}{\Delta t}$$

Taking the limit as $\Delta r \rightarrow 0$ and $\Delta t \rightarrow 0$ yields

$$\frac{1}{A} \frac{\partial}{\partial r} \left(kA \frac{\partial T}{\partial r} \right) + \dot{e}_{\text{gen}} = \rho c \frac{\partial T}{\partial t}$$

since, from the definition of the derivative and Fourier's law of heat conduction,

$$\lim_{\Delta r \rightarrow 0} \frac{\dot{Q}_{r+\Delta r} - \dot{Q}_r}{\Delta r} = \frac{\partial \dot{Q}}{\partial r} = \frac{\partial}{\partial r} \left(-kA \frac{\partial T}{\partial r} \right)$$

Noting that the heat transfer area in this case is $A = 2\pi rL$ and the thermal conductivity is constant, the one-dimensional transient heat conduction equation in a cylinder becomes

$$\frac{1}{r} \frac{\partial}{\partial r} \left(r \frac{\partial T}{\partial r} \right) + \dot{e}_{\text{gen}} = \frac{1}{\alpha} \frac{\partial T}{\partial t}$$

where $\alpha = k / \rho c$ is the thermal diffusivity of the material.

2-24 We consider a thin spherical shell element of thickness Δr in a sphere (see Fig. 2-17 in the text). The density of the sphere is ρ , the specific heat is c , and the length is L . The area of the sphere normal to the direction of heat transfer at any location is $A = 4\pi r^2$ where r is the value of the radius at that location. Note that the heat transfer area A depends on r in this case, and thus it varies with location. When there is no heat generation, an *energy balance* on this thin spherical shell element of thickness Δr during a small time interval Δt can be expressed as

$$\dot{Q}_r - \dot{Q}_{r+\Delta r} = \frac{\Delta E_{\text{element}}}{\Delta t}$$

where

$$\Delta E_{\text{element}} = E_{t+\Delta t} - E_t = mc(T_{t+\Delta t} - T_t) = \rho c A \Delta r (T_{t+\Delta t} - T_t)$$

Substituting,

$$\dot{Q}_r - \dot{Q}_{r+\Delta r} = \rho c A \Delta r \frac{T_{t+\Delta t} - T_t}{\Delta t}$$

where $A = 4\pi r^2$. Dividing the equation above by $A \Delta r$ gives

$$-\frac{1}{A} \frac{\dot{Q}_{r+\Delta r} - \dot{Q}_r}{\Delta r} = \rho c \frac{T_{t+\Delta t} - T_t}{\Delta t}$$

Taking the limit as $\Delta r \rightarrow 0$ and $\Delta t \rightarrow 0$ yields

$$\frac{1}{A} \frac{\partial}{\partial r} \left(k A \frac{\partial T}{\partial r} \right) = \rho c \frac{\partial T}{\partial t}$$

since, from the definition of the derivative and Fourier's law of heat conduction,

$$\lim_{\Delta r \rightarrow 0} \frac{\dot{Q}_{r+\Delta r} - \dot{Q}_r}{\Delta r} = \frac{\partial \dot{Q}}{\partial r} = \frac{\partial}{\partial r} \left(-k A \frac{\partial T}{\partial r} \right)$$

Noting that the heat transfer area in this case is $A = 4\pi r^2$ and the thermal conductivity k is constant, the one-dimensional transient heat conduction equation in a sphere becomes

$$\frac{1}{r^2} \frac{\partial}{\partial r} \left(r^2 \frac{\partial T}{\partial r} \right) = \frac{1}{\alpha} \frac{\partial T}{\partial t}$$

where $\alpha = k / \rho c$ is the thermal diffusivity of the material.

2-25 For a medium in which the heat conduction equation is given in its simplest by $\frac{\partial^2 T}{\partial x^2} = \frac{1}{\alpha} \frac{\partial T}{\partial t}$:

(a) Heat transfer is transient, (b) it is one-dimensional, (c) there is no heat generation, and (d) the thermal conductivity is constant.

2-26 For a medium in which the heat conduction equation is given in its simplest by

$$\frac{1}{r} \frac{d}{dr} \left(rk \frac{dT}{dr} \right) + \dot{e}_{\text{gen}} = 0 :$$

(a) Heat transfer is steady, (b) it is one-dimensional, (c) there is heat generation, and (d) the thermal conductivity is variable.

2-27 For a medium in which the heat conduction equation is given by $\frac{1}{r^2} \frac{\partial}{\partial r} \left(r^2 \frac{\partial T}{\partial r} \right) = \frac{1}{\alpha} \frac{\partial T}{\partial t}$

(a) Heat transfer is transient, (b) it is one-dimensional, (c) there is no heat generation, and (d) the thermal conductivity is constant.

2-28 For a medium in which the heat conduction equation is given in its simplest by $r \frac{d^2 T}{dr^2} + \frac{dT}{dr} = 0 :$

(a) Heat transfer is steady, (b) it is one-dimensional, (c) there is no heat generation, and (d) the thermal conductivity is constant.

2-29 We consider a small rectangular element of length Δx , width Δy , and height $\Delta z = 1$ (similar to the one in Fig. 2-21). The density of the body is ρ and the specific heat is c . Noting that heat conduction is two-dimensional and assuming no heat generation, an *energy balance* on this element during a small time interval Δt can be expressed as

$$\left(\begin{array}{l} \text{Rate of heat} \\ \text{conduction at the} \\ \text{surfaces at } x \text{ and } y \end{array} \right) - \left(\begin{array}{l} \text{Rate of heat conduction} \\ \text{at the surfaces at} \\ x + \Delta x \text{ and } y + \Delta y \end{array} \right) = \left(\begin{array}{l} \text{Rate of change of} \\ \text{the energy content} \\ \text{of the element} \end{array} \right)$$

$$\text{or} \quad \dot{Q}_x + \dot{Q}_y - \dot{Q}_{x+\Delta x} - \dot{Q}_{y+\Delta y} = \frac{\Delta E_{\text{element}}}{\Delta t}$$

Noting that the volume of the element is $V_{\text{element}} = \Delta x \Delta y \Delta z = \Delta x \Delta y \times 1$, the change in the energy content of the element can be expressed as

$$\Delta E_{\text{element}} = E_{t+\Delta t} - E_t = mc(T_{t+\Delta t} - T_t) = \rho c \Delta x \Delta y (T_{t+\Delta t} - T_t)$$

$$\text{Substituting,} \quad \dot{Q}_x + \dot{Q}_y - \dot{Q}_{x+\Delta x} - \dot{Q}_{y+\Delta y} = \rho c \Delta x \Delta y \frac{T_{t+\Delta t} - T_t}{\Delta t}$$

Dividing by $\Delta x \Delta y$ gives

$$-\frac{1}{\Delta y} \frac{\dot{Q}_{x+\Delta x} - \dot{Q}_x}{\Delta x} - \frac{1}{\Delta x} \frac{\dot{Q}_{y+\Delta y} - \dot{Q}_y}{\Delta y} = \rho c \frac{T_{t+\Delta t} - T_t}{\Delta t}$$

Taking the thermal conductivity k to be constant and noting that the heat transfer surface areas of the element for heat conduction in the x and y directions are $A_x = \Delta y \times 1$ and $A_y = \Delta x \times 1$, respectively, and taking the limit as $\Delta x, \Delta y$, and $\Delta t \rightarrow 0$ yields

$$\frac{\partial^2 T}{\partial x^2} + \frac{\partial^2 T}{\partial y^2} = \frac{1}{\alpha} \frac{\partial T}{\partial t}$$

since, from the definition of the derivative and Fourier's law of heat conduction,

$$\lim_{\Delta x \rightarrow 0} \frac{1}{\Delta y \Delta z} \frac{\dot{Q}_{x+\Delta x} - \dot{Q}_x}{\Delta x} = \frac{1}{\Delta y \Delta z} \frac{\partial \dot{Q}_x}{\partial x} = \frac{1}{\Delta y \Delta z} \frac{\partial}{\partial x} \left(-k \Delta y \Delta z \frac{\partial T}{\partial x} \right) = -\frac{\partial}{\partial x} \left(k \frac{\partial T}{\partial x} \right) = -k \frac{\partial^2 T}{\partial x^2}$$

$$\lim_{\Delta y \rightarrow 0} \frac{1}{\Delta x \Delta z} \frac{\dot{Q}_{y+\Delta y} - \dot{Q}_y}{\Delta y} = \frac{1}{\Delta x \Delta z} \frac{\partial \dot{Q}_y}{\partial y} = \frac{1}{\Delta x \Delta z} \frac{\partial}{\partial y} \left(-k \Delta x \Delta z \frac{\partial T}{\partial y} \right) = -\frac{\partial}{\partial y} \left(k \frac{\partial T}{\partial y} \right) = -k \frac{\partial^2 T}{\partial y^2}$$

Here the property $\alpha = k / \rho c$ is the thermal diffusivity of the material.

2-30 We consider a thin ring shaped volume element of width Δz and thickness Δr in a cylinder. The density of the cylinder is ρ and the specific heat is c . In general, an *energy balance* on this ring element during a small time interval Δt can be expressed as

$$(\dot{Q}_r - \dot{Q}_{r+\Delta r}) + (\dot{Q}_z - \dot{Q}_{z+\Delta z}) = \frac{\Delta E_{\text{element}}}{\Delta t}$$

But the change in the energy content of the element can be expressed as

$$\Delta E_{\text{element}} = E_{t+\Delta t} - E_t = mc(T_{t+\Delta t} - T_t) = \rho c(2\pi r \Delta r) \Delta z (T_{t+\Delta t} - T_t)$$

Substituting,

$$(\dot{Q}_r - \dot{Q}_{r+\Delta r}) + (\dot{Q}_z - \dot{Q}_{z+\Delta z}) = \rho c(2\pi r \Delta r) \Delta z \frac{T_{t+\Delta t} - T_t}{\Delta t}$$

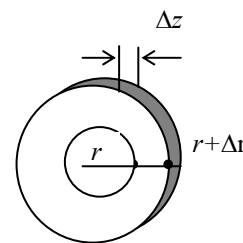

Dividing the equation above by $(2\pi r \Delta r) \Delta z$ gives

$$-\frac{1}{2\pi r \Delta z} \frac{\dot{Q}_{r+\Delta r} - \dot{Q}_r}{\Delta r} - \frac{1}{2\pi r \Delta r} \frac{\dot{Q}_{z+\Delta z} - \dot{Q}_z}{\Delta z} = \rho c \frac{T_{t+\Delta t} - T_t}{\Delta t}$$

Noting that the heat transfer surface areas of the element for heat conduction in the r and z directions are $A_r = 2\pi r \Delta z$ and $A_z = 2\pi r \Delta r$, respectively, and taking the limit as $\Delta r, \Delta z$ and $\Delta t \rightarrow 0$ yields

$$\frac{1}{r} \frac{\partial}{\partial r} \left(kr \frac{\partial T}{\partial r} \right) + \frac{1}{r^2} \frac{\partial}{\partial \phi} \left(k \frac{\partial T}{\partial \phi} \right) + \frac{\partial}{\partial z} \left(k \frac{\partial T}{\partial z} \right) = \rho c \frac{\partial T}{\partial t}$$

since, from the definition of the derivative and Fourier's law of heat conduction,

$$\lim_{\Delta r \rightarrow 0} \frac{1}{2\pi r \Delta z} \frac{\dot{Q}_{r+\Delta r} - \dot{Q}_r}{\Delta r} = \frac{1}{2\pi r \Delta z} \frac{\partial \dot{Q}}{\partial r} = \frac{1}{2\pi r \Delta z} \frac{\partial}{\partial r} \left(-k(2\pi r \Delta z) \frac{\partial T}{\partial r} \right) = -\frac{1}{r} \frac{\partial}{\partial r} \left(kr \frac{\partial T}{\partial r} \right)$$

$$\lim_{\Delta z \rightarrow 0} \frac{1}{2\pi r \Delta r} \frac{\dot{Q}_{z+\Delta z} - \dot{Q}_z}{\Delta z} = \frac{1}{2\pi r \Delta r} \frac{\partial \dot{Q}_z}{\partial z} = \frac{1}{2\pi r \Delta r} \frac{\partial}{\partial z} \left(-k(2\pi r \Delta r) \frac{\partial T}{\partial z} \right) = -\frac{\partial}{\partial z} \left(k \frac{\partial T}{\partial z} \right)$$

For the case of constant thermal conductivity the equation above reduces to

$$\frac{1}{r} \frac{\partial}{\partial r} \left(r \frac{\partial T}{\partial r} \right) + \frac{\partial^2 T}{\partial z^2} = \frac{1}{\alpha} \frac{\partial T}{\partial t}$$

where $\alpha = k / \rho c$ is the thermal diffusivity of the material. For the case of steady heat conduction with no heat generation it reduces to

$$\frac{1}{r} \frac{\partial}{\partial r} \left(r \frac{\partial T}{\partial r} \right) + \frac{\partial^2 T}{\partial z^2} = 0$$

2-31 Consider a thin disk element of thickness Δz and diameter D in a long cylinder (Fig. P2-31). The density of the cylinder is ρ , the specific heat is c , and the area of the cylinder normal to the direction of heat transfer is $A = \pi D^2 / 4$, which is constant. An *energy balance* on this thin element of thickness Δz during a small time interval Δt can be expressed as

$$\left(\begin{array}{c} \text{Rate of heat} \\ \text{conduction at} \\ \text{the surface at } z \end{array} \right) - \left(\begin{array}{c} \text{Rate of heat} \\ \text{conduction at the} \\ \text{surface at } z + \Delta z \end{array} \right) + \left(\begin{array}{c} \text{Rate of heat} \\ \text{generation inside} \\ \text{the element} \end{array} \right) = \left(\begin{array}{c} \text{Rate of change of} \\ \text{the energy content} \\ \text{of the element} \end{array} \right)$$

or,

$$\dot{Q}_z - \dot{Q}_{z+\Delta z} + \dot{E}_{\text{element}} = \frac{\Delta E_{\text{element}}}{\Delta t}$$

But the change in the energy content of the element and the rate of heat generation within the element can be expressed as

$$\Delta E_{\text{element}} = E_{t+\Delta t} - E_t = mc(T_{t+\Delta t} - T_t) = \rho c A \Delta z (T_{t+\Delta t} - T_t)$$

and

$$\dot{E}_{\text{element}} = \dot{e}_{\text{gen}} \mathcal{V}_{\text{element}} = \dot{e}_{\text{gen}} A \Delta z$$

Substituting,

$$\dot{Q}_z - \dot{Q}_{z+\Delta z} + \dot{e}_{\text{gen}} A \Delta z = \rho c A \Delta z \frac{T_{t+\Delta t} - T_t}{\Delta t}$$

Dividing by $A \Delta z$ gives

$$-\frac{1}{A} \frac{\dot{Q}_{z+\Delta z} - \dot{Q}_z}{\Delta z} + \dot{e}_{\text{gen}} = \rho c \frac{T_{t+\Delta t} - T_t}{\Delta t}$$

Taking the limit as $\Delta z \rightarrow 0$ and $\Delta t \rightarrow 0$ yields

$$\frac{1}{A} \frac{\partial}{\partial z} \left(kA \frac{\partial T}{\partial z} \right) + \dot{e}_{\text{gen}} = \rho c \frac{\partial T}{\partial t}$$

since, from the definition of the derivative and Fourier's law of heat conduction,

$$\lim_{\Delta z \rightarrow 0} \frac{\dot{Q}_{z+\Delta z} - \dot{Q}_z}{\Delta z} = \frac{\partial \dot{Q}}{\partial z} = \frac{\partial}{\partial z} \left(-kA \frac{\partial T}{\partial z} \right)$$

Noting that the area A and the thermal conductivity k are constant, the one-dimensional transient heat conduction equation in the axial direction in a long cylinder becomes

$$\frac{\partial^2 T}{\partial z^2} + \frac{\dot{e}_{\text{gen}}}{k} = \frac{1}{\alpha} \frac{\partial T}{\partial t}$$

where the property $\alpha = k / \rho c$ is the thermal diffusivity of the material.

2-32 For a medium in which the heat conduction equation is given by $\frac{\partial^2 T}{\partial x^2} + \frac{\partial^2 T}{\partial y^2} = \frac{1}{\alpha} \frac{\partial T}{\partial t}$:

(a) Heat transfer is transient, (b) it is two-dimensional, (c) there is no heat generation, and (d) the thermal conductivity is constant.

2-33 For a medium in which the heat conduction equation is given by

$$\frac{1}{r} \frac{\partial}{\partial r} \left(kr \frac{\partial T}{\partial r} \right) + \frac{\partial}{\partial z} \left(k \frac{\partial T}{\partial z} \right) + \dot{e}_{\text{gen}} = 0 :$$

(a) Heat transfer is steady, (b) it is two-dimensional, (c) there is heat generation, and (d) the thermal conductivity is variable.

2-34 For a medium in which the heat conduction equation is given by

$$\frac{1}{r^2} \frac{\partial}{\partial r} \left(r^2 \frac{\partial T}{\partial r} \right) + \frac{1}{r^2 \sin^2 \theta} \frac{\partial^2 T}{\partial \phi^2} = \frac{1}{\alpha} \frac{\partial T}{\partial t}$$

(a) Heat transfer is transient, (b) it is two-dimensional, (c) there is no heat generation, and (d) the thermal conductivity is constant.

Boundary and Initial Conditions; Formulation of Heat Conduction Problems

2-35C The mathematical expressions of the thermal conditions at the boundaries are called the **boundary conditions**. To describe a heat transfer problem completely, *two boundary conditions* must be given for *each direction* of the coordinate system along which heat transfer is significant. Therefore, we need to specify four boundary conditions for two-dimensional problems.

2-36C The mathematical expression for the temperature distribution of the medium initially is called the **initial condition**. We need only one initial condition for a heat conduction problem regardless of the dimension since the conduction equation is first order in time (it involves the first derivative of temperature with respect to time). Therefore, we need only 1 initial condition for a two-dimensional problem.

2-37C A heat transfer problem that is symmetric about a plane, line, or point is said to have thermal symmetry about that plane, line, or point. The thermal symmetry boundary condition is a mathematical expression of this thermal symmetry. It is equivalent to *insulation* or *zero heat flux* boundary condition, and is expressed at a point x_0 as $\partial T(x_0, t) / \partial x = 0$.

2-38C The boundary condition at a perfectly insulated surface (at $x = 0$, for example) can be expressed as

$$-k \frac{\partial T(0, t)}{\partial x} = 0 \quad \text{or} \quad \frac{\partial T(0, t)}{\partial x} = 0 \quad \text{which indicates zero heat flux.}$$

2-39C Yes, the temperature profile in a medium must be perpendicular to an insulated surface since the slope $\partial T / \partial x = 0$ at that surface.

2-40C We try to avoid the radiation boundary condition in heat transfer analysis because it is a non-linear expression that causes mathematical difficulties while solving the problem; often making it impossible to obtain analytical solutions.

2-41 A spherical container of inner radius r_1 , outer radius r_2 , and thermal conductivity k is given. The boundary condition on the inner surface of the container for steady one-dimensional conduction is to be expressed for the following cases:

(a) Specified temperature of 50°C : $T(r_1) = 50^\circ\text{C}$

(b) Specified heat flux of 30 W/m^2 towards the center: $k \frac{dT(r_1)}{dr} = 30 \text{ W/m}^2$

(c) Convection to a medium at T_∞ with a heat transfer coefficient of h : $k \frac{dT(r_1)}{dr} = h[T(r_1) - T_\infty]$

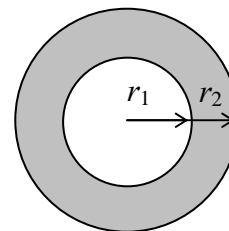

2-42 Heat is generated in a long wire of radius r_o covered with a plastic insulation layer at a constant rate of \dot{e}_{gen} . The heat flux boundary condition at the interface (radius r_o) in terms of the heat generated is to be expressed. The total heat generated in the wire and the heat flux at the interface are

$$\begin{aligned} \dot{E}_{\text{gen}} &= \dot{e}_{\text{gen}} \mathcal{V}_{\text{wire}} = \dot{e}_{\text{gen}} (\pi r_o^2 L) \\ \dot{q}_s &= \frac{\dot{Q}_s}{A} = \frac{\dot{E}_{\text{gen}}}{A} = \frac{\dot{e}_{\text{gen}} (\pi r_o^2 L)}{(2\pi r_o) L} = \frac{\dot{e}_{\text{gen}} r_o}{2} \end{aligned}$$

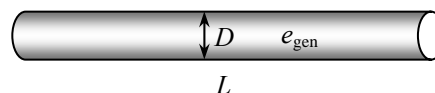

Assuming steady one-dimensional conduction in the radial direction, the heat flux boundary condition can be expressed as

$$-k \frac{dT(r_o)}{dr} = \frac{\dot{e}_{\text{gen}} r_o}{2}$$

2-43 A long pipe of inner radius r_1 , outer radius r_2 , and thermal conductivity k is considered. The outer surface of the pipe is subjected to convection to a medium at T_∞ with a heat transfer coefficient of h . Assuming steady one-dimensional conduction in the radial direction, the convection boundary condition on the outer surface of the pipe can be expressed as

$$-k \frac{dT(r_2)}{dr} = h[T(r_2) - T_\infty]$$

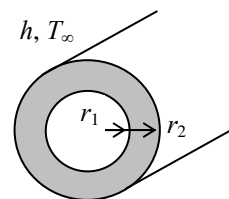

2-44 A spherical shell of inner radius r_1 , outer radius r_2 , and thermal conductivity k is considered. The outer surface of the shell is subjected to radiation to surrounding surfaces at T_{surr} . Assuming no convection and steady one-dimensional conduction in the radial direction, the radiation boundary condition on the outer surface of the shell can be expressed as

$$-k \frac{dT(r_2)}{dr} = \varepsilon \sigma [T(r_2)^4 - T_{\text{surr}}^4]$$

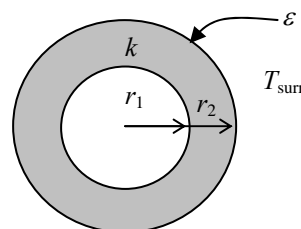

2-45 A spherical container consists of two spherical layers A and B that are at perfect contact. The radius of the interface is r_o . Assuming transient one-dimensional conduction in the radial direction, the boundary conditions at the interface can be expressed as

$$T_A(r_o, t) = T_B(r_o, t)$$

and
$$-k_A \frac{\partial T_A(r_o, t)}{\partial r} = -k_B \frac{\partial T_B(r_o, t)}{\partial r}$$

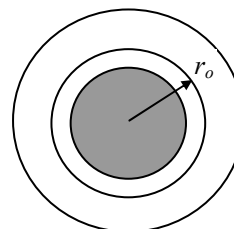

2-46 Heat conduction through the bottom section of a steel pan that is used to boil water on top of an electric range is considered. Assuming constant thermal conductivity and one-dimensional heat transfer, the mathematical formulation (the differential equation and the boundary conditions) of this heat conduction problem is to be obtained for steady operation.

Assumptions **1** Heat transfer is given to be steady and one-dimensional. **2** Thermal conductivity is given to be constant. **3** There is no heat generation in the medium. **4** The top surface at $x = L$ is subjected to convection and the bottom surface at $x = 0$ is subjected to uniform heat flux.

Analysis The heat flux at the bottom of the pan is

$$\dot{q}_s = \frac{\dot{Q}_s}{A_s} = \frac{\dot{E}_{\text{gen}}}{\pi D^2 / 4} = \frac{0.85 \times (1250 \text{ W})}{\pi (0.20 \text{ m})^2 / 4} = 33,820 \text{ W/m}^2$$

Then the differential equation and the boundary conditions for this heat conduction problem can be expressed as

$$\begin{aligned} \frac{d^2 T}{dx^2} &= 0 \\ -k \frac{dT(0)}{dx} &= \dot{q}_s = 33,280 \text{ W/m}^2 \\ -k \frac{dT(L)}{dx} &= h[T(L) - T_\infty] \end{aligned}$$

2-47E A 2-kW resistance heater wire is used for space heating. Assuming constant thermal conductivity and one-dimensional heat transfer, the mathematical formulation (the differential equation and the boundary conditions) of this heat conduction problem is to be obtained for steady operation.

Assumptions **1** Heat transfer is given to be steady and one-dimensional. **2** Thermal conductivity is given to be constant. **3** Heat is generated uniformly in the wire.

Analysis The heat flux at the surface of the wire is

$$\dot{q}_s = \frac{\dot{Q}_s}{A_s} = \frac{\dot{E}_{\text{gen}}}{2\pi r_o L} = \frac{1200 \text{ W}}{2\pi (0.06 \text{ in})(15 \text{ in})} = 212.2 \text{ W/in}^2$$

Noting that there is thermal symmetry about the center line and there is uniform heat flux at the outer surface, the differential equation and the boundary conditions for this heat conduction problem can be expressed as

$$\begin{aligned} \frac{1}{r} \frac{d}{dr} \left(r \frac{dT}{dr} \right) + \frac{\dot{e}_{\text{gen}}}{k} &= 0 \\ \frac{dT(0)}{dr} &= 0 \\ -k \frac{dT(r_o)}{dr} &= \dot{q}_s = 212.2 \text{ W/in}^2 \end{aligned}$$

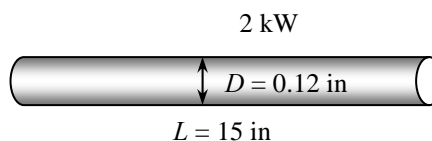

2-48 Heat conduction through the bottom section of an aluminum pan that is used to cook stew on top of an electric range is considered (Fig. P2-48). Assuming variable thermal conductivity and one-dimensional heat transfer, the mathematical formulation (the differential equation and the boundary conditions) of this heat conduction problem is to be obtained for steady operation.

Assumptions **1** Heat transfer is given to be steady and one-dimensional. **2** Thermal conductivity is given to be variable. **3** There is no heat generation in the medium. **4** The top surface at $x = L$ is subjected to specified temperature and the bottom surface at $x = 0$ is subjected to uniform heat flux.

Analysis The heat flux at the bottom of the pan is

$$\dot{q}_s = \frac{\dot{Q}_s}{A_s} = \frac{\dot{E}_{\text{gen}}}{\pi D^2 / 4} = \frac{0.90 \times (900 \text{ W})}{\pi (0.18 \text{ m})^2 / 4} = 31,831 \text{ W/m}^2$$

Then the differential equation and the boundary conditions for this heat conduction problem can be expressed as

$$\begin{aligned} \frac{d}{dx} \left(k \frac{dT}{dx} \right) &= 0 \\ -k \frac{dT(0)}{dx} &= \dot{q}_s = 31,831 \text{ W/m}^2 \\ T(L) &= T_L = 108^\circ\text{C} \end{aligned}$$

2-49 Water flows through a pipe whose outer surface is wrapped with a thin electric heater that consumes 300 W per m length of the pipe. The exposed surface of the heater is heavily insulated so that the entire heat generated in the heater is transferred to the pipe. Heat is transferred from the inner surface of the pipe to the water by convection. Assuming constant thermal conductivity and one-dimensional heat transfer, the mathematical formulation (the differential equation and the boundary conditions) of the heat conduction in the pipe is to be obtained for steady operation.

Assumptions **1** Heat transfer is given to be steady and one-dimensional. **2** Thermal conductivity is given to be constant. **3** There is no heat generation in the medium. **4** The outer surface at $r = r_2$ is subjected to uniform heat flux and the inner surface at $r = r_1$ is subjected to convection.

Analysis The heat flux at the outer surface of the pipe is

$$\dot{q}_s = \frac{\dot{Q}_s}{A_s} = \frac{\dot{Q}_s}{2\pi r_2 L} = \frac{300 \text{ W}}{2\pi (0.065 \text{ cm})(1 \text{ m})} = 734.6 \text{ W/m}^2$$

Noting that there is thermal symmetry about the center line and there is uniform heat flux at the outer surface, the differential equation and the boundary conditions for this heat conduction problem can be expressed as

$$\begin{aligned} \frac{d}{dr} \left(r \frac{dT}{dr} \right) &= 0 \\ k \frac{dT(r_1)}{dr} &= h[T(r_1) - T_\infty] = 85[T(r_1) - 70] \\ k \frac{dT(r_2)}{dr} &= \dot{q}_s = 734.6 \text{ W/m}^2 \end{aligned}$$

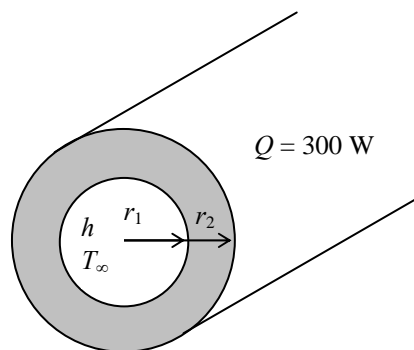

2-50 A spherical metal ball that is heated in an oven to a temperature of T_i throughout is dropped into a large body of water at T_∞ where it is cooled by convection. Assuming constant thermal conductivity and transient one-dimensional heat transfer, the mathematical formulation (the differential equation and the boundary and initial conditions) of this heat conduction problem is to be obtained.

Assumptions **1** Heat transfer is given to be transient and one-dimensional. **2** Thermal conductivity is given to be constant. **3** There is no heat generation in the medium. **4** The outer surface at $r = r_o$ is subjected to convection.

Analysis Noting that there is thermal symmetry about the midpoint and convection at the outer surface, the differential equation and the boundary conditions for this heat conduction problem can be expressed as

$$\frac{1}{r^2} \frac{\partial}{\partial r} \left(r^2 \frac{\partial T}{\partial r} \right) = \frac{1}{\alpha} \frac{\partial T}{\partial t}$$

$$\frac{\partial T(0, t)}{\partial r} = 0$$

$$-k \frac{\partial T(r_o, t)}{\partial r} = h[T(r_o) - T_\infty]$$

$$T(r, 0) = T_i$$

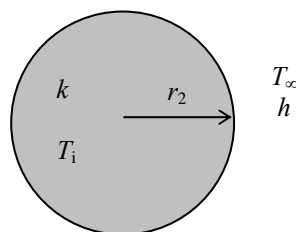

2-51 A spherical metal ball that is heated in an oven to a temperature of T_i throughout is allowed to cool in ambient air at T_∞ by convection and radiation. Assuming constant thermal conductivity and transient one-dimensional heat transfer, the mathematical formulation (the differential equation and the boundary and initial conditions) of this heat conduction problem is to be obtained.

Assumptions **1** Heat transfer is given to be transient and one-dimensional. **2** Thermal conductivity is given to be variable. **3** There is no heat generation in the medium. **4** The outer surface at $r = r_o$ is subjected to convection and radiation.

Analysis Noting that there is thermal symmetry about the midpoint and convection and radiation at the outer surface and expressing all temperatures in Rankine, the differential equation and the boundary conditions for this heat conduction problem can be expressed as

$$\frac{1}{r^2} \frac{\partial}{\partial r} \left(kr^2 \frac{\partial T}{\partial r} \right) = \rho c \frac{\partial T}{\partial t}$$

$$\frac{\partial T(0, t)}{\partial r} = 0$$

$$-k \frac{\partial T(r_o, t)}{\partial r} = h[T(r_o) - T_\infty] + \varepsilon \sigma [T(r_o)^4 - T_{\text{surr}}^4]$$

$$T(r, 0) = T_i$$

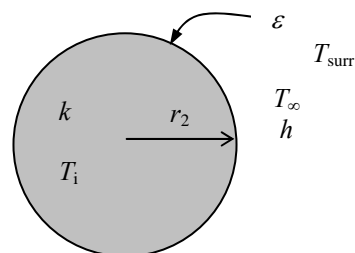

2-52 The outer surface of the East wall of a house exchanges heat with both convection and radiation, while the interior surface is subjected to convection only. Assuming the heat transfer through the wall to be steady and one-dimensional, the mathematical formulation (the differential equation and the boundary and initial conditions) of this heat conduction problem is to be obtained.

Assumptions **1** Heat transfer is given to be steady and one-dimensional. **2** Thermal conductivity is given to be constant. **3** There is no heat generation in the medium. **4** The outer surface at $x = L$ is subjected to convection and radiation while the inner surface at $x = 0$ is subjected to convection only.

Analysis Expressing all the temperatures in Kelvin, the differential equation and the boundary conditions for this heat conduction problem can be expressed as

$$\frac{d^2T}{dx^2} = 0$$

$$-k \frac{dT(0)}{dx} = h_1[T_{\infty 1} - T(0)]$$

$$-k \frac{dT(L)}{dx} = h_1[T(L) - T_{\infty 2}] + \varepsilon_2 \sigma [T(L)^4 - T_{\text{sky}}^4]$$

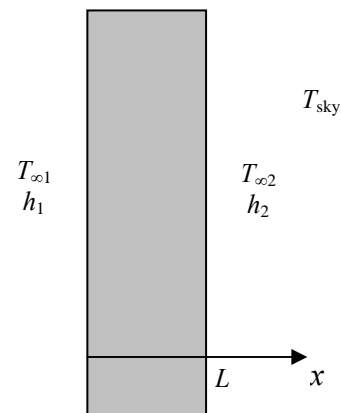

Solution of Steady One-Dimensional Heat Conduction Problems

2-53C Yes, this claim is reasonable since in the absence of any heat generation the rate of heat transfer through a plain wall in steady operation must be constant. But the value of this constant must be zero since one side of the wall is perfectly insulated. Therefore, there can be no temperature difference between different parts of the wall; that is, the temperature in a plane wall must be uniform in steady operation.

2-54C Yes, the temperature in a plane wall with constant thermal conductivity and no heat generation will vary linearly during steady one-dimensional heat conduction even when the wall loses heat by radiation from its surfaces. This is because the steady heat conduction equation in a plane wall is $d^2T/dx^2 = 0$ whose solution is $T(x) = C_1x + C_2$ regardless of the boundary conditions. The solution function represents a straight line whose slope is C_1 .

2-55C Yes, in the case of constant thermal conductivity and no heat generation, the temperature in a solid cylindrical rod whose ends are maintained at constant but different temperatures while the side surface is perfectly insulated will vary linearly during steady one-dimensional heat conduction. This is because the steady heat conduction equation in this case is $d^2T/dx^2 = 0$ whose solution is $T(x) = C_1x + C_2$ which represents a straight line whose slope is C_1 .

2-56C Yes, this claim is reasonable since no heat is entering the cylinder and thus there can be no heat transfer from the cylinder in steady operation. This condition will be satisfied only when there are no temperature differences within the cylinder and the outer surface temperature of the cylinder is the equal to the temperature of the surrounding medium.

2-57 A large plane wall is subjected to specified temperature on the left surface and convection on the right surface. The mathematical formulation, the variation of temperature, and the rate of heat transfer are to be determined for steady one-dimensional heat transfer.

Assumptions 1 Heat conduction is steady and one-dimensional. 2 Thermal conductivity is constant. 3 There is no heat generation.

Properties The thermal conductivity is given to be $k = 2.3 \text{ W/m}\cdot\text{°C}$.

Analysis (a) Taking the direction normal to the surface of the wall to be the x direction with $x = 0$ at the left surface, the mathematical formulation of this problem can be expressed as

$$\frac{d^2T}{dx^2} = 0$$

and

$$T(0) = T_1 = 90^\circ\text{C}$$

$$-k \frac{dT(L)}{dx} = h[T(L) - T_\infty]$$

(b) Integrating the differential equation twice with respect to x yields

$$\frac{dT}{dx} = C_1$$

$$T(x) = C_1x + C_2$$

where C_1 and C_2 are arbitrary constants. Applying the boundary conditions give

$$x = 0: \quad T(0) = C_1 \times 0 + C_2 \rightarrow C_2 = T_1$$

$$x = L: \quad -kC_1 = h[(C_1L + C_2) - T_\infty] \rightarrow C_1 = -\frac{h(C_2 - T_\infty)}{k + hL} \rightarrow C_1 = -\frac{h(T_1 - T_\infty)}{k + hL}$$

Substituting C_1 and C_2 into the general solution, the variation of temperature is determined to be

$$\begin{aligned} T(x) &= -\frac{h(T_1 - T_\infty)}{k + hL}x + T_1 \\ &= -\frac{(24 \text{ W/m}^2 \cdot \text{°C})(90 - 25)^\circ\text{C}}{(2.3 \text{ W/m} \cdot \text{°C}) + (24 \text{ W/m}^2 \cdot \text{°C})(0.4 \text{ m})}x + 90^\circ\text{C} \\ &= 90 - 131.1x \end{aligned}$$

(c) The rate of heat conduction through the wall is

$$\begin{aligned} \dot{Q}_{\text{wall}} &= -kA \frac{dT}{dx} = -kAC_1 = kA \frac{h(T_1 - T_\infty)}{k + hL} \\ &= (2.3 \text{ W/m} \cdot \text{°C})(30 \text{ m}^2) \frac{(24 \text{ W/m}^2 \cdot \text{°C})(90 - 25)^\circ\text{C}}{(2.3 \text{ W/m} \cdot \text{°C}) + (24 \text{ W/m}^2 \cdot \text{°C})(0.4 \text{ m})} \\ &= \mathbf{9045 \text{ W}} \end{aligned}$$

Note that under steady conditions the rate of heat conduction through a plain wall is constant.

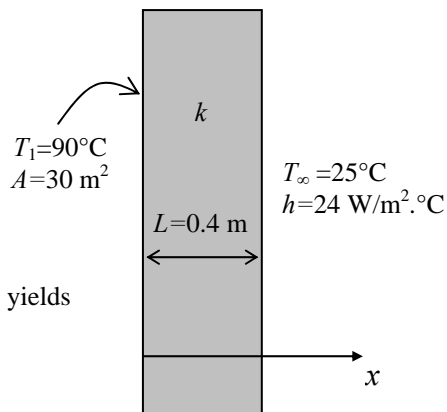

2-58 The top and bottom surfaces of a solid cylindrical rod are maintained at constant temperatures of 20°C and 95°C while the side surface is perfectly insulated. The rate of heat transfer through the rod is to be determined for the cases of copper, steel, and granite rod.

Assumptions **1** Heat conduction is steady and one-dimensional. **2** Thermal conductivity is constant. **3** There is no heat generation.

Properties The thermal conductivities are given to be $k = 380 \text{ W/m}\cdot\text{°C}$ for copper, $k = 18 \text{ W/m}\cdot\text{°C}$ for steel, and $k = 1.2 \text{ W/m}\cdot\text{°C}$ for granite.

Analysis Noting that the heat transfer area (the area normal to the direction of heat transfer) is constant, the rate of heat transfer along the rod is determined from

$$\dot{Q} = kA \frac{T_1 - T_2}{L}$$

where $L = 0.15 \text{ m}$ and the heat transfer area A is

$$A = \pi D^2 / 4 = \pi(0.05 \text{ m})^2 / 4 = 1.964 \times 10^{-3} \text{ m}^2$$

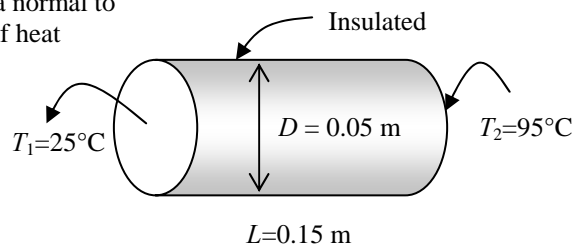

Then the heat transfer rate for each case is determined as follows:

(a) Copper:
$$\dot{Q} = kA \frac{T_1 - T_2}{L} = (380 \text{ W/m}\cdot\text{°C})(1.964 \times 10^{-3} \text{ m}^2) \frac{(95 - 20)^\circ\text{C}}{0.15 \text{ m}} = \mathbf{373.1 \text{ W}}$$

(b) Steel:
$$\dot{Q} = kA \frac{T_1 - T_2}{L} = (18 \text{ W/m}\cdot\text{°C})(1.964 \times 10^{-3} \text{ m}^2) \frac{(95 - 20)^\circ\text{C}}{0.15 \text{ m}} = \mathbf{17.7 \text{ W}}$$

(c) Granite:
$$\dot{Q} = kA \frac{T_1 - T_2}{L} = (1.2 \text{ W/m}\cdot\text{°C})(1.964 \times 10^{-3} \text{ m}^2) \frac{(95 - 20)^\circ\text{C}}{0.15 \text{ m}} = \mathbf{1.2 \text{ W}}$$

Discussion: The steady rate of heat conduction can differ by orders of magnitude, depending on the thermal conductivity of the material.

2-59 EES Prob. 2-58 is reconsidered. The rate of heat transfer as a function of the thermal conductivity of the rod is to be plotted.

Analysis The problem is solved using EES, and the solution is given below.

"GIVEN"

$$L=0.15 \text{ [m]}$$

$$D=0.05 \text{ [m]}$$

$$T_1=20 \text{ [C]}$$

$$T_2=95 \text{ [C]}$$

$$k=1.2 \text{ [W/m-C]}$$

"ANALYSIS"

$$A=\pi \cdot D^2/4$$

$$Q_{\text{dot}}=k \cdot A \cdot (T_2-T_1)/L$$

k [W/m.C]	Q [W]
1	0.9817
22	21.6
43	42.22
64	62.83
85	83.45
106	104.1
127	124.7
148	145.3
169	165.9
190	186.5
211	207.1
232	227.8
253	248.4
274	269
295	289.6
316	310.2
337	330.8
358	351.5
379	372.1
400	392.7

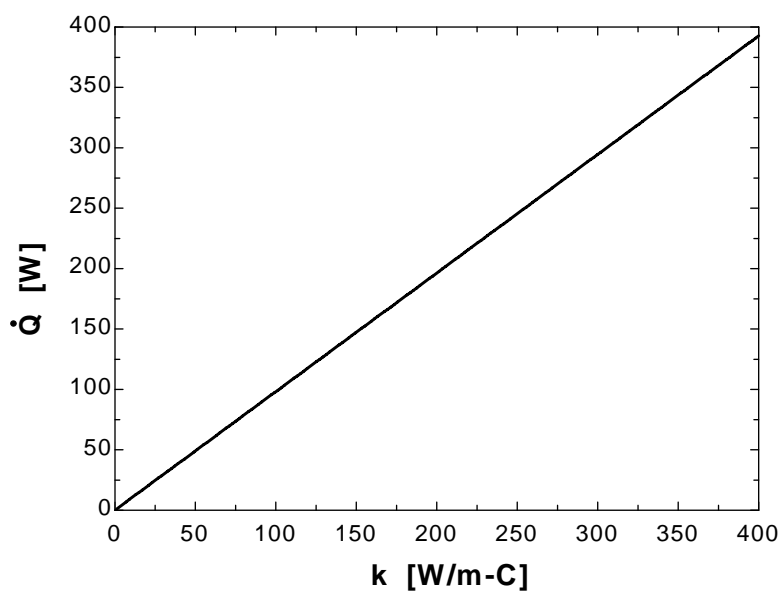

2-60 The base plate of a household iron is subjected to specified heat flux on the left surface and to specified temperature on the right surface. The mathematical formulation, the variation of temperature in the plate, and the inner surface temperature are to be determined for steady one-dimensional heat transfer.

Assumptions 1 Heat conduction is steady and one-dimensional since the surface area of the base plate is large relative to its thickness, and the thermal conditions on both sides of the plate are uniform. **2** Thermal conductivity is constant. **3** There is no heat generation in the plate. **4** Heat loss through the upper part of the iron is negligible.

Properties The thermal conductivity is given to be $k = 20 \text{ W/m}\cdot\text{°C}$.

Analysis (a) Noting that the upper part of the iron is well insulated and thus the entire heat generated in the resistance wires is transferred to the base plate, the heat flux through the inner surface is determined to be

$$\dot{q}_0 = \frac{\dot{Q}_0}{A_{\text{base}}} = \frac{800 \text{ W}}{160 \times 10^{-4} \text{ m}^2} = 50,000 \text{ W/m}^2$$

Taking the direction normal to the surface of the wall to be the x direction with $x = 0$ at the left surface, the mathematical formulation of this problem can be expressed as

$$\frac{d^2T}{dx^2} = 0$$

and $-k \frac{dT(0)}{dx} = \dot{q}_0 = 50,000 \text{ W/m}^2$

$$T(L) = T_2 = 85^\circ\text{C}$$

(b) Integrating the differential equation twice with respect to x yields

$$\frac{dT}{dx} = C_1$$

$$T(x) = C_1x + C_2$$

where C_1 and C_2 are arbitrary constants. Applying the boundary conditions give

$$x = 0: \quad -kC_1 = \dot{q}_0 \rightarrow C_1 = -\frac{\dot{q}_0}{k}$$

$$x = L: \quad T(L) = C_1L + C_2 = T_2 \rightarrow C_2 = T_2 - C_1L \rightarrow C_2 = T_2 + \frac{\dot{q}_0L}{k}$$

Substituting C_1 and C_2 into the general solution, the variation of temperature is determined to be

$$\begin{aligned} T(x) &= -\frac{\dot{q}_0}{k}x + T_2 + \frac{\dot{q}_0L}{k} = \frac{\dot{q}_0(L-x)}{k} + T_2 \\ &= \frac{(50,000 \text{ W/m}^2)(0.006 - x)\text{m}}{20 \text{ W/m}\cdot\text{°C}} + 85^\circ\text{C} \\ &= 2500(0.006 - x) + 85 \end{aligned}$$

(c) The temperature at $x = 0$ (the inner surface of the plate) is

$$T(0) = 2500(0.006 - 0) + 85 = \mathbf{100^\circ\text{C}}$$

Note that the inner surface temperature is higher than the exposed surface temperature, as expected.

2-61 The base plate of a household iron is subjected to specified heat flux on the left surface and to specified temperature on the right surface. The mathematical formulation, the variation of temperature in the plate, and the inner surface temperature are to be determined for steady one-dimensional heat transfer.

Assumptions 1 Heat conduction is steady and one-dimensional since the surface area of the base plate is large relative to its thickness, and the thermal conditions on both sides of the plate are uniform. **2** Thermal conductivity is constant. **3** There is no heat generation in the plate. **4** Heat loss through the upper part of the iron is negligible.

Properties The thermal conductivity is given to be $k = 20 \text{ W/m}\cdot\text{°C}$.

Analysis (a) Noting that the upper part of the iron is well insulated and thus the entire heat generated in the resistance wires is transferred to the base plate, the heat flux through the inner surface is determined to be

$$\dot{q}_0 = \frac{\dot{Q}_0}{A_{\text{base}}} = \frac{1200 \text{ W}}{160 \times 10^{-4} \text{ m}^2} = 75,000 \text{ W/m}^2$$

Taking the direction normal to the surface of the wall to be the x direction with $x = 0$ at the left surface, the mathematical formulation of this problem can be expressed as

$$\frac{d^2T}{dx^2} = 0$$

$$\text{and } -k \frac{dT(0)}{dx} = \dot{q}_0 = 75,000 \text{ W/m}^2$$

$$T(L) = T_2 = 85\text{°C}$$

(b) Integrating the differential equation twice with respect to x yields

$$\frac{dT}{dx} = C_1$$

$$T(x) = C_1x + C_2$$

where C_1 and C_2 are arbitrary constants. Applying the boundary conditions give

$$x = 0: \quad -kC_1 = \dot{q}_0 \rightarrow C_1 = -\frac{\dot{q}_0}{k}$$

$$x = L: \quad T(L) = C_1L + C_2 = T_2 \rightarrow C_2 = T_2 - C_1L \rightarrow C_2 = T_2 + \frac{\dot{q}_0L}{k}$$

Substituting C_1 and C_2 into the general solution, the variation of temperature is determined to be

$$\begin{aligned} T(x) &= -\frac{\dot{q}_0}{k}x + T_2 + \frac{\dot{q}_0L}{k} = \frac{\dot{q}_0(L-x)}{k} + T_2 \\ &= \frac{(75,000 \text{ W/m}^2)(0.006 - x)\text{m}}{20 \text{ W/m}\cdot\text{°C}} + 85\text{°C} \\ &= 3750(0.006 - x) + 85 \end{aligned}$$

(c) The temperature at $x = 0$ (the inner surface of the plate) is

$$T(0) = 3750(0.006 - 0) + 85 = \mathbf{107.5\text{°C}}$$

Note that the inner surface temperature is higher than the exposed surface temperature, as expected.

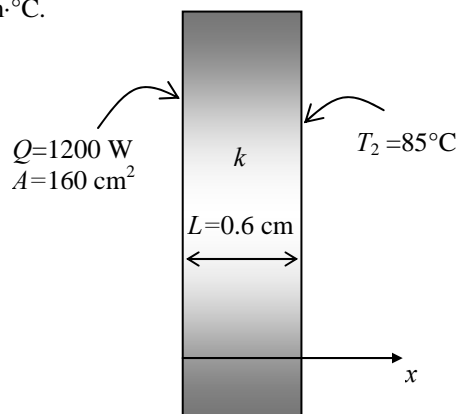

2-62 EES Prob. 2-60 is reconsidered. The temperature as a function of the distance is to be plotted.

Analysis The problem is solved using EES, and the solution is given below.

"GIVEN"

$$Q_{\text{dot}}=800 \text{ [W]}$$

$$L=0.006 \text{ [m]}$$

$$A_{\text{base}}=160\text{E-}4 \text{ [m}^2\text{]}$$

$$k=20 \text{ [W/m-C]}$$

$$T_2=85 \text{ [C]}$$

"ANALYSIS"

$$q_{\text{dot}_0}=Q_{\text{dot}}/A_{\text{base}}$$

$$T=q_{\text{dot}_0}*(L-x)/k+T_2 \text{ "Variation of temperature"}$$

"x is the parameter to be varied"

x [m]	T [C]
0	100
0.0006667	98.33
0.001333	96.67
0.002	95
0.002667	93.33
0.003333	91.67
0.004	90
0.004667	88.33
0.005333	86.67
0.006	85

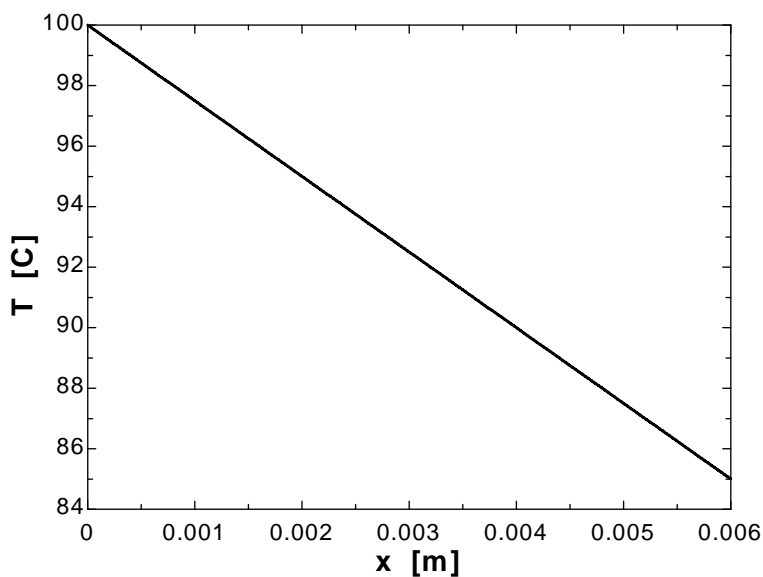

2-63 Chilled water flows in a pipe that is well insulated from outside. The mathematical formulation and the variation of temperature in the pipe are to be determined for steady one-dimensional heat transfer.

Assumptions 1 Heat conduction is steady and one-dimensional since the pipe is long relative to its thickness, and there is thermal symmetry about the center line. **2** Thermal conductivity is constant. **3** There is no heat generation in the pipe.

Analysis (a) Noting that heat transfer is one-dimensional in the radial r direction, the mathematical formulation of this problem can be expressed as

$$\frac{d}{dr} \left(r \frac{dT}{dr} \right) = 0$$

and
$$-k \frac{dT(r_1)}{dr} = h[T_f - T(r_1)]$$

$$\frac{dT(r_2)}{dr} = 0$$

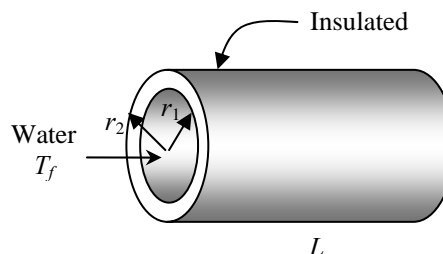

(b) Integrating the differential equation once with respect to r gives

$$r \frac{dT}{dr} = C_1$$

Dividing both sides of the equation above by r to bring it to a readily integrable form and then integrating,

$$\frac{dT}{dr} = \frac{C_1}{r}$$

$$T(r) = C_1 \ln r + C_2$$

where C_1 and C_2 are arbitrary constants. Applying the boundary conditions give

$$r = r_2: \quad \frac{C_1}{r_2} = 0 \rightarrow C_1 = 0$$

$$r = r_1: \quad -k \frac{C_1}{r_1} = h[T_f - (C_1 \ln r_1 + C_2)]$$

$$0 = h(T_f - C_2) \rightarrow C_2 = T_f$$

Substituting C_1 and C_2 into the general solution, the variation of temperature is determined to be

$$T(r) = T_f$$

This result is not surprising since steady operating conditions exist.

2-64E A steam pipe is subjected to convection on the inner surface and to specified temperature on the outer surface. The mathematical formulation, the variation of temperature in the pipe, and the rate of heat loss are to be determined for steady one-dimensional heat transfer.

Assumptions 1 Heat conduction is steady and one-dimensional since the pipe is long relative to its thickness, and there is thermal symmetry about the center line. **2** Thermal conductivity is constant. **3** There is no heat generation in the pipe.

Properties The thermal conductivity is given to be $k = 7.2 \text{ Btu/h}\cdot\text{ft}\cdot^\circ\text{F}$.

Analysis (a) Noting that heat transfer is one-dimensional in the radial r direction, the mathematical formulation of this problem can be expressed as

$$\frac{d}{dr} \left(r \frac{dT}{dr} \right) = 0$$

$$\text{and } -k \frac{dT(r_1)}{dr} = h[T_\infty - T(r_1)]$$

$$T(r_2) = T_2 = 160^\circ\text{F}$$

(b) Integrating the differential equation once with respect to r gives

$$r \frac{dT}{dr} = C_1$$

Dividing both sides of the equation above by r to bring it to a readily integrable form and then integrating,

$$\frac{dT}{dr} = \frac{C_1}{r}$$

$$T(r) = C_1 \ln r + C_2$$

where C_1 and C_2 are arbitrary constants. Applying the boundary conditions give

$$r = r_1: \quad -k \frac{C_1}{r_1} = h[T_\infty - (C_1 \ln r_1 + C_2)]$$

$$r = r_2: \quad T(r_2) = C_1 \ln r_2 + C_2 = T_2$$

Solving for C_1 and C_2 simultaneously gives

$$C_1 = \frac{T_2 - T_\infty}{\ln \frac{r_2}{r_1} + \frac{k}{hr_1}} \quad \text{and} \quad C_2 = T_2 - C_1 \ln r_2 = T_2 - \frac{T_2 - T_\infty}{\ln \frac{r_2}{r_1} + \frac{k}{hr_1}} \ln r_2$$

Substituting C_1 and C_2 into the general solution, the variation of temperature is determined to be

$$\begin{aligned} T(r) &= C_1 \ln r + T_2 - C_1 \ln r_2 = C_1 (\ln r - \ln r_2) + T_2 = \frac{T_2 - T_\infty}{\ln \frac{r_2}{r_1} + \frac{k}{hr_1}} \ln \frac{r}{r_2} + T_2 \\ &= \frac{(160 - 250)^\circ\text{F}}{\ln \frac{2.4}{2} + \frac{7.2 \text{ Btu/h}\cdot\text{ft}\cdot^\circ\text{F}}{(12.5 \text{ Btu/h}\cdot\text{ft}^2\cdot^\circ\text{F})(2/12 \text{ ft})}} \ln \frac{r}{2.4 \text{ in}} + 160^\circ\text{F} = -24.74 \ln \frac{r}{2.4 \text{ in}} + 160^\circ\text{F} \end{aligned}$$

(c) The rate of heat conduction through the pipe is

$$\begin{aligned} \dot{Q} &= -kA \frac{dT}{dr} = -k(2\pi rL) \frac{C_1}{r} = -2\pi Lk \frac{T_2 - T_\infty}{\ln \frac{r_2}{r_1} + \frac{k}{hr_1}} \\ &= -2\pi(30 \text{ ft})(7.2 \text{ Btu/h}\cdot\text{ft}\cdot^\circ\text{F}) \frac{(160 - 250)^\circ\text{F}}{\ln \frac{2.4}{2} + \frac{7.2 \text{ Btu/h}\cdot\text{ft}\cdot^\circ\text{F}}{(12.5 \text{ Btu/h}\cdot\text{ft}^2\cdot^\circ\text{F})(2/12 \text{ ft})}} = \mathbf{33,600 \text{ Btu/h}} \end{aligned}$$

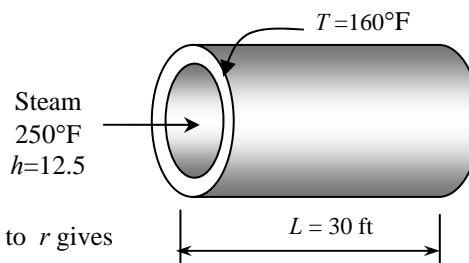

2-65 A spherical container is subjected to specified temperature on the inner surface and convection on the outer surface. The mathematical formulation, the variation of temperature, and the rate of heat transfer are to be determined for steady one-dimensional heat transfer.

Assumptions 1 Heat conduction is steady and one-dimensional since there is no change with time and there is thermal symmetry about the midpoint. **2** Thermal conductivity is constant. **3** There is no heat generation.

Properties The thermal conductivity is given to be $k = 30 \text{ W/m}\cdot\text{C}$.

Analysis (a) Noting that heat transfer is one-dimensional in the radial r direction, the mathematical formulation of this problem can be expressed as

$$\frac{d}{dr} \left(r^2 \frac{dT}{dr} \right) = 0$$

and $T(r_1) = T_1 = 0^\circ\text{C}$

$$-k \frac{dT(r_2)}{dr} = h[T(r_2) - T_\infty]$$

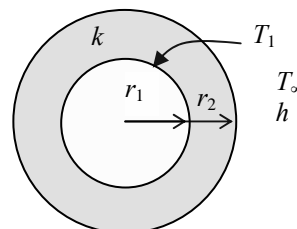

(b) Integrating the differential equation once with respect to r gives

$$r^2 \frac{dT}{dr} = C_1$$

Dividing both sides of the equation above by r to bring it to a readily integrable form and then integrating,

$$\frac{dT}{dr} = \frac{C_1}{r^2}$$

$$T(r) = -\frac{C_1}{r} + C_2$$

where C_1 and C_2 are arbitrary constants. Applying the boundary conditions give

$$r = r_1: \quad T(r_1) = -\frac{C_1}{r_1} + C_2 = T_1$$

$$r = r_2: \quad -k \frac{C_1}{r_2^2} = h \left(-\frac{C_1}{r_2} + C_2 - T_\infty \right)$$

Solving for C_1 and C_2 simultaneously gives

$$C_1 = \frac{r_2(T_1 - T_\infty)}{1 - \frac{r_2}{r_1} - \frac{k}{hr_2}} \quad \text{and} \quad C_2 = T_1 + \frac{C_1}{r_1} = T_1 + \frac{T_1 - T_\infty}{1 - \frac{r_2}{r_1} - \frac{k}{hr_2}} \frac{r_2}{r_1}$$

Substituting C_1 and C_2 into the general solution, the variation of temperature is determined to be

$$\begin{aligned} T(r) &= -\frac{C_1}{r} + T_1 + \frac{C_1}{r_1} = C_1 \left(\frac{1}{r_1} - \frac{1}{r} \right) + T_1 = \frac{T_1 - T_\infty}{1 - \frac{r_2}{r_1} - \frac{k}{hr_2}} \left(\frac{r_2}{r_1} - \frac{r_2}{r} \right) + T_1 \\ &= \frac{(0 - 25)^\circ\text{C}}{1 - \frac{2.1}{2} - \frac{30 \text{ W/m}\cdot\text{C}}{(18 \text{ W/m}^2 \cdot \text{C})(2.1 \text{ m})}} \left(\frac{2.1}{2} - \frac{2.1}{r} \right) + 0^\circ\text{C} = 29.63(1.05 - 2.1/r) \end{aligned}$$

(c) The rate of heat conduction through the wall is

$$\begin{aligned} \dot{Q} &= -kA \frac{dT}{dr} = -k(4\pi r^2) \frac{C_1}{r^2} = -4\pi k C_1 = -4\pi k \frac{r_2(T_1 - T_\infty)}{1 - \frac{r_2}{r_1} - \frac{k}{hr_2}} \\ &= -4\pi(30 \text{ W/m}\cdot\text{C}) \frac{(2.1 \text{ m})(0 - 25)^\circ\text{C}}{1 - \frac{2.1}{2} - \frac{30 \text{ W/m}\cdot\text{C}}{(18 \text{ W/m}^2 \cdot \text{C})(2.1 \text{ m})}} = \mathbf{23,460 \text{ W}} \end{aligned}$$

2-66 A large plane wall is subjected to specified heat flux and temperature on the left surface and no conditions on the right surface. The mathematical formulation, the variation of temperature in the plate, and the right surface temperature are to be determined for steady one-dimensional heat transfer.

Assumptions 1 Heat conduction is steady and one-dimensional since the wall is large relative to its thickness, and the thermal conditions on both sides of the wall are uniform. **2** Thermal conductivity is constant. **3** There is no heat generation in the wall.

Properties The thermal conductivity is given to be $k = 2.5 \text{ W/m}\cdot\text{°C}$.

Analysis (a) Taking the direction normal to the surface of the wall to be the x direction with $x = 0$ at the left surface, the mathematical formulation of this problem can be expressed as

$$\frac{d^2T}{dx^2} = 0$$

and
$$-k \frac{dT(0)}{dx} = \dot{q}_0 = 700 \text{ W/m}^2$$

$$T(0) = T_1 = 80^\circ\text{C}$$

(b) Integrating the differential equation twice with respect to x yields

$$\frac{dT}{dx} = C_1$$

$$T(x) = C_1x + C_2$$

where C_1 and C_2 are arbitrary constants. Applying the boundary conditions give

Heat flux at $x = 0$:
$$-kC_1 = \dot{q}_0 \rightarrow C_1 = -\frac{\dot{q}_0}{k}$$

Temperature at $x = 0$:
$$T(0) = C_1 \times 0 + C_2 = T_1 \rightarrow C_2 = T_1$$

Substituting C_1 and C_2 into the general solution, the variation of temperature is determined to be

$$T(x) = -\frac{\dot{q}_0}{k}x + T_1 = -\frac{700 \text{ W/m}^2}{2.5 \text{ W/m}\cdot\text{°C}}x + 80^\circ\text{C} = -280x + 80$$

(c) The temperature at $x = L$ (the right surface of the wall) is

$$T(L) = -280 \times (0.3 \text{ m}) + 80 = \mathbf{-4^\circ\text{C}}$$

Note that the right surface temperature is lower as expected.

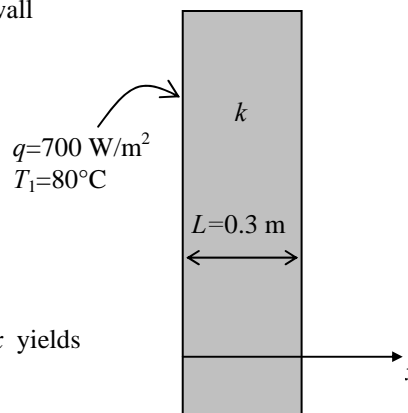

2-67 A large plane wall is subjected to specified heat flux and temperature on the left surface and no conditions on the right surface. The mathematical formulation, the variation of temperature in the plate, and the right surface temperature are to be determined for steady one-dimensional heat transfer.

Assumptions 1 Heat conduction is steady and one-dimensional since the wall is large relative to its thickness, and the thermal conditions on both sides of the wall are uniform. **2** Thermal conductivity is constant. **3** There is no heat generation in the wall.

Properties The thermal conductivity is given to be $k = 2.5 \text{ W/m}\cdot\text{C}$.

Analysis (a) Taking the direction normal to the surface of the wall to be the x direction with $x = 0$ at the left surface, the mathematical formulation of this problem can be expressed as

$$\frac{d^2T}{dx^2} = 0$$

and $-k \frac{dT(0)}{dx} = \dot{q}_0 = 1050 \text{ W/m}^2$

$$T(0) = T_1 = 90^\circ\text{C}$$

(b) Integrating the differential equation twice with respect to x yields

$$\frac{dT}{dx} = C_1$$

$$T(x) = C_1x + C_2$$

where C_1 and C_2 are arbitrary constants. Applying the boundary conditions give

Heat flux at $x = 0$: $-kC_1 = \dot{q}_0 \rightarrow C_1 = -\frac{\dot{q}_0}{k}$

Temperature at $x = 0$: $T(0) = C_1 \times 0 + C_2 = T_1 \rightarrow C_2 = T_1$

Substituting C_1 and C_2 into the general solution, the variation of temperature is determined to be

$$T(x) = -\frac{\dot{q}_0}{k}x + T_1 = -\frac{1050 \text{ W/m}^2}{2.5 \text{ W/m}\cdot\text{C}}x + 90^\circ\text{C} = -420x + 90$$

(c) The temperature at $x = L$ (the right surface of the wall) is

$$T(L) = -420 \times (0.3 \text{ m}) + 90 = \mathbf{-36^\circ\text{C}}$$

Note that the right surface temperature is lower as expected.

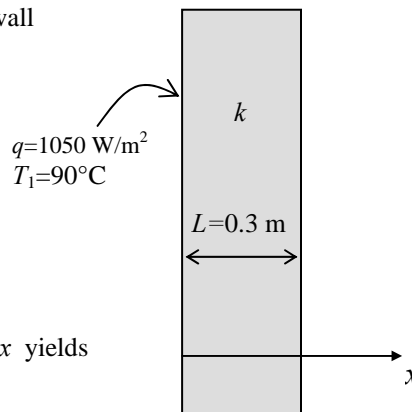

2-68E A large plate is subjected to convection, radiation, and specified temperature on the top surface and no conditions on the bottom surface. The mathematical formulation, the variation of temperature in the plate, and the bottom surface temperature are to be determined for steady one-dimensional heat transfer.

Assumptions 1 Heat conduction is steady and one-dimensional since the plate is large relative to its thickness, and the thermal conditions on both sides of the plate are uniform. **2** Thermal conductivity is constant. **3** There is no heat generation in the plate.

Properties The thermal conductivity and emissivity are given to be $k = 7.2 \text{ Btu/h}\cdot\text{ft}\cdot^\circ\text{F}$ and $\varepsilon = 0.7$.

Analysis (a) Taking the direction normal to the surface of the plate to be the x direction with $x = 0$ at the bottom surface, and the mathematical formulation of this problem can be expressed as

$$\frac{d^2T}{dx^2} = 0$$

$$\text{and } -k \frac{dT(L)}{dx} = h[T(L) - T_\infty] + \varepsilon\sigma[T(L)^4 - T_{\text{sky}}^4] = h[T_2 - T_\infty] + \varepsilon\sigma[(T_2 + 460)^4 - T_{\text{sky}}^4]$$

$$T(L) = T_2 = 75^\circ\text{F}$$

(b) Integrating the differential equation twice with respect to x yields

$$\frac{dT}{dx} = C_1$$

$$T(x) = C_1x + C_2$$

where C_1 and C_2 are arbitrary constants. Applying the boundary conditions give

$$\begin{aligned} \text{Convection at } x = L: \quad & -kC_1 = h[T_2 - T_\infty] + \varepsilon\sigma[(T_2 + 460)^4 - T_{\text{sky}}^4] \\ \rightarrow C_1 = & -\{h[T_2 - T_\infty] + \varepsilon\sigma[(T_2 + 460)^4 - T_{\text{sky}}^4]\} / k \end{aligned}$$

$$\text{Temperature at } x = L: \quad T(L) = C_1 \times L + C_2 = T_2 \rightarrow C_2 = T_2 - C_1L$$

Substituting C_1 and C_2 into the general solution, the variation of temperature is determined to be

$$\begin{aligned} T(x) &= C_1x + (T_2 - C_1L) = T_2 - (L-x)C_1 = T_2 + \frac{h[T_2 - T_\infty] + \varepsilon\sigma[(T_2 + 460)^4 - T_{\text{sky}}^4]}{k}(L-x) \\ &= 75^\circ\text{F} + \frac{(12 \text{ Btu/h}\cdot\text{ft}^2\cdot^\circ\text{F})(75 - 90)^\circ\text{F} + 0.7(0.1714 \times 10^{-8} \text{ Btu/h}\cdot\text{ft}^2\cdot\text{R}^4)[(535 \text{ R})^4 - (480 \text{ R})^4]}{7.2 \text{ Btu/h}\cdot\text{ft}\cdot^\circ\text{F}}(4/12 - x) \text{ ft} \\ &= 75 - 20.2(1/3 - x) \end{aligned}$$

(c) The temperature at $x = 0$ (the bottom surface of the plate) is

$$T(0) = 75 - 20.2 \times (1/3 - 0) = \mathbf{68.3^\circ\text{F}}$$

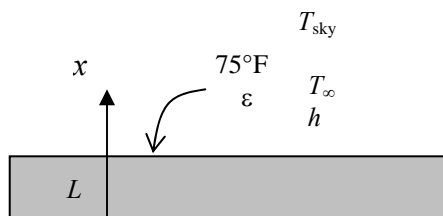

2-69E A large plate is subjected to convection and specified temperature on the top surface and no conditions on the bottom surface. The mathematical formulation, the variation of temperature in the plate, and the bottom surface temperature are to be determined for steady one-dimensional heat transfer.

Assumptions 1 Heat conduction is steady and one-dimensional since the plate is large relative to its thickness, and the thermal conditions on both sides of the plate are uniform. **2** Thermal conductivity is constant. **3** There is no heat generation in the plate.

Properties The thermal conductivity is given to be $k = 7.2 \text{ Btu/h}\cdot\text{ft}\cdot^\circ\text{F}$.

Analysis (a) Taking the direction normal to the surface of the plate to be the x direction with $x = 0$ at the bottom surface, the mathematical formulation of this problem can be expressed as

$$\frac{d^2 T}{dx^2} = 0$$

and
$$-k \frac{dT(L)}{dx} = h[T(L) - T_\infty] = h(T_2 - T_\infty)$$

$$T(L) = T_2 = 75^\circ\text{F}$$

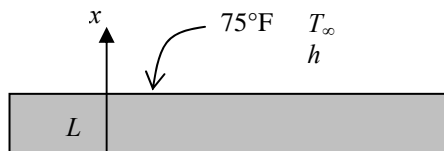

(b) Integrating the differential equation twice with respect to x yields

$$\frac{dT}{dx} = C_1$$

$$T(x) = C_1 x + C_2$$

where C_1 and C_2 are arbitrary constants. Applying the boundary conditions give

Convection at $x = L$: $-kC_1 = h(T_2 - T_\infty) \rightarrow C_1 = -h(T_2 - T_\infty)/k$

Temperature at $x = L$: $T(L) = C_1 \times L + C_2 = T_2 \rightarrow C_2 = T_2 - C_1 L$

Substituting C_1 and C_2 into the general solution, the variation of temperature is determined to be

$$\begin{aligned} T(x) &= C_1 x + (T_2 - C_1 L) = T_2 - (L - x)C_1 = T_2 + \frac{h(T_2 - T_\infty)}{k}(L - x) \\ &= 75^\circ\text{F} + \frac{(12 \text{ Btu/h}\cdot\text{ft}^2\cdot^\circ\text{F})(75 - 90)^\circ\text{F}}{7.2 \text{ Btu/h}\cdot\text{ft}\cdot^\circ\text{F}}(4/12 - x) \text{ ft} \\ &= 75 - 25(1/3 - x) \end{aligned}$$

(c) The temperature at $x = 0$ (the bottom surface of the plate) is

$$T(0) = 75 - 25 \times (1/3 - 0) = \mathbf{66.7^\circ\text{F}}$$

2-70 A compressed air pipe is subjected to uniform heat flux on the outer surface and convection on the inner surface. The mathematical formulation, the variation of temperature in the pipe, and the surface temperatures are to be determined for steady one-dimensional heat transfer.

Assumptions 1 Heat conduction is steady and one-dimensional since the pipe is long relative to its thickness, and there is thermal symmetry about the center line. **2** Thermal conductivity is constant. **3** There is no heat generation in the pipe.

Properties The thermal conductivity is given to be $k = 14 \text{ W/m}\cdot\text{C}$.

Analysis (a) Noting that the 85% of the 300 W generated by the strip heater is transferred to the pipe, the heat flux through the outer surface is determined to be

$$\dot{q}_s = \frac{\dot{Q}_s}{A_2} = \frac{\dot{Q}_s}{2\pi r_2 L} = \frac{0.85 \times 300 \text{ W}}{2\pi(0.04 \text{ m})(6 \text{ m})} = 169.1 \text{ W/m}^2$$

Noting that heat transfer is one-dimensional in the radial r direction and heat flux is in the negative r direction, the mathematical formulation of this problem can be expressed as

$$\frac{d}{dr} \left(r \frac{dT}{dr} \right) = 0$$

$$\text{and} \quad -k \frac{dT(r_1)}{dr} = h[T_\infty - T(r_1)]$$

$$k \frac{dT(r_2)}{dr} = \dot{q}_s$$

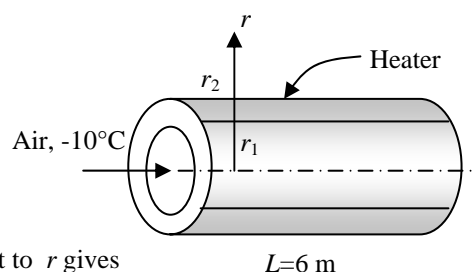

(b) Integrating the differential equation once with respect to r gives

$$r \frac{dT}{dr} = C_1$$

Dividing both sides of the equation above by r to bring it to a readily integrable form and then integrating,

$$\frac{dT}{dr} = \frac{C_1}{r}$$

$$T(r) = C_1 \ln r + C_2$$

where C_1 and C_2 are arbitrary constants. Applying the boundary conditions give

$$r = r_2: \quad k \frac{C_1}{r_2} = \dot{q}_s \rightarrow C_1 = \frac{\dot{q}_s r_2}{k}$$

$$r = r_1: \quad -k \frac{C_1}{r_1} = h[T_\infty - (C_1 \ln r_1 + C_2)] \rightarrow C_2 = T_\infty - \left(\ln r_1 - \frac{k}{hr_1} \right) C_1 = T_\infty - \left(\ln r_1 - \frac{k}{hr_1} \right) \frac{\dot{q}_s r_2}{k}$$

Substituting C_1 and C_2 into the general solution, the variation of temperature is determined to be

$$\begin{aligned} T(r) &= C_1 \ln r + T_\infty - \left(\ln r_1 - \frac{k}{hr_1} \right) C_1 = T_\infty + \left(\ln r - \ln r_1 + \frac{k}{hr_1} \right) C_1 = T_\infty + \left(\ln \frac{r}{r_1} + \frac{k}{hr_1} \right) \frac{\dot{q}_s r_2}{k} \\ &= -10^\circ\text{C} + \left(\ln \frac{r}{r_1} + \frac{14 \text{ W/m}\cdot\text{C}}{(30 \text{ W/m}^2\cdot\text{C})(0.037 \text{ m})} \right) \frac{(169.1 \text{ W/m}^2)(0.04 \text{ m})}{14 \text{ W/m}\cdot\text{C}} = -10 + 0.483 \left(\ln \frac{r}{r_1} + 12.61 \right) \end{aligned}$$

(c) The inner and outer surface temperatures are determined by direct substitution to be

$$\text{Inner surface } (r = r_1): \quad T(r_1) = -10 + 0.483 \left(\ln \frac{r_1}{r_1} + 12.61 \right) = -10 + 0.483(0 + 12.61) = -3.91^\circ\text{C}$$

$$\text{Outer surface } (r = r_2): \quad T(r_2) = -10 + 0.483 \left(\ln \frac{r_2}{r_1} + 12.61 \right) = -10 + 0.483 \left(\ln \frac{0.04}{0.037} + 12.61 \right) = -3.87^\circ\text{C}$$

Note that the pipe is essentially isothermal at a temperature of about -3.9°C .

2-71 EES Prob. 2-70 is reconsidered. The temperature as a function of the radius is to be plotted.

Analysis The problem is solved using EES, and the solution is given below.

"GIVEN"

L=6 [m]
 r_1=0.037 [m]
 r_2=0.04 [m]
 k=14 [W/m-C]
 Q_dot=300 [W]
 T_infinity=-10 [C]
 h=30 [W/m^2-C]
 f_loss=0.15

"ANALYSIS"

$q_{dot_s} = ((1 - f_{loss}) * Q_{dot}) / A$

$A = 2 * \pi * r_2 * L$

$T = T_{infinity} + (\ln(r/r_1) + k/(h*r_1)) * (q_{dot_s} * r_2) / k$ "Variation of temperature"

"r is the parameter to be varied"

r [m]	T [C]
0.037	3.906
0.03733	3.902
0.03767	3.898
0.038	3.893
0.03833	3.889
0.03867	3.885
0.039	3.881
0.03933	3.877
0.03967	3.873
0.04	3.869

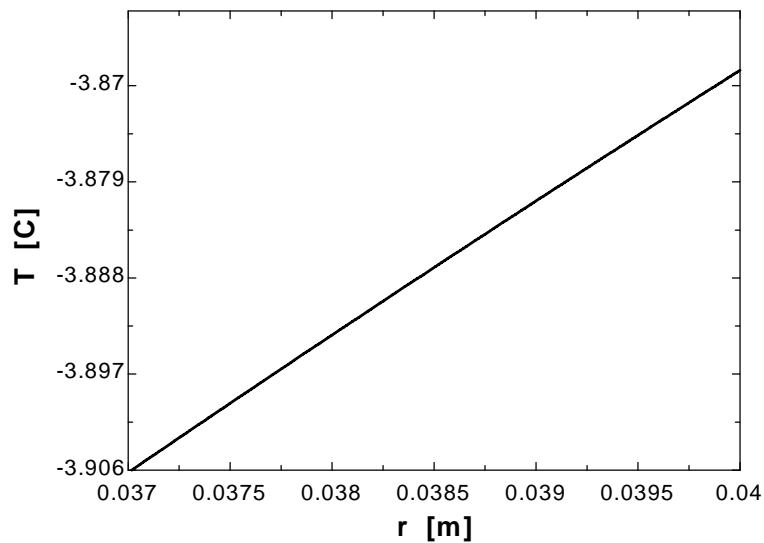

2-72 A spherical container is subjected to uniform heat flux on the outer surface and specified temperature on the inner surface. The mathematical formulation, the variation of temperature in the pipe, and the outer surface temperature, and the maximum rate of hot water supply are to be determined for steady one-dimensional heat transfer.

Assumptions 1 Heat conduction is steady and one-dimensional since there is no change with time and there is thermal symmetry about the mid point. **2** Thermal conductivity is constant. **3** There is no heat generation in the container.

Properties The thermal conductivity is given to be $k = 1.5 \text{ W/m}\cdot^\circ\text{C}$. The specific heat of water at the average temperature of $(100+20)/2 = 60^\circ\text{C}$ is $4.185 \text{ kJ/kg}\cdot^\circ\text{C}$ (Table A-9).

Analysis (a) Noting that the 90% of the 500 W generated by the strip heater is transferred to the container, the heat flux through the outer surface is determined to be

$$\dot{q}_s = \frac{\dot{Q}_s}{A_2} = \frac{\dot{Q}_s}{4\pi r_2^2} = \frac{0.90 \times 500 \text{ W}}{4\pi(0.41 \text{ m})^2} = 213.0 \text{ W/m}^2$$

Noting that heat transfer is one-dimensional in the radial r direction and heat flux is in the negative r direction, the mathematical formulation of this problem can be expressed as

$$\frac{d}{dr} \left(r^2 \frac{dT}{dr} \right) = 0$$

and $T(r_1) = T_1 = 100^\circ\text{C}$

$$k \frac{dT(r_2)}{dr} = \dot{q}_s$$

(b) Integrating the differential equation once with respect to r gives

$$r^2 \frac{dT}{dr} = C_1$$

Dividing both sides of the equation above by r^2 and then integrating,

$$\frac{dT}{dr} = \frac{C_1}{r^2}$$

$$T(r) = -\frac{C_1}{r} + C_2$$

where C_1 and C_2 are arbitrary constants. Applying the boundary conditions give

$$r = r_2: \quad k \frac{C_1}{r_2^2} = \dot{q}_s \rightarrow C_1 = \frac{\dot{q}_s r_2^2}{k}$$

$$r = r_1: \quad T(r_1) = T_1 = -\frac{C_1}{r_1} + C_2 \rightarrow C_2 = T_1 + \frac{C_1}{r_1} = T_1 + \frac{\dot{q}_s r_2^2}{kr_1}$$

Substituting C_1 and C_2 into the general solution, the variation of temperature is determined to be

$$\begin{aligned} T(r) &= -\frac{C_1}{r} + C_2 = -\frac{C_1}{r} + T_1 + \frac{C_1}{r_1} = T_1 + \left(\frac{1}{r_1} - \frac{1}{r} \right) C_1 = T_1 + \left(\frac{1}{r_1} - \frac{1}{r} \right) \frac{\dot{q}_s r_2^2}{k} \\ &= 100^\circ\text{C} + \left(\frac{1}{0.40 \text{ m}} - \frac{1}{r} \right) \frac{(213 \text{ W/m}^2)(0.41 \text{ m})^2}{1.5 \text{ W/m}\cdot^\circ\text{C}} = 100 + 23.87 \left(2.5 - \frac{1}{r} \right) \end{aligned}$$

(c) The outer surface temperature is determined by direct substitution to be

$$\text{Outer surface } (r = r_2): \quad T(r_2) = 100 + 23.87 \left(2.5 - \frac{1}{r_2} \right) = 100 + 23.87 \left(2.5 - \frac{1}{0.41} \right) = \mathbf{101.5^\circ\text{C}}$$

Noting that the maximum rate of heat supply to the water is $0.9 \times 500 \text{ W} = 450 \text{ W}$, water can be heated from 20 to 100°C at a rate of

$$\dot{Q} = \dot{m} c_p \Delta T \rightarrow \dot{m} = \frac{\dot{Q}}{c_p \Delta T} = \frac{0.450 \text{ kJ/s}}{(4.185 \text{ kJ/kg}\cdot^\circ\text{C})(100 - 20)^\circ\text{C}} = 0.00134 \text{ kg/s} = \mathbf{4.84 \text{ kg/h}}$$

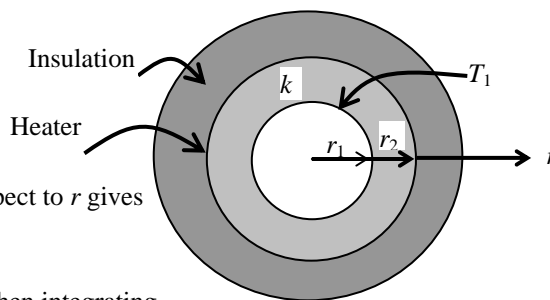

2-73 EES Prob. 2-72 is reconsidered. The temperature as a function of the radius is to be plotted.

Analysis The problem is solved using EES, and the solution is given below.

"GIVEN"

r_1=0.40 [m]
 r_2=0.41 [m]
 k=1.5 [W/m-C]
 T_1=100 [C]
 Q_dot=500 [W]
 f_loss=0.10

"ANALYSIS"

q_dot_s=((1-f_loss)*Q_dot)/A

A=4*pi*r_2^2

T=T_1+(1/r_1-1/r)*(q_dot_s*r_2^2)/k "Variation of temperature"

r [m]	T [C]
0.4	100
0.4011	100.2
0.4022	100.3
0.4033	100.5
0.4044	100.7
0.4056	100.8
0.4067	101
0.4078	101.1
0.4089	101.3
0.41	101.5

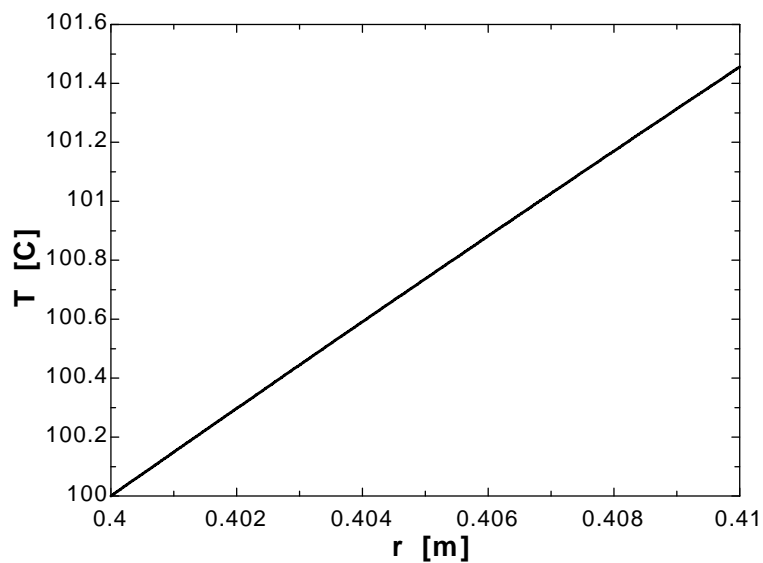

Heat Generation in Solids

2-74C No. Heat generation in a solid is simply the conversion of some form of energy into sensible heat energy. For example resistance heating in wires is conversion of electrical energy to heat.

2-75C Heat generation in a solid is simply conversion of some form of energy into sensible heat energy. Some examples of heat generations are resistance heating in wires, exothermic chemical reactions in a solid, and nuclear reactions in nuclear fuel rods.

2-76C The rate of heat generation inside an iron becomes equal to the rate of heat loss from the iron when steady operating conditions are reached and the temperature of the iron stabilizes.

2-77C No, it is not possible since the highest temperature in the plate will occur at its center, and heat cannot flow “uphill.”

2-78C The cylinder will have a higher center temperature since the cylinder has less surface area to lose heat from per unit volume than the sphere.

2-79 A 2-kW resistance heater wire with a specified surface temperature is used to boil water. The center temperature of the wire is to be determined.

Assumptions **1** Heat transfer is steady since there is no change with time. **2** Heat transfer is one-dimensional since there is thermal symmetry about the center line and no change in the axial direction. **3** Thermal conductivity is constant. **4** Heat generation in the heater is uniform.

Properties The thermal conductivity is given to be $k = 20 \text{ W/m}\cdot\text{C}$.

Analysis The resistance heater converts electric energy into heat at a rate of 2 kW. The rate of heat generation per unit volume of the wire is

$$\dot{e}_{\text{gen}} = \frac{\dot{E}_{\text{gen}}}{V_{\text{wire}}} = \frac{\dot{E}_{\text{gen}}}{\pi r_o^2 L} = \frac{2000 \text{ W}}{\pi (0.002 \text{ m})^2 (0.9 \text{ m})} = 1.768 \times 10^8 \text{ W/m}^3$$

The center temperature of the wire is then determined from Eq. 2-71 to be

$$T_o = T_s + \frac{\dot{e}_{\text{gen}} r_o^2}{4k} = 110^\circ\text{C} + \frac{(1.768 \times 10^8 \text{ W/m}^3)(0.002 \text{ m})^2}{4(20 \text{ W/m}\cdot\text{C})} = \mathbf{118.8^\circ\text{C}}$$

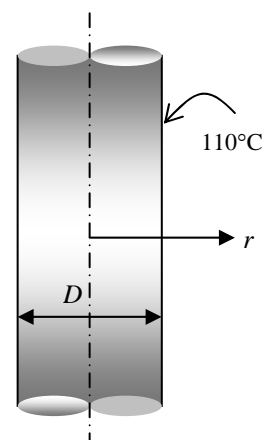

2-80 Heat is generated in a long solid cylinder with a specified surface temperature. The variation of temperature in the cylinder is given by

$$T(r) = \frac{\dot{e}_{\text{gen}} r_o^2}{k} \left[1 - \left(\frac{r}{r_o} \right)^2 \right] + T_s$$

(a) Heat conduction is steady since there is no time t variable involved.

(b) Heat conduction is a one-dimensional.

(c) Using Eq. (1), the heat flux on the surface of the cylinder at $r = r_o$ is determined from its definition to be

$$\begin{aligned} \dot{q}_s &= -k \frac{dT(r_o)}{dr} = -k \left[\frac{\dot{e}_{\text{gen}} r_o^2}{k} \left(-\frac{2r}{r_o^2} \right) \right]_{r=r_o} \\ &= -k \left[\frac{\dot{e}_{\text{gen}} r_o^2}{k} \left(-\frac{2r_o}{r_o^2} \right) \right] = 2\dot{e}_{\text{gen}} r_o = 2(35 \text{ W/cm}^3)(4 \text{ cm}) = \mathbf{280 \text{ W/cm}^2} \end{aligned}$$

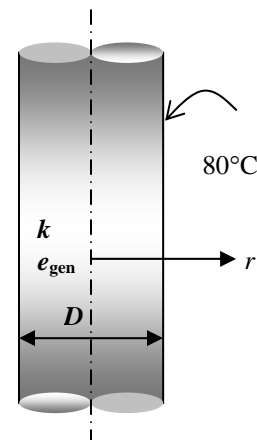

2-81 EES Prob. 2-80 is reconsidered. The temperature as a function of the radius is to be plotted.

Analysis The problem is solved using EES, and the solution is given below.

"GIVEN"

$r_0=0.04$ [m]

$k=25$ [W/m-C]

$g_dot_0=35E+6$ [W/m³]

$T_s=80$ [C]

"ANALYSIS"

$T=(g_dot_0*r_0^2)/k*(1-(r/r_0)^2)+T_s$ "Variation of temperature"

r [m]	T [C]
0	2320
0.004444	2292
0.008889	2209
0.01333	2071
0.01778	1878
0.02222	1629
0.02667	1324
0.03111	964.9
0.03556	550.1
0.04	80

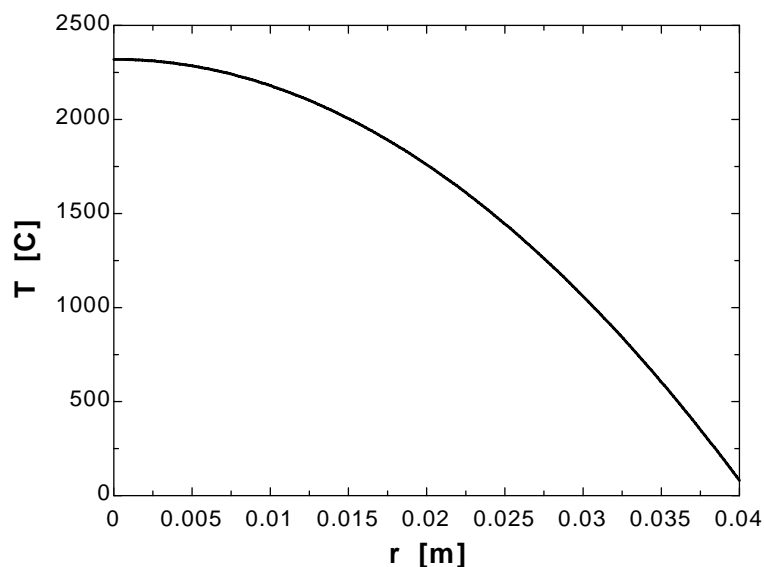

2-82 Heat is generated in a large plane wall whose one side is insulated while the other side is subjected to convection. The mathematical formulation, the variation of temperature in the wall, the relation for the surface temperature, and the relation for the maximum temperature rise in the plate are to be determined for steady one-dimensional heat transfer.

Assumptions **1** Heat transfer is steady since there is no indication of any change with time. **2** Heat transfer is one-dimensional since the wall is large relative to its thickness. **3** Thermal conductivity is constant. **4** Heat generation is uniform.

Analysis (a) Noting that heat transfer is steady and one-dimensional in x direction, the mathematical formulation of this problem can be expressed as

$$\frac{d^2T}{dx^2} + \frac{\dot{e}_{\text{gen}}}{k} = 0$$

and $\frac{dT(0)}{dx} = 0$ (insulated surface at $x = 0$)

$$-k \frac{dT(L)}{dx} = h[T(L) - T_\infty]$$

(b) Rearranging the differential equation and integrating,

$$\frac{d^2T}{dx^2} = -\frac{\dot{e}_{\text{gen}}}{k} \rightarrow \frac{dT}{dx} = -\frac{\dot{e}_{\text{gen}}}{k}x + C_1$$

Integrating one more time,

$$T(x) = \frac{-\dot{e}_{\text{gen}}x^2}{2k} + C_1x + C_2 \quad (1)$$

Applying the boundary conditions:

B.C. at $x = 0$: $\frac{dT(0)}{dx} = 0 \rightarrow \frac{-\dot{e}_{\text{gen}}}{k}(0) + C_1 = 0 \rightarrow C_1 = 0$

B. C. at $x = L$: $-k \left(\frac{-\dot{e}_{\text{gen}}}{k}L \right) = h \left(\frac{-\dot{e}_{\text{gen}}L^2}{2k} + C_2 - T_\infty \right)$

$$\dot{e}_{\text{gen}}L = \frac{-h\dot{e}_{\text{gen}}L^2}{2k} - hT_\infty + C_2 \rightarrow C_2 = \dot{e}_{\text{gen}}L + \frac{h\dot{e}_{\text{gen}}L^2}{2k} + hT_\infty$$

Dividing by h : $C_2 = \frac{\dot{e}_{\text{gen}}L}{h} + \frac{\dot{e}_{\text{gen}}L^2}{2k} + T_\infty$

Substituting the C_1 and C_2 relations into Eq. (1) and rearranging give

$$T(x) = \frac{-\dot{e}_{\text{gen}}x^2}{2k} + \frac{\dot{e}_{\text{gen}}L}{h} + \frac{\dot{e}_{\text{gen}}L^2}{2k} + T_\infty = \frac{\dot{e}_{\text{gen}}}{2k}(L^2 - x^2) + \frac{\dot{e}_{\text{gen}}L}{h} + T_\infty$$

which is the desired solution for the temperature distribution in the wall as a function of x .

(c) The temperatures at two surfaces and the temperature difference between these surfaces are

$$T(0) = \frac{\dot{e}_{\text{gen}}L^2}{2k} + \frac{\dot{e}_{\text{gen}}L}{h} + T_\infty$$

$$T(L) = \frac{\dot{e}_{\text{gen}}L}{h} + T_\infty$$

$$\Delta T_{\text{max}} = T(0) - T(L) = \frac{\dot{e}_{\text{gen}}L^2}{2k}$$

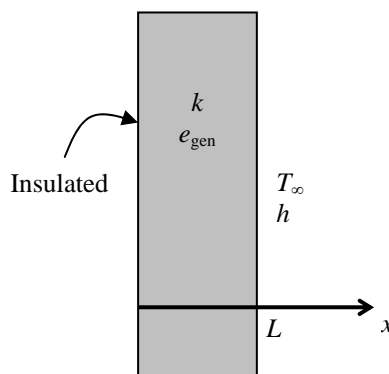

Discussion These relations are obtained without using differential equations in the text (see Eqs. 2-67 and 2-73).

2-83E A long homogeneous resistance heater wire with specified convection conditions at the surface is used to boil water. The mathematical formulation, the variation of temperature in the wire, and the temperature at the centerline of the wire are to be determined.

Assumptions 1 Heat transfer is steady since there is no indication of any change with time. **2** Heat transfer is one-dimensional since there is thermal symmetry about the center line and no change in the axial direction. **3** Thermal conductivity is constant. **4** Heat generation in the wire is uniform.

Properties The thermal conductivity is given to be $k = 8.6 \text{ Btu/h}\cdot\text{ft}\cdot^\circ\text{F}$.

Analysis Noting that heat transfer is steady and one-dimensional in the radial r direction, the mathematical formulation of this problem can be expressed as

$$\frac{1}{r} \frac{d}{dr} \left(r \frac{dT}{dr} \right) + \frac{\dot{e}_{\text{gen}}}{k} = 0$$

and $-k \frac{dT(r_o)}{dr} = h[T(r_o) - T_\infty]$ (convection at the outer surface)

$$\frac{dT(0)}{dr} = 0 \quad (\text{thermal symmetry about the centerline})$$

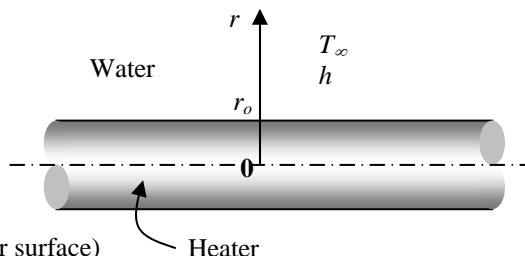

Multiplying both sides of the differential equation by r and rearranging gives

$$\frac{d}{dr} \left(r \frac{dT}{dr} \right) = -\frac{\dot{e}_{\text{gen}}}{k} r$$

Integrating with respect to r gives

$$r \frac{dT}{dr} = -\frac{\dot{e}_{\text{gen}}}{k} \frac{r^2}{2} + C_1 \quad (a)$$

It is convenient at this point to apply the second boundary condition since it is related to the first derivative of the temperature by replacing all occurrences of r and dT/dr in the equation above by zero. It yields

B.C. at $r = 0$: $0 \times \frac{dT(0)}{dr} = -\frac{\dot{e}_{\text{gen}}}{2k} \times 0 + C_1 \rightarrow C_1 = 0$

Dividing both sides of Eq. (a) by r to bring it to a readily integrable form and integrating,

$$\frac{dT}{dr} = -\frac{\dot{e}_{\text{gen}}}{2k} r$$

and $T(r) = -\frac{\dot{e}_{\text{gen}}}{4k} r^2 + C_2 \quad (b)$

Applying the second boundary condition at $r = r_o$,

B. C. at $r = r_o$: $k \frac{\dot{e}_{\text{gen}} r_o}{2k} = h \left(-\frac{\dot{e}_{\text{gen}}}{4k} r_o^2 + C_2 - T_\infty \right) \rightarrow C_2 = T_\infty + \frac{\dot{e}_{\text{gen}} r_o}{2h} + \frac{\dot{e}_{\text{gen}}}{4k} r_o^2$

Substituting this C_2 relation into Eq. (b) and rearranging give

$$T(r) = T_\infty + \frac{\dot{e}_{\text{gen}}}{4k} (r_o^2 - r^2) + \frac{\dot{e}_{\text{gen}} r_o}{2h}$$

which is the desired solution for the temperature distribution in the wire as a function of r . Then the temperature at the center line ($r = 0$) is determined by substituting the known quantities to be

$$\begin{aligned} T(0) &= T_\infty + \frac{\dot{e}_{\text{gen}}}{4k} r_o^2 + \frac{\dot{e}_{\text{gen}} r_o}{2h} \\ &= 212^\circ\text{F} + \frac{(1800 \text{ Btu/h}\cdot\text{in}^3)(0.25 \text{ in})^2}{4 \times (8.6 \text{ Btu/h}\cdot\text{ft}\cdot^\circ\text{F})} \left(\frac{12 \text{ in}}{1 \text{ ft}} \right) + \frac{(1800 \text{ Btu/h}\cdot\text{in}^3)(0.25 \text{ in})}{2 \times (820 \text{ Btu/h}\cdot\text{ft}^2\cdot^\circ\text{F})} \left(\frac{12 \text{ in}}{1 \text{ ft}} \right)^2 = \mathbf{290.8^\circ\text{F}} \end{aligned}$$

Thus the centerline temperature will be about 80°F above the temperature of the surface of the wire.

2-84E EES Prob. 2-83E is reconsidered. The temperature at the centerline of the wire as a function of the heat generation is to be plotted.

Analysis The problem is solved using EES, and the solution is given below.

"GIVEN"

$r_0=0.25/12$ [ft]
 $k=8.6$ [Btu/h-ft-F]
 $e_{\text{dot}}=1800$ [Btu/h-in³]
 $T_{\text{infinity}}=212$ [F]
 $h=820$ [Btu/h-ft²-F]

"ANALYSIS"

$T_0=T_{\text{infinity}}+(e_{\text{dot}}/\text{Convert}(\text{in}^3, \text{ft}^3))/(4*k)*(r_0^2-r^2)+((e_{\text{dot}}/\text{Convert}(\text{in}^3, \text{ft}^3))*r_0)/(2*h)$ "Variation of temperature"
 $r=0$ "for centerline temperature"

e [Btu/h.in ³]	T ₀ [F]
400	229.5
600	238.3
800	247
1000	255.8
1200	264.5
1400	273.3
1600	282
1800	290.8
2000	299.5
2200	308.3
2400	317

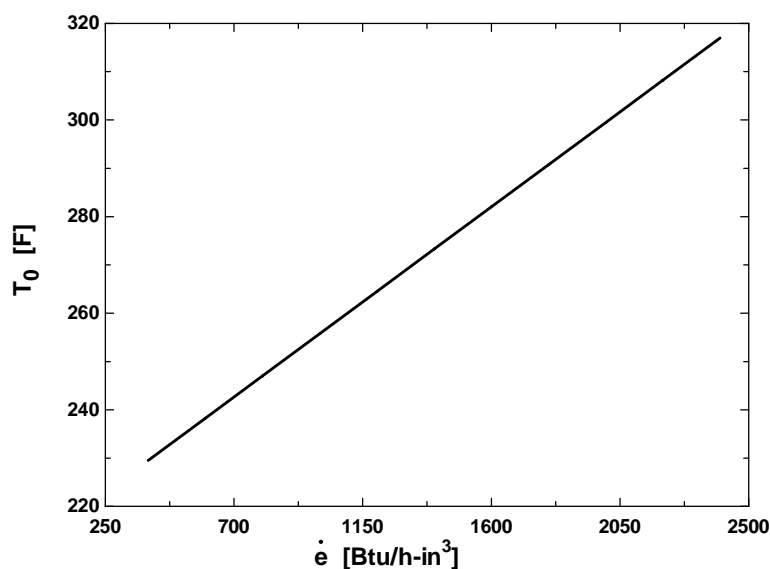

2-85 A nuclear fuel rod with a specified surface temperature is used as the fuel in a nuclear reactor. The center temperature of the rod is to be determined.

Assumptions **1** Heat transfer is steady since there is no indication of any change with time. **2** Heat transfer is one-dimensional since there is thermal symmetry about the center line and no change in the axial direction. **3** Thermal conductivity is constant. **4** Heat generation in the rod is uniform.

Properties The thermal conductivity is given to be $k = 29.5$ W/m·°C.

Analysis The center temperature of the rod is determined from

$$T_o = T_s + \frac{\dot{e}_{\text{gen}} r_o^2}{4k} = 220^\circ\text{C} + \frac{(4 \times 10^7 \text{ W/m}^3)(0.005 \text{ m})^2}{4(29.5 \text{ W/m}\cdot^\circ\text{C})} = \mathbf{228^\circ\text{C}}$$

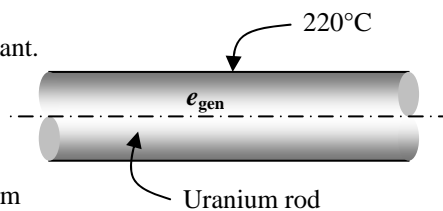

2-86 Both sides of a large stainless steel plate in which heat is generated uniformly are exposed to convection with the environment. The location and values of the highest and the lowest temperatures in the plate are to be determined.

Assumptions 1 Heat transfer is steady since there is no indication of any change with time. **2** Heat transfer is one-dimensional since the plate is large relative to its thickness, and there is thermal symmetry about the center plane **3** Thermal conductivity is constant. **4** Heat generation is uniform.

Properties The thermal conductivity is given to be $k = 15.1 \text{ W/m}\cdot\text{°C}$.

Analysis The lowest temperature will occur at surfaces of plate while the highest temperature will occur at the midplane. Their values are determined directly from

$$T_s = T_\infty + \frac{\dot{e}_{\text{gen}} L}{h} = 30^\circ\text{C} + \frac{(5 \times 10^5 \text{ W/m}^3)(0.015 \text{ m})}{60 \text{ W/m}^2 \cdot \text{°C}} = \mathbf{155^\circ\text{C}}$$

$$T_o = T_s + \frac{\dot{e}_{\text{gen}} L^2}{2k} = 155^\circ\text{C} + \frac{(5 \times 10^5 \text{ W/m}^3)(0.015 \text{ m})^2}{2(15.1 \text{ W/m}\cdot\text{°C})} = \mathbf{158.7^\circ\text{C}}$$

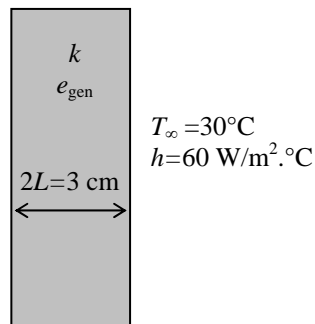

2-87 Heat is generated uniformly in a large brass plate. One side of the plate is insulated while the other side is subjected to convection. The location and values of the highest and the lowest temperatures in the plate are to be determined.

Assumptions 1 Heat transfer is steady since there is no indication of any change with time. **2** Heat transfer is one-dimensional since the plate is large relative to its thickness, and there is thermal symmetry about the center plane **3** Thermal conductivity is constant. **4** Heat generation is uniform.

Properties The thermal conductivity is given to be $k = 111 \text{ W/m}\cdot\text{°C}$.

Analysis This insulated plate whose thickness is L is equivalent to one-half of an uninsulated plate whose thickness is $2L$ since the midplane of the uninsulated plate can be treated as insulated surface. The highest temperature will occur at the insulated surface while the lowest temperature will occur at the surface which is exposed to the environment. Note that L in the following relations is the full thickness of the given plate since the insulated side represents the center surface of a plate whose thickness is doubled. The desired values are determined directly from

$$T_s = T_\infty + \frac{\dot{e}_{\text{gen}} L}{h} = 25^\circ\text{C} + \frac{(2 \times 10^5 \text{ W/m}^3)(0.05 \text{ m})}{44 \text{ W/m}^2 \cdot \text{°C}} = \mathbf{252.3^\circ\text{C}}$$

$$T_o = T_s + \frac{\dot{e}_{\text{gen}} L^2}{2k} = 252.3^\circ\text{C} + \frac{(2 \times 10^5 \text{ W/m}^3)(0.05 \text{ m})^2}{2(111 \text{ W/m}\cdot\text{°C})} = \mathbf{254.6^\circ\text{C}}$$

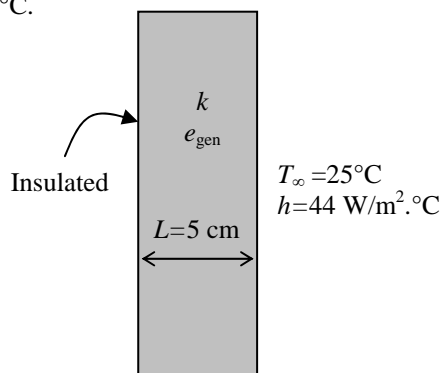

2-88 EES Prob. 2-87 is reconsidered. The effect of the heat transfer coefficient on the highest and lowest temperatures in the plate is to be investigated.

Analysis The problem is solved using EES, and the solution is given below.

"GIVEN"

L=0.05 [m]
k=111 [W/m-C]
g_dot=2E5 [W/m^3]
T_infinity=25 [C]
h=44 [W/m^2-C]

"ANALYSIS"

$T_{min} = T_{infinity} + (g_dot * L) / h$
 $T_{max} = T_{min} + (g_dot * L^2) / (2 * k)$

h [W/m ² .C]	T _{min} [C]	T _{max} [C]
20	525	527.3
25	425	427.3
30	358.3	360.6
35	310.7	313
40	275	277.3
45	247.2	249.5
50	225	227.3
55	206.8	209.1
60	191.7	193.9
65	178.8	181.1
70	167.9	170.1
75	158.3	160.6
80	150	152.3
85	142.6	144.9
90	136.1	138.4
95	130.3	132.5
100	125	127.3

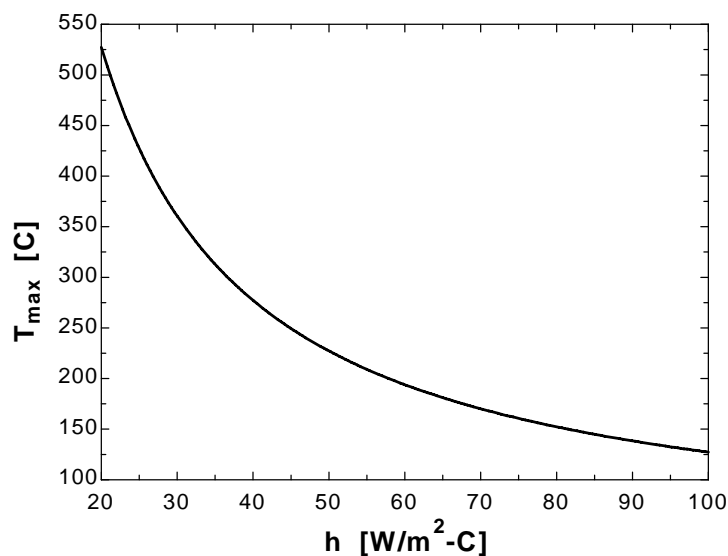
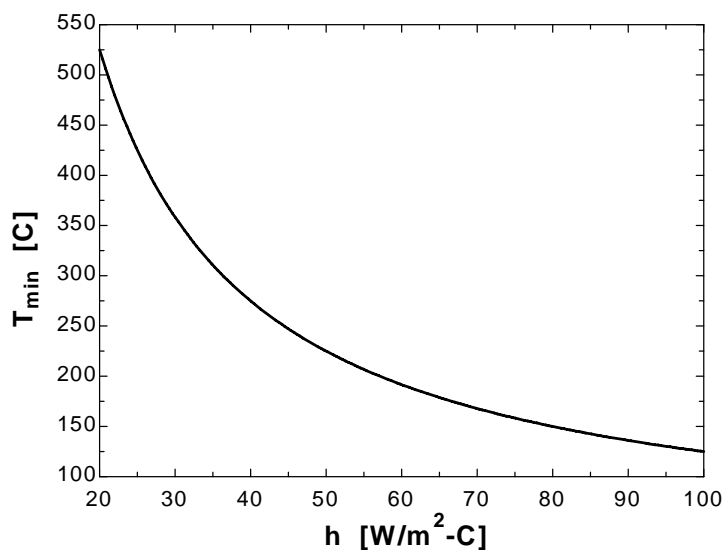

2-89 A long resistance heater wire is subjected to convection at its outer surface. The surface temperature of the wire is to be determined using the applicable relations directly and by solving the applicable differential equation.

Assumptions 1 Heat transfer is steady since there is no indication of any change with time. **2** Heat transfer is one-dimensional since there is thermal symmetry about the center line and no change in the axial direction. **3** Thermal conductivity is constant. **4** Heat generation in the wire is uniform.

Properties The thermal conductivity is given to be $k = 15.1 \text{ W/m}\cdot^\circ\text{C}$.

Analysis (a) The heat generation per unit volume of the wire is

$$\dot{e}_{\text{gen}} = \frac{\dot{E}_{\text{gen}}}{V_{\text{wire}}} = \frac{\dot{E}_{\text{gen}}}{\pi r_o^2 L} = \frac{2000 \text{ W}}{\pi (0.001 \text{ m})^2 (6 \text{ m})} = 1.061 \times 10^8 \text{ W/m}^3$$

The surface temperature of the wire is then (Eq. 2-68)

$$T_s = T_\infty + \frac{\dot{e}_{\text{gen}} r_o}{2h} = 20^\circ\text{C} + \frac{(1.061 \times 10^8 \text{ W/m}^3)(0.001 \text{ m})}{2(175 \text{ W/m}^2 \cdot ^\circ\text{C})} = \mathbf{323^\circ\text{C}}$$

(b) The mathematical formulation of this problem can be expressed as

$$\frac{1}{r} \frac{d}{dr} \left(r \frac{dT}{dr} \right) + \frac{\dot{e}_{\text{gen}}}{k} = 0$$

$$\text{and } -k \frac{dT(r_o)}{dr} = h[T(r_o) - T_\infty] \quad (\text{convection at the outer surface})$$

$$\frac{dT(0)}{dr} = 0 \quad (\text{thermal symmetry about the centerline})$$

Multiplying both sides of the differential equation by r and integrating gives

$$\frac{d}{dr} \left(r \frac{dT}{dr} \right) = -\frac{\dot{e}_{\text{gen}}}{k} r \rightarrow r \frac{dT}{dr} = -\frac{\dot{e}_{\text{gen}}}{k} \frac{r^2}{2} + C_1 \quad (a)$$

Applying the boundary condition at the center line,

$$\text{B.C. at } r = 0: \quad 0 \times \frac{dT(0)}{dr} = -\frac{\dot{e}_{\text{gen}}}{2k} \times 0 + C_1 \rightarrow C_1 = 0$$

Dividing both sides of Eq. (a) by r to bring it to a readily integrable form and integrating,

$$\frac{dT}{dr} = -\frac{\dot{e}_{\text{gen}}}{2k} r \rightarrow T(r) = -\frac{\dot{e}_{\text{gen}}}{4k} r^2 + C_2 \quad (b)$$

Applying the boundary condition at $r = r_o$,

$$\text{B. C. at } r = r_o: \quad -k \frac{\dot{e}_{\text{gen}} r_o}{2k} = h \left(-\frac{\dot{e}_{\text{gen}}}{4k} r_o^2 + C_2 - T_\infty \right) \rightarrow C_2 = T_\infty + \frac{\dot{e}_{\text{gen}} r_o}{2h} + \frac{\dot{e}_{\text{gen}}}{4k} r_o^2$$

Substituting this C_2 relation into Eq. (b) and rearranging give

$$T(r) = T_\infty + \frac{\dot{e}_{\text{gen}}}{4k} (r_o^2 - r^2) + \frac{\dot{e}_{\text{gen}} r_o}{2h}$$

which is the temperature distribution in the wire as a function of r . Then the temperature of the wire at the surface ($r = r_o$) is determined by substituting the known quantities to be

$$T(r_o) = T_\infty + \frac{\dot{e}_{\text{gen}}}{4k} (r_o^2 - r_o^2) + \frac{\dot{e}_{\text{gen}} r_o}{2h} = T_\infty + \frac{\dot{e}_{\text{gen}} r_o}{2h} = 20^\circ\text{C} + \frac{(1.061 \times 10^8 \text{ W/m}^3)(0.001 \text{ m})}{2(175 \text{ W/m}^2 \cdot ^\circ\text{C})} = \mathbf{323^\circ\text{C}}$$

Note that both approaches give the same result.

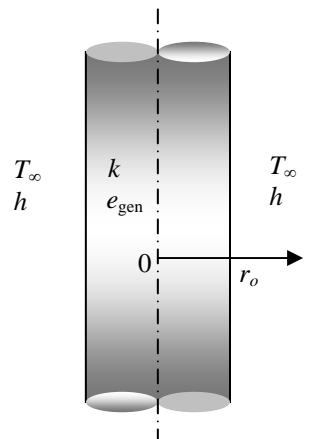

2-90E Heat is generated uniformly in a resistance heater wire. The temperature difference between the center and the surface of the wire is to be determined.

Assumptions 1 Heat transfer is steady since there is no change with time. 2 Heat transfer is one-dimensional since there is thermal symmetry about the center line and no change in the axial direction. 3 Thermal conductivity is constant. 4 Heat generation in the heater is uniform.

Properties The thermal conductivity is given to be $k = 5.8 \text{ Btu/h}\cdot\text{ft}\cdot^\circ\text{F}$.

Analysis The resistance heater converts electric energy into heat at a rate of 3 kW. The rate of heat generation per unit length of the wire is

$$\dot{e}_{\text{gen}} = \frac{\dot{E}_{\text{gen}}}{V_{\text{wire}}} = \frac{\dot{E}_{\text{gen}}}{\pi r_o^2 L} = \frac{(3 \times 3412.14 \text{ Btu/h})}{\pi (0.04 / 12 \text{ ft})^2 (1 \text{ ft})} = 2.933 \times 10^8 \text{ Btu/h}\cdot\text{ft}^3$$

Then the temperature difference between the centerline and the surface becomes

$$\Delta T_{\text{max}} = \frac{\dot{e}_{\text{gen}} r_o^2}{4k} = \frac{(2.933 \times 10^8 \text{ Btu/h}\cdot\text{ft}^3)(0.04 / 12 \text{ ft})^2}{4(5.8 \text{ Btu/h}\cdot\text{ft}\cdot^\circ\text{F})} = \mathbf{140.5^\circ\text{F}}$$

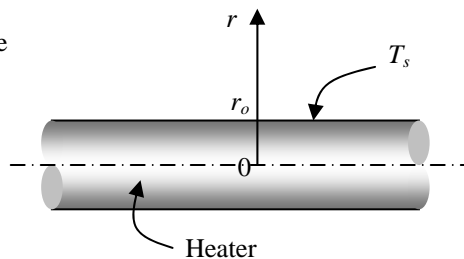

2-91E Heat is generated uniformly in a resistance heater wire. The temperature difference between the center and the surface of the wire is to be determined.

Assumptions 1 Heat transfer is steady since there is no change with time. 2 Heat transfer is one-dimensional since there is thermal symmetry about the center line and no change in the axial direction. 3 Thermal conductivity is constant. 4 Heat generation in the heater is uniform.

Properties The thermal conductivity is given to be $k = 4.5 \text{ Btu/h}\cdot\text{ft}\cdot^\circ\text{F}$.

Analysis The resistance heater converts electric energy into heat at a rate of 3 kW. The rate of heat generation per unit volume of the wire is

$$\dot{e}_{\text{gen}} = \frac{\dot{E}_{\text{gen}}}{V_{\text{wire}}} = \frac{\dot{E}_{\text{gen}}}{\pi r_o^2 L} = \frac{(3 \times 3412.14 \text{ Btu/h})}{\pi (0.04 / 12 \text{ ft})^2 (1 \text{ ft})} = 2.933 \times 10^8 \text{ Btu/h}\cdot\text{ft}^3$$

Then the temperature difference between the centerline and the surface becomes

$$\Delta T_{\text{max}} = \frac{\dot{e}_{\text{gen}} r_o^2}{4k} = \frac{(2.933 \times 10^8 \text{ Btu/h}\cdot\text{ft}^3)(0.04 / 12 \text{ ft})^2}{4(4.5 \text{ Btu/h}\cdot\text{ft}\cdot^\circ\text{F})} = \mathbf{181.0^\circ\text{F}}$$

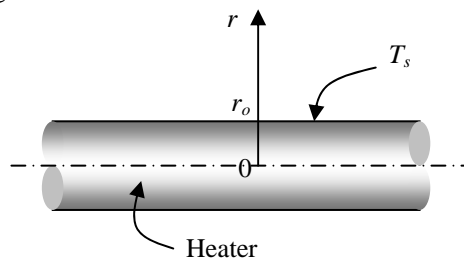

2-92 Heat is generated uniformly in a spherical radioactive material with specified surface temperature. The mathematical formulation, the variation of temperature in the sphere, and the center temperature are to be determined for steady one-dimensional heat transfer.

Assumptions 1 Heat transfer is steady since there is no indication of any changes with time. **2** Heat transfer is one-dimensional since there is thermal symmetry about the mid point. **3** Thermal conductivity is constant. **4** Heat generation is uniform.

Properties The thermal conductivity is given to be $k = 15 \text{ W/m}\cdot^\circ\text{C}$.

Analysis (a) Noting that heat transfer is steady and one-dimensional in the radial r direction, the mathematical formulation of this problem can be expressed as

$$\frac{1}{r^2} \frac{d}{dr} \left(r^2 \frac{dT}{dr} \right) + \frac{\dot{e}_{\text{gen}}}{k} = 0 \quad \text{with } \dot{e}_{\text{gen}} = \text{constant}$$

and $T(r_o) = T_s = 80^\circ\text{C}$ (specified surface temperature)

$$\frac{dT(0)}{dr} = 0 \quad (\text{thermal symmetry about the mid point})$$

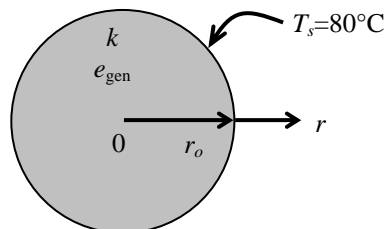

(b) Multiplying both sides of the differential equation by r^2 and rearranging gives

$$\frac{d}{dr} \left(r^2 \frac{dT}{dr} \right) = -\frac{\dot{e}_{\text{gen}}}{k} r^2$$

Integrating with respect to r gives

$$r^2 \frac{dT}{dr} = -\frac{\dot{e}_{\text{gen}}}{k} \frac{r^3}{3} + C_1 \quad (a)$$

Applying the boundary condition at the mid point,

$$\text{B.C. at } r = 0: \quad 0 \times \frac{dT(0)}{dr} = -\frac{\dot{e}_{\text{gen}}}{3k} \times 0 + C_1 \quad \rightarrow \quad C_1 = 0$$

Dividing both sides of Eq. (a) by r^2 to bring it to a readily integrable form and integrating,

$$\frac{dT}{dr} = -\frac{\dot{e}_{\text{gen}}}{3k} r$$

$$\text{and} \quad T(r) = -\frac{\dot{e}_{\text{gen}}}{6k} r^2 + C_2 \quad (b)$$

Applying the other boundary condition at $r = r_o$,

$$\text{B. C. at } r = r_o: \quad T_s = -\frac{\dot{e}_{\text{gen}}}{6k} r_o^2 + C_2 \quad \rightarrow \quad C_2 = T_s + \frac{\dot{e}_{\text{gen}}}{6k} r_o^2$$

Substituting this C_2 relation into Eq. (b) and rearranging give

$$T(r) = T_s + \frac{\dot{e}_{\text{gen}}}{6k} (r_o^2 - r^2)$$

which is the desired solution for the temperature distribution in the wire as a function of r .

(c) The temperature at the center of the sphere ($r = 0$) is determined by substituting the known quantities to be

$$T(0) = T_s + \frac{\dot{e}_{\text{gen}}}{6k} (r_o^2 - 0^2) = T_s + \frac{\dot{e}_{\text{gen}} r_o^2}{6k} = 80^\circ\text{C} + \frac{(4 \times 10^7 \text{ W/m}^3)(0.04 \text{ m})^2}{6 \times (15 \text{ W/m}\cdot^\circ\text{C})} = \mathbf{791^\circ\text{C}}$$

Thus the temperature at center will be about 711°C above the temperature of the outer surface of the sphere.

2-93 EES Prob. 2-92 is reconsidered. The temperature as a function of the radius is to be plotted. Also, the center temperature of the sphere as a function of the thermal conductivity is to be plotted.

Analysis The problem is solved using EES, and the solution is given below.

"GIVEN"

$r_0=0.04$ [m]
 $g_{\text{dot}}=4E7$ [W/m³]
 $T_s=80$ [C]
 $k=15$ [W/m-C]

"ANALYSIS"

$T=T_s+g_{\text{dot}}/(6*k)*(r_0^2-r^2)$ "Temperature distribution as a function of r"
 $T_0=T_s+g_{\text{dot}}/(6*k)*r_0^2$ "Temperature at the center (r=0)"

r [m]	T [C]
0	791.1
0.002105	789.1
0.004211	783.2
0.006316	773.4
0.008421	759.6
0.01053	741.9
0.01263	720.2
0.01474	694.6
0.01684	665
0.01895	631.6
0.02105	594.1
0.02316	552.8
0.02526	507.5
0.02737	458.2
0.02947	405
0.03158	347.9
0.03368	286.8
0.03579	221.8
0.03789	152.9
0.04	80

k [W/m.C]	T ₀ [C]
10	1147
30.53	429.4
51.05	288.9
71.58	229
92.11	195.8
112.6	174.7
133.2	160.1
153.7	149.4
174.2	141.2
194.7	134.8
215.3	129.6
235.8	125.2
256.3	121.6
276.8	118.5

297.4	115.9
317.9	113.6
338.4	111.5
358.9	109.7
379.5	108.1
400	106.7

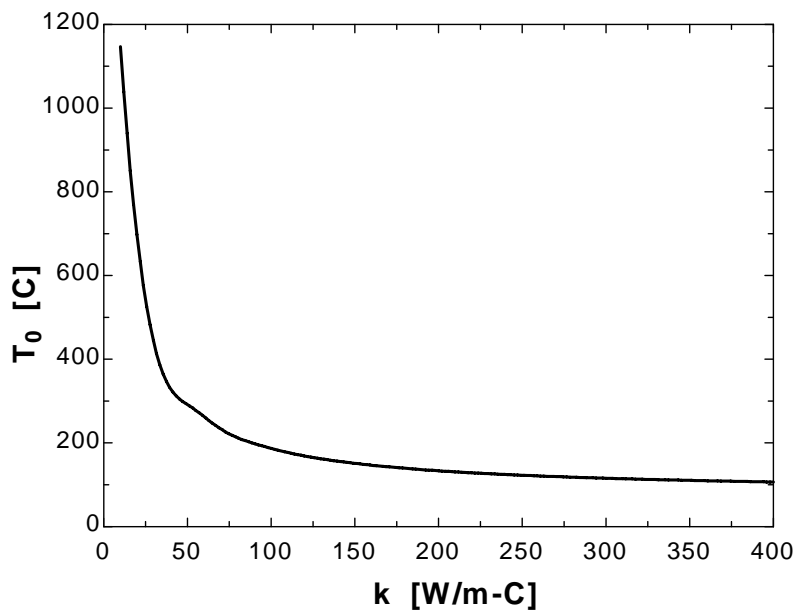
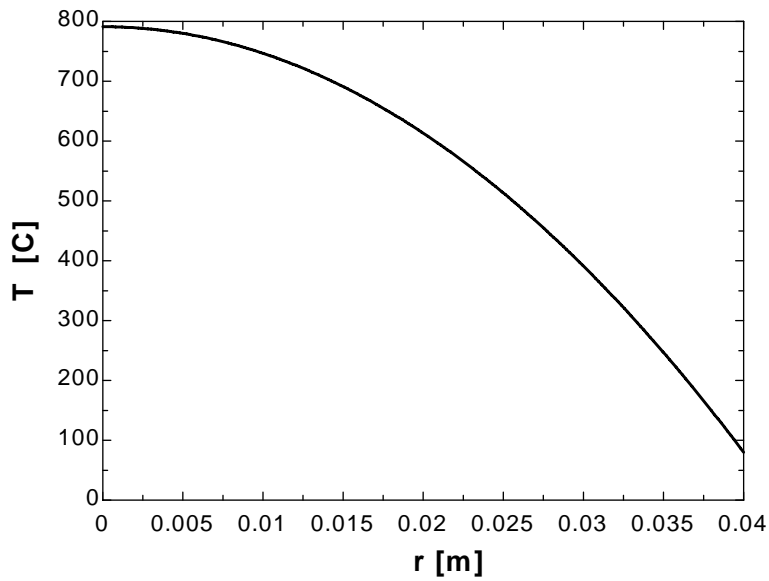

2-94 A long homogeneous resistance heater wire with specified surface temperature is used to heat the air. The temperature of the wire 3.5 mm from the center is to be determined in steady operation.

Assumptions 1 Heat transfer is steady since there is no indication of any change with time. **2** Heat transfer is one-dimensional since there is thermal symmetry about the center line and no change in the axial direction. **3** Thermal conductivity is constant. **4** Heat generation in the wire is uniform.

Properties The thermal conductivity is given to be $k = 8 \text{ W/m}\cdot\text{C}$.

Analysis Noting that heat transfer is steady and one-dimensional in the radial r direction, the mathematical formulation of this problem can be expressed as

$$\frac{1}{r} \frac{d}{dr} \left(r \frac{dT}{dr} \right) + \frac{\dot{e}_{\text{gen}}}{k} = 0$$

and $T(r_o) = T_s = 180^\circ\text{C}$ (specified surface temperature)

$$\frac{dT(0)}{dr} = 0 \quad (\text{thermal symmetry about the centerline})$$

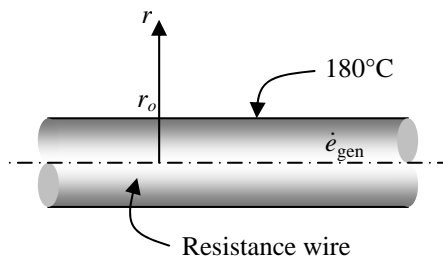

Multiplying both sides of the differential equation by r and rearranging gives

$$\frac{d}{dr} \left(r \frac{dT}{dr} \right) = -\frac{\dot{e}_{\text{gen}}}{k} r$$

Integrating with respect to r gives

$$r \frac{dT}{dr} = -\frac{\dot{e}_{\text{gen}}}{k} \frac{r^2}{2} + C_1 \quad (a)$$

It is convenient at this point to apply the boundary condition at the center since it is related to the first derivative of the temperature. It yields

$$\text{B.C. at } r = 0: \quad 0 \times \frac{dT(0)}{dr} = -\frac{\dot{e}_{\text{gen}}}{2k} \times 0 + C_1 \quad \rightarrow \quad C_1 = 0$$

Dividing both sides of Eq. (a) by r to bring it to a readily integrable form and integrating,

$$\frac{dT}{dr} = -\frac{\dot{e}_{\text{gen}}}{2k} r$$

$$\text{and} \quad T(r) = -\frac{\dot{e}_{\text{gen}}}{4k} r^2 + C_2 \quad (b)$$

Applying the other boundary condition at $r = r_o$,

$$\text{B. C. at } r = r_o: \quad T_s = -\frac{\dot{e}_{\text{gen}}}{4k} r_o^2 + C_2 \quad \rightarrow \quad C_2 = T_s + \frac{\dot{e}_{\text{gen}}}{4k} r_o^2$$

Substituting this C_2 relation into Eq. (b) and rearranging give

$$T(r) = T_s + \frac{\dot{e}_{\text{gen}}}{4k} (r_o^2 - r^2)$$

which is the desired solution for the temperature distribution in the wire as a function of r . The temperature 3.5 mm from the center line ($r = 0.0035 \text{ m}$) is determined by substituting the known quantities to be

$$T(0.0035 \text{ m}) = T_s + \frac{\dot{e}_{\text{gen}}}{4k} (r_o^2 - r^2) = 180^\circ\text{C} + \frac{5 \times 10^7 \text{ W/m}^3}{4 \times (8 \text{ W/m}\cdot\text{C})} [(0.005 \text{ m})^2 - (0.0035 \text{ m})^2] = \mathbf{200^\circ\text{C}}$$

Thus the temperature at that location will be about 20°C above the temperature of the outer surface of the wire.

2-95 Heat is generated in a large plane wall whose one side is insulated while the other side is maintained at a specified temperature. The mathematical formulation, the variation of temperature in the wall, and the temperature of the insulated surface are to be determined for steady one-dimensional heat transfer.

Assumptions 1 Heat transfer is steady since there is no indication of any change with time. **2** Heat transfer is one-dimensional since the wall is large relative to its thickness, and there is thermal symmetry about the center plane. **3** Thermal conductivity is constant. **4** Heat generation varies with location in the x direction.

Properties The thermal conductivity is given to be $k = 30 \text{ W/m}\cdot^\circ\text{C}$.

Analysis (a) Noting that heat transfer is steady and one-dimensional in x direction, the mathematical formulation of this problem can be expressed as

$$\frac{d^2T}{dx^2} + \frac{\dot{e}_{\text{gen}}(x)}{k} = 0$$

where $\dot{e}_{\text{gen}} = \dot{e}_0 e^{-0.5x/L}$ and $\dot{e}_0 = 8 \times 10^6 \text{ W/m}^3$

and $\frac{dT(0)}{dx} = 0$ (insulated surface at $x = 0$)

$T(L) = T_2 = 30^\circ\text{C}$ (specified surface temperature)

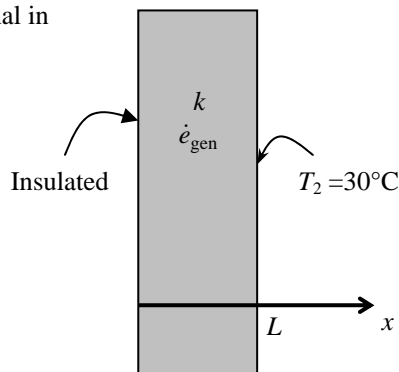

(b) Rearranging the differential equation and integrating,

$$\frac{d^2T}{dx^2} = -\frac{\dot{e}_0}{k} e^{-0.5x/L} \rightarrow \frac{dT}{dx} = -\frac{\dot{e}_0}{k} \frac{e^{-0.5x/L}}{-0.5/L} + C_1 \rightarrow \frac{dT}{dx} = \frac{2\dot{e}_0 L}{k} e^{-0.5x/L} + C_1$$

Integrating one more time,

$$T(x) = \frac{2\dot{e}_0 L}{k} \frac{e^{-0.5x/L}}{-0.5/L} + C_1 x + C_2 \rightarrow T(x) = -\frac{4\dot{e}_0 L^2}{k} e^{-0.5x/L} + C_1 x + C_2 \quad (1)$$

Applying the boundary conditions:

$$\text{B.C. at } x=0: \quad \frac{dT(0)}{dx} = \frac{2\dot{e}_0 L}{k} e^{-0.5 \times 0/L} + C_1 \rightarrow 0 = \frac{2\dot{e}_0 L}{k} + C_1 \rightarrow C_1 = -\frac{2\dot{e}_0 L}{k}$$

$$\text{B.C. at } x=L: \quad T(L) = T_2 = -\frac{4\dot{e}_0 L^2}{k} e^{-0.5L/L} + C_1 L + C_2 \rightarrow C_2 = T_2 + \frac{4\dot{e}_0 L^2}{k} e^{-0.5} + \frac{2\dot{e}_0 L^2}{k}$$

Substituting the C_1 and C_2 relations into Eq. (1) and rearranging give

$$T(x) = T_2 + \frac{\dot{e}_0 L^2}{k} [4(e^{-0.5} - e^{-0.5x/L}) + 2(1 - x/L)]$$

which is the desired solution for the temperature distribution in the wall as a function of x .

(c) The temperature at the insulate surface ($x = 0$) is determined by substituting the known quantities to be

$$\begin{aligned} T(0) &= T_2 + \frac{\dot{e}_0 L^2}{k} [4(e^{-0.5} - e^0) + (2 - 0/L)] \\ &= 30^\circ\text{C} + \frac{(8 \times 10^6 \text{ W/m}^3)(0.05 \text{ m})^2}{(30 \text{ W/m}\cdot^\circ\text{C})} [4(e^{-0.5} - 1) + (2 - 0)] = \mathbf{314^\circ\text{C}} \end{aligned}$$

Therefore, there is a temperature difference of almost 300°C between the two sides of the plate.

2-96 EES Prob. 2-95 is reconsidered. The heat generation as a function of the distance is to be plotted.

Analysis The problem is solved using EES, and the solution is given below.

"GIVEN"

L=0.05 [m]

T_s=30 [C]

k=30 [W/m-C]

e_dot_0=8E6 [W/m³]

"ANALYSIS"

e_dot=e_dot_0*exp((-0.5*x)/L) "Heat generation as a function of x"

"x is the parameter to be varied"

x [m]	e [W/m ³]
0	8.000E+06
0.005	7.610E+06
0.01	7.239E+06
0.015	6.886E+06
0.02	6.550E+06
0.025	6.230E+06
0.03	5.927E+06
0.035	5.638E+06
0.04	5.363E+06
0.045	5.101E+06
0.05	4.852E+06

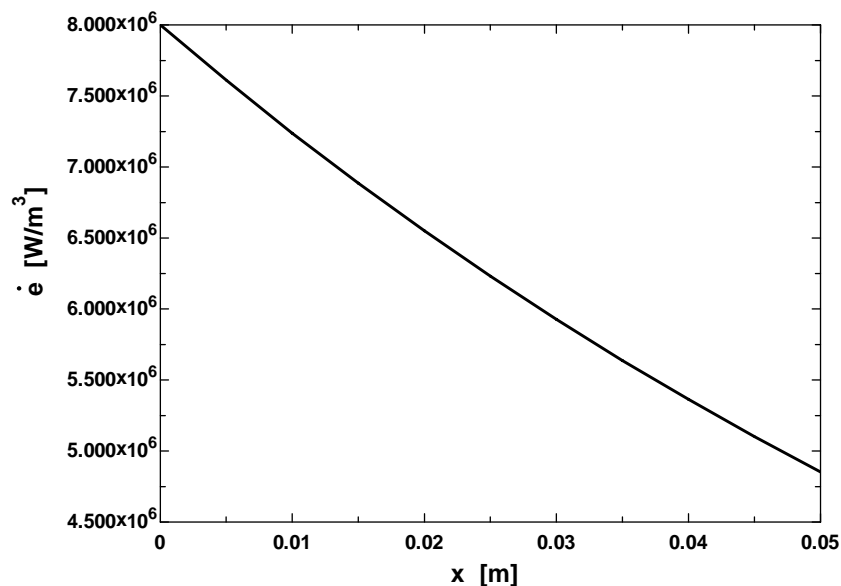

Variable Thermal Conductivity

2-97C During steady one-dimensional heat conduction in a plane wall, long cylinder, and sphere with constant thermal conductivity and no heat generation, the temperature in only the *plane wall* will vary linearly.

2-98C The thermal conductivity of a medium, in general, varies with temperature.

2-99C During steady one-dimensional heat conduction in a plane wall in which the thermal conductivity varies linearly, the error involved in heat transfer calculation by assuming constant thermal conductivity at the average temperature is (a) *none*.

2-100C No, the temperature variation in a plain wall will not be linear when the thermal conductivity varies with temperature.

2-101C Yes, when the thermal conductivity of a medium varies linearly with temperature, the average thermal conductivity is always equivalent to the conductivity value at the average temperature.

2-102 A plate with variable conductivity is subjected to specified temperatures on both sides. The rate of heat transfer through the plate is to be determined.

Assumptions **1** Heat transfer is given to be steady and one-dimensional. **2** Thermal conductivity varies quadratically. **3** There is no heat generation.

Properties The thermal conductivity is given to be

$$k(T) = k_0(1 + \beta T^2).$$

Analysis When the variation of thermal conductivity with temperature $k(T)$ is known, the average value of the thermal conductivity in the temperature range between T_1 and T_2 can be determined from

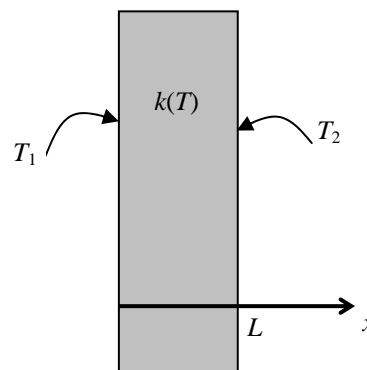

$$\begin{aligned} k_{\text{avg}} &= \frac{\int_{T_1}^{T_2} k(T) dT}{T_2 - T_1} = \frac{\int_{T_1}^{T_2} k_0(1 + \beta T^2) dT}{T_2 - T_1} = \frac{k_0 \left(T + \frac{\beta}{3} T^3 \right) \Big|_{T_1}^{T_2}}{T_2 - T_1} = \frac{k_0 \left[(T_2 - T_1) + \frac{\beta}{3} (T_2^3 - T_1^3) \right]}{T_2 - T_1} \\ &= k_0 \left[1 + \frac{\beta}{3} (T_2^2 + T_1 T_2 + T_1^2) \right] \end{aligned}$$

This relation is based on the requirement that the rate of heat transfer through a medium with constant average thermal conductivity k_{avg} equals the rate of heat transfer through the same medium with variable conductivity $k(T)$. Then the rate of heat conduction through the plate can be determined to be

$$\dot{Q} = k_{\text{avg}} A \frac{T_1 - T_2}{L} = k_0 \left[1 + \frac{\beta}{3} (T_2^2 + T_1 T_2 + T_1^2) \right] A \frac{T_1 - T_2}{L}$$

Discussion We would obtain the same result if we substituted the given $k(T)$ relation into the second part of Eq. 2-76, and performed the indicated integration.

2-103 A cylindrical shell with variable conductivity is subjected to specified temperatures on both sides. The variation of temperature and the rate of heat transfer through the shell are to be determined.

Assumptions 1 Heat transfer is given to be steady and one-dimensional. **2** Thermal conductivity varies linearly. **3** There is no heat generation.

Properties The thermal conductivity is given to be $k(T) = k_0(1 + \beta T)$.

Solution (a) The rate of heat transfer through the shell is expressed as

$$\dot{Q}_{\text{cylinder}} = 2\pi k_{\text{avg}} L \frac{T_1 - T_2}{\ln(r_2 / r_1)}$$

where L is the length of the cylinder, r_1 is the inner radius, and r_2 is the outer radius, and

$$k_{\text{avg}} = k(T_{\text{avg}}) = k_0 \left(1 + \beta \frac{T_2 + T_1}{2} \right)$$

is the average thermal conductivity.

(b) To determine the temperature distribution in the shell, we begin with the Fourier's law of heat conduction expressed as

$$\dot{Q} = -k(T)A \frac{dT}{dr}$$

where the rate of conduction heat transfer \dot{Q} is constant and the heat conduction area $A = 2\pi rL$ is variable. Separating the variables in the above equation and integrating from $r = r_1$ where $T(r_1) = T_1$ to any r where $T(r) = T$, we get

$$\dot{Q} \int_{r_1}^r \frac{dr}{r} = -2\pi L \int_{T_1}^T k(T) dT$$

Substituting $k(T) = k_0(1 + \beta T)$ and performing the integrations gives

$$\dot{Q} \ln \frac{r}{r_1} = -2\pi L k_0 [(T - T_1) + \beta(T^2 - T_1^2) / 2]$$

Substituting the \dot{Q} expression from part (a) and rearranging give

$$T^2 + \frac{2}{\beta} T + \frac{2k_{\text{avg}}}{\beta k_0} \frac{\ln(r / r_1)}{\ln(r_2 / r_1)} (T_1 - T_2) - T_1^2 - \frac{2}{\beta} T_1 = 0$$

which is a *quadratic* equation in the unknown temperature T . Using the quadratic formula, the temperature distribution $T(r)$ in the cylindrical shell is determined to be

$$T(r) = -\frac{1}{\beta} \pm \sqrt{\frac{1}{\beta^2} - \frac{2k_{\text{avg}}}{\beta k_0} \frac{\ln(r / r_1)}{\ln(r_2 / r_1)} (T_1 - T_2) + T_1^2 + \frac{2}{\beta} T_1}$$

Discussion The proper sign of the square root term (+ or -) is determined from the requirement that the temperature at any point within the medium must remain between T_1 and T_2 .

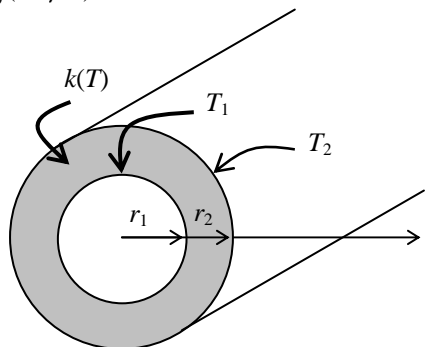

2-104 A spherical shell with variable conductivity is subjected to specified temperatures on both sides. The variation of temperature and the rate of heat transfer through the shell are to be determined.

Assumptions 1 Heat transfer is given to be steady and one-dimensional. **2** Thermal conductivity varies linearly. **3** There is no heat generation.

Properties The thermal conductivity is given to be $k(T) = k_0(1 + \beta T)$.

Solution (a) The rate of heat transfer through the shell is expressed as

$$\dot{Q}_{\text{sphere}} = 4\pi k_{\text{avg}} r_1 r_2 \frac{T_1 - T_2}{r_2 - r_1}$$

where r_1 is the inner radius, r_2 is the outer radius, and

$$k_{\text{avg}} = k(T_{\text{avg}}) = k_0 \left(1 + \beta \frac{T_2 + T_1}{2} \right)$$

is the average thermal conductivity.

(b) To determine the temperature distribution in the shell, we begin with the Fourier's law of heat conduction expressed as

$$\dot{Q} = -k(T)A \frac{dT}{dr}$$

where the rate of conduction heat transfer \dot{Q} is constant and the heat conduction area $A = 4\pi r^2$ is variable. Separating the variables in the above equation and integrating from $r = r_1$ where $T(r_1) = T_1$ to any r where $T(r) = T$, we get

$$\dot{Q} \int_{r_1}^r \frac{dr}{r^2} = -4\pi \int_{T_1}^T k(T) dT$$

Substituting $k(T) = k_0(1 + \beta T)$ and performing the integrations gives

$$\dot{Q} \left(\frac{1}{r_1} - \frac{1}{r} \right) = -4\pi k_0 \left[(T - T_1) + \beta (T^2 - T_1^2) / 2 \right]$$

Substituting the \dot{Q} expression from part (a) and rearranging give

$$T^2 + \frac{2}{\beta} T + \frac{2k_{\text{avg}}}{\beta k_0} \frac{r_2(r - r_1)}{r(r_2 - r_1)} (T_1 - T_2) - T_1^2 - \frac{2}{\beta} T_1 = 0$$

which is a *quadratic* equation in the unknown temperature T . Using the quadratic formula, the temperature distribution $T(r)$ in the cylindrical shell is determined to be

$$T(r) = -\frac{1}{\beta} \pm \sqrt{\frac{1}{\beta^2} - \frac{2k_{\text{avg}}}{\beta k_0} \frac{r_2(r - r_1)}{r(r_2 - r_1)} (T_1 - T_2) + T_1^2 + \frac{2}{\beta} T_1}$$

Discussion The proper sign of the square root term (+ or -) is determined from the requirement that the temperature at any point within the medium must remain between T_1 and T_2 .

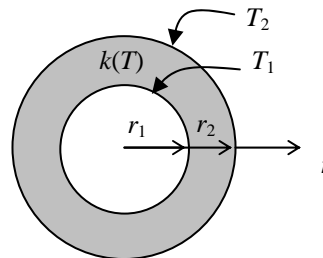

2-105 A plate with variable conductivity is subjected to specified temperatures on both sides. The rate of heat transfer through the plate is to be determined.

Assumptions 1 Heat transfer is given to be steady and one-dimensional. 2 Thermal conductivity varies linearly. 3 There is no heat generation.

Properties The thermal conductivity is given to be $k(T) = k_0(1 + \beta T)$.

Analysis The average thermal conductivity of the medium in this case is simply the conductivity value at the average temperature since the thermal conductivity varies linearly with temperature, and is determined to be

$$\begin{aligned} k_{\text{ave}} &= k(T_{\text{avg}}) = k_0 \left(1 + \beta \frac{T_2 + T_1}{2} \right) \\ &= (25 \text{ W/m} \cdot \text{K}) \left(1 + (8.7 \times 10^{-4} \text{ K}^{-1}) \frac{(500 + 350) \text{ K}}{2} \right) \\ &= 34.24 \text{ W/m} \cdot \text{K} \end{aligned}$$

Then the rate of heat conduction through the plate becomes

$$\dot{Q} = k_{\text{avg}} A \frac{T_1 - T_2}{L} = (34.24 \text{ W/m} \cdot \text{K})(1.5 \text{ m} \times 0.6 \text{ m}) \frac{(500 - 350) \text{ K}}{0.15 \text{ m}} = 30,820 \text{ W} = \mathbf{30.8 \text{ kW}}$$

Discussion We would obtain the same result if we substituted the given $k(T)$ relation into the second part of Eq. 2-76, and performed the indicated integration.

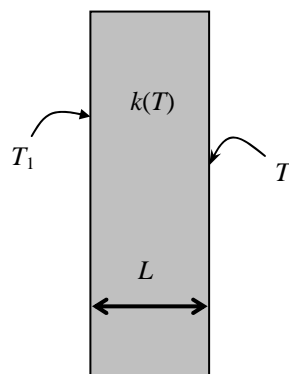

2-106 EES Prob. 2-105 is reconsidered. The rate of heat conduction through the plate as a function of the temperature of the hot side of the plate is to be plotted.

Analysis The problem is solved using EES, and the solution is given below.

"GIVEN"

A=1.5*0.6 [m^2]
 L=0.15 [m]
 T_1=500 [K]
 T_2=350 [K]
 k_0=25 [W/m-K]
 beta=8.7E-4 [1/K]

"ANALYSIS"

k=k_0*(1+beta*T)
 T=1/2*(T_1+T_2)
 Q_dot=k*A*(T_1-T_2)/L

T ₁ [W]	Q [W]
400	9947
425	15043
450	20220
475	25479
500	30819
525	36241
550	41745
575	47330
600	52997
625	58745
650	64575
675	70486
700	76479

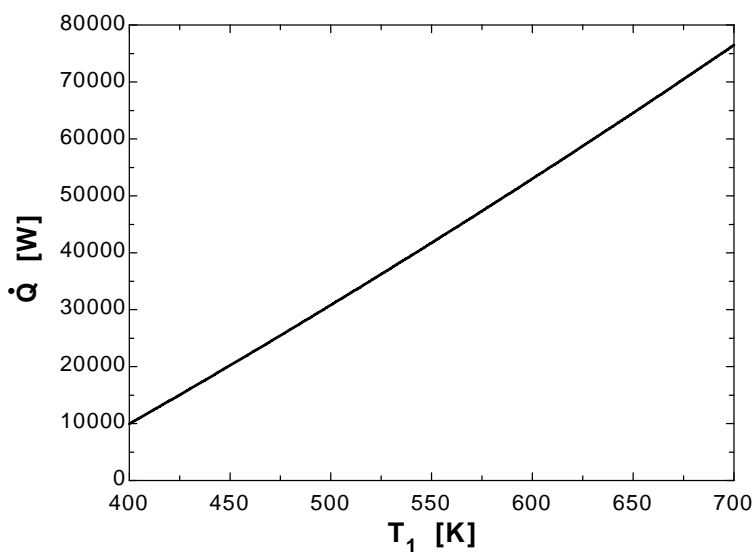

Special Topic: Review of Differential equations

2-107C We utilize appropriate simplifying assumptions when deriving differential equations to obtain an equation that we can deal with and solve.

2-108C A **variable** is a quantity which may assume various values during a study. A variable whose value can be changed arbitrarily is called an **independent variable** (or argument). A variable whose value depends on the value of other variables and thus cannot be varied independently is called a **dependent variable** (or a function).

2-109C A differential equation may involve more than one dependent or independent variable. For example, the equation $\frac{\partial^2 T(x,t)}{\partial x^2} + \frac{\dot{e}_{\text{gen}}}{k} = \frac{1}{\alpha} \frac{\partial T(x,t)}{\partial t}$ has one dependent (T) and 2 independent variables (x and t). the equation $\frac{\partial^2 T(x,t)}{\partial x^2} + \frac{\partial W(x,t)}{\partial x} = \frac{1}{\alpha} \frac{\partial T(x,t)}{\partial t} + \frac{1}{\alpha} \frac{\partial W(x,t)}{\partial t}$ has 2 dependent (T and W) and 2 independent variables (x and t).

2-110C Geometrically, the **derivative** of a function $y(x)$ at a point represents the *slope* of the tangent line to the graph of the function at that point. The derivative of a function that depends on two or more independent variables with respect to one variable while holding the other variables constant is called the partial derivative. Ordinary and partial derivatives are equivalent for functions that depend on a single independent variable.

2-111C The order of a derivative represents the number of times a function is differentiated, whereas the degree of a derivative represents how many times a derivative is multiplied by itself. For example, y''' is the third order derivative of y , whereas $(y')^3$ is the third degree of the first derivative of y .

2-112C For a function $f(x, y)$, the partial derivative $\partial f / \partial x$ will be equal to the ordinary derivative df / dx when f does not depend on y or this dependence is negligible.

2-113C For a function $f(x)$, the derivative df / dx does not have to be a function of x . The derivative will be a constant when the f is a linear function of x .

2-114C Integration is the inverse of derivation. Derivation increases the order of a derivative by one, integration reduces it by one.

2-115C A differential equation involves derivatives, an algebraic equation does not.

2-116C A differential equation that involves only ordinary derivatives is called an ordinary differential equation, and a differential equation that involves partial derivatives is called a partial differential equation.

2-117C The order of a differential equation is the order of the highest order derivative in the equation.

2-118C A differential equation is said to be **linear** if the dependent variable and all of its derivatives are of the first degree, and their coefficients depend on the independent variable only. In other words, a differential equation is linear if it can be written in a form which does not involve (1) any powers of the dependent variable or its derivatives such as y^3 or $(y')^2$, (2) any products of the dependent variable or its derivatives such as yy' or $y'y''$, and (3) any other nonlinear functions of the dependent variable such as $\sin y$ or e^y . Otherwise, it is **nonlinear**.

2-119C A linear homogeneous differential equation of order n is expressed in the most general form as

$$y^{(n)} + f_1(x)y^{(n-1)} + \cdots + f_{n-1}(x)y' + f_n(x)y = 0$$

Each term in a linear homogeneous equation contains the dependent variable or one of its derivatives after the equation is cleared of any common factors. The equation $y'' - 4x^2y = 0$ is linear and homogeneous since each term is linear in y , and contains the dependent variable or one of its derivatives.

2-120C A differential equation is said to have **constant coefficients** if the coefficients of all the terms which involve the dependent variable or its derivatives are constants. If, after cleared of any common factors, any of the terms with the dependent variable or its derivatives involve the independent variable as a coefficient, that equation is said to have **variable coefficients**. The equation $y'' - 4x^2y = 0$ has variable coefficients whereas the equation $y'' - 4y = 0$ has constant coefficients.

2-121C A linear differential equation that involves a single term with the derivatives can be solved by direct integration.

2-122C The general solution of a 3rd order linear and homogeneous differential equation will involve 3 arbitrary constants.

Review Problems

2-123 A small hot metal object is allowed to cool in an environment by convection. The differential equation that describes the variation of temperature of the ball with time is to be derived.

Assumptions **1** The temperature of the metal object changes uniformly with time during cooling so that $T = T(t)$. **2** The density, specific heat, and thermal conductivity of the body are constant. **3** There is no heat generation.

Analysis Consider a body of arbitrary shape of mass m , volume \mathcal{V} , surface area A , density ρ , and specific heat c_p initially at a uniform temperature T_i . At time $t = 0$, the body is placed into a medium at temperature T_∞ , and heat transfer takes place between the body and its environment with a heat transfer coefficient h .

During a differential time interval dt , the temperature of the body rises by a differential amount dT . Noting that the temperature changes with time only, an energy balance of the solid for the time interval dt can be expressed as

$$\left(\begin{array}{c} \text{Heat transfer from the body} \\ \text{during } dt \end{array} \right) = \left(\begin{array}{c} \text{The decrease in the energy} \\ \text{of the body during } dt \end{array} \right)$$

or $hA_s(T - T_\infty)dt = mc_p(-dT)$

Noting that $m = \rho\mathcal{V}$ and $dT = d(T - T_\infty)$ since $T_\infty = \text{constant}$, the equation above can be rearranged as

$$\frac{d(T - T_\infty)}{T - T_\infty} = -\frac{hA_s}{\rho\mathcal{V}c_p} dt$$

which is the desired differential equation.

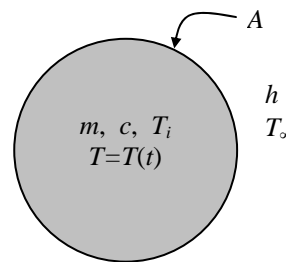

2-124 A long rectangular bar is initially at a uniform temperature of T_i . The surfaces of the bar at $x = 0$ and $y = 0$ are insulated while heat is lost from the other two surfaces by convection. The mathematical formulation of this heat conduction problem is to be expressed for transient two-dimensional heat transfer with no heat generation.

Assumptions **1** Heat transfer is transient and two-dimensional. **2** Thermal conductivity is constant. **3** There is no heat generation.

Analysis The differential equation and the boundary conditions for this heat conduction problem can be expressed as

$$\begin{aligned} \frac{\partial^2 T}{\partial x^2} + \frac{\partial^2 T}{\partial y^2} &= \frac{1}{\alpha} \frac{\partial T}{\partial t} \\ \frac{\partial T(x, 0, t)}{\partial x} &= 0 \\ \frac{\partial T(0, y, t)}{\partial x} &= 0 \\ -k \frac{\partial T(a, y, t)}{\partial x} &= h[T(a, y, t) - T_\infty] \\ -k \frac{\partial T(x, b, t)}{\partial x} &= h[T(x, b, t) - T_\infty] \\ T(x, y, 0) &= T_i \end{aligned}$$

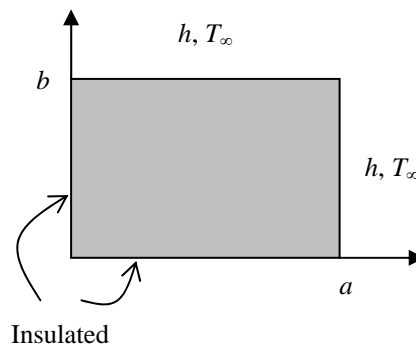

2-125 Heat is generated at a constant rate in a short cylinder. Heat is lost from the cylindrical surface at $r = r_o$ by convection to the surrounding medium at temperature T_∞ with a heat transfer coefficient of h . The bottom surface of the cylinder at $r = 0$ is insulated, the top surface at $z = H$ is subjected to uniform heat flux \dot{q}_H , and the cylindrical surface at $r = r_o$ is subjected to convection. The mathematical formulation of this problem is to be expressed for steady two-dimensional heat transfer.

Assumptions **1** Heat transfer is given to be steady and two-dimensional. **2** Thermal conductivity is constant. **3** Heat is generated uniformly.

Analysis The differential equation and the boundary conditions for this heat conduction problem can be expressed as

$$\begin{aligned} \frac{1}{r} \frac{\partial}{\partial r} \left(r \frac{\partial T}{\partial r} \right) + \frac{\partial^2 T}{\partial z^2} + \frac{\dot{e}_{\text{gen}}}{k} &= 0 \\ \frac{\partial T(r, 0)}{\partial z} &= 0 \\ k \frac{\partial T(r, H)}{\partial z} &= \dot{q}_H \\ \frac{\partial T(0, z)}{\partial r} &= 0 \\ -k \frac{\partial T(r_o, z)}{\partial r} &= h[T(r_o, z) - T_\infty] \end{aligned}$$

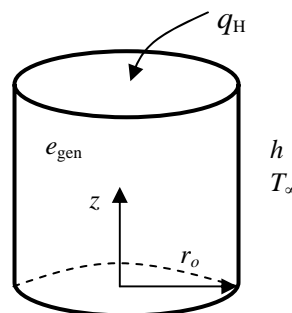

2-126E A large plane wall is subjected to a specified temperature on the left (inner) surface and solar radiation and heat loss by radiation to space on the right (outer) surface. The temperature of the right surface of the wall and the rate of heat transfer are to be determined when steady operating conditions are reached.

Assumptions **1** Steady operating conditions are reached. **2** Heat transfer is one-dimensional since the wall is large relative to its thickness, and the thermal conditions on both sides of the wall are uniform. **3** Thermal properties are constant. **4** There is no heat generation in the wall.

Properties The properties of the plate are given to be $k = 1.2$ Btu/h·ft·°F and $\varepsilon = 0.80$, and $\alpha_s = 0.60$.

Analysis In steady operation, heat conduction through the wall must be equal to net heat transfer from the outer surface. Therefore, taking the outer surface temperature of the plate to be T_2 (absolute, in R),

$$kA_s \frac{T_1 - T_2}{L} = \varepsilon \sigma A_s T_2^4 - \alpha_s A_s \dot{q}_{\text{solar}}$$

Canceling the area A and substituting the known quantities,

$$(1.2 \text{ Btu/h} \cdot \text{ft} \cdot ^\circ\text{F}) \frac{(520 \text{ R}) - T_2}{0.8 \text{ ft}} = 0.8(0.1714 \times 10^{-8} \text{ Btu/h} \cdot \text{ft}^2 \cdot \text{R}^4) T_2^4 - 0.60(300 \text{ Btu/h} \cdot \text{ft}^2)$$

Solving for T_2 gives the outer surface temperature to be $T_2 = 553.9 \text{ R}$

Then the rate of heat transfer through the wall becomes

$$\dot{q} = k \frac{T_1 - T_2}{L} = (1.2 \text{ Btu/h} \cdot \text{ft} \cdot ^\circ\text{F}) \frac{(520 - 553.9) \text{ R}}{0.8 \text{ ft}} = -50.9 \text{ Btu/h} \cdot \text{ft}^2 \quad (\text{per unit area})$$

Discussion The negative sign indicates that the direction of heat transfer is from the outside to the inside. Therefore, the structure is gaining heat.

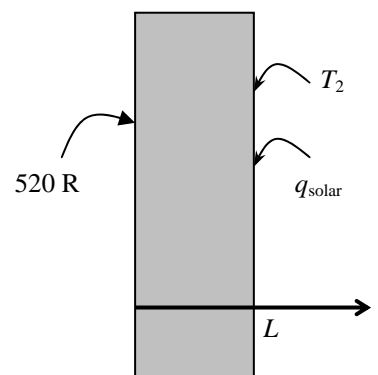

2-127E A large plane wall is subjected to a specified temperature on the left (inner) surface and heat loss by radiation to space on the right (outer) surface. The temperature of the right surface of the wall and the rate of heat transfer are to be determined when steady operating conditions are reached.

Assumptions 1 Steady operating conditions are reached. 2 Heat transfer is one-dimensional since the wall is large relative to its thickness, and the thermal conditions on both sides of the wall are uniform. 3 Thermal properties are constant. 4 There is no heat generation in the wall.

Properties The properties of the plate are given to be $k = 1.2$ Btu/h·ft·°F and $\varepsilon = 0.80$.

Analysis In steady operation, heat conduction through the wall must be equal to net heat transfer from the outer surface. Therefore, taking the outer surface temperature of the plate to be T_2 (absolute, in R),

$$kA_s \frac{T_1 - T_2}{L} = \varepsilon \sigma A_s T_2^4$$

Canceling the area A and substituting the known quantities,

$$(1.2 \text{ Btu/h} \cdot \text{ft} \cdot ^\circ\text{F}) \frac{(520 \text{ R}) - T_2}{0.5 \text{ ft}} = 0.8(0.1714 \times 10^{-8} \text{ Btu/h} \cdot \text{ft}^2 \cdot \text{R}^4) T_2^4$$

Solving for T_2 gives the outer surface temperature to be $T_2 = 487.7 \text{ R}$

Then the rate of heat transfer through the wall becomes

$$\dot{q} = k \frac{T_1 - T_2}{L} = (1.2 \text{ Btu/h} \cdot \text{ft} \cdot ^\circ\text{F}) \frac{(520 - 487.7) \text{ R}}{0.5 \text{ ft}} = 77.5 \text{ Btu/h} \cdot \text{ft}^2 \quad (\text{per unit area})$$

Discussion The positive sign indicates that the direction of heat transfer is from the inside to the outside. Therefore, the structure is losing heat as expected.

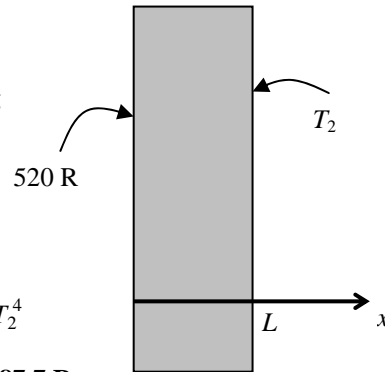

2-128 A steam pipe is subjected to convection on both the inner and outer surfaces. The mathematical formulation of the problem and expressions for the variation of temperature in the pipe and on the outer surface temperature are to be obtained for steady one-dimensional heat transfer.

Assumptions 1 Heat conduction is steady and one-dimensional since the pipe is long relative to its thickness, and there is thermal symmetry about the center line. **2** Thermal conductivity is constant. **3** There is no heat generation in the pipe.

Analysis (a) Noting that heat transfer is steady and one-dimensional in the radial r direction, the mathematical formulation of this problem can be expressed as

$$\frac{d}{dr} \left(r \frac{dT}{dr} \right) = 0$$

and
$$-k \frac{dT(r_1)}{dr} = h_i [T_i - T(r_1)]$$

$$-k \frac{dT(r_2)}{dr} = h_o [T(r_2) - T_o]$$

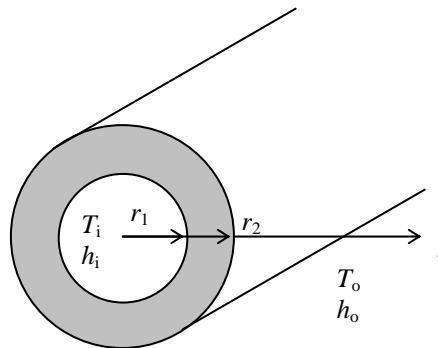

(b) Integrating the differential equation once with respect to r gives

$$r \frac{dT}{dr} = C_1$$

Dividing both sides of the equation above by r to bring it to a readily integrable form and then integrating,

$$\frac{dT}{dr} = \frac{C_1}{r}$$

$$T(r) = C_1 \ln r + C_2$$

where C_1 and C_2 are arbitrary constants. Applying the boundary conditions give

$$r = r_1: \quad -k \frac{C_1}{r_1} = h_i [T_i - (C_1 \ln r_1 + C_2)]$$

$$r = r_2: \quad -k \frac{C_1}{r_2} = h_o [(C_1 \ln r_2 + C_2) - T_o]$$

Solving for C_1 and C_2 simultaneously gives

$$C_1 = \frac{T_o - T_i}{\ln \frac{r_2}{r_1} + \frac{k}{h_i r_1} + \frac{k}{h_o r_2}} \quad \text{and} \quad C_2 = T_i - C_1 \left(\ln r_1 - \frac{k}{h_i r_1} \right) = T_i - \frac{T_o - T_i}{\ln \frac{r_2}{r_1} + \frac{k}{h_i r_1} + \frac{k}{h_o r_2}} \left(\ln r_1 - \frac{k}{h_i r_1} \right)$$

Substituting C_1 and C_2 into the general solution and simplifying, we get the variation of temperature to be

$$T(r) = C_1 \ln r + T_i - C_1 \left(\ln r_1 - \frac{k}{h_i r_1} \right) = T_i + \frac{\ln \frac{r}{r_1} + \frac{k}{h_i r_1}}{\ln \frac{r_2}{r_1} + \frac{k}{h_i r_1} + \frac{k}{h_o r_2}}$$

(c) The outer surface temperature is determined by simply replacing r in the relation above by r_2 . We get

$$T(r_2) = T_i + \frac{\ln \frac{r_2}{r_1} + \frac{k}{h_i r_1}}{\ln \frac{r_2}{r_1} + \frac{k}{h_i r_1} + \frac{k}{h_o r_2}}$$

2-129 A spherical liquid nitrogen container is subjected to specified temperature on the inner surface and convection on the outer surface. The mathematical formulation, the variation of temperature, and the rate of evaporation of nitrogen are to be determined for steady one-dimensional heat transfer.

Assumptions 1 Heat conduction is steady and one-dimensional since there is no change with time and there is thermal symmetry about the midpoint. **2** Thermal conductivity is constant. **3** There is no heat generation.

Properties The thermal conductivity of the tank is given to be $k = 18 \text{ W/m}\cdot\text{C}$. Also, $h_{fg} = 198 \text{ kJ/kg}$ for nitrogen.

Analysis (a) Noting that heat transfer is one-dimensional in the radial r direction, the mathematical formulation of this problem can be expressed as

$$\frac{d}{dr} \left(r^2 \frac{dT}{dr} \right) = 0$$

and $T(r_1) = T_1 = -196^\circ\text{C}$

$$-k \frac{dT(r_2)}{dr} = h[T(r_2) - T_\infty]$$

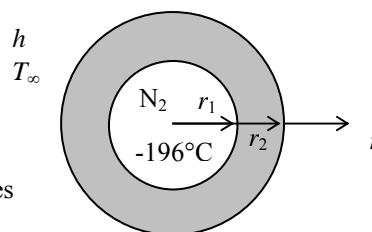

(b) Integrating the differential equation once with respect to r gives

$$r^2 \frac{dT}{dr} = C_1$$

Dividing both sides of the equation above by r to bring it to a readily integrable form and then integrating,

$$\frac{dT}{dr} = \frac{C_1}{r^2} \rightarrow T(r) = -\frac{C_1}{r} + C_2$$

where C_1 and C_2 are arbitrary constants. Applying the boundary conditions give

$$r = r_1: \quad T(r_1) = -\frac{C_1}{r_1} + C_2 = T_1$$

$$r = r_2: \quad -k \frac{C_1}{r_2^2} = h \left(-\frac{C_1}{r_2} + C_2 - T_\infty \right)$$

Solving for C_1 and C_2 simultaneously gives

$$C_1 = \frac{r_2(T_1 - T_\infty)}{1 - \frac{r_2}{r_1} - \frac{k}{hr_2}} \quad \text{and} \quad C_2 = T_1 + \frac{C_1}{r_1} = T_1 + \frac{T_1 - T_\infty}{1 - \frac{r_2}{r_1} - \frac{k}{hr_2}} \frac{r_2}{r_1}$$

Substituting C_1 and C_2 into the general solution, the variation of temperature is determined to be

$$\begin{aligned} T(r) &= -\frac{C_1}{r} + T_1 + \frac{C_1}{r_1} = C_1 \left(\frac{1}{r_1} - \frac{1}{r} \right) + T_1 = \frac{T_1 - T_\infty}{1 - \frac{r_2}{r_1} - \frac{k}{hr_2}} \left(\frac{r_2}{r_1} - \frac{r_2}{r} \right) + T_1 \\ &= \frac{(-196 - 20)^\circ\text{C}}{1 - \frac{2.1}{2} - \frac{18 \text{ W/m}\cdot\text{C}}{(25 \text{ W/m}^2\cdot\text{C})(2.1 \text{ m})}} \left(\frac{2.1}{2} - \frac{2.1}{r} \right) + (-196)^\circ\text{C} = 549.8(1.05 - 2.1/r) - 196 \end{aligned}$$

(c) The rate of heat transfer through the wall and the rate of evaporation of nitrogen are determined from

$$\begin{aligned} \dot{Q} &= -kA \frac{dT}{dx} = -k(4\pi r^2) \frac{C_1}{r^2} = -4\pi k C_1 = -4\pi k \frac{r_2(T_1 - T_\infty)}{1 - \frac{r_2}{r_1} - \frac{k}{hr_2}} \\ &= -4\pi(18 \text{ W/m}\cdot\text{C}) \frac{(2.1 \text{ m})(-196 - 20)^\circ\text{C}}{1 - \frac{2.1}{2} - \frac{18 \text{ W/m}\cdot\text{C}}{(25 \text{ W/m}^2\cdot\text{C})(2.1 \text{ m})}} = -261,200 \text{ W (to the tank since negative)} \end{aligned}$$

$$\dot{m} = \frac{\dot{Q}}{h_{fg}} = \frac{261,200 \text{ J/s}}{198,000 \text{ J/kg}} = \mathbf{1.32 \text{ kg/s}}$$

2-130 A spherical liquid oxygen container is subjected to specified temperature on the inner surface and convection on the outer surface. The mathematical formulation, the variation of temperature, and the rate of evaporation of oxygen are to be determined for steady one-dimensional heat transfer.

Assumptions 1 Heat conduction is steady and one-dimensional since there is no change with time and there is thermal symmetry about the midpoint. **2** Thermal conductivity is constant. **3** There is no heat generation.

Properties The thermal conductivity of the tank is given to be $k = 18 \text{ W/m}\cdot\text{°C}$. Also, $h_{fg} = 213 \text{ kJ/kg}$ for oxygen.

Analysis (a) Noting that heat transfer is one-dimensional in the radial r direction, the mathematical formulation of this problem can be expressed as

$$\frac{d}{dr} \left(r^2 \frac{dT}{dr} \right) = 0$$

and $T(r_1) = T_1 = -183^\circ\text{C}$

$$-k \frac{dT(r_2)}{dr} = h[T(r_2) - T_\infty]$$

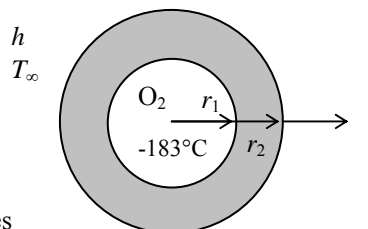

(b) Integrating the differential equation once with respect to r gives

$$r^2 \frac{dT}{dr} = C_1$$

Dividing both sides of the equation above by r to bring it to a readily integrable form and then integrating,

$$\frac{dT}{dr} = \frac{C_1}{r^2} \quad \rightarrow \quad T(r) = -\frac{C_1}{r} + C_2$$

where C_1 and C_2 are arbitrary constants. Applying the boundary conditions give

$$r = r_1: \quad T(r_1) = -\frac{C_1}{r_1} + C_2 = T_1$$

$$r = r_2: \quad -k \frac{C_1}{r_2^2} = h \left(-\frac{C_1}{r_2} + C_2 - T_\infty \right)$$

Solving for C_1 and C_2 simultaneously gives

$$C_1 = \frac{r_2(T_1 - T_\infty)}{1 - \frac{r_2}{r_1} - \frac{k}{hr_2}} \quad \text{and} \quad C_2 = T_1 + \frac{C_1}{r_1} = T_1 + \frac{T_1 - T_\infty}{1 - \frac{r_2}{r_1} - \frac{k}{hr_2}} \frac{r_2}{r_1}$$

Substituting C_1 and C_2 into the general solution, the variation of temperature is determined to be

$$\begin{aligned} T(r) &= -\frac{C_1}{r} + T_1 + \frac{C_1}{r_1} = C_1 \left(\frac{1}{r_1} - \frac{1}{r} \right) + T_1 = \frac{T_1 - T_\infty}{1 - \frac{r_2}{r_1} - \frac{k}{hr_2}} \left(\frac{r_2}{r_1} - \frac{r_2}{r} \right) + T_1 \\ &= \frac{(-183 - 20)^\circ\text{C}}{1 - \frac{2.1}{2} - \frac{18 \text{ W/m}\cdot\text{°C}}{(25 \text{ W/m}^2 \cdot \text{°C})(2.1 \text{ m})}} \left(\frac{2.1}{2} - \frac{2.1}{r} \right) + (-183)^\circ\text{C} = 516.7(1.05 - 2.1/r) - 183 \end{aligned}$$

(c) The rate of heat transfer through the wall and the rate of evaporation of oxygen are determined from

$$\begin{aligned} \dot{Q} &= -kA \frac{dT}{dx} = -k(4\pi r^2) \frac{C_1}{r^2} = -4\pi k C_1 = -4\pi k \frac{r_2(T_1 - T_\infty)}{1 - \frac{r_2}{r_1} - \frac{k}{hr_2}} \\ &= -4\pi(18 \text{ W/m}\cdot\text{°C}) \frac{(2.1 \text{ m})(-183 - 20)^\circ\text{C}}{1 - \frac{2.1}{2} - \frac{18 \text{ W/m}\cdot\text{°C}}{(25 \text{ W/m}^2 \cdot \text{°C})(2.1 \text{ m})}} = \mathbf{-245,450 \text{ W}} \quad (\text{to the tank since negative}) \end{aligned}$$

$$\dot{m} = \frac{\dot{Q}}{h_{fg}} = \frac{245,450 \text{ J/s}}{213,000 \text{ J/kg}} = \mathbf{1.15 \text{ kg/s}}$$

2-131 A large plane wall is subjected to convection, radiation, and specified temperature on the right surface and no conditions on the left surface. The mathematical formulation, the variation of temperature in the wall, and the left surface temperature are to be determined for steady one-dimensional heat transfer.

Assumptions 1 Heat conduction is steady and one-dimensional since the wall is large relative to its thickness, and the thermal conditions on both sides of the wall are uniform. **2** Thermal conductivity is constant. **3** There is no heat generation in the wall.

Properties The thermal conductivity and emissivity are given to be $k = 8.4 \text{ W/m}\cdot\text{°C}$ and $\varepsilon = 0.7$.

Analysis (a) Taking the direction normal to the surface of the wall to be the x direction with $x = 0$ at the left surface, and the mathematical formulation of this problem can be expressed as

$$\frac{d^2T}{dx^2} = 0$$

$$\text{and } -k \frac{dT(L)}{dx} = h[T(L) - T_\infty] + \varepsilon\sigma[T(L)^4 - T_{\text{surr}}^4] = h[T_2 - T_\infty] + \varepsilon\sigma[(T_2 + 273)^4 - T_{\text{surr}}^4]$$

$$T(L) = T_2 = 45^\circ\text{C}$$

(b) Integrating the differential equation twice with respect to x yields

$$\frac{dT}{dx} = C_1$$

$$T(x) = C_1x + C_2$$

where C_1 and C_2 are arbitrary constants. Applying the boundary conditions give

$$\begin{aligned} \text{Convection at } x = L \quad & -kC_1 = h[T_2 - T_\infty] + \varepsilon\sigma[(T_2 + 273)^4 - T_{\text{surr}}^4] \\ \rightarrow C_1 = & -\{h[T_2 - T_\infty] + \varepsilon\sigma[(T_2 + 273)^4 - T_{\text{surr}}^4]\} / k \end{aligned}$$

$$\text{Temperature at } x = L: \quad T(L) = C_1 \times L + C_2 = T_2 \rightarrow C_2 = T_2 - C_1L$$

Substituting C_1 and C_2 into the general solution, the variation of temperature is determined to be

$$\begin{aligned} T(x) &= C_1x + (T_2 - C_1L) = T_2 - (L-x)C_1 = T_2 + \frac{h[T_2 - T_\infty] + \varepsilon\sigma[(T_2 + 273)^4 - T_{\text{surr}}^4]}{k}(L-x) \\ &= 45^\circ\text{C} + \frac{(14 \text{ W/m}^2 \cdot \text{°C})(45 - 25)^\circ\text{C} + 0.7(5.67 \times 10^{-8} \text{ W/m}^2 \cdot \text{K}^4)[(318\text{K})^4 - (290\text{K})^4]}{8.4 \text{ W/m}\cdot\text{°C}}(0.4 - x) \text{ m} \\ &= 45 + 48.23(0.4 - x) \end{aligned}$$

(c) The temperature at $x = 0$ (the left surface of the wall) is

$$T(0) = 45 + 48.23(0.4 - 0) = \mathbf{64.3^\circ\text{C}}$$

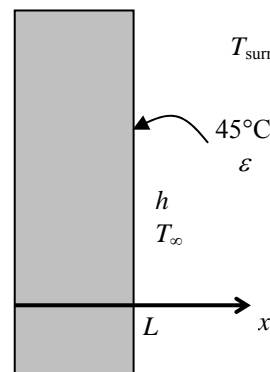

2-132 The base plate of an iron is subjected to specified heat flux on the left surface and convection and radiation on the right surface. The mathematical formulation, and an expression for the outer surface temperature and its value are to be determined for steady one-dimensional heat transfer.

Assumptions 1 Heat conduction is steady and one-dimensional. 2 Thermal conductivity is constant. 3 There is no heat generation. 4 Heat loss through the upper part of the iron is negligible.

Properties The thermal conductivity and emissivity are given to be $k = 18 \text{ W/m}\cdot\text{°C}$ and $\varepsilon = 0.7$.

Analysis (a) Noting that the upper part of the iron is well insulated and thus the entire heat generated in the resistance wires is transferred to the base plate, the heat flux through the inner surface is determined to be

$$\dot{q}_0 = \frac{\dot{Q}_0}{A_{\text{base}}} = \frac{1000 \text{ W}}{150 \times 10^{-4} \text{ m}^2} = 66,667 \text{ W/m}^2$$

Taking the direction normal to the surface of the wall to be the x direction with $x = 0$ at the left surface, the mathematical formulation of this problem can be expressed as

$$\frac{d^2 T}{dx^2} = 0$$

and
$$-k \frac{dT(0)}{dx} = \dot{q}_0 = 66,667 \text{ W/m}^2$$

$$-k \frac{dT(L)}{dx} = h[T(L) - T_\infty] + \varepsilon\sigma[T(L)^4 - T_{\text{surr}}^4] = h[T_2 - T_\infty] + \varepsilon\sigma[(T_2 + 273)^4 - T_{\text{surr}}^4]$$

(b) Integrating the differential equation twice with respect to x yields

$$\frac{dT}{dx} = C_1$$

$$T(x) = C_1 x + C_2$$

where C_1 and C_2 are arbitrary constants. Applying the boundary conditions give

$$x = 0: \quad -kC_1 = \dot{q}_0 \rightarrow C_1 = -\frac{\dot{q}_0}{k}$$

$$x = L: \quad -kC_1 = h[T_2 - T_\infty] + \varepsilon\sigma[(T_2 + 273)^4 - T_{\text{surr}}^4]$$

Eliminating the constant C_1 from the two relations above gives the following expression for the outer surface temperature T_2 ,

$$h(T_2 - T_\infty) + \varepsilon\sigma[(T_2 + 273)^4 - T_{\text{surr}}^4] = \dot{q}_0$$

(c) Substituting the known quantities into the implicit relation above gives

$$(30 \text{ W/m}^2 \cdot \text{°C})(T_2 - 26) + 0.7(5.67 \times 10^{-8} \text{ W/m}^2 \cdot \text{K}^4)[(T_2 + 273)^4 - 295^4] = 66,667 \text{ W/m}^2$$

Using an equation solver (or a trial and error approach), the outer surface temperature is determined from the relation above to be

$$T_2 = \mathbf{759^\circ\text{C}}$$

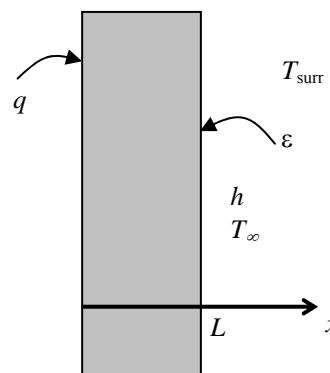

2-133 The base plate of an iron is subjected to specified heat flux on the left surface and convection and radiation on the right surface. The mathematical formulation, and an expression for the outer surface temperature and its value are to be determined for steady one-dimensional heat transfer.

Assumptions 1 Heat conduction is steady and one-dimensional. **2** Thermal conductivity is constant. **3** There is no heat generation. **4** Heat loss through the upper part of the iron is negligible.

Properties The thermal conductivity and emissivity are given to be $k = 18 \text{ W/m}\cdot\text{°C}$ and $\varepsilon = 0.7$.

Analysis (a) Noting that the upper part of the iron is well insulated and thus the entire heat generated in the resistance wires is transferred to the base plate, the heat flux through the inner surface is determined to be

$$\dot{q}_0 = \frac{\dot{Q}_0}{A_{\text{base}}} = \frac{1500 \text{ W}}{150 \times 10^{-4} \text{ m}^2} = 100,000 \text{ W/m}^2$$

Taking the direction normal to the surface of the wall to be the x direction with $x = 0$ at the left surface, the mathematical formulation of this problem can be expressed as

$$\frac{d^2 T}{dx^2} = 0$$

and
$$-k \frac{dT(0)}{dx} = \dot{q}_0 = 100,000 \text{ W/m}^2$$

$$-k \frac{dT(L)}{dx} = h[T(L) - T_\infty] + \varepsilon\sigma[T(L)^4 - T_{\text{surr}}^4] = h[T_2 - T_\infty] + \varepsilon\sigma[(T_2 + 273)^4 - T_{\text{surr}}^4]$$

(b) Integrating the differential equation twice with respect to x yields

$$\frac{dT}{dx} = C_1$$

$$T(x) = C_1 x + C_2$$

where C_1 and C_2 are arbitrary constants. Applying the boundary conditions give

$$x = 0: \quad -kC_1 = \dot{q}_0 \rightarrow C_1 = -\frac{\dot{q}_0}{k}$$

$$x = L: \quad -kC_1 = h[T_2 - T_\infty] + \varepsilon\sigma[(T_2 + 273)^4 - T_{\text{surr}}^4]$$

Eliminating the constant C_1 from the two relations above gives the following expression for the outer surface temperature T_2 ,

$$h(T_2 - T_\infty) + \varepsilon\sigma[(T_2 + 273)^4 - T_{\text{surr}}^4] = \dot{q}_0$$

(c) Substituting the known quantities into the implicit relation above gives

$$(30 \text{ W/m}^2 \cdot \text{°C})(T_2 - 26) + 0.7(5.67 \times 10^{-8} \text{ W/m}^2 \cdot \text{K}^4)[(T_2 + 273)^4 - 295^4] = 100,000 \text{ W/m}^2$$

Using an equation solver (or a trial and error approach), the outer surface temperature is determined from the relation above to be

$$T_2 = \mathbf{896^\circ\text{C}}$$

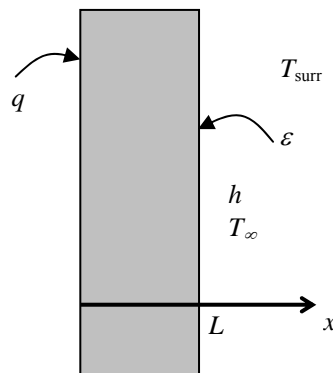

2-134E The concrete slab roof of a house is subjected to specified temperature at the bottom surface and convection and radiation at the top surface. The temperature of the top surface of the roof and the rate of heat transfer are to be determined when steady operating conditions are reached.

Assumptions 1 Steady operating conditions are reached. 2 Heat transfer is one-dimensional since the roof area is large relative to its thickness, and the thermal conditions on both sides of the roof are uniform. 3 Thermal properties are constant. 4 There is no heat generation in the wall.

Properties The thermal conductivity and emissivity are given to be $k = 1.1 \text{ Btu/h}\cdot\text{ft}\cdot^\circ\text{F}$ and $\varepsilon = 0.8$.

Analysis In steady operation, heat conduction through the roof must be equal to net heat transfer from the outer surface. Therefore, taking the outer surface temperature of the roof to be T_2 (in $^\circ\text{F}$),

$$kA \frac{T_1 - T_2}{L} = hA(T_2 - T_\infty) + \varepsilon A \sigma [(T_2 + 460)^4 - T_{\text{sky}}^4]$$

Canceling the area A and substituting the known quantities,

$$(1.1 \text{ Btu/h}\cdot\text{ft}\cdot^\circ\text{F}) \frac{(62 - T_2)^\circ\text{F}}{0.8 \text{ ft}} = (3.2 \text{ Btu/h}\cdot\text{ft}^2\cdot^\circ\text{F})(T_2 - 50)^\circ\text{F} + 0.8(0.1714 \times 10^{-8} \text{ Btu/h}\cdot\text{ft}^2\cdot\text{R}^4)[(T_2 + 460)^4 - 310^4] \text{R}^4$$

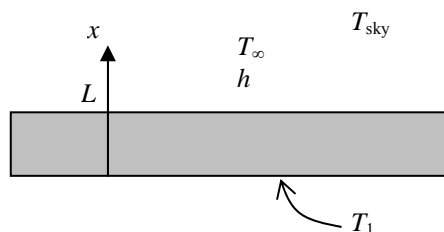

Using an equation solver (or the trial and error method), the outer surface temperature is determined to be

$$T_2 = \mathbf{38^\circ\text{F}}$$

Then the rate of heat transfer through the roof becomes

$$\dot{Q} = kA \frac{T_1 - T_2}{L} = (1.1 \text{ Btu/h}\cdot\text{ft}\cdot^\circ\text{F})(25 \times 35 \text{ ft}^2) \frac{(62 - 38)^\circ\text{F}}{0.8 \text{ ft}} = \mathbf{28,875 \text{ Btu/h}}$$

Discussion The positive sign indicates that the direction of heat transfer is from the inside to the outside. Therefore, the house is losing heat as expected.

2-135 The surface and interface temperatures of a resistance wire covered with a plastic layer are to be determined.

Assumptions 1 Heat transfer is steady since there is no change with time. **2** Heat transfer is one-dimensional since this two-layer heat transfer problem possesses symmetry about the center line and involves no change in the axial direction, and thus $T = T(r)$. **3** Thermal conductivities are constant. **4** Heat generation in the wire is uniform.

Properties It is given that $k_{\text{wire}} = 18 \text{ W/m} \cdot ^\circ\text{C}$ and $k_{\text{plastic}} = 1.8 \text{ W/m} \cdot ^\circ\text{C}$.

Analysis Letting T_I denote the unknown interface temperature, the mathematical formulation of the heat transfer problem in the wire can be expressed as

$$\frac{1}{r} \frac{d}{dr} \left(r \frac{dT}{dr} \right) + \frac{\dot{e}_{\text{gen}}}{k} = 0$$

with $T(r_1) = T_I$ and $\frac{dT(0)}{dr} = 0$

Multiplying both sides of the differential equation by r , rearranging, and integrating give

$$\frac{d}{dr} \left(r \frac{dT}{dr} \right) = -\frac{\dot{e}_{\text{gen}}}{k} r \rightarrow r \frac{dT}{dr} = -\frac{\dot{e}_{\text{gen}}}{k} \frac{r^2}{2} + C_1 \quad (a)$$

Applying the boundary condition at the center ($r = 0$) gives

B.C. at $r = 0$: $0 \times \frac{dT(0)}{dr} = -\frac{\dot{e}_{\text{gen}}}{2k} \times 0 + C_1 \rightarrow C_1 = 0$

Dividing both sides of Eq. (a) by r to bring it to a readily integrable form and integrating,

$$\frac{dT}{dr} = -\frac{\dot{e}_{\text{gen}}}{2k} r \rightarrow T(r) = -\frac{\dot{e}_{\text{gen}}}{4k} r^2 + C_2 \quad (b)$$

Applying the other boundary condition at $r = r_1$,

B. C. at $r = r_1$: $T_I = -\frac{\dot{e}_{\text{gen}}}{4k} r_1^2 + C_2 \rightarrow C_2 = T_I + \frac{\dot{e}_{\text{gen}}}{4k} r_1^2$

Substituting this C_2 relation into Eq. (b) and rearranging give

$$T_{\text{wire}}(r) = T_I + \frac{\dot{e}_{\text{gen}}}{4k_{\text{wire}}} (r_1^2 - r^2) \quad (c)$$

Plastic layer The mathematical formulation of heat transfer problem in the plastic can be expressed as

$$\frac{d}{dr} \left(r \frac{dT}{dr} \right) = 0$$

with $T(r_1) = T_I$ and $-k \frac{dT(r_2)}{dr} = h[T(r_2) - T_\infty]$

The solution of the differential equation is determined by integration to be

$$r \frac{dT}{dr} = C_1 \rightarrow \frac{dT}{dr} = \frac{C_1}{r} \rightarrow T(r) = C_1 \ln r + C_2$$

where C_1 and C_2 are arbitrary constants. Applying the boundary conditions give

$r = r_1$: $C_1 \ln r_1 + C_2 = T_I \rightarrow C_2 = T_I - C_1 \ln r_1$

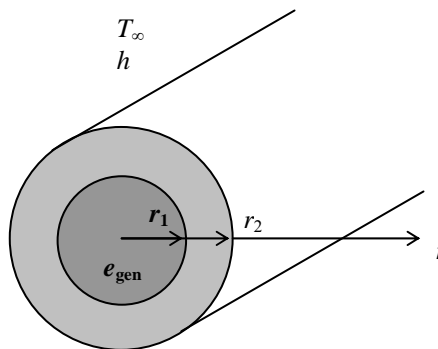

$$r = r_2: \quad -k \frac{C_1}{r_2} = h[(C_1 \ln r_2 + C_2) - T_\infty] \quad \rightarrow \quad C_1 = \frac{T_\infty - T_I}{\ln \frac{r_2}{r_1} + \frac{k}{hr_2}}$$

Substituting C_1 and C_2 into the general solution, the variation of temperature in plastic is determined to be

$$T_{\text{plastic}}(r) = C_1 \ln r + T_I - C_1 \ln r_1 = T_I + \frac{T_\infty - T_I}{\ln \frac{r_2}{r_1} + \frac{k_{\text{plastic}}}{hr_2}} \ln \frac{r}{r_1}$$

We have already utilized the first interface condition by setting the wire and plastic layer temperatures equal to T_I at the interface $r = r_1$. The interface temperature T_I is determined from the second interface condition that the heat flux in the wire and the plastic layer at $r = r_1$ must be the same:

$$-k_{\text{wire}} \frac{dT_{\text{wire}}(r_1)}{dr} = -k_{\text{plastic}} \frac{dT_{\text{plastic}}(r_1)}{dr} \quad \rightarrow \quad \frac{\dot{e}_{\text{gen}} r_1}{2} = -k_{\text{plastic}} \frac{T_\infty - T_I}{\ln \frac{r_2}{r_1} + \frac{k_{\text{plastic}}}{hr_2}} \frac{1}{r_1}$$

Solving for T_I and substituting the given values, the interface temperature is determined to be

$$\begin{aligned} T_I &= \frac{\dot{e}_{\text{gen}} r_1^2}{2k_{\text{plastic}}} \left(\ln \frac{r_2}{r_1} + \frac{k_{\text{plastic}}}{hr_2} \right) + T_\infty \\ &= \frac{(1.5 \times 10^6 \text{ W/m}^3)(0.003 \text{ m})^2}{2(1.8 \text{ W/m} \cdot ^\circ\text{C})} \left(\ln \frac{0.007 \text{ m}}{0.003 \text{ m}} + \frac{1.8 \text{ W/m} \cdot ^\circ\text{C}}{(14 \text{ W/m}^2 \cdot ^\circ\text{C})(0.007 \text{ m})} \right) + 25^\circ\text{C} = \mathbf{97.1^\circ\text{C}} \end{aligned}$$

Knowing the interface temperature, the temperature at the center line ($r = 0$) is obtained by substituting the known quantities into Eq. (c),

$$T_{\text{wire}}(0) = T_I + \frac{\dot{e}_{\text{gen}} r_1^2}{4k_{\text{wire}}} = 97.1^\circ\text{C} + \frac{(1.5 \times 10^6 \text{ W/m}^3)(0.003 \text{ m})^2}{4 \times (18 \text{ W/m} \cdot ^\circ\text{C})} = \mathbf{97.3^\circ\text{C}}$$

Thus the temperature of the centerline will be slightly above the interface temperature.

2-136 A cylindrical shell with variable conductivity is subjected to specified temperatures on both sides. The rate of heat transfer through the shell is to be determined.

Assumptions 1 Heat transfer is given to be steady and one-dimensional. 2 Thermal conductivity varies quadratically. 3 There is no heat generation.

Properties The thermal conductivity is given to be

$$k(T) = k_0(1 + \beta T^2).$$

Analysis When the variation of thermal conductivity with temperature $k(T)$ is known, the average value of the thermal conductivity in the temperature range between T_1 and T_2 is determined from

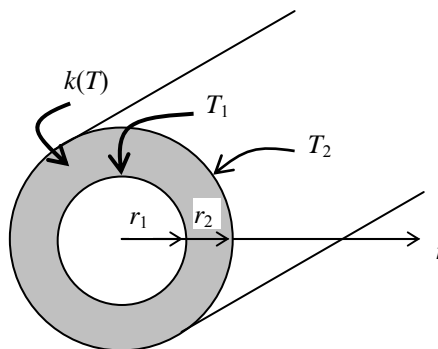

$$\begin{aligned} k_{\text{avg}} &= \frac{\int_{T_1}^{T_2} k(T) dT}{T_2 - T_1} = \frac{\int_{T_1}^{T_2} k_0(1 + \beta T^2) dT}{T_2 - T_1} = \frac{k_0 \left(T + \frac{\beta}{3} T^3 \right) \Big|_{T_1}^{T_2}}{T_2 - T_1} = \frac{k_0 \left[(T_2 - T_1) + \frac{\beta}{3} (T_2^3 - T_1^3) \right]}{T_2 - T_1} \\ &= k_0 \left[1 + \frac{\beta}{3} (T_2^2 + T_1 T_2 + T_1^2) \right] \end{aligned}$$

This relation is based on the requirement that the rate of heat transfer through a medium with constant average thermal conductivity k_{avg} equals the rate of heat transfer through the same medium with variable conductivity $k(T)$.

Then the rate of heat conduction through the cylindrical shell can be determined from Eq. 2-77 to be

$$\dot{Q}_{\text{cylinder}} = 2\pi k_{\text{avg}} L \frac{T_1 - T_2}{\ln(r_2 / r_1)} = 2\pi k_0 \left[1 + \frac{\beta}{3} (T_2^2 + T_1 T_2 + T_1^2) \right] L \frac{T_1 - T_2}{\ln(r_2 / r_1)}$$

Discussion We would obtain the same result if we substituted the given $k(T)$ relation into the second part of Eq. 2-77, and performed the indicated integration.

2-137 Heat is generated uniformly in a cylindrical uranium fuel rod. The temperature difference between the center and the surface of the fuel rod is to be determined.

Assumptions 1 Heat transfer is steady since there is no indication of any change with time. 2 Heat transfer is one-dimensional since there is thermal symmetry about the center line and no change in the axial direction. 3 Thermal conductivity is constant. 4 Heat generation is uniform.

Properties The thermal conductivity of uranium at room temperature is $k = 27.6 \text{ W/m}\cdot^\circ\text{C}$ (Table A-3).

Analysis The temperature difference between the center and the surface of the fuel rods is determined from

$$T_o - T_s = \frac{\dot{e}_{\text{gen}} r_o^2}{4k} = \frac{(4 \times 10^7 \text{ W/m}^3)(0.016 \text{ m})^2}{4(27.6 \text{ W/m}\cdot^\circ\text{C})} = \mathbf{92.8^\circ\text{C}}$$

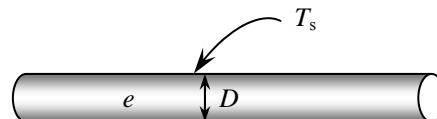

2-138 A large plane wall is subjected to convection on the inner and outer surfaces. The mathematical formulation, the variation of temperature, and the temperatures at the inner and outer surfaces to be determined for steady one-dimensional heat transfer.

Assumptions 1 Heat conduction is steady and one-dimensional. **2** Thermal conductivity is constant. **3** There is no heat generation.

Properties The thermal conductivity is given to be $k = 0.77 \text{ W/m}\cdot\text{C}$.

Analysis (a) Taking the direction normal to the surface of the wall to be the x direction with $x = 0$ at the inner surface, the mathematical formulation of this problem can be expressed as

$$\frac{d^2T}{dx^2} = 0$$

and

$$h_1[T_{\infty 1} - T(0)] = -k \frac{dT(0)}{dx}$$

$$-k \frac{dT(L)}{dx} = h_2[T(L) - T_{\infty 2}]$$

(b) Integrating the differential equation twice with respect to x yields

$$\frac{dT}{dx} = C_1$$

$$T(x) = C_1x + C_2$$

where C_1 and C_2 are arbitrary constants. Applying the boundary conditions give

$$x = 0: \quad h_1[T_{\infty 1} - (C_1 \times 0 + C_2)] = -kC_1$$

$$x = L: \quad -kC_1 = h_2[(C_1L + C_2) - T_{\infty 2}]$$

Substituting the given values, these equations can be written as

$$5(27 - C_2) = -0.77C_1$$

$$-0.77C_1 = (12)(0.2C_1 + C_2 - 8)$$

Solving these equations simultaneously give

$$C_1 = -45.45 \quad C_2 = 20$$

Substituting C_1 and C_2 into the general solution, the variation of temperature is determined to be

$$T(x) = 20 - 45.45x$$

(c) The temperatures at the inner and outer surfaces are

$$T(0) = 20 - 45.45 \times 0 = \mathbf{20^\circ\text{C}}$$

$$T(L) = 20 - 45.45 \times 0.2 = \mathbf{10.9^\circ\text{C}}$$

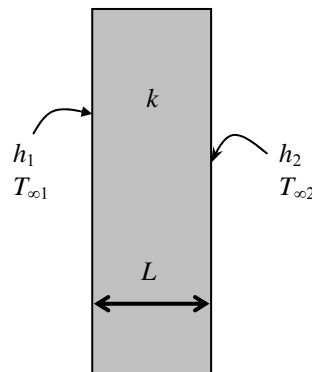

2-139 A hollow pipe is subjected to specified temperatures at the inner and outer surfaces. There is also heat generation in the pipe. The variation of temperature in the pipe and the center surface temperature of the pipe are to be determined for steady one-dimensional heat transfer.

Assumptions 1 Heat conduction is steady and one-dimensional since the pipe is long relative to its thickness, and there is thermal symmetry about the centerline. **2** Thermal conductivity is constant.

Properties The thermal conductivity is given to be $k = 14 \text{ W/m}\cdot^\circ\text{C}$.

Analysis The rate of heat generation is determined from

$$\dot{e}_{\text{gen}} = \frac{\dot{W}}{\mathcal{V}} = \frac{\dot{W}}{\pi(D_2^2 - D_1^2)L/4} = \frac{25,000 \text{ W}}{\pi[(0.4 \text{ m})^2 - (0.3 \text{ m})^2](17 \text{ m})/4} = 26,750 \text{ W/m}^3$$

Noting that heat transfer is one-dimensional in the radial r direction, the mathematical formulation of this problem can be expressed as

$$\frac{1}{r} \frac{d}{dr} \left(r \frac{dT}{dr} \right) + \frac{\dot{e}_{\text{gen}}}{k} = 0$$

and $T(r_1) = T_1 = 60^\circ\text{C}$

$T(r_2) = T_2 = 80^\circ\text{C}$

Rearranging the differential equation

$$\frac{d}{dr} \left(r \frac{dT}{dr} \right) = \frac{-\dot{e}_{\text{gen}} r}{k} = 0$$

and then integrating once with respect to r ,

$$r \frac{dT}{dr} = \frac{-\dot{e}_{\text{gen}} r^2}{2k} + C_1$$

Rearranging the differential equation again

$$\frac{dT}{dr} = \frac{-\dot{e}_{\text{gen}} r}{2k} + \frac{C_1}{r}$$

and finally integrating again with respect to r , we obtain

$$T(r) = \frac{-\dot{e}_{\text{gen}} r^2}{4k} + C_1 \ln r + C_2$$

where C_1 and C_2 are arbitrary constants. Applying the boundary conditions give

$$r = r_1: \quad T(r_1) = \frac{-\dot{e}_{\text{gen}} r_1^2}{4k} + C_1 \ln r_1 + C_2$$

$$r = r_2: \quad T(r_2) = \frac{-\dot{e}_{\text{gen}} r_2^2}{4k} + C_1 \ln r_2 + C_2$$

Substituting the given values, these equations can be written as

$$60 = \frac{-(26,750)(0.15)^2}{4(14)} + C_1 \ln(0.15) + C_2$$

$$80 = \frac{-(26,750)(0.20)^2}{4(14)} + C_1 \ln(0.20) + C_2$$

Solving for C_1 and C_2 simultaneously gives

$$C_1 = 98.58 \quad C_2 = 257.8$$

Substituting C_1 and C_2 into the general solution, the variation of temperature is determined to be

$$T(r) = \frac{-26,750r^2}{4(14)} + 98.58 \ln r + 257.8 = 257.8 - 477.7r^2 + 98.58 \ln r$$

The temperature at the center surface of the pipe is determined by setting radius r to be 17.5 cm, which is the average of the inner radius and outer radius.

$$T(r) = 257.8 - 477.7(0.175)^2 + 98.58 \ln(0.175) = \mathbf{71.3^\circ\text{C}}$$

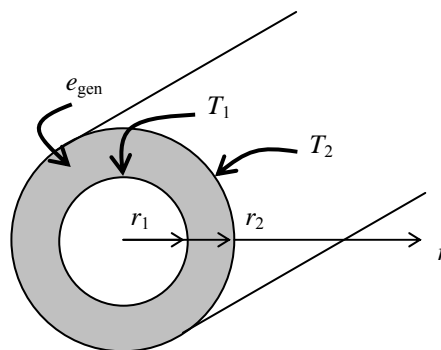

2-140 Heat is generated in a plane wall. Heat is supplied from one side which is insulated while the other side is subjected to convection with water. The convection coefficient, the variation of temperature in the wall, and the location and the value of the maximum temperature in the wall are to be determined.

Assumptions 1 Heat transfer is steady since there is no indication of any change with time. 2 Heat transfer is one-dimensional since the wall is large relative to its thickness. 3 Thermal conductivity is constant. 4 Heat generation is uniform.

Analysis (a) Noting that the heat flux and the heat generated will be transferred to the water, the heat transfer coefficient is determined from the Newton's law of cooling to be

$$h = \frac{\dot{q}_s + \dot{e}_{\text{gen}} L}{T_s - T_\infty} = \frac{(16,000 \text{ W/m}^2) + (10^5 \text{ W/m}^3)(0.04 \text{ m})}{(90 - 40)^\circ\text{C}} = 400 \text{ W/m}^2 \cdot ^\circ\text{C}$$

(b) The variation of temperature in the wall is in the form of $T(x) = ax^2 + bx + c$. First, the coefficient a is determined as follows

$$k \frac{d^2 T}{dx^2} + \dot{e}_{\text{gen}} = 0 \quad \rightarrow \quad k \frac{d^2 T}{dx^2} = -\frac{\dot{e}_{\text{gen}}}{k}$$

$$\frac{dT}{dx} = -\frac{\dot{e}_{\text{gen}}}{k} x + b \quad \text{and} \quad T = -\frac{\dot{e}_{\text{gen}}}{2k} x^2 + bx + c \quad \rightarrow$$

$$a = -\frac{\dot{e}_{\text{gen}}}{2k} = \frac{10^5 \text{ W/m}^3}{2(20 \text{ W/m} \cdot ^\circ\text{C})} = -2500^\circ\text{C/m}^2$$

Applying the first boundary condition:

$$x = 0, \quad T(0) = T_s \rightarrow c = T_s = 90^\circ\text{C}$$

As the second boundary condition, we can use either

$$-k \left. \frac{dT}{dx} \right|_{x=L} = -q_s \rightarrow k \left(-\frac{\dot{e}_{\text{gen}} L}{k} + b \right) = q_s \rightarrow b = \frac{1}{k} (q_s + \dot{e}_{\text{gen}} L) = \frac{1}{20} (16000 + 10^5 \times 0.04) = 1000^\circ\text{C/m}$$

or

$$-k \left. \frac{dT}{dx} \right|_{x=0} = -h(T_s - T_\infty)$$

$$k(a \times 0 + b) = h(T_s - T_\infty) \rightarrow b = \frac{400}{20} (90 - 40) = 1000^\circ\text{C/m}$$

Substituting the coefficients, the variation of temperature becomes

$$T(x) = -2500x^2 + 1000x + 90$$

(c) The x -coordinate of T_{max} is $x_{\text{vertex}} = -b/(2a) = 1000/(2 \times 2500) = 0.2 \text{ m} = 20 \text{ cm}$. This is outside of the wall boundary, to the left, so T_{max} is at the left surface of the wall. Its value is determined to be

$$T_{\text{max}} = T(L) = -2500L^2 + 1000L + 90 = -2500(0.04)^2 + 1000(0.04) + 90 = 126^\circ\text{C}$$

The direction of $q_s(L)$ (in the negative x direction) indicates that at $x = L$ the temperature increases in the positive x direction. If a is negative, the T plot is like in Fig. 1, which shows T_{max} at $x=L$. If a is positive, the T plot could only be like in Fig. 2, which is incompatible with the direction of heat transfer at the surface in contact with the water. So, temperature distribution can only be like in Fig. 1, where T_{max} is at $x=L$, and this was determined without using numerical values for a , b , or c .

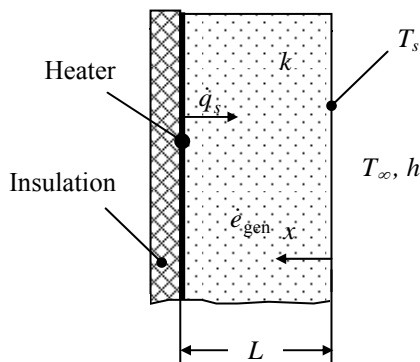

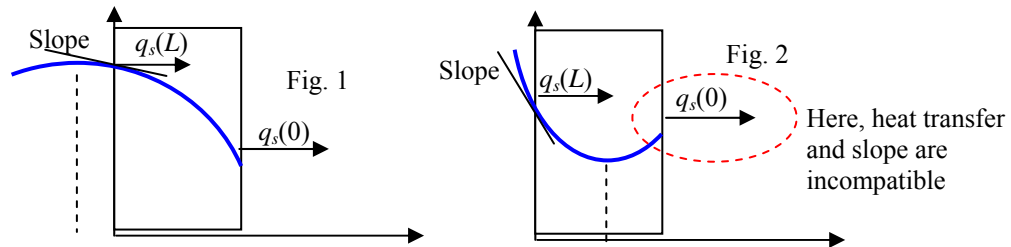

This part could also be answered to without any information about the nature of the $T(x)$ function, using qualitative arguments only. At steady state, heat cannot go from right to left at any location. There is no way out through the left surface because of the adiabatic insulation, so it would accumulate somewhere, contradicting the steady state assumption. Therefore, the temperature must continually decrease from left to right, and T_{\max} is at $x = L$.

2-141 Heat is generated in a plane wall. The temperature distribution in the wall is given. The surface temperature, the heat generation rate, the surface heat fluxes, and the relationship between these heat fluxes, the heat generation rate, and the geometry of the wall are to be determined.

Assumptions 1 Heat transfer is steady since there is no indication of any change with time. 2 Heat transfer is one-dimensional since the wall is large relative to its thickness. 3 Thermal conductivity is constant. 4 Heat generation is uniform.

Analysis (a) The variation of temperature is symmetric about $x = 0$. The surface temperature is

$$T_s = T(L) = T(-L) = a - bL^2 = 80^\circ\text{C} - (2 \times 10^4 \text{C/m}^2)(0.02 \text{ m})^2 = \mathbf{72^\circ\text{C}}$$

The plot of temperatures across the wall thickness is given below.

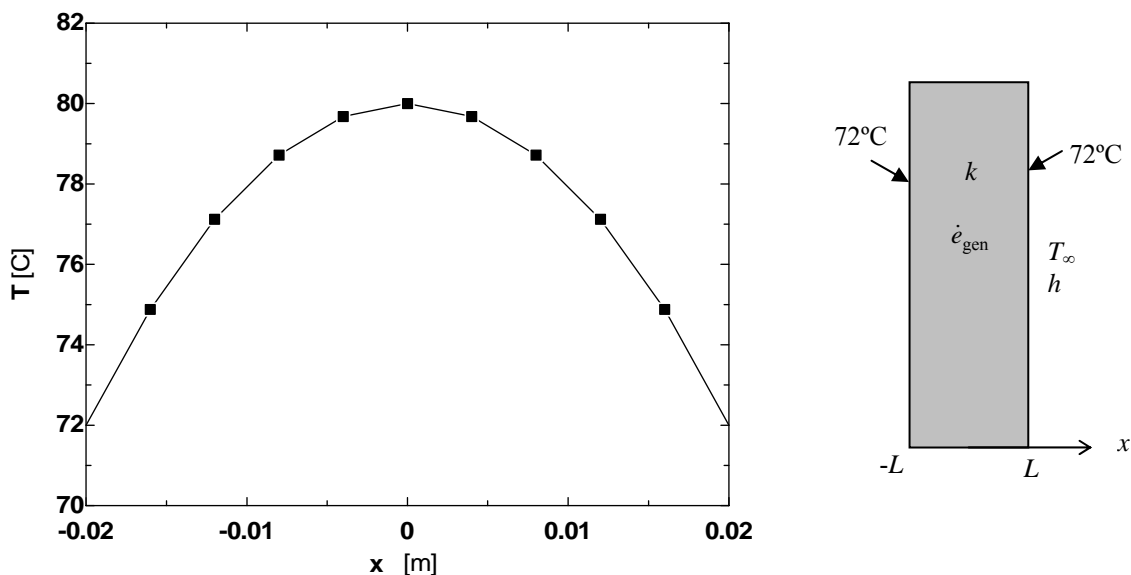

(b) The volumetric rate of heat generation is

$$k \frac{d^2 T}{dx^2} + \dot{e}_{\text{gen}} = 0 \longrightarrow \dot{e}_{\text{gen}} = -k(-2b) = 2(5 \text{ W/m} \cdot ^\circ\text{C})(2 \times 10^4 \text{C/m}^2) = \mathbf{2 \times 10^5 \text{ W/m}^3}$$

(c) The heat fluxes at the two surfaces are

$$\begin{aligned} \dot{q}_s(L) &= -k \left. \frac{dT}{dx} \right|_L = -k(-2bL) = 2(5 \text{ W/m} \cdot ^\circ\text{C})(2 \times 10^4 \text{C/m}^2)(0.02 \text{ m}) = \mathbf{4000 \text{ W/m}^2} \\ \dot{q}_s(-L) &= -k \left. \frac{dT}{dx} \right|_{-L} = -k[(-2b)(-L)] = -2(5 \text{ W/m} \cdot ^\circ\text{C})(2 \times 10^4 \text{C/m}^2)(0.02 \text{ m}) = \mathbf{-4000 \text{ W/m}^2} \end{aligned}$$

(d) The relationship between these fluxes, the heat generation rate and the geometry of the wall is

$$\begin{aligned} \dot{E}_{\text{out}} &= \dot{E}_{\text{gen}} \\ [\dot{q}_s(L) + \dot{q}_s(-L)]A &= \dot{e}_{\text{gen}} \mathcal{V} \\ [\dot{q}_s(L) + \dot{q}_s(-L)]WH &= \dot{e}_{\text{gen}} (2LWH) \\ \dot{q}_s(L) + \dot{q}_s(-L) &= 2\dot{e}_{\text{gen}}L \end{aligned}$$

Discussion Note that in this relation the absolute values of heat fluxes should be used. Substituting numerical values gives 8000 W/m^2 on both sides of the equation, and thus verifying the relationship.

2-142 Steady one-dimensional heat conduction takes place in a long slab. It is to be shown that the heat flux in steady operation is given by $\dot{q} = \frac{k^*}{W} \ln\left(\frac{T^* + T_0}{T^* + T_w}\right)$. Also, the heat flux is to be calculated for a given set of parameters.

Assumptions 1 Heat transfer is steady. **2** Heat transfer is one-dimensional since the wall is large relative to its thickness.

Analysis The derivation is given as follows

$$\dot{q} = -k \frac{dT}{dx} = \frac{-k^*}{(T^* + T)} \frac{dT}{dx}$$

or

$$\int_{T_0}^{T_w} \frac{dT}{T^* + T} = -\frac{\dot{q}}{k^*} \int_0^W dx$$

$$\ln(T^* + T) \Big|_{T_0}^{T_w} = -\frac{\dot{q}}{k^*} (W - 0)$$

$$\ln\left(\frac{T^* + T_w}{T^* + T_0}\right) = -\dot{q} \frac{W}{k^*}$$

$$\dot{q} = \frac{k^*}{W} \ln\left(\frac{T^* + T_0}{T^* + T_w}\right)$$

The heat flux for the given values is

$$\dot{q} = \frac{k^*}{W} \ln\left(\frac{T^* + T_0}{T^* + T_w}\right) = \frac{7 \times 10^4 \text{ W/m}}{0.2 \text{ m}} \ln\left(\frac{(1000 - 600)\text{K}}{(1000 - 400)\text{K}}\right) = -1.42 \times 10^5 \text{ W/m}^2$$

2-143 A spherical ball in which heat is generated uniformly is exposed to iced-water. The temperatures at the center and at the surface of the ball are to be determined.

Assumptions 1 Heat transfer is steady since there is no indication of any change with time. **2** Heat transfer is one-dimensional, and there is thermal symmetry about the center point. **3** Thermal conductivity is constant. **4** Heat generation is uniform.

Properties The thermal conductivity is given to be $k = 45 \text{ W/m}\cdot^\circ\text{C}$.

Analysis The temperatures at the center and at the surface of the ball are determined directly from

$$T_s = T_\infty + \frac{\dot{e}_{\text{gen}} r_o}{3h} = 0^\circ\text{C} + \frac{(2.6 \times 10^6 \text{ W/m}^3)(0.12 \text{ m})}{3(1200 \text{ W/m}^2 \cdot ^\circ\text{C})} = 86.7^\circ\text{C}$$

$$T_0 = T_s + \frac{\dot{e}_{\text{gen}} r_o^2}{6k} = 86.7^\circ\text{C} + \frac{(2.6 \times 10^6 \text{ W/m}^3)(0.12 \text{ m})^2}{6(45 \text{ W/m}\cdot^\circ\text{C})} = 225^\circ\text{C}$$

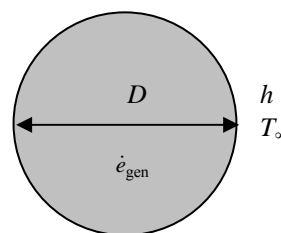

Fundamentals of Engineering (FE) Exam Problems

2-144 The heat conduction equation in a medium is given in its simplest form as $\frac{1}{r} \frac{d}{dr} \left(rk \frac{dT}{dr} \right) + \dot{e}_{\text{gen}} = 0$

Select the wrong statement below.

- (a) the medium is of cylindrical shape.
- (b) the thermal conductivity of the medium is constant.
- (c) heat transfer through the medium is steady.
- (d) there is heat generation within the medium.
- (e) heat conduction through the medium is one-dimensional.

Answer (b) thermal conductivity of the medium is constant

2-145 Consider a medium in which the heat conduction equation is given in its simplest form as

$$\frac{1}{r^2} \frac{\partial}{\partial r} \left(r^2 \frac{\partial T}{\partial r} \right) = \frac{1}{\alpha} \frac{\partial T}{\partial t}$$

- (a) Is heat transfer steady or transient?
- (b) Is heat transfer one-, two-, or three-dimensional?
- (c) Is there heat generation in the medium?
- (d) Is the thermal conductivity of the medium constant or variable?
- (e) Is the medium a plane wall, a cylinder, or a sphere?
- (f) Is this differential equation for heat conduction linear or nonlinear?

Answers: (a) transient, (b) one-dimensional, (c) no, (d) constant, (e) sphere, (f) linear

2-146 An apple of radius R is losing heat steadily and uniformly from its outer surface to the ambient air at temperature T_{∞} with a convection coefficient of h , and to the surrounding surfaces at temperature T_{surr} (all temperatures are absolute temperatures). Also, heat is generated within the apple uniformly at a rate of \dot{e}_{gen} per unit volume. If T_s denotes the outer surface temperature, the boundary condition at the outer surface of the apple can be expressed as

- (a) $-k \left. \frac{dT}{dr} \right|_{r=R} = h(T_s - T_{\infty}) + \varepsilon\sigma(T_s^4 - T_{\text{surr}}^4)$
- (b) $-k \left. \frac{dT}{dr} \right|_{r=R} = h(T_s - T_{\infty}) + \varepsilon\sigma(T_s^4 - T_{\text{surr}}^4) + \dot{e}_{\text{gen}}$
- (c) $k \left. \frac{dT}{dr} \right|_{r=R} = h(T_s - T_{\infty}) + \varepsilon\sigma(T_s^4 - T_{\text{surr}}^4)$
- (d) $k \left. \frac{dT}{dr} \right|_{r=R} = h(T_s - T_{\infty}) + \varepsilon\sigma(T_s^4 - T_{\text{surr}}^4) + \frac{4\pi R^3 / 3}{4\pi R^2} \dot{e}_{\text{gen}}$
- (e) None of them

Answer: $-k \left. \frac{dT}{dr} \right|_{r=R} = h(T_s - T_{\infty}) + \varepsilon\sigma(T_s^4 - T_{\text{surr}}^4)$

Note: Heat generation in the medium has no effect on boundary conditions.

2-147 A furnace of spherical shape is losing heat steadily and uniformly from its outer surface of radius R to the ambient air at temperature T_∞ with a convection coefficient of h , and to the surrounding surfaces at temperature T_{surr} (all temperatures are absolute temperatures). If T_o denotes the outer surface temperature, the boundary condition at the outer surface of the furnace can be expressed as

$$(a) -k \left. \frac{dT}{dr} \right|_{r=R} = h(T_o - T_\infty) + \varepsilon\sigma(T_o^4 - T_{\text{surr}}^4) \quad (b) -k \left. \frac{dT}{dr} \right|_{r=R} = h(T_o - T_\infty) - \varepsilon\sigma(T_o^4 - T_{\text{surr}}^4)$$

$$(c) k \left. \frac{dT}{dr} \right|_{r=R} = h(T_o - T_\infty) + \varepsilon\sigma(T_o^4 - T_{\text{surr}}^4) \quad (d) k \left. \frac{dT}{dr} \right|_{r=R} = h(T_o - T_\infty) - \varepsilon\sigma(T_o^4 - T_{\text{surr}}^4)$$

$$(e) k(4\pi R^2) \left. \frac{dT}{dr} \right|_{r=R} = h(T_o - T_\infty) + \varepsilon\sigma(T_o^4 - T_{\text{surr}}^4)$$

$$\text{Answer (a)} \quad -k \left. \frac{dT}{dr} \right|_{r=R} = h(T_o - T_\infty) + \varepsilon\sigma(T_o^4 - T_{\text{surr}}^4)$$

2-148 A plane wall of thickness L is subjected to convection at both surfaces with ambient temperature $T_{\infty 1}$ and heat transfer coefficient h_1 at inner surface, and corresponding $T_{\infty 2}$ and h_2 values at the outer surface. Taking the positive direction of x to be from the inner surface to the outer surface, the correct expression for the convection boundary condition is

$$(a) k \frac{dT(0)}{dx} = h_1 [T(0) - T_{\infty 1}] \quad (b) k \frac{dT(L)}{dx} = h_2 [T(L) - T_{\infty 2}]$$

$$(c) -k \frac{dT(0)}{dx} = h_1 [T_{\infty 1} - T(0)] \quad (d) -k \frac{dT(L)}{dx} = h_2 [T_{\infty 2} - T(L)]$$

(e) None of them

$$\text{Answer (a)} \quad k \frac{dT(0)}{dx} = h_1 [T(0) - T_{\infty 1}]$$

2-149 Consider steady one-dimensional heat conduction through a plane wall, a cylindrical shell, and a spherical shell of uniform thickness with constant thermophysical properties and no thermal energy generation. The geometry in which the variation of temperature in the direction of heat transfer be linear is

(a) plane wall (b) cylindrical shell (c) spherical shell (d) all of them (e) none of them

Answer (a) plane wall

2-150 Consider a large plane wall of thickness L , thermal conductivity k , and surface area A . The left surface of the wall is exposed to the ambient air at T_∞ with a heat transfer coefficient of h while the right surface is insulated. The variation of temperature in the wall for steady one-dimensional heat conduction with no heat generation is

$$(a) T(x) = \frac{h(L-x)}{k} T_\infty$$

$$(b) T(x) = \frac{k}{h(x+0.5L)} T_\infty$$

$$(c) T(x) = \left(1 - \frac{xh}{k}\right) T_\infty$$

$$(d) T(x) = (L-x)T_\infty$$

$$(e) T(x) = T_\infty$$

Answer (e) $T(x) = T_\infty$

2-151 The variation of temperature in a plane wall is determined to be $T(x)=65x+25$ where x is in m and T is in $^\circ\text{C}$. If the temperature at one surface is 38°C , the thickness of the wall is

$$(a) 2 \text{ m}$$

$$(b) 0.4 \text{ m}$$

$$(c) 0.2 \text{ m}$$

$$(d) 0.1 \text{ m}$$

$$(e) 0.05 \text{ m}$$

Answer (c) 0.2 m

Solution Solved by EES Software. Solutions can be verified by copying-and-pasting the following lines on a blank EES screen.

$$38=65*L+25$$

2-152 The variation of temperature in a plane wall is determined to be $T(x)=110-48x$ where x is in m and T is in $^\circ\text{C}$. If the thickness of the wall is 0.75 m, the temperature difference between the inner and outer surfaces of the wall is

$$(a) 110^\circ\text{C}$$

$$(b) 74^\circ\text{C}$$

$$(c) 55^\circ\text{C}$$

$$(d) 36^\circ\text{C}$$

$$(e) 18^\circ\text{C}$$

Answer (d) 36°C

Solution Solved by EES Software. Solutions can be verified by copying-and-pasting the following lines on a blank EES screen.

$$T1=110 \text{ [C]}$$

$$L=0.75$$

$$T2=110-48*L$$

$$\text{DELTA}T=T1-T2$$

2-153 The temperatures at the inner and outer surfaces of a 15-cm-thick plane wall are measured to be 40°C and 28°C, respectively. The expression for steady, one-dimensional variation of temperature in the wall is

- (a) $T(x) = 28x + 40$ (b) $T(x) = -40x + 28$
(c) $T(x) = 40x + 28$ (d) $T(x) = -80x + 40$
(e) $T(x) = 40x - 80$

Answer (d) $T(x) = -80x + 40$

Solution Solved by EES Software. Solutions can be verified by copying-and-pasting the following lines on a blank EES screen.

T1=40 [C]
T2=28 [C]
L=0.15 [m]

"T(x)=C1x+C2"
C2=T1
T2=C1*L+T1

2-154 Heat is generated in a long 0.3-cm-diameter cylindrical electric heater at a rate of 150 W/cm^3 . The heat flux at the surface of the heater in steady operation is

- (a) 42.7 W/cm^2 (b) 159 W/cm^2 (c) 150 W/cm^2 (d) 10.6 W/cm^2 (e) 11.3 W/cm^2

Answer (e) 11.3 W/cm^2

Solution Solved by EES Software. Solutions can be verified by copying-and-pasting the following lines on a blank EES screen.

"Consider a 1-cm long heater:"

L=1 [cm]
e=150 [W/cm^3]
D=0.3 [cm]
V=pi*(D^2/4)*L
A=pi*D*L "[cm^2]"
Egen=e*v "[W]"
Qflux=Egen/A "[W/cm^2]"

"Some Wrong Solutions with Common Mistakes:"

W1=Egen "Ignoring area effect and using the total"
W2=e/A "Threating g as total generation rate"
W3=e "ignoring volume and area effects"

2-155 Heat is generated in a 8-cm-diameter spherical radioactive material whose thermal conductivity is 25 W/m·°C uniformly at a rate of 15 W/cm³. If the surface temperature of the material is measured to be 120°C, the center temperature of the material during steady operation is

- (a) 160°C (b) 280°C (c) 212°C (d) 360°C (e) 600°C

Answer (b) 280°C

D=0.08
Ts=120
k=25
e_gen=15E+6
T=Ts+g*(D/2)^2/(6*k)

"Some Wrong Solutions with Common Mistakes:"

W1_T= e_gen*(D/2)^2/(6*k) "Not using Ts"

W2_T= Ts+e_gen*(D/2)^2/(4*k) "Using the relation for cylinder"

W3_T= Ts+e_gen*(D/2)^2/(2*k) "Using the relation for slab"

2-156 Heat is generated in a 3-cm-diameter spherical radioactive material uniformly at a rate of 15 W/cm³. Heat is dissipated to the surrounding medium at 25°C with a heat transfer coefficient of 120 W/m²·°C. The surface temperature of the material in steady operation is

- (a) 56°C (b) 84°C (c) 494°C (d) 650°C (e) 108°C

Answer (d) 650°C

Solution Solved by EES Software. Solutions can be verified by copying-and-pasting the following lines on a blank EES screen.

h=120 [W/m^2-C]
e=15 [W/cm^3]
Tinf=25 [C]
D=3 [cm]
V=pi*D^3/6 "[cm^3]"
A=pi*D^2/10000 "[m^2]"
Egen=e*V "[W]"
Qgen=h*A*(Ts-Tinf)

2-157 Heat is generated uniformly in a 4-cm-diameter, 16-cm-long solid bar ($k = 2.4 \text{ W/m}\cdot\text{C}$). The temperatures at the center and at the surface of the bar are measured to be 210°C and 45°C , respectively. The rate of heat generation within the bar is

- (a) 240 W (b) 796 W (c) 1013 W (d) $79,620 \text{ W}$ (e) $3.96 \times 10^6 \text{ W}$

Answer (b) 796 W

Solution Solved by EES Software. Solutions can be verified by copying-and-pasting the following lines on a blank EES screen.

```
D=0.04 [m]
L=0.16 [m]
k=2.4 [W/m-C]
T0=210 [C]
T_s=45 [C]
T0-T_s=(e*(D/2)^2)/(4*k)
V=pi*D^2/4*L
E_dot_gen=e*V
```

"Some Wrong Solutions with Common Mistakes"

W1_V=pi*D*L "Using surface area equation for volume"

W1_E_dot_gen=e*W1_V

T0=(W2_e*(D/2)^2)/(4*k) "Using center temperature instead of temperature difference"

W2_Q_dot_gen=W2_e*V

W3_Q_dot_gen=e "Using heat generation per unit volume instead of total heat generation as the result"

2-158 A solar heat flux \dot{q}_s is incident on a sidewalk whose thermal conductivity is k , solar absorptivity is α_s and convective heat transfer coefficient is h . Taking the positive x direction to be towards the sky and disregarding radiation exchange with the surroundings surfaces, the correct boundary condition for this sidewalk surface is

(a) $-k \frac{dT}{dx} = \alpha_s \dot{q}_s$ (b) $-k \frac{dT}{dx} = h(T - T_\infty)$ (c) $-k \frac{dT}{dx} = h(T - T_\infty) - \alpha_s \dot{q}_s$

(d) $h(T - T_\infty) = \alpha_s \dot{q}_s$ (e) None of them

Answer (c) $-k \frac{dT}{dx} = h(T - T_\infty) - \alpha_s \dot{q}_s$

2-159 Hot water flows through a PVC ($k = 0.092$ W/m·K) pipe whose inner diameter is 2 cm and outer diameter is 2.5 cm. The temperature of the interior surface of this pipe is 35°C and the temperature of the exterior surface is 20°C. The rate of heat transfer per unit of pipe length is

- (a) 22.8 W/m (b) 38.9 W/m (c) 48.7 W/m (d) 63.6 W/m (e) 72.6 W/m

Answer (b) 38.9 W/m

Solution Solved by EES Software. Solutions can be verified by copying-and-pasting the following lines on a blank EES screen.

```
do=2.5 [cm]
di=2.0 [cm]
k=0.092 [W/m-C]
T2=35 [C]
T1=20 [C]
Q=2*pi*k*(T2-T1)/LN(do/di)
```

2-160 The thermal conductivity of a solid depends upon the solid's temperature as $k = aT + b$ where a and b are constants. The temperature in a planar layer of this solid as it conducts heat is given by

- (a) $aT + b = x + C_2$ (b) $aT + b = C_1x^2 + C_2$ (c) $aT^2 + bT = C_1x + C_2$
 (d) $aT^2 + bT = C_1x^2 + C_2$ (e) None of them

Answer (c) $aT^2 + bT = C_1x + C_2$

2-161 Harvested grains, like wheat, undergo a volumetric exothermic reaction while they are being stored. This heat generation causes these grains to spoil or even start fires if not controlled properly. Wheat ($k = 0.5$ W/m·K) is stored on the ground (effectively an adiabatic surface) in 5-m thick layers. Air at 20°C contacts the upper surface of this layer of wheat with $h = 3$ W/m²·K. The temperature distribution inside this layer is given by

$$\frac{T - T_s}{T_0 - T_s} = 1 - \left(\frac{x}{L}\right)^2$$

where T_s is the upper surface temperature, T_0 is the lower surface temperature, x is measured upwards from the ground, and L is the thickness of the layer. When the temperature of the upper surface is 24°C, what is the temperature of the wheat next to the ground?

- (a) 39°C (b) 51°C (c) 72°C (d) 84°C (e) 91°C

Answer (d) 84°C

```
k=0.5 [W/m-K]
h=3 [W/m^2-K]
L=5[m]
Ts=24 [C]
Ta=20 [C]
To=(h*L/(2*k))*(Ts-Ta)+Ts
```

2-162 The conduction equation boundary condition for an adiabatic surface with direction n being normal to the surface is

(a) $T = 0$ (b) $dT/dn = 0$ (c) $d^2T/dn^2 = 0$ (d) $d^3T/dn^3 = 0$ (e) $-kdT/dn = 1$

Answer (b) $dT/dn = 0$

2-163 Which one of the followings is the correct expression for one-dimensional, steady-state, constant thermal conductivity heat conduction equation for a cylinder with heat generation?

(a) $\frac{1}{r} \frac{\partial}{\partial r} \left(rk \frac{\partial T}{\partial r} \right) + \dot{e}_{\text{gen}} = \rho c \frac{\partial T}{\partial t}$ (b) $\frac{1}{r} \frac{\partial}{\partial r} \left(r \frac{\partial T}{\partial r} \right) + \frac{\dot{e}_{\text{gen}}}{k} = \frac{1}{\alpha} \frac{\partial T}{\partial t}$
 (c) $\frac{1}{r} \frac{\partial}{\partial r} \left(r \frac{\partial T}{\partial r} \right) = \frac{1}{\alpha} \frac{\partial T}{\partial t}$ (d) $\frac{1}{r} \frac{d}{dr} \left(r \frac{dT}{dr} \right) + \frac{\dot{e}_{\text{gen}}}{k} = 0$ (e) $\frac{d}{dr} \left(r \frac{dT}{dr} \right) = 0$

Answer (d) $\frac{1}{r} \frac{d}{dr} \left(r \frac{dT}{dr} \right) + \frac{\dot{e}_{\text{gen}}}{k} = 0$

2-164 2-167 Design and Essay Problems



Chapter 3

STEADY HEAT CONDUCTION

Steady Heat Conduction in Plane Walls

3-1C (a) If the lateral surfaces of the rod are insulated, the heat transfer surface area of the cylindrical rod is the bottom or the top surface area of the rod, $A_s = \pi D^2 / 4$. (b) If the top and the bottom surfaces of the rod are insulated, the heat transfer area of the rod is the lateral surface area of the rod, $A = \pi DL$.

3-2C In steady heat conduction, the rate of heat transfer into the wall is equal to the rate of heat transfer out of it. Also, the temperature at any point in the wall remains constant. Therefore, the energy content of the wall does not change during steady heat conduction. However, the temperature along the wall and thus the energy content of the wall will change during transient conduction.

3-3C The temperature distribution in a plane wall will be a straight line during steady and one dimensional heat transfer with constant wall thermal conductivity.

3-4C The thermal resistance of a medium represents the resistance of that medium against heat transfer.

3-5C The combined heat transfer coefficient represents the combined effects of radiation and convection heat transfers on a surface, and is defined as $h_{\text{combined}} = h_{\text{convection}} + h_{\text{radiation}}$. It offers the convenience of incorporating the effects of radiation in the convection heat transfer coefficient, and to ignore radiation in heat transfer calculations.

3-6C Yes. The convection resistance can be defined as the inverse of the convection heat transfer coefficient per unit surface area since it is defined as $R_{\text{conv}} = 1/(hA)$.

3-7C The convection and the radiation resistances at a surface are parallel since both the convection and radiation heat transfers occur simultaneously.

3-8C For a surface of A at which the convection and radiation heat transfer coefficients are h_{conv} and h_{rad} , the single equivalent heat transfer coefficient is $h_{\text{eqv}} = h_{\text{conv}} + h_{\text{rad}}$ when the medium and the surrounding surfaces are at the same temperature. Then the equivalent thermal resistance will be $R_{\text{eqv}} = 1/(h_{\text{eqv}}A)$.

3-9C The thermal resistance network associated with a five-layer composite wall involves five single-layer resistances connected in series.

3-10C Once the rate of heat transfer \dot{Q} is known, the temperature drop across any layer can be determined by multiplying heat transfer rate by the thermal resistance across that layer, $\Delta T_{\text{layer}} = \dot{Q}R_{\text{layer}}$

3-11C The temperature of each surface in this case can be determined from

$$\dot{Q} = (T_{\infty 1} - T_{s1}) / R_{\infty 1-s1} \longrightarrow T_{s1} = T_{\infty 1} - (\dot{Q}R_{\infty 1-s1})$$

$$\dot{Q} = (T_{s2} - T_{\infty 2}) / R_{s2-\infty 2} \longrightarrow T_{s2} = T_{\infty 2} + (\dot{Q}R_{s2-\infty 2})$$

where $R_{\infty-i}$ is the thermal resistance between the environment ∞ and surface i .

3-12C Yes, it is.

3-13C The window glass which consists of two 4 mm thick glass sheets pressed tightly against each other will probably have thermal contact resistance which serves as an additional thermal resistance to heat transfer through window, and thus the heat transfer rate will be smaller relative to the one which consists of a single 8 mm thick glass sheet.

3-14C Convection heat transfer through the wall is expressed as $\dot{Q} = hA_s(T_s - T_{\infty})$. In steady heat transfer, heat transfer rate to the wall and from the wall are equal. Therefore at the outer surface which has convection heat transfer coefficient three times that of the inner surface will experience three times smaller temperature drop compared to the inner surface. Therefore, at the outer surface, the temperature will be closer to the surrounding air temperature.

3-15C The new design introduces the thermal resistance of the copper layer in addition to the thermal resistance of the aluminum which has the same value for both designs. Therefore, the new design will be a poorer conductor of heat.

3-16C The blanket will introduce additional resistance to heat transfer and slow down the heat gain of the drink wrapped in a blanket. Therefore, the drink left on a table will warm up faster.

3-17 The two surfaces of a wall are maintained at specified temperatures. The rate of heat loss through the wall is to be determined.

Assumptions 1 Heat transfer through the wall is steady since the surface temperatures remain constant at the specified values. **2** Heat transfer is one-dimensional since any significant temperature gradients will exist in the direction from the indoors to the outdoors. **3** Thermal conductivity is constant.

Properties The thermal conductivity is given to be $k = 0.8 \text{ W/m}\cdot\text{C}$.

Analysis The surface area of the wall and the rate of heat loss through the wall are

$$A = (3 \text{ m}) \times (6 \text{ m}) = 18 \text{ m}^2$$

$$\dot{Q} = kA \frac{T_1 - T_2}{L} = (0.8 \text{ W/m}\cdot\text{C})(18 \text{ m}^2) \frac{(14 - 2)\text{C}}{0.3 \text{ m}} = \mathbf{576 \text{ W}}$$

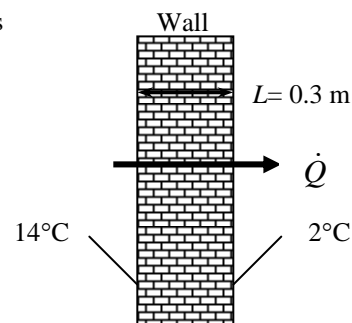

3-18 A double-pane window is considered. The rate of heat loss through the window and the temperature difference across the largest thermal resistance are to be determined.

Assumptions 1 Steady operating conditions exist. **2** Heat transfer coefficients are constant.

Properties The thermal conductivities of glass and air are given to be $0.78 \text{ W/m}\cdot\text{K}$ and $0.025 \text{ W/m}\cdot\text{K}$, respectively.

Analysis (a) The rate of heat transfer through the window is determined to be

$$\begin{aligned}\dot{Q} &= \frac{A\Delta T}{\frac{1}{h_i} + \frac{L_g}{k_g} + \frac{L_a}{k_a} + \frac{L_g}{k_g} + \frac{1}{h_o}} \\ &= \frac{(1 \times 1.5 \text{ m}^2)[20 - (-20)]^\circ\text{C}}{\frac{1}{40 \text{ W/m}^2 \cdot ^\circ\text{C}} + \frac{0.004 \text{ m}}{0.78 \text{ W/m} \cdot ^\circ\text{C}} + \frac{0.005 \text{ m}}{0.025 \text{ W/m} \cdot ^\circ\text{C}} + \frac{0.004 \text{ m}}{0.78 \text{ W/m} \cdot ^\circ\text{C}} + \frac{1}{20 \text{ W/m}^2 \cdot ^\circ\text{C}}} \\ &= \frac{(1 \times 1.5 \text{ m}^2)[20 - (-20)]^\circ\text{C}}{0.025 + 0.000513 + 0.2 + 0.000513 + 0.05} = \mathbf{210 \text{ W}}\end{aligned}$$

(b) Noting that the largest resistance is through the air gap, the temperature difference across the air gap is determined from

$$\Delta T_a = \dot{Q}R_a = \dot{Q} \frac{L_a}{k_a A} = (210 \text{ W}) \frac{0.005 \text{ m}}{(0.025 \text{ W/m} \cdot ^\circ\text{C})(1 \times 1.5 \text{ m}^2)} = \mathbf{28^\circ\text{C}}$$

3-19 The two surfaces of a window are maintained at specified temperatures. The rate of heat loss through the window and the inner surface temperature are to be determined.

Assumptions 1 Heat transfer through the window is steady since the surface temperatures remain constant at the specified values. **2** Heat transfer is one-dimensional since any significant temperature gradients will exist in the direction from the indoors to the outdoors. **3** Thermal conductivity is constant. **4** Heat transfer by radiation is negligible.

Properties The thermal conductivity of the glass is given to be $k = 0.78 \text{ W/m}\cdot^\circ\text{C}$.

Analysis The area of the window and the individual resistances are

$$A = (1.2 \text{ m}) \times (2 \text{ m}) = 2.4 \text{ m}^2$$

$$R_i = R_{conv,1} = \frac{1}{h_1 A} = \frac{1}{(10 \text{ W/m}^2 \cdot ^\circ\text{C})(2.4 \text{ m}^2)} = 0.04167 \text{ }^\circ\text{C/W}$$

$$R_{glass} = \frac{L}{k_1 A} = \frac{0.006 \text{ m}}{(0.78 \text{ W/m}\cdot^\circ\text{C})(2.4 \text{ m}^2)} = 0.00321 \text{ }^\circ\text{C/W}$$

$$R_o = R_{conv,2} = \frac{1}{h_2 A} = \frac{1}{(25 \text{ W/m}^2 \cdot ^\circ\text{C})(2.4 \text{ m}^2)} = 0.01667 \text{ }^\circ\text{C/W}$$

$$\begin{aligned}R_{total} &= R_{conv,1} + R_{glass} + R_{conv,2} \\ &= 0.04167 + 0.00321 + 0.01667 = 0.06155 \text{ }^\circ\text{C/W}\end{aligned}$$

The steady rate of heat transfer through window glass is then

$$\dot{Q} = \frac{T_{\infty 1} - T_{\infty 2}}{R_{total}} = \frac{[24 - (-5)]^\circ\text{C}}{0.06155 \text{ }^\circ\text{C/W}} = \mathbf{471 \text{ W}}$$

The inner surface temperature of the window glass can be determined from

$$\dot{Q} = \frac{T_{\infty 1} - T_1}{R_{conv,1}} \longrightarrow T_1 = T_{\infty 1} - \dot{Q}R_{conv,1} = 24^\circ\text{C} - (471 \text{ W})(0.04167 \text{ }^\circ\text{C/W}) = \mathbf{4.4^\circ\text{C}}$$

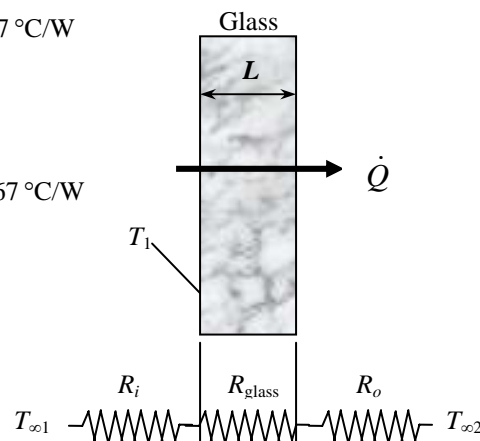

3-20 A double-pane window consists of two layers of glass separated by a stagnant air space. For specified indoors and outdoors temperatures, the rate of heat loss through the window and the inner surface temperature of the window are to be determined.

Assumptions 1 Heat transfer through the window is steady since the indoor and outdoor temperatures remain constant at the specified values. **2** Heat transfer is one-dimensional since any significant temperature gradients will exist in the direction from the indoors to the outdoors. **3** Thermal conductivities of the glass and air are constant. **4** Heat transfer by radiation is negligible.

Properties The thermal conductivity of the glass and air are given to be $k_{\text{glass}} = 0.78 \text{ W/m}\cdot\text{C}$ and $k_{\text{air}} = 0.026 \text{ W/m}\cdot\text{C}$.

Analysis The area of the window and the individual resistances are

$$A = (1.2 \text{ m}) \times (2 \text{ m}) = 2.4 \text{ m}^2$$

$$R_i = R_{\text{conv},1} = \frac{1}{h_1 A} = \frac{1}{(10 \text{ W/m}^2\cdot\text{C})(2.4 \text{ m}^2)} = 0.0417 \text{ }^\circ\text{C/W}$$

$$R_1 = R_3 = R_{\text{glass}} = \frac{L_1}{k_1 A} = \frac{0.003 \text{ m}}{(0.78 \text{ W/m}\cdot\text{C})(2.4 \text{ m}^2)} = 0.0016 \text{ }^\circ\text{C/W}$$

$$R_2 = R_{\text{air}} = \frac{L_2}{k_2 A} = \frac{0.012 \text{ m}}{(0.026 \text{ W/m}\cdot\text{C})(2.4 \text{ m}^2)} = 0.1923 \text{ }^\circ\text{C/W}$$

$$R_o = R_{\text{conv},2} = \frac{1}{h_2 A} = \frac{1}{(25 \text{ W/m}^2\cdot\text{C})(2.4 \text{ m}^2)} = 0.0167 \text{ }^\circ\text{C/W}$$

$$R_{\text{total}} = R_{\text{conv},1} + 2R_1 + R_2 + R_{\text{conv},2} = 0.0417 + 2(0.0016) + 0.1923 + 0.0167 \\ = 0.2539 \text{ }^\circ\text{C/W}$$

The steady rate of heat transfer through window glass then becomes

$$\dot{Q} = \frac{T_{\infty 1} - T_{\infty 2}}{R_{\text{total}}} = \frac{[24 - (-5)]^\circ\text{C}}{0.2539^\circ\text{C/W}} = \mathbf{114 \text{ W}}$$

The inner surface temperature of the window glass can be determined from

$$\dot{Q} = \frac{T_{\infty 1} - T_1}{R_{\text{conv},1}} \longrightarrow T_1 = T_{\infty 1} - \dot{Q}R_{\text{conv},1} = 24^\circ\text{C} - (114 \text{ W})(0.0417^\circ\text{C/W}) = \mathbf{19.2^\circ\text{C}}$$

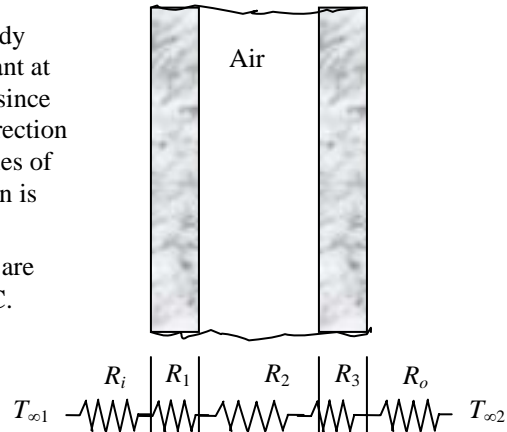

3-21 A double-pane window consists of two layers of glass separated by an evacuated space. For specified indoors and outdoors temperatures, the rate of heat loss through the window and the inner surface temperature of the window are to be determined.

Assumptions 1 Heat transfer through the window is steady since the indoor and outdoor temperatures remain constant at the specified values. **2** Heat transfer is one-dimensional since any significant temperature gradients will exist in the direction from the indoors to the outdoors. **3** Thermal conductivity of the glass is constant. **4** Heat transfer by radiation is negligible.

Properties The thermal conductivity of the glass is given to be $k_{\text{glass}} = 0.78 \text{ W/m}\cdot\text{C}$.

Analysis Heat cannot be conducted through an evacuated space since the thermal conductivity of vacuum is zero (no medium to conduct heat) and thus its thermal resistance is zero. Therefore, if radiation is disregarded, the heat transfer through the window will be zero. Then the answer of this problem is **zero** since the problem states to disregard radiation.

Discussion In reality, heat will be transferred between the glasses by radiation. We do not know the inner surface temperatures of windows. In order to determine radiation heat resistance we assume them to be 5°C and 15°C , respectively, and take the emissivity to be 1. Then individual resistances are

$$A = (1.2 \text{ m}) \times (2 \text{ m}) = 2.4 \text{ m}^2$$

$$R_i = R_{\text{conv},1} = \frac{1}{h_1 A} = \frac{1}{(10 \text{ W/m}^2 \cdot \text{C})(2.4 \text{ m}^2)} = 0.0417 \text{ C/W}$$

$$R_1 = R_3 = R_{\text{glass}} = \frac{L_1}{k_1 A} = \frac{0.003 \text{ m}}{(0.78 \text{ W/m}\cdot\text{C})(2.4 \text{ m}^2)} = 0.0016 \text{ C/W}$$

$$R_{\text{rad}} = \frac{1}{\varepsilon \sigma A (T_s^2 + T_{\text{surr}}^2)(T_s + T_{\text{surr}})}$$

$$= \frac{1}{1(5.67 \times 10^{-8} \text{ W/m}^2 \cdot \text{K}^4)(2.4 \text{ m}^2)[288^2 + 278^2][288 + 278] \text{ K}^3}$$

$$= 0.0810 \text{ C/W}$$

$$R_o = R_{\text{conv},2} = \frac{1}{h_2 A} = \frac{1}{(25 \text{ W/m}^2 \cdot \text{C})(2.4 \text{ m}^2)} = 0.0167 \text{ C/W}$$

$$R_{\text{total}} = R_{\text{conv},1} + 2R_1 + R_{\text{rad}} + R_{\text{conv},2} = 0.0417 + 2(0.0016) + 0.0810 + 0.0167$$

$$= 0.1426 \text{ C/W}$$

The steady rate of heat transfer through window glass then becomes

$$\dot{Q} = \frac{T_{\infty 1} - T_{\infty 2}}{R_{\text{total}}} = \frac{[24 - (-5)]^\circ\text{C}}{0.1426 \text{ C/W}} = \mathbf{203 \text{ W}}$$

The inner surface temperature of the window glass can be determined from

$$\dot{Q} = \frac{T_{\infty 1} - T_1}{R_{\text{conv},1}} \longrightarrow T_1 = T_{\infty 1} - \dot{Q} R_{\text{conv},1} = 24^\circ\text{C} - (203 \text{ W})(0.0417 \text{ C/W}) = \mathbf{15.5^\circ\text{C}}$$

Similarly, the inner surface temperatures of the glasses are calculated to be 15.2 and -1.2°C (we had assumed them to be 15 and 5°C when determining the radiation resistance). We can improve the result obtained by reevaluating the radiation resistance and repeating the calculations.

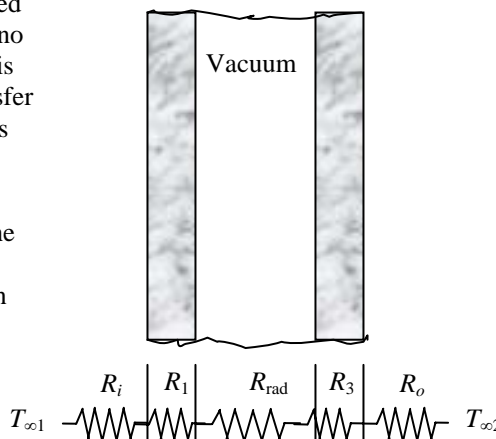

3-22 EES Prob. 3-20 is reconsidered. The rate of heat transfer through the window as a function of the width of air space is to be plotted.

Analysis The problem is solved using EES, and the solution is given below.

"GIVEN"

A=1.2*2 [m^2]
 L_glass=3 [mm]
 k_glass=0.78 [W/m-C]
 L_air=12 [mm]
 T_infinity_1=24 [C]
 T_infinity_2=-5 [C]
 h_1=10 [W/m^2-C]
 h_2=25 [W/m^2-C]

"PROPERTIES"

k_air=conductivity(Air,T=25)

"ANALYSIS"

R_conv_1=1/(h_1*A)
 R_glass=(L_glass*Convert(mm, m))/(k_glass*A)
 R_air=(L_air*Convert(mm, m))/(k_air*A)
 R_conv_2=1/(h_2*A)
 R_total=R_conv_1+2*R_glass+R_air+R_conv_2
 Q_dot=(T_infinity_1-T_infinity_2)/R_total

L _{air} [mm]	Q [W]
2	307.8
4	228.6
6	181.8
8	150.9
10	129
12	112.6
14	99.93
16	89.82
18	81.57
20	74.7

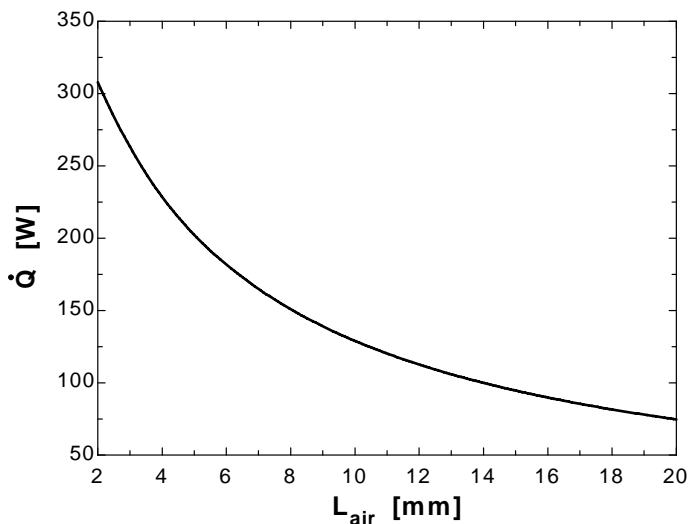

3-23E The inner and outer surfaces of the walls of an electrically heated house remain at specified temperatures during a winter day. The amount of heat lost from the house that day and its cost are to be determined.

Assumptions 1 Heat transfer through the walls is steady since the surface temperatures of the walls remain constant at the specified values during the time period considered. **2** Heat transfer is one-dimensional since any significant temperature gradients will exist in the direction from the indoors to the outdoors. **3** Thermal conductivity of the walls is constant.

Properties The thermal conductivity of the brick wall is given to be $k = 0.40 \text{ Btu/h}\cdot\text{ft}\cdot^\circ\text{F}$.

Analysis We consider heat loss through the walls only. The total heat transfer area is

$$A = 2(50 \times 9 + 35 \times 9) = 1530 \text{ ft}^2$$

The rate of heat loss during the daytime is

$$\dot{Q}_{\text{day}} = kA \frac{T_1 - T_2}{L} = (0.40 \text{ Btu/h}\cdot\text{ft}\cdot^\circ\text{F})(1530 \text{ ft}^2) \frac{(55 - 45)^\circ\text{F}}{1 \text{ ft}} = 6120 \text{ Btu/h}$$

The rate of heat loss during nighttime is

$$\begin{aligned} \dot{Q}_{\text{night}} &= kA \frac{T_1 - T_2}{L} \\ &= (0.40 \text{ Btu/h}\cdot\text{ft}\cdot^\circ\text{F})(1530 \text{ ft}^2) \frac{(55 - 35)^\circ\text{C}}{1 \text{ ft}} = 12,240 \text{ Btu/h} \end{aligned}$$

The amount of heat loss from the house that night will be

$$\begin{aligned} \dot{Q} &= \frac{Q}{\Delta t} \longrightarrow Q = \dot{Q} \Delta t = 10 \dot{Q}_{\text{day}} + 14 \dot{Q}_{\text{night}} = (10 \text{ h})(6120 \text{ Btu/h}) + (14 \text{ h})(12,240 \text{ Btu/h}) \\ &= \mathbf{232,560 \text{ Btu}} \end{aligned}$$

Then the cost of this heat loss for that day becomes

$$\text{Cost} = (232,560 / 3412 \text{ kWh})(\$0.09 / \text{kWh}) = \mathbf{\$6.13}$$

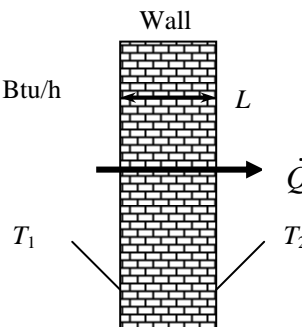

3-24 A cylindrical resistor on a circuit board dissipates 0.15 W of power steadily in a specified environment. The amount of heat dissipated in 24 h, the surface heat flux, and the surface temperature of the resistor are to be determined.

Assumptions 1 Steady operating conditions exist. **2** Heat is transferred uniformly from all surfaces of the resistor.

Analysis (a) The amount of heat this resistor dissipates during a 24-hour period is

$$Q = \dot{Q} \Delta t = (0.15 \text{ W})(24 \text{ h}) = \mathbf{3.6 \text{ Wh}}$$

(b) The heat flux on the surface of the resistor is

$$A_s = 2 \frac{\pi D^2}{4} + \pi DL = 2 \frac{\pi(0.003 \text{ m})^2}{4} + \pi(0.003 \text{ m})(0.012 \text{ m}) = 0.000127 \text{ m}^2$$

$$\dot{q} = \frac{\dot{Q}}{A_s} = \frac{0.15 \text{ W}}{0.000127 \text{ m}^2} = \mathbf{1179 \text{ W/m}^2}$$

(c) The surface temperature of the resistor can be determined from

$$\dot{Q} = hA_s(T_s - T_\infty) \longrightarrow T_s = T_\infty + \frac{\dot{Q}}{hA_s} = 40^\circ\text{C} + \frac{0.15 \text{ W}}{(9 \text{ W/m}^2 \cdot ^\circ\text{C})(0.000127 \text{ m}^2)} = \mathbf{171^\circ\text{C}}$$

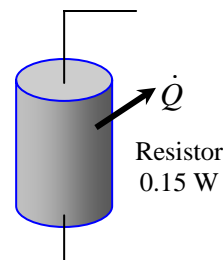

3-25 A power transistor dissipates 0.2 W of power steadily in a specified environment. The amount of heat dissipated in 24 h, the surface heat flux, and the surface temperature of the resistor are to be determined.

Assumptions 1 Steady operating conditions exist. 2 Heat is transferred uniformly from all surfaces of the transistor.

Analysis (a) The amount of heat this transistor dissipates during a 24-hour period is

$$Q = \dot{Q}\Delta t = (0.2 \text{ W})(24 \text{ h}) = 4.8 \text{ Wh} = \mathbf{0.0048 \text{ kWh}}$$

(b) The heat flux on the surface of the transistor is

$$A_s = 2 \frac{\pi D^2}{4} + \pi DL$$

$$= 2 \frac{\pi(0.005 \text{ m})^2}{4} + \pi(0.005 \text{ m})(0.004 \text{ m}) = 0.0001021 \text{ m}^2$$

$$\dot{q} = \frac{\dot{Q}}{A_s} = \frac{0.2 \text{ W}}{0.0001021 \text{ m}^2} = \mathbf{1959 \text{ W/m}^2}$$

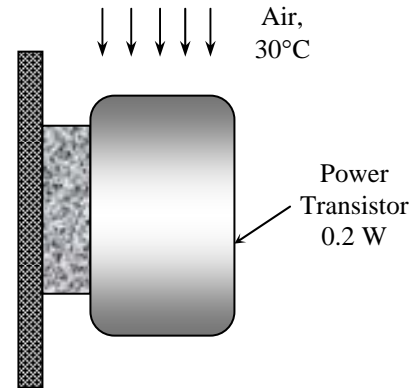

(c) The surface temperature of the transistor can be determined from

$$\dot{Q} = hA_s(T_s - T_\infty) \longrightarrow T_s = T_\infty + \frac{\dot{Q}}{hA_s} = 30^\circ\text{C} + \frac{0.2 \text{ W}}{(18 \text{ W/m}^2 \cdot ^\circ\text{C})(0.0001021 \text{ m}^2)} = \mathbf{139^\circ\text{C}}$$

3-26 A circuit board houses 100 chips, each dissipating 0.06 W. The surface heat flux, the surface temperature of the chips, and the thermal resistance between the surface of the board and the cooling medium are to be determined.

Assumptions 1 Steady operating conditions exist. 2 Heat transfer from the back surface of the board is negligible. 2 Heat is transferred uniformly from the entire front surface.

Analysis (a) The heat flux on the surface of the circuit board is

$$A_s = (0.12 \text{ m})(0.18 \text{ m}) = 0.0216 \text{ m}^2$$

$$\dot{q} = \frac{\dot{Q}}{A_s} = \frac{(100 \times 0.06) \text{ W}}{0.0216 \text{ m}^2} = \mathbf{278 \text{ W/m}^2}$$

(b) The surface temperature of the chips is

$$\dot{Q} = hA_s(T_s - T_\infty)$$

$$T_s = T_\infty + \frac{\dot{Q}}{hA_s} = 40^\circ\text{C} + \frac{(100 \times 0.06) \text{ W}}{(10 \text{ W/m}^2 \cdot ^\circ\text{C})(0.0216 \text{ m}^2)} = \mathbf{67.8^\circ\text{C}}$$

(c) The thermal resistance is

$$R_{conv} = \frac{1}{hA_s} = \frac{1}{(10 \text{ W/m}^2 \cdot ^\circ\text{C})(0.0216 \text{ m}^2)} = \mathbf{4.63^\circ\text{C/W}}$$

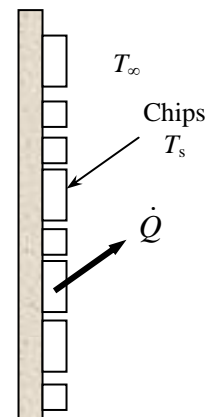

3-27 A person is dissipating heat at a rate of 150 W by natural convection and radiation to the surrounding air and surfaces. For a given deep body temperature, the outer skin temperature is to be determined.

Assumptions 1 Steady operating conditions exist. 2 The heat transfer coefficient is constant and uniform over the entire exposed surface of the person. 3 The surrounding surfaces are at the same temperature as the indoor air temperature. 4 Heat generation within the 0.5-cm thick outer layer of the tissue is negligible.

Properties The thermal conductivity of the tissue near the skin is given to be $k = 0.3 \text{ W/m}\cdot\text{°C}$.

Analysis The skin temperature can be determined directly from

$$\dot{Q} = kA \frac{T_1 - T_{skin}}{L}$$

$$T_{skin} = T_1 - \frac{\dot{Q}L}{kA} = 37^\circ\text{C} - \frac{(150 \text{ W})(0.005 \text{ m})}{(0.3 \text{ W/m}\cdot\text{°C})(1.7 \text{ m}^2)} = \mathbf{35.5^\circ\text{C}}$$

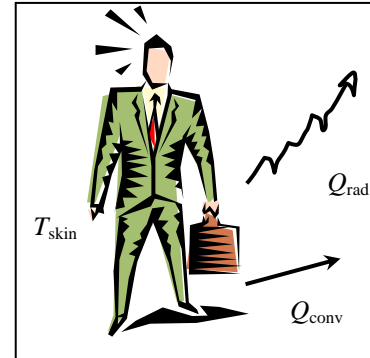

3-28 Heat is transferred steadily to the boiling water in an aluminum pan. The inner surface temperature of the bottom of the pan is given. The boiling heat transfer coefficient and the outer surface temperature of the bottom of the pan are to be determined.

Assumptions 1 Steady operating conditions exist. 2 Heat transfer is one-dimensional since the thickness of the bottom of the pan is small relative to its diameter. 3 The thermal conductivity of the pan is constant.

Properties The thermal conductivity of the aluminum pan is given to be $k = 237 \text{ W/m}\cdot\text{°C}$.

Analysis (a) The boiling heat transfer coefficient is

$$A_s = \frac{\pi D^2}{4} = \frac{\pi(0.25 \text{ m})^2}{4} = 0.0491 \text{ m}^2$$

$$\dot{Q} = hA_s(T_s - T_\infty)$$

$$h = \frac{\dot{Q}}{A_s(T_s - T_\infty)} = \frac{800 \text{ W}}{(0.0491 \text{ m}^2)(108 - 95)^\circ\text{C}} = \mathbf{1254 \text{ W/m}^2\cdot\text{°C}}$$

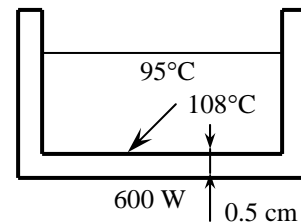

(b) The outer surface temperature of the bottom of the pan is

$$\dot{Q} = kA \frac{T_{s,outer} - T_{s,inner}}{L}$$

$$T_{s,outer} = T_{s,inner} + \frac{\dot{Q}L}{kA} = 108^\circ\text{C} + \frac{(800 \text{ W})(0.005 \text{ m})}{(237 \text{ W/m}\cdot\text{°C})(0.0491 \text{ m}^2)} = \mathbf{108.3^\circ\text{C}}$$

3-29E A wall is constructed of two layers of sheetrock with fiberglass insulation in between. The thermal resistance of the wall and its R-value of insulation are to be determined.

Assumptions 1 Heat transfer through the wall is one-dimensional. 2 Thermal conductivities are constant.

Properties The thermal conductivities are given to be

$$k_{\text{sheetrock}} = 0.10 \text{ Btu/h}\cdot\text{ft}\cdot^\circ\text{F} \text{ and } k_{\text{insulation}} = 0.020 \text{ Btu/h}\cdot\text{ft}\cdot^\circ\text{F}.$$

Analysis (a) The surface area of the wall is not given and thus we consider a unit surface area ($A = 1 \text{ ft}^2$). Then the R-value of insulation of the wall becomes equivalent to its thermal resistance, which is determined from.

$$R_{\text{sheetrock}} = R_1 = R_3 = \frac{L_1}{k_1} = \frac{0.7/12 \text{ ft}}{(0.10 \text{ Btu/h}\cdot\text{ft}\cdot^\circ\text{F})} = 0.583 \text{ ft}^2 \cdot^\circ\text{F}\cdot\text{h/Btu}$$

$$R_{\text{fiberglass}} = R_2 = \frac{L_2}{k_2} = \frac{7/12 \text{ ft}}{(0.020 \text{ Btu/h}\cdot\text{ft}\cdot^\circ\text{F})} = 29.17 \text{ ft}^2 \cdot^\circ\text{F}\cdot\text{h/Btu}$$

$$R_{\text{total}} = 2R_1 + R_2 = 2 \times 0.583 + 29.17 = \mathbf{30.34 \text{ ft}^2 \cdot^\circ\text{F}\cdot\text{h/Btu}}$$

(b) Therefore, this is approximately a **R-30** wall in English units.

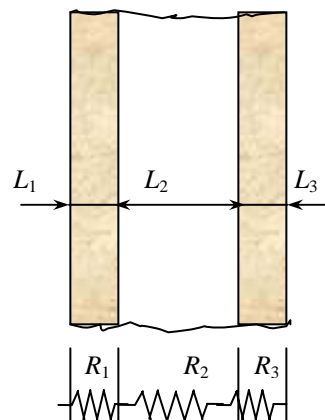

3-30 The roof of a house with a gas furnace consists of a concrete that is losing heat to the outdoors by radiation and convection. The rate of heat transfer through the roof and the money lost through the roof that night during a 14 hour period are to be determined.

Assumptions 1 Steady operating conditions exist. **2** The emissivity and thermal conductivity of the roof are constant.

Properties The thermal conductivity of the concrete is given to be $k = 2 \text{ W/m}\cdot\text{C}$. The emissivity of both surfaces of the roof is given to be 0.9.

Analysis When the surrounding surface temperature is different than the ambient temperature, the thermal resistances network approach becomes cumbersome in problems that involve radiation. Therefore, we will use a different but intuitive approach.

In steady operation, heat transfer from the room to the roof (by convection and radiation) must be equal to the heat transfer from the roof to the surroundings (by convection and radiation), that must be equal to the heat transfer through the roof by conduction. That is,

$$\dot{Q} = \dot{Q}_{\text{room to roof, conv+rad}} = \dot{Q}_{\text{roof, cond}} = \dot{Q}_{\text{roof to surroundings, conv+rad}}$$

Taking the inner and outer surface temperatures of the roof to be $T_{s,in}$ and $T_{s,out}$, respectively, the quantities above can be expressed as

$$\begin{aligned} \dot{Q}_{\text{room to roof, conv+rad}} &= h_i A (T_{\text{room}} - T_{s,in}) + \varepsilon A \sigma (T_{\text{room}}^4 - T_{s,in}^4) = (5 \text{ W/m}^2 \cdot \text{C})(300 \text{ m}^2)(20 - T_{s,in})^\circ\text{C} \\ &\quad + (0.9)(300 \text{ m}^2)(5.67 \times 10^{-8} \text{ W/m}^2 \cdot \text{K}^4) \left[(20 + 273 \text{ K})^4 - (T_{s,in} + 273 \text{ K})^4 \right] \end{aligned}$$

$$\dot{Q}_{\text{roof, cond}} = kA \frac{T_{s,in} - T_{s,out}}{L} = (2 \text{ W/m}\cdot\text{C})(300 \text{ m}^2) \frac{T_{s,in} - T_{s,out}}{0.15 \text{ m}}$$

$$\begin{aligned} \dot{Q}_{\text{roof to surr, conv+rad}} &= h_o A (T_{s,out} - T_{\text{surr}}) + \varepsilon A \sigma (T_{s,out}^4 - T_{\text{surr}}^4) = (12 \text{ W/m}^2 \cdot \text{C})(300 \text{ m}^2)(T_{s,out} - 10)^\circ\text{C} \\ &\quad + (0.9)(300 \text{ m}^2)(5.67 \times 10^{-8} \text{ W/m}^2 \cdot \text{K}^4) \left[(T_{s,out} + 273 \text{ K})^4 - (100 \text{ K})^4 \right] \end{aligned}$$

Solving the equations above simultaneously gives

$$\dot{Q} = \mathbf{37,440 \text{ W}}, T_{s,in} = \mathbf{7.3^\circ\text{C}}, \text{ and } T_{s,out} = \mathbf{-2.1^\circ\text{C}}$$

The total amount of natural gas consumption during a 14-hour period is

$$Q_{\text{gas}} = \frac{Q_{\text{total}}}{0.80} = \frac{\dot{Q} \Delta t}{0.80} = \frac{(37.440 \text{ kJ/s})(14 \times 3600 \text{ s})}{0.80} \left(\frac{1 \text{ therm}}{105,500 \text{ kJ}} \right) = 22.36 \text{ therms}$$

Finally, the money lost through the roof during that period is

$$\text{Money lost} = (22.36 \text{ therms})(\$1.20 / \text{therm}) = \mathbf{\$26.8}$$

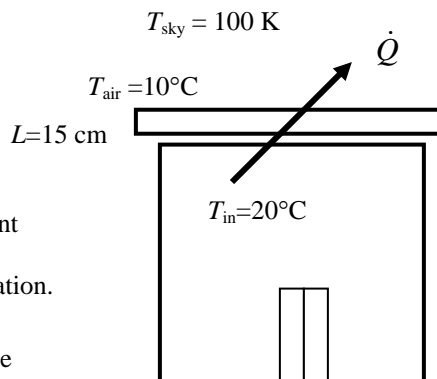

3-31 An exposed hot surface of an industrial natural gas furnace is to be insulated to reduce the heat loss through that section of the wall by 90 percent. The thickness of the insulation that needs to be used is to be determined. Also, the length of time it will take for the insulation to pay for itself from the energy it saves will be determined.

Assumptions 1 Heat transfer through the wall is steady and one-dimensional. 2 Thermal conductivities are constant. 3 The furnace operates continuously. 4 The given heat transfer coefficient accounts for the radiation effects.

Properties The thermal conductivity of the glass wool insulation is given to be $k = 0.038 \text{ W/m}\cdot\text{C}$.

Analysis The rate of heat transfer without insulation is

$$A = (2 \text{ m})(1.5 \text{ m}) = 3 \text{ m}^2$$

$$\dot{Q} = hA(T_s - T_\infty) = (10 \text{ W/m}^2 \cdot \text{C})(3 \text{ m}^2)(80 - 30)^\circ\text{C} = 1500 \text{ W}$$

In order to reduce heat loss by 90%, the new heat transfer rate and thermal resistance must be

$$\dot{Q} = 0.10 \times 1500 \text{ W} = 150 \text{ W}$$

$$\dot{Q} = \frac{\Delta T}{R_{total}} \rightarrow R_{total} = \frac{\Delta T}{\dot{Q}} = \frac{(80 - 30)^\circ\text{C}}{150 \text{ W}} = 0.333^\circ\text{C/W}$$

and in order to have this thermal resistance, the thickness of insulation must be

$$\begin{aligned} R_{total} &= R_{conv} + R_{insulation} = \frac{1}{hA} + \frac{L}{kA} \\ &= \frac{1}{(10 \text{ W/m}^2 \cdot \text{C})(3 \text{ m}^2)} + \frac{L}{(0.038 \text{ W/m}\cdot\text{C})(3 \text{ m}^2)} = 0.333^\circ\text{C/W} \\ L &= 0.034 \text{ m} = \mathbf{3.4 \text{ cm}} \end{aligned}$$

Noting that heat is saved at a rate of $0.9 \times 1500 = 1350 \text{ W}$ and the furnace operates continuously and thus $365 \times 24 = 8760 \text{ h}$ per year, and that the furnace efficiency is 78%, the amount of natural gas saved per year is

$$\text{Energy Saved} = \frac{\dot{Q}_{saved} \Delta t}{\text{Efficiency}} = \frac{(1.350 \text{ kJ/s})(8760 \text{ h}) \left(\frac{3600 \text{ s}}{1 \text{ h}} \right) \left(\frac{1 \text{ therm}}{105,500 \text{ kJ}} \right)}{0.78} = 517.4 \text{ therms}$$

The money saved is

$$\text{Money saved} = (\text{Energy Saved})(\text{Cost of energy}) = (517.4 \text{ therms})(\$1.10/\text{therm}) = \$569.1 \text{ (per year)}$$

The insulation will pay for its cost of \$250 in

$$\text{Payback period} = \frac{\text{Money spent}}{\text{Money saved}} = \frac{\$250}{\$569.1/\text{yr}} = \mathbf{0.44 \text{ yr}}$$

which is equal to 5.3 months.

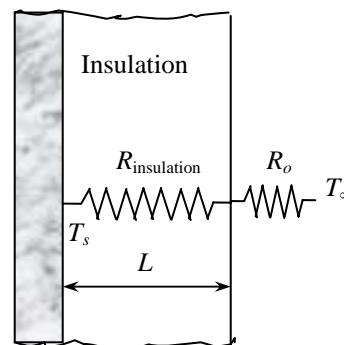

3-32 An exposed hot surface of an industrial natural gas furnace is to be insulated to reduce the heat loss through that section of the wall by 90 percent. The thickness of the insulation that needs to be used is to be determined. Also, the length of time it will take for the insulation to pay for itself from the energy it saves will be determined.

Assumptions 1 Heat transfer through the wall is steady and one-dimensional. 2 Thermal conductivities are constant. 3 The furnace operates continuously. 4 The given heat transfer coefficients accounts for the radiation effects.

Properties The thermal conductivity of the expanded perlite insulation is given to be $k = 0.052 \text{ W/m}\cdot\text{C}$.

Analysis The rate of heat transfer without insulation is

$$A = (2 \text{ m})(1.5 \text{ m}) = 3 \text{ m}^2$$

$$\dot{Q} = hA(T_s - T_\infty) = (10 \text{ W/m}^2 \cdot \text{C})(3 \text{ m}^2)(80 - 30)^\circ\text{C} = 1500 \text{ W}$$

In order to reduce heat loss by 90%, the new heat transfer rate and thermal resistance must be

$$\dot{Q} = 0.10 \times 1500 \text{ W} = 150 \text{ W}$$

$$\dot{Q} = \frac{\Delta T}{R_{total}} \longrightarrow R_{total} = \frac{\Delta T}{\dot{Q}} = \frac{(80 - 30)^\circ\text{C}}{150 \text{ W}} = 0.333^\circ\text{C/W}$$

and in order to have this thermal resistance, the thickness of insulation must be

$$\begin{aligned} R_{total} &= R_{conv} + R_{insulation} = \frac{1}{hA} + \frac{L}{kA} \\ &= \frac{1}{(10 \text{ W/m}^2 \cdot \text{C})(3 \text{ m}^2)} + \frac{L}{(0.052 \text{ W/m}\cdot\text{C})(3 \text{ m}^2)} = 0.333^\circ\text{C/W} \\ L &= 0.047 \text{ m} = \mathbf{4.7 \text{ cm}} \end{aligned}$$

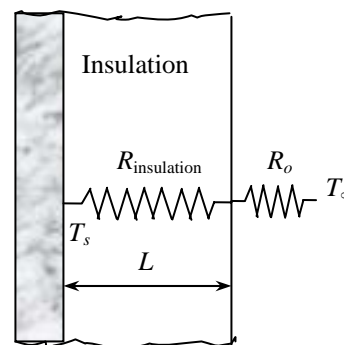

Noting that heat is saved at a rate of $0.9 \times 1500 = 1350 \text{ W}$ and the furnace operates continuously and thus $365 \times 24 = 8760 \text{ h}$ per year, and that the furnace efficiency is 78%, the amount of natural gas saved per year is

$$\text{Energy Saved} = \frac{\dot{Q}_{saved} \Delta t}{\text{Efficiency}} = \frac{(1.350 \text{ kJ/s})(8760 \text{ h}) \left(\frac{3600 \text{ s}}{1 \text{ h}} \right) \left(\frac{1 \text{ therm}}{105,500 \text{ kJ}} \right)}{0.78} = 517.4 \text{ therms}$$

The money saved is

$$\text{Money saved} = (\text{Energy Saved})(\text{Cost of energy}) = (517.4 \text{ therms})(\$1.10/\text{therm}) = \$569.1 \text{ (per year)}$$

The insulation will pay for its cost of \$250 in

$$\text{Payback period} = \frac{\text{Money spent}}{\text{Money saved}} = \frac{\$250}{\$569.1/\text{yr}} = \mathbf{0.44 \text{ yr}}$$

which is equal to 5.3 months.

3-33 EES Prob. 3-31 is reconsidered. The effect of thermal conductivity on the required insulation thickness is to be investigated.

Analysis The problem is solved using EES, and the solution is given below.

"GIVEN"

$$A=2*1.5 \text{ [m}^2\text{]}$$

$$T_s=80 \text{ [C]}$$

$$T_{\text{infinity}}=30 \text{ [C]}$$

$$h=10 \text{ [W/m}^2\text{-C]}$$

$$k_{\text{ins}}=0.038 \text{ [W/m-C]}$$

$$f_{\text{reduce}}=0.90$$

"ANALYSIS"

$$Q_{\text{dot_old}}=h*A*(T_s-T_{\text{infinity}})$$

$$Q_{\text{dot_new}}=(1-f_{\text{reduce}})*Q_{\text{dot_old}}$$

$$Q_{\text{dot_new}}=(T_s-T_{\text{infinity}})/R_{\text{total}}$$

$$R_{\text{total}}=R_{\text{conv}}+R_{\text{ins}}$$

$$R_{\text{conv}}=1/(h*A)$$

$$R_{\text{ins}}=(L_{\text{ins}}*\text{Convert(cm, m)})/(k_{\text{ins}}*A) \text{ "L}_{\text{ins}} \text{ is in cm"}$$

k_{ins} [W/m.C]	L_{ins} [cm]
0.02	1.8
0.025	2.25
0.03	2.7
0.035	3.15
0.04	3.6
0.045	4.05
0.05	4.5
0.055	4.95
0.06	5.4
0.065	5.85
0.07	6.3
0.075	6.75
0.08	7.2

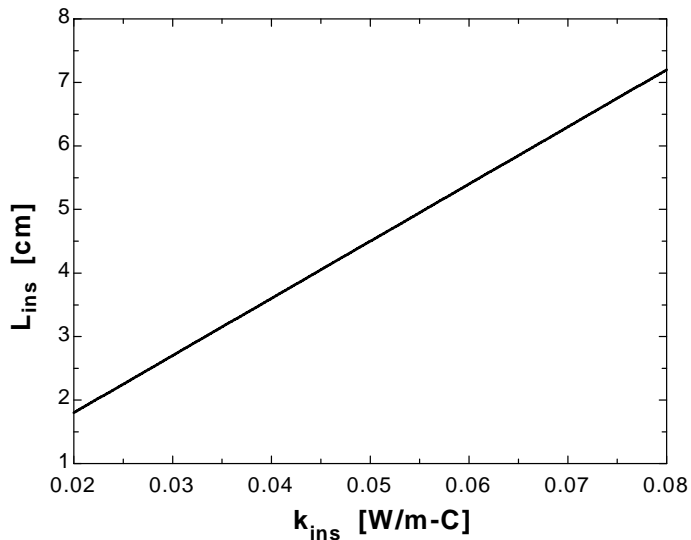

3-34E Two of the walls of a house have no windows while the other two walls have 4 windows each. The ratio of heat transfer through the walls with and without windows is to be determined.

Assumptions 1 Heat transfer through the walls and the windows is steady and one-dimensional. **2** Thermal conductivities are constant. **3** Any direct radiation gain or loss through the windows is negligible. **4** Heat transfer coefficients are constant and uniform over the entire surface.

Properties The thermal conductivity of the glass is given to be $k_{\text{glass}} = 0.45 \text{ Btu/h}\cdot\text{ft}\cdot^\circ\text{F}$. The R-value of the wall is given to be $19 \text{ h}\cdot\text{ft}^2\cdot^\circ\text{F/Btu}$.

Analysis The thermal resistances through the wall without windows are

$$A = (12 \text{ ft})(40 \text{ ft}) = 480 \text{ ft}^2$$

$$R_i = \frac{1}{h_i A} = \frac{1}{(2 \text{ Btu/h}\cdot\text{ft}^2\cdot^\circ\text{F})(480 \text{ ft}^2)} = 0.0010417 \text{ h}\cdot^\circ\text{F/Btu}$$

$$R_{\text{wall}} = \frac{L}{kA} = \frac{19 \text{ h}\cdot\text{ft}^2\cdot^\circ\text{F/Btu}}{480 \text{ ft}^2} = 0.03958 \text{ h}\cdot^\circ\text{F/Btu}$$

$$R_o = \frac{1}{h_o A} = \frac{1}{(4 \text{ Btu/h}\cdot\text{ft}^2\cdot^\circ\text{F})(480 \text{ ft}^2)} = 0.00052 \text{ h}\cdot^\circ\text{F/Btu}$$

$$R_{\text{total},1} = R_i + R_{\text{wall}} + R_o \\ = 0.0010417 + 0.03958 + 0.00052 = 0.0411417 \text{ h}\cdot^\circ\text{F/Btu}$$

The thermal resistances through the wall with windows are

$$A_{\text{windows}} = 4(3 \times 5) = 60 \text{ ft}^2$$

$$A_{\text{wall}} = A_{\text{total}} - A_{\text{windows}} = 480 - 60 = 420 \text{ ft}^2$$

$$R_2 = R_{\text{glass}} = \frac{L}{kA} = \frac{0.25 / 12 \text{ ft}}{(0.45 \text{ Btu/h}\cdot\text{ft}\cdot^\circ\text{F})(60 \text{ ft}^2)} = 0.0007716 \text{ h}\cdot^\circ\text{F/Btu}$$

$$R_4 = R_{\text{wall}} = \frac{L}{kA} = \frac{19 \text{ h}\cdot\text{ft}^2\cdot^\circ\text{F/Btu}}{(420 \text{ ft}^2)} = 0.04524 \text{ h}\cdot^\circ\text{F/Btu}$$

$$\frac{1}{R_{\text{eqv}}} = \frac{1}{R_{\text{glass}}} + \frac{1}{R_{\text{wall}}} = \frac{1}{0.0007716} + \frac{1}{0.04524} \longrightarrow R_{\text{eqv}} = 0.00076 \text{ h}\cdot^\circ\text{F/Btu}$$

$$R_{\text{total},2} = R_i + R_{\text{eqv}} + R_o = 0.001047 + 0.00076 + 0.00052 = 0.002327 \text{ h}\cdot^\circ\text{F/Btu}$$

Then the ratio of the heat transfer through the walls with and without windows becomes

$$\frac{\dot{Q}_{\text{total},2}}{\dot{Q}_{\text{total},1}} = \frac{\Delta T / R_{\text{total},2}}{\Delta T / R_{\text{total},1}} = \frac{R_{\text{total},1}}{R_{\text{total},2}} = \frac{0.0411417}{0.002327} = \mathbf{17.7}$$

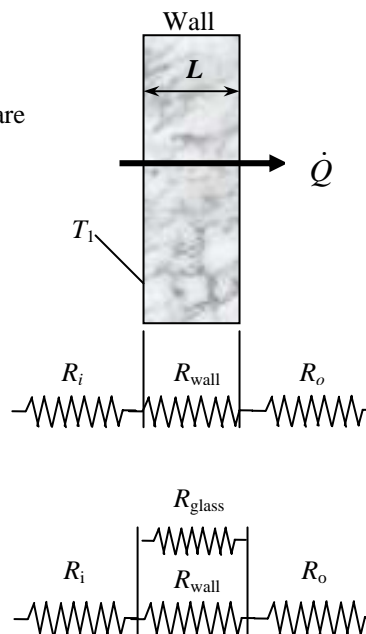

3-35 Two of the walls of a house have no windows while the other two walls have single- or double-pane windows. The average rate of heat transfer through each wall, and the amount of money this household will save per heating season by converting the single pane windows to double pane windows are to be determined.

Assumptions 1 Heat transfer through the window is steady since the indoor and outdoor temperatures remain constant at the specified values. **2** Heat transfer is one-dimensional since any significant temperature gradients will exist in the direction from the indoors to the outdoors. **3** Thermal conductivities of the glass and air are constant. **4** Heat transfer by radiation is disregarded.

Properties The thermal conductivities are given to be $k = 0.026 \text{ W/m}\cdot^\circ\text{C}$ for air, and $0.78 \text{ W/m}\cdot^\circ\text{C}$ for glass.

Analysis The rate of heat transfer through each wall can be determined by applying thermal resistance network. The convection resistances at the inner and outer surfaces are common in all cases.

Walls without windows:

$$R_i = \frac{1}{h_i A} = \frac{1}{(7 \text{ W/m}^2 \cdot ^\circ\text{C})(10 \times 4 \text{ m}^2)} = 0.003571 \text{ }^\circ\text{C/W}$$

$$R_{\text{wall}} = \frac{L_{\text{wall}}}{kA} = \frac{R\text{-value}}{A} = \frac{2.31 \text{ m}^2 \cdot ^\circ\text{C/W}}{(10 \times 4 \text{ m}^2)} = 0.05775 \text{ }^\circ\text{C/W}$$

$$R_o = \frac{1}{h_o A} = \frac{1}{(18 \text{ W/m}^2 \cdot ^\circ\text{C})(10 \times 4 \text{ m}^2)} = 0.001389 \text{ }^\circ\text{C/W}$$

$$R_{\text{total}} = R_i + R_{\text{wall}} + R_o = 0.003571 + 0.05775 + 0.001389 = 0.06271 \text{ }^\circ\text{C/W}$$

$$\text{Then } \dot{Q} = \frac{T_{\infty 1} - T_{\infty 2}}{R_{\text{total}}} = \frac{(24 - 8)^\circ\text{C}}{0.06271 \text{ }^\circ\text{C/W}} = \mathbf{255.1 \text{ W}}$$

Wall with single pane windows:

$$R_i = \frac{1}{h_i A} = \frac{1}{(7 \text{ W/m}^2 \cdot ^\circ\text{C})(20 \times 4 \text{ m}^2)} = 0.001786 \text{ }^\circ\text{C/W}$$

$$R_{\text{wall}} = \frac{L_{\text{wall}}}{kA} = \frac{R\text{-value}}{A} = \frac{2.31 \text{ m}^2 \cdot ^\circ\text{C/W}}{(20 \times 4) - 5(1.2 \times 1.8) \text{ m}^2} = 0.033382 \text{ }^\circ\text{C/W}$$

$$R_{\text{glass}} = \frac{L_{\text{glass}}}{kA} = \frac{0.005 \text{ m}}{(0.78 \text{ W/m}^2 \cdot ^\circ\text{C})(1.2 \times 1.8) \text{ m}^2} = 0.002968 \text{ }^\circ\text{C/W}$$

$$\frac{1}{R_{\text{eqv}}} = \frac{1}{R_{\text{wall}}} + 5 \frac{1}{R_{\text{glass}}} = \frac{1}{0.033382} + 5 \frac{1}{0.002968} \rightarrow R_{\text{eqv}} = 0.000583 \text{ }^\circ\text{C/W}$$

$$R_o = \frac{1}{h_o A} = \frac{1}{(18 \text{ W/m}^2 \cdot ^\circ\text{C})(20 \times 4 \text{ m}^2)} = 0.000694 \text{ }^\circ\text{C/W}$$

$$R_{\text{total}} = R_i + R_{\text{eqv}} + R_o = 0.001786 + 0.000583 + 0.000694 = 0.003063 \text{ }^\circ\text{C/W}$$

Then

$$\dot{Q} = \frac{T_{\infty 1} - T_{\infty 2}}{R_{\text{total}}} = \frac{(24 - 8)^\circ\text{C}}{0.003063 \text{ }^\circ\text{C/W}} = \mathbf{5224 \text{ W}}$$

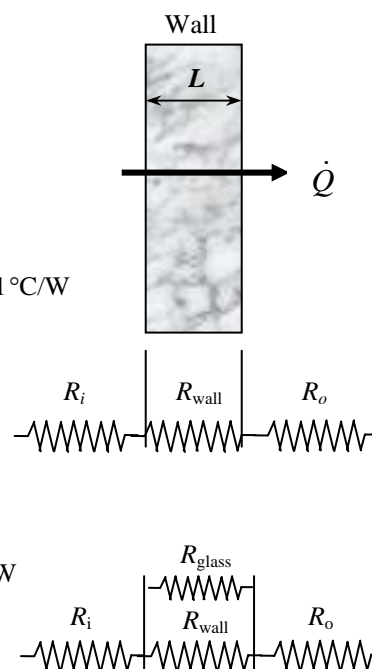

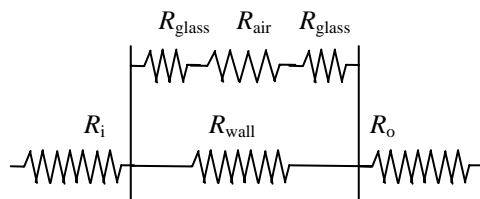
4th wall with double pane windows:

$$R_{\text{wall}} = \frac{L_{\text{wall}}}{kA} = \frac{R\text{-value}}{A} = \frac{2.31 \text{ m}^2 \cdot \text{°C/W}}{(20 \times 4) - 5(1.2 \times 1.8) \text{ m}^2} = 0.033382 \text{ °C/W}$$

$$R_{\text{glass}} = \frac{L_{\text{glass}}}{kA} = \frac{0.005 \text{ m}}{(0.78 \text{ W/m}^2 \cdot \text{°C})(1.2 \times 1.8) \text{ m}^2} = 0.002968 \text{ °C/W}$$

$$R_{\text{air}} = \frac{L_{\text{air}}}{kA} = \frac{0.015 \text{ m}}{(0.026 \text{ W/m}^2 \cdot \text{°C})(1.2 \times 1.8) \text{ m}^2} = 0.267094 \text{ °C/W}$$

$$R_{\text{window}} = 2R_{\text{glass}} + R_{\text{air}} = 2 \times 0.002968 + 0.267094 = 0.27303 \text{ °C/W}$$

$$\frac{1}{R_{\text{eqv}}} = \frac{1}{R_{\text{wall}}} + 5 \frac{1}{R_{\text{window}}} = \frac{1}{0.033382} + 5 \frac{1}{0.27303} \longrightarrow R_{\text{eqv}} = 0.020717 \text{ °C/W}$$

$$R_{\text{total}} = R_i + R_{\text{eqv}} + R_o = 0.001786 + 0.020717 + 0.000694 = 0.023197 \text{ °C/W}$$

Then $\dot{Q} = \frac{T_{\infty 1} - T_{\infty 2}}{R_{\text{total}}} = \frac{(24 - 8) \text{ °C}}{0.023197 \text{ °C/W}} = \mathbf{690 \text{ W}}$

The rate of heat transfer which will be saved if the single pane windows are converted to double pane windows is

$$\dot{Q}_{\text{save}} = \dot{Q}_{\text{single pane}} - \dot{Q}_{\text{double pane}} = 5224 - 690 = 4534 \text{ W}$$

The amount of energy and money saved during a 7-month long heating season by switching from single pane to double pane windows become

$$Q_{\text{save}} = \dot{Q}_{\text{save}} \Delta t = (4.534 \text{ kW})(7 \times 30 \times 24 \text{ h}) = 22,851 \text{ kWh}$$

$$\text{Money savings} = (\text{Energy saved})(\text{Unit cost of energy}) = (22,851 \text{ kWh})(\$0.08/\text{kWh}) = \mathbf{\$1828}$$

3-36 The wall of a refrigerator is constructed of fiberglass insulation sandwiched between two layers of sheet metal. The minimum thickness of insulation that needs to be used in the wall in order to avoid condensation on the outer surfaces is to be determined.

Assumptions 1 Heat transfer through the refrigerator walls is steady since the temperatures of the food compartment and the kitchen air remain constant at the specified values. **2** Heat transfer is one-dimensional. **3** Thermal conductivities are constant. **4** Heat transfer coefficients account for the radiation effects.

Properties The thermal conductivities are given to be $k = 15.1 \text{ W/m}\cdot^\circ\text{C}$ for sheet metal and $0.035 \text{ W/m}\cdot^\circ\text{C}$ for fiberglass insulation.

Analysis The minimum thickness of insulation can be determined by assuming the outer surface temperature of the refrigerator to be 20°C . In steady operation, the rate of heat transfer through the refrigerator wall is constant, and thus heat transfer between the room and the refrigerated space is equal to the heat transfer between the room and the outer surface of the refrigerator. Considering a unit surface area,

$$\begin{aligned}\dot{Q} &= h_o A (T_{\text{room}} - T_{s,\text{out}}) \\ &= (9 \text{ W/m}^2 \cdot ^\circ\text{C})(1 \text{ m}^2)(25 - 20)^\circ\text{C} = 45 \text{ W}\end{aligned}$$

Using the thermal resistance network, heat transfer between the room and the refrigerated space can be expressed as

$$\begin{aligned}\dot{Q} &= \frac{T_{\text{room}} - T_{\text{refrig}}}{R_{\text{total}}} \\ \dot{Q}/A &= \frac{T_{\text{room}} - T_{\text{refrig}}}{\frac{1}{h_o} + 2\left(\frac{L}{k}\right)_{\text{metal}} + \left(\frac{L}{k}\right)_{\text{insulation}} + \frac{1}{h_i}}\end{aligned}$$

Substituting,

$$45 \text{ W/m}^2 = \frac{(25 - 3)^\circ\text{C}}{\frac{1}{9 \text{ W/m}^2 \cdot ^\circ\text{C}} + \frac{2 \times 0.001 \text{ m}}{15.1 \text{ W/m}^2 \cdot ^\circ\text{C}} + \frac{L}{0.035 \text{ W/m}^2 \cdot ^\circ\text{C}} + \frac{1}{4 \text{ W/m}^2 \cdot ^\circ\text{C}}}$$

Solving for L , the minimum thickness of insulation is determined to be

$$L = 0.0045 \text{ m} = \mathbf{0.45 \text{ cm}}$$

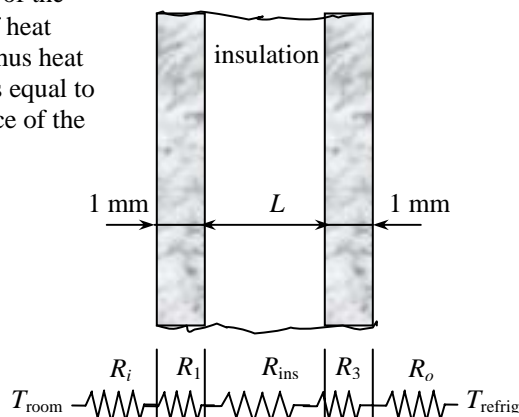

3-37 EES Prob. 3-36 is reconsidered. The effects of the thermal conductivities of the insulation material and the sheet metal on the thickness of the insulation is to be investigated.

Analysis The problem is solved using EES, and the solution is given below.

"GIVEN"

k_ins=0.035 [W/m-C]
 L_metal=0.001 [m]
 k_metal=15.1 [W/m-C]
 T_refrig=3 [C]
 T_kitchen=25 [C]
 h_i=4 [W/m^2-C]
 h_o=9 [W/m^2-C]
 T_s_out=20 [C]

"ANALYSIS"

A=1 [m^2] "a unit surface area is considered"
 $Q_{\dot{}}=h_o \cdot A \cdot (T_{\text{kitchen}} - T_{\text{s_out}})$
 $Q_{\dot{}}=(T_{\text{kitchen}} - T_{\text{refrig}})/R_{\text{total}}$
 $R_{\text{total}}=R_{\text{conv_i}} + 2 \cdot R_{\text{metal}} + R_{\text{ins}} + R_{\text{conv_o}}$
 $R_{\text{conv_i}}=1/(h_i \cdot A)$
 $R_{\text{metal}}=L_{\text{metal}}/(k_{\text{metal}} \cdot A)$
 $R_{\text{ins}}=(L_{\text{ins}} \cdot \text{Convert}(\text{cm}, \text{m})) / (k_{\text{ins}} \cdot A)$ "L_ins is in cm"
 $R_{\text{conv_o}}=1/(h_o \cdot A)$

k_{ins} [W/m.C]	L_{ins} [cm]
0.02	0.2553
0.025	0.3191
0.03	0.3829
0.035	0.4468
0.04	0.5106
0.045	0.5744
0.05	0.6382
0.055	0.702
0.06	0.7659
0.065	0.8297
0.07	0.8935
0.075	0.9573
0.08	1.021

k_{metal} [W/m.C]	L_{ins} [cm]
10	0.4465
30.53	0.447
51.05	0.4471
71.58	0.4471
92.11	0.4471
112.6	0.4472
133.2	0.4472
153.7	0.4472
174.2	0.4472
194.7	0.4472
215.3	0.4472
235.8	0.4472

256.3	0.4472
276.8	0.4472
297.4	0.4472
317.9	0.4472
338.4	0.4472
358.9	0.4472
379.5	0.4472
400	0.4472

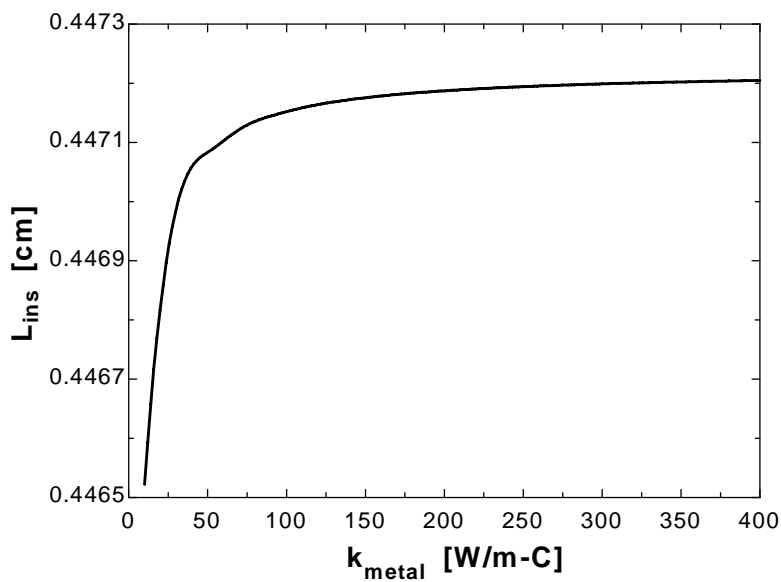
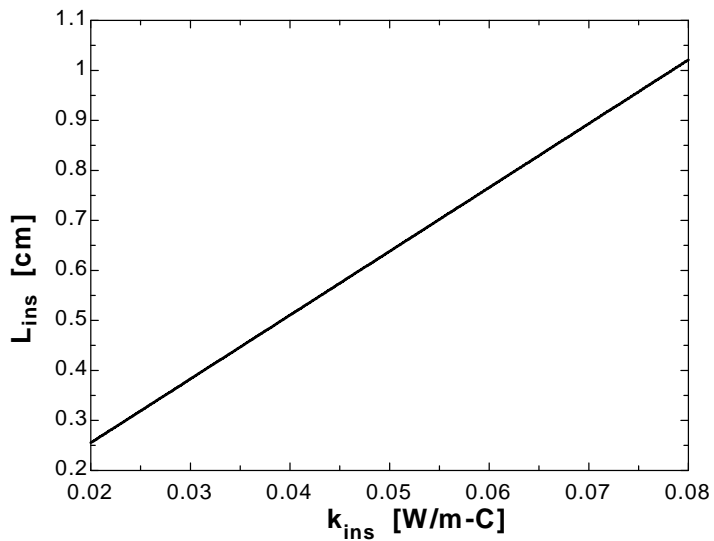

3-38 Heat is to be conducted along a circuit board with a copper layer on one side. The percentages of heat conduction along the copper and epoxy layers as well as the effective thermal conductivity of the board are to be determined.

Assumptions 1 Steady operating conditions exist. 2 Heat transfer is one-dimensional since heat transfer from the side surfaces is disregarded 3 Thermal conductivities are constant.

Properties The thermal conductivities are given to be $k = 386 \text{ W/m}\cdot^\circ\text{C}$ for copper and $0.26 \text{ W/m}\cdot^\circ\text{C}$ for epoxy layers.

Analysis We take the length in the direction of heat transfer to be L and the width of the board to be w . Then heat conduction along this two-layer board can be expressed as

$$\begin{aligned}\dot{Q} &= \dot{Q}_{\text{copper}} + \dot{Q}_{\text{epoxy}} = \left(kA \frac{\Delta T}{L} \right)_{\text{copper}} + \left(kA \frac{\Delta T}{L} \right)_{\text{epoxy}} \\ &= \left[(kt)_{\text{copper}} + (kt)_{\text{epoxy}} \right] w \frac{\Delta T}{L}\end{aligned}$$

Heat conduction along an “equivalent” board of thickness $t = t_{\text{copper}} + t_{\text{epoxy}}$ and thermal conductivity k_{eff} can be expressed as

$$\dot{Q} = \left(kA \frac{\Delta T}{L} \right)_{\text{board}} = k_{\text{eff}} (t_{\text{copper}} + t_{\text{epoxy}}) w \frac{\Delta T}{L}$$

Setting the two relations above equal to each other and solving for the effective conductivity gives

$$k_{\text{eff}} (t_{\text{copper}} + t_{\text{epoxy}}) = (kt)_{\text{copper}} + (kt)_{\text{epoxy}} \longrightarrow k_{\text{eff}} = \frac{(kt)_{\text{copper}} + (kt)_{\text{epoxy}}}{t_{\text{copper}} + t_{\text{epoxy}}}$$

Note that heat conduction is proportional to kt . Substituting, the fractions of heat conducted along the copper and epoxy layers as well as the effective thermal conductivity of the board are determined to be

$$(kt)_{\text{copper}} = (386 \text{ W/m}\cdot^\circ\text{C})(0.0001 \text{ m}) = 0.0386 \text{ W}/^\circ\text{C}$$

$$(kt)_{\text{epoxy}} = (0.26 \text{ W/m}\cdot^\circ\text{C})(0.0012 \text{ m}) = 0.000312 \text{ W}/^\circ\text{C}$$

$$(kt)_{\text{total}} = (kt)_{\text{copper}} + (kt)_{\text{epoxy}} = 0.0386 + 0.000312 = 0.038912 \text{ W}/^\circ\text{C}$$

$$f_{\text{epoxy}} = \frac{(kt)_{\text{epoxy}}}{(kt)_{\text{total}}} = \frac{0.000312}{0.038912} = 0.008 = \mathbf{0.8\%}$$

$$f_{\text{copper}} = \frac{(kt)_{\text{copper}}}{(kt)_{\text{total}}} = \frac{0.0386}{0.038912} = 0.992 = \mathbf{99.2\%}$$

and

$$k_{\text{eff}} = \frac{(386 \times 0.0001 + 0.26 \times 0.0012) \text{ W}/^\circ\text{C}}{(0.0001 + 0.0012) \text{ m}} = \mathbf{29.9 \text{ W/m}\cdot^\circ\text{C}}$$

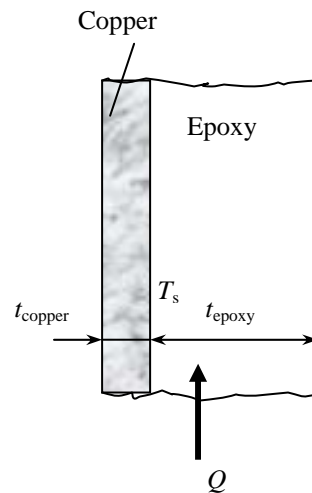

3-39E A thin copper plate is sandwiched between two layers of epoxy boards. The effective thermal conductivity of the board along its 9 in long side and the fraction of the heat conducted through copper along that side are to be determined.

Assumptions 1 Steady operating conditions exist. 2 Heat transfer is one-dimensional since heat transfer from the side surfaces are disregarded 3 Thermal conductivities are constant.

Properties The thermal conductivities are given to be $k = 223 \text{ Btu/h}\cdot\text{ft}\cdot^\circ\text{F}$ for copper and $0.15 \text{ Btu/h}\cdot\text{ft}\cdot^\circ\text{F}$ for epoxy layers.

Analysis We take the length in the direction of heat transfer to be L and the width of the board to be w . Then heat conduction along this two-layer plate can be expressed as (we treat the two layers of epoxy as a single layer that is twice as thick)

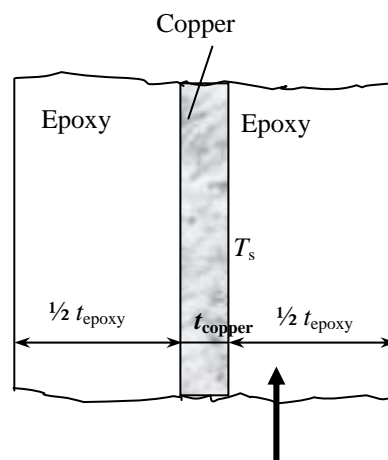

$$\begin{aligned}\dot{Q} &= \dot{Q}_{\text{copper}} + \dot{Q}_{\text{epoxy}} \\ &= \left(kA \frac{\Delta T}{L} \right)_{\text{copper}} + \left(kA \frac{\Delta T}{L} \right)_{\text{epoxy}} = \left[(kt)_{\text{copper}} + (kt)_{\text{epoxy}} \right] w \frac{\Delta T}{L}\end{aligned}$$

Heat conduction along an “equivalent” plate of thick ness $t = t_{\text{copper}} + t_{\text{epoxy}}$ and thermal conductivity k_{eff} can be expressed as

$$\dot{Q} = \left(kA \frac{\Delta T}{L} \right)_{\text{board}} = k_{\text{eff}} (t_{\text{copper}} + t_{\text{epoxy}}) w \frac{\Delta T}{L}$$

Setting the two relations above equal to each other and solving for the effective conductivity gives

$$k_{\text{eff}} (t_{\text{copper}} + t_{\text{epoxy}}) = (kt)_{\text{copper}} + (kt)_{\text{epoxy}} \longrightarrow k_{\text{eff}} = \frac{(kt)_{\text{copper}} + (kt)_{\text{epoxy}}}{t_{\text{copper}} + t_{\text{epoxy}}}$$

Note that heat conduction is proportional to kt . Substituting, the fraction of heat conducted along the copper layer and the effective thermal conductivity of the plate are determined to be

$$(kt)_{\text{copper}} = (223 \text{ Btu/h}\cdot\text{ft}\cdot^\circ\text{F})(0.03/12 \text{ ft}) = 0.5575 \text{ Btu/h}\cdot^\circ\text{F}$$

$$(kt)_{\text{epoxy}} = 2(0.15 \text{ Btu/h}\cdot\text{ft}\cdot^\circ\text{F})(0.15/12 \text{ ft}) = 0.00375 \text{ Btu/h}\cdot^\circ\text{F}$$

$$(kt)_{\text{total}} = (kt)_{\text{copper}} + (kt)_{\text{epoxy}} = (0.5575 + 0.00375) = 0.56125 \text{ Btu/h}\cdot^\circ\text{F}$$

and

$$\begin{aligned}k_{\text{eff}} &= \frac{(kt)_{\text{copper}} + (kt)_{\text{epoxy}}}{t_{\text{copper}} + t_{\text{epoxy}}} \\ &= \frac{0.56125 \text{ Btu/h}\cdot^\circ\text{F}}{[(0.03/12) + 2(0.15/12)] \text{ ft}} = \mathbf{20.4 \text{ Btu/h}\cdot\text{ft}^2\cdot^\circ\text{F}}\end{aligned}$$

$$f_{\text{copper}} = \frac{(kt)_{\text{copper}}}{(kt)_{\text{total}}} = \frac{0.5575}{0.56125} = 0.993 = \mathbf{99.3\%}$$

Thermal Contact Resistance

3-40C The resistance that an interface offers to heat transfer per unit interface area is called thermal contact resistance, R_c . The inverse of thermal contact resistance is called the thermal contact conductance.

3-41C The thermal contact resistance will be greater for rough surfaces because an interface with rough surfaces will contain more air gaps whose thermal conductivity is low.

3-42C An interface acts like a very thin layer of insulation, and thus the thermal contact resistance has significance only for highly conducting materials like metals. Therefore, the thermal contact resistance can be ignored for two layers of insulation pressed against each other.

3-43C An interface acts like a very thin layer of insulation, and thus the thermal contact resistance is significant for highly conducting materials like metals. Therefore, the thermal contact resistance must be considered for two layers of metals pressed against each other.

3-44C Heat transfer through the voids at an interface is by conduction and radiation. Evacuating the interface eliminates heat transfer by conduction, and thus increases the thermal contact resistance.

3-45C Thermal contact resistance can be minimized by (1) applying a thermally conducting liquid on the surfaces before they are pressed against each other, (2) by replacing the air at the interface by a better conducting gas such as helium or hydrogen, (3) by increasing the interface pressure, and (4) by inserting a soft metallic foil such as tin, silver, copper, nickel, or aluminum between the two surfaces.

3-46 The thickness of copper plate whose thermal resistance is equal to the thermal contact resistance is to be determined.

Properties The thermal conductivity of copper is $k = 386 \text{ W/m}\cdot\text{°C}$.

Analysis Noting that thermal contact resistance is the inverse of thermal contact conductance, the thermal contact resistance is determined to be

$$R_c = \frac{1}{h_c} = \frac{1}{18,000 \text{ W/m}^2\cdot\text{°C}} = 5.556 \times 10^{-5} \text{ m}^2\cdot\text{°C/W}$$

For a unit surface area, the thermal resistance of a flat plate is defined as $R = \frac{L}{k}$ where L is the thickness of the plate and k is the thermal conductivity. Setting $R = R_c$, the equivalent thickness is determined from the relation above to be

$$L = kR = kR_c = (386 \text{ W/m}\cdot\text{°C})(5.556 \times 10^{-5} \text{ m}^2\cdot\text{°C/W}) = 0.0214 \text{ m} = \mathbf{2.14 \text{ cm}}$$

Therefore, the interface between the two plates offers as much resistance to heat transfer as a 2.14 cm thick copper. Note that the thermal contact resistance in this case is greater than the sum of the thermal resistances of both plates.

3-47 Six identical power transistors are attached on a copper plate. For a maximum case temperature of 75°C, the maximum power dissipation and the temperature jump at the interface are to be determined.

Assumptions **1** Steady operating conditions exist. **2** Heat transfer can be approximated as being one-dimensional, although it is recognized that heat conduction in some parts of the plate will be two-dimensional since the plate area is much larger than the base area of the transistor. But the large thermal conductivity of copper will minimize this effect. **3** All the heat generated at the junction is dissipated through the back surface of the plate since the transistors are covered by a thick plexiglass layer. **4** Thermal conductivities are constant.

Properties The thermal conductivity of copper is given to be $k = 386 \text{ W/m}\cdot\text{°C}$. The contact conductance at the interface of copper-aluminum plates for the case of 1.17-1.4 μm roughness and 10 MPa pressure is $h_c = 49,000 \text{ W/m}^2\cdot\text{°C}$ (Table 3-2).

Analysis The contact area between the case and the plate is given to be 9 cm^2 , and the plate area for each transistor is 100 cm^2 . The thermal resistance network of this problem consists of three resistances in series (contact, plate, and convection) which are determined to be

$$R_{\text{contact}} = \frac{1}{h_c A_c} = \frac{1}{(49,000 \text{ W/m}^2 \cdot \text{°C})(9 \times 10^{-4} \text{ m}^2)} = 0.0227 \text{ °C/W}$$

$$R_{\text{plate}} = \frac{L}{kA} = \frac{0.012 \text{ m}}{(386 \text{ W/m}\cdot\text{°C})(0.01 \text{ m}^2)} = 0.0031 \text{ °C/W}$$

$$R_{\text{convection}} = \frac{1}{h_o A} = \frac{1}{(30 \text{ W/m}^2 \cdot \text{°C})(0.01 \text{ m}^2)} = 3.333 \text{ °C/W}$$

The total thermal resistance is then

$$\begin{aligned} R_{\text{total}} &= R_{\text{contact}} + R_{\text{plate}} + R_{\text{convection}} \\ &= 0.0227 + 0.0031 + 3.333 = 3.359 \text{ °C/W} \end{aligned}$$

Note that the thermal resistance of copper plate is very small and can be ignored all together. Then the rate of heat transfer is determined to be

$$\dot{Q} = \frac{\Delta T}{R_{\text{total}}} = \frac{(75 - 23) \text{ °C}}{3.359 \text{ °C/W}} = \mathbf{15.5 \text{ W}}$$

Therefore, the power transistor should not be operated at power levels greater than 15.5 W if the case temperature is not to exceed 75°C.

The temperature jump at the interface is determined from

$$\Delta T_{\text{interface}} = \dot{Q} R_{\text{contact}} = (15.5 \text{ W})(0.0227 \text{ °C/W}) = \mathbf{0.35 \text{ °C}}$$

which is not very large. Therefore, even if we eliminate the thermal contact resistance at the interface completely, we will lower the operating temperature of the transistor in this case by less than 1°C.

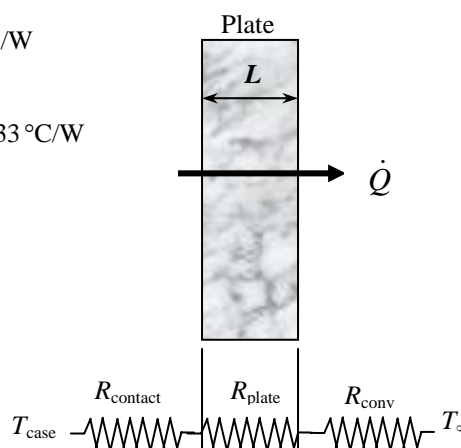

3-48 Two cylindrical aluminum bars with ground surfaces are pressed against each other in an insulation sleeve. For specified top and bottom surface temperatures, the rate of heat transfer along the cylinders and the temperature drop at the interface are to be determined.

Assumptions **1** Steady operating conditions exist. **2** Heat transfer is one-dimensional in the axial direction since the lateral surfaces of both cylinders are well-insulated. **3** Thermal conductivities are constant.

Properties The thermal conductivity of aluminum bars is given to be $k = 176 \text{ W/m}\cdot\text{°C}$. The contact conductance at the interface of aluminum-aluminum plates for the case of ground surfaces and of $20 \text{ atm} \approx 2 \text{ MPa}$ pressure is $h_c = 11,400 \text{ W/m}^2\cdot\text{°C}$ (Table 3-2).

Analysis (a) The thermal resistance network in this case consists of two conduction resistance and the contact resistance, and they are determined to be

$$R_{\text{contact}} = \frac{1}{h_c A_c} = \frac{1}{(11,400 \text{ W/m}^2\cdot\text{°C})[\pi(0.05 \text{ m})^2/4]} = 0.0447 \text{ °C/W}$$

$$R_{\text{plate}} = \frac{L}{kA} = \frac{0.15 \text{ m}}{(176 \text{ W/m}\cdot\text{°C})[\pi(0.05 \text{ m})^2/4]} = 0.4341 \text{ °C/W}$$

Then the rate of heat transfer is determined to be

$$\dot{Q} = \frac{\Delta T}{R_{\text{total}}} = \frac{\Delta T}{R_{\text{contact}} + 2R_{\text{bar}}} = \frac{(150 - 20)\text{°C}}{(0.0447 + 2 \times 0.4341) \text{ °C/W}} = \mathbf{142.4 \text{ W}}$$

Therefore, the rate of heat transfer through the bars is 142.4 W.

(b) The temperature drop at the interface is determined to be

$$\Delta T_{\text{interface}} = \dot{Q} R_{\text{contact}} = (142.4 \text{ W})(0.0447 \text{ °C/W}) = \mathbf{6.4\text{°C}}$$

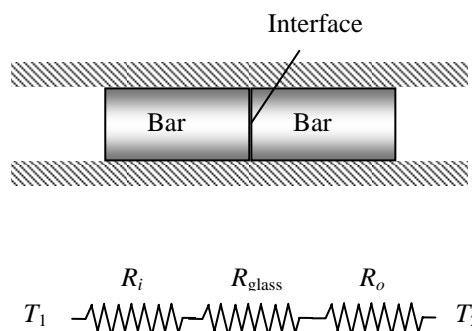

3-49 A thin copper plate is sandwiched between two epoxy boards. The error involved in the total thermal resistance of the plate if the thermal contact conductances are ignored is to be determined.

Assumptions **1** Steady operating conditions exist. **2** Heat transfer is one-dimensional since the plate is large. **3** Thermal conductivities are constant.

Properties The thermal conductivities are given to be $k = 386 \text{ W/m}\cdot\text{°C}$ for copper plates and $k = 0.26 \text{ W/m}\cdot\text{°C}$ for epoxy boards. The contact conductance at the interface of copper-epoxy layers is given to be $h_c = 6000 \text{ W/m}^2\cdot\text{°C}$.

Analysis The thermal resistances of different layers for unit surface area of 1 m^2 are

$$R_{\text{contact}} = \frac{1}{h_c A_c} = \frac{1}{(6000 \text{ W/m}^2 \cdot \text{°C})(1 \text{ m}^2)} = 0.00017 \text{ °C/W}$$

$$R_{\text{plate}} = \frac{L}{kA} = \frac{0.001 \text{ m}}{(386 \text{ W/m}\cdot\text{°C})(1 \text{ m}^2)} = 2.6 \times 10^{-6} \text{ °C/W}$$

$$R_{\text{epoxy}} = \frac{L}{kA} = \frac{0.005 \text{ m}}{(0.26 \text{ W/m}\cdot\text{°C})(1 \text{ m}^2)} = 0.01923 \text{ °C/W}$$

The total thermal resistance is

$$\begin{aligned} R_{\text{total}} &= 2R_{\text{contact}} + R_{\text{plate}} + 2R_{\text{epoxy}} \\ &= 2 \times 0.00017 + 2.6 \times 10^{-6} + 2 \times 0.01923 = 0.03880 \text{ °C/W} \end{aligned}$$

Then the percent error involved in the total thermal resistance of the plate if the thermal contact resistances are ignored is determined to be

$$\% \text{ Error} = \frac{2R_{\text{contact}}}{R_{\text{total}}} \times 100 = \frac{2 \times 0.00017}{0.03880} \times 100 = \mathbf{0.88\%}$$

which is negligible.

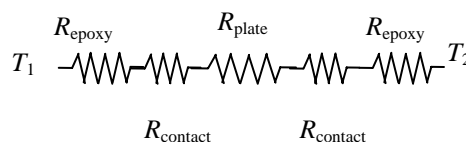
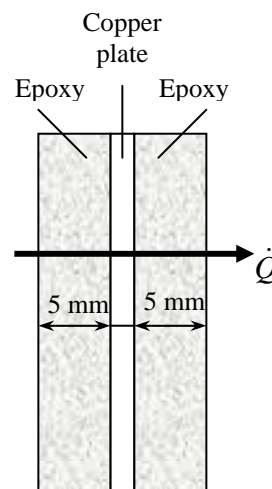

Generalized Thermal Resistance Networks

3-50C Parallel resistances indicate simultaneous heat transfer (such as convection and radiation on a surface). Series resistances indicate sequential heat transfer (such as two homogeneous layers of a wall).

3-51C The thermal resistance network approach will give adequate results for multi-dimensional heat transfer problems if heat transfer occurs predominantly in one direction.

3-52C Two approaches used in development of the thermal resistance network in the x-direction for multi-dimensional problems are (1) to assume any plane wall normal to the x-axis to be isothermal and (2) to assume any plane parallel to the x-axis to be adiabatic.

3-53 A typical section of a building wall is considered. The average heat flux through the wall is to be determined.

Assumptions 1 Steady operating conditions exist.

Properties The thermal conductivities are given to be $k_{23b} = 50$ W/m·K, $k_{23a} = 0.03$ W/m·K, $k_{12} = 0.5$ W/m·K, $k_{34} = 1.0$ W/m·K.

Analysis We consider 1 m² of wall area. The thermal resistances are

$$R_{12} = \frac{t_{12}}{k_{12}} = \frac{0.01 \text{ m}}{(0.5 \text{ W/m} \cdot \text{°C})} = 0.02 \text{ m}^2 \cdot \text{°C/W}$$

$$\begin{aligned} R_{23a} &= t_{23} \frac{L_a}{k_{23a}(L_a + L_b)} \\ &= (0.08 \text{ m}) \frac{0.6 \text{ m}}{(0.03 \text{ W/m} \cdot \text{°C})(0.6 + 0.005)} = 2.645 \text{ m}^2 \cdot \text{°C/W} \end{aligned}$$

$$\begin{aligned} R_{23b} &= t_{23} \frac{L_b}{k_{23b}(L_a + L_b)} \\ &= (0.08 \text{ m}) \frac{0.005 \text{ m}}{(50 \text{ W/m} \cdot \text{°C})(0.6 + 0.005)} = 1.32 \times 10^{-5} \text{ m}^2 \cdot \text{°C/W} \end{aligned}$$

$$R_{34} = \frac{t_{34}}{k_{34}} = \frac{0.1 \text{ m}}{(1.0 \text{ W/m} \cdot \text{°C})} = 0.1 \text{ m}^2 \cdot \text{°C/W}$$

The total thermal resistance and the rate of heat transfer are

$$\begin{aligned} R_{\text{total}} &= R_{12} + \left(\frac{R_{23a} R_{23b}}{R_{23a} + R_{23b}} \right) + R_{34} \\ &= 0.02 + 2.645 \left(\frac{1.32 \times 10^{-5}}{2.645 + 1.32 \times 10^{-5}} \right) + 0.1 = 0.120 \text{ m}^2 \cdot \text{°C/W} \end{aligned}$$

$$\dot{q} = \frac{T_4 - T_1}{R_{\text{total}}} = \frac{(35 - 20) \text{°C}}{0.120 \text{ m}^2 \cdot \text{°C/W}} = \mathbf{125 \text{ W/m}^2}$$

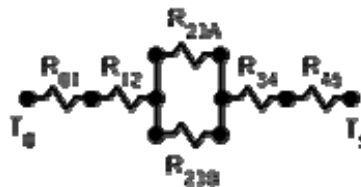
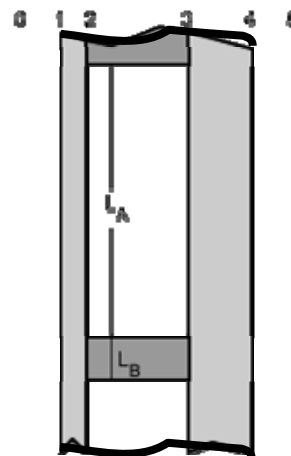

3-54 A wall consists of horizontal bricks separated by plaster layers. There are also plaster layers on each side of the wall, and a rigid foam on the inner side of the wall. The rate of heat transfer through the wall is to be determined.

Assumptions **1** Heat transfer is steady since there is no indication of change with time. **2** Heat transfer through the wall is one-dimensional. **3** Thermal conductivities are constant. **4** Heat transfer by radiation is disregarded.

Properties The thermal conductivities are given to be $k = 0.72 \text{ W/m}\cdot\text{C}$ for bricks, $k = 0.22 \text{ W/m}\cdot\text{C}$ for plaster layers, and $k = 0.026 \text{ W/m}\cdot\text{C}$ for the rigid foam.

Analysis We consider 1 m deep and 0.33 m high portion of wall which is representative of the entire wall. The thermal resistance network and individual resistances are

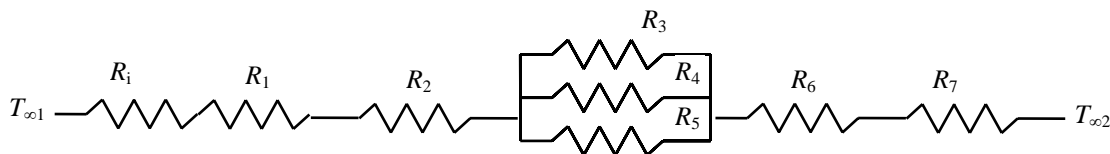

$$R_i = R_{conv,1} = \frac{1}{h_1 A} = \frac{1}{(10 \text{ W/m}^2 \cdot \text{C})(0.33 \times 1 \text{ m}^2)} = 0.303 \text{ C/W}$$

$$R_1 = R_{foam} = \frac{L}{kA} = \frac{0.02 \text{ m}}{(0.026 \text{ W/m}\cdot\text{C})(0.33 \times 1 \text{ m}^2)} = 2.33 \text{ C/W}$$

$$R_2 = R_6 = R_{plaster\ side} = \frac{L}{kA} = \frac{0.02 \text{ m}}{(0.22 \text{ W/m}\cdot\text{C})(0.33 \times 1 \text{ m}^2)} = 0.275 \text{ C/W}$$

$$R_3 = R_5 = R_{plaster\ center} = \frac{L}{h_o A} = \frac{0.18 \text{ m}}{(0.22 \text{ W/m}\cdot\text{C})(0.015 \times 1 \text{ m}^2)} = 54.55 \text{ C/W}$$

$$R_4 = R_{brick} = \frac{L}{kA} = \frac{0.18 \text{ m}}{(0.72 \text{ W/m}\cdot\text{C})(0.30 \times 1 \text{ m}^2)} = 0.833 \text{ C/W}$$

$$R_o = R_{conv,2} = \frac{1}{h_2 A} = \frac{1}{(20 \text{ W/m}\cdot\text{C})(0.33 \times 1 \text{ m}^2)} = 0.152 \text{ C/W}$$

$$\frac{1}{R_{mid}} = \frac{1}{R_3} + \frac{1}{R_4} + \frac{1}{R_5} = \frac{1}{54.55} + \frac{1}{0.833} + \frac{1}{54.55} \longrightarrow R_{mid} = 0.81 \text{ C/W}$$

$$R_{total} = R_i + R_1 + 2R_2 + R_{mid} + R_o = 0.303 + 2.33 + 2(0.275) + 0.81 + 0.152 = 4.145 \text{ C/W}$$

The steady rate of heat transfer through the wall per 0.33 m^2 is

$$\dot{Q} = \frac{T_{\infty 1} - T_{\infty 2}}{R_{total}} = \frac{[(22 - (-4))\text{C}]}{4.145 \text{ C/W}} = 6.27 \text{ W}$$

Then steady rate of heat transfer through the entire wall becomes

$$\dot{Q}_{total} = (6.27 \text{ W}) \frac{(4 \times 6) \text{ m}^2}{0.33 \text{ m}^2} = \mathbf{456 \text{ W}}$$

3-55 EES Prob. 3-54 is reconsidered. The rate of heat transfer through the wall as a function of the thickness of the rigid foam is to be plotted.

Analysis The problem is solved using EES, and the solution is given below.

"GIVEN"

A=4*6 [m^2]
 L_brick=0.18 [m]
 L_plaster_center=0.18 [m]
 L_plaster_side=0.02 [m]
 L_foam=2 [cm]
 k_brick=0.72 [W/m-C]
 k_plaster=0.22 [W/m-C]
 k_foam=0.026 [W/m-C]
 T_infinity_1=22 [C]
 T_infinity_2=-4 [C]
 h_1=10 [W/m^2-C]
 h_2=20 [W/m^2-C]

"ANALYSIS"

R_conv_1=1/(h_1*A_1)
 A_1=0.33*1 "[m^2]"
 R_foam=(L_foam*Convert(cm, m))/(k_foam*A_1) "L_foam is in cm"
 R_plaster_side=L_plaster_side/(k_plaster*A_1)
 A_2=0.30*1 "[m^2]"
 R_plaster_center=L_plaster_center/(k_plaster*A_3)
 A_3=0.015*1 "[m^2]"
 R_brick=L_brick/(k_brick*A_2)
 R_conv_2=1/(h_2*A_1)
 1/R_mid=2*1/R_plaster_center+1/R_brick
 R_total=R_conv_1+R_foam+2*R_plaster_side+R_mid+R_conv_2
 Q_dot=(T_infinity_1-T_infinity_2)/R_total
 Q_dot_total=Q_dot*A/A_1

L _{foam} [cm]	Q _{total} [W]
1	634.6
2	456.2
3	356.1
4	292
5	247.4
6	214.7
7	189.6
8	169.8
9	153.7
10	140.4

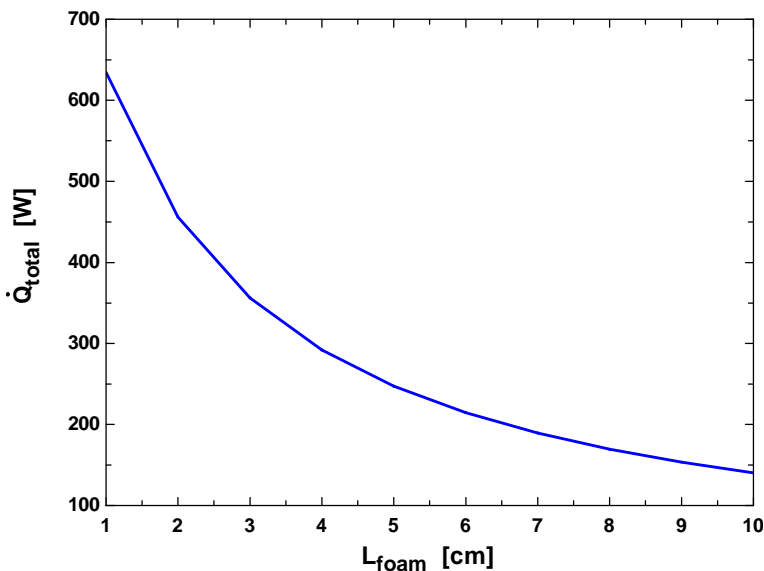

3-56 A wall is to be constructed of 10-cm thick wood studs or with pairs of 5-cm thick wood studs nailed to each other. The rate of heat transfer through the solid stud and through a stud pair nailed to each other, as well as the effective conductivity of the nailed stud pair are to be determined.

Assumptions **1** Heat transfer is steady since there is no indication of change with time. **2** Heat transfer can be approximated as being one-dimensional since it is predominantly in the x direction. **3** Thermal conductivities are constant. **4** The thermal contact resistance between the two layers is negligible. **4** Heat transfer by radiation is disregarded.

Properties The thermal conductivities are given to be $k = 0.11 \text{ W/m}\cdot\text{C}$ for wood studs and $k = 50 \text{ W/m}\cdot\text{C}$ for manganese steel nails.

Analysis (a) The heat transfer area of the stud is $A = (0.1 \text{ m})(2.5 \text{ m}) = 0.25 \text{ m}^2$. The thermal resistance and heat transfer rate through the solid stud are

$$R_{stud} = \frac{L}{kA} = \frac{0.1 \text{ m}}{(0.11 \text{ W/m}\cdot\text{C})(0.25 \text{ m}^2)} = 3.636 \text{ }^\circ\text{C/W}$$

$$\dot{Q} = \frac{\Delta T}{R_{stud}} = \frac{8 \text{ }^\circ\text{C}}{3.636 \text{ }^\circ\text{C/W}} = \mathbf{2.2 \text{ W}}$$

(b) The thermal resistances of stud pair and nails are in parallel

$$A_{nails} = 50 \frac{\pi D^2}{4} = 50 \left[\frac{\pi (0.004 \text{ m})^2}{4} \right] = 0.000628 \text{ m}^2$$

$$R_{nails} = \frac{L}{kA} = \frac{0.1 \text{ m}}{(50 \text{ W/m}\cdot\text{C})(0.000628 \text{ m}^2)} = 3.18 \text{ }^\circ\text{C/W}$$

$$R_{stud} = \frac{L}{kA} = \frac{0.1 \text{ m}}{(0.11 \text{ W/m}\cdot\text{C})(0.25 - 0.000628 \text{ m}^2)} = 3.65 \text{ }^\circ\text{C/W}$$

$$\frac{1}{R_{total}} = \frac{1}{R_{stud}} + \frac{1}{R_{nails}} = \frac{1}{3.65} + \frac{1}{3.18} \longrightarrow R_{total} = 1.70 \text{ }^\circ\text{C/W}$$

$$\dot{Q} = \frac{\Delta T}{R_{total}} = \frac{8 \text{ }^\circ\text{C}}{1.70 \text{ }^\circ\text{C/W}} = \mathbf{4.7 \text{ W}}$$

(c) The effective conductivity of the nailed stud pair can be determined from

$$\dot{Q} = k_{eff} A \frac{\Delta T}{L} \longrightarrow k_{eff} = \frac{\dot{Q}L}{\Delta TA} = \frac{(4.7 \text{ W})(0.1 \text{ m})}{(8 \text{ }^\circ\text{C})(0.25 \text{ m}^2)} = \mathbf{0.235 \text{ W/m}\cdot\text{C}}$$

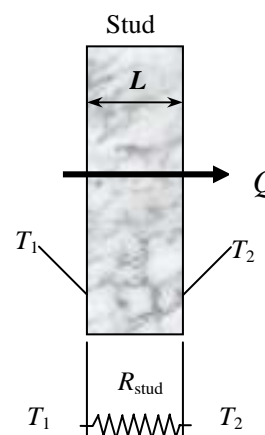

3-57 A wall is constructed of two layers of sheetrock spaced by 5 cm × 12 cm wood studs. The space between the studs is filled with fiberglass insulation. The thermal resistance of the wall and the rate of heat transfer through the wall are to be determined.

Assumptions **1** Heat transfer is steady since there is no indication of change with time. **2** Heat transfer through the wall is one-dimensional. **3** Thermal conductivities are constant. **4** Heat transfer coefficients account for the radiation heat transfer.

Properties The thermal conductivities are given to be $k = 0.17 \text{ W/m}\cdot\text{°C}$ for sheetrock, $k = 0.11 \text{ W/m}\cdot\text{°C}$ for wood studs, and $k = 0.034 \text{ W/m}\cdot\text{°C}$ for fiberglass insulation.

Analysis (a) The representative surface area is $A = 1 \times 0.65 = 0.65 \text{ m}^2$. The thermal resistance network and the individual thermal resistances are

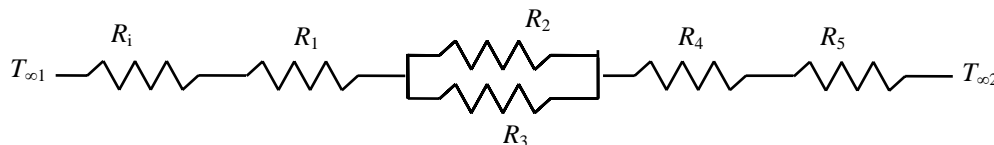

$$R_i = \frac{1}{h_i A} = \frac{1}{(8.3 \text{ W/m}^2 \cdot \text{°C})(0.65 \text{ m}^2)} = 0.185 \text{ °C/W}$$

$$R_1 = R_4 = R_{\text{sheetrock}} = \frac{L}{kA} = \frac{0.01 \text{ m}}{(0.17 \text{ W/m}\cdot\text{°C})(0.65 \text{ m}^2)} = 0.090 \text{ °C/W}$$

$$R_2 = R_{\text{stud}} = \frac{L}{kA} = \frac{0.16 \text{ m}}{(0.11 \text{ W/m}\cdot\text{°C})(0.05 \text{ m}^2)} = 29.091 \text{ °C/W}$$

$$R_3 = R_{\text{fiberglass}} = \frac{L}{kA} = \frac{0.16 \text{ m}}{(0.034 \text{ W/m}\cdot\text{°C})(0.60 \text{ m}^2)} = 7.843 \text{ °C/W}$$

$$R_o = \frac{1}{h_o A} = \frac{1}{(34 \text{ W/m}^2 \cdot \text{°C})(0.65 \text{ m}^2)} = 0.045 \text{ °C/W}$$

$$\frac{1}{R_{\text{mid}}} = \frac{1}{R_2} + \frac{1}{R_3} = \frac{1}{29.091} + \frac{1}{7.843} \longrightarrow R_{\text{mid}} = 6.178 \text{ °C/W}$$

$$R_{\text{total}} = R_i + R_1 + R_{\text{mid}} + R_4 + R_o \\ = 0.185 + 0.090 + 6.178 + 0.090 + 0.045 = \mathbf{6.588 \text{ °C/W}} \text{ (for a } 1 \text{ m} \times 0.65 \text{ m section)}$$

$$\dot{Q} = \frac{T_{\infty 1} - T_{\infty 2}}{R_{\text{total}}} = \frac{[20 - (-9)] \text{ °C}}{6.588 \text{ °C/W}} = 4.40 \text{ W}$$

(b) Then steady rate of heat transfer through entire wall becomes

$$\dot{Q}_{\text{total}} = (4.40 \text{ W}) \frac{(12 \text{ m})(5 \text{ m})}{0.65 \text{ m}^2} = \mathbf{406 \text{ W}}$$

3-58E A wall is to be constructed using solid bricks or identical size bricks with 9 square air holes. There is a 0.5 in thick sheetrock layer between two adjacent bricks on all four sides, and on both sides of the wall. The rates of heat transfer through the wall constructed of solid bricks and of bricks with air holes are to be determined.

Assumptions **1** Heat transfer is steady since there is no indication of change with time. **2** Heat transfer through the wall is one-dimensional. **3** Thermal conductivities are constant. **4** Heat transfer coefficients account for the radiation heat transfer.

Properties The thermal conductivities are given to be $k = 0.40$ Btu/h·ft·°F for bricks, $k = 0.015$ Btu/h·ft·°F for air, and $k = 0.10$ Btu/h·ft·°F for sheetrock.

Analysis (a) The representative surface area is $A = (7.5/12)(7.5/12) = 0.3906$ ft². The thermal resistance network and the individual thermal resistances if the wall is constructed of solid bricks are

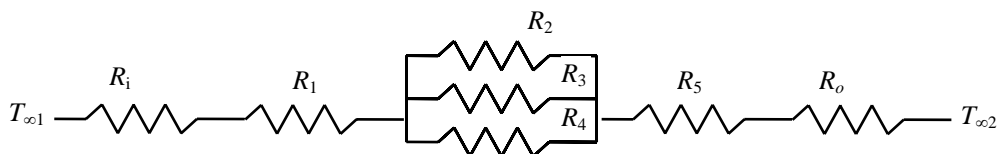

$$R_i = \frac{1}{h_i A} = \frac{1}{(1.5 \text{ Btu/h} \cdot \text{ft}^2 \cdot ^\circ\text{F})(0.3906 \text{ ft}^2)} = 1.7068 \text{ h} \cdot ^\circ\text{F/Btu}$$

$$R_1 = R_5 = R_{\text{plaster}} = \frac{L}{kA} = \frac{0.5/12 \text{ ft}}{(0.10 \text{ Btu/h} \cdot \text{ft} \cdot ^\circ\text{F})(0.3906 \text{ ft}^2)} = 1.0667 \text{ h} \cdot ^\circ\text{F/Btu}$$

$$R_2 = R_{\text{plaster}} = \frac{L}{kA} = \frac{9/12 \text{ ft}}{(0.10 \text{ Btu/h} \cdot \text{ft} \cdot ^\circ\text{F})[(7.5/12) \times (0.5/12)] \text{ ft}^2} = 288 \text{ h} \cdot ^\circ\text{F/Btu}$$

$$R_3 = R_{\text{plaster}} = \frac{L}{kA} = \frac{9/12 \text{ ft}}{(0.10 \text{ Btu/h} \cdot \text{ft} \cdot ^\circ\text{F})[(7/12) \times (0.5/12)] \text{ ft}^2} = 308.57 \text{ h} \cdot ^\circ\text{F/Btu}$$

$$R_4 = R_{\text{brick}} = \frac{L}{kA} = \frac{9/12 \text{ ft}}{(0.40 \text{ Btu/h} \cdot \text{ft} \cdot ^\circ\text{F})[(7/12) \times (7/12)] \text{ ft}^2} = 5.51 \text{ h} \cdot ^\circ\text{F/Btu}$$

$$R_o = \frac{1}{h_o A} = \frac{1}{(4 \text{ Btu/h} \cdot \text{ft}^2 \cdot ^\circ\text{F})(0.3906 \text{ ft}^2)} = 0.64 \text{ h} \cdot ^\circ\text{F/Btu}$$

$$\frac{1}{R_{\text{mid}}} = \frac{1}{R_2} + \frac{1}{R_3} + \frac{1}{R_4} = \frac{1}{288} + \frac{1}{308.57} + \frac{1}{5.51} \longrightarrow R_{\text{mid}} = 5.3135 \text{ h} \cdot ^\circ\text{F/Btu}$$

$$R_{\text{total}} = R_i + R_1 + R_{\text{mid}} + R_5 + R_o = 1.7068 + 1.0667 + 5.3135 + 1.0667 + 0.64 = 9.7937 \text{ h} \cdot ^\circ\text{F/Btu}$$

$$\dot{Q} = \frac{T_{\infty 1} - T_{\infty 2}}{R_{\text{total}}} = \frac{(80 - 30)^\circ\text{F}}{9.7937 \text{ h} \cdot ^\circ\text{F/Btu}} = 5.1053 \text{ Btu/h}$$

Then steady rate of heat transfer through entire wall becomes

$$\dot{Q}_{\text{total}} = (5.1053 \text{ Btu/h}) \frac{(30 \text{ ft})(10 \text{ ft})}{0.3906 \text{ m}^2} = \mathbf{3921 \text{ Btu/h}}$$

(b) The thermal resistance network and the individual thermal resistances if the wall is constructed of bricks with air holes are

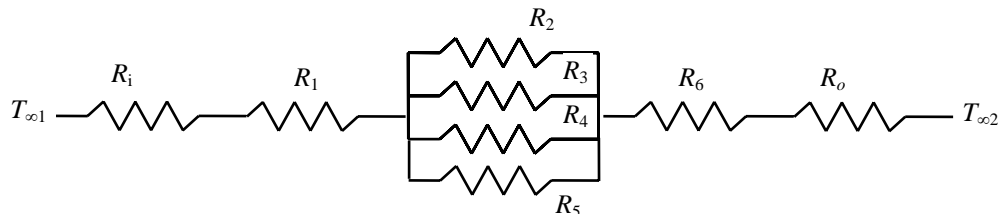

$$A_{\text{airholes}} = 9(1.5/12) \times (1.55/12) = 0.1406 \text{ ft}^2$$

$$A_{\text{bricks}} = (7/12 \text{ ft})^2 - 0.1406 = 0.1997 \text{ ft}^2$$

$$R_4 = R_{\text{airholes}} = \frac{L}{kA} = \frac{9/12 \text{ ft}}{(0.015 \text{ Btu/h} \cdot \text{ft} \cdot ^\circ\text{F})(0.1406 \text{ ft}^2)} = 355.62 \text{ h} \cdot ^\circ\text{F/Btu}$$

$$R_5 = R_{\text{brick}} = \frac{L}{kA} = \frac{9/12 \text{ ft}}{(0.40 \text{ Btu/h} \cdot \text{ft} \cdot ^\circ\text{F})(0.1997 \text{ ft}^2)} = 9.389 \text{ h} \cdot ^\circ\text{F/Btu}$$

$$\frac{1}{R_{\text{mid}}} = \frac{1}{R_2} + \frac{1}{R_3} + \frac{1}{R_4} + \frac{1}{R_5} = \frac{1}{288} + \frac{1}{308.57} + \frac{1}{355.62} + \frac{1}{9.389} \longrightarrow R_{\text{mid}} = 8.618 \text{ h} \cdot ^\circ\text{F/Btu}$$

$$R_{\text{total}} = R_i + R_1 + R_{\text{mid}} + R_6 + R_o = 1.7068 + 1.0667 + 8.618 + 1.0677 + 0.64 = 13.0992 \text{ h} \cdot ^\circ\text{F/Btu}$$

$$\dot{Q} = \frac{T_{\infty 1} - T_{\infty 2}}{R_{\text{total}}} = \frac{(80 - 30)^\circ\text{F}}{13.0992 \text{ h} \cdot ^\circ\text{F/Btu}} = 3.817 \text{ Btu/h}$$

Then steady rate of heat transfer through entire wall becomes

$$\dot{Q}_{\text{total}} = (3.817 \text{ Btu/h}) \frac{(30 \text{ ft})(10 \text{ ft})}{0.3906 \text{ ft}^2} = \mathbf{2932 \text{ Btu/h}}$$

3-59 A composite wall consists of several horizontal and vertical layers. The left and right surfaces of the wall are maintained at uniform temperatures. The rate of heat transfer through the wall, the interface temperatures, and the temperature drop across the section F are to be determined.

Assumptions 1 Heat transfer is steady since there is no indication of change with time. **2** Heat transfer through the wall is one-dimensional. **3** Thermal conductivities are constant. **4** Thermal contact resistances at the interfaces are disregarded.

Properties The thermal conductivities are given to be $k_A = k_F = 2$, $k_B = 8$, $k_C = 20$, $k_D = 15$, $k_E = 35$ W/m·°C.

Analysis (a) The representative surface area is $A = 0.12 \times 1 = 0.12$ m². The thermal resistance network and the individual thermal resistances are

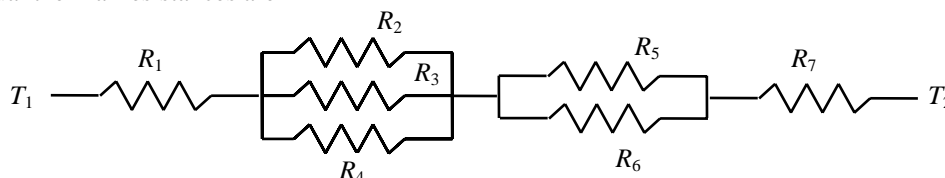

$$R_1 = R_A = \left(\frac{L}{kA} \right)_A = \frac{0.01 \text{ m}}{(2 \text{ W/m} \cdot \text{°C})(0.12 \text{ m}^2)} = 0.04 \text{ °C/W}$$

$$R_2 = R_4 = R_C = \left(\frac{L}{kA} \right)_C = \frac{0.05 \text{ m}}{(20 \text{ W/m} \cdot \text{°C})(0.04 \text{ m}^2)} = 0.06 \text{ °C/W}$$

$$R_3 = R_B = \left(\frac{L}{kA} \right)_B = \frac{0.05 \text{ m}}{(8 \text{ W/m} \cdot \text{°C})(0.04 \text{ m}^2)} = 0.16 \text{ °C/W}$$

$$R_5 = R_D = \left(\frac{L}{kA} \right)_D = \frac{0.1 \text{ m}}{(15 \text{ W/m} \cdot \text{°C})(0.06 \text{ m}^2)} = 0.11 \text{ °C/W}$$

$$R_6 = R_E = \left(\frac{L}{kA} \right)_E = \frac{0.1 \text{ m}}{(35 \text{ W/m} \cdot \text{°C})(0.06 \text{ m}^2)} = 0.05 \text{ °C/W}$$

$$R_7 = R_F = \left(\frac{L}{kA} \right)_F = \frac{0.06 \text{ m}}{(2 \text{ W/m} \cdot \text{°C})(0.12 \text{ m}^2)} = 0.25 \text{ °C/W}$$

$$\frac{1}{R_{mid,1}} = \frac{1}{R_2} + \frac{1}{R_3} + \frac{1}{R_4} = \frac{1}{0.06} + \frac{1}{0.16} + \frac{1}{0.06} \longrightarrow R_{mid,1} = 0.025 \text{ °C/W}$$

$$\frac{1}{R_{mid,2}} = \frac{1}{R_5} + \frac{1}{R_6} = \frac{1}{0.11} + \frac{1}{0.05} \longrightarrow R_{mid,2} = 0.034 \text{ °C/W}$$

$$R_{total} = R_1 + R_{mid,1} + R_{mid,2} + R_7 = 0.04 + 0.025 + 0.034 + 0.25 = 0.349 \text{ °C/W}$$

$$\dot{Q} = \frac{T_{\infty 1} - T_{\infty 2}}{R_{total}} = \frac{(300 - 100) \text{ °C}}{0.349 \text{ °C/W}} = 572 \text{ W (for a } 0.12 \text{ m} \times 1 \text{ m section)}$$

Then steady rate of heat transfer through entire wall becomes

$$\dot{Q}_{total} = (572 \text{ W}) \frac{(5 \text{ m})(8 \text{ m})}{0.12 \text{ m}^2} = \mathbf{1.91 \times 10^5 \text{ W}}$$

(b) The total thermal resistance between left surface and the point where the sections B, D, and E meet is

$$R_{total} = R_1 + R_{mid,1} = 0.04 + 0.025 = 0.065 \text{ °C/W}$$

Then the temperature at the point where the sections B, D, and E meet becomes

$$\dot{Q} = \frac{T_1 - T}{R_{total}} \longrightarrow T = T_1 - \dot{Q} R_{total} = 300 \text{ °C} - (572 \text{ W})(0.065 \text{ °C/W}) = \mathbf{263 \text{ °C}}$$

(c) The temperature drop across the section F can be determined from

$$\dot{Q} = \frac{\Delta T}{R_F} \rightarrow \Delta T = \dot{Q} R_F = (572 \text{ W})(0.25 \text{ °C/W}) = \mathbf{143 \text{ °C}}$$

3-60 A composite wall consists of several horizontal and vertical layers. The left and right surfaces of the wall are maintained at uniform temperatures. The rate of heat transfer through the wall, the interface temperatures, and the temperature drop across the section F are to be determined.

Assumptions **1** Heat transfer is steady since there is no indication of change with time. **2** Heat transfer through the wall is one-dimensional. **3** Thermal conductivities are constant. **4** Thermal contact resistances at the interfaces are to be considered.

Properties The thermal conductivities of various materials used are given to be $k_A = k_F = 2$, $k_B = 8$, $k_C = 20$, $k_D = 15$, and $k_E = 35$ W/m·°C.

Analysis The representative surface area is $A = 0.12 \times 1 = 0.12$ m²

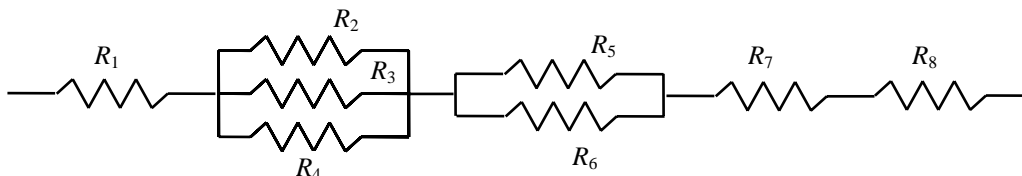

(a) The thermal resistance network and the individual thermal resistances are

$$R_1 = R_A = \left(\frac{L}{kA} \right)_A = \frac{0.01 \text{ m}}{(2 \text{ W/m} \cdot \text{°C})(0.12 \text{ m}^2)} = 0.04 \text{ °C/W}$$

$$R_2 = R_4 = R_C = \left(\frac{L}{kA} \right)_C = \frac{0.05 \text{ m}}{(20 \text{ W/m} \cdot \text{°C})(0.04 \text{ m}^2)} = 0.06 \text{ °C/W}$$

$$R_3 = R_B = \left(\frac{L}{kA} \right)_B = \frac{0.05 \text{ m}}{(8 \text{ W/m} \cdot \text{°C})(0.04 \text{ m}^2)} = 0.16 \text{ °C/W}$$

$$R_5 = R_D = \left(\frac{L}{kA} \right)_D = \frac{0.1 \text{ m}}{(15 \text{ W/m} \cdot \text{°C})(0.06 \text{ m}^2)} = 0.11 \text{ °C/W}$$

$$R_6 = R_E = \left(\frac{L}{kA} \right)_E = \frac{0.1 \text{ m}}{(35 \text{ W/m} \cdot \text{°C})(0.06 \text{ m}^2)} = 0.05 \text{ °C/W}$$

$$R_7 = R_F = \left(\frac{L}{kA} \right)_F = \frac{0.06 \text{ m}}{(2 \text{ W/m} \cdot \text{°C})(0.12 \text{ m}^2)} = 0.25 \text{ °C/W}$$

$$R_8 = \frac{0.00012 \text{ m}^2 \cdot \text{°C/W}}{0.12 \text{ m}^2} = 0.001 \text{ °C/W}$$

$$\frac{1}{R_{mid,1}} = \frac{1}{R_2} + \frac{1}{R_3} + \frac{1}{R_4} = \frac{1}{0.06} + \frac{1}{0.16} + \frac{1}{0.06} \longrightarrow R_{mid,1} = 0.025 \text{ °C/W}$$

$$\frac{1}{R_{mid,2}} = \frac{1}{R_5} + \frac{1}{R_6} = \frac{1}{0.11} + \frac{1}{0.05} \longrightarrow R_{mid,2} = 0.034 \text{ °C/W}$$

$$R_{total} = R_1 + R_{mid,1} + R_{mid,2} + R_7 + R_8 = 0.04 + 0.025 + 0.034 + 0.25 + 0.001 = 0.350 \text{ °C/W}$$

$$\dot{Q} = \frac{T_{\infty 1} - T_{\infty 2}}{R_{total}} = \frac{(300 - 100) \text{ °C}}{0.350 \text{ °C/W}} = 571 \text{ W (for a } 0.12 \text{ m} \times 1 \text{ m section)}$$

Then steady rate of heat transfer through entire wall becomes

$$\dot{Q}_{total} = (571 \text{ W}) \frac{(5 \text{ m})(8 \text{ m})}{0.12 \text{ m}^2} = \mathbf{1.90 \times 10^5 \text{ W}}$$

(b) The total thermal resistance between left surface and the point where the sections B, D, and E meet is

$$R_{total} = R_1 + R_{mid,1} = 0.04 + 0.025 = 0.065 \text{ } ^\circ\text{C/W}$$

Then the temperature at the point where The sections B, D, and E meet becomes

$$\dot{Q} = \frac{T_1 - T}{R_{total}} \longrightarrow T = T_1 - \dot{Q}R_{total} = 300^\circ\text{C} - (571 \text{ W})(0.065 \text{ } ^\circ\text{C/W}) = \mathbf{263^\circ\text{C}}$$

(c) The temperature drop across the section F can be determined from

$$\dot{Q} = \frac{\Delta T}{R_F} \longrightarrow \Delta T = \dot{Q}R_F = (571 \text{ W})(0.25 \text{ } ^\circ\text{C/W}) = \mathbf{143^\circ\text{C}}$$

3-61 A coat is made of 5 layers of 0.1 mm thick synthetic fabric separated by 1.5 mm thick air space. The rate of heat loss through the jacket is to be determined, and the result is to be compared to the heat loss through a jackets without the air space. Also, the equivalent thickness of a wool coat is to be determined.

Assumptions 1 Heat transfer is steady since there is no indication of change with time. **2** Heat transfer through the jacket is one-dimensional. **3** Thermal conductivities are constant. **4** Heat transfer coefficients account for the radiation heat transfer.

Properties The thermal conductivities are given to be $k = 0.13 \text{ W/m}\cdot^\circ\text{C}$ for synthetic fabric, $k = 0.026 \text{ W/m}\cdot^\circ\text{C}$ for air, and $k = 0.035 \text{ W/m}\cdot^\circ\text{C}$ for wool fabric.

Analysis The thermal resistance network and the individual thermal resistances are

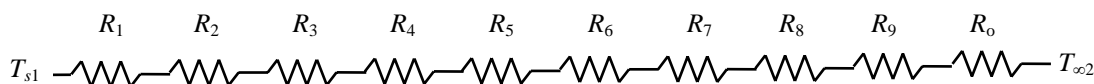

$$R_{fabric} = R_1 = R_3 = R_5 = R_7 = R_9 = \frac{L}{kA} = \frac{0.0001 \text{ m}}{(0.13 \text{ W/m}\cdot^\circ\text{C})(1.25 \text{ m}^2)} = 0.0006 \text{ } ^\circ\text{C/W}$$

$$R_{air} = R_2 = R_4 = R_6 = R_8 = \frac{L}{kA} = \frac{0.0015 \text{ m}}{(0.026 \text{ W/m}\cdot^\circ\text{C})(1.25 \text{ m}^2)} = 0.0462 \text{ } ^\circ\text{C/W}$$

$$R_o = \frac{1}{hA} = \frac{1}{(25 \text{ W/m}^2 \cdot ^\circ\text{C})(1.25 \text{ m}^2)} = 0.0320 \text{ } ^\circ\text{C/W}$$

$$R_{total} = 5R_{fabric} + 4R_{air} + R_o = 5 \times 0.0006 + 4 \times 0.0462 + 0.0320 = 0.2198 \text{ } ^\circ\text{C/W}$$

and

$$\dot{Q} = \frac{T_{s1} - T_{\infty 2}}{R_{total}} = \frac{(28 - 0)^\circ\text{C}}{0.2198 \text{ } ^\circ\text{C/W}} = \mathbf{127 \text{ W}}$$

If the jacket is made of a single layer of 0.5 mm thick synthetic fabric, the rate of heat transfer would be

$$\dot{Q} = \frac{T_{s1} - T_{\infty 2}}{R_{total}} = \frac{T_{s1} - T_{\infty 2}}{5 \times R_{fabric} + R_o} = \frac{(28 - 0)^\circ\text{C}}{(5 \times 0.0006 + 0.0320) \text{ } ^\circ\text{C/W}} = \mathbf{800 \text{ W}}$$

The thickness of a wool fabric that has the same thermal resistance is determined from

$$R_{total} = R_{wool fabric} + R_o = \frac{L}{kA} + \frac{1}{hA}$$

$$0.2198 \text{ } ^\circ\text{C/W} = \frac{L}{(0.035 \text{ W/m}\cdot^\circ\text{C})(1.25 \text{ m}^2)} + 0.0320 \longrightarrow L = 0.0082 \text{ m} = \mathbf{8.2 \text{ mm}}$$

3-62 A coat is made of 5 layers of 0.1 mm thick cotton fabric separated by 1.5 mm thick air space. The rate of heat loss through the jacket is to be determined, and the result is to be compared to the heat loss through a jackets without the air space. Also, the equivalent thickness of a wool coat is to be determined.

Assumptions **1** Heat transfer is steady since there is no indication of change with time. **2** Heat transfer through the jacket is one-dimensional. **3** Thermal conductivities are constant. **4** Heat transfer coefficients account for the radiation heat transfer.

Properties The thermal conductivities are given to be $k = 0.06 \text{ W/m}\cdot\text{C}$ for cotton fabric, $k = 0.026 \text{ W/m}\cdot\text{C}$ for air, and $k = 0.035 \text{ W/m}\cdot\text{C}$ for wool fabric.

Analysis The thermal resistance network and the individual thermal resistances are

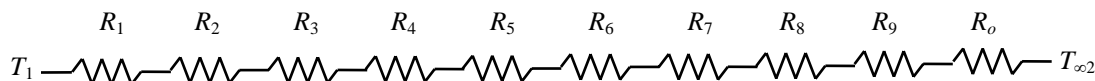

$$R_{\text{cotton}} = R_1 = R_3 = R_5 = R_7 = R_9 = \frac{L}{kA} = \frac{0.0001 \text{ m}}{(0.06 \text{ W/m}\cdot\text{C})(1.25 \text{ m}^2)} = 0.00133 \text{ C/W}$$

$$R_{\text{air}} = R_2 = R_4 = R_6 = R_8 = \frac{L}{kA} = \frac{0.0015 \text{ m}}{(0.026 \text{ W/m}\cdot\text{C})(1.25 \text{ m}^2)} = 0.0462 \text{ C/W}$$

$$R_o = \frac{1}{hA} = \frac{1}{(25 \text{ W/m}^2 \cdot \text{C})(1.25 \text{ m}^2)} = 0.0320 \text{ C/W}$$

$$R_{\text{total}} = 5R_{\text{fabric}} + 4R_{\text{air}} + R_o = 5 \times 0.00133 + 4 \times 0.0462 + 0.0320 = 0.2235 \text{ C/W}$$

and

$$\dot{Q} = \frac{T_{s1} - T_{\infty 2}}{R_{\text{total}}} = \frac{(28 - 0) \text{ C}}{0.2235 \text{ C/W}} = \mathbf{125 \text{ W}}$$

If the jacket is made of a single layer of 0.5 mm thick cotton fabric, the rate of heat transfer will be

$$\dot{Q} = \frac{T_{s1} - T_{\infty 2}}{R_{\text{total}}} = \frac{T_{s1} - T_{\infty 2}}{5 \times R_{\text{fabric}} + R_o} = \frac{(28 - 0) \text{ C}}{(5 \times 0.00133 + 0.0320) \text{ C/W}} = \mathbf{724 \text{ W}}$$

The thickness of a wool fabric for that case can be determined from

$$R_{\text{total}} = R_{\text{wool fabric}} + R_o = \frac{L}{kA} + \frac{1}{hA}$$

$$0.2235 \text{ C/W} = \frac{L}{(0.035 \text{ W/m}\cdot\text{C})(1.25 \text{ m}^2)} + 0.0320 \longrightarrow L = 0.0084 \text{ m} = \mathbf{8.4 \text{ mm}}$$

3-63 A kiln is made of 20 cm thick concrete walls and ceiling. The two ends of the kiln are made of thin sheet metal covered with 2-cm thick styrofoam. For specified indoor and outdoor temperatures, the rate of heat transfer from the kiln is to be determined.

Assumptions **1** Heat transfer is steady since there is no indication of change with time. **2** Heat transfer through the walls and ceiling is one-dimensional. **3** Thermal conductivities are constant. **4** Heat transfer coefficients account for the radiation heat transfer. **5** Heat loss through the floor is negligible. **6** Thermal resistance of sheet metal is negligible.

Properties The thermal conductivities are given to be $k = 0.9 \text{ W/m}\cdot\text{°C}$ for concrete and $k = 0.033 \text{ W/m}\cdot\text{°C}$ for styrofoam insulation.

Analysis In this problem there is a question of which surface area to use. We will use the outer surface area for outer convection resistance, the inner surface area for inner convection resistance, and the average area for the conduction resistance. Or we could use the inner or the outer surface areas in the calculation of all thermal resistances with little loss in accuracy. For top and the two side surfaces:

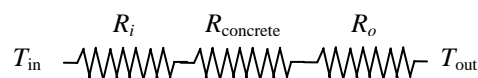

$$R_i = \frac{1}{h_i A_i} = \frac{1}{(3000 \text{ W/m}^2 \cdot \text{°C})[(40 \text{ m})(13 - 1.2) \text{ m}]} = 0.0071 \times 10^{-4} \text{ °C/W}$$

$$R_{\text{concrete}} = \frac{L}{k A_{\text{ave}}} = \frac{0.2 \text{ m}}{(0.9 \text{ W/m}\cdot\text{°C})[(40 \text{ m})(13 - 0.6) \text{ m}]} = 4.480 \times 10^{-4} \text{ °C/W}$$

$$R_o = \frac{1}{h_o A_o} = \frac{1}{(25 \text{ W/m}^2 \cdot \text{°C})[(40 \text{ m})(13 \text{ m})]} = 0.769 \times 10^{-4} \text{ °C/W}$$

$$R_{\text{total}} = R_i + R_{\text{concrete}} + R_o = (0.0071 + 4.480 + 0.769) \times 10^{-4} = 5.256 \times 10^{-4} \text{ °C/W}$$

$$\text{and } \dot{Q}_{\text{top+sides}} = \frac{T_{\text{in}} - T_{\text{out}}}{R_{\text{total}}} = \frac{[40 - (-4)]\text{°C}}{5.256 \times 10^{-4} \text{ °C/W}} = 83,700 \text{ W}$$

Heat loss through the end surface of the kiln with styrofoam:

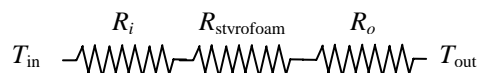

$$R_i = \frac{1}{h_i A_i} = \frac{1}{(3000 \text{ W/m}^2 \cdot \text{°C})[(4 - 0.4)(5 - 0.4) \text{ m}^2]} = 0.201 \times 10^{-4} \text{ °C/W}$$

$$R_{\text{styrofoam}} = \frac{L}{k A_{\text{ave}}} = \frac{0.02 \text{ m}}{(0.033 \text{ W/m}\cdot\text{°C})[(4 - 0.2)(5 - 0.2) \text{ m}^2]} = 0.0332 \text{ °C/W}$$

$$R_o = \frac{1}{h_o A_o} = \frac{1}{(25 \text{ W/m}^2 \cdot \text{°C})[4 \times 5 \text{ m}^2]} = 0.0020 \text{ °C/W}$$

$$R_{\text{total}} = R_i + R_{\text{styrofoam}} + R_o = 0.201 \times 10^{-4} + 0.0332 + 0.0020 = 0.0352 \text{ °C/W}$$

$$\text{and } \dot{Q}_{\text{end surface}} = \frac{T_{\text{in}} - T_{\text{out}}}{R_{\text{total}}} = \frac{[40 - (-4)]\text{°C}}{0.0352 \text{ °C/W}} = 1250 \text{ W}$$

Then the total rate of heat transfer from the kiln becomes

$$\dot{Q}_{\text{total}} = \dot{Q}_{\text{top+sides}} + 2\dot{Q}_{\text{side}} = 83,700 + 2 \times 1250 = \mathbf{86,200 \text{ W}}$$

3-64 EES Prob. 3-63 is reconsidered. The effects of the thickness of the wall and the convection heat transfer coefficient on the outer surface of the rate of heat loss from the kiln are to be investigated.

Analysis The problem is solved using EES, and the solution is given below.

"GIVEN"

width=5 [m]
 height=4 [m]
 length=40 [m]
 L_wall=0.2 [m]
 k_concrete=0.9 [W/m-C]
 T_in=40 [C]
 T_out=-4 [C]
 L_sheet=0.003 [m]
 L_styrofoam=0.02 [m]
 k_styrofoam=0.033 [W/m-C]
 h_i=3000 [W/m^2-C]
 h_o=25 [W/m^2-C]

"ANALYSIS"

R_conv_i=1/(h_i*A_1)
 A_1=(2*height+width-6*L_wall)*length
 R_concrete=L_wall/(k_concrete*A_2)
 A_2=(2*height+width-3*L_wall)*length
 R_conv_o=1/(h_o*A_3)
 A_3=(2*height+width)*length
 R_total_top_sides=R_conv_i+R_concrete+R_conv_o
 Q_dot_top_sides=(T_in-T_out)/R_total_top_sides "Heat loss from top and the two side surfaces"

R_conv_i_end=1/(h_i*A_4)
 A_4=(height-2*L_wall)*(width-2*L_wall)
 R_styrofoam=L_styrofoam/(k_styrofoam*A_5)
 A_5=(height-L_wall)*(width-L_wall)
 R_conv_o_end=1/(h_o*A_6)
 A_6=height*width
 R_total_end=R_conv_i_end+R_styrofoam+R_conv_o_end
 Q_dot_end=(T_in-T_out)/R_total_end "Heat loss from one end surface"

Q_dot_total=Q_dot_top_sides+2*Q_dot_end

L_{wall} [m]	Q_{total} [W]
0.1	151098
0.12	131499
0.14	116335
0.16	104251
0.18	94395
0.2	86201
0.22	79281
0.24	73359
0.26	68233
0.28	63751
0.3	59800

h_o [W/m ² .C]	Q_{total} [W]
5	54834
10	70939
15	78670
20	83212
25	86201
30	88318
35	89895
40	91116
45	92089
50	92882

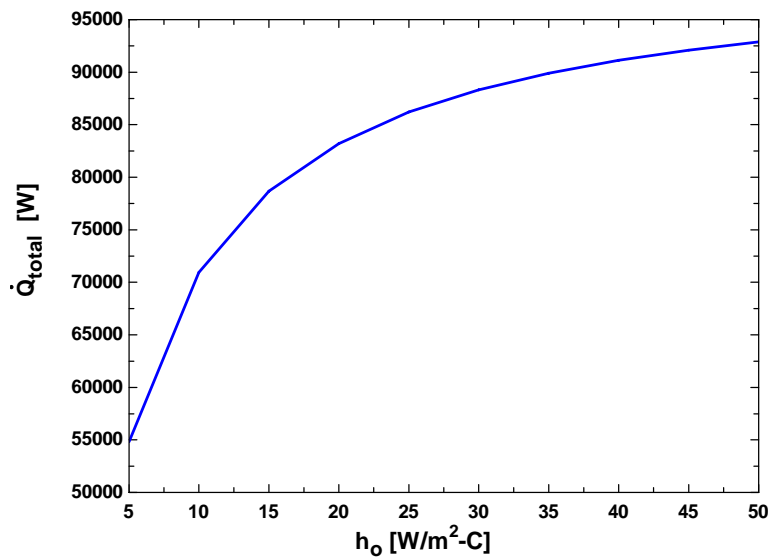
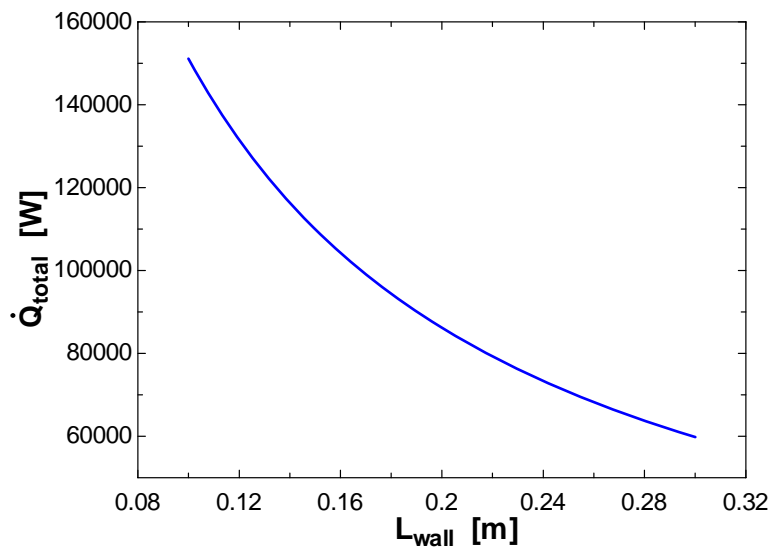

3-65E The thermal resistance of an epoxy glass laminate across its thickness is to be reduced by planting cylindrical copper fillings throughout. The thermal resistance of the epoxy board for heat conduction across its thickness as a result of this modification is to be determined.

Assumptions 1 Steady operating conditions exist. 2 Heat transfer through the plate is one-dimensional. 3 Thermal conductivities are constant.

Properties The thermal conductivities are given to be $k = 0.10$ Btu/h·ft·°F for epoxy glass laminate and $k = 223$ Btu/h·ft·°F for copper fillings.

Analysis The thermal resistances of copper fillings and the epoxy board are in parallel. The number of copper fillings in the board and the area they comprise are

$$A_{total} = (6/12 \text{ ft})(8/12 \text{ ft}) = 0.333 \text{ ft}^2$$

$$n_{copper} = \frac{0.33 \text{ ft}^2}{(0.06/12 \text{ ft})(0.06/12 \text{ ft})} = 13,333 \text{ (number of copper fillings)}$$

$$A_{copper} = n \frac{\pi D^2}{4} = 13,333 \frac{\pi (0.02/12 \text{ ft})^2}{4} = 0.0291 \text{ ft}^2$$

$$A_{epoxy} = A_{total} - A_{copper} = 0.3333 - 0.0291 = 0.3042 \text{ ft}^2$$

The thermal resistances are evaluated to be

$$R_{copper} = \frac{L}{kA} = \frac{0.05/12 \text{ ft}}{(223 \text{ Btu/h} \cdot \text{ft} \cdot \text{°F})(0.0291 \text{ ft}^2)} = 0.00064 \text{ h} \cdot \text{°F/Btu}$$

$$R_{epoxy} = \frac{L}{kA} = \frac{0.05/12 \text{ ft}}{(0.10 \text{ Btu/h} \cdot \text{ft} \cdot \text{°F})(0.3042 \text{ ft}^2)} = 0.137 \text{ h} \cdot \text{°F/Btu}$$

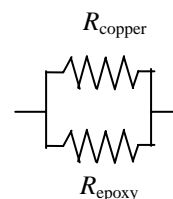

Then the thermal resistance of the entire epoxy board becomes

$$\frac{1}{R_{board}} = \frac{1}{R_{copper}} + \frac{1}{R_{epoxy}} = \frac{1}{0.00064} + \frac{1}{0.137} \longrightarrow R_{board} = \mathbf{0.00064 \text{ h} \cdot \text{°F/Btu}}$$

Heat Conduction in Cylinders and Spheres

3-66C When the diameter of cylinder is very small compared to its length, it can be treated as an infinitely long cylinder. Cylindrical rods can also be treated as being infinitely long when dealing with heat transfer at locations far from the top or bottom surfaces. However, it is not proper to use this model when finding temperatures near the bottom and the top of the cylinder.

3-67C Heat transfer in this short cylinder is one-dimensional since there will be no heat transfer in the axial and tangential directions.

3-68C No. In steady-operation the temperature of a solid cylinder or sphere does not change in radial direction (unless there is heat generation).

3-69 Chilled water is flowing inside a pipe. The thickness of the insulation needed to reduce the temperature rise of water to one-fourth of the original value is to be determined.

Assumptions **1** Heat transfer is steady since there is no indication of any change with time. **2** Heat transfer is one-dimensional since there is thermal symmetry about the centerline and no variation in the axial direction. **3** Thermal conductivities are constant. **4** The thermal contact resistance at the interface is negligible.

Properties The thermal conductivity is given to be $k = 0.05 \text{ W/m}\cdot\text{C}$ for insulation.

Analysis The rate of heat transfer without the insulation is

$$\dot{Q}_{\text{old}} = \dot{m}c_p\Delta T = (0.98 \text{ kg/s})(4180 \text{ J/kg}\cdot\text{C})(8 - 7)\text{C} = 4096 \text{ W}$$

The total resistance in this case is

$$\dot{Q}_{\text{old}} = \frac{T_{\infty} - T_w}{R_{\text{total}}}$$

$$4096 \text{ W} = \frac{(30 - 7.5)\text{C}}{R_{\text{total}}} \rightarrow R_{\text{total}} = 0.005493\text{C/W}$$

The convection resistance on the outer surface is

$$R_o = \frac{1}{h_o A_o} = \frac{1}{(9 \text{ W/m}^2\cdot\text{C})\pi(0.05 \text{ m})(150 \text{ m})} = 0.004716\text{C/W}$$

The rest of thermal resistances are due to convection resistance on the inner surface and the resistance of the pipe and it is determined from

$$R_1 = R_{\text{total}} - R_o = 0.005493 - 0.004716 = 0.0007769\text{C/W}$$

The rate of heat transfer with the insulation is

$$\dot{Q}_{\text{new}} = \dot{m}c_p\Delta T = (0.98 \text{ kg/s})(4180 \text{ J/kg}\cdot\text{C})(0.25\text{C}) = 1024 \text{ W}$$

The total thermal resistance with the insulation is

$$\dot{Q}_{\text{new}} = \frac{T_{\infty} - T_w}{R_{\text{total,new}}} \rightarrow 1024 \text{ W} = \frac{[30 - (7 + 7.25)/2]\text{C}}{R_{\text{total,new}}} \rightarrow R_{\text{total,new}} = 0.02234\text{C/W}$$

It is expressed by

$$R_{\text{total,new}} = R_1 + R_{o,\text{new}} + R_{\text{ins}} = R_1 + \frac{1}{h_o A_o} + \frac{\ln(D_2 / D_1)}{2\pi k_{\text{ins}} L}$$

$$0.02234\text{C/W} = 0.0007769 + \frac{1}{(9 \text{ W/m}^2\cdot\text{C})\pi D_2 (150 \text{ m})} + \frac{\ln(D_2 / 0.05)}{2\pi(0.05 \text{ W/m}\cdot\text{C})(150 \text{ m})}$$

Solving this equation by trial-error or by using an equation solver such as EES, we obtain

$$D_2 = 0.1265 \text{ m}$$

Then the required thickness of the insulation becomes

$$t_{\text{ins}} = (D_2 - D_1) / 2 = (0.05 - 0.1265) / 2 = 0.0382 \text{ m} = \mathbf{3.8 \text{ cm}}$$

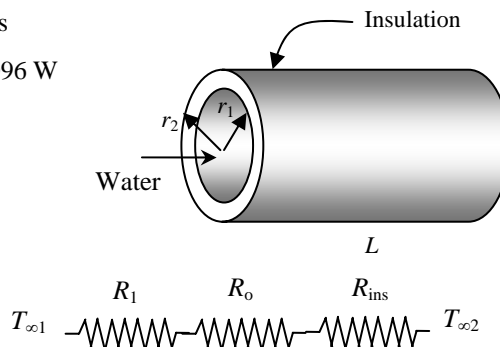

3-70 Steam flows in a steel pipe, which is insulated by gypsum plaster. The rate of heat transfer from the steam and the temperature on the outside surface of the insulation are to be determined.

Assumptions **1** Heat transfer is steady since there is no indication of any change with time. **2** Heat transfer is one-dimensional since there is thermal symmetry about the centerline and no variation in the axial direction. **3** Thermal conductivities are constant. **4** The thermal contact resistance at the interface is negligible.

Properties (a) The thermal conductivities of steel and gypsum plaster are given to be 50 and 0.5 W/m·°C, respectively.

Analysis The thermal resistances are

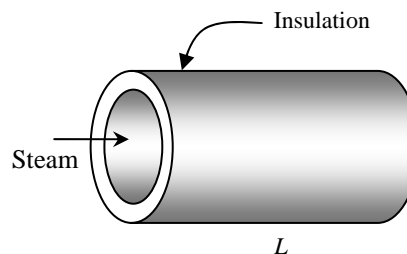

$$R_i = \frac{1}{h_i A_i} = \frac{1}{(800 \text{ W/m}^2 \cdot \text{°C})\pi(0.06 \text{ m})(20 \text{ m})} = 0.0003316^\circ\text{C/W}$$

$$R_{\text{steel}} = \frac{\ln(D_2 / D_1)}{2\pi k_{\text{steel}} L} = \frac{\ln(8 / 6)}{2\pi(50 \text{ W/m} \cdot \text{°C})(20 \text{ m})} = 0.0000458^\circ\text{C/W}$$

$$R_{\text{ins}} = \frac{\ln(D_3 / D_2)}{2\pi k_{\text{ins}} L} = \frac{\ln(16 / 8)}{2\pi(0.5 \text{ W/m} \cdot \text{°C})(20 \text{ m})} = 0.011032^\circ\text{C/W}$$

$$R_o = \frac{1}{h_o A_o} = \frac{1}{(200 \text{ W/m}^2 \cdot \text{°C})\pi(0.16 \text{ m})(20 \text{ m})} = 0.0004974^\circ\text{C/W}$$

The total thermal resistance and the rate of heat transfer are

$$R_{\text{total}} = R_i + R_{\text{steel}} + R_{\text{ins}} + R_o = 0.0003316 + 0.0000458 + 0.011032 + 0.0004974 = 0.011907^\circ\text{C/W}$$

$$\dot{Q} = \frac{T_i - T_o}{R_{\text{total}}} = \frac{(200 - 10)^\circ\text{C}}{0.011907 \text{ m}^2 \cdot \text{°C/W}} = \mathbf{15,957 \text{ W}}$$

(b) The temperature at the outer surface of the insulation is determined from

$$\dot{Q} = \frac{T_s - T_o}{R_o} \longrightarrow 15,957 \text{ W} = \frac{(T_s - 10)^\circ\text{C}}{0.0004974 \text{ m}^2 \cdot \text{°C/W}} \longrightarrow T_s = \mathbf{17.9^\circ\text{C}}$$

3-71 A spherical container filled with iced water is subjected to convection and radiation heat transfer at its outer surface. The rate of heat transfer and the amount of ice that melts per day are to be determined.

Assumptions 1 Heat transfer is steady since the specified thermal conditions at the boundaries do not change with time. **2** Heat transfer is one-dimensional since there is thermal symmetry about the midpoint. **3** Thermal conductivity is constant.

Properties The thermal conductivity of steel is given to be $k = 15 \text{ W/m}\cdot\text{C}$. The heat of fusion of water at 1 atm is $h_{if} = 333.7 \text{ kJ/kg}$. The outer surface of the tank is black and thus its emissivity is $\epsilon = 1$.

Analysis (a) The inner and the outer surface areas of sphere are

$$A_i = \pi D_i^2 = \pi(8 \text{ m})^2 = 201.06 \text{ m}^2 \quad A_o = \pi D_o^2 = \pi(8.03 \text{ m})^2 = 202.57 \text{ m}^2$$

We assume the outer surface temperature T_2 to be 5°C after comparing convection heat transfer coefficients at the inner and the outer surfaces of the tank. With this assumption, the radiation heat transfer coefficient can be determined from

$$\begin{aligned} h_{rad} &= \epsilon \sigma (T_2^2 + T_{surr}^2)(T_2 + T_{surr}) \\ &= 1(5.67 \times 10^{-8} \text{ W/m}^2 \cdot \text{K}^4)[(273 + 5 \text{ K})^2 + (273 + 25 \text{ K})^2](273 + 25 \text{ K})(273 + 5 \text{ K}) \\ &= 5.424 \text{ W/m}^2 \cdot \text{K} \end{aligned}$$

The individual thermal resistances are

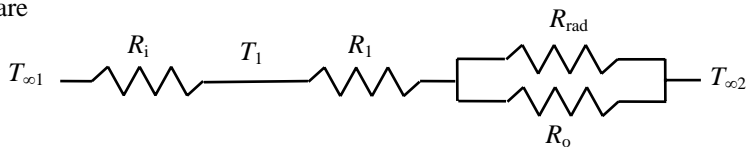

$$R_{conv,i} = \frac{1}{h_i A} = \frac{1}{(80 \text{ W/m}^2 \cdot ^\circ\text{C})(201.06 \text{ m}^2)} = 0.000062 \text{ }^\circ\text{C/W}$$

$$R_1 = R_{sphere} = \frac{r_2 - r_1}{4\pi k r_1 r_2} = \frac{(4.015 - 4.0) \text{ m}}{4\pi(15 \text{ W/m}\cdot^\circ\text{C})(4.015 \text{ m})(4.0 \text{ m})} = 0.000005 \text{ }^\circ\text{C/W}$$

$$R_{conv,o} = \frac{1}{h_o A} = \frac{1}{(10 \text{ W/m}^2 \cdot ^\circ\text{C})(202.57 \text{ m}^2)} = 0.000494 \text{ }^\circ\text{C/W}$$

$$R_{rad} = \frac{1}{h_{rad} A} = \frac{1}{(5.424 \text{ W/m}^2 \cdot ^\circ\text{C})(202.57 \text{ m}^2)} = 0.000910 \text{ }^\circ\text{C/W}$$

$$\frac{1}{R_{eqv}} = \frac{1}{R_{conv,o}} + \frac{1}{R_{rad}} = \frac{1}{0.000494} + \frac{1}{0.000910} \longrightarrow R_{eqv} = 0.000320 \text{ }^\circ\text{C/W}$$

$$R_{total} = R_{conv,i} + R_1 + R_{eqv} = 0.000062 + 0.000005 + 0.000320 = 0.000387 \text{ }^\circ\text{C/W}$$

Then the steady rate of heat transfer to the iced water becomes

$$\dot{Q} = \frac{T_{\infty 1} - T_{\infty 2}}{R_{total}} = \frac{(25 - 0)^\circ\text{C}}{0.000387 \text{ }^\circ\text{C/W}} = \mathbf{64,600 \text{ W}}$$

(b) The total amount of heat transfer during a 24-hour period and the amount of ice that will melt during this period are

$$Q = \dot{Q} \Delta t = (64,600 \text{ kJ/s})(24 \times 3600 \text{ s}) = 5.581 \times 10^6 \text{ kJ}$$

$$m_{ice} = \frac{Q}{h_{if}} = \frac{5.581 \times 10^6 \text{ kJ}}{333.7 \text{ kJ/kg}} = \mathbf{16,730 \text{ kg}}$$

Check: The outer surface temperature of the tank is

$$\begin{aligned} \dot{Q} &= h_{conv+rad} A_o (T_{\infty 1} - T_s) \\ \rightarrow T_s &= T_{\infty 1} - \frac{\dot{Q}}{h_{conv+rad} A_o} = 25^\circ\text{C} - \frac{64,600 \text{ W}}{(10 + 5.424 \text{ W/m}^2 \cdot ^\circ\text{C})(202.57 \text{ m}^2)} = 4.3^\circ\text{C} \end{aligned}$$

which is very close to the assumed temperature of 5°C for the outer surface temperature used in the evaluation of the radiation heat transfer coefficient. Therefore, there is no need to repeat the calculations.

3-72 A steam pipe covered with 3-cm thick glass wool insulation is subjected to convection on its surfaces. The rate of heat transfer per unit length and the temperature drops across the pipe and the insulation are to be determined.

Assumptions **1** Heat transfer is steady since there is no indication of any change with time. **2** Heat transfer is one-dimensional since there is thermal symmetry about the center line and no variation in the axial direction. **3** Thermal conductivities are constant. **4** The thermal contact resistance at the interface is negligible.

Properties The thermal conductivities are given to be $k = 15 \text{ W/m}\cdot^\circ\text{C}$ for steel and $k = 0.038 \text{ W/m}\cdot^\circ\text{C}$ for glass wool insulation

Analysis The inner and the outer surface areas of the insulated pipe per unit length are

$$A_i = \pi D_i L = \pi(0.05 \text{ m})(1 \text{ m}) = 0.157 \text{ m}^2$$

$$A_o = \pi D_o L = \pi(0.055 + 0.06 \text{ m})(1 \text{ m}) = 0.361 \text{ m}^2$$

The individual thermal resistances are

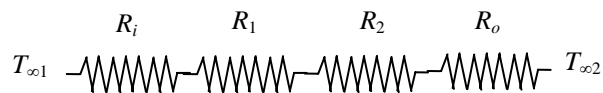

$$R_i = \frac{1}{h_i A_i} = \frac{1}{(80 \text{ W/m}^2 \cdot ^\circ\text{C})(0.157 \text{ m}^2)} = 0.08 \text{ }^\circ\text{C/W}$$

$$R_1 = R_{\text{pipe}} = \frac{\ln(r_2 / r_1)}{2\pi k_1 L} = \frac{\ln(2.75 / 2.5)}{2\pi(15 \text{ W/m}\cdot^\circ\text{C})(1 \text{ m})} = 0.00101 \text{ }^\circ\text{C/W}$$

$$R_2 = R_{\text{insulation}} = \frac{\ln(r_3 / r_2)}{2\pi k_2 L} = \frac{\ln(5.75 / 2.75)}{2\pi(0.038 \text{ W/m}\cdot^\circ\text{C})(1 \text{ m})} = 3.089 \text{ }^\circ\text{C/W}$$

$$R_o = \frac{1}{h_o A_o} = \frac{1}{(15 \text{ W/m}^2 \cdot ^\circ\text{C})(0.361 \text{ m}^2)} = 0.1847 \text{ }^\circ\text{C/W}$$

$$R_{\text{total}} = R_i + R_1 + R_2 + R_o = 0.08 + 0.00101 + 3.089 + 0.1847 = 3.355 \text{ }^\circ\text{C/W}$$

Then the steady rate of heat loss from the steam per m. pipe length becomes

$$\dot{Q} = \frac{T_{\infty 1} - T_{\infty 2}}{R_{\text{total}}} = \frac{(320 - 5)^\circ\text{C}}{3.355 \text{ }^\circ\text{C/W}} = \mathbf{93.9 \text{ W}}$$

The temperature drops across the pipe and the insulation are

$$\Delta T_{\text{pipe}} = \dot{Q} R_{\text{pipe}} = (93.9 \text{ W})(0.00101 \text{ }^\circ\text{C/W}) = \mathbf{0.095^\circ\text{C}}$$

$$\Delta T_{\text{insulation}} = \dot{Q} R_{\text{insulation}} = (93.9 \text{ W})(3.089 \text{ }^\circ\text{C/W}) = \mathbf{290^\circ\text{C}}$$

3-73 EES Prob. 3-72 is reconsidered. The effect of the thickness of the insulation on the rate of heat loss from the steam and the temperature drop across the insulation layer are to be investigated.

Analysis The problem is solved using EES, and the solution is given below.

"GIVEN"

T_infinity_1=320 [C]; T_infinity_2=5 [C]
 k_steel=15 [W/m-C]
 D_i=0.05 [m]; D_o=0.055 [m]
 r_1=D_i/2; r_2=D_o/2
 t_ins=3 [cm]
 k_ins=0.038 [W/m-C]
 h_o=15 [W/m^2-C]
 h_i=80 [W/m^2-C]
 L=1 [m]

"ANALYSIS"

A_i=pi*D_i*L
 A_o=pi*(D_o+2*t_ins*Convert(cm, m))*L
 R_conv_i=1/(h_i*A_i)
 R_pipe=ln(r_2/r_1)/(2*pi*k_steel*L)
 R_ins=ln(r_3/r_2)/(2*pi*k_ins*L)
 r_3=r_2+t_ins*Convert(cm, m) "t_ins is in cm"
 R_conv_o=1/(h_o*A_o)
 R_total=R_conv_i+R_pipe+R_ins+R_conv_o
 Q_dot=(T_infinity_1-T_infinity_2)/R_total
 DELTAT_pipe=Q_dot*R_pipe
 DELTAT_ins=Q_dot*R_ins

T _{ins} [cm]	Q [W]	ΔT _{ins} [C]
1	189.5	246.1
2	121.5	278.1
3	93.91	290.1
4	78.78	296.3
5	69.13	300
6	62.38	302.4
7	57.37	304.1
8	53.49	305.4
9	50.37	306.4
10	47.81	307.2

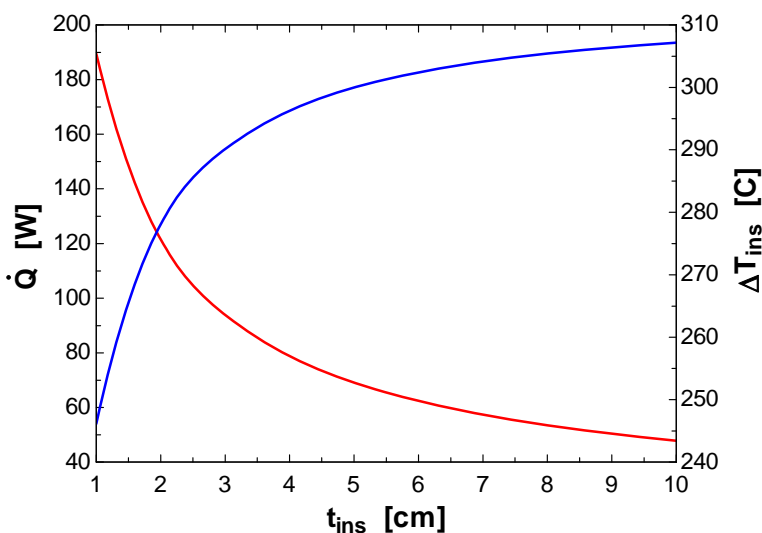

3-74 A 50-m long section of a steam pipe passes through an open space at 15°C. The rate of heat loss from the steam pipe, the annual cost of this heat loss, and the thickness of fiberglass insulation needed to save 90 percent of the heat lost are to be determined.

Assumptions **1** Heat transfer is steady since there is no indication of any change with time. **2** Heat transfer is one-dimensional since there is thermal symmetry about the center line and no variation in the axial direction. **3** Thermal conductivity is constant. **4** The thermal contact resistance at the interface is negligible. **5** The pipe temperature remains constant at about 150°C with or without insulation. **6** The combined heat transfer coefficient on the outer surface remains constant even after the pipe is insulated.

Properties The thermal conductivity of fiberglass insulation is given to be $k = 0.035 \text{ W/m}\cdot\text{°C}$.

Analysis (a) The rate of heat loss from the steam pipe is

$$A_o = \pi DL = \pi(0.1 \text{ m})(50 \text{ m}) = 15.71 \text{ m}^2$$

$$\dot{Q}_{\text{bare}} = h_o A(T_s - T_{\text{air}}) = (20 \text{ W/m}^2 \cdot \text{°C})(15.71 \text{ m}^2)(150 - 15)\text{°C} = \mathbf{42,412 \text{ W}}$$

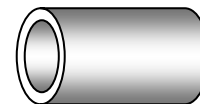

(b) The amount of heat loss per year is

$$Q = \dot{Q}\Delta t = (42.412 \text{ kJ/s})(365 \times 24 \times 3600 \text{ s/yr}) = 1.337 \times 10^9 \text{ kJ/yr}$$

The amount of gas consumption from the natural gas furnace that has an efficiency of 75% is

$$Q_{\text{gas}} = \frac{1.337 \times 10^9 \text{ kJ/yr}}{0.75} \left(\frac{1 \text{ therm}}{105,500 \text{ kJ}} \right) = 16,903 \text{ therms/yr}$$

The annual cost of this energy lost is

$$\begin{aligned} \text{Energy cost} &= (\text{Energy used})(\text{Unit cost of energy}) \\ &= (16,903 \text{ therms/yr})(\$0.52 / \text{therm}) = \mathbf{\$8790/\text{yr}} \end{aligned}$$

(c) In order to save 90% of the heat loss and thus to reduce it to $0.1 \times 42,412 = 4241 \text{ W}$, the thickness of insulation needed is determined from

$$\dot{Q}_{\text{insulated}} = \frac{T_s - T_{\text{air}}}{R_o + R_{\text{insulation}}} = \frac{T_s - T_{\text{air}}}{\frac{1}{h_o A_o} + \frac{\ln(r_2 / r_1)}{2\pi k L}}$$

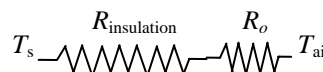

Substituting and solving for r_2 , we get

$$4241 \text{ W} = \frac{(150 - 15)\text{°C}}{\frac{1}{(20 \text{ W/m}^2 \cdot \text{°C})(2\pi r_2 (50 \text{ m}))} + \frac{\ln(r_2 / 0.05)}{2\pi(0.035 \text{ W/m}\cdot\text{°C})(50 \text{ m})}} \longrightarrow r_2 = 0.0692 \text{ m}$$

Then the thickness of insulation becomes

$$t_{\text{insulation}} = r_2 - r_1 = 6.92 - 5 = \mathbf{1.92 \text{ cm}}$$

3-75 An electric hot water tank is made of two concentric cylindrical metal sheets with foam insulation in between. The fraction of the hot water cost that is due to the heat loss from the tank and the payback period of the do-it-yourself insulation kit are to be determined.

Assumptions 1 Heat transfer is steady since there is no indication of any change with time. **2** Heat transfer is one-dimensional since there is thermal symmetry about the center line and no variation in the axial direction. **3** Thermal conductivities are constant. **4** The thermal resistances of the water tank and the outer thin sheet metal shell are negligible. **5** Heat loss from the top and bottom surfaces is negligible.

Properties The thermal conductivities are given to be $k = 0.03 \text{ W/m}\cdot\text{C}$ for foam insulation and $k = 0.035 \text{ W/m}\cdot\text{C}$ for fiber glass insulation

Analysis We consider only the side surfaces of the water heater for simplicity, and disregard the top and bottom surfaces (it will make difference of about 10 percent). The individual thermal resistances are

$$A_i = \pi D_i L = \pi(0.40 \text{ m})(2 \text{ m}) = 2.51 \text{ m}^2$$

$$R_o = \frac{1}{h_i A_i} = \frac{1}{(50 \text{ W/m}^2 \cdot \text{C})(2.51 \text{ m}^2)} = 0.008 \text{ C/W}$$

$$A_o = \pi D_o L = \pi(0.46 \text{ m})(2 \text{ m}) = 2.89 \text{ m}^2$$

$$R_o = \frac{1}{h_o A_o} = \frac{1}{(12 \text{ W/m}^2 \cdot \text{C})(2.89 \text{ m}^2)} = 0.029 \text{ C/W}$$

$$R_{\text{foam}} = \frac{\ln(r_2 / r_1)}{2\pi k L} = \frac{\ln(23 / 20)}{2\pi(0.03 \text{ W/m}^2 \cdot \text{C})(2 \text{ m})} = 0.37 \text{ C/W}$$

$$R_{\text{total}} = R_i + R_o + R_{\text{foam}} = 0.008 + 0.029 + 0.37 = 0.407 \text{ C/W}$$

The rate of heat loss from the hot water tank is

$$\dot{Q} = \frac{T_w - T_{\infty 2}}{R_{\text{total}}} = \frac{(55 - 27)^\circ\text{C}}{0.407 \text{ C/W}} = 68.8 \text{ W}$$

The amount and cost of heat loss per year are

$$Q = \dot{Q}\Delta t = (0.0688 \text{ kW})(365 \times 24 \text{ h/yr}) = 602.7 \text{ kWh/yr}$$

$$\text{Cost of Energy} = (\text{Amount of energy})(\text{Unit cost}) = (602.7 \text{ kWh})(\$0.08 / \text{kWh}) = \$48.22$$

$$f = \frac{\$48.22}{\$280} = 0.1722 = \mathbf{17.2\%}$$

If 3 cm thick fiber glass insulation is used to wrap the entire tank, the individual resistances becomes

$$A_o = \pi D_o L = \pi(0.52 \text{ m})(2 \text{ m}) = 3.267 \text{ m}^2$$

$$R_o = \frac{1}{h_o A_o} = \frac{1}{(12 \text{ W/m}^2 \cdot \text{C})(3.267 \text{ m}^2)} = 0.026 \text{ C/W}$$

$$R_{\text{foam}} = \frac{\ln(r_2 / r_1)}{2\pi k_1 L} = \frac{\ln(23 / 20)}{2\pi(0.03 \text{ W/m}^2 \cdot \text{C})(2 \text{ m})} = 0.371 \text{ C/W}$$

$$R_{\text{fiberglass}} = \frac{\ln(r_3 / r_2)}{2\pi k_2 L} = \frac{\ln(26 / 23)}{2\pi(0.035 \text{ W/m}^2 \cdot \text{C})(2 \text{ m})} = 0.279 \text{ C/W}$$

$$R_{\text{total}} = R_i + R_o + R_{\text{foam}} + R_{\text{fiberglass}} = 0.008 + 0.026 + 0.371 + 0.279 = 0.684 \text{ C/W}$$

The rate of heat loss from the hot water heater in this case is

$$\dot{Q} = \frac{T_w - T_{\infty 2}}{R_{\text{total}}} = \frac{(55 - 27)^\circ\text{C}}{0.684 \text{ C/W}} = 40.94 \text{ W}$$

The energy saving is

$$\text{saving} = 70 - 40.94 = 29.06 \text{ W}$$

The time necessary for this additional insulation to pay for its cost of \$30 is then determined to be

$$\text{Cost} = (0.02906 \text{ kW})(\text{Time period})(\$0.08 / \text{kWh}) = \$30$$

Then, Time period = 12,904 hours = **538 days \approx 1.5 years**

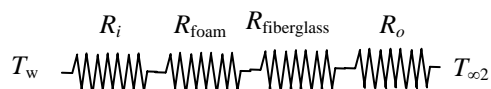
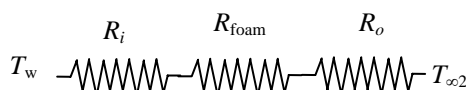

3-76 EES Prob. 3-75 is reconsidered. The fraction of energy cost of hot water due to the heat loss from the tank as a function of the hot-water temperature is to be plotted.

Analysis The problem is solved using EES, and the solution is given below.

"GIVEN"

L=2 [m]
 D_i=0.40 [m]
 D_o=0.46 [m]
 r_1=D_i/2
 r_2=D_o/2
 T_w=55 [C]
 T_infinity_2=27 [C]
 h_i=50 [W/m^2-C]
 h_o=12 [W/m^2-C]
 k_ins=0.03 [W/m-C]
 Price_electric=0.08 [\$/kWh]
 Cost_heating=280 [\$/year]

"ANALYSIS"

A_i=pi*D_i*L
 A_o=pi*D_o*L
 R_conv_i=1/(h_i*A_i)
 R_ins=ln(r_2/r_1)/(2*pi*k_ins*L)
 R_conv_o=1/(h_o*A_o)
 R_total=R_conv_i+R_ins+R_conv_o
 Q_dot=(T_w-T_infinity_2)/R_total
 Q=(Q_dot*Convert(W, kW))*time
 time=365*24 "[h/year]"
 Cost_HeatLoss=Q*Price_electric
 f_HeatLoss=Cost_HeatLoss/Cost_heating*Convert(, %)

T _w [C]	f _{HeatLoss} [%]
40	7.984
45	11.06
50	14.13
55	17.2
60	20.27
65	23.34
70	26.41
75	29.48
80	32.55
85	35.62
90	38.69

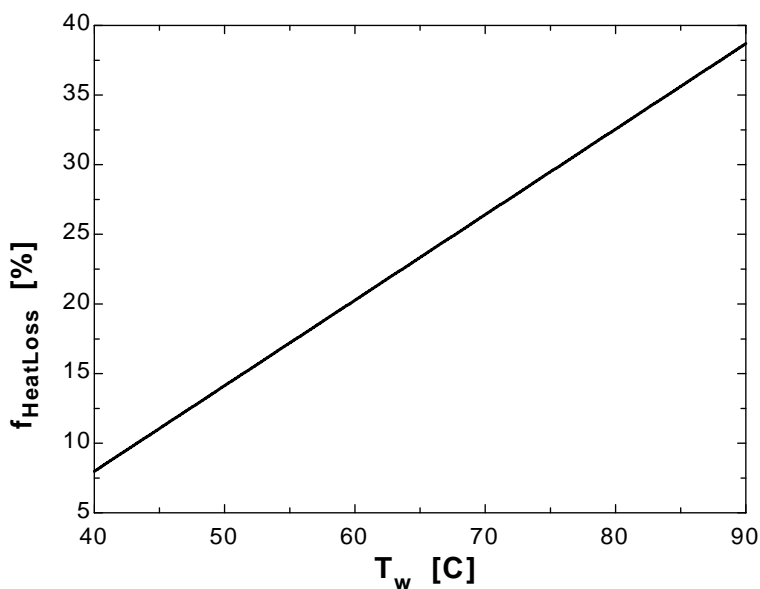

3-77 A cold aluminum canned drink that is initially at a uniform temperature of 3°C is brought into a room air at 25°C. The time it will take for the average temperature of the drink to rise to 15°C with and without rubber insulation is to be determined.

Assumptions 1 The drink is at a uniform temperature at all times. **2** The thermal resistance of the can and the internal convection resistance are negligible so that the can is at the same temperature as the drink inside. **3** Heat transfer is one-dimensional since there is thermal symmetry about the centerline and no variation in the axial direction. **4** Thermal properties are constant. **5** The thermal contact resistance at the interface is negligible.

Properties The thermal conductivity of rubber insulation is given to be $k = 0.13 \text{ W/m}\cdot\text{°C}$. For the drink, we use the properties of water at room temperature, $\rho = 1000 \text{ kg/m}^3$ and $c_p = 4180 \text{ J/kg}\cdot\text{°C}$.

Analysis This is a transient heat conduction, and the rate of heat transfer will decrease as the drink warms up and the temperature difference between the drink and the surroundings decreases. However, we can solve this problem approximately by assuming a constant average temperature of $(3+15)/2 = 9.5\text{°C}$ during the process. Then the average rate of heat transfer into the drink is

$$A_o = \pi D_o L + 2 \frac{\pi D^2}{4} = \pi(0.06 \text{ m})(0.125 \text{ m}) + 2 \frac{\pi(0.06 \text{ m})^2}{4} = 0.02922 \text{ m}^2$$

$$\dot{Q}_{bare,ave} = h_o A(T_{air} - T_{can,ave}) = (10 \text{ W/m}^2 \cdot \text{°C})(0.02922 \text{ m}^2)(25 - 9.5)\text{°C} = 4.529 \text{ W}$$

The amount of heat that must be supplied to the drink to raise its temperature to 15°C is

$$m = \rho V = \rho \pi r^2 L = (1000 \text{ kg/m}^3) \pi (0.03 \text{ m})^2 (0.125 \text{ m}) = 0.3534 \text{ kg}$$

$$Q = mc_p \Delta T = (0.3534 \text{ kg})(4180 \text{ J/kg})(15 - 4)\text{°C} = 16,250 \text{ J}$$

Then the time required for this much heat transfer to take place is

$$\Delta t = \frac{Q}{\dot{Q}} = \frac{16,250 \text{ J}}{4.529 \text{ J/s}} = 3588 \text{ s} = \mathbf{59.8 \text{ min}}$$

We now repeat calculations after wrapping the can with 1-cm thick rubber insulation, except the top surface. The rate of heat transfer from the top surface is

$$\dot{Q}_{top,ave} = h_o A_{top} (T_{air} - T_{can,ave}) = (10 \text{ W/m}^2 \cdot \text{°C})[\pi(0.03 \text{ m})^2](25 - 9.5)\text{°C} = 0.44 \text{ W}$$

Heat transfer through the insulated side surface is

$$A_o = \pi D_o L = \pi(0.08 \text{ m})(0.125 \text{ m}) = 0.03142 \text{ m}^2$$

$$R_o = \frac{1}{h_o A_o} = \frac{1}{(10 \text{ W/m}^2 \cdot \text{°C})(0.03142 \text{ m}^2)} = 3.183 \text{ °C/W}$$

$$R_{insulation,side} = \frac{\ln(r_2 / r_1)}{2\pi k L} = \frac{\ln(4/3)}{2\pi(0.13 \text{ W/m}^2 \cdot \text{°C})(0.125 \text{ m})} = 2.818 \text{ °C/W}$$

$$R_{total} = R_o + R_{insulation} = 3.183 + 2.818 = 6.001 \text{ °C/W}$$

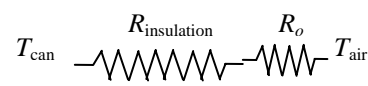
$$\dot{Q}_{side} = \frac{T_{air} - T_{can,ave}}{R_{conv,o}} = \frac{(25 - 9.5)\text{°C}}{6.001 \text{ °C/W}} = 2.58 \text{ W}$$

The ratio of bottom to the side surface areas is $(\pi r^2)/(2\pi r L) = r/(2L) = 3/(2 \times 12.5) = 0.12$. Therefore, the effect of heat transfer through the bottom surface can be accounted for approximately by increasing the heat transfer from the side surface by 12%. Then,

$$\dot{Q}_{insulated} = \dot{Q}_{side+bottom} + \dot{Q}_{top} = 1.12 \times 2.58 + 0.44 = 3.33 \text{ W}$$

Then the time of heating becomes

$$\Delta t = \frac{Q}{\dot{Q}} = \frac{16,250 \text{ J}}{3.33 \text{ J/s}} = 4880 \text{ s} = \mathbf{81.3 \text{ min}}$$

3-78 A cold aluminum canned drink that is initially at a uniform temperature of 3°C is brought into a room air at 25°C. The time it will take for the average temperature of the drink to rise to 10°C with and without rubber insulation is to be determined.

Assumptions 1 The drink is at a uniform temperature at all times. **2** The thermal resistance of the can and the internal convection resistance are negligible so that the can is at the same temperature as the drink inside. **3** Heat transfer is one-dimensional since there is thermal symmetry about the centerline and no variation in the axial direction. **4** Thermal properties are constant. **5** The thermal contact resistance at the interface is to be considered.

Properties The thermal conductivity of rubber insulation is given to be $k = 0.13 \text{ W/m}\cdot\text{°C}$. For the drink, we use the properties of water at room temperature, $\rho = 1000 \text{ kg/m}^3$ and $c_p = 4180 \text{ J/kg}\cdot\text{°C}$.

Analysis This is a transient heat conduction, and the rate of heat transfer will decrease as the drink warms up and the temperature difference between the drink and the surroundings decreases. However, we can solve this problem approximately by assuming a constant average temperature of $(3+10)/2 = 6.5^\circ\text{C}$ during the process. Then the average rate of heat transfer into the drink is

$$A_o = \pi D_o L + 2 \frac{\pi D^2}{4} = \pi(0.06 \text{ m})(0.125 \text{ m}) + 2 \frac{\pi(0.06 \text{ m})^2}{4} = 0.02922 \text{ m}^2$$

$$\dot{Q}_{\text{bare,ave}} = h_o A(T_{\text{air}} - T_{\text{can,ave}}) = (10 \text{ W/m}^2 \cdot \text{°C})(0.02922 \text{ m}^2)(25 - 9.5)^\circ\text{C} = 4.529 \text{ W}$$

The amount of heat that must be supplied to the drink to raise its temperature to 15°C is

$$m = \rho V = \rho \pi r^2 L = (1000 \text{ kg/m}^3)\pi(0.03 \text{ m})^2(0.125 \text{ m}) = 0.3534 \text{ kg}$$

$$Q = mc_p \Delta T = (0.3534 \text{ kg})(4180 \text{ J/kg})(15 - 4)^\circ\text{C} = 16,250 \text{ J}$$

Then the time required for this much heat transfer to take place is

$$\Delta t = \frac{Q}{\dot{Q}} = \frac{16,250 \text{ J}}{4.529 \text{ J/s}} = 3588 \text{ s} = \mathbf{59.8 \text{ min}}$$

We now repeat calculations after wrapping the can with 1-cm thick rubber insulation, except the top surface. The rate of heat transfer from the top surface is

$$\dot{Q}_{\text{top,ave}} = h_o A_{\text{top}}(T_{\text{air}} - T_{\text{can,ave}}) = (10 \text{ W/m}^2 \cdot \text{°C})[\pi(0.03 \text{ m})^2](25 - 9.5)^\circ\text{C} = 0.44 \text{ W}$$

Heat transfer through the insulated side surface is

$$A_o = \pi D_o L = \pi(0.08 \text{ m})(0.125 \text{ m}) = 0.03142 \text{ m}^2$$

$$R_o = \frac{1}{h_o A_o} = \frac{1}{(10 \text{ W/m}^2 \cdot \text{°C})(0.03142 \text{ m}^2)} = 3.183 \text{ °C/W}$$

$$R_{\text{insulation,side}} = \frac{\ln(r_2 / r_1)}{2\pi k L} = \frac{\ln(4/3)}{2\pi(0.13 \text{ W/m}\cdot\text{°C})(0.125 \text{ m})} = 2.818 \text{ °C/W}$$

$$R_{\text{contact}} = \frac{0.00008 \text{ m}^2 \cdot \text{°C/W}}{\pi(0.06 \text{ m})(0.125 \text{ m})} = 0.0034 \text{ °C/W}$$

$$R_{\text{total}} = R_o + R_{\text{insulation}} + R_{\text{contact}} = 3.183 + 2.818 + 0.0034 = 6.004 \text{ °C/W}$$

$$\dot{Q}_{\text{side}} = \frac{T_{\text{air}} - T_{\text{can,ave}}}{R_{\text{conv,o}}} = \frac{(25 - 9.5)^\circ\text{C}}{6.004 \text{ °C/W}} = 2.58 \text{ W}$$

The ratio of bottom to the side surface areas is $(\pi r^2)/(2\pi r L) = r/(2L) = 3/(2 \times 12.5) = 0.12$. Therefore, the effect of heat transfer through the bottom surface can be accounted for approximately by increasing the heat transfer from the side surface by 12%. Then,

$$\dot{Q}_{\text{insulated}} = \dot{Q}_{\text{side+bottom}} + \dot{Q}_{\text{top}} = 1.12 \times 2.58 + 0.44 = 3.33 \text{ W}$$

Then the time of heating becomes

$$\Delta t = \frac{Q}{\dot{Q}} = \frac{16,250 \text{ J}}{3.33 \text{ J/s}} = 4880 \text{ s} = \mathbf{81.3 \text{ min}}$$

Discussion The thermal contact resistance did not have any effect on heat transfer.

3-79E A steam pipe covered with 2-in thick fiberglass insulation is subjected to convection on its surfaces. The rate of heat loss from the steam per unit length and the error involved in neglecting the thermal resistance of the steel pipe in calculations are to be determined.

Assumptions **1** Heat transfer is steady since there is no indication of any change with time. **2** Heat transfer is one-dimensional since there is thermal symmetry about the center line and no variation in the axial direction. **3** Thermal conductivities are constant. **4** The thermal contact resistance at the interface is negligible.

Properties The thermal conductivities are given to be $k = 8.7 \text{ Btu/h}\cdot\text{ft}\cdot^\circ\text{F}$ for steel and $k = 0.020 \text{ Btu/h}\cdot\text{ft}\cdot^\circ\text{F}$ for fiberglass insulation.

Analysis The inner and outer surface areas of the insulated pipe are

$$A_i = \pi D_i L = \pi(3.5/12 \text{ ft})(1 \text{ ft}) = 0.916 \text{ ft}^2$$

$$A_o = \pi D_o L = \pi(8/12 \text{ ft})(1 \text{ ft}) = 2.094 \text{ ft}^2$$

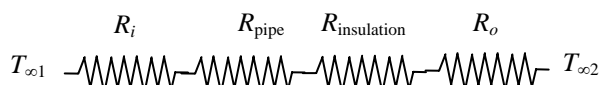

The individual resistances are

$$R_i = \frac{1}{h_i A_i} = \frac{1}{(30 \text{ Btu/h}\cdot\text{ft}^2\cdot^\circ\text{F})(0.916 \text{ ft}^2)} = 0.036 \text{ h}\cdot^\circ\text{F/Btu}$$

$$R_1 = R_{\text{pipe}} = \frac{\ln(r_2 / r_1)}{2\pi k_1 L} = \frac{\ln(2/1.75)}{2\pi(8.7 \text{ Btu/h}\cdot\text{ft}\cdot^\circ\text{F})(1 \text{ ft})} = 0.002 \text{ h}\cdot^\circ\text{F/Btu}$$

$$R_2 = R_{\text{insulation}} = \frac{\ln(r_3 / r_2)}{2\pi k_2 L} = \frac{\ln(4/2)}{2\pi(0.020 \text{ Btu/h}\cdot\text{ft}\cdot^\circ\text{F})(1 \text{ ft})} = 5.516 \text{ h}\cdot^\circ\text{F/Btu}$$

$$R_o = \frac{1}{h_o A_o} = \frac{1}{(5 \text{ Btu/h}\cdot\text{ft}^2\cdot^\circ\text{F})(2.094 \text{ ft}^2)} = 0.096 \text{ h}\cdot^\circ\text{F/Btu}$$

$$R_{\text{total}} = R_i + R_1 + R_2 + R_o = 0.036 + 0.002 + 5.516 + 0.096 = 5.65 \text{ h}\cdot^\circ\text{F/Btu}$$

Then the steady rate of heat loss from the steam per ft. pipe length becomes

$$\dot{Q} = \frac{T_{\infty 1} - T_{\infty 2}}{R_{\text{total}}} = \frac{(450 - 55)^\circ\text{F}}{5.65 \text{ h}\cdot^\circ\text{F/Btu}} = \mathbf{69.91 \text{ Btu/h}}$$

If the thermal resistance of the steel pipe is neglected, the new value of total thermal resistance will be

$$R_{\text{total}} = R_i + R_2 + R_o = 0.036 + 5.516 + 0.096 = 5.648 \text{ h}\cdot^\circ\text{F/Btu}$$

Then the percentage error involved in calculations becomes

$$\text{error}\% = \frac{(5.65 - 5.648) \text{ h}\cdot^\circ\text{F/Btu}}{5.65 \text{ h}\cdot^\circ\text{F/Btu}} \times 100 = \mathbf{0.035\%}$$

which is insignificant.

3-80 Hot water is flowing through a 15-m section of a cast iron pipe. The pipe is exposed to cold air and surfaces in the basement. The rate of heat loss from the hot water and the average velocity of the water in the pipe as it passes through the basement are to be determined.

Assumptions **1** Heat transfer is steady since there is no indication of any change with time. **2** Heat transfer is one-dimensional since there is thermal symmetry about the center line and no variation in the axial direction. **3** Thermal properties are constant.

Properties The thermal conductivity and emissivity of cast iron are given to be $k = 52 \text{ W/m}\cdot\text{°C}$ and $\varepsilon = 0.7$.

Analysis The individual resistances are

$$A_i = \pi D_i L = \pi(0.04 \text{ m})(15 \text{ m}) = 1.885 \text{ m}^2$$

$$A_o = \pi D_o L = \pi(0.046 \text{ m})(15 \text{ m}) = 2.168 \text{ m}^2$$

$$R_i = \frac{1}{h_i A_i} = \frac{1}{(120 \text{ W/m}^2\cdot\text{°C})(1.885 \text{ m}^2)} = 0.00442 \text{ °C/W}$$

$$R_{\text{pipe}} = \frac{\ln(r_2 / r_1)}{2\pi k_1 L} = \frac{\ln(2.3 / 2)}{2\pi(52 \text{ W/m}\cdot\text{°C})(15 \text{ m})} = 0.00003 \text{ °C/W}$$

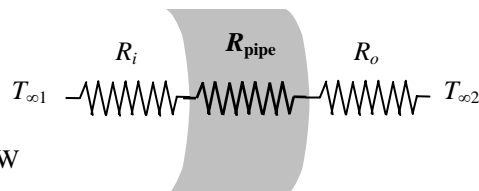

The outer surface temperature of the pipe will be somewhat below the water temperature. Assuming the outer surface temperature of the pipe to be 60°C (we will check this assumption later), the radiation heat transfer coefficient is determined to be

$$h_{\text{rad}} = \varepsilon\sigma(T_2^2 + T_{\text{surr}}^2)(T_2 + T_{\text{surr}}) \\ = (0.7)(5.67 \times 10^{-8} \text{ W/m}^2\cdot\text{K}^4)[(333 \text{ K})^2 + (283 \text{ K})^2](333 + 283) = 4.67 \text{ W/m}^2\cdot\text{K}$$

Since the surrounding medium and surfaces are at the same temperature, the radiation and convection heat transfer coefficients can be added and the result can be taken as the combined heat transfer coefficient. Then,

$$h_{\text{combined}} = h_{\text{rad}} + h_{\text{conv},2} = 4.67 + 15 = 19.67 \text{ W/m}^2\cdot\text{°C}$$

$$R_o = \frac{1}{h_{\text{combined}} A_o} = \frac{1}{(19.67 \text{ W/m}^2\cdot\text{°C})(2.168 \text{ m}^2)} = 0.02345 \text{ °C/W}$$

$$R_{\text{total}} = R_i + R_{\text{pipe}} + R_o = 0.00442 + 0.00003 + 0.02345 = 0.0279 \text{ °C/W}$$

The rate of heat loss from the hot water pipe then becomes

$$\dot{Q} = \frac{T_{\infty 1} - T_{\infty 2}}{R_{\text{total}}} = \frac{(70 - 10)^\circ\text{C}}{0.0279 \text{ °C/W}} = \mathbf{2151 \text{ W}}$$

For a temperature drop of 3°C , the mass flow rate of water and the average velocity of water must be

$$\dot{Q} = \dot{m} c_p \Delta T \longrightarrow \dot{m} = \frac{\dot{Q}}{c_p \Delta T} = \frac{2151 \text{ J/s}}{(4180 \text{ J/kg}\cdot\text{°C})(3^\circ\text{C})} = 0.172 \text{ kg/s}$$

$$\dot{m} = \rho V A_c \longrightarrow V = \frac{\dot{m}}{\rho A_c} = \frac{0.172 \text{ kg/s}}{(1000 \text{ kg/m}^3) \frac{\pi(0.04 \text{ m})^2}{4}} = \mathbf{0.136 \text{ m/s}}$$

Discussion The outer surface temperature of the pipe is

$$\dot{Q} = \frac{T_{\infty 1} - T_s}{R_i + R_{\text{pipe}}} \rightarrow 2151 \text{ W} = \frac{(70 - T_s)^\circ\text{C}}{(0.00442 + 0.00003)^\circ\text{C/W}} \rightarrow T_s = 60.4^\circ\text{C}$$

which is very close to the value assumed for the surface temperature in the evaluation of the radiation resistance. Therefore, there is no need to repeat the calculations.

3-81 Hot water is flowing through a 15 m section of a copper pipe. The pipe is exposed to cold air and surfaces in the basement. The rate of heat loss from the hot water and the average velocity of the water in the pipe as it passes through the basement are to be determined.

Assumptions **1** Heat transfer is steady since there is no indication of any change with time. **2** Heat transfer is one-dimensional since there is thermal symmetry about the centerline and no variation in the axial direction. **3** Thermal properties are constant.

Properties The thermal conductivity and emissivity of copper are given to be $k = 386 \text{ W/m}\cdot\text{°C}$ and $\varepsilon = 0.7$.

Analysis The individual resistances are

$$A_i = \pi D_i L = \pi(0.04 \text{ m})(15 \text{ m}) = 1.885 \text{ m}^2$$

$$A_o = \pi D_o L = \pi(0.046 \text{ m})(15 \text{ m}) = 2.168 \text{ m}^2$$

$$R_i = \frac{1}{h_i A_i} = \frac{1}{(120 \text{ W/m}^2\cdot\text{°C})(1.885 \text{ m}^2)} = 0.00442 \text{ °C/W}$$

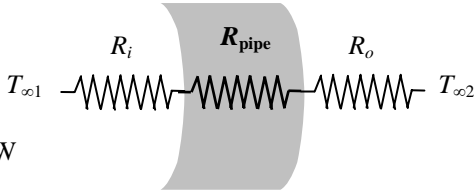
$$R_{\text{pipe}} = \frac{\ln(r_2 / r_1)}{2\pi k L} = \frac{\ln(2.3 / 2)}{2\pi(386 \text{ W/m}\cdot\text{°C})(15 \text{ m})} = 0.0000038 \text{ °C/W}$$

The outer surface temperature of the pipe will be somewhat below the water temperature. Assuming the outer surface temperature of the pipe to be 60°C (we will check this assumption later), the radiation heat transfer coefficient is determined to be

$$h_{\text{rad}} = \varepsilon \sigma (T_2^2 + T_{\text{surr}}^2)(T_2 + T_{\text{surr}})$$

$$= (0.7)(5.67 \times 10^{-8} \text{ W/m}^2\cdot\text{K}^4)[(333 \text{ K})^2 + (283 \text{ K})^2](333 + 283) = 4.67 \text{ W/m}^2\cdot\text{K}$$

Since the surrounding medium and surfaces are at the same temperature, the radiation and convection heat transfer coefficients can be added and the result can be taken as the combined heat transfer coefficient.

Then,

$$h_{\text{combined}} = h_{\text{rad}} + h_{\text{conv},2} = 4.67 + 15 = 19.67 \text{ W/m}^2\cdot\text{°C}$$

$$R_o = \frac{1}{h_{\text{combined}} A_o} = \frac{1}{(19.67 \text{ W/m}^2\cdot\text{°C})(2.168 \text{ m}^2)} = 0.02345 \text{ °C/W}$$

$$R_{\text{total}} = R_i + R_{\text{pipe}} + R_o = 0.00442 + 0.0000038 + 0.02345 = 0.02787 \text{ °C/W}$$

The rate of heat loss from the hot water pipe then becomes

$$\dot{Q} = \frac{T_{\infty 1} - T_{\infty 2}}{R_{\text{total}}} = \frac{(70 - 10)^\circ\text{C}}{0.02787 \text{ °C/W}} = \mathbf{2153 \text{ W}}$$

For a temperature drop of 3°C , the mass flow rate of water and the average velocity of water must be

$$\dot{Q} = \dot{m} c_p \Delta T \longrightarrow \dot{m} = \frac{\dot{Q}}{c_p \Delta T} = \frac{21534 \text{ J/s}}{(4180 \text{ J/kg}\cdot\text{°C})(3^\circ\text{C})} = 0.172 \text{ kg/s}$$

$$\dot{m} = \rho V A_c \longrightarrow V = \frac{\dot{m}}{\rho A_c} = \frac{0.186 \text{ kg/s}}{(1000 \text{ kg/m}^3) \frac{\pi(0.04 \text{ m})^2}{4}} = \mathbf{0.137 \text{ m/s}}$$

Discussion The outer surface temperature of the pipe is

$$\dot{Q} = \frac{T_{\infty 1} - T_s}{R_i + R_{\text{pipe}}} \rightarrow 2153 \text{ W} = \frac{(70 - T_s)^\circ\text{C}}{(0.00442 + 0.0000038)^\circ\text{C/W}} \rightarrow T_s = 60.5^\circ\text{C}$$

which is very close to the value assumed for the surface temperature in the evaluation of the radiation resistance. Therefore, there is no need to repeat the calculations.

3-82E Steam exiting the turbine of a steam power plant at 100°F is to be condensed in a large condenser by cooling water flowing through copper tubes. For specified heat transfer coefficients, the length of the tube required to condense steam at a rate of 120 lbm/h is to be determined.

Assumptions **1** Heat transfer is steady since there is no indication of any change with time. **2** Heat transfer is one-dimensional since there is thermal symmetry about the center line and no variation in the axial direction. **3** Thermal properties are constant. **4** Heat transfer coefficients are constant and uniform over the surfaces.

Properties The thermal conductivity of copper tube is given to be $k = 223 \text{ Btu/h}\cdot\text{ft}\cdot^\circ\text{F}$. The heat of vaporization of water at 100°F is given to be 1037 Btu/lbm.

Analysis The individual resistances are

$$A_i = \pi D_i L = \pi(0.4/12 \text{ ft})(1 \text{ ft}) = 0.105 \text{ ft}^2$$

$$A_o = \pi D_o L = \pi(0.6/12 \text{ ft})(1 \text{ ft}) = 0.157 \text{ ft}^2$$

$$R_i = \frac{1}{h_i A_i} = \frac{1}{(35 \text{ Btu/h}\cdot\text{ft}^2\cdot^\circ\text{F})(0.105 \text{ ft}^2)} = 0.27211 \text{ h}^\circ\text{F/Btu}$$

$$R_{\text{pipe}} = \frac{\ln(r_2/r_1)}{2\pi k L} = \frac{\ln(3/2)}{2\pi(223 \text{ Btu/h}\cdot\text{ft}\cdot^\circ\text{F})(1 \text{ ft})} = 0.00029 \text{ h}^\circ\text{F/Btu}$$

$$R_o = \frac{1}{h_o A_o} = \frac{1}{(1500 \text{ Btu/h}\cdot\text{ft}^2\cdot^\circ\text{F})(0.157 \text{ ft}^2)} = 0.00425 \text{ h}^\circ\text{F/Btu}$$

$$R_{\text{total}} = R_i + R_{\text{pipe}} + R_o = 0.27211 + 0.00029 + 0.00425 = 0.27665 \text{ h}^\circ\text{F/Btu}$$

The heat transfer rate per ft length of the tube is

$$\dot{Q} = \frac{T_{\infty 1} - T_{\infty 2}}{R_{\text{total}}} = \frac{(100 - 70)^\circ\text{F}}{0.27665 \text{ h}^\circ\text{F/Btu}} = 108.44 \text{ Btu/h}$$

The total rate of heat transfer required to condense steam at a rate of 120 lbm/h and the length of the tube required is determined to be

$$\dot{Q}_{\text{total}} = \dot{m} h_{fg} = (120 \text{ lbm/h})(1037 \text{ Btu/lbm}) = 124,440 \text{ Btu/h}$$

$$\text{Tube length} = \frac{\dot{Q}_{\text{total}}}{\dot{Q}} = \frac{124,440}{108.44} = \mathbf{1148 \text{ ft}}$$

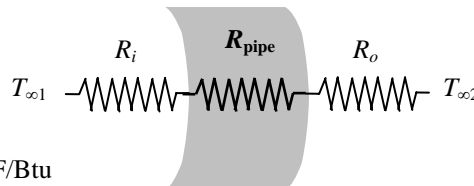

3-83E Steam exiting the turbine of a steam power plant at 100°F is to be condensed in a large condenser by cooling water flowing through copper tubes. For specified heat transfer coefficients and 0.01-in thick scale build up on the inner surface, the length of the tube required to condense steam at a rate of 120 lbm/h is to be determined.

Assumptions **1** Heat transfer is steady since there is no indication of any change with time. **2** Heat transfer is one-dimensional since there is thermal symmetry about the centerline and no variation in the axial direction. **3** Thermal properties are constant. **4** Heat transfer coefficients are constant and uniform over the surfaces.

Properties The thermal conductivities are given to be $k = 223 \text{ Btu/h}\cdot\text{ft}\cdot^\circ\text{F}$ for copper tube and be $k = 0.5 \text{ Btu/h}\cdot\text{ft}\cdot^\circ\text{F}$ for the mineral deposit. The heat of vaporization of water at 100°F is given to be 1037 Btu/lbm.

Analysis When a 0.01-in thick layer of deposit forms on the inner surface of the pipe, the inner diameter of the pipe will reduce from 0.4 in to 0.38 in. The individual thermal resistances are



$$A_i = \pi D_i L = \pi(0.38/12 \text{ ft})(1 \text{ ft}) = 0.099 \text{ ft}^2$$

$$A_o = \pi D_o L = \pi(0.6/12 \text{ ft})(1 \text{ ft}) = 0.157 \text{ ft}^2$$

$$R_i = \frac{1}{h_i A_i} = \frac{1}{(35 \text{ Btu/h}\cdot\text{ft}^2\cdot^\circ\text{F})(0.099 \text{ ft}^2)} = 0.2886 \text{ h}^\circ\text{F/Btu}$$

$$R_{\text{pipe}} = \frac{\ln(r_2/r_1)}{2\pi k L} = \frac{\ln(3/2)}{2\pi(223 \text{ Btu/h}\cdot\text{ft}\cdot^\circ\text{F})(1 \text{ ft})} = 0.00029 \text{ h}^\circ\text{F/Btu}$$

$$R_{\text{deposit}} = \frac{\ln(r_1/r_{\text{dep}})}{2\pi k_2 L} = \frac{\ln(0.2/0.19)}{2\pi(0.5 \text{ Btu/h}\cdot\text{ft}\cdot^\circ\text{F})(1 \text{ ft})} = 0.01633 \text{ h}^\circ\text{F/Btu}$$

$$R_o = \frac{1}{h_o A_o} = \frac{1}{(1500 \text{ Btu/h}\cdot\text{ft}^2\cdot^\circ\text{F})(0.157 \text{ ft}^2)} = 0.00425 \text{ h}^\circ\text{F/Btu}$$

$$R_{\text{total}} = R_i + R_{\text{pipe}} + R_{\text{deposit}} + R_o = 0.2886 + 0.00029 + 0.01633 + 0.00425 = 0.3095 \text{ h}^\circ\text{F/Btu}$$

The heat transfer rate per ft length of the tube is

$$\dot{Q} = \frac{T_{\infty 1} - T_{\infty 2}}{R_{\text{total}}} = \frac{(100 - 70)^\circ\text{F}}{0.3095 \text{ h}^\circ\text{F/Btu}} = 96.9 \text{ Btu/h}$$

The total rate of heat transfer required to condense steam at a rate of 120 lbm/h and the length of the tube required can be determined to be

$$\dot{Q}_{\text{total}} = \dot{m} h_{fg} = (120 \text{ lbm/h})(1037 \text{ Btu/lbm}) = 124,440 \text{ Btu/h}$$

$$\text{Tube length} = \frac{\dot{Q}_{\text{total}}}{\dot{Q}} = \frac{124,440}{96.9} = \mathbf{1284 \text{ ft}}$$

3-84E EES Prob. 3-82E is reconsidered. The effects of the thermal conductivity of the pipe material and the outer diameter of the pipe on the length of the tube required are to be investigated.

Analysis The problem is solved using EES, and the solution is given below.

"GIVEN"

T_infinity_1=100 [F]
 T_infinity_2=70 [F]
 k_pipe=223 [Btu/h-ft-F]
 D_i=0.4 [in]
 D_o=0.6 [in]
 r_1=D_i/2
 r_2=D_o/2
 h_fg=1037 [Btu/lbm]
 h_o=1500 [Btu/h-ft^2-F]
 h_i=35 [Btu/h-ft^2-F]
 m_dot=120 [lbm/h]

"ANALYSIS"

L=1 "[ft], for 1 ft length of the tube"
 A_i=pi*(D_i*Convert(in, ft))*L
 A_o=pi*(D_o*Convert(in, ft))*L
 R_conv_i=1/(h_i*A_i)
 R_pipe=ln(r_2/r_1)/(2*pi*k_pipe*L)
 R_conv_o=1/(h_o*A_o)
 R_total=R_conv_i+R_pipe+R_conv_o
 Q_dot=(T_infinity_1-T_infinity_2)/R_total
 Q_dot_total=m_dot*h_fg
 L_tube=Q_dot_total/Q_dot

k_{pipe} [Btu/h.ft.F]	L_{tube} [ft]
10	1176
30.53	1158
51.05	1155
71.58	1153
92.11	1152
112.6	1152
133.2	1151
153.7	1151
174.2	1151
194.7	1151
215.3	1151
235.8	1150
256.3	1150
276.8	1150
297.4	1150
317.9	1150
338.4	1150
358.9	1150
379.5	1150
400	1150

D_o [in]	L_{tube} [ft]
0.5	1154
0.525	1153
0.55	1152
0.575	1151
0.6	1151
0.625	1150
0.65	1149
0.675	1149
0.7	1148
0.725	1148
0.75	1148
0.775	1147
0.8	1147
0.825	1147
0.85	1146
0.875	1146
0.9	1146
0.925	1146
0.95	1145
0.975	1145
1	1145

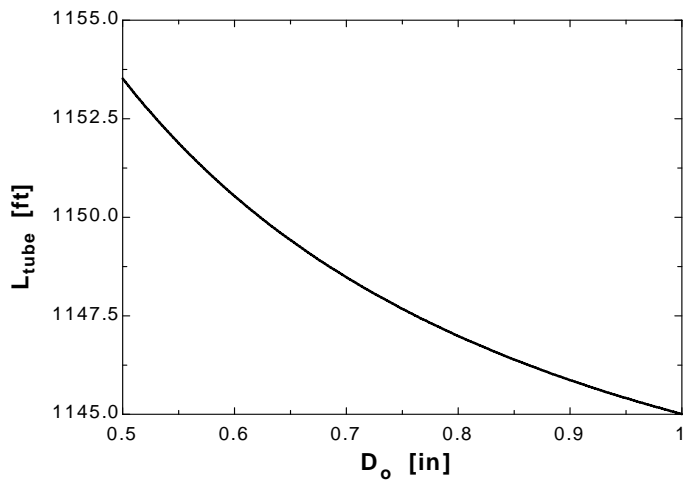
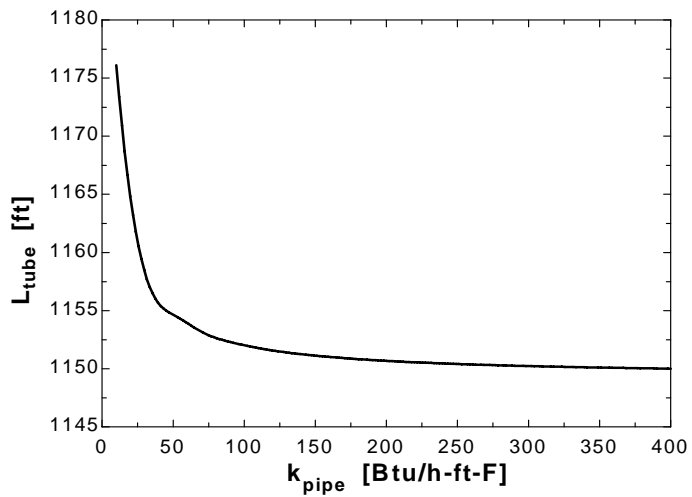

3-85 A spherical tank filled with liquid nitrogen at 1 atm and -196°C is exposed to convection and radiation with the surrounding air and surfaces. The rate of evaporation of liquid nitrogen in the tank as a result of the heat gain from the surroundings for the cases of no insulation, 5-cm thick fiberglass insulation, and 2-cm thick superinsulation are to be determined.

Assumptions 1 Heat transfer is steady since the specified thermal conditions at the boundaries do not change with time. **2** Heat transfer is one-dimensional since there is thermal symmetry about the midpoint. **3** The combined heat transfer coefficient is constant and uniform over the entire surface. **4** The temperature of the thin-shelled spherical tank is said to be nearly equal to the temperature of the nitrogen inside, and thus thermal resistance of the tank and the internal convection resistance are negligible.

Properties The heat of vaporization and density of liquid nitrogen at 1 atm are given to be 198 kJ/kg and 810 kg/m^3 , respectively. The thermal conductivities are given to be $k = 0.035\text{ W/m}\cdot^{\circ}\text{C}$ for fiberglass insulation and $k = 0.00005\text{ W/m}\cdot^{\circ}\text{C}$ for super insulation.

Analysis (a) The heat transfer rate and the rate of evaporation of the liquid without insulation are

$$A = \pi D^2 = \pi(3\text{ m})^2 = 28.27\text{ m}^2$$

$$R_o = \frac{1}{h_o A} = \frac{1}{(35\text{ W/m}^2\cdot^{\circ}\text{C})(28.27\text{ m}^2)} = 0.00101\text{ }^{\circ}\text{C/W}$$

$$\dot{Q} = \frac{T_{s1} - T_{\infty 2}}{R_o} = \frac{[15 - (-196)]^{\circ}\text{C}}{0.00101\text{ }^{\circ}\text{C/W}} = 208,910\text{ W}$$

$$\dot{Q} = \dot{m}h_{fg} \longrightarrow \dot{m} = \frac{\dot{Q}}{h_{fg}} = \frac{208.910\text{ kJ/s}}{198\text{ kJ/kg}} = \mathbf{1.055\text{ kg/s}}$$

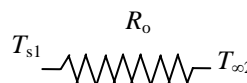

(b) The heat transfer rate and the rate of evaporation of the liquid with a 5-cm thick layer of fiberglass insulation are

$$A = \pi D^2 = \pi(3.1\text{ m})^2 = 30.19\text{ m}^2$$

$$R_o = \frac{1}{h_o A} = \frac{1}{(35\text{ W/m}^2\cdot^{\circ}\text{C})(30.19\text{ m}^2)} = 0.000946\text{ }^{\circ}\text{C/W}$$

$$R_{insulation} = \frac{r_2 - r_1}{4\pi k r_1 r_2} = \frac{(1.55 - 1.5)\text{ m}}{4\pi(0.035\text{ W/m}\cdot^{\circ}\text{C})(1.55\text{ m})(1.5\text{ m})} = 0.0489\text{ }^{\circ}\text{C/W}$$

$$R_{total} = R_o + R_{insulation} = 0.000946 + 0.0489 = 0.0498\text{ }^{\circ}\text{C/W}$$

$$\dot{Q} = \frac{T_{s1} - T_{\infty 2}}{R_{total}} = \frac{[15 - (-196)]^{\circ}\text{C}}{0.0498\text{ }^{\circ}\text{C/W}} = 4233\text{ W}$$

$$\dot{Q} = \dot{m}h_{fg} \longrightarrow \dot{m} = \frac{\dot{Q}}{h_{fg}} = \frac{4.233\text{ kJ/s}}{198\text{ kJ/kg}} = \mathbf{0.0214\text{ kg/s}}$$

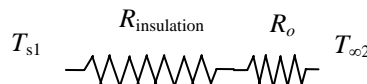

(c) The heat transfer rate and the rate of evaporation of the liquid with 2-cm thick layer of superinsulation is

$$A = \pi D^2 = \pi(3.04\text{ m})^2 = 29.03\text{ m}^2$$

$$R_o = \frac{1}{h_o A} = \frac{1}{(35\text{ W/m}^2\cdot^{\circ}\text{C})(29.03\text{ m}^2)} = 0.000984\text{ }^{\circ}\text{C/W}$$

$$R_{insulation} = \frac{r_2 - r_1}{4\pi k r_1 r_2} = \frac{(1.52 - 1.5)\text{ m}}{4\pi(0.00005\text{ W/m}\cdot^{\circ}\text{C})(1.52\text{ m})(1.5\text{ m})} = 13.96\text{ }^{\circ}\text{C/W}$$

$$R_{total} = R_o + R_{insulation} = 0.000984 + 13.96 = 13.96\text{ }^{\circ}\text{C/W}$$

$$\dot{Q} = \frac{T_{s1} - T_{\infty 2}}{R_{total}} = \frac{[15 - (-196)]^{\circ}\text{C}}{13.96\text{ }^{\circ}\text{C/W}} = 15.11\text{ W}$$

$$\dot{Q} = \dot{m}h_{fg} \longrightarrow \dot{m} = \frac{\dot{Q}}{h_{fg}} = \frac{0.01511\text{ kJ/s}}{198\text{ kJ/kg}} = \mathbf{0.000076\text{ kg/s}}$$

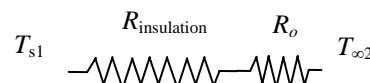

3-86 A spherical tank filled with liquid oxygen at 1 atm and -183°C is exposed to convection and radiation with the surrounding air and surfaces. The rate of evaporation of liquid oxygen in the tank as a result of the heat gain from the surroundings for the cases of no insulation, 5-cm thick fiberglass insulation, and 2-cm thick superinsulation are to be determined.

Assumptions 1 Heat transfer is steady since the specified thermal conditions at the boundaries do not change with time. **2** Heat transfer is one-dimensional since there is thermal symmetry about the midpoint. **3** The combined heat transfer coefficient is constant and uniform over the entire surface. **4** The temperature of the thin-shelled spherical tank is said to be nearly equal to the temperature of the oxygen inside, and thus thermal resistance of the tank and the internal convection resistance are negligible.

Properties The heat of vaporization and density of liquid oxygen at 1 atm are given to be 213 kJ/kg and 1140 kg/m^3 , respectively. The thermal conductivities are given to be $k = 0.035\text{ W/m}\cdot^{\circ}\text{C}$ for fiberglass insulation and $k = 0.00005\text{ W/m}\cdot^{\circ}\text{C}$ for super insulation.

Analysis (a) The heat transfer rate and the rate of evaporation of the liquid without insulation are

$$A = \pi D^2 = \pi(3\text{ m})^2 = 28.27\text{ m}^2$$

$$R_o = \frac{1}{h_o A} = \frac{1}{(35\text{ W/m}^2\cdot^{\circ}\text{C})(28.27\text{ m}^2)} = 0.00101\text{ }^{\circ}\text{C/W}$$

$$\dot{Q} = \frac{T_{s1} - T_{\infty 2}}{R_o} = \frac{[15 - (-183)]^{\circ}\text{C}}{0.00101\text{ }^{\circ}\text{C/W}} = 196,040\text{ W}$$

$$\dot{Q} = \dot{m}h_{fg} \longrightarrow \dot{m} = \frac{\dot{Q}}{h_{fg}} = \frac{196.040\text{ kJ/s}}{213\text{ kJ/kg}} = \mathbf{0.920\text{ kg/s}}$$

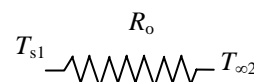

(b) The heat transfer rate and the rate of evaporation of the liquid with a 5-cm thick layer of fiberglass insulation are

$$A = \pi D^2 = \pi(3.1\text{ m})^2 = 30.19\text{ m}^2$$

$$R_o = \frac{1}{h_o A} = \frac{1}{(35\text{ W/m}^2\cdot^{\circ}\text{C})(30.19\text{ m}^2)} = 0.000946\text{ }^{\circ}\text{C/W}$$

$$R_{insulation} = \frac{r_2 - r_1}{4\pi k r_1 r_2} = \frac{(1.55 - 1.5)\text{ m}}{4\pi(0.035\text{ W/m}\cdot^{\circ}\text{C})(1.55\text{ m})(1.5\text{ m})} = 0.0489\text{ }^{\circ}\text{C/W}$$

$$R_{total} = R_o + R_{insulation} = 0.000946 + 0.0489 = 0.0498\text{ }^{\circ}\text{C/W}$$

$$\dot{Q} = \frac{T_{s1} - T_{\infty 2}}{R_{total}} = \frac{[15 - (-183)]^{\circ}\text{C}}{0.0498\text{ }^{\circ}\text{C/W}} = 3976\text{ W}$$

$$\dot{Q} = \dot{m}h_{fg} \longrightarrow \dot{m} = \frac{\dot{Q}}{h_{fg}} = \frac{3.976\text{ kJ/s}}{213\text{ kJ/kg}} = \mathbf{0.0187\text{ kg/s}}$$

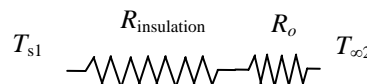

(c) The heat transfer rate and the rate of evaporation of the liquid with a 2-cm superinsulation is

$$A = \pi D^2 = \pi(3.04\text{ m})^2 = 29.03\text{ m}^2$$

$$R_o = \frac{1}{h_o A} = \frac{1}{(35\text{ W/m}^2\cdot^{\circ}\text{C})(29.03\text{ m}^2)} = 0.000984\text{ }^{\circ}\text{C/W}$$

$$R_{insulation} = \frac{r_2 - r_1}{4\pi k r_1 r_2} = \frac{(1.52 - 1.5)\text{ m}}{4\pi(0.00005\text{ W/m}\cdot^{\circ}\text{C})(1.52\text{ m})(1.5\text{ m})} = 13.96\text{ }^{\circ}\text{C/W}$$

$$R_{total} = R_o + R_{insulation} = 0.000984 + 13.96 = 13.96\text{ }^{\circ}\text{C/W}$$

$$\dot{Q} = \frac{T_{s1} - T_{\infty 2}}{R_{total}} = \frac{[15 - (-183)]^{\circ}\text{C}}{13.96\text{ }^{\circ}\text{C/W}} = 14.18\text{ W}$$

$$\dot{Q} = \dot{m}h_{fg} \longrightarrow \dot{m} = \frac{\dot{Q}}{h_{fg}} = \frac{0.01418\text{ kJ/s}}{213\text{ kJ/kg}} = \mathbf{0.000067\text{ kg/s}}$$

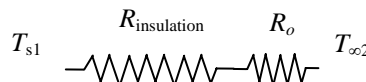

Critical Radius of Insulation

3-87C In a cylindrical pipe or a spherical shell, the additional insulation increases the conduction resistance of insulation, but decreases the convection resistance of the surface because of the increase in the outer surface area. Due to these opposite effects, a critical radius of insulation is defined as the outer radius that provides maximum rate of heat transfer. For a cylindrical layer, it is defined as $r_{cr} = k/h$ where k is the thermal conductivity of insulation and h is the external convection heat transfer coefficient.

3-88C It will decrease.

3-89C Yes, the measurements can be right. If the radius of insulation is less than critical radius of insulation of the pipe, the rate of heat loss will increase.

3-90C No.

3-91C For a cylindrical pipe, the critical radius of insulation is defined as $r_{cr} = k/h$. On windy days, the external convection heat transfer coefficient is greater compared to calm days. Therefore critical radius of insulation will be greater on calm days.

3-92 An electric wire is tightly wrapped with a 1-mm thick plastic cover. The interface temperature and the effect of doubling the thickness of the plastic cover on the interface temperature are to be determined.

Assumptions **1** Heat transfer is steady since there is no indication of any change with time. **2** Heat transfer is one-dimensional since there is thermal symmetry about the centerline and no variation in the axial direction. **3** Thermal properties are constant. **4** The thermal contact resistance at the interface is negligible. **5** Heat transfer coefficient accounts for the radiation effects, if any.

Properties The thermal conductivity of plastic cover is given to be $k = 0.15 \text{ W/m}\cdot^\circ\text{C}$.

Analysis In steady operation, the rate of heat transfer from the wire is equal to the heat generated within the wire,

$$\dot{Q} = \dot{W}_e = VI = (8 \text{ V})(13 \text{ A}) = 104 \text{ W}$$

The total thermal resistance is

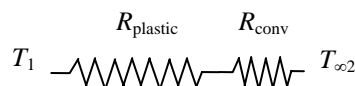

$$R_{\text{conv}} = \frac{1}{h_o A_o} = \frac{1}{(24 \text{ W/m}^2 \cdot ^\circ\text{C})[\pi(0.0042 \text{ m})(10 \text{ m})]} = 0.3158 \text{ }^\circ\text{C/W}$$

$$R_{\text{plastic}} = \frac{\ln(r_2/r_1)}{2\pi kL} = \frac{\ln(2.1/1.1)}{2\pi(0.15 \text{ W/m}\cdot^\circ\text{C})(10 \text{ m})} = 0.0686 \text{ }^\circ\text{C/W}$$

$$R_{\text{total}} = R_{\text{conv}} + R_{\text{plastic}} = 0.3158 + 0.0686 = 0.3844 \text{ }^\circ\text{C/W}$$

Then the interface temperature becomes

$$\dot{Q} = \frac{T_1 - T_{\infty 2}}{R_{\text{total}}} \longrightarrow T_1 = T_{\infty} + \dot{Q}R_{\text{total}} = 30^\circ\text{C} + (104 \text{ W})(0.3844 \text{ }^\circ\text{C/W}) = \mathbf{70.0^\circ\text{C}}$$

The critical radius of plastic insulation is

$$r_{cr} = \frac{k}{h} = \frac{0.15 \text{ W/m}\cdot^\circ\text{C}}{24 \text{ W/m}^2 \cdot ^\circ\text{C}} = 0.00625 \text{ m} = 6.25 \text{ mm}$$

Doubling the thickness of the plastic cover will increase the outer radius of the wire to 3 mm, which is less than the critical radius of insulation. Therefore, doubling the thickness of plastic cover will increase the rate of heat loss and decrease the interface temperature.

3-93E An electrical wire is covered with 0.02-in thick plastic insulation. It is to be determined if the plastic insulation on the wire will increase or decrease heat transfer from the wire.

Assumptions **1** Heat transfer from the wire is steady since there is no indication of any change with time. **2** Heat transfer is one-dimensional since there is thermal symmetry about the centerline and no variation in the axial direction. **3** Thermal properties are constant. **4** The thermal contact resistance at the interface is negligible.

Properties The thermal conductivity of plastic cover is given to be $k = 0.075 \text{ Btu/h}\cdot\text{ft}\cdot^\circ\text{F}$.

Analysis The critical radius of plastic insulation is

$$r_{cr} = \frac{k}{h} = \frac{0.075 \text{ Btu/h}\cdot\text{ft}\cdot^\circ\text{F}}{2.5 \text{ Btu/h}\cdot\text{ft}^2\cdot^\circ\text{F}} = 0.03 \text{ ft} = 0.36 \text{ in} > r_2 (= 0.0615 \text{ in})$$

Since the outer radius of the wire with insulation is smaller than critical radius of insulation, plastic insulation will **increase** heat transfer from the wire.

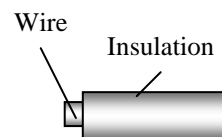

3-94E An electrical wire is covered with 0.02-in thick plastic insulation. By considering the effect of thermal contact resistance, it is to be determined if the plastic insulation on the wire will increase or decrease heat transfer from the wire.

Assumptions **1** Heat transfer from the wire is steady since there is no indication of any change with time. **2** Heat transfer is one-dimensional since there is thermal symmetry about the centerline and no variation in the axial direction. **3** Thermal properties are constant

Properties The thermal conductivity of plastic cover is given to be $k = 0.075 \text{ Btu/h}\cdot\text{ft}\cdot^\circ\text{F}$.

Analysis Without insulation, the total thermal resistance is (per ft length of the wire)

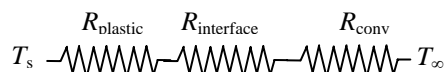

$$R_{tot} = R_{conv} = \frac{1}{h_o A_o} = \frac{1}{(2.5 \text{ Btu/h}\cdot\text{ft}^2\cdot^\circ\text{F})[\pi(0.083/12 \text{ ft})(1 \text{ ft})]} = 18.4 \text{ h}\cdot^\circ\text{F/Btu}$$

With insulation, the total thermal resistance is

$$R_{conv} = \frac{1}{h_o A_o} = \frac{1}{(2.5 \text{ Btu/h}\cdot\text{ft}^2\cdot^\circ\text{F})[\pi(0.123/12 \text{ ft})(1 \text{ ft})]} = 12.42 \text{ h}\cdot^\circ\text{F/Btu}$$

$$R_{plastic} = \frac{\ln(r_2/r_1)}{2\pi k L} = \frac{\ln(0.123/0.083)}{2\pi(0.075 \text{ Btu/h}\cdot\text{ft}\cdot^\circ\text{F})(1 \text{ ft})} = 0.835 \text{ h}\cdot^\circ\text{F/Btu}$$

$$R_{interface} = \frac{h_c}{A_c} = \frac{0.001 \text{ h}\cdot\text{ft}^2\cdot^\circ\text{F/Btu}}{[\pi(0.083/12 \text{ ft})(1 \text{ ft})]} = 0.046 \text{ h}\cdot^\circ\text{F/Btu}$$

$$R_{total} = R_{conv} + R_{plastic} + R_{interface} = 12.42 + 0.835 + 0.046 = 13.30 \text{ h}\cdot^\circ\text{F/Btu}$$

Since the total thermal resistance decreases after insulation, plastic insulation **will increase** heat transfer from the wire. The thermal contact resistance appears to have negligible effect in this case.

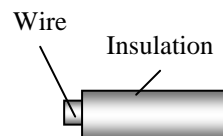

3-95 A spherical ball is covered with 1-mm thick plastic insulation. It is to be determined if the plastic insulation on the ball will increase or decrease heat transfer from it.

Assumptions **1** Heat transfer from the ball is steady since there is no indication of any change with time. **2** Heat transfer is one-dimensional since there is thermal symmetry about the midpoint. **3** Thermal properties are constant. **4** The thermal contact resistance at the interface is negligible.

Properties The thermal conductivity of plastic cover is given to be $k = 0.13 \text{ W/m}\cdot\text{°C}$.

Analysis The critical radius of plastic insulation for the spherical ball is

$$r_{cr} = \frac{2k}{h} = \frac{2(0.13 \text{ W/m}\cdot\text{°C})}{20 \text{ W/m}^2\cdot\text{°C}} = 0.013 \text{ m} = 13 \text{ mm} > r_2 (= 7 \text{ mm})$$

Since the outer radius of the ball with insulation is smaller than critical radius of insulation, plastic insulation will **increase** heat transfer from the wire.

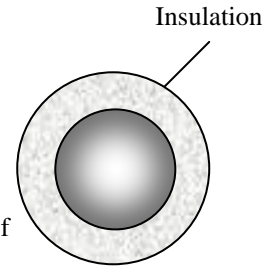

3-96 EES Prob. 3-95 is reconsidered. The rate of heat transfer from the ball as a function of the plastic insulation thickness is to be plotted.

Analysis The problem is solved using EES, and the solution is given below.

"GIVEN"

D_1=0.005 [m]
 t_ins=1 [mm]
 k_ins=0.13 [W/m-C]
 T_ball=50 [C]
 T_infinity=15 [C]
 h_o=20 [W/m^2-C]

"ANALYSIS"

D_2=D_1+2*t_ins*Convert(mm, m)
 A_o=pi*D_2^2
 R_conv_o=1/(h_o*A_o)
 R_ins=(r_2-r_1)/(4*pi*r_1*r_2*k_ins)
 r_1=D_1/2
 r_2=D_2/2
 R_total=R_conv_o+R_ins
 Q_dot=(T_ball-T_infinity)/R_total

t _{ins} [mm]	Q [W]
0.5	0.07248
1.526	0.1035
2.553	0.1252
3.579	0.139
4.605	0.1474
5.632	0.1523
6.658	0.1552
7.684	0.1569
8.711	0.1577
9.737	0.1581
10.76	0.1581
11.79	0.158
12.82	0.1578
13.84	0.1574
14.87	0.1571
15.89	0.1567
16.92	0.1563
17.95	0.1559
18.97	0.1556
20	0.1552

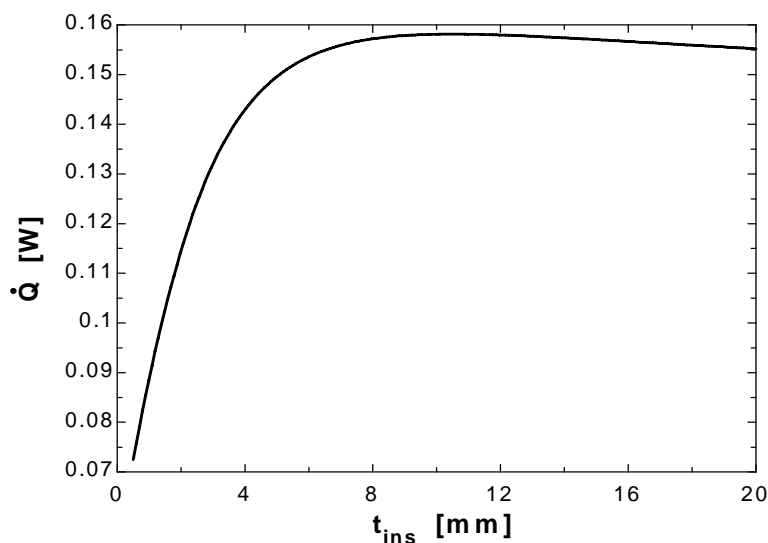

Heat Transfer from Finned Surfaces

3-97C Increasing the rate of heat transfer from a surface by increasing the heat transfer surface area.

3-98C The fin efficiency is defined as the ratio of actual heat transfer rate from the fin to the ideal heat transfer rate from the fin if the entire fin were at base temperature, and its value is between 0 and 1. Fin effectiveness is defined as the ratio of heat transfer rate from a finned surface to the heat transfer rate from the same surface if there were no fins, and its value is expected to be greater than 1.

3-99C Heat transfer rate will decrease since a fin effectiveness smaller than 1 indicates that the fin acts as insulation.

3-100C Fins enhance heat transfer from a surface by increasing heat transfer surface area for convection heat transfer. However, adding too many fins on a surface can suffocate the fluid and retard convection, and thus it may cause the overall heat transfer coefficient and heat transfer to decrease.

3-101C Effectiveness of a single fin is the ratio of the heat transfer rate from the entire exposed surface of the fin to the heat transfer rate from the fin base area. The overall effectiveness of a finned surface is defined as the ratio of the total heat transfer from the finned surface to the heat transfer from the same surface if there were no fins.

3-102C Fins should be attached on the air side since the convection heat transfer coefficient is lower on the air side than it is on the water side.

3-103C Fins should be attached to the outside since the heat transfer coefficient inside the tube will be higher due to forced convection. Fins should be added to both sides of the tubes when the convection coefficients at the inner and outer surfaces are comparable in magnitude.

3-104C Welding or tight fitting introduces thermal contact resistance at the interface, and thus retards heat transfer. Therefore, the fins formed by casting or extrusion will provide greater enhancement in heat transfer.

3-105C If the fin is too long, the temperature of the fin tip will approach the surrounding temperature and we can neglect heat transfer from the fin tip. Also, if the surface area of the fin tip is very small compared to the total surface area of the fin, heat transfer from the tip can again be neglected.

3-106C Increasing the length of a fin decreases its efficiency but increases its effectiveness.

3-107C Increasing the diameter of a fin increases its efficiency but decreases its effectiveness.

3-108C The thicker fin has higher efficiency; the thinner one has higher effectiveness.

3-109C The fin with the lower heat transfer coefficient has the higher efficiency and the higher effectiveness.

3-110 A relation is to be obtained for the fin efficiency for a fin of constant cross-sectional area A_c , perimeter p , length L , and thermal conductivity k exposed to convection to a medium at T_∞ with a heat transfer coefficient h . The relation is to be simplified for circular fin of diameter D and for a rectangular fin of thickness t .

Assumptions 1 The fins are sufficiently long so that the temperature of the fin at the tip is nearly T_∞ . 2 Heat transfer from the fin tips is negligible.

Analysis Taking the temperature of the fin at the base to be T_b and using the heat transfer relation for a long fin, fin efficiency for long fins can be expressed as

$$\eta_{\text{fin}} = \frac{\text{Actual heat transfer rate from the fin}}{\text{Ideal heat transfer rate from the fin if the entire fin were at base temperature}}$$

$$= \frac{\sqrt{hpkA_c}(T_b - T_\infty)}{hA_{\text{fin}}(T_b - T_\infty)} = \frac{\sqrt{hpkA_c}}{hpL} = \frac{1}{L} \sqrt{\frac{kA_c}{ph}}$$

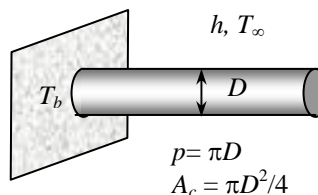

This relation can be simplified for a circular fin of diameter D and rectangular fin of thickness t and width w to be

$$\eta_{\text{fin,circular}} = \frac{1}{L} \sqrt{\frac{kA_c}{ph}} = \frac{1}{L} \sqrt{\frac{k(\pi D^2/4)}{(\pi D)h}} = \frac{1}{2L} \sqrt{\frac{kD}{h}}$$

$$\eta_{\text{fin,rectangular}} = \frac{1}{L} \sqrt{\frac{kA_c}{ph}} = \frac{1}{L} \sqrt{\frac{k(wt)}{2(w+t)h}} \cong \frac{1}{L} \sqrt{\frac{k(wt)}{2wh}} = \frac{1}{L} \sqrt{\frac{kt}{2h}}$$

3-111 The maximum power rating of a transistor whose case temperature is not to exceed 80°C is to be determined.

Assumptions 1 Steady operating conditions exist. 2 The transistor case is isothermal at 80°C .

Properties The case-to-ambient thermal resistance is given to be $20^\circ\text{C}/\text{W}$.

Analysis The maximum power at which this transistor can be operated safely is

$$\dot{Q} = \frac{\Delta T}{R_{\text{case-ambient}}} = \frac{T_{\text{case}} - T_\infty}{R_{\text{case-ambient}}} = \frac{(80 - 40)^\circ\text{C}}{25^\circ\text{C}/\text{W}} = \mathbf{1.6\text{ W}}$$

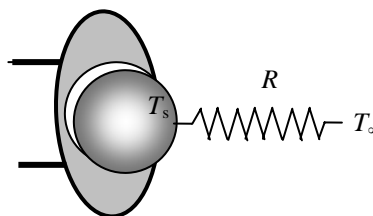

3-112 A fin is attached to a surface. The percent error in the rate of heat transfer from the fin when the infinitely long fin assumption is used instead of the adiabatic fin tip assumption is to be determined.

Assumptions 1 Steady operating conditions exist. 2 The temperature along the fins varies in one direction only (normal to the plate). 3 The heat transfer coefficient is constant and uniform over the entire fin surface. 4 The thermal properties of the fins are constant. 5 The heat transfer coefficient accounts for the effect of radiation from the fins.

Properties The thermal conductivity of the aluminum fin is given to be $k = 237 \text{ W/m}\cdot^\circ\text{C}$.

Analysis The expressions for the heat transfer from a fin under infinitely long fin and adiabatic fin tip assumptions are

$$\dot{Q}_{\text{long fin}} = \sqrt{hp k A_c} (T_b - T_\infty)$$

$$\dot{Q}_{\text{ins. tip}} = \sqrt{hp k A_c} (T_b - T_\infty) \tanh(mL)$$

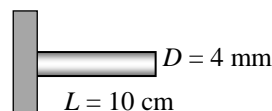

The percent error in using long fin assumption can be expressed as

$$\% \text{ Error} = \frac{\dot{Q}_{\text{long fin}} - \dot{Q}_{\text{ins. tip}}}{\dot{Q}_{\text{ins. tip}}} = \frac{\sqrt{hp k A_c} (T_b - T_\infty) - \sqrt{hp k A_c} (T_b - T_\infty) \tanh(mL)}{\sqrt{hp k A_c} (T_b - T_\infty) \tanh(mL)} = \frac{1}{\tanh(mL)} - 1$$

where $m = \sqrt{\frac{hp}{k A_c}} = \sqrt{\frac{(12 \text{ W/m}^2 \cdot ^\circ\text{C})\pi(0.004 \text{ m})}{(237 \text{ W/m}\cdot^\circ\text{C})\pi(0.004 \text{ m})^2 / 4}} = 7.116 \text{ m}^{-1}$

Substituting,

$$\% \text{ Error} = \frac{1}{\tanh(mL)} - 1 = \frac{1}{\tanh[(7.116 \text{ m}^{-1})(0.10 \text{ m})]} - 1 = 0.635 = \mathbf{63.5\%}$$

This result shows that using infinitely long fin assumption may yield results grossly in error.

3-113 A very long fin is attached to a flat surface. The fin temperature at a certain distance from the base and the rate of heat loss from the entire fin are to be determined.

Assumptions 1 Steady operating conditions exist. 2 The temperature along the fins varies in one direction only (normal to the plate). 3 The heat transfer coefficient is constant and uniform over the entire fin surface. 4 The thermal properties of the fins are constant. 5 The heat transfer coefficient accounts for the effect of radiation from the fins.

Properties The thermal conductivity of the fin is given to be $k = 200 \text{ W/m}\cdot^\circ\text{C}$.

Analysis The fin temperature at a distance of 5 cm from the base is determined from

$$m = \sqrt{\frac{hp}{k A_c}} = \sqrt{\frac{(20 \text{ W/m}^2 \cdot ^\circ\text{C})(2 \times 0.05 + 2 \times 0.001) \text{ m}}{(200 \text{ W/m}\cdot^\circ\text{C})(0.05 \times 0.001) \text{ m}^2}} = 14.3 \text{ m}^{-1}$$

$$\frac{T - T_\infty}{T_b - T_\infty} = e^{-mx} \longrightarrow \frac{T - 20}{40 - 20} = e^{-(14.3)(0.05)} \longrightarrow T = \mathbf{29.8^\circ\text{C}}$$



The rate of heat loss from this very long fin is

$$\begin{aligned} \dot{Q}_{\text{long fin}} &= \sqrt{hp k A_c} (T_b - T_\infty) \\ &= \sqrt{(20)(2 \times 0.05 + 2 \times 0.001)(200)(0.05 \times 0.001)} (40 - 20) \\ &= \mathbf{2.9 \text{ W}} \end{aligned}$$

3-114 Circular fins made of copper are considered. The function $\theta(x) = T(x) - T_\infty$ along a fin is to be expressed and the temperature at the middle is to be determined. Also, the rate of heat transfer from each fin, the fin effectiveness, and the total rate of heat transfer from the wall are to be determined.

Assumptions 1 Steady operating conditions exist. 2 The temperature along the fins varies in one direction only (normal to the plate). 3 The heat transfer coefficient is constant and uniform over the entire finned and unfinned wall surfaces. 4 The thermal properties of the fins are constant. 5 The heat transfer coefficient accounts for the effect of radiation from the fins.

Properties The thermal conductivity of the copper fin is given to be $k = 400 \text{ W/m}\cdot^\circ\text{C}$.

Analysis (a) For fin with prescribed tip temperature,

$$\frac{\theta}{\theta_b} = \frac{\theta_L / \theta_b \sinh(mx) + \sinh[m(L-x)]}{\sinh(mL)}$$

With $\theta_b = T_b - T_\infty = T_{s1}$ and $\theta_L = T_L - T_\infty = 0$, the equation becomes

$$\frac{\theta}{\theta_b} = \frac{\sinh[m(L-x)]}{\sinh(mL)} = \frac{\exp[m(L-x)] - \exp[-m(L-x)]}{\exp(mL) - \exp(-mL)}$$

For $x = L/2$:

$$m = \sqrt{\frac{hp}{kA_c}} = \sqrt{\frac{(100)\pi(0.001)}{(400)\pi(0.001)^2/4}} = 31.6 \text{ m}^{-1}$$

$$\begin{aligned} \theta_{L/2} = T_{L/2} - T_\infty &= \theta_b \frac{\sinh(mL/2)}{\sinh(mL)} = T_{s1} \frac{\exp(mL/2) - \exp(-mL/2)}{\exp(mL) - \exp(-mL)} \\ &= (132) \frac{\exp(31.6 \times 0.0254/2) - \exp(-31.6 \times 0.0254/2)}{\exp(31.6 \times 0.0254) - \exp(-31.6 \times 0.0254)} = 61.6^\circ\text{C} \end{aligned}$$

(b) The rate of heat transfer from a single fin is

$$\begin{aligned} \dot{q}_{\text{one fin}} &= \theta_b \sqrt{hpkA_c} \frac{\cosh(mL)}{\sinh(mL)} \\ &= (132 - 0) \sqrt{(100)\pi(0.001)(400)\pi(0.001)^2/4} \frac{\cosh(31.6 \times 0.0254)}{\sinh(31.6 \times 0.0254)} \\ &= 1.97 \text{ W} \end{aligned}$$

The effectiveness of the fin is

$$\varepsilon = \frac{q_f}{A_c h \theta_b} = \frac{1.97}{0.25\pi(0.001)^2 (100)(132 - 0)} = 190$$

Since $\varepsilon \gg 2$, the fins are well justified.

(c) The total rate of heat transfer is

$$\begin{aligned} \dot{q}_{\text{total}} &= \dot{q}_{\text{fins}} + \dot{q}_{\text{base}} \\ &= n_{\text{fin}} \dot{q}_{\text{one fin}} + (A_{\text{wall}} - n_{\text{fin}} A_c) h \theta_b \\ &= (625)(1.97) + [0.1 \times 0.1 - 625 \times 0.25\pi(0.001)^2](100)(132) \\ &= \mathbf{1363 \text{ W}} \end{aligned}$$

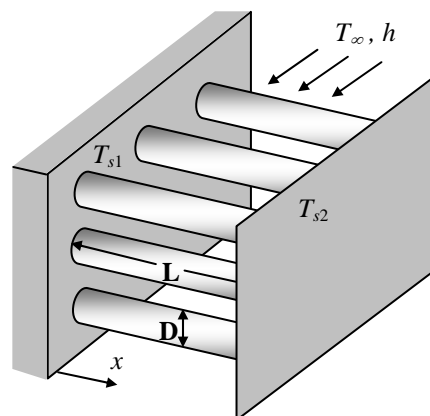

3-115 A commercially available heat sink is to be selected to keep the case temperature of a transistor below 90°C in an environment at 20°C .

Assumptions **1** Steady operating conditions exist. **2** The transistor case is isothermal at 90°C . **3** The contact resistance between the transistor and the heat sink is negligible.

Analysis The thermal resistance between the transistor attached to the sink and the ambient air is determined to be

$$\dot{Q} = \frac{\Delta T}{R_{\text{case-ambient}}} \longrightarrow R_{\text{case-ambient}} = \frac{T_{\text{transistor}} - T_{\infty}}{\dot{Q}} = \frac{(90 - 20)^{\circ}\text{C}}{40 \text{ W}} = \mathbf{1.75^{\circ}\text{C/W}}$$

The thermal resistance of the heat sink must be below 1.75°C/W . Table 3-6 reveals that HS6071 in vertical position, HS5030 and HS6115 in both horizontal and vertical position can be selected.

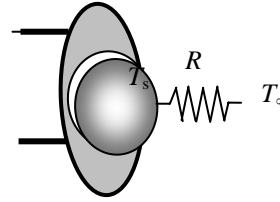

3-116 A commercially available heat sink is to be selected to keep the case temperature of a transistor below 55°C in an environment at 18°C .

Assumptions **1** Steady operating conditions exist. **2** The transistor case is isothermal at 55°C . **3** The contact resistance between the transistor and the heat sink is negligible.

Analysis The thermal resistance between the transistor attached to the sink and the ambient air is determined to be

$$\dot{Q} = \frac{\Delta T}{R_{\text{case-ambient}}} \longrightarrow R_{\text{case-ambient}} = \frac{T_{\text{transistor}} - T_{\infty}}{\dot{Q}} = \frac{(55 - 18)^{\circ}\text{C}}{25 \text{ W}} = \mathbf{1.5^{\circ}\text{C/W}}$$

The thermal resistance of the heat sink must be below 1.5°C/W . Table 3-6 reveals that HS5030 in both horizontal and vertical positions, HS6071 in vertical position, and HS6115 in both horizontal and vertical positions can be selected.

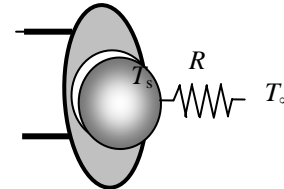

3-117 Circular aluminum fins are to be attached to the tubes of a heating system. The increase in heat transfer from the tubes per unit length as a result of adding fins is to be determined.

Assumptions 1 Steady operating conditions exist. **2** The heat transfer coefficient is constant and uniform over the entire fin surfaces. **3** Thermal conductivity is constant. **4** Heat transfer by radiation is negligible.

Properties The thermal conductivity of the fins is given to be $k = 186 \text{ W/m}\cdot^\circ\text{C}$.

Analysis In case of no fins, heat transfer from the tube per meter of its length is

$$A_{\text{no fin}} = \pi D_1 L = \pi(0.05 \text{ m})(1 \text{ m}) = 0.1571 \text{ m}^2$$

$$\dot{Q}_{\text{no fin}} = hA_{\text{no fin}}(T_b - T_\infty) = (40 \text{ W/m}^2\cdot^\circ\text{C})(0.1571 \text{ m}^2)(180 - 25)^\circ\text{C} = 974 \text{ W}$$

The efficiency of these circular fins is, from the efficiency curve, Fig. 3-43

$$\left. \begin{aligned} L &= (D_2 - D_1) / 2 = (0.06 - 0.05) / 2 = 0.005 \text{ m} \\ \frac{r_2 + (t/2)}{r_1} &= \frac{0.03 + (0.001/2)}{0.025} = 1.22 \\ L_c^{3/2} \left(\frac{h}{kA_p} \right)^{1/2} &= \left(L + \frac{t}{2} \right) \sqrt{\frac{h}{kt}} \\ &= \left(0.005 + \frac{0.001}{2} \right) \sqrt{\frac{40 \text{ W/m}^2\cdot^\circ\text{C}}{(186 \text{ W/m}\cdot^\circ\text{C})(0.001 \text{ m})}} = 0.08 \end{aligned} \right\} \eta_{\text{fin}} = 0.97$$

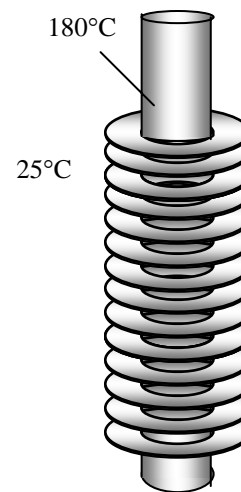

Heat transfer from a single fin is

$$A_{\text{fin}} = 2\pi(r_2^2 - r_1^2) + 2\pi r_2 t = 2\pi(0.03^2 - 0.025^2) + 2\pi(0.03)(0.001) = 0.001916 \text{ m}^2$$

$$\begin{aligned} \dot{Q}_{\text{fin}} &= \eta_{\text{fin}} \dot{Q}_{\text{fin,max}} = \eta_{\text{fin}} hA_{\text{fin}}(T_b - T_\infty) \\ &= 0.97(40 \text{ W/m}^2\cdot^\circ\text{C})(0.001916 \text{ m}^2)(180 - 25)^\circ\text{C} \\ &= 11.53 \text{ W} \end{aligned}$$

Heat transfer from a single unfinned portion of the tube is

$$A_{\text{unfin}} = \pi D_1 s = \pi(0.05 \text{ m})(0.003 \text{ m}) = 0.0004712 \text{ m}^2$$

$$\dot{Q}_{\text{unfin}} = hA_{\text{unfin}}(T_b - T_\infty) = (40 \text{ W/m}^2\cdot^\circ\text{C})(0.0004712 \text{ m}^2)(180 - 25)^\circ\text{C} = 2.92 \text{ W}$$

There are 250 fins and thus 250 interfin spacings per meter length of the tube. The total heat transfer from the finned tube is then determined from

$$\dot{Q}_{\text{total,fin}} = n(\dot{Q}_{\text{fin}} + \dot{Q}_{\text{unfin}}) = 250(11.53 + 2.92) = 3613 \text{ W}$$

Therefore the increase in heat transfer from the tube per meter of its length as a result of the addition of the fins is

$$\dot{Q}_{\text{increase}} = \dot{Q}_{\text{total,fin}} - \dot{Q}_{\text{no fin}} = 3613 - 974 = \mathbf{2639 \text{ W}}$$

3-118E The handle of a stainless steel spoon partially immersed in boiling water extends 7 in. in the air from the free surface of the water. The temperature difference across the exposed surface of the spoon handle is to be determined.

Assumptions 1 The temperature of the submerged portion of the spoon is equal to the water temperature. **2** The temperature in the spoon varies in the axial direction only (along the spoon), $T(x)$. **3** The heat transfer from the tip of the spoon is negligible. **4** The heat transfer coefficient is constant and uniform over the entire spoon surface. **5** The thermal properties of the spoon are constant. **6** The heat transfer coefficient accounts for the effect of radiation from the spoon.

Properties The thermal conductivity of the spoon is given to be $k = 8.7 \text{ Btu/h}\cdot\text{ft}\cdot^\circ\text{F}$.

Analysis Noting that the cross-sectional area of the spoon is constant and measuring x from the free surface of water, the variation of temperature along the spoon can be expressed as

$$\frac{T(x) - T_\infty}{T_b - T_\infty} = \frac{\cosh m(L - x)}{\cosh mL}$$

where

$$p = 2(0.5/12 \text{ ft} + 0.08/12 \text{ ft}) = 0.0967 \text{ ft}$$

$$A_c = (0.5/12 \text{ ft})(0.08/12 \text{ ft}) = 0.000278 \text{ ft}^2$$

$$m = \sqrt{\frac{hp}{kA_c}} = \sqrt{\frac{(3 \text{ Btu/h}\cdot\text{ft}^2\cdot^\circ\text{F})(0.0967 \text{ ft})}{(8.7 \text{ Btu/h}\cdot\text{ft}\cdot^\circ\text{F})(0.000278 \text{ ft}^2)}} = 10.95 \text{ ft}^{-1}$$

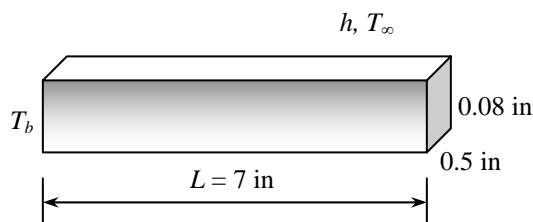

Noting that $x = L = 7/12 = 0.583 \text{ ft}$ at the tip and substituting, the tip temperature of the spoon is determined to be

$$\begin{aligned} T(L) &= T_\infty + (T_b - T_\infty) \frac{\cosh m(L - L)}{\cosh mL} \\ &= 75^\circ\text{F} + (200 - 75) \frac{\cosh 0}{\cosh(10.95 \times 0.583)} = 75^\circ\text{F} + (200 - 75) \frac{1}{296} = 75.4^\circ\text{F} \end{aligned}$$

Therefore, the temperature difference across the exposed section of the spoon handle is

$$\Delta T = T_b - T_{\text{tip}} = (200 - 75.4)^\circ\text{F} = \mathbf{124.6^\circ\text{F}}$$

3-119E The handle of a silver spoon partially immersed in boiling water extends 7 in. in the air from the free surface of the water. The temperature difference across the exposed surface of the spoon handle is to be determined.

Assumptions **1** The temperature of the submerged portion of the spoon is equal to the water temperature. **2** The temperature in the spoon varies in the axial direction only (along the spoon), $T(x)$. **3** The heat transfer from the tip of the spoon is negligible. **4** The heat transfer coefficient is constant and uniform over the entire spoon surface. **5** The thermal properties of the spoon are constant. **6** The heat transfer coefficient accounts for the effect of radiation from the spoon..

Properties The thermal conductivity of the spoon is given to be $k = 247 \text{ Btu/h}\cdot\text{ft}\cdot^\circ\text{F}$.

Analysis Noting that the cross-sectional area of the spoon is constant and measuring x from the free surface of water, the variation of temperature along the spoon can be expressed as

$$\frac{T(x) - T_\infty}{T_b - T_\infty} = \frac{\cosh m(L - x)}{\cosh mL}$$

where

$$p = 2(0.5/12 \text{ ft} + 0.08/12 \text{ ft}) = 0.0967 \text{ ft}$$

$$A_c = (0.5/12 \text{ ft})(0.08/12 \text{ ft}) = 0.000278 \text{ ft}^2$$

$$m = \sqrt{\frac{hp}{kA_c}} = \sqrt{\frac{(3 \text{ Btu/h}\cdot\text{ft}^2\cdot^\circ\text{F})(0.0967 \text{ ft})}{(247 \text{ Btu/h}\cdot\text{ft}\cdot^\circ\text{F})(0.000278 \text{ ft}^2)}} = 2.055 \text{ ft}^{-1}$$

Noting that $x = L = 0.7/12 = 0.583 \text{ ft}$ at the tip and substituting, the tip temperature of the spoon is determined to be

$$\begin{aligned} T(L) &= T_\infty + (T_b - T_\infty) \frac{\cosh m(L - L)}{\cosh mL} \\ &= 75^\circ\text{F} + (200 - 75) \frac{\cosh 0}{\cosh(2.055 \times 0.583)} = 75^\circ\text{F} + (200 - 75) \frac{1}{1.81} = \mathbf{144.1^\circ\text{F}} \end{aligned}$$

Therefore, the temperature difference across the exposed section of the spoon handle is

$$\Delta T = T_b - T_{\text{tip}} = (200 - 144.1)^\circ\text{C} = \mathbf{55.9^\circ\text{F}}$$

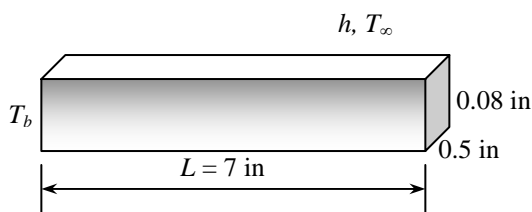

3-120E EES Prob. 3-118E is reconsidered. The effects of the thermal conductivity of the spoon material and the length of its extension in the air on the temperature difference across the exposed surface of the spoon handle are to be investigated.

Analysis The problem is solved using EES, and the solution is given below.

"GIVEN"

$$k_{\text{spoon}}=8.7 \text{ [Btu/h-ft-F]}$$

$$T_w=200 \text{ [F]}$$

$$T_{\text{infinity}}=75 \text{ [F]}$$

$$A_c=0.08/12*0.5/12 \text{ [ft}^2\text{]}$$

$$L=7 \text{ [in]}$$

$$h=3 \text{ [Btu/h-ft}^2\text{-F]}$$

"ANALYSIS"

$$p=2*(0.08/12+0.5/12)$$

$$a=\sqrt{(h*p)/(k_{\text{spoon}}*A_c)}$$

$$(T_{\text{tip}}-T_{\text{infinity}})/(T_w-T_{\text{infinity}})=\cosh(a*(L-x)*\text{Convert(in, ft)})/\cosh(a*L*\text{Convert(in, ft)})$$

$$x=L \text{ "for tip temperature"}$$

$$\text{DELTAT}=T_w-T_{\text{tip}}$$

k_{spoon} [Btu/h.ft.F]	ΔT [F]
5	124.9
16.58	122.6
28.16	117.8
39.74	112.5
51.32	107.1
62.89	102
74.47	97.21
86.05	92.78
97.63	88.69
109.2	84.91
120.8	81.42
132.4	78.19
143.9	75.19
155.5	72.41
167.1	69.82
178.7	67.4
190.3	65.14
201.8	63.02
213.4	61.04
225	59.17

k_{spoon} [Btu/h.ft.F]	ΔT [F]
5	122.4
5.5	123.4
6	124
6.5	124.3
7	124.6
7.5	124.7
8	124.8
8.5	124.9
9	124.9
9.5	125
10	125
10.5	125
11	125
11.5	125
12	125

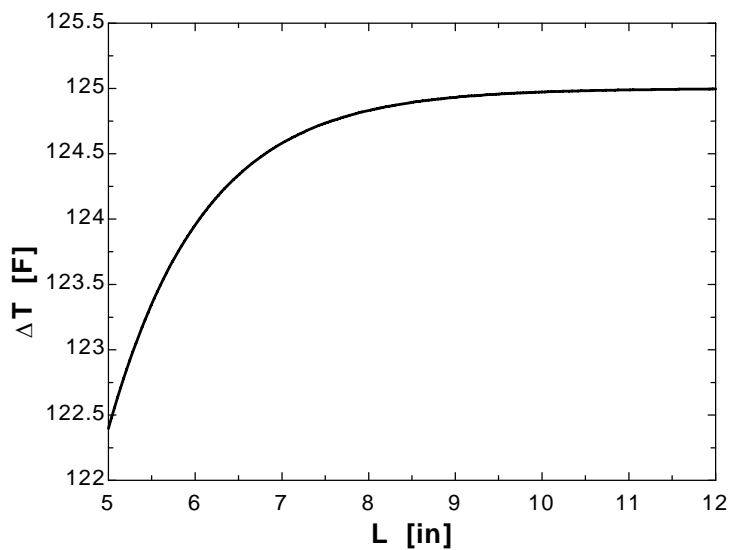
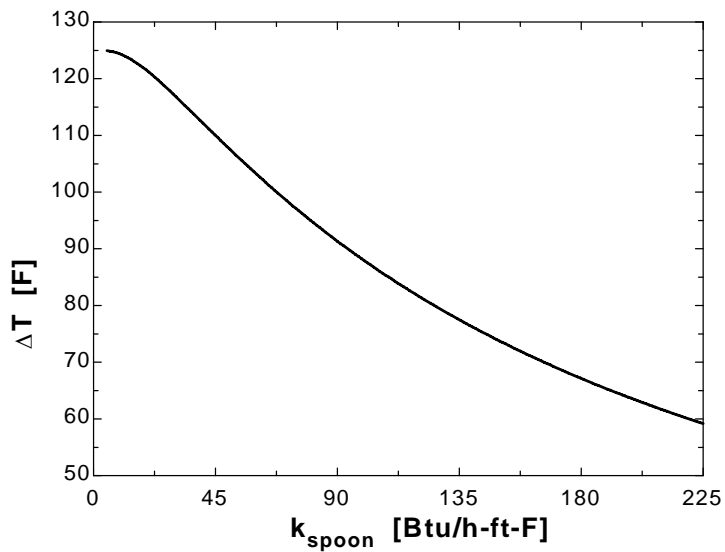

3-121 A circuit board houses 80 logic chips on one side, dissipating 0.04 W each through the back side of the board to the surrounding medium. The temperatures on the two sides of the circuit board are to be determined for the cases of no fins and 864 aluminum pin fins on the back surface.

Assumptions 1 Steady operating conditions exist. 2 The temperature in the board and along the fins varies in one direction only (normal to the board). 3 All the heat generated in the chips is conducted across the circuit board, and is dissipated from the back side of the board. 4 Heat transfer from the fin tips is negligible. 5 The heat transfer coefficient is constant and uniform over the entire fin surface. 6 The thermal properties of the fins are constant. 7 The heat transfer coefficient accounts for the effect of radiation from the fins.

Properties The thermal conductivities are given to be $k = 30 \text{ W/m}\cdot^\circ\text{C}$ for the circuit board, $k = 237 \text{ W/m}\cdot^\circ\text{C}$ for the aluminum plate and fins, and $k = 1.8 \text{ W/m}\cdot^\circ\text{C}$ for the epoxy adhesive.

Analysis (a) The total rate of heat transfer dissipated by the chips is

$$\dot{Q} = 80 \times (0.04 \text{ W}) = 3.2 \text{ W}$$

The individual resistances are

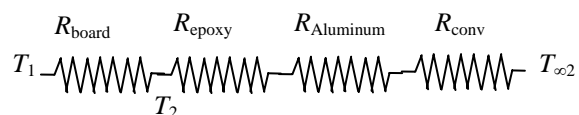

$$A = (0.12 \text{ m})(0.18 \text{ m}) = 0.0216 \text{ m}^2$$

$$R_{\text{board}} = \frac{L}{kA} = \frac{0.003 \text{ m}}{(30 \text{ W/m}\cdot^\circ\text{C})(0.0216 \text{ m}^2)} = 0.00463 \text{ }^\circ\text{C/W}$$

$$R_{\text{conv}} = \frac{1}{hA} = \frac{1}{(40 \text{ W/m}^2\cdot^\circ\text{C})(0.0216 \text{ m}^2)} = 1.1574 \text{ }^\circ\text{C/W}$$

$$R_{\text{total}} = R_{\text{board}} + R_{\text{conv}} = 0.00463 + 1.1574 = 1.1620 \text{ }^\circ\text{C/W}$$

The temperatures on the two sides of the circuit board are

$$\dot{Q} = \frac{T_1 - T_{\infty 2}}{R_{\text{total}}} \longrightarrow T_1 = T_{\infty 2} + \dot{Q}R_{\text{total}} = 40^\circ\text{C} + (3.2 \text{ W})(1.1620 \text{ }^\circ\text{C/W}) = \mathbf{43.7^\circ\text{C}}$$

$$\dot{Q} = \frac{T_1 - T_2}{R_{\text{board}}} \longrightarrow T_2 = T_1 - \dot{Q}R_{\text{board}} = 43.7^\circ\text{C} - (3.2 \text{ W})(0.00463 \text{ }^\circ\text{C/W}) = 43.7 - 0.015 \cong \mathbf{43.7^\circ\text{C}}$$

Therefore, the board is nearly isothermal.

(b) Noting that the cross-sectional areas of the fins are constant, the efficiency of the circular fins can be determined to be

$$m = \sqrt{\frac{hp}{kA_c}} = \sqrt{\frac{h\pi D}{k\pi D^2/4}} = \sqrt{\frac{4h}{kD}} = \sqrt{\frac{4(40 \text{ W/m}^2\cdot^\circ\text{C})}{(237 \text{ W/m}\cdot^\circ\text{C})(0.0025 \text{ m})}} = 16.43 \text{ m}^{-1}$$

$$\eta_{\text{fin}} = \frac{\tanh mL}{mL} = \frac{\tanh(16.43 \text{ m}^{-1} \times 0.02 \text{ m})}{16.43 \text{ m}^{-1} \times 0.02 \text{ m}} = 0.965$$

The fins can be assumed to be at base temperature provided that the fin area is modified by multiplying it by 0.965. Then the various thermal resistances are

$$R_{\text{epoxy}} = \frac{L}{kA} = \frac{0.0002 \text{ m}}{(1.8 \text{ W/m}\cdot^\circ\text{C})(0.0216 \text{ m}^2)} = 0.0051 \text{ }^\circ\text{C/W}$$

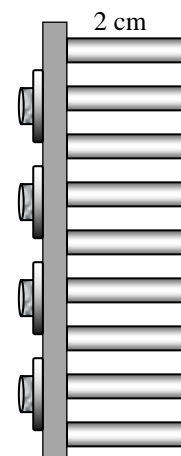

$$R_{Al} = \frac{L}{kA} = \frac{0.002 \text{ m}}{(237 \text{ W/m}\cdot\text{°C})(0.0216 \text{ m}^2)} = 0.00039 \text{ °C/W}$$

$$A_{\text{finned}} = \eta_{\text{fin}} n \pi D L = 0.965 \times 864 \pi (0.0025 \text{ m})(0.02 \text{ m}) = 0.131 \text{ m}^2$$

$$A_{\text{unfinned}} = 0.0216 - 864 \frac{\pi D^2}{4} = 0.0216 - 864 \times \frac{\pi (0.0025)^2}{4} = 0.0174 \text{ m}^2$$

$$A_{\text{total, with fins}} = A_{\text{finned}} + A_{\text{unfinned}} = 0.131 + 0.0174 = 0.148 \text{ m}^2$$

$$R_{\text{conv}} = \frac{1}{hA_{\text{total, with fins}}} = \frac{1}{(40 \text{ W/m}^2\cdot\text{°C})(0.148 \text{ m}^2)} = 0.1689 \text{ °C/W}$$

$$\begin{aligned} R_{\text{total}} &= R_{\text{board}} + R_{\text{epoxy}} + R_{\text{aluminum}} + R_{\text{conv}} \\ &= 0.00463 + 0.0051 + 0.00039 + 0.1689 = 0.1790 \text{ °C/W} \end{aligned}$$

Then the temperatures on the two sides of the circuit board becomes

$$\dot{Q} = \frac{T_1 - T_{\infty 2}}{R_{\text{total}}} \longrightarrow T_1 = T_{\infty 2} + \dot{Q} R_{\text{total}} = 40 \text{ °C} + (3.2 \text{ W})(0.1790 \text{ °C/W}) = \mathbf{40.6 \text{ °C}}$$

$$\dot{Q} = \frac{T_1 - T_2}{R_{\text{board}}} \longrightarrow T_2 = T_1 - \dot{Q} R_{\text{board}} = 40.6 \text{ °C} - (3.2 \text{ W})(0.00463 \text{ °C/W}) = 40.6 - 0.015 \cong \mathbf{40.6 \text{ °C}}$$

3-122 A circuit board houses 80 logic chips on one side, dissipating 0.04 W each through the back side of the board to the surrounding medium. The temperatures on the two sides of the circuit board are to be determined for the cases of no fins and 864 copper pin fins on the back surface.

Assumptions 1 Steady operating conditions exist. 2 The temperature in the board and along the fins varies in one direction only (normal to the board). 3 All the heat generated in the chips is conducted across the circuit board, and is dissipated from the back side of the board. 4 Heat transfer from the fin tips is negligible. 5 The heat transfer coefficient is constant and uniform over the entire fin surface. 6 The thermal properties of the fins are constant. 7 The heat transfer coefficient accounts for the effect of radiation from the fins.

Properties The thermal conductivities are given to be $k = 20 \text{ W/m}\cdot\text{C}$ for the circuit board, $k = 386 \text{ W/m}\cdot\text{C}$ for the copper plate and fins, and $k = 1.8 \text{ W/m}\cdot\text{C}$ for the epoxy adhesive.

Analysis (a) The total rate of heat transfer dissipated by the chips is

$$\dot{Q} = 80 \times (0.04 \text{ W}) = 3.2 \text{ W}$$

The individual resistances are

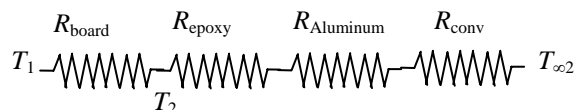

$$A = (0.12 \text{ m})(0.18 \text{ m}) = 0.0216 \text{ m}^2$$

$$R_{\text{board}} = \frac{L}{kA} = \frac{0.003 \text{ m}}{(30 \text{ W/m}\cdot\text{C})(0.0216 \text{ m}^2)} = 0.00463 \text{ C/W}$$

$$R_{\text{conv}} = \frac{1}{hA} = \frac{1}{(40 \text{ W/m}^2\cdot\text{C})(0.0216 \text{ m}^2)} = 1.1574 \text{ C/W}$$

$$R_{\text{total}} = R_{\text{board}} + R_{\text{conv}} = 0.00463 + 1.1574 = 1.1620 \text{ C/W}$$

The temperatures on the two sides of the circuit board are

$$\dot{Q} = \frac{T_1 - T_{\infty 2}}{R_{\text{total}}} \longrightarrow T_1 = T_{\infty 2} + \dot{Q}R_{\text{total}} = 40\text{C} + (3.2 \text{ W})(1.1620 \text{ C/W}) = \mathbf{43.7\text{C}}$$

$$\dot{Q} = \frac{T_1 - T_2}{R_{\text{board}}} \longrightarrow T_2 = T_1 - \dot{Q}R_{\text{board}} = 43.7\text{C} - (3.2 \text{ W})(0.00463 \text{ C/W}) = 43.7 - 0.015 \cong \mathbf{43.7\text{C}}$$

Therefore, the board is nearly isothermal.

(b) Noting that the cross-sectional areas of the fins are constant, the efficiency of the circular fins can be determined to be

$$m = \sqrt{\frac{hp}{kA_c}} = \sqrt{\frac{h\pi D}{k\pi D^2/4}} = \sqrt{\frac{4h}{kD}} = \sqrt{\frac{4(40 \text{ W/m}^2\cdot\text{C})}{(386 \text{ W/m}\cdot\text{C})(0.0025 \text{ m})}} = 12.88 \text{ m}^{-1}$$

$$\eta_{\text{fin}} = \frac{\tanh mL}{mL} = \frac{\tanh(12.88 \text{ m}^{-1} \times 0.02 \text{ m})}{12.88 \text{ m}^{-1} \times 0.02 \text{ m}} = 0.978$$

The fins can be assumed to be at base temperature provided that the fin area is modified by multiplying it by 0.978. Then the various thermal resistances are

$$R_{\text{epoxy}} = \frac{L}{kA} = \frac{0.0002 \text{ m}}{(1.8 \text{ W/m}\cdot\text{C})(0.0216 \text{ m}^2)} = 0.0051 \text{ C/W}$$

$$R_{\text{Cu}} = \frac{L}{kA} = \frac{0.002 \text{ m}}{(386 \text{ W/m}\cdot\text{C})(0.0216 \text{ m}^2)} = 0.00024 \text{ C/W}$$

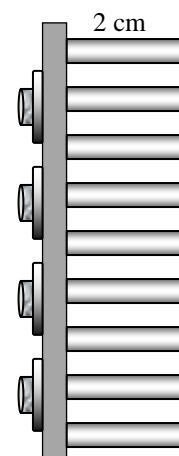

$$A_{\text{finned}} = \eta_{\text{fin}} n \pi D L = 0.978 \times 864 \pi (0.0025 \text{ m})(0.02 \text{ m}) = 0.133 \text{ m}^2$$

$$A_{\text{unfinned}} = 0.0216 - 864 \frac{\pi D^2}{4} = 0.0216 - 864 \times \frac{\pi (0.0025)^2}{4} = 0.0174 \text{ m}^2$$

$$A_{\text{total, with fins}} = A_{\text{finned}} + A_{\text{unfinned}} = 0.133 + 0.0174 = 0.150 \text{ m}^2$$

$$R_{\text{conv}} = \frac{1}{h A_{\text{total, with fins}}} = \frac{1}{(40 \text{ W/m}^2 \cdot \text{°C})(0.150 \text{ m}^2)} = 0.1667 \text{ °C/W}$$

$$R_{\text{total}} = R_{\text{board}} + R_{\text{epoxy}} + R_{\text{aluminum}} + R_{\text{conv}}$$

$$= 0.00463 + 0.0051 + 0.00024 + 0.1667 = 0.1767 \text{ °C/W}$$

Then the temperatures on the two sides of the circuit board becomes

$$\dot{Q} = \frac{T_1 - T_{\infty 2}}{R_{\text{total}}} \longrightarrow T_1 = T_{\infty 2} + \dot{Q} R_{\text{total}} = 40 \text{ °C} + (3.2 \text{ W})(0.1767 \text{ °C/W}) = \mathbf{40.6 \text{ °C}}$$

$$\dot{Q} = \frac{T_1 - T_2}{R_{\text{board}}} \longrightarrow T_2 = T_1 - \dot{Q} R_{\text{board}} = 40.6 \text{ °C} - (3.2 \text{ W})(0.00463 \text{ °C/W}) = 40.6 - 0.015 \cong \mathbf{40.6 \text{ °C}}$$

3-123 A hot plate is to be cooled by attaching aluminum pin fins on one side. The rate of heat transfer from the 1 m by 1 m section of the plate and the effectiveness of the fins are to be determined.

Assumptions 1 Steady operating conditions exist. 2 The temperature along the fins varies in one direction only (normal to the plate). 3 Heat transfer from the fin tips is negligible. 4 The heat transfer coefficient is constant and uniform over the entire fin surface. 5 The thermal properties of the fins are constant. 6 The heat transfer coefficient accounts for the effect of radiation from the fins.

Properties The thermal conductivity of the aluminum plate and fins is given to be $k = 237 \text{ W/m}\cdot^\circ\text{C}$.

Analysis Noting that the cross-sectional areas of the fins are constant, the efficiency of the circular fins can be determined to be

$$m = \sqrt{\frac{hp}{kA_c}} = \sqrt{\frac{h\pi D}{k\pi D^2/4}} = \sqrt{\frac{4h}{kD}} = \sqrt{\frac{4(35 \text{ W/m}^2\cdot^\circ\text{C})}{(237 \text{ W/m}\cdot^\circ\text{C})(0.0025 \text{ m})}} = 15.37 \text{ m}^{-1}$$

$$\eta_{\text{fin}} = \frac{\tanh mL}{mL} = \frac{\tanh(15.37 \text{ m}^{-1} \times 0.03 \text{ m})}{15.37 \text{ m}^{-1} \times 0.03 \text{ m}} = 0.935$$

The number of fins, finned and unfinned surface areas, and heat transfer rates from those areas are

$$n = \frac{1 \text{ m}^2}{(0.006 \text{ m})(0.006 \text{ m})} = 27,777$$

$$A_{\text{fin}} = 27777 \left[\pi DL + \frac{\pi D^2}{4} \right] = 27777 \left[\pi(0.0025)(0.03) + \frac{\pi(0.0025)^2}{4} \right] = 6.68 \text{ m}^2$$

$$A_{\text{unfinned}} = 1 - 27777 \left(\frac{\pi D^2}{4} \right) = 1 - 27777 \left[\frac{\pi(0.0025)^2}{4} \right] = 0.86 \text{ m}^2$$

$$\begin{aligned} \dot{Q}_{\text{finned}} &= \eta_{\text{fin}} \dot{Q}_{\text{fin,max}} = \eta_{\text{fin}} h A_{\text{fin}} (T_b - T_\infty) \\ &= 0.935(35 \text{ W/m}^2\cdot^\circ\text{C})(6.68 \text{ m}^2)(100 - 30)^\circ\text{C} \\ &= 15,300 \text{ W} \end{aligned}$$

$$\begin{aligned} \dot{Q}_{\text{unfinned}} &= h A_{\text{unfinned}} (T_b - T_\infty) = (35 \text{ W/m}^2\cdot^\circ\text{C})(0.86 \text{ m}^2)(100 - 30)^\circ\text{C} \\ &= 2107 \text{ W} \end{aligned}$$

Then the total heat transfer from the finned plate becomes

$$\dot{Q}_{\text{total,fin}} = \dot{Q}_{\text{finned}} + \dot{Q}_{\text{unfinned}} = 15,300 + 2107 = 1.74 \times 10^4 \text{ W} = \mathbf{17.4 \text{ kW}}$$

The rate of heat transfer if there were no fin attached to the plate would be

$$A_{\text{no fin}} = (1 \text{ m})(1 \text{ m}) = 1 \text{ m}^2$$

$$\dot{Q}_{\text{no fin}} = h A_{\text{no fin}} (T_b - T_\infty) = (35 \text{ W/m}^2\cdot^\circ\text{C})(1 \text{ m}^2)(100 - 30)^\circ\text{C} = 2450 \text{ W}$$

Then the fin effectiveness becomes

$$\varepsilon_{\text{fin}} = \frac{\dot{Q}_{\text{fin}}}{\dot{Q}_{\text{no fin}}} = \frac{17,400}{2450} = \mathbf{7.10}$$

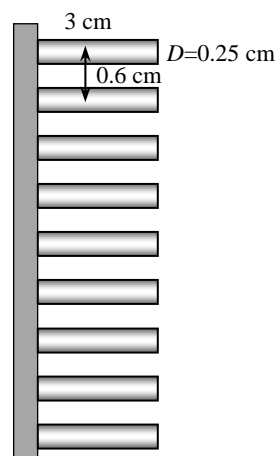

3-124 A hot plate is to be cooled by attaching copper pin fins on one side. The rate of heat transfer from the 1 m by 1 m section of the plate and the effectiveness of the fins are to be determined.

Assumptions 1 Steady operating conditions exist. 2 The temperature along the fins varies in one direction only (normal to the plate). 3 Heat transfer from the fin tips is negligible. 4 The heat transfer coefficient is constant and uniform over the entire fin surface. 5 The thermal properties of the fins are constant. 6 The heat transfer coefficient accounts for the effect of radiation from the fins.

Properties The thermal conductivity of the copper plate and fins is given to be $k = 386 \text{ W/m}\cdot\text{C}$.

Analysis Noting that the cross-sectional areas of the fins are constant, the efficiency of the circular fins can be determined to be

$$m = \sqrt{\frac{hp}{kA_c}} = \sqrt{\frac{h\pi D}{k\pi D^2/4}} = \sqrt{\frac{4h}{kD}} = \sqrt{\frac{4(35 \text{ W/m}^2\cdot\text{C})}{(386 \text{ W/m}\cdot\text{C})(0.0025 \text{ m})}} = 12.04 \text{ m}^{-1}$$

$$\eta_{\text{fin}} = \frac{\tanh mL}{mL} = \frac{\tanh(12.04 \text{ m}^{-1} \times 0.03 \text{ m})}{12.04 \text{ m}^{-1} \times 0.03 \text{ m}} = 0.959$$

The number of fins, finned and unfinned surface areas, and heat transfer rates from those areas are

$$n = \frac{1 \text{ m}^2}{(0.006 \text{ m})(0.006 \text{ m})} = 27777$$

$$A_{\text{fin}} = 27777 \left[\pi DL + \frac{\pi D^2}{4} \right] = 27777 \left[\pi(0.0025)(0.03) + \frac{\pi(0.0025)^2}{4} \right] = 6.68 \text{ m}^2$$

$$A_{\text{unfinned}} = 1 - 27777 \left(\frac{\pi D^2}{4} \right) = 1 - 27777 \left[\frac{\pi(0.0025)^2}{4} \right] = 0.86 \text{ m}^2$$

$$\begin{aligned} \dot{Q}_{\text{finned}} &= \eta_{\text{fin}} \dot{Q}_{\text{fin,max}} = \eta_{\text{fin}} h A_{\text{fin}} (T_b - T_\infty) \\ &= 0.959(35 \text{ W/m}^2\cdot\text{C})(6.68 \text{ m}^2)(100 - 30)\text{C} \\ &= 15,700 \text{ W} \end{aligned}$$

$$\dot{Q}_{\text{unfinned}} = h A_{\text{unfinned}} (T_b - T_\infty) = (35 \text{ W/m}^2\cdot\text{C})(0.86 \text{ m}^2)(100 - 30)\text{C} = 2107 \text{ W}$$

Then the total heat transfer from the finned plate becomes

$$\dot{Q}_{\text{total,fin}} = \dot{Q}_{\text{finned}} + \dot{Q}_{\text{unfinned}} = 15,700 + 2107 = 1.78 \times 10^4 \text{ W} = \mathbf{17.8 \text{ kW}}$$

The rate of heat transfer if there were no fin attached to the plate would be

$$A_{\text{no fin}} = (1 \text{ m})(1 \text{ m}) = 1 \text{ m}^2$$

$$\dot{Q}_{\text{no fin}} = h A_{\text{no fin}} (T_b - T_\infty) = (35 \text{ W/m}^2\cdot\text{C})(1 \text{ m}^2)(100 - 30)\text{C} = 2450 \text{ W}$$

Then the fin effectiveness becomes

$$\varepsilon_{\text{fin}} = \frac{\dot{Q}_{\text{fin}}}{\dot{Q}_{\text{no fin}}} = \frac{17800}{2450} = \mathbf{7.27}$$

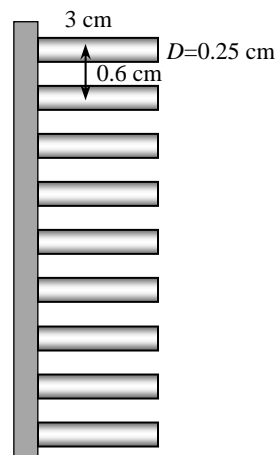

3-125 EES Prob. 3-123 is reconsidered. The effect of the center-to center distance of the fins on the rate of heat transfer from the surface and the overall effectiveness of the fins is to be investigated.

Analysis The problem is solved using EES, and the solution is given below.

"GIVEN"

T_b=100 [C]
 L=0.03 [m]
 D=0.0025 [m]
 k=237 [W/m-C]
 S=0.6 [cm]
 T_{infinity}=30 [C]
 h=35 [W/m²-C]
 A_{surface}=1*1 [m²]

"ANALYSIS"

p=pi*D
 A_c=pi*D²/4
 a=sqrt((h*p)/(k*A_c))
 eta_{fin}=tanh(a*L)/(a*L)
 n=A_{surface}/(S²*Convert(cm², m²)) "number of fins"
 A_{fin}=n*(pi*D*L+pi*D²/4)
 A_{unfinned}=A_{surface}-n*(pi*D²/4)
 Q_{dot}_{finned}=eta_{fin}*h*A_{fin}*(T_b-T_{infinity})
 Q_{dot}_{unfinned}=h*A_{unfinned}*(T_b-T_{infinity})
 Q_{dot}_{total}_{fin}=Q_{dot}_{finned}+Q_{dot}_{unfinned}
 Q_{dot}_{nofin}=h*A_{surface}*(T_b-T_{infinity})
 epsilon_{fin}=Q_{dot}_{total}_{fin}/Q_{dot}_{nofin}

S [cm]	Q _{total,fin} [W]	ε _{fin}
0.4	36123	14.74
0.5	24001	9.796
0.6	17416	7.108
0.7	13445	5.488
0.8	10868	4.436
0.9	9101	3.715
1	7838	3.199
1.1	6903	2.817
1.2	6191	2.527
1.3	5638	2.301
1.4	5199	2.122
1.5	4845	1.977
1.6	4555	1.859
1.7	4314	1.761
1.8	4113	1.679
1.9	3942	1.609
2	3797	1.55

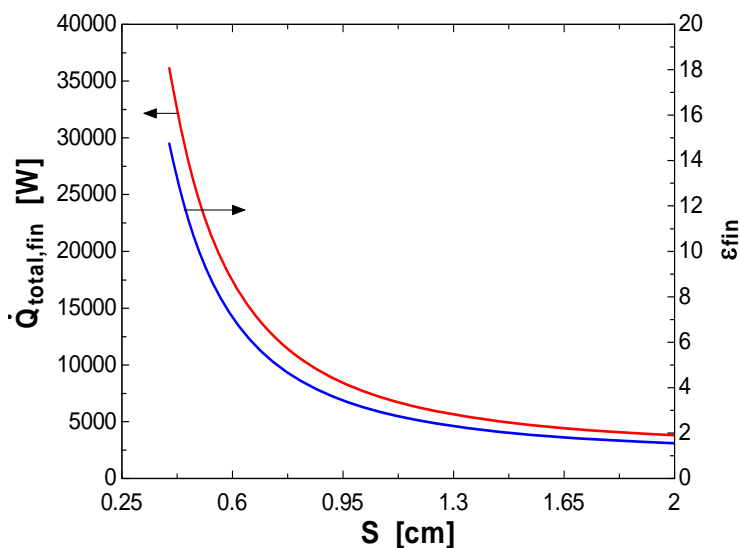

3-126 Two cast iron steam pipes are connected to each other through two 1-cm thick flanges exposed to cold ambient air. The average outer surface temperature of the pipe, the fin efficiency, the rate of heat transfer from the flanges, and the equivalent pipe length of the flange for heat transfer are to be determined.

Assumptions 1 Steady operating conditions exist. 2 The temperature along the flanges (fins) varies in one direction only (normal to the pipe). 3 The heat transfer coefficient is constant and uniform over the entire fin surface. 4 The thermal properties of the fins are constant. 5 The heat transfer coefficient accounts for the effect of radiation from the fins.

Properties The thermal conductivity of the cast iron is given to be $k = 52 \text{ W/m}\cdot^\circ\text{C}$.

Analysis (a) We treat the flanges as fins. The individual thermal resistances are

$$A_i = \pi D_i L = \pi(0.092 \text{ m})(6 \text{ m}) = 1.73 \text{ m}^2$$

$$A_o = \pi D_o L = \pi(0.1 \text{ m})(6 \text{ m}) = 1.88 \text{ m}^2$$

$$R_i = \frac{1}{h_i A_i} = \frac{1}{(180 \text{ W/m}^2 \cdot ^\circ\text{C})(1.73 \text{ m}^2)} = 0.0032 \text{ }^\circ\text{C/W}$$

$$R_{\text{cond}} = \frac{\ln(r_2 / r_1)}{2\pi k L} = \frac{\ln(5 / 4.6)}{2\pi(52 \text{ W/m}\cdot^\circ\text{C})(6 \text{ m})} = 0.00004 \text{ }^\circ\text{C/W}$$

$$R_o = \frac{1}{h_o A_o} = \frac{1}{(25 \text{ W/m}^2 \cdot ^\circ\text{C})(1.88 \text{ m}^2)} = 0.0213 \text{ }^\circ\text{C/W}$$

$$R_{\text{total}} = R_i + R_{\text{cond}} + R_o = 0.0032 + 0.00004 + 0.0213 = 0.0245 \text{ }^\circ\text{C/W}$$

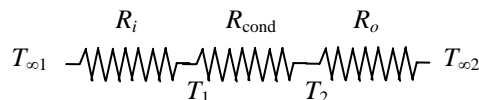

The rate of heat transfer and average outer surface temperature of the pipe are

$$\dot{Q} = \frac{T_{\infty 1} - T_{\infty 2}}{R_{\text{total}}} = \frac{(200 - 12)^\circ\text{C}}{0.0245 \text{ }^\circ\text{C}} = 7673 \text{ W}$$

$$\dot{Q} = \frac{T_2 - T_{\infty 2}}{R_o} \rightarrow T_2 = T_{\infty 2} + \dot{Q}R_o = 12^\circ\text{C} + (7673 \text{ W})(0.0213 \text{ }^\circ\text{C/W}) = \mathbf{175.4^\circ\text{C}}$$

(b) The fin efficiency can be determined from (Fig. 3-43)

$$\left. \begin{aligned} \frac{r_2 + \frac{t}{2}}{r_1} &= \frac{0.1 + \frac{0.02}{2}}{0.05} = 2.2 \\ \xi &= L_c^{3/2} \left(\frac{h}{kA_p} \right)^{1/2} = \left(L + \frac{t}{2} \right) \sqrt{\frac{h}{kt}} = \left(0.05 \text{ m} + \frac{0.02}{2} \text{ m} \right) \sqrt{\frac{25 \text{ W/m}^2 \cdot ^\circ\text{C}}{(52 \text{ W/m}\cdot^\circ\text{C})(0.02 \text{ m})}} = 0.29 \end{aligned} \right\} \eta_{\text{fin}} = 0.88$$

$$A_{\text{fin}} = 2\pi(r_2^2 - r_1^2) + 2\pi r_2 t = 2\pi[(0.1 \text{ m})^2 - (0.05 \text{ m})^2] + 2\pi(0.1 \text{ m})(0.02 \text{ m}) = 0.0597 \text{ m}^2$$

The heat transfer rate from the flanges is

$$\begin{aligned} \dot{Q}_{\text{finned}} &= \eta_{\text{fin}} \dot{Q}_{\text{fin,max}} = \eta_{\text{fin}} h A_{\text{fin}} (T_b - T_{\infty}) \\ &= 0.88(25 \text{ W/m}^2 \cdot ^\circ\text{C})(0.0597 \text{ m}^2)(175.4 - 12)^\circ\text{C} = \mathbf{215 \text{ W}} \end{aligned}$$

(c) A 6-m long section of the steam pipe is losing heat at a rate of 7673 W or $7673/6 = 1279 \text{ W}$ per m length. Then for heat transfer purposes the flange section is equivalent to

$$\text{Equivalent length} = \frac{215 \text{ W}}{1279 \text{ W/m}} = 0.168 \text{ m} = \mathbf{16.8 \text{ cm}}$$

Therefore, the flange acts like a fin and increases the heat transfer by $16.8/2 = 8.4$ times.

Heat Transfer in Common Configurations

3-127C Under steady conditions, the rate of heat transfer between two surfaces is expressed as

$\dot{Q} = Sk(T_1 - T_2)$ where S is the conduction shape factor. It is related to the thermal resistance by $S = 1/(kR)$.

3-128C It provides an easy way of calculating the steady rate of heat transfer between two isothermal surfaces in common configurations.

3-129 The hot water pipe of a district heating system is buried in the soil. The rate of heat loss from the pipe is to be determined.

Assumptions **1** Steady operating conditions exist. **2** Heat transfer is two-dimensional (no change in the axial direction). **3** Thermal conductivity of the soil is constant.

Properties The thermal conductivity of the soil is given to be $k = 0.9 \text{ W/m}\cdot^\circ\text{C}$.

Analysis Since $z > 1.5D$, the shape factor for this configuration is given in Table 3-7 to be

$$S = \frac{2\pi L}{\ln(4z/D)} = \frac{2\pi(20 \text{ m})}{\ln[4(0.8 \text{ m})/(0.08 \text{ m})]} = 34.07 \text{ m}$$

Then the steady rate of heat transfer from the pipe becomes

$$\dot{Q} = Sk(T_1 - T_2) = (34.07 \text{ m})(0.9 \text{ W/m}\cdot^\circ\text{C})(60 - 5)^\circ\text{C} = \mathbf{1686 \text{ W}}$$

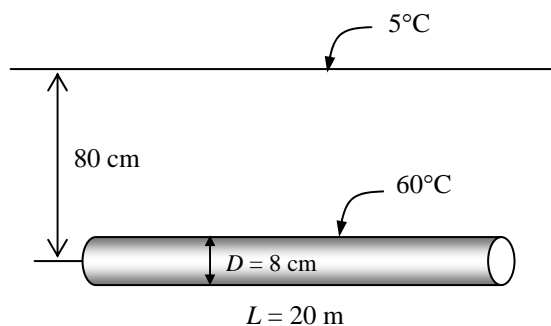

3-130 EES Prob. 3-129 is reconsidered. The rate of heat loss from the pipe as a function of the burial depth is to be plotted.

Analysis The problem is solved using EES, and the solution is given below.

"GIVEN"

$$L=20 \text{ [m]}$$

$$D=0.08 \text{ [m]}$$

$$z=0.80 \text{ [m]}$$

$$T_1=60 \text{ [C]}$$

$$T_2=5 \text{ [C]}$$

$$k=0.9 \text{ [W/m-C]}$$

"ANALYSIS"

$$S=(2*\pi*L)/\ln(4*z/D)$$

$$Q_dot=S*k*(T_1-T_2)$$

z [m]	Q [W]
0.2	2701
0.38	2113
0.56	1867
0.74	1723
0.92	1625
1.1	1552
1.28	1496
1.46	1450
1.64	1412
1.82	1379
2	1351

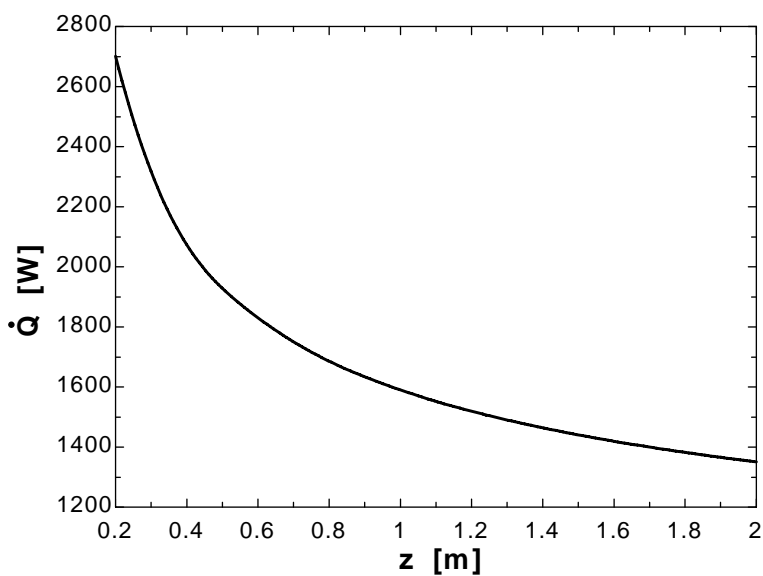

3-131 Hot and cold water pipes run parallel to each other in a thick concrete layer. The rate of heat transfer between the pipes is to be determined.

Assumptions 1 Steady operating conditions exist. 2 Heat transfer is two-dimensional (no change in the axial direction). 3 Thermal conductivity of the concrete is constant.

Properties The thermal conductivity of concrete is given to be $k = 0.75 \text{ W/m}\cdot\text{C}$.

Analysis The shape factor for this configuration is given in Table 3-7 to be

$$S = \frac{2\pi L}{\cosh^{-1}\left(\frac{4z^2 - D_1^2 - D_2^2}{2D_1D_2}\right)}$$

$$= \frac{2\pi(8 \text{ m})}{\cosh^{-1}\left(\frac{4(0.4 \text{ m})^2 - (0.05 \text{ m})^2 - (0.05 \text{ m})^2}{2(0.05 \text{ m})(0.05 \text{ m})}\right)} = 9.078 \text{ m}$$

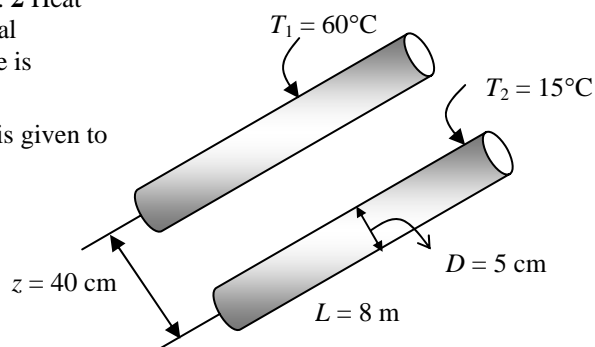

Then the steady rate of heat transfer between the pipes becomes

$$\dot{Q} = Sk(T_1 - T_2) = (9.078 \text{ m})(0.75 \text{ W/m}\cdot\text{C})(60 - 15)^\circ\text{C} = \mathbf{306 \text{ W}}$$

3-132 EES Prob. 3-131 is reconsidered. The rate of heat transfer between the pipes as a function of the distance between the centerlines of the pipes is to be plotted.

Analysis The problem is solved using EES, and the solution is given below.

"GIVEN"

L=8 [m]
 D_1=0.05 [m]
 D_2=D_1
 z=0.40 [m]
 T_1=60 [C]
 T_2=15 [C]
 k=0.75 [W/m-C]

"ANALYSIS"

$S = (2 \cdot \pi \cdot L) / (\operatorname{arccosh}((4 \cdot z^2 - D_1^2 - D_2^2) / (2 \cdot D_1 \cdot D_2)))$
 $\dot{Q} = S \cdot k \cdot (T_1 - T_2)$

z [m]	Q [W]
0.1	644.1
0.2	411.1
0.3	342.3
0.4	306.4
0.5	283.4
0.6	267
0.7	254.7
0.8	244.8
0.9	236.8
1	230

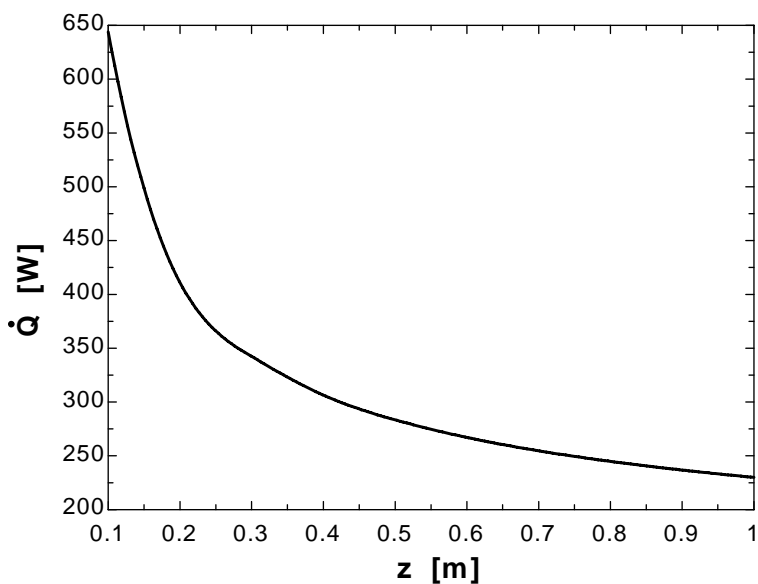

3-133E A row of used uranium fuel rods are buried in the ground parallel to each other. The rate of heat transfer from the fuel rods to the atmosphere through the soil is to be determined.

Assumptions 1 Steady operating conditions exist. 2 Heat transfer is two-dimensional (no change in the axial direction). 3 Thermal conductivity of the soil is constant.

Properties The thermal conductivity of the soil is given to be $k = 0.6 \text{ Btu/h}\cdot\text{ft}\cdot^\circ\text{F}$.

Analysis The shape factor for this configuration is given in Table 3-7 to be

$$S_{\text{total}} = 4 \times \frac{2\pi L}{\ln\left(\frac{2w}{\pi D} \sinh \frac{2\pi z}{w}\right)}$$

$$= 4 \times \frac{2\pi(3 \text{ ft})}{\ln\left(\frac{2(8/12 \text{ ft})}{\pi(1/12 \text{ ft})} \sinh \frac{2\pi(15 \text{ ft})}{(8/12 \text{ ft})}\right)} = 0.5298$$

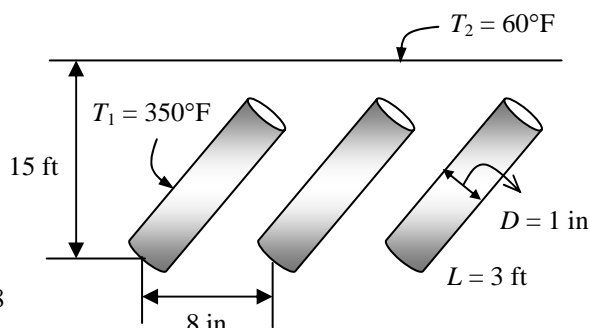

Then the steady rate of heat transfer from the fuel rods becomes

$$\dot{Q} = S_{\text{total}} k (T_1 - T_2) = (0.5298 \text{ ft})(0.6 \text{ Btu/h}\cdot\text{ft}\cdot^\circ\text{F})(350 - 60)^\circ\text{C} = \mathbf{92.2 \text{ Btu/h}}$$

3-134 Hot water flows through a 5-m long section of a thin walled hot water pipe that passes through the center of a 14-cm thick wall filled with fiberglass insulation. The rate of heat transfer from the pipe to the air in the rooms and the temperature drop of the hot water as it flows through the pipe are to be determined.

Assumptions 1 Steady operating conditions exist. 2 Heat transfer is two-dimensional (no change in the axial direction). 3 Thermal conductivity of the fiberglass insulation is constant. 4 The pipe is at the same temperature as the hot water.

Properties The thermal conductivity of fiberglass insulation is given to be $k = 0.035 \text{ W/m}\cdot^\circ\text{C}$.

Analysis (a) The shape factor for this configuration is given in Table 3-7 to be

$$S = \frac{2\pi L}{\ln\left(\frac{8z}{\pi D}\right)} = \frac{2\pi(5 \text{ m})}{\ln\left[\frac{8(0.07 \text{ m})}{\pi(0.025 \text{ m})}\right]} = 16 \text{ m}$$

Then the steady rate of heat transfer from the pipe becomes

$$\dot{Q} = Sk(T_1 - T_2) = (16 \text{ m})(0.035 \text{ W/m}\cdot^\circ\text{C})(53 - 18)^\circ\text{C} = \mathbf{19.6 \text{ W}}$$

(b) Using the water properties at the room temperature, the temperature drop of the hot water as it flows through this 5-m section of the wall becomes

$$\dot{Q} = \dot{m} c_p \Delta T$$

$$\Delta T = \frac{\dot{Q}}{\dot{m} c_p} = \frac{\dot{Q}}{\rho \dot{V} c_p} = \frac{\dot{Q}}{\rho V A_c c_p} = \frac{19.6 \text{ J/s}}{(1000 \text{ kg/m}^3)(0.4 \text{ m/s}) \left[\frac{\pi(0.025 \text{ m})^2}{4} \right] (4180 \text{ J/kg}\cdot^\circ\text{C})} = \mathbf{0.024^\circ\text{C}}$$

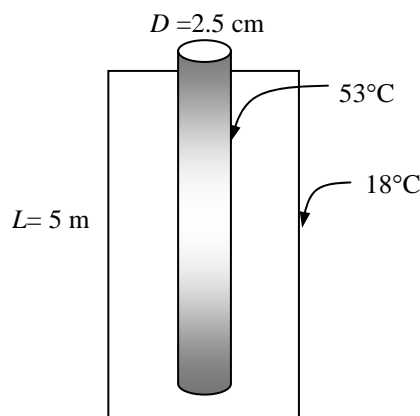

3-135 Hot water is flowing through a pipe that extends 2 m in the ambient air and continues in the ground before it enters the next building. The surface of the ground is covered with snow at 0°C. The total rate of heat loss from the hot water and the temperature drop of the hot water in the pipe are to be determined.

Assumptions 1 Steady operating conditions exist. 2 Heat transfer is two-dimensional (no change in the axial direction). 3 Thermal conductivity of the ground is constant. 4 The pipe is at the same temperature as the hot water.

Properties The thermal conductivity of the ground is given to be $k = 1.5 \text{ W/m}\cdot\text{°C}$.

Analysis (a) We assume that the surface temperature of the tube is equal to the temperature of the water. Then the heat loss from the part of the tube that is on the ground is

$$A_s = \pi DL = \pi(0.05 \text{ m})(2 \text{ m}) = 0.3142 \text{ m}^2$$

$$\dot{Q} = hA_s(T_s - T_\infty)$$

$$= (22 \text{ W/m}^2\cdot\text{°C})(0.3142 \text{ m}^2)(80 - 8)\text{°C} = 498 \text{ W}$$

Considering the shape factor, the heat loss for vertical part of the tube can be determined from

$$S = \frac{2\pi L}{\ln\left(\frac{4L}{D}\right)} = \frac{2\pi(3 \text{ m})}{\ln\left[\frac{4(3 \text{ m})}{(0.05 \text{ m})}\right]} = 3.44 \text{ m}$$

$$\dot{Q} = Sk(T_1 - T_2) = (3.44 \text{ m})(1.5 \text{ W/m}\cdot\text{°C})(80 - 0)\text{°C} = 413 \text{ W}$$

The shape factor, and the rate of heat loss on the horizontal part that is in the ground are

$$S = \frac{2\pi L}{\ln\left(\frac{4z}{D}\right)} = \frac{2\pi(20 \text{ m})}{\ln\left[\frac{4(3 \text{ m})}{(0.05 \text{ m})}\right]} = 22.9 \text{ m}$$

$$\dot{Q} = Sk(T_1 - T_2) = (22.9 \text{ m})(1.5 \text{ W/m}\cdot\text{°C})(80 - 0)\text{°C} = 2748 \text{ W}$$

and the total rate of heat loss from the hot water becomes

$$\dot{Q}_{\text{total}} = 498 + 413 + 2748 = \mathbf{3659 \text{ W}}$$

(b) Using the water properties at the room temperature, the temperature drop of the hot water as it flows through this 25-m section of the wall becomes

$$\dot{Q} = \dot{m}c_p \Delta T$$

$$\Delta T = \frac{\dot{Q}}{\dot{m}c_p} = \frac{\dot{Q}}{(\rho \dot{V})c_p} = \frac{\dot{Q}}{(\rho VA_c)c_p} = \frac{3659 \text{ J/s}}{(1000 \text{ kg/m}^3)(1.5 \text{ m/s})\left[\frac{\pi(0.05 \text{ m})^2}{4}\right](4180 \text{ J/kg}\cdot\text{°C})} = \mathbf{0.32\text{°C}}$$

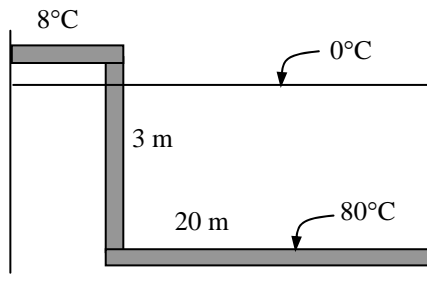

3-136 The walls and the roof of the house are made of 20-cm thick concrete, and the inner and outer surfaces of the house are maintained at specified temperatures. The rate of heat loss from the house through its walls and the roof is to be determined, and the error involved in ignoring the edge and corner effects is to be assessed.

Assumptions 1 Steady operating conditions exist. 2 Heat transfer at the edges and corners is two- or three-dimensional. 3 Thermal conductivity of the concrete is constant. 4 The edge effects of adjoining surfaces on heat transfer are to be considered.

Properties The thermal conductivity of the concrete is given to be $k = 0.75 \text{ W/m}\cdot^\circ\text{C}$.

Analysis The rate of heat transfer excluding the edges and corners is first determined to be

$$A_{\text{total}} = (12 - 0.4)(12 - 0.4) + 4(12 - 0.4)(6 - 0.2) = 403.7 \text{ m}^2$$

$$\dot{Q} = \frac{kA_{\text{total}}}{L}(T_1 - T_2) = \frac{(0.75 \text{ W/m}\cdot^\circ\text{C})(403.7 \text{ m}^2)}{0.2 \text{ m}}(15 - 3)^\circ\text{C} = 18,167 \text{ W}$$

The heat transfer rate through the edges can be determined using the shape factor relations in Table 3-7,

$$S_{\text{corners+edges}} = 4 \times \text{corners} + 4 \times \text{edges} = 4 \times 0.15L + 4 \times 0.54w$$

$$= 4 \times 0.15(0.2 \text{ m}) + 4 \times 0.54(12 \text{ m}) = 26.04 \text{ m}$$

$$\dot{Q}_{\text{corners+edges}} = S_{\text{corners+edges}}k(T_1 - T_2) = (26.04 \text{ m})(0.75 \text{ W/m}\cdot^\circ\text{C})(15 - 3)^\circ\text{C} = 234 \text{ W}$$

and $\dot{Q}_{\text{total}} = 18,167 + 234 = 1.840 \times 10^4 \text{ W} = \mathbf{18.4 \text{ kW}}$

Ignoring the edge effects of adjoining surfaces, the rate of heat transfer is determined from

$$A_{\text{total}} = (12)(12) + 4(12)(6) = 432 \text{ m}^2$$

$$\dot{Q} = \frac{kA_{\text{total}}}{L}(T_1 - T_2) = \frac{(0.75 \text{ W/m}\cdot^\circ\text{C})(432 \text{ m}^2)}{0.2 \text{ m}}(15 - 3)^\circ\text{C} = 1.94 \times 10^4 = 19.4 \text{ kW}$$

The percentage error involved in ignoring the effects of the edges then becomes

$$\% \text{ error} = \frac{19.4 - 18.4}{18.4} \times 100 = \mathbf{5.4\%}$$

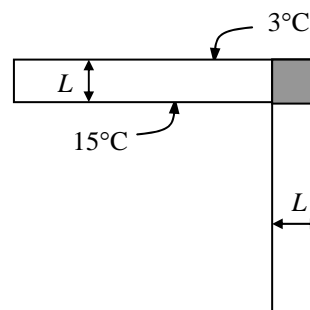

3-137 The inner and outer surfaces of a long thick-walled concrete duct are maintained at specified temperatures. The rate of heat transfer through the walls of the duct is to be determined.

Assumptions 1 Steady operating conditions exist. 2 Heat transfer is two-dimensional (no change in the axial direction). 3 Thermal conductivity of the concrete is constant.

Properties The thermal conductivity of concrete is given to be $k = 0.75 \text{ W/m}\cdot^\circ\text{C}$.

Analysis The shape factor for this configuration is given in Table 3-7 to be

$$\frac{a}{b} = \frac{20}{16} = 1.25 < 1.41 \longrightarrow S = \frac{2\pi L}{0.785 \ln\left(\frac{a}{b}\right)} = \frac{2\pi(25 \text{ m})}{0.785 \ln 1.25} = 896.7 \text{ m}$$

Then the steady rate of heat transfer through the walls of the duct becomes

$$\dot{Q} = Sk(T_1 - T_2) = (896.7 \text{ m})(0.75 \text{ W/m}\cdot^\circ\text{C})(100 - 30)^\circ\text{C} = 4.71 \times 10^4 \text{ W} = \mathbf{47.1 \text{ kW}}$$

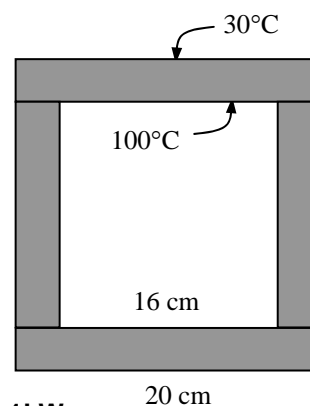

3-138 A spherical tank containing some radioactive material is buried in the ground. The tank and the ground surface are maintained at specified temperatures. The rate of heat transfer from the tank is to be determined.

Assumptions 1 Steady operating conditions exist. 2 Heat transfer is two-dimensional (no change in the axial direction). 3 Thermal conductivity of the ground is constant.

Properties The thermal conductivity of the ground is given to be $k = 1.4 \text{ W/m}\cdot\text{°C}$.

Analysis The shape factor for this configuration is given in Table 3-7 to be

$$S = \frac{2\pi D}{1 - 0.25 \frac{D}{z}} = \frac{2\pi(3 \text{ m})}{1 - 0.25 \frac{3 \text{ m}}{5.5 \text{ m}}} = 21.83 \text{ m}$$

Then the steady rate of heat transfer from the tank becomes

$$\dot{Q} = Sk(T_1 - T_2) = (21.83 \text{ m})(1.4 \text{ W/m}\cdot\text{°C})(140 - 15)\text{°C} = \mathbf{3820 \text{ W}}$$

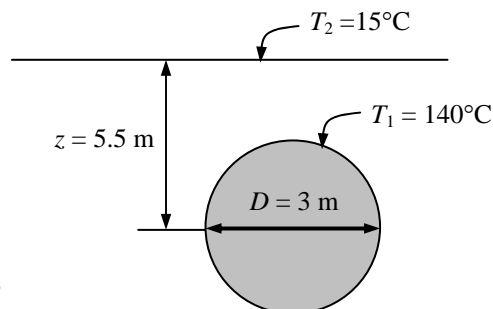

3-139 EES Prob. 3-138 is reconsidered. The rate of heat transfer from the tank as a function of the tank diameter is to be plotted.

Analysis The problem is solved using EES, and the solution is given below.

"GIVEN"

D=3 [m]
k=1.4 [W/m-C]
h=4 [m]
T_1=140 [C]
T_2=15 [C]

"ANALYSIS"

z=h+D/2
S=(2*pi*D)/(1-0.25*D/z)
Q_dot=S*k*(T_1-T_2)

D [m]	Q [W]
0.5	566.4
1	1164
1.5	1791
2	2443
2.5	3120
3	3820
3.5	4539
4	5278
4.5	6034
5	6807

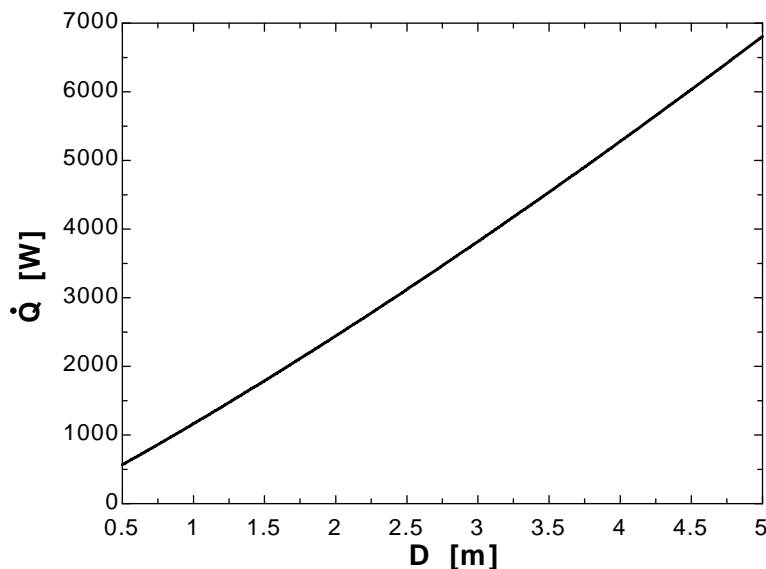

3-140 Hot water passes through a row of 8 parallel pipes placed vertically in the middle of a concrete wall whose surfaces are exposed to a medium at 20°C with a heat transfer coefficient of 8 W/m²·°C. The rate of heat loss from the hot water, and the surface temperature of the wall are to be determined.

Assumptions 1 Steady operating conditions exist. 2 Heat transfer is two-dimensional (no change in the axial direction). 3 Thermal conductivity of concrete is constant.

Properties The thermal conductivity of concrete is given to be $k = 0.75 \text{ W/m}\cdot\text{°C}$.

Analysis The shape factor for this configuration is given in Table 3-7 to be

$$S = \frac{2\pi L}{\ln\left(\frac{8z}{\pi D}\right)} = \frac{2\pi(4 \text{ m})}{\ln\left(\frac{8(0.075 \text{ m})}{\pi(0.03 \text{ m})}\right)} = 13.58 \text{ m}$$

Then rate of heat loss from the hot water in 8 parallel pipes becomes

$$\dot{Q} = 8Sk(T_1 - T_2) = 8(13.58 \text{ m})(0.75 \text{ W/m}\cdot\text{°C})(85 - 32)\text{°C} = \mathbf{4318 \text{ W}}$$

The surface temperature of the wall can be determined from

$$A_s = 2(4 \text{ m})(8 \text{ m}) = 64 \text{ m}^2 \quad (\text{from both sides})$$

$$\dot{Q} = hA_s(T_s - T_\infty) \longrightarrow T_s = T_\infty + \frac{\dot{Q}}{hA_s} = 32\text{°C} + \frac{4318 \text{ W}}{(12 \text{ W/m}^2\cdot\text{°C})(64 \text{ m}^2)} = \mathbf{37.6\text{°C}}$$

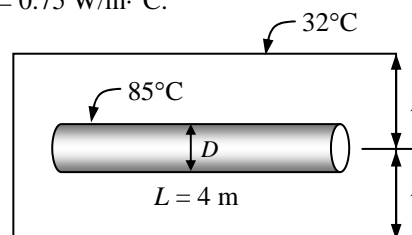

Special Topic: Heat Transfer through the Walls and Roofs

3-141C The R -value of a wall is the thermal resistance of the wall per unit surface area. It is the same as the unit thermal resistance of the wall. It is the inverse of the U -factor of the wall, $R = 1/U$.

3-142C The effective emissivity for a plane-parallel air space is the “equivalent” emissivity of one surface for use in the relation $\dot{Q}_{\text{rad}} = \varepsilon_{\text{effective}} \sigma A_s (T_2^4 - T_1^4)$ that results in the same rate of radiation heat transfer between the two surfaces across the air space. It is determined from

$$\frac{1}{\varepsilon_{\text{effective}}} = \frac{1}{\varepsilon_1} + \frac{1}{\varepsilon_2} - 1$$

where ε_1 and ε_2 are the emissivities of the surfaces of the air space. When the effective emissivity is known, the radiation heat transfer through the air space is determined from the \dot{Q}_{rad} relation above.

3-143C The unit thermal resistances (R -value) of both 40-mm and 90-mm vertical air spaces are given to be the same, which implies that more than doubling the thickness of air space in a wall has no effect on heat transfer through the wall. This is not surprising since the convection currents that set in in the thicker air space offset any additional resistance due to a thicker air space.

3-144C Radiant barriers are highly reflective materials that minimize the radiation heat transfer between surfaces. Highly reflective materials such as aluminum foil or aluminum coated paper are suitable for use as radiant barriers. Yes, it is worthwhile to use radiant barriers in the attics of homes by covering at least one side of the attic (the roof or the ceiling side) since they reduce radiation heat transfer between the ceiling and the roof considerably.

3-145C The roof of a house whose attic space is ventilated effectively so that the air temperature in the attic is the same as the ambient air temperature at all times will still have an effect on heat transfer through the ceiling since the roof in this case will act as a radiation shield, and reduce heat transfer by radiation.

3-146 The R -value and the U -factor of a wood frame wall are to be determined.

Assumptions **1** Steady operating conditions exist. **2** Heat transfer through the wall is one-dimensional. **3** Thermal properties of the wall and the heat transfer coefficients are constant.

Properties The R -values of different materials are given in Table 3-8.

Analysis The schematic of the wall as well as the different elements used in its construction are shown below. Heat transfer through the insulation and through the studs will meet different resistances, and thus we need to analyze the thermal resistance for each path separately. Once the unit thermal resistances and the U -factors for the insulation and stud sections are available, the overall average thermal resistance for the entire wall can be determined from

$$R_{\text{overall}} = 1/U_{\text{overall}} \quad \text{where} \quad U_{\text{overall}} = (Uf_{\text{area}})_{\text{insulation}} + (Uf_{\text{area}})_{\text{stud}}$$

and the value of the area fraction f_{area} is 0.80 for insulation section and 0.20 for stud section since the headers that constitute a small part of the wall are to be treated as studs. Using the available R -values from Table 3-8 and calculating others, the total R -values for each section is determined in the table below.

Construction	R -value, $\text{m}^2 \cdot ^\circ\text{C}/\text{W}$	
	Between studs	At studs
1. Outside surface, 12 km/h wind	0.044	0.044
2. Wood bevel lapped siding	0.14	0.14
3. Fiberboard sheathing, 13 mm	0.23	0.23
4a. Mineral fiber insulation, 140 mm	3.696	--
4b. Wood stud, 38 mm by 140 mm	--	0.98
5. Gypsum wallboard, 13 mm	0.079	0.079
6. Inside surface, still air	0.12	0.12

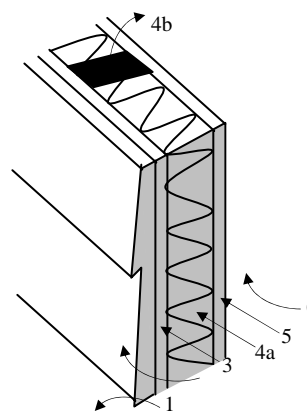

Total unit thermal resistance of each section, R (in $\text{m}^2 \cdot ^\circ\text{C}/\text{W}$)	4.309	1.593
The U -factor of each section, $U = 1/R$, in $\text{W}/\text{m}^2 \cdot ^\circ\text{C}$	0.232	0.628
Area fraction of each section, f_{area}	0.80	0.20
Overall U -factor, $U = \sum f_{\text{area},i} U_i = 0.80 \times 0.232 + 0.20 \times 0.628$	0.311 $\text{W}/\text{m}^2 \cdot ^\circ\text{C}$	
Overall unit thermal resistance, $R = 1/U$	3.213 $\text{m}^2 \cdot ^\circ\text{C}/\text{W}$	

Therefore, the R -value and U -factor of the wall are $R = 3.213 \text{ m}^2 \cdot ^\circ\text{C}/\text{W}$ and $U = 0.311 \text{ W}/\text{m}^2 \cdot ^\circ\text{C}$.

3-147 The change in the R -value of a wood frame wall due to replacing fiberwood sheathing in the wall by rigid foam sheathing is to be determined.

Assumptions 1 Steady operating conditions exist. 2 Heat transfer through the wall is one-dimensional. 3 Thermal properties of the wall and the heat transfer coefficients are constant.

Properties The R -values of different materials are given in Table 3-8.

Analysis The schematic of the wall as well as the different elements used in its construction are shown below. Heat transfer through the insulation and through the studs will meet different resistances, and thus we need to analyze the thermal resistance for each path separately. Once the unit thermal resistances and the U -factors for the insulation and stud sections are available, the overall average thermal resistance for the entire wall can be determined from

$$R_{\text{overall}} = 1/U_{\text{overall}} \quad \text{where} \quad U_{\text{overall}} = (Uf_{\text{area}})_{\text{insulation}} + (Uf_{\text{area}})_{\text{stud}}$$

and the value of the area fraction f_{area} is 0.80 for insulation section and 0.20 for stud section since the headers that constitute a small part of the wall are to be treated as studs. Using the available R -values from Table 3-6 and calculating others, the total R -values for each section of the existing wall is determined in the table below.

Construction	R -value, $\text{m}^2 \cdot \text{C}/\text{W}$	
	Between studs	At studs
1. Outside surface, 12 km/h wind	0.044	0.044
2. Wood bevel lapped siding	0.14	0.14
3. Rigid foam, 25 mm	0.98	0.98
4a. Mineral fiber insulation, 140 mm	3.696	--
4b. Wood stud, 38 mm by 140 mm	--	0.98
5. Gypsum wallboard, 13 mm	0.079	0.079
6. Inside surface, still air	0.12	0.12

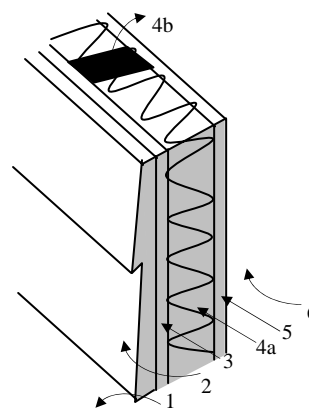

Total unit thermal resistance of each section, R (in $\text{m}^2 \cdot \text{C}/\text{W}$)	5.059	2.343
The U -factor of each section, $U = 1/R$, in $\text{W}/\text{m}^2 \cdot \text{C}$	0.198	0.426
Area fraction of each section, f_{area}	0.80	0.20
Overall U -factor, $U = \sum f_{\text{area},i} U_i = 0.80 \times 0.232 + 0.20 \times 0.628$	0.2436 $\text{W}/\text{m}^2 \cdot \text{C}$	
Overall unit thermal resistance, $R = 1/U$	4.105 $\text{m}^2 \cdot \text{C}/\text{W}$	

The R -value of the existing wall is $R = 3.213 \text{ m}^2 \cdot \text{C}/\text{W}$. Then the change in the R -value becomes

$$\% \text{ Change} = \frac{\Delta R - \text{value}}{R - \text{value, old}} = \frac{4.105 - 3.213}{4.105} = 0.217 \quad (\text{or } \mathbf{21.7\%})$$

3-148E The R -value and the U -factor of a masonry cavity wall are to be determined.

Assumptions **1** Steady operating conditions exist. **2** Heat transfer through the wall is one-dimensional. **3** Thermal properties of the wall and the heat transfer coefficients are constant.

Properties The R -values of different materials are given in Table 3-8.

Analysis The schematic of the wall as well as the different elements used in its construction are shown below. Heat transfer through the air space and through the studs will meet different resistances, and thus we need to analyze the thermal resistance for each path separately. Once the unit thermal resistances and the U -factors for the air space and stud sections are available, the overall average thermal resistance for the entire wall can be determined from

$$R_{\text{overall}} = 1/U_{\text{overall}} \quad \text{where} \quad U_{\text{overall}} = (U_{f_{\text{area}}})_{\text{air space}} + (U_{f_{\text{area}}})_{\text{stud}}$$

and the value of the area fraction f_{area} is 0.80 for air space and 0.20 for the furrings and similar structures. Using the available R -values from Table 3-8 and calculating others, the total R -values for each section of the existing wall is determined in the table below.

Construction	R -value, h.ft ² .°F/Btu	
	Between furring	At furring
1. Outside surface, 15 mph wind	0.17	0.17
2. Face brick, 4 in	0.43	0.43
3. Cement mortar, 0.5 in	0.10	0.10
4. Concrete block, 4-in	1.51	1.51
5a. Air space, 3/4-in, nonreflective	2.91	--
5b. Nominal 1 × 3 vertical furring	--	0.94
6. Gypsum wallboard, 0.5 in	0.45	0.45
7. Inside surface, still air	0.68	0.68

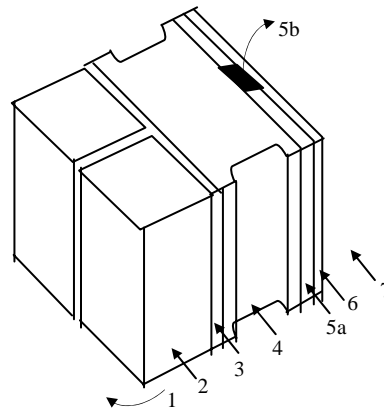

Total unit thermal resistance of each section, R	6.25	4.28
The U -factor of each section, $U = 1/R$, in Btu/h.ft ² .°F	0.160	0.234
Area fraction of each section, f_{area}	0.80	0.20
Overall U -factor, $U = \sum f_{\text{area},i} U_i = 0.80 \times 0.160 + 0.20 \times 0.234$	0.175 Btu/h.ft².°F	
Overall unit thermal resistance, $R = 1/U$	5.72 h.ft².°F/Btu	

Therefore, the overall unit thermal resistance of the wall is $R = 5.72 \text{ h.ft}^2 \cdot \text{°F/Btu}$ and the overall U -factor is $U = 0.175 \text{ Btu/h.ft}^2 \cdot \text{°F}$. These values account for the effects of the vertical furring.

3-149 The winter R -value and the U -factor of a flat ceiling with an air space are to be determined for the cases of air space with reflective and nonreflective surfaces.

Assumptions 1 Steady operating conditions exist. 2 Heat transfer through the ceiling is one-dimensional. 3 Thermal properties of the ceiling and the heat transfer coefficients are constant.

Properties The R -values are given in Table 3-8 for different materials, and in Table 3-11 for air layers.

Analysis The schematic of the ceiling as well as the different elements used in its construction are shown below. Heat transfer through the air space and through the studs will meet different resistances, and thus we need to analyze the thermal resistance for each path separately. Once the unit thermal resistances and the U -factors for the air space and stud sections are available, the overall average thermal resistance for the entire wall can be determined from

$R_{\text{overall}} = 1/U_{\text{overall}}$ where $U_{\text{overall}} = (Uf_{\text{area}})_{\text{air space}} + (Uf_{\text{area}})_{\text{stud}}$ and the value of the area fraction f_{area} is 0.82 for air space and 0.18 for stud section since the headers which constitute a small part of the wall are to be treated as studs.

(a) Nonreflective surfaces, $\varepsilon_1 = \varepsilon_2 = 0.9$ and thus $\varepsilon_{\text{effective}} = \frac{1}{1/\varepsilon_1 + 1/\varepsilon_2 - 1} = \frac{1}{1/0.9 + 1/0.9 - 1} = 0.82$

Construction	R -value, $\text{m}^2 \cdot \text{C}/\text{W}$	
	Between studs	At studs
1. Still air above ceiling	0.12	0.044
2. Linoleum ($R = 0.009 \text{ m}^2 \cdot \text{C}/\text{W}$)	0.009	0.14
3. Felt ($R = 0.011 \text{ m}^2 \cdot \text{C}/\text{W}$)	0.011	0.23
4. Plywood, 13 mm	0.11	
5. Wood subfloor ($R = 0.166 \text{ m}^2 \cdot \text{C}/\text{W}$)	0.166	
6a. Air space, 90 mm, nonreflective	0.16	---
6b. Wood stud, 38 mm by 90 mm	---	0.63
7. Gypsum wallboard, 13 mm	0.079	0.079
8. Still air below ceiling	0.12	0.12

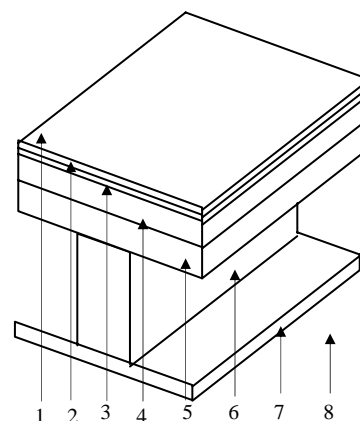

Total unit thermal resistance of each section, R (in $\text{m}^2 \cdot \text{C}/\text{W}$)	0.775	1.243
The U -factor of each section, $U = 1/R$, in $\text{W}/\text{m}^2 \cdot \text{C}$	1.290	0.805
Area fraction of each section, f_{area}	0.82	0.18
Overall U -factor, $U = \sum f_{\text{area},i} U_i = 0.82 \times 1.290 + 0.18 \times 0.805$	1.203 $\text{W}/\text{m}^2 \cdot \text{C}$	
Overall unit thermal resistance, $R = 1/U$	0.831 $\text{m}^2 \cdot \text{C}/\text{W}$	

(b) One-reflective surface, $\varepsilon_1 = 0.05$ and $\varepsilon_2 = 0.9 \rightarrow \varepsilon_{\text{effective}} = \frac{1}{1/\varepsilon_1 + 1/\varepsilon_2 - 1} = \frac{1}{1/0.05 + 1/0.9 - 1} = 0.05$

In this case we replace item 6a from 0.16 to 0.47 $\text{m}^2 \cdot \text{C}/\text{W}$. It gives $R = 1.085 \text{ m}^2 \cdot \text{C}/\text{W}$ and $U = 0.922 \text{ W}/\text{m}^2 \cdot \text{C}$ for the air space. Then,

Overall U -factor, $U = \sum f_{\text{area},i} U_i = 0.82 \times 1.085 + 0.18 \times 0.805$	1.035 $\text{W}/\text{m}^2 \cdot \text{C}$
Overall unit thermal resistance, $R = 1/U$	0.967 $\text{m}^2 \cdot \text{C}/\text{W}$

(c) Two-reflective surface, $\varepsilon_1 = \varepsilon_2 = 0.05 \rightarrow \varepsilon_{\text{effective}} = \frac{1}{1/\varepsilon_1 + 1/\varepsilon_2 - 1} = \frac{1}{1/0.05 + 1/0.05 - 1} = 0.03$

In this case we replace item 6a from 0.16 to 0.49 $\text{m}^2 \cdot \text{C}/\text{W}$. It gives $R = 1.105 \text{ m}^2 \cdot \text{C}/\text{W}$ and $U = 0.905 \text{ W}/\text{m}^2 \cdot \text{C}$ for the air space. Then,

Overall U -factor, $U = \sum f_{\text{area},i} U_i = 0.82 \times 1.105 + 0.18 \times 0.805$	1.051 $\text{W}/\text{m}^2 \cdot \text{C}$
Overall unit thermal resistance, $R = 1/U$	0.951 $\text{m}^2 \cdot \text{C}/\text{W}$

3-150 The winter R -value and the U -factor of a masonry cavity wall are to be determined.

Assumptions **1** Steady operating conditions exist. **2** Heat transfer through the wall is one-dimensional. **3** Thermal properties of the wall and the heat transfer coefficients are constant.

Properties The R -values of different materials are given in Table 3-8.

Analysis The schematic of the wall as well as the different elements used in its construction are shown below. Heat transfer through the air space and through the studs will meet different resistances, and thus we need to analyze the thermal resistance for each path separately. Once the unit thermal resistances and the U -factors for the air space and stud sections are available, the overall average thermal resistance for the entire wall can be determined from

$$R_{\text{overall}} = 1/U_{\text{overall}} \quad \text{where} \quad U_{\text{overall}} = (Uf_{\text{area}})_{\text{air space}} + (Uf_{\text{area}})_{\text{stud}}$$

and the value of the area fraction f_{area} is 0.84 for air space and 0.16 for the ferrings and similar structures. Using the available R -values from Tables 3-8 and 3-11 and calculating others, the total R -values for each section of the existing wall is determined in the table below.

Construction	R -value, $\text{m}^2 \cdot ^\circ\text{C}/\text{W}$	
	Between furring	At furring
1. Outside surface, 24 km/h	0.030	0.030
2. Face brick, 100 mm	0.12	0.12
3. Air space, 90-mm, nonreflective	0.16	0.16
4. Concrete block, lightweight, 100-mm	0.27	0.27
5a. Air space, 20 mm, nonreflective	0.17	---
5b. Vertical furring, 20 mm thick	---	0.94
6. Gypsum wallboard, 13	0.079	0.079
7. Inside surface, still air	0.12	0.12

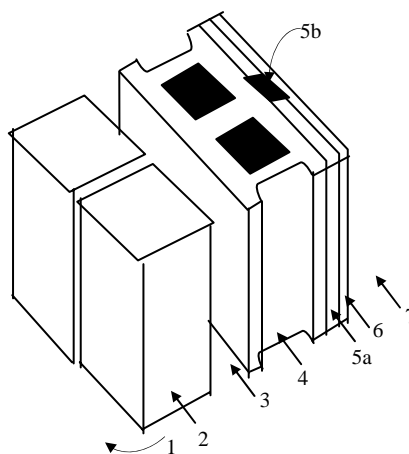

Total unit thermal resistance of each section, R	0.949	1.719
The U -factor of each section, $U = 1/R$, in $\text{W}/\text{m}^2 \cdot ^\circ\text{C}$	1.054	0.582
Area fraction of each section, f_{area}	0.84	0.16
Overall U -factor, $U = \sum f_{\text{area},i} U_i = 0.84 \times 1.054 + 0.16 \times 0.582$	0.978 $\text{W}/\text{m}^2 \cdot ^\circ\text{C}$	
Overall unit thermal resistance, $R = 1/U$	1.02 $\text{m}^2 \cdot ^\circ\text{C}/\text{W}$	

Therefore, the overall unit thermal resistance of the wall is $R = 1.02 \text{ m}^2 \cdot ^\circ\text{C}/\text{W}$ and the overall U -factor is $U = 0.978 \text{ W}/\text{m}^2 \cdot ^\circ\text{C}$. These values account for the effects of the vertical furring.

3-151 The winter R -value and the U -factor of a masonry cavity wall with a reflective surface are to be determined.

Assumptions 1 Steady operating conditions exist. 2 Heat transfer through the wall is one-dimensional. 3 Thermal properties of the wall and the heat transfer coefficients are constant.

Properties The R -values of different materials are given in Table 3-8. The R -values of air spaces are given in Table 3-11.

Analysis The schematic of the wall as well as the different elements used in its construction are shown below. Heat transfer through the air space and through the studs will meet different resistances, and thus we need to analyze the thermal resistance for each path separately. Once the unit thermal resistances and the U -factors for the air space and stud sections are available, the overall average thermal resistance for the entire wall can be determined from

$$R_{\text{overall}} = 1/U_{\text{overall}} \quad \text{where} \quad U_{\text{overall}} = (Uf_{\text{area}})_{\text{air space}} + (Uf_{\text{area}})_{\text{stud}}$$

and the value of the area fraction f_{area} is 0.84 for air space and 0.16 for the furrings and similar structures. For an air space with one-reflective surface, we have $\varepsilon_1 = 0.05$ and $\varepsilon_2 = 0.9$, and thus

$$\varepsilon_{\text{effective}} = \frac{1}{1/\varepsilon_1 + 1/\varepsilon_2 - 1} = \frac{1}{1/0.05 + 1/0.9 - 1} = 0.05$$

Using the available R -values from Tables 3-8 and 3-11 and calculating others, the total R -values for each section of the existing wall is determined in the table below.

Construction	R -value, $\text{m}^2 \cdot ^\circ\text{C}/\text{W}$	
	Between furring	At furring
1. Outside surface, 24 km/h	0.030	0.030
2. Face brick, 100 mm	0.12	0.12
3. Air space, 90-mm, reflective with $\varepsilon = 0.05$	0.45	0.45
4. Concrete block, lightweight, 100-mm	0.27	0.27
5a. Air space, 20 mm, reflective with $\varepsilon = 0.05$	0.49	---
5b. Vertical furring, 20 mm thick	---	0.94
6. Gypsum wallboard, 13	0.079	0.079
7. Inside surface, still air	0.12	0.12

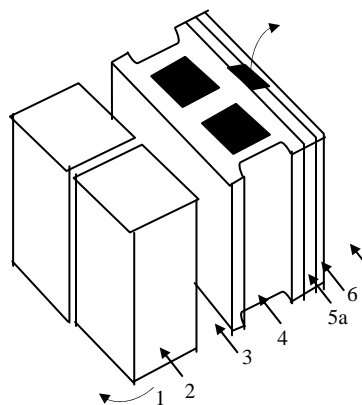

Total unit thermal resistance of each section, R	1.559	2.009
The U -factor of each section, $U = 1/R$, in $\text{W}/\text{m}^2 \cdot ^\circ\text{C}$	0.641	0.498
Area fraction of each section, f_{area}	0.84	0.16
Overall U -factor, $U = \sum f_{\text{area},i} U_i = 0.84 \times 0.641 + 0.16 \times 0.498$	$0.618 \text{ W}/\text{m}^2 \cdot ^\circ\text{C}$	
Overall unit thermal resistance, $R = 1/U$	$1.62 \text{ m}^2 \cdot ^\circ\text{C}/\text{W}$	

Therefore, the overall unit thermal resistance of the wall is $R = 1.62 \text{ m}^2 \cdot ^\circ\text{C}/\text{W}$ and the overall U -factor is $U = 0.618 \text{ W}/\text{m}^2 \cdot ^\circ\text{C}$. These values account for the effects of the vertical furring.

Discussion The change in the U -value as a result of adding reflective surfaces is

$$\text{Change} = \frac{\Delta U - \text{value}}{U - \text{value, nonreflective}} = \frac{0.978 - 0.618}{0.978} = 0.368$$

Therefore, the rate of heat transfer through the wall will decrease by 36.8% as a result of adding a reflective surface.

3-152 The winter R -value and the U -factor of a masonry wall are to be determined.

Assumptions **1** Steady operating conditions exist. **2** Heat transfer through the wall is one-dimensional. **3** Thermal properties of the wall and the heat transfer coefficients are constant.

Properties The R -values of different materials are given in Table 3-8.

Analysis Using the available R -values from Tables 3-8, the total R -value of the wall is determined in the table below.

Construction	R -value, $\text{m}^2 \cdot ^\circ\text{C}/\text{W}$
1. Outside surface, 24 km/h	0.030
2. Face brick, 100 mm	0.075
3. Common brick, 100 mm	0.12
4. Urethane foam insulation, 25-mm	0.98
5. Gypsum wallboard, 13 mm	0.079
6. Inside surface, still air	0.12

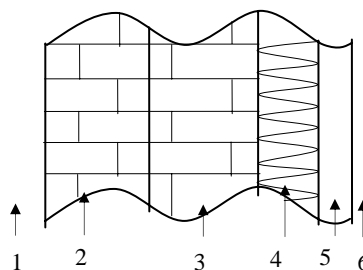

Total unit thermal resistance of each section, R	1.404 $\text{m}^2 \cdot ^\circ\text{C}/\text{W}$
The U -factor of each section, $U = 1/R$	0.712 $\text{W}/\text{m}^2 \cdot ^\circ\text{C}$

Therefore, the overall unit thermal resistance of the wall is $R = 1.404 \text{ m}^2 \cdot ^\circ\text{C}/\text{W}$ and the overall U -factor is $U = 0.712 \text{ W}/\text{m}^2 \cdot ^\circ\text{C}$.

3-153 The U -value of a wall under winter design conditions is given. The U -value of the wall under summer design conditions is to be determined.

Assumptions **1** Steady operating conditions exist. **2** Heat transfer through the wall is one-dimensional. **3** Thermal properties of the wall and the heat transfer coefficients are constant except the one at the outer surface.

Properties The R -values at the outer surface of a wall for summer (12 km/h winds) and winter (24 km/h winds) conditions are given in Table 3-8 to be $R_{o, \text{summer}} = 0.044 \text{ m}^2 \cdot ^\circ\text{C}/\text{W}$ and $R_{o, \text{winter}} = 0.030 \text{ m}^2 \cdot ^\circ\text{C}/\text{W}$.

Analysis The R -value of the existing wall is

$$R_{\text{winter}} = 1/U_{\text{winter}} = 1/1.40 = 0.714 \text{ m}^2 \cdot ^\circ\text{C}/\text{W}$$

Noting that the added and removed thermal resistances are in series, the overall R -value of the wall under summer conditions becomes

$$\begin{aligned} R_{\text{summer}} &= R_{\text{winter}} - R_{o, \text{winter}} + R_{o, \text{summer}} \\ &= 0.714 - 0.030 + 0.044 \\ &= 0.728 \text{ m}^2 \cdot ^\circ\text{C}/\text{W} \end{aligned}$$

Then the summer U -value of the wall becomes

$$R_{\text{summer}} = 1/U_{\text{summer}} = 1/0.728 = \mathbf{1.37 \text{ m}^2 \cdot ^\circ\text{C}/\text{W}}$$

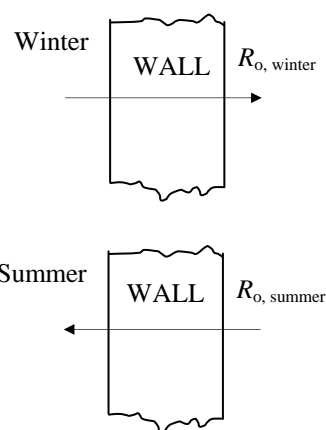

3-154 The U -value of a wall is given. A layer of face brick is added to the outside of a wall, leaving a 20-mm air space between the wall and the bricks. The new U -value of the wall and the rate of heat transfer through the wall is to be determined.

Assumptions 1 Steady operating conditions exist. 2 Heat transfer through the wall is one-dimensional. 3 Thermal properties of the wall and the heat transfer coefficients are constant.

Properties The U -value of a wall is given to be $U = 2.25 \text{ W/m}^2 \cdot ^\circ\text{C}$. The R -values of 100-mm face brick and a 20-mm air space between the wall and the bricks various layers are 0.075 and $0.170 \text{ m}^2 \cdot ^\circ\text{C/W}$, respectively.

Analysis The R -value of the existing wall for the winter conditions is

$$R_{\text{existing wall}} = 1/U_{\text{existing wall}} = 1/2.25 = 0.444 \text{ m}^2 \cdot ^\circ\text{C/W}$$

Noting that the added thermal resistances are in series, the overall R -value of the wall becomes

$$\begin{aligned} R_{\text{modified wall}} &= R_{\text{existing wall}} + R_{\text{brick}} + R_{\text{air layer}} \\ &= 0.44 + 0.075 + 0.170 = 0.689 \text{ m}^2 \cdot ^\circ\text{C/W} \end{aligned}$$

Then the U -value of the wall after modification becomes

$$R_{\text{modified wall}} = 1/U_{\text{modified wall}} = 1/0.689 = \mathbf{1.45 \text{ m}^2 \cdot ^\circ\text{C/W}}$$

The rate of heat transfer through the modified wall is

$$\dot{Q}_{\text{wall}} = (UA)_{\text{wall}}(T_i - T_o) = (1.45 \text{ W/m}^2 \cdot ^\circ\text{C})(3 \times 7 \text{ m}^2)[22 - (-5)^\circ\text{C}] = \mathbf{822 \text{ W}}$$

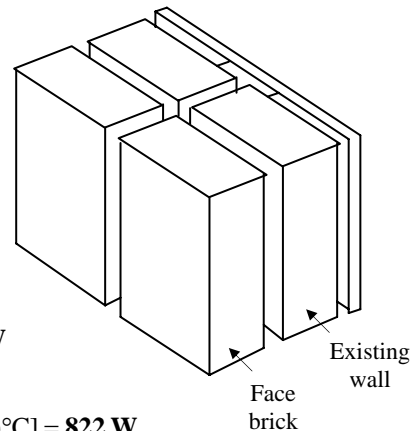

3-155 The summer and winter R -values of a masonry wall are to be determined.

Assumptions 1 Steady operating conditions exist. 2 Heat transfer through the wall is one-dimensional. 3 Thermal properties of the wall and the heat transfer coefficients are constant. 4 The air cavity does not have any reflecting surfaces.

Properties The R -values of different materials are given in Table 3-8.

Analysis Using the available R -values from Tables 3-8, the total R -value of the wall is determined in the table below.

Construction	R -value, $\text{m}^2 \cdot ^\circ\text{C/W}$	
	Summer	Winter
1a. Outside surface, 24 km/h (winter)	---	0.030
1b. Outside surface, 12 km/h (summer)	0.044	---
2. Face brick, 100 mm	0.075	0.075
3. Cement mortar, 13 mm	0.018	0.018
4. Concrete block, lightweight, 100 mm	0.27	0.27
5. Air space, nonreflecting, 40-mm	0.16	0.16
5. Plaster board, 20 mm	0.122	0.122
6. Inside surface, still air	0.12	0.12

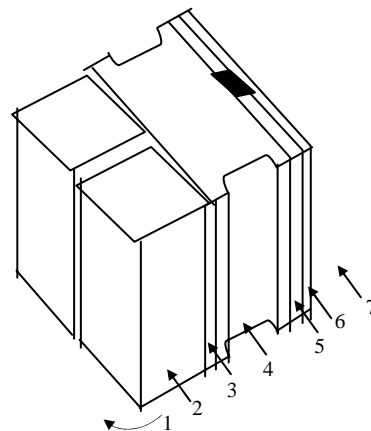

Total unit thermal resistance of each section (the R -value), $\text{m}^2 \cdot ^\circ\text{C/W}$	0.809	0.795
---	--------------	--------------

Therefore, the overall unit thermal resistance of the wall is $R = 0.809 \text{ m}^2 \cdot ^\circ\text{C/W}$ in summer and $R = 0.795 \text{ m}^2 \cdot ^\circ\text{C/W}$ in winter.

3-156E The U -value of a wall for 7.5 mph winds outside are given. The U -value of the wall for the case of 15 mph winds outside is to be determined.

Assumptions 1 Steady operating conditions exist. 2 Heat transfer through the wall is one-dimensional. 3 Thermal properties of the wall and the heat transfer coefficients are constant except the one at the outer surface.

Properties The R -values at the outer surface of a wall for summer (7.5 mph winds) and winter (15 mph winds) conditions are given in Table 3-8 to be

$$R_{o, 7.5 \text{ mph}} = R_{o, \text{summer}} = 0.25 \text{ h}\cdot\text{ft}^2\cdot^\circ\text{F}/\text{Btu}$$

and $R_{o, 15 \text{ mph}} = R_{o, \text{winter}} = 0.17 \text{ h}\cdot\text{ft}^2\cdot^\circ\text{F}/\text{Btu}$

Analysis The R -value of the wall at 7.5 mph winds (summer) is

$$R_{\text{wall}, 7.5 \text{ mph}} = 1/U_{\text{wall}, 7.5 \text{ mph}} = 1/0.075 = 13.33 \text{ h}\cdot\text{ft}^2\cdot^\circ\text{F}/\text{Btu}$$

Noting that the added and removed thermal resistances are in series, the overall R -value of the wall at 15 mph (winter) conditions is obtained by replacing the summer value of outer convection resistance by the winter value,

$$R_{\text{wall}, 15 \text{ mph}} = R_{\text{wall}, 7.5 \text{ mph}} - R_{o, 7.5 \text{ mph}} + R_{o, 15 \text{ mph}}$$

$$= 13.33 - 0.25 + 0.17 = 13.25 \text{ h}\cdot\text{ft}^2\cdot^\circ\text{F}/\text{Btu}$$

Then the U -value of the wall at 15 mph winds becomes

$$R_{\text{wall}, 15 \text{ mph}} = 1/U_{\text{wall}, 15 \text{ mph}} = 1/13.25 = \mathbf{0.0755 \text{ h}\cdot\text{ft}^2\cdot^\circ\text{F}/\text{Btu}}$$

Discussion Note that the effect of doubling the wind velocity on the U -value of the wall is less than 1 percent since

$$\text{Change} = \frac{\Delta U - \text{value}}{U - \text{value}} = \frac{0.0907 - 0.09}{0.09} = 0.0078 \quad (\text{or } 0.78\%)$$

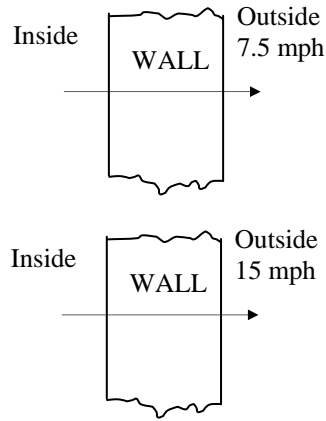

3-157 Two homes are identical, except that their walls are constructed differently. The house that is more energy efficient is to be determined.

Assumptions 1 The homes are identical, except that their walls are constructed differently. 2 Heat transfer through the wall is one-dimensional. 3 Thermal properties of the wall and the heat transfer coefficients are constant.

Properties The R -values of different materials are given in Table 3-8.

Analysis Using the available R -values from Tables 3-8, the total R -value of the masonry wall is determined in the table below.

Construction	R -value, $\text{m}^2\cdot^\circ\text{C}/\text{W}$
1. Outside surface, 24 km/h (winter)	0.030
2. Concrete block, light weight, 200 mm	$2 \times 0.27 = 0.54$
3. Air space, nonreflecting, 20 mm	0.17
5. Plasterboard, 20 mm	0.12
6. Inside surface, still air	0.12

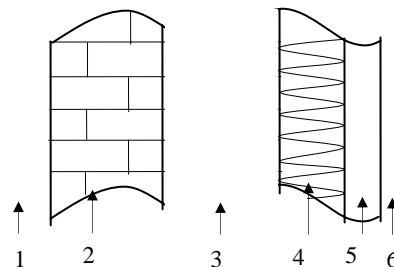

Total unit thermal resistance (the R -value)	$0.98 \text{ m}^2\cdot^\circ\text{C}/\text{W}$
--	--

which is less than $2.4 \text{ m}^2\cdot^\circ\text{C}/\text{W}$. Therefore, the standard R -2.4 $\text{m}^2\cdot^\circ\text{C}/\text{W}$ wall is better insulated and thus it is more energy efficient.

3-158 A ceiling consists of a layer of reflective acoustical tiles. The R -value of the ceiling is to be determined for winter conditions.

Assumptions 1 Heat transfer through the ceiling is one-dimensional. **3** Thermal properties of the ceiling and the heat transfer coefficients are constant.

Properties The R -values of different materials are given in Tables 3-8 and 3-9.

Analysis Using the available R -values, the total R -value of the ceiling is determined in the table below.

Construction	R -value,
	$\text{m}^2 \cdot ^\circ\text{C}/\text{W}$
1. Still air, reflective horizontal surface facing up	$R = 1/h = 1/4.32 = 0.23$
2. Acoustic tile, 19 mm	0.32
3. Still air, horizontal surface, facing down	$R = 1/h = 1/9.26 = 0.11$

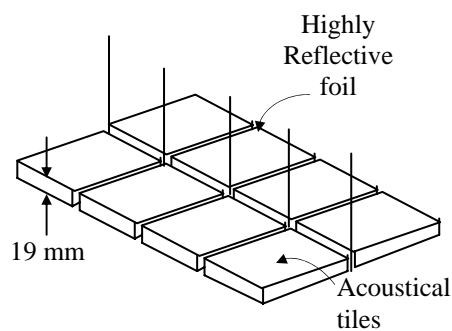

Total unit thermal resistance (the R -value)	$0.66 \text{ m}^2 \cdot ^\circ\text{C}/\text{W}$
--	--

Therefore, the R -value of the hanging ceiling is $0.66 \text{ m}^2 \cdot ^\circ\text{C}/\text{W}$.

Review Problems

3-159E Steam is produced in copper tubes by heat transferred from another fluid condensing outside the tubes at a high temperature. The rate of heat transfer per foot length of the tube when a 0.01 in thick layer of limestone is formed on the inner surface of the tube is to be determined.

Assumptions **1** Heat transfer is steady since there is no indication of any change with time. **2** Heat transfer is one-dimensional since there is thermal symmetry about the centerline and no variation in the axial direction. **3** Thermal properties are constant. **4** Heat transfer coefficients are constant and uniform over the surfaces.

Properties The thermal conductivities are given to be $k = 223$ Btu/h·ft·°F for copper tubes and $k = 1.7$ Btu/h·ft·°F for limestone.

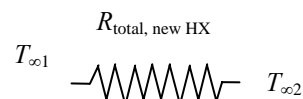

Analysis The total thermal resistance of the new heat exchanger is

$$\dot{Q}_{\text{new}} = \frac{T_{\infty 1} - T_{\infty 2}}{R_{\text{total, new}}} \longrightarrow R_{\text{total, new}} = \frac{T_{\infty 1} - T_{\infty 2}}{\dot{Q}_{\text{new}}} = \frac{(350 - 250)^{\circ}\text{F}}{2 \times 10^4 \text{ Btu/h}} = 0.005 \text{ h}\cdot^{\circ}\text{F/Btu}$$

After 0.01 in thick layer of limestone forms, the new value of thermal resistance and heat transfer rate are determined to be

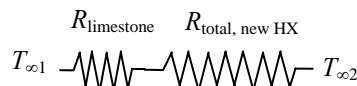

$$R_{\text{limestone, i}} = \frac{\ln(r_1 / r_i)}{2\pi kL} = \frac{\ln(0.5 / 0.49)}{2\pi(1.7 \text{ Btu/h}\cdot\text{ft}\cdot^{\circ}\text{F})(1 \text{ ft})} = 0.00189 \text{ h}\cdot^{\circ}\text{F/Btu}$$

$$R_{\text{total, w/lime}} = R_{\text{total, new}} + R_{\text{limestone, i}} = 0.005 + 0.00189 = 0.00689 \text{ h}\cdot^{\circ}\text{F/Btu}$$

$$\dot{Q}_{\text{w/lime}} = \frac{T_{\infty 1} - T_{\infty 2}}{R_{\text{total, w/lime}}} = \frac{(350 - 250)^{\circ}\text{F}}{0.00689 \text{ h}\cdot^{\circ}\text{F/Btu}} = \mathbf{1.45 \times 10^4 \text{ Btu/h}} \quad (\text{a decline of } 27\%)$$

Discussion Note that the limestone layer will change the inner surface area of the pipe and thus the internal convection resistance slightly, but this effect should be negligible.

3-160E Steam is produced in copper tubes by heat transferred from another fluid condensing outside the tubes at a high temperature. The rate of heat transfer per foot length of the tube when a 0.01 in thick layer of limestone is formed on the inner and outer surfaces of the tube is to be determined.

Assumptions 1 Heat transfer is steady since there is no indication of any change with time. **2** Heat transfer is one-dimensional since there is thermal symmetry about the centerline and no variation in the axial direction. **3** Thermal properties are constant. **4** Heat transfer coefficients are constant and uniform over the surfaces.

Properties The thermal conductivities are given to be $k = 223$ Btu/h·ft·°F for copper tubes and $k = 1.7$ Btu/h·ft·°F for limestone.

Analysis The total thermal resistance of the new heat exchanger is

$$\dot{Q}_{\text{new}} = \frac{T_{\infty 1} - T_{\infty 2}}{R_{\text{total,new}}} \longrightarrow R_{\text{total,new}} = \frac{T_{\infty 1} - T_{\infty 2}}{\dot{Q}_{\text{new}}} = \frac{(350 - 250)^{\circ}\text{F}}{2 \times 10^4 \text{ Btu/h}} = 0.005 \text{ h}\cdot^{\circ}\text{F/Btu}$$

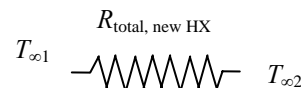

After 0.01 in thick layer of limestone forms, the new value of thermal resistance and heat transfer rate are determined to be

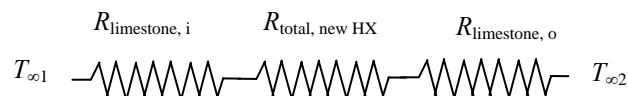

$$R_{\text{limestone,i}} = \frac{\ln(r_1 / r_i)}{2\pi kL} = \frac{\ln(0.5 / 0.49)}{2\pi(1.7 \text{ Btu/h}\cdot\text{ft}\cdot^{\circ}\text{F})(1 \text{ ft})} = 0.00189 \text{ h}\cdot^{\circ}\text{F/Btu}$$

$$R_{\text{limestone,o}} = \frac{\ln(r_o / r_2)}{2\pi kL} = \frac{\ln(0.66 / 0.65)}{2\pi(1.7 \text{ Btu/h}\cdot\text{ft}\cdot^{\circ}\text{F})(1 \text{ ft})} = 0.00143 \text{ h}\cdot^{\circ}\text{F/Btu}$$

$$R_{\text{total,w/lime}} = R_{\text{total,new}} + R_{\text{limestone,i}} + R_{\text{limestone,o}} = 0.005 + 0.00189 + 0.00143 = 0.00832 \text{ h}\cdot^{\circ}\text{F/Btu}$$

$$\dot{Q}_{\text{w/lime}} = \frac{T_{\infty 1} - T_{\infty 2}}{R_{\text{total,w/lime}}} = \frac{(350 - 250)^{\circ}\text{F}}{0.00832 \text{ h}\cdot^{\circ}\text{F/Btu}} = \mathbf{1.20 \times 10^4 \text{ Btu/h}} \quad (\text{a decline of } 40\%)$$

Discussion Note that the limestone layer will change the inner surface area of the pipe and thus the internal convection resistance slightly, but this effect should be negligible.

3-161 A cylindrical tank filled with liquid propane at 1 atm is exposed to convection and radiation. The time it will take for the propane to evaporate completely as a result of the heat gain from the surroundings for the cases of no insulation and 5-cm thick glass wool insulation are to be determined.

Assumptions 1 Heat transfer is steady. 2 Heat transfer is one-dimensional. 3 The combined heat transfer coefficient is constant and uniform over the entire surface. 4 The temperature of the thin-shelled spherical tank is said to be nearly equal to the temperature of the propane inside, and thus thermal resistance of the tank and the internal convection resistance are negligible.

Properties The heat of vaporization and density of liquid propane at 1 atm are given to be 425 kJ/kg and 581 kg/m³, respectively. The thermal conductivity of glass wool insulation is given to be $k = 0.038$ W/m·°C.

Analysis (a) If the tank is not insulated, the heat transfer rate is determined to be

$$A_{\text{tank}} = \pi DL + 2\pi(\pi D^2 / 4) = \pi(1.2 \text{ m})(6 \text{ m}) + 2\pi(1.2 \text{ m})^2 / 4 = 24.88 \text{ m}^2$$

$$\dot{Q} = hA_{\text{tank}}(T_{\infty 1} - T_{\infty 2}) = (25 \text{ W/m}^2 \cdot \text{°C})(24.88 \text{ m}^2)[30 - (-42)]\text{°C} = 44,787 \text{ W}$$

The volume of the tank and the mass of the propane are

$$V = \pi r^2 L = \pi(0.6 \text{ m})^2 (6 \text{ m}) = 6.786 \text{ m}^3$$

$$m = \rho V = (581 \text{ kg/m}^3)(6.786 \text{ m}^3) = 3942.6 \text{ kg}$$

The rate of vaporization of propane is

$$\dot{Q} = \dot{m}h_{fg} \rightarrow \dot{m} = \frac{\dot{Q}}{h_{fg}} = \frac{44,787 \text{ kJ/s}}{425 \text{ kJ/kg}} = 0.1054 \text{ kg/s}$$

Then the time period for the propane tank to empty becomes

$$\Delta t = \frac{m}{\dot{m}} = \frac{3942.6 \text{ kg}}{0.1054 \text{ kg/s}} = 37,413 \text{ s} = \mathbf{10.4 \text{ hours}}$$

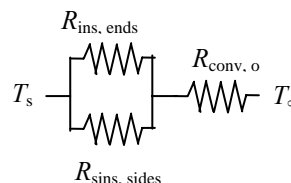
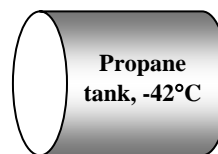

(b) We now repeat calculations for the case of insulated tank with 5-cm thick insulation.

$$A_o = \pi DL + 2\pi(\pi D^2 / 4) = \pi(1.3 \text{ m})(6 \text{ m}) + 2\pi(1.3 \text{ m})^2 / 4 = 27.16 \text{ m}^2$$

$$R_{\text{conv},o} = \frac{1}{h_o A_o} = \frac{1}{(25 \text{ W/m}^2 \cdot \text{°C})(27.16 \text{ m}^2)} = 0.001473 \text{ °C/W}$$

$$R_{\text{insulation,side}} = \frac{\ln(r_2 / r_1)}{2\pi k L} = \frac{\ln(65 / 60)}{2\pi(0.038 \text{ W/m} \cdot \text{°C})(6 \text{ m})} = 0.05587 \text{ °C/W}$$

$$R_{\text{insulation,ends}} = 2 \frac{L}{k A_{\text{avg}}} = \frac{2 \times 0.05 \text{ m}}{(0.038 \text{ W/m} \cdot \text{°C})[\pi(1.25 \text{ m})^2 / 4]} = 2.1444 \text{ °C/W}$$

Noting that the insulation on the side surface and the end surfaces are in parallel, the equivalent resistance for the insulation is determined to be

$$R_{\text{insulation}} = \left(\frac{1}{R_{\text{insulation,side}}} + \frac{1}{R_{\text{insulation,ends}}} \right)^{-1} = \left(\frac{1}{0.05587 \text{ °C/W}} + \frac{1}{2.1444 \text{ °C/W}} \right)^{-1} = 0.05445 \text{ °C/W}$$

Then the total thermal resistance and the heat transfer rate become

$$R_{\text{total}} = R_{\text{conv},o} + R_{\text{insulation}} = 0.001473 + 0.05445 = 0.05592 \text{ °C/W}$$

$$\dot{Q} = \frac{T_{\infty} - T_s}{R_{\text{total}}} = \frac{[30 - (-42)]\text{°C}}{0.05592 \text{ °C/W}} = 1288 \text{ W}$$

Then the time period for the propane tank to empty becomes

$$\dot{Q} = \dot{m}h_{fg} \rightarrow \dot{m} = \frac{\dot{Q}}{h_{fg}} = \frac{1,288 \text{ kJ/s}}{425 \text{ kJ/kg}} = 0.003031 \text{ kg/s}$$

$$\Delta t = \frac{m}{\dot{m}} = \frac{3942.6 \text{ kg}}{0.003031 \text{ kg/s}} = 1.301 \times 10^6 \text{ s} = 361.4 \text{ hours} = \mathbf{15.1 \text{ days}}$$

3-162 Hot water is flowing through a 15-m section of a cast iron pipe. The pipe is exposed to cold air and surfaces in the basement, and it experiences a 3°C-temperature drop. The combined convection and radiation heat transfer coefficient at the outer surface of the pipe is to be determined.

Assumptions 1 Heat transfer is steady since there is no indication of any significant change with time. **2** Heat transfer is one-dimensional since there is thermal symmetry about the centerline and no significant variation in the axial direction. **3** Thermal properties are constant.

Properties The thermal conductivity of cast iron is given to be $k = 52 \text{ W/m}\cdot\text{°C}$.

Analysis Using water properties at room temperature, the mass flow rate of water and rate of heat transfer from the water are determined to be

$$\dot{m} = \rho \dot{V}_c = \rho V A_c = (1000 \text{ kg/m}^3)(1.5 \text{ m/s})[\pi(0.03)^2 / 4] \text{ m}^2 = 1.06 \text{ kg/s}$$

$$\dot{Q} = \dot{m} c_p \Delta T = (1.06 \text{ kg/s})(4180 \text{ J/kg}\cdot\text{°C})(70 - 67)\text{°C} = 13,296 \text{ W}$$

The thermal resistances for convection in the pipe and the pipe itself are

$$R_{\text{pipe}} = \frac{\ln(r_2 / r_1)}{2\pi k L}$$

$$= \frac{\ln(1.75 / 1.5)}{2\pi(52 \text{ W/m}\cdot\text{°C})(15 \text{ m})} = 0.000031 \text{ °C/W}$$

$$R_{\text{conv},i} = \frac{1}{h_i A_i} = \frac{1}{(400 \text{ W/m}^2\cdot\text{°C})[\pi(0.03)(15)] \text{ m}^2} = 0.001768 \text{ °C/W}$$

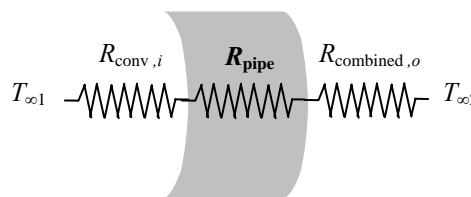

Using arithmetic mean temperature $(70+67)/2 = 68.5\text{°C}$ for water, the heat transfer can be expressed as

$$\dot{Q} = \frac{T_{\infty,1,ave} - T_{\infty,2}}{R_{\text{total}}} = \frac{T_{\infty,1,ave} - T_{\infty,2}}{R_{\text{conv},i} + R_{\text{pipe}} + R_{\text{combined},o}} = \frac{T_{\infty,1,ave} - T_{\infty,2}}{R_{\text{conv},i} + R_{\text{pipe}} + \frac{1}{h_{\text{combined}} A_o}}$$

Substituting, $13,296 \text{ W} = \frac{(68.5 - 15)\text{°C}}{(0.000031 \text{ °C/W}) + (0.001768 \text{ °C/W}) + \frac{1}{h_{\text{combined}}[\pi(0.035)(15)] \text{ m}^2}}$

Solving for the combined heat transfer coefficient gives

$$h_{\text{combined}} = 272.5 \text{ W/m}^2\cdot\text{°C}$$

3-163 An 10-m long section of a steam pipe exposed to the ambient is to be insulated to reduce the heat loss through that section of the pipe by 90 percent. The amount of heat loss from the steam in 10 h and the amount of saved per year by insulating the steam pipe.

Assumptions **1** Heat transfer through the pipe is steady and one-dimensional. **2** Thermal conductivities are constant. **3** The furnace operates continuously. **4** The given heat transfer coefficients accounts for the radiation effects. **5** The temperatures of the pipe surface and the surroundings are representative of annual average during operating hours. **6** The plant operates 110 days a year.

Analysis The rate of heat transfer for the uninsulated case is

$$A_o = \pi D_o L = \pi(0.12 \text{ m})(10 \text{ m}) = 3.77 \text{ m}^2$$

$$\dot{Q} = hA_o(T_s - T_{air}) = (35 \text{ W/m}^2 \cdot \text{°C})(3.77 \text{ m}^2)(82 - 8)^\circ\text{C} = 9764 \text{ W}$$

The amount of heat loss during a 10-hour period is

$$Q = \dot{Q}\Delta t = (9.764 \text{ kJ/s})(10 \times 3600 \text{ s}) = \mathbf{3.515 \times 10^5 \text{ kJ}} \text{ (per day)}$$

The steam generator has an efficiency of 85%, and steam heating is used for 110 days a year. Then the amount of natural gas consumed per year and its cost are

$$\text{Fuel used} = \frac{3.515 \times 10^5 \text{ kJ}}{0.85} \left(\frac{1 \text{ therm}}{105,500 \text{ kJ}} \right) (110 \text{ days/yr}) = 431.2 \text{ therms/yr}$$

$$\begin{aligned} \text{Cost of fuel} &= (\text{Amount of fuel})(\text{Unit cost of fuel}) \\ &= (431.2 \text{ therms/yr})(\$1.20/\text{therm}) = \$517.4/\text{yr} \end{aligned}$$

Then the money saved by reducing the heat loss by 90% by insulation becomes

$$\text{Money saved} = 0.9 \times (\text{Cost of fuel}) = 0.9 \times \$517.4/\text{yr} = \mathbf{\$466}$$

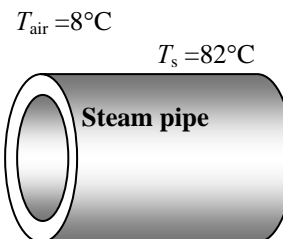

3-164 A multilayer circuit board dissipating 27 W of heat consists of 4 layers of copper and 3 layers of epoxy glass sandwiched together. The circuit board is attached to a heat sink from both ends maintained at 35°C. The magnitude and location of the maximum temperature that occurs in the board is to be determined.

Assumptions **1** Steady operating conditions exist. **2** Heat transfer can be approximated as being one-dimensional. **3** Thermal conductivities are constant. **4** Heat is generated uniformly in the epoxy layers of the board. **5** Heat transfer from the top and bottom surfaces of the board is negligible. **6** The thermal contact resistances at the copper-epoxy interfaces are negligible.

Properties The thermal conductivities are given to be $k = 386 \text{ W/m} \cdot \text{°C}$ for copper layers and $k = 0.26 \text{ W/m} \cdot \text{°C}$ for epoxy glass boards.

Analysis The effective conductivity of the multilayer circuit board is first determined to be

$$(kt)_{\text{copper}} = 4[(386 \text{ W/m} \cdot \text{°C})(0.0002 \text{ m})] = 0.3088 \text{ W/°C}$$

$$(kt)_{\text{epoxy}} = 3[(0.26 \text{ W/m} \cdot \text{°C})(0.0015 \text{ m})] = 0.00117 \text{ W/°C}$$

$$k_{\text{eff}} = \frac{(kt)_{\text{copper}} + (kt)_{\text{epoxy}}}{t_{\text{copper}} + t_{\text{epoxy}}} = \frac{(0.3088 + 0.00117) \text{ W/°C}}{[4(0.0002) + 3(0.0015) \text{ m}]} = 58.48 \text{ W/m} \cdot \text{°C}$$

The maximum temperature will occur at the midplane of the board that is the farthest to the heat sink. Its value is

$$A = 0.18[4(0.0002) + 3(0.0015)] = 0.000954 \text{ m}^2$$

$$\dot{Q} = \frac{k_{\text{eff}} A}{L} (T_1 - T_2)$$

$$T_{\text{max}} = T_1 = T_2 + \frac{\dot{Q}L}{k_{\text{eff}} A} = 35^\circ\text{C} + \frac{(27/2 \text{ W})(0.18/2 \text{ m})}{(58.48 \text{ W/m} \cdot \text{°C})(0.000954 \text{ m}^2)} = \mathbf{56.8^\circ\text{C}}$$

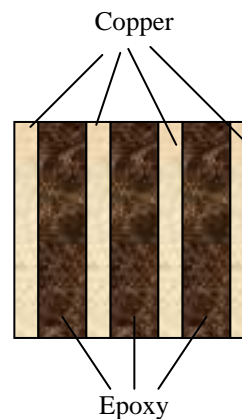

3-165 The plumbing system of a house involves some section of a plastic pipe exposed to the ambient air. The pipe is initially filled with stationary water at 0°C. It is to be determined if the water in the pipe will completely freeze during a cold night.

Assumptions 1 Heat transfer is transient, but can be treated as steady since the water temperature remains constant during freezing. **2** Heat transfer is one-dimensional since there is thermal symmetry about the centerline and no variation in the axial direction. **3** Thermal properties of water are constant. **4** The water in the pipe is stationary, and its initial temperature is 0°C. **5** The convection resistance inside the pipe is negligible so that the inner surface temperature of the pipe is 0°C.

Properties The thermal conductivity of the pipe is given to be $k = 0.16 \text{ W/m}\cdot\text{°C}$. The density and latent heat of fusion of water at 0°C are $\rho = 1000 \text{ kg/m}^3$ and $h_{if} = 333.7 \text{ kJ/kg}$ (Table A-9).

Analysis We assume the inner surface of the pipe to be at 0°C at all times. The thermal resistances involved and the rate of heat transfer are

$$R_{\text{pipe}} = \frac{\ln(r_2/r_1)}{2\pi kL} = \frac{\ln(1.2/1)}{2\pi(0.16 \text{ W/m}\cdot\text{°C})(0.5 \text{ m})} = 0.3627 \text{ °C/W}$$

$$R_{\text{conv,o}} = \frac{1}{h_o A} = \frac{1}{(40 \text{ W/m}^2\cdot\text{°C})[\pi(0.024 \text{ m})(0.5 \text{ m})]} = 0.6631 \text{ °C/W}$$

$$R_{\text{total}} = R_{\text{pipe}} + R_{\text{conv,o}} = 0.3627 + 0.6631 = 1.0258 \text{ °C/W}$$

$$\dot{Q} = \frac{T_{s1} - T_{\infty 2}}{R_{\text{total}}} = \frac{[0 - (-5)]\text{°C}}{1.0258 \text{ °C/W}} = 4.874 \text{ W}$$

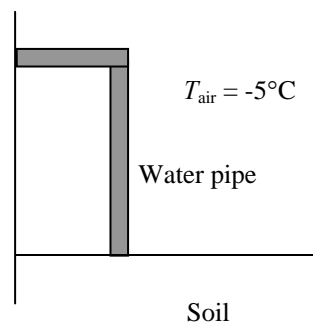

The total amount of heat lost by the water during a 14-h period that night is

$$Q = \dot{Q}\Delta t = (4.874 \text{ J/s})(14 \times 3600 \text{ s}) = 245.7 \text{ kJ}$$

The amount of heat required to freeze the water in the pipe completely is

$$m = \rho V = \rho \pi r^2 L = (1000 \text{ kg/m}^3)\pi(0.01 \text{ m})^2(0.5 \text{ m}) = 0.157 \text{ kg}$$

$$Q = mh_{fg} = (0.157 \text{ kg})(333.7 \text{ kJ/kg}) = 52.4 \text{ kJ}$$

The water in the pipe will **freeze completely** that night since the amount heat loss is greater than the amount it takes to freeze the water completely ($245.7 > 52.4$).

3-166 The plumbing system of a house involves some section of a plastic pipe exposed to the ambient air. The pipe is initially filled with stationary water at 0°C . It is to be determined if the water in the pipe will completely freeze during a cold night.

Assumptions 1 Heat transfer is transient, but can be treated as steady since the water temperature remains constant during freezing. **2** Heat transfer is one-dimensional since there is thermal symmetry about the centerline and no variation in the axial direction. **3** Thermal properties of water are constant. **4** The water in the pipe is stationary, and its initial temperature is 0°C . **5** The convection resistance inside the pipe is negligible so that the inner surface temperature of the pipe is 0°C .

Properties The thermal conductivity of the pipe is given to be $k = 0.16 \text{ W/m}\cdot^{\circ}\text{C}$. The density and latent heat of fusion of water at 0°C are $\rho = 1000 \text{ kg/m}^3$ and $h_{if} = 333.7 \text{ kJ/kg}$ (Table A-9).

Analysis We assume the inner surface of the pipe to be at 0°C at all times. The thermal resistances involved and the rate of heat transfer are

$$R_{\text{pipe}} = \frac{\ln(r_2/r_1)}{2\pi kL} = \frac{\ln(1.2/1)}{2\pi(0.16 \text{ W/m}\cdot^{\circ}\text{C})(0.5 \text{ m}^2)} = 0.3627^{\circ}\text{C/W}$$

$$R_{\text{conv,o}} = \frac{1}{h_o A} = \frac{1}{(10 \text{ W/m}^2\cdot^{\circ}\text{C})[\pi(0.024 \text{ m})(0.5 \text{ m})]} = 2.6526^{\circ}\text{C/W}$$

$$R_{\text{total}} = R_{\text{pipe}} + R_{\text{conv,o}} = 0.3627 + 2.6526 = 3.0153^{\circ}\text{C/W}$$

$$\dot{Q} = \frac{T_{\infty 1} - T_{\infty 2}}{R_{\text{total}}} = \frac{[0 - (-5)]^{\circ}\text{C}}{3.0153^{\circ}\text{C/W}} = 1.658 \text{ W}$$

$$Q = \dot{Q}\Delta t = (1.658 \text{ J/s})(14 \times 3600 \text{ s}) = 83.57 \text{ kJ}$$

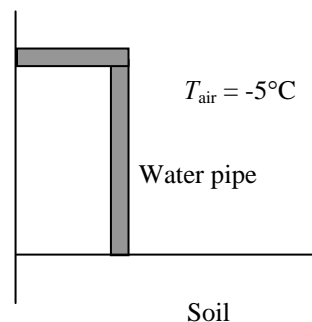

The amount of heat required to freeze the water in the pipe completely is

$$m = \rho V = \rho \pi r^2 L = (1000 \text{ kg/m}^3)\pi(0.01 \text{ m})^2(0.5 \text{ m}) = 0.157 \text{ kg}$$

$$Q = mh_{fg} = (0.157 \text{ kg})(333.7 \text{ kJ/kg}) = 52.4 \text{ kJ}$$

The water in the pipe will **freeze completely** that night since the amount heat loss is greater than the amount it takes to freeze the water completely ($83.57 > 52.4$).

3-167E The surface temperature of a baked potato drops from 300°F to 200°F in 5 minutes in an environment at 70°F. The average heat transfer coefficient and the cooling time of the potato if it is wrapped completely in a towel are to be determined.

Assumptions **1** Thermal properties of potato are constant, and can be taken to be the properties of water. **2** The thermal contact resistance at the interface is negligible. **3** The heat transfer coefficients for wrapped and unwrapped potatoes are the same.

Properties The thermal conductivity of a thick towel is given to be $k = 0.035 \text{ Btu/h}\cdot\text{ft}\cdot^\circ\text{F}$. We take the properties of potato to be those of water at room temperature, $\rho = 62.2 \text{ lbm/ft}^3$ and $c_p = 0.998 \text{ Btu/lbm}\cdot^\circ\text{F}$.

Analysis This is a transient heat conduction problem, and the rate of heat transfer will decrease as the potato cools down and the temperature difference between the potato and the surroundings decreases. However, we can solve this problem approximately by assuming a constant average temperature of $(300+200)/2 = 250^\circ\text{F}$ for the potato during the process. The mass of the potato is

$$\begin{aligned} m &= \rho V = \rho \frac{4}{3} \pi r^3 \\ &= (62.2 \text{ lbm/ft}^3) \frac{4}{3} \pi (1.5/12 \text{ ft})^3 \\ &= 0.5089 \text{ lbm} \end{aligned}$$

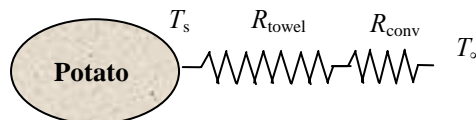

The amount of heat lost as the potato is cooled from 300 to 200°F is

$$Q = mc_p \Delta T = (0.5089 \text{ lbm})(0.998 \text{ Btu/lbm}\cdot^\circ\text{F})(300 - 200)^\circ\text{F} = 50.8 \text{ Btu}$$

The rate of heat transfer and the average heat transfer coefficient between the potato and its surroundings are

$$\dot{Q} = \frac{Q}{\Delta t} = \frac{50.8 \text{ Btu}}{(5/60 \text{ h})} = 609.6 \text{ Btu/h}$$

$$\dot{Q} = hA_o(T_s - T_\infty) \longrightarrow h = \frac{\dot{Q}}{A_o(T_s - T_\infty)} = \frac{609.6 \text{ Btu/h}}{\pi(3/12 \text{ ft})^2(250 - 70)^\circ\text{F}} = \mathbf{17.2 \text{ Btu/h}\cdot\text{ft}^2\cdot^\circ\text{F}}$$

When the potato is wrapped in a towel, the thermal resistance and heat transfer rate are determined to be

$$R_{\text{towel}} = \frac{r_2 - r_1}{4\pi k r_1 r_2} = \frac{[(1.5 + 0.12)/12] \text{ ft} - (1.5/12) \text{ ft}}{4\pi(0.035 \text{ Btu/h}\cdot\text{ft}\cdot^\circ\text{F})[(1.5 + 0.12)/12] \text{ ft}(1.5/12) \text{ ft}} = 1.3473 \text{ h}\cdot^\circ\text{F/Btu}$$

$$R_{\text{conv}} = \frac{1}{hA} = \frac{1}{(17.2 \text{ Btu/h}\cdot\text{ft}^2\cdot^\circ\text{F})\pi(3.24/12)^2 \text{ ft}^2} = 0.2539 \text{ h}\cdot^\circ\text{F/Btu}$$

$$R_{\text{total}} = R_{\text{towel}} + R_{\text{conv}} = 1.3473 + 0.2539 = 1.6012 \text{ h}\cdot^\circ\text{F/Btu}$$

$$\dot{Q} = \frac{T_s - T_\infty}{R_{\text{total}}} = \frac{(250 - 70)^\circ\text{F}}{1.6012 \text{ h}\cdot^\circ\text{F/Btu}} = 112.4 \text{ Btu/h}$$

$$\Delta t = \frac{Q}{\dot{Q}} = \frac{50.8 \text{ Btu}}{112.4 \text{ Btu/h}} = 0.452 \text{ h} = \mathbf{27.1 \text{ min}}$$

This result is conservative since the heat transfer coefficient will be lower in this case because of the smaller exposed surface temperature.

3-168E The surface temperature of a baked potato drops from 300°F to 200°F in 5 minutes in an environment at 70°F. The average heat transfer coefficient and the cooling time of the potato if it is loosely wrapped completely in a towel are to be determined.

Assumptions 1 Thermal properties of potato are constant, and can be taken to be the properties of water. 2 The heat transfer coefficients for wrapped and unwrapped potatoes are the same.

Properties The thermal conductivity of a thick towel is given to be $k = 0.035$ Btu/h·ft·°F. The thermal conductivity of air is given to be $k = 0.015$ Btu/h·ft·°F. We take the properties of potato to be those of water at room temperature, $\rho = 62.2$ lbm/ft³ and $c_p = 0.998$ Btu/lbm·°F.

Analysis This is a transient heat conduction problem, and the rate of heat transfer will decrease as the potato cools down and the temperature difference between the potato and the surroundings decreases. However, we can solve this problem approximately by assuming a constant average temperature of $(300+200)/2 = 250^\circ\text{F}$ for the potato during the process. The mass of the potato is

$$\begin{aligned} m &= \rho V = \rho \frac{4}{3} \pi r^3 \\ &= (62.2 \text{ lbm/ft}^3) \frac{4}{3} \pi (1.5/12 \text{ ft})^3 \\ &= 0.5089 \text{ lbm} \end{aligned}$$

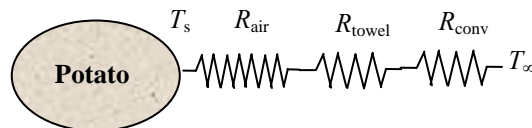

The amount of heat lost as the potato is cooled from 300 to 200°F is

$$Q = mc_p \Delta T = (0.5089 \text{ lbm})(0.998 \text{ Btu/lbm}\cdot^\circ\text{F})(300 - 200)^\circ\text{F} = 50.8 \text{ Btu}$$

The rate of heat transfer and the average heat transfer coefficient between the potato and its surroundings are

$$\dot{Q} = \frac{Q}{\Delta t} = \frac{50.8 \text{ Btu}}{(5/60 \text{ h})} = 609.6 \text{ Btu/h}$$

$$\dot{Q} = hA_o(T_s - T_\infty) \longrightarrow h = \frac{\dot{Q}}{A_o(T_s - T_\infty)} = \frac{609.6 \text{ Btu/h}}{\pi(3/12 \text{ ft})^2(250 - 70)^\circ\text{F}} = \mathbf{17.2 \text{ Btu/h}\cdot\text{ft}^2\cdot^\circ\text{F}}$$

When the potato is wrapped in a towel, the thermal resistance and heat transfer rate are determined to be

$$R_{\text{air}} = \frac{r_2 - r_1}{4\pi k r_1 r_2} = \frac{[(1.50 + 0.02)/12] \text{ ft} - (1.50/12) \text{ ft}}{4\pi(0.015 \text{ Btu/h}\cdot\text{ft}\cdot^\circ\text{F})[(1.50 + 0.02)/12] \text{ ft}(1.50/12) \text{ ft}} = 0.5584 \text{ h}\cdot^\circ\text{F/Btu}$$

$$R_{\text{towel}} = \frac{r_3 - r_2}{4\pi k r_2 r_3} = \frac{[(1.52 + 0.12)/12] \text{ ft} - (1.52/12) \text{ ft}}{4\pi(0.035 \text{ Btu/h}\cdot\text{ft}\cdot^\circ\text{F})[(1.52 + 0.12)/12] \text{ ft}(1.52/12) \text{ ft}} = 1.3134 \text{ h}\cdot^\circ\text{F/Btu}$$

$$R_{\text{conv}} = \frac{1}{hA} = \frac{1}{(17.2 \text{ Btu/h}\cdot\text{ft}^2\cdot^\circ\text{F})\pi(3.28/12)^2 \text{ ft}^2} = 0.2477 \text{ h}\cdot^\circ\text{F/Btu}$$

$$R_{\text{total}} = R_{\text{air}} + R_{\text{towel}} + R_{\text{conv}} = 0.5584 + 1.3134 + 0.2477 = 2.1195 \text{ h}\cdot^\circ\text{F/Btu}$$

$$\dot{Q} = \frac{T_s - T_\infty}{R_{\text{total}}} = \frac{(250 - 70)^\circ\text{F}}{2.1195 \text{ h}\cdot^\circ\text{F/Btu}} = 84.9 \text{ Btu/h}$$

$$\Delta t = \frac{Q}{\dot{Q}} = \frac{50.8 \text{ Btu}}{84.9 \text{ Btu/h}} = 0.598 \text{ h} = \mathbf{35.9 \text{ min}}$$

This result is conservative since the heat transfer coefficient will be lower because of the smaller exposed surface temperature.

3-169 An ice chest made of 3-cm thick styrofoam is initially filled with 45 kg of ice at 0°C. The length of time it will take for the ice in the chest to melt completely is to be determined.

Assumptions 1 Heat transfer is steady since the specified thermal conditions at the boundaries do not change with time. 2 Heat transfer is one-dimensional. 3 Thermal conductivity is constant. 4 The inner surface temperature of the ice chest can be taken to be 0°C at all times. 5 Heat transfer from the base of the ice chest is negligible.

Properties The thermal conductivity of styrofoam is given to be $k = 0.033 \text{ W/m}\cdot\text{°C}$. The heat of fusion of water at 1 atm is $h_{if} = 333.7 \text{ kJ/kg}$.

Analysis Disregarding any heat loss through the bottom of the ice chest, the total thermal resistance and the heat transfer rate are determined to be

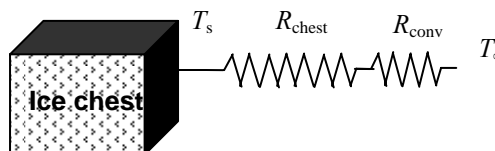

$$A_i = 2(0.3 - 0.03)(0.4 - 0.06) + 2(0.3 - 0.03)(0.5 - 0.06) + (0.4 - 0.06)(0.5 - 0.06) = 0.5708 \text{ m}^2$$

$$A_o = 2(0.3)(0.4) + 2(0.3)(0.5) + (0.4)(0.5) = 0.74 \text{ m}^2$$

$$R_{\text{chest}} = \frac{L}{kA_i} = \frac{0.03 \text{ m}}{(0.033 \text{ W/m}\cdot\text{°C})(0.5708 \text{ m}^2)} = 1.5927 \text{ °C/W}$$

$$R_{\text{conv}} = \frac{1}{hA_o} = \frac{1}{(18 \text{ W/m}^2\cdot\text{°C})(0.74 \text{ m}^2)} = 0.07508 \text{ °C/W}$$

$$R_{\text{total}} = R_{\text{chest}} + R_{\text{conv}} = 1.5927 + 0.07508 = 1.6678 \text{ °C/W}$$

$$\dot{Q} = \frac{T_s - T_{\infty}}{R_{\text{total}}} = \frac{(28 - 0)\text{°C}}{1.6678 \text{ °C/W}} = 16.79 \text{ W}$$

The total amount of heat necessary to melt the ice completely is

$$Q = mh_{if} = (50 \text{ kg})(333.7 \text{ kJ/kg}) = 16,685 \text{ kJ}$$

Then the time period to transfer this much heat to the cooler to melt the ice completely becomes

$$\Delta t = \frac{Q}{\dot{Q}} = \frac{16,685,000 \text{ J}}{16.79 \text{ J/s}} = 9.937 \times 10^5 \text{ s} = 276 \text{ h} = \mathbf{11.5 \text{ days}}$$

3-170 A wall is constructed of two large steel plates separated by 1-cm thick steel bars placed 99 cm apart. The remaining space between the steel plates is filled with fiberglass insulation. The rate of heat transfer through the wall is to be determined, and it is to be assessed if the steel bars between the plates can be ignored in heat transfer analysis since they occupy only 1 percent of the heat transfer surface area.

Assumptions 1 Heat transfer is steady since there is no indication of change with time. **2** Heat transfer through the wall can be approximated to be one-dimensional. **3** Thermal conductivities are constant. **4** The surfaces of the wall are maintained at constant temperatures.

Properties The thermal conductivities are given to be $k = 15 \text{ W/m}\cdot\text{°C}$ for steel plates and $k = 0.035 \text{ W/m}\cdot\text{°C}$ for fiberglass insulation.

Analysis We consider 1 m high and 1 m wide portion of the wall which is representative of entire wall. Thermal resistance network and individual resistances are

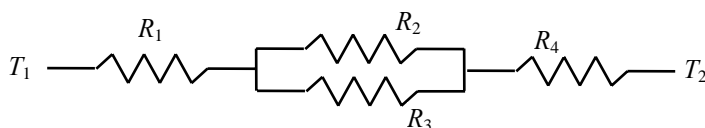

$$R_1 = R_4 = R_{\text{steel}} = \frac{L}{kA} = \frac{0.02 \text{ m}}{(15 \text{ W/m}\cdot\text{°C})(1 \text{ m}^2)} = 0.00133 \text{ °C/W}$$

$$R_2 = R_{\text{steel}} = \frac{L}{kA} = \frac{0.2 \text{ m}}{(15 \text{ W/m}\cdot\text{°C})(0.01 \text{ m}^2)} = 1.333 \text{ °C/W}$$

$$R_3 = R_{\text{insulation}} = \frac{L}{kA} = \frac{0.2 \text{ m}}{(0.035 \text{ W/m}\cdot\text{°C})(0.99 \text{ m}^2)} = 5.772 \text{ °C/W}$$

$$\frac{1}{R_{\text{eqv}}} = \frac{1}{R_2} + \frac{1}{R_3} = \frac{1}{1.333} + \frac{1}{5.772} \rightarrow R_{\text{eqv}} = 1.083 \text{ °C/W}$$

$$R_{\text{total}} = R_1 + R_{\text{eqv}} + R_4 = 0.00133 + 1.083 + 0.00133 = 1.0857 \text{ °C/W}$$

The rate of heat transfer per m^2 surface area of the wall is

$$\dot{Q} = \frac{\Delta T}{R_{\text{total}}} = \frac{22 \text{ °C}}{1.0857 \text{ °C/W}} = 20.26 \text{ W}$$

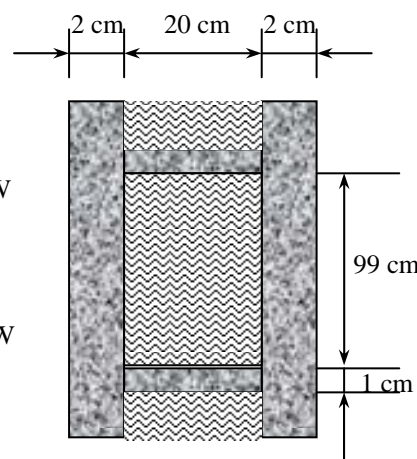

The total rate of heat transfer through the entire wall is then determined to be

$$\dot{Q}_{\text{total}} = (4 \times 6) \dot{Q} = 24(20.26 \text{ W}) = \mathbf{486.2 \text{ W}}$$

If the steel bars were ignored since they constitute only 1% of the wall section, the R_{equiv} would simply be equal to the thermal resistance of the insulation, and the heat transfer rate in this case would be

$$\dot{Q} = \frac{\Delta T}{R_{\text{total}}} = \frac{\Delta T}{R_1 + R_{\text{insulation}} + R_4} = \frac{22 \text{ °C}}{(0.00133 + 5.772 + 0.00133) \text{ °C/W}} = 3.81 \text{ W}$$

which is much less than 20.26 W obtained earlier. Therefore, $(20.26 - 3.81)/20.26 = 81.2\%$ of the heat transfer occurs through the steel bars across the wall despite the negligible space that they occupy, and obviously their effect cannot be neglected. The connecting bars are serving as “thermal bridges.”

3-171 A circuit board houses electronic components on one side, dissipating a total of 15 W through the backside of the board to the surrounding medium. The temperatures on the two sides of the circuit board are to be determined for the cases of no fins and 20 aluminum fins of rectangular profile on the backside.

Assumptions 1 Steady operating conditions exist. 2 The temperature in the board and along the fins varies in one direction only (normal to the board). 3 All the heat generated in the chips is conducted across the circuit board, and is dissipated from the backside of the board. 4 Heat transfer from the fin tips is negligible. 5 The heat transfer coefficient is constant and uniform over the entire fin surface. 6 The thermal properties of the fins are constant. 7 The heat transfer coefficient accounts for the effect of radiation from the fins.

Properties The thermal conductivities are given to be $k = 12 \text{ W/m}\cdot^\circ\text{C}$ for the circuit board, $k = 237 \text{ W/m}\cdot^\circ\text{C}$ for the aluminum plate and fins, and $k = 1.8 \text{ W/m}\cdot^\circ\text{C}$ for the epoxy adhesive.

Analysis (a) The thermal resistance of the board and the convection resistance on the backside of the board are

$$R_{\text{board}} = \frac{L}{kA} = \frac{0.002 \text{ m}}{(12 \text{ W/m}\cdot^\circ\text{C})(0.1 \text{ m})(0.15 \text{ m})} = 0.011^\circ\text{C/W}$$

$$R_{\text{conv}} = \frac{1}{hA} = \frac{1}{(45 \text{ W/m}\cdot^\circ\text{C})(0.1 \text{ m})(0.15 \text{ m})} = 1.481^\circ\text{C/W}$$

$$R_{\text{total}} = R_{\text{board}} + R_{\text{conv}} = 0.011 + 1.481 = 1.492^\circ\text{C/W}$$

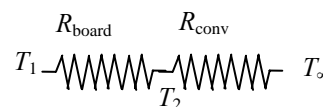

Then surface temperatures on the two sides of the circuit board becomes

$$\dot{Q} = \frac{T_1 - T_\infty}{R_{\text{total}}} \longrightarrow T_1 = T_\infty + \dot{Q}R_{\text{total}} = 37^\circ\text{C} + (15 \text{ W})(1.492^\circ\text{C/W}) = \mathbf{59.4^\circ\text{C}}$$

$$\dot{Q} = \frac{T_1 - T_2}{R_{\text{board}}} \longrightarrow T_2 = T_1 - \dot{Q}R_{\text{board}} = 59.4^\circ\text{C} - (15 \text{ W})(0.011^\circ\text{C/W}) = \mathbf{59.2^\circ\text{C}}$$

(b) Noting that the cross-sectional areas of the fins are constant, the efficiency of these rectangular fins is determined to be

$$m = \sqrt{\frac{hp}{kA_c}} \cong \sqrt{\frac{h(2w)}{k(tw)}} = \sqrt{\frac{2h}{kt}} = \sqrt{\frac{2(45 \text{ W/m}^2\cdot^\circ\text{C})}{(237 \text{ W/m}\cdot^\circ\text{C})(0.002 \text{ m})}} = 13.78 \text{ m}^{-1}$$

$$\eta_{\text{fin}} = \frac{\tanh mL}{mL} = \frac{\tanh(13.78 \text{ m}^{-1} \times 0.02 \text{ m})}{13.78 \text{ m}^{-1} \times 0.02 \text{ m}} = 0.975$$

The finned and unfinned surface areas are

$$A_{\text{finned}} = (20)2w\left(L + \frac{t}{2}\right) = (20)2(0.15)\left(0.02 + \frac{0.002}{2}\right) = 0.126 \text{ m}^2$$

$$A_{\text{unfinned}} = (0.1)(0.15) - 20(0.002)(0.15) = 0.0090 \text{ m}^2$$

Then,

$$\dot{Q}_{\text{finned}} = \eta_{\text{fin}} \dot{Q}_{\text{fin,max}} = \eta_{\text{fin}} hA_{\text{fin}} (T_{\text{base}} - T_\infty)$$

$$\dot{Q}_{\text{unfinned}} = hA_{\text{unfinned}} (T_{\text{base}} - T_\infty)$$

$$\dot{Q}_{\text{total}} = \dot{Q}_{\text{unfinned}} + \dot{Q}_{\text{finned}} = h(T_{\text{base}} - T_\infty)(\eta_{\text{fin}} A_{\text{fin}} + A_{\text{unfinned}})$$

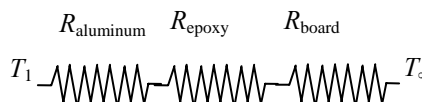

Substituting, the base temperature of the finned surfaces is determined to be

$$\begin{aligned} T_{\text{base}} &= T_\infty + \frac{\dot{Q}_{\text{total}}}{h(\eta_{\text{fin}} A_{\text{fin}} + A_{\text{unfinned}})} \\ &= 37^\circ\text{C} + \frac{15 \text{ W}}{(45 \text{ W/m}^2\cdot^\circ\text{C})[(0.975)(0.126 \text{ m}^2) + (0.0090 \text{ m}^2)]} = \mathbf{39.5^\circ\text{C}} \end{aligned}$$

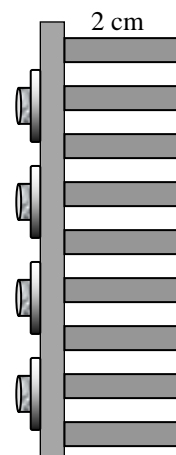

Then the temperatures on both sides of the board are determined using the thermal resistance network to be

$$R_{\text{aluminum}} = \frac{L}{kA} = \frac{0.001 \text{ m}}{(237 \text{ W/m}\cdot\text{C})(0.1 \text{ m})(0.15 \text{ m})} = 0.00028 \text{ C/W}$$

$$R_{\text{epoxy}} = \frac{L}{kA} = \frac{0.0003 \text{ m}}{(1.8 \text{ W/m}\cdot\text{C})(0.1 \text{ m})(0.15 \text{ m})} = 0.01111 \text{ C/W}$$

$$\dot{Q} = \frac{T_1 - T_{\text{base}}}{R_{\text{aluminum}} + R_{\text{epoxy}} + R_{\text{board}}} = \frac{(T_1 - 39.5)^\circ\text{C}}{(0.00028 + 0.01111 + 0.011) \text{ C/W}}$$

$$\longrightarrow T_1 = 39.5^\circ\text{C} + (15 \text{ W})(0.02239 \text{ C/W}) = \mathbf{39.8^\circ\text{C}}$$

$$\dot{Q} = \frac{T_1 - T_2}{R_{\text{board}}} \longrightarrow T_2 = T_1 - \dot{Q}R_{\text{board}} = 39.8^\circ\text{C} - (15 \text{ W})(0.011 \text{ C/W}) = \mathbf{39.6^\circ\text{C}}$$

3-172 A circuit board houses electronic components on one side, dissipating a total of 15 W through the backside of the board to the surrounding medium. The temperatures on the two sides of the circuit board are to be determined for the cases of no fins and 20 copper fins of rectangular profile on the backside.

Assumptions 1 Steady operating conditions exist. 2 The temperature in the board and along the fins varies in one direction only (normal to the board). 3 All the heat generated in the chips is conducted across the circuit board, and is dissipated from the backside of the board. 4 Heat transfer from the fin tips is negligible. 5 The heat transfer coefficient is constant and uniform over the entire fin surface. 6 The thermal properties of the fins are constant. 7 The heat transfer coefficient accounts for the effect of radiation from the fins.

Properties The thermal conductivities are given to be $k = 12 \text{ W/m}\cdot^\circ\text{C}$ for the circuit board, $k = 386 \text{ W/m}\cdot^\circ\text{C}$ for the copper plate and fins, and $k = 1.8 \text{ W/m}\cdot^\circ\text{C}$ for the epoxy adhesive.

Analysis (a) The thermal resistance of the board and the convection resistance on the backside of the board are

$$R_{\text{board}} = \frac{L}{kA} = \frac{0.002 \text{ m}}{(12 \text{ W/m}\cdot^\circ\text{C})(0.1 \text{ m})(0.15 \text{ m})} = 0.011^\circ\text{C/W}$$

$$R_{\text{conv}} = \frac{1}{hA} = \frac{1}{(45 \text{ W/m}\cdot^\circ\text{C})(0.1 \text{ m})(0.15 \text{ m})} = 1.481^\circ\text{C/W}$$

$$R_{\text{total}} = R_{\text{board}} + R_{\text{conv}} = 0.011 + 1.481 = 1.492^\circ\text{C/W}$$

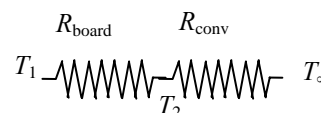

Then surface temperatures on the two sides of the circuit board becomes

$$\dot{Q} = \frac{T_1 - T_\infty}{R_{\text{total}}} \longrightarrow T_1 = T_\infty + \dot{Q}R_{\text{total}} = 37^\circ\text{C} + (15 \text{ W})(1.492^\circ\text{C/W}) = \mathbf{59.4^\circ\text{C}}$$

$$\dot{Q} = \frac{T_1 - T_2}{R_{\text{board}}} \longrightarrow T_2 = T_1 - \dot{Q}R_{\text{board}} = 59.4^\circ\text{C} - (15 \text{ W})(0.011^\circ\text{C/W}) = \mathbf{59.2^\circ\text{C}}$$

(b) Noting that the cross-sectional areas of the fins are constant, the efficiency of these rectangular fins is determined to be

$$m = \sqrt{\frac{hp}{kA_c}} \cong \sqrt{\frac{h(2w)}{k(tw)}} = \sqrt{\frac{2h}{kt}} = \sqrt{\frac{2(45 \text{ W/m}^2\cdot^\circ\text{C})}{(386 \text{ W/m}\cdot^\circ\text{C})(0.002 \text{ m})}} = 10.80 \text{ m}^{-1}$$

$$\eta_{\text{fin}} = \frac{\tanh mL}{mL} = \frac{\tanh(10.80 \text{ m}^{-1} \times 0.02 \text{ m})}{10.80 \text{ m}^{-1} \times 0.02 \text{ m}} = 0.985$$

The finned and unfinned surface areas are

$$A_{\text{finned}} = (20)2w\left(L + \frac{t}{2}\right) = (20)2(0.15)\left(0.02 + \frac{0.002}{2}\right) = 0.126 \text{ m}^2$$

$$A_{\text{unfinned}} = (0.1)(0.15) - 20(0.002)(0.15) = 0.0090 \text{ m}^2$$

Then,

$$\dot{Q}_{\text{finned}} = \eta_{\text{fin}} \dot{Q}_{\text{fin,max}} = \eta_{\text{fin}} hA_{\text{fin}} (T_{\text{base}} - T_\infty)$$

$$\dot{Q}_{\text{unfinned}} = hA_{\text{unfinned}} (T_{\text{base}} - T_\infty)$$

$$\dot{Q}_{\text{total}} = \dot{Q}_{\text{unfinned}} + \dot{Q}_{\text{finned}} = h(T_{\text{base}} - T_\infty)(\eta_{\text{fin}} A_{\text{fin}} + A_{\text{unfinned}})$$

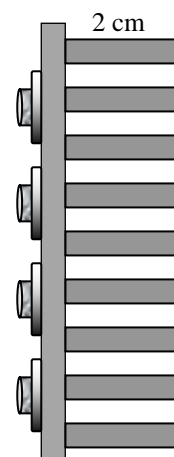

Substituting, the base temperature of the finned surfaces determine to be

$$\begin{aligned} T_{\text{base}} &= T_{\infty} + \frac{\dot{Q}_{\text{total}}}{h(\eta_{\text{fin}} A_{\text{fin}} + A_{\text{unfinned}})} \\ &= 37^{\circ}\text{C} + \frac{15 \text{ W}}{(45 \text{ W/m}^2 \cdot ^{\circ}\text{C})[(0.985)(0.126 \text{ m}^2) + (0.0090 \text{ m}^2)]} = \mathbf{39.5^{\circ}\text{C}} \end{aligned}$$

Then the temperatures on both sides of the board are determined using the thermal resistance network to be

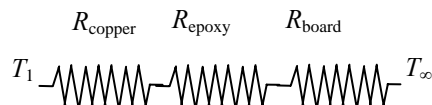

$$R_{\text{copper}} = \frac{L}{kA} = \frac{0.001 \text{ m}}{(386 \text{ W/m} \cdot ^{\circ}\text{C})(0.1 \text{ m})(0.15 \text{ m})} = 0.00017^{\circ}\text{C/W}$$

$$R_{\text{epoxy}} = \frac{L}{kA} = \frac{0.0003 \text{ m}}{(1.8 \text{ W/m} \cdot ^{\circ}\text{C})(0.1 \text{ m})(0.15 \text{ m})} = 0.01111^{\circ}\text{C/W}$$

$$\dot{Q} = \frac{T_1 - T_{\text{base}}}{R_{\text{copper}} + R_{\text{epoxy}} + R_{\text{board}}} = \frac{(T_1 - 39.5)^{\circ}\text{C}}{(0.00017 + 0.01111 + 0.011)^{\circ}\text{C/W}}$$

$$\longrightarrow T_1 = 39.5^{\circ}\text{C} + (15 \text{ W})(0.02228^{\circ}\text{C/W}) = \mathbf{39.8^{\circ}\text{C}}$$

$$\dot{Q} = \frac{T_1 - T_2}{R_{\text{board}}} \longrightarrow T_2 = T_1 - \dot{Q}R_{\text{board}} = 39.8^{\circ}\text{C} - (15 \text{ W})(0.011^{\circ}\text{C/W}) = \mathbf{39.6^{\circ}\text{C}}$$

3-173 Steam passes through a row of 10 parallel pipes placed horizontally in a concrete floor exposed to room air at 20°C with a heat transfer coefficient of $12\text{ W/m}^2\cdot^\circ\text{C}$. If the surface temperature of the concrete floor is not to exceed 35°C , the minimum burial depth of the steam pipes below the floor surface is to be determined.

Assumptions **1** Steady operating conditions exist. **2** Heat transfer is two-dimensional (no change in the axial direction). **3** Thermal conductivity of the concrete is constant.

Properties The thermal conductivity of concrete is given to be $k = 0.75\text{ W/m}\cdot^\circ\text{C}$.

Analysis In steady operation, the rate of heat loss from the steam through the concrete floor by conduction must be equal to the rate of heat transfer from the concrete floor to the room by combined convection and radiation, which is determined to be

$$\begin{aligned}\dot{Q} &= hA_s(T_s - T_\infty) \\ &= (12\text{ W/m}^2\cdot^\circ\text{C})[(10\text{ m})(5\text{ m})](35 - 20)^\circ\text{C} = 9000\text{ W}\end{aligned}$$

Then the depth the steam pipes should be buried can be determined with the aid of shape factor for this configuration from Table 3-7 to be

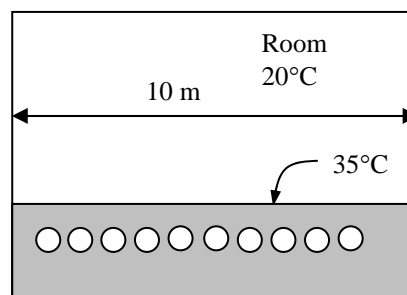

$$\dot{Q} = nSk(T_1 - T_2) \longrightarrow S = \frac{\dot{Q}}{nk(T_1 - T_2)} = \frac{9000\text{ W}}{10(0.75\text{ W/m}\cdot^\circ\text{C})(145 - 35)^\circ\text{C}} = 10.91\text{ m (per pipe)}$$

$$w = \frac{a}{n} = \frac{10\text{ m}}{10} = 1\text{ m (center - to - center distance of pipes)}$$

$$S = \frac{2\pi L}{\ln\left(\frac{2w}{\pi D} \sinh \frac{2\pi z}{w}\right)}$$

$$10.91\text{ m} = \frac{2\pi(5\text{ m})}{\ln\left[\frac{2(1\text{ m})}{\pi(0.06\text{ m})} \sinh \frac{2\pi z}{(1\text{ m})}\right]} \longrightarrow z = 0.205\text{ m} = \mathbf{20.5\text{ cm}}$$

3-174 Two persons are wearing different clothes made of different materials with different surface areas. The fractions of heat lost from each person's body by perspiration are to be determined.

Assumptions 1 Heat transfer is steady. 2 Heat transfer is one-dimensional. 3 Thermal conductivities are constant. 4 Heat transfer by radiation is accounted for in the heat transfer coefficient. 5 The human body is assumed to be cylindrical in shape for heat transfer purposes.

Properties The thermal conductivities of the leather and synthetic fabric are given to be $k = 0.159 \text{ W/m}\cdot^\circ\text{C}$ and $k = 0.13 \text{ W/m}\cdot^\circ\text{C}$, respectively.

Analysis The surface area of each body is first determined from

$$A_1 = \pi DL / 2 = \pi(0.25 \text{ m})(1.7 \text{ m})/2 = 0.6675 \text{ m}^2$$

$$A_2 = 2A_1 = 2 \times 0.6675 = 1.335 \text{ m}^2$$

The sensible heat lost from the first person's body is

$$R_{\text{leather}} = \frac{L}{kA} = \frac{0.001 \text{ m}}{(0.159 \text{ W/m}\cdot^\circ\text{C})(0.6675 \text{ m}^2)} = 0.00942 \text{ }^\circ\text{C/W}$$

$$R_{\text{conv}} = \frac{1}{hA} = \frac{1}{(15 \text{ W/m}^2\cdot^\circ\text{C})(0.6675 \text{ m}^2)} = 0.09988 \text{ }^\circ\text{C/W}$$

$$R_{\text{total}} = R_{\text{leather}} + R_{\text{conv}} = 0.00942 + 0.09988 = 0.10930 \text{ }^\circ\text{C/W}$$

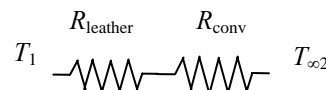

The total sensible heat transfer is the sum of heat transferred through the clothes and the skin

$$\dot{Q}_{\text{clothes}} = \frac{T_1 - T_{\infty 2}}{R_{\text{total}}} = \frac{(32 - 30)^\circ\text{C}}{0.10930^\circ\text{C/W}} = 18.3 \text{ W}$$

$$\dot{Q}_{\text{skin}} = \frac{T_1 - T_{\infty 2}}{R_{\text{conv}}} = \frac{(32 - 30)^\circ\text{C}}{0.09988^\circ\text{C/W}} = 20.0 \text{ W}$$

$$\dot{Q}_{\text{sensible}} = \dot{Q}_{\text{clothes}} + \dot{Q}_{\text{skin}} = 18.3 + 20 = 38.3 \text{ W}$$

Then the fraction of heat lost by respiration becomes

$$f = \frac{\dot{Q}_{\text{respiration}}}{\dot{Q}_{\text{total}}} = \frac{\dot{Q}_{\text{total}} - \dot{Q}_{\text{sensible}}}{\dot{Q}_{\text{total}}} = \frac{60 - 38.3}{60} = \mathbf{0.362}$$

Repeating similar calculations for the second person's body

$$R_{\text{synthetic}} = \frac{L}{kA} = \frac{0.001 \text{ m}}{(0.13 \text{ W/m}\cdot^\circ\text{C})(1.335 \text{ m}^2)} = 0.00576 \text{ }^\circ\text{C/W}$$

$$R_{\text{conv}} = \frac{1}{hA} = \frac{1}{(15 \text{ W/m}^2\cdot^\circ\text{C})(1.335 \text{ m}^2)} = 0.04994 \text{ }^\circ\text{C/W}$$

$$R_{\text{total}} = R_{\text{leather}} + R_{\text{conv}} = 0.00576 + 0.04994 = 0.05570 \text{ }^\circ\text{C/W}$$

$$\dot{Q}_{\text{sensible}} = \frac{T_1 - T_{\infty 2}}{R_{\text{total}}} = \frac{(32 - 30)^\circ\text{C}}{0.05570^\circ\text{C/W}} = 35.9 \text{ W}$$

$$f = \frac{\dot{Q}_{\text{respiration}}}{\dot{Q}_{\text{total}}} = \frac{\dot{Q}_{\text{total}} - \dot{Q}_{\text{sensible}}}{\dot{Q}_{\text{total}}} = \frac{60 - 35.9}{60} = \mathbf{0.402}$$

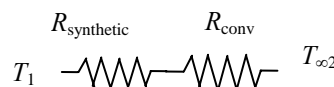

3-175 A wall constructed of three layers is considered. The rate of heat transfer through the wall and temperature drops across the plaster, brick, covering, and surface-ambient air are to be determined.

Assumptions 1 Heat transfer is steady. 2 Heat transfer is one-dimensional. 3 Thermal conductivities are constant. 4 Heat transfer by radiation is accounted for in the heat transfer coefficient.

Properties The thermal conductivities of the plaster, brick, and covering are given to be $k = 0.72 \text{ W/m}\cdot^\circ\text{C}$, $k = 0.36 \text{ W/m}\cdot^\circ\text{C}$, $k = 1.40 \text{ W/m}\cdot^\circ\text{C}$, respectively.

Analysis The surface area of the wall and the individual resistances are

$$A = (6 \text{ m}) \times (2.8 \text{ m}) = 16.8 \text{ m}^2$$

$$R_1 = R_{\text{plaster}} = \frac{L_1}{k_1 A} = \frac{0.01 \text{ m}}{(0.36 \text{ W/m}\cdot^\circ\text{C})(16.8 \text{ m}^2)} = 0.00165 \text{ }^\circ\text{C/W}$$

$$R_2 = R_{\text{brick}} = \frac{L_2}{k_2 A} = \frac{0.20 \text{ m}}{(0.72 \text{ W/m}\cdot^\circ\text{C})(16.8 \text{ m}^2)} = 0.01653 \text{ }^\circ\text{C/W}$$

$$R_3 = R_{\text{covering}} = \frac{L_3}{k_3 A} = \frac{0.02 \text{ m}}{(1.4 \text{ W/m}\cdot^\circ\text{C})(16.8 \text{ m}^2)} = 0.00085 \text{ }^\circ\text{C/W}$$

$$R_o = R_{\text{conv},2} = \frac{1}{h_2 A} = \frac{1}{(17 \text{ W/m}^2\cdot^\circ\text{C})(16.8 \text{ m}^2)} = 0.00350 \text{ }^\circ\text{C/W}$$

$$R_{\text{total}} = R_1 + R_2 + R_3 + R_{\text{conv},2}$$

$$= 0.00165 + 0.01653 + 0.00085 + 0.00350 = 0.02253 \text{ }^\circ\text{C/W}$$

The steady rate of heat transfer through the wall then becomes

$$\dot{Q} = \frac{T_1 - T_{\infty 2}}{R_{\text{total}}} = \frac{(23 - 8)^\circ\text{C}}{0.02253 \text{ }^\circ\text{C/W}} = \mathbf{665.8 \text{ W}}$$

The temperature drops are

$$\Delta T_{\text{plaster}} = \dot{Q} R_{\text{plaster}} = (665.8 \text{ W})(0.00165 \text{ }^\circ\text{C/W}) = \mathbf{1.1 \text{ }^\circ\text{C}}$$

$$\Delta T_{\text{brick}} = \dot{Q} R_{\text{brick}} = (665.8 \text{ W})(0.01653 \text{ }^\circ\text{C/W}) = \mathbf{11.0 \text{ }^\circ\text{C}}$$

$$\Delta T_{\text{covering}} = \dot{Q} R_{\text{covering}} = (665.8 \text{ W})(0.00085 \text{ }^\circ\text{C/W}) = \mathbf{0.6 \text{ }^\circ\text{C}}$$

$$\Delta T_{\text{conv}} = \dot{Q} R_{\text{conv}} = (665.8 \text{ W})(0.00350 \text{ }^\circ\text{C/W}) = \mathbf{2.3 \text{ }^\circ\text{C}}$$

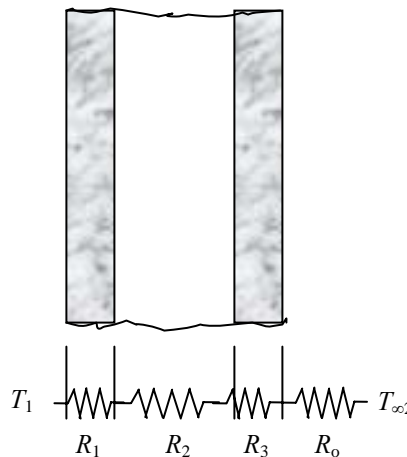

3-176 An insulation is to be added to a wall to decrease the heat loss by 85%. The thickness of insulation and the outer surface temperature of the wall are to be determined for two different insulating materials.

Assumptions 1 Heat transfer is steady. 2 Heat transfer is one-dimensional. 3 Thermal conductivities are constant. 4 Heat transfer by radiation is accounted for in the heat transfer coefficient.

Properties The thermal conductivities of the plaster, brick, covering, polyurethane foam, and glass fiber are given to be 0.72 W/m·°C, 0.36 W/m·°C, 1.40 W/m·°C, 0.025 W/m·°C, 0.036 W/m·°C, respectively.

Analysis The surface area of the wall and the individual resistances are

$$A = (6 \text{ m}) \times (2.8 \text{ m}) = 16.8 \text{ m}^2$$

$$R_1 = R_{\text{plaster}} = \frac{L_1}{k_1 A} = \frac{0.01 \text{ m}}{(0.36 \text{ W/m}\cdot^\circ\text{C})(16.8 \text{ m}^2)} = 0.00165^\circ\text{C/W}$$

$$R_2 = R_{\text{brick}} = \frac{L_2}{k_2 A} = \frac{0.20 \text{ m}}{(0.72 \text{ W/m}\cdot^\circ\text{C})(16.8 \text{ m}^2)} = 0.01653^\circ\text{C/W}$$

$$R_3 = R_{\text{covering}} = \frac{L_3}{k_3 A} = \frac{0.02 \text{ m}}{(1.4 \text{ W/m}\cdot^\circ\text{C})(16.8 \text{ m}^2)} = 0.00085^\circ\text{C/W}$$

$$R_o = R_{\text{conv},2} = \frac{1}{h_2 A} = \frac{1}{(17 \text{ W/m}^2\cdot^\circ\text{C})(16.8 \text{ m}^2)} = 0.00350^\circ\text{C/W}$$

$$\begin{aligned} R_{\text{total, no ins}} &= R_1 + R_2 + R_3 + R_{\text{conv},2} \\ &= 0.00165 + 0.01653 + 0.00085 + 0.00350 \\ &= 0.02253^\circ\text{C/W} \end{aligned}$$

The rate of heat loss without the insulation is

$$\dot{Q} = \frac{T_1 - T_{\infty 2}}{R_{\text{total, no ins}}} = \frac{(23 - 8)^\circ\text{C}}{0.02253^\circ\text{C/W}} = 666 \text{ W}$$

(a) The rate of heat transfer after insulation is

$$\dot{Q}_{\text{ins}} = 0.15 \dot{Q}_{\text{no ins}} = 0.15 \times 666 = 99.9 \text{ W}$$

The total thermal resistance with the foam insulation is

$$\begin{aligned} R_{\text{total}} &= R_1 + R_2 + R_3 + R_{\text{foam}} + R_{\text{conv},2} \\ &= 0.02253^\circ\text{C/W} + \frac{L_4}{(0.025 \text{ W/m}\cdot^\circ\text{C})(16.8 \text{ m}^2)} \\ &= 0.02253^\circ\text{C/W} + \frac{L_4}{(0.42 \text{ W}\cdot\text{m}^2/\text{C})} \end{aligned}$$

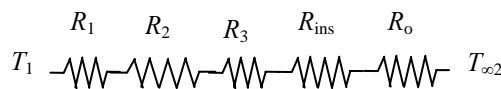
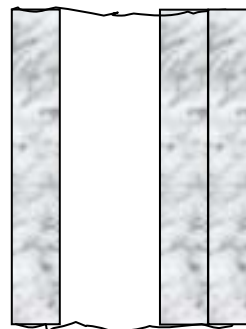

The thickness of insulation is determined from

$$\dot{Q}_{\text{ins}} = \frac{T_1 - T_{\infty 2}}{R_{\text{total}}} \rightarrow 99.9 \text{ W} = \frac{(23 - 8)^\circ\text{C}}{0.02253^\circ\text{C/W} + \frac{L_4}{(0.42 \text{ W}\cdot\text{m}^2/\text{C})}} \rightarrow L_4 = \mathbf{0.054 \text{ m} = 5.4 \text{ cm}}$$

The outer surface temperature of the wall is determined from

$$\dot{Q}_{\text{ins}} = \frac{T_2 - T_{\infty 2}}{R_{\text{conv}}} \rightarrow 99.9 \text{ W} = \frac{(T_2 - 8)^\circ\text{C}}{0.00350^\circ\text{C/W}} \rightarrow T_2 = \mathbf{8.3^\circ\text{C}}$$

(b) The total thermal resistance with the fiberglass insulation is

$$R_{\text{total}} = R_1 + R_2 + R_3 + R_{\text{fiber glass}} + R_{\text{conv},2}$$

$$= 0.02253 \text{ }^\circ\text{C/W} + \frac{L_4}{(0.036 \text{ W/m}\cdot^\circ\text{C})(16.8 \text{ m}^2)} = 0.02253 \text{ }^\circ\text{C/W} + \frac{L_4}{(0.6048 \text{ W}\cdot\text{m}/^\circ\text{C})}$$

The thickness of insulation is determined from

$$\dot{Q}_{\text{ins}} = \frac{T_1 - T_{\infty 2}}{R_{\text{total}}} \longrightarrow 99.9 \text{ W} = \frac{(23 - 8)^\circ\text{C}}{0.02253 \text{ }^\circ\text{C/W} + \frac{L_4}{(0.6048 \text{ W}\cdot\text{m}/^\circ\text{C})}} \longrightarrow L_4 = \mathbf{0.077 \text{ m} = 7.7 \text{ cm}}$$

The outer surface temperature of the wall is determined from

$$\dot{Q}_{\text{ins}} = \frac{T_2 - T_{\infty 2}}{R_{\text{conv}}} \longrightarrow 99.9 = \frac{(T_2 - 8)^\circ\text{C}}{0.00350 \text{ }^\circ\text{C/W}} \longrightarrow T_2 = \mathbf{8.3^\circ\text{C}}$$

Discussion The outer surface temperature is same for both cases since the rate of heat transfer does not change.

3-177 Cold conditioned air is flowing inside a duct of square cross-section. The maximum length of the duct for a specified temperature increase in the duct is to be determined.

Assumptions 1 Heat transfer is steady. 2 Heat transfer is one-dimensional. 3 Thermal conductivities are constant. 4 Steady one-dimensional heat conduction relations can be used due to small thickness of the duct wall. 5 When calculating the conduction thermal resistance of aluminum, the average of inner and outer surface areas will be used.

Properties The thermal conductivity of aluminum is given to be $237 \text{ W/m}\cdot^\circ\text{C}$. The specific heat of air at the given temperature is $c_p = 1006 \text{ J/kg}\cdot^\circ\text{C}$ (Table A-15).

Analysis The inner and the outer surface areas of the duct per unit length and the individual thermal resistances are

$$A_1 = 4a_1 L = 4(0.22 \text{ m})(1 \text{ m}) = 0.88 \text{ m}^2$$

$$A_2 = 4a_2 L = 4(0.25 \text{ m})(1 \text{ m}) = 1.0 \text{ m}^2$$

$$R_i = \frac{1}{h_1 A} = \frac{1}{(75 \text{ W/m}^2\cdot^\circ\text{C})(0.88 \text{ m}^2)} = 0.01515 \text{ }^\circ\text{C/W}$$

$$R_{\text{alum}} = \frac{L}{kA} = \frac{0.015 \text{ m}}{(237 \text{ W/m}\cdot^\circ\text{C})[(0.88 + 1) / 2] \text{ m}^2} = 0.00007 \text{ }^\circ\text{C/W}$$

$$R_o = \frac{1}{h_2 A} = \frac{1}{(13 \text{ W/m}^2\cdot^\circ\text{C})(1.0 \text{ m}^2)} = 0.07692 \text{ }^\circ\text{C/W}$$

$$R_{\text{total}} = R_i + R_{\text{alum}} + R_o = 0.01515 + 0.00007 + 0.07692 = 0.09214 \text{ }^\circ\text{C/W}$$

The rate of heat loss from the air inside the duct is

$$\dot{Q} = \frac{T_{\infty 2} - T_{\infty 1}}{R_{\text{total}}} = \frac{(33 - 12)^\circ\text{C}}{0.09214 \text{ }^\circ\text{C/W}} = 228 \text{ W}$$

For a temperature rise of 1°C , the air inside the duct should gain heat at a rate of

$$\dot{Q}_{\text{total}} = \dot{m} c_p \Delta T = (0.8 \text{ kg/s})(1006 \text{ J/kg}\cdot^\circ\text{C})(1^\circ\text{C}) = 805 \text{ W}$$

Then the maximum length of the duct becomes

$$L = \frac{\dot{Q}_{\text{total}}}{\dot{Q}} = \frac{805 \text{ W}}{228 \text{ W}} = \mathbf{3.53 \text{ m}}$$

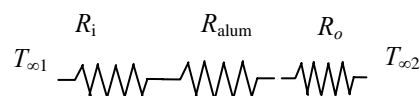

3-178 Heat transfer through a window is considered. The percent error involved in the calculation of heat gain through the window assuming the window consist of glass only is to be determined.

Assumptions 1 Heat transfer is steady. 2 Heat transfer is one-dimensional. 3 Thermal conductivities are constant.

4 Radiation is accounted for in heat transfer coefficients.

Properties The thermal conductivities are given to be $0.7 \text{ W/m}\cdot^\circ\text{C}$ for glass and $0.12 \text{ W/m}\cdot^\circ\text{C}$ for pine wood.

Analysis The surface areas of the glass and the wood and the individual thermal resistances are

$$A_{\text{glass}} = 0.85(1.5 \text{ m})(2 \text{ m}) = 2.55 \text{ m}^2 \quad A_{\text{wood}} = 0.15(1.5 \text{ m})(2 \text{ m}) = 0.45 \text{ m}^2$$

$$R_{i,\text{glass}} = \frac{1}{h_1 A_{\text{glass}}} = \frac{1}{(7 \text{ W/m}^2\cdot^\circ\text{C})(2.55 \text{ m}^2)} = 0.05602^\circ\text{C/W}$$

$$R_{i,\text{wood}} = \frac{1}{h_1 A_{\text{wood}}} = \frac{1}{(7 \text{ W/m}^2\cdot^\circ\text{C})(0.45 \text{ m}^2)} = 0.31746^\circ\text{C/W}$$

$$R_{\text{glass}} = \frac{L_{\text{glass}}}{k_{\text{glass}} A_{\text{glass}}} = \frac{0.003 \text{ m}}{(0.7 \text{ W/m}\cdot^\circ\text{C})(2.55 \text{ m}^2)} = 0.00168^\circ\text{C/W}$$

$$R_{\text{wood}} = \frac{L_{\text{wood}}}{k_{\text{wood}} A_{\text{wood}}} = \frac{0.05 \text{ m}}{(0.12 \text{ W/m}\cdot^\circ\text{C})(0.45 \text{ m}^2)} = 0.92593^\circ\text{C/W}$$

$$R_{o,\text{glass}} = \frac{1}{h_2 A_{\text{glass}}} = \frac{1}{(13 \text{ W/m}^2\cdot^\circ\text{C})(2.55 \text{ m}^2)} = 0.03017^\circ\text{C/W}$$

$$R_{o,\text{wood}} = \frac{1}{h_2 A_{\text{wood}}} = \frac{1}{(13 \text{ W/m}^2\cdot^\circ\text{C})(0.45 \text{ m}^2)} = 0.17094^\circ\text{C/W}$$

$$R_{\text{total,glass}} = R_{i,\text{glass}} + R_{\text{glass}} + R_{o,\text{glass}} = 0.05602 + 0.00168 + 0.03017 = 0.08787^\circ\text{C/W}$$

$$R_{\text{total,wood}} = R_{i,\text{wood}} + R_{\text{wood}} + R_{o,\text{wood}} = 0.31746 + 0.92593 + 0.17094 = 1.41433^\circ\text{C/W}$$

The rate of heat gain through the glass and the wood and their total are

$$\dot{Q}_{\text{glass}} = \frac{T_{\infty 2} - T_{\infty 1}}{R_{\text{total,glass}}} = \frac{(40 - 24)^\circ\text{C}}{0.08787^\circ\text{C/W}} = 182.1 \text{ W} \quad \dot{Q}_{\text{wood}} = \frac{T_{\infty 2} - T_{\infty 1}}{R_{\text{total,wood}}} = \frac{(40 - 24)^\circ\text{C}}{1.41433^\circ\text{C/W}} = 11.3 \text{ W}$$

$$\dot{Q}_{\text{total}} = \dot{Q}_{\text{glass}} + \dot{Q}_{\text{wood}} = 182.1 + 11.3 = 193.4 \text{ W}$$

If the window consists of glass only the heat gain through the window is

$$A_{\text{glass}} = (1.5 \text{ m})(2 \text{ m}) = 3.0 \text{ m}^2$$

$$R_{i,\text{glass}} = \frac{1}{h_1 A_{\text{glass}}} = \frac{1}{(7 \text{ W/m}^2\cdot^\circ\text{C})(3.0 \text{ m}^2)} = 0.04762^\circ\text{C/W}$$

$$R_{\text{glass}} = \frac{L_{\text{glass}}}{k_{\text{glass}} A_{\text{glass}}} = \frac{0.003 \text{ m}}{(0.7 \text{ W/m}\cdot^\circ\text{C})(3.0 \text{ m}^2)} = 0.00143^\circ\text{C/W}$$

$$R_{o,\text{glass}} = \frac{1}{h_2 A_{\text{glass}}} = \frac{1}{(13 \text{ W/m}^2\cdot^\circ\text{C})(3.0 \text{ m}^2)} = 0.02564^\circ\text{C/W}$$

$$R_{\text{total,glass}} = R_{i,\text{glass}} + R_{\text{glass}} + R_{o,\text{glass}} = 0.04762 + 0.00143 + 0.02564 = 0.07469^\circ\text{C/W}$$

$$\dot{Q}_{\text{glass}} = \frac{T_{\infty 2} - T_{\infty 1}}{R_{\text{total,glass}}} = \frac{(40 - 24)^\circ\text{C}}{0.07469^\circ\text{C/W}} = 214.2 \text{ W}$$

Then the percentage error involved in heat gain through the window assuming the window consist of glass only becomes

$$\% \text{ Error} = \frac{\dot{Q}_{\text{glass only}} - \dot{Q}_{\text{with wood}}}{\dot{Q}_{\text{with wood}}} = \frac{214.2 - 193.4}{193.4} \times 100 = \mathbf{10.8\%}$$

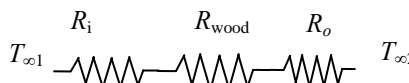
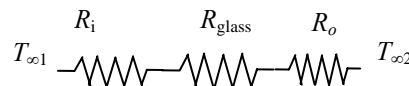

3-179 Steam is flowing inside a steel pipe. The thickness of the insulation needed to reduce the heat loss by 95 percent and the thickness of the insulation needed to reduce outer surface temperature to 40°C are to be determined.

Assumptions 1 Heat transfer is steady since there is no indication of any change with time. **2** Heat transfer is one-dimensional since there is thermal symmetry about the centerline and no variation in the axial direction. **3** Thermal conductivities are constant. **4** The thermal contact resistance at the interface is negligible.

Properties The thermal conductivities are given to be $k = 61 \text{ W/m}\cdot\text{°C}$ for steel and $k = 0.038 \text{ W/m}\cdot\text{°C}$ for insulation.

Analysis (a) Considering a unit length of the pipe, the inner and the outer surface areas of the pipe and the insulation are

$$A_1 = \pi D_i L = \pi(0.10 \text{ m})(1 \text{ m}) = 0.3142 \text{ m}^2$$

$$A_2 = \pi D_o L = \pi(0.12 \text{ m})(1 \text{ m}) = 0.3770 \text{ m}^2$$

$$A_3 = \pi D_3 L = \pi D_3 (1 \text{ m}) = 3.1416 D_3 \text{ m}^2$$

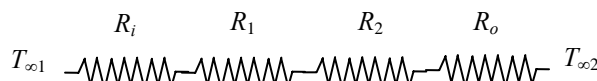

The individual thermal resistances are

$$R_i = \frac{1}{h_i A_i} = \frac{1}{(105 \text{ W/m}^2\cdot\text{°C})(0.3142 \text{ m}^2)} = 0.03031 \text{ °C/W}$$

$$R_1 = R_{\text{pipe}} = \frac{\ln(r_2 / r_1)}{2\pi k_1 L} = \frac{\ln(6/5)}{2\pi(61 \text{ W/m}\cdot\text{°C})(1 \text{ m})} = 0.00048 \text{ °C/W}$$

$$R_2 = R_{\text{insulation}} = \frac{\ln(r_3 / r_2)}{2\pi k_2 L} = \frac{\ln(D_3 / 0.12)}{2\pi(0.038 \text{ W/m}\cdot\text{°C})(1 \text{ m})} = \frac{\ln(D_3 / 0.12)}{0.23876} \text{ °C/W}$$

$$R_{o,\text{steel}} = \frac{1}{h_o A_o} = \frac{1}{(14 \text{ W/m}^2\cdot\text{°C})(0.3770 \text{ m}^2)} = 0.18947 \text{ °C/W}$$

$$R_{o,\text{insulation}} = \frac{1}{h_o A_o} = \frac{1}{(14 \text{ W/m}^2\cdot\text{°C})(3.1416 D_3 \text{ m}^2)} = \frac{0.02274}{D_3} \text{ °C/W}$$

$$R_{\text{total, no insulation}} = R_i + R_1 + R_{o,\text{steel}} = 0.03031 + 0.00048 + 0.18947 = 0.22026 \text{ °C/W}$$

$$\begin{aligned} R_{\text{total, insulation}} &= R_i + R_1 + R_2 + R_{o,\text{insulation}} = 0.03031 + 0.00048 + \frac{\ln(D_3 / 0.12)}{0.23876} + \frac{0.02274}{D_3} \\ &= 0.03079 + \frac{\ln(D_3 / 0.12)}{0.23876} + \frac{0.02274}{D_3} \text{ °C/W} \end{aligned}$$

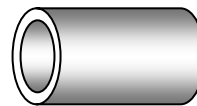

Then the steady rate of heat loss from the steam per meter pipe length for the case of no insulation becomes

$$\dot{Q} = \frac{T_{\infty 1} - T_{\infty 2}}{R_{\text{total}}} = \frac{(235 - 20) \text{ °C}}{0.22026 \text{ °C/W}} = 976.1 \text{ W}$$

The thickness of the insulation needed in order to save 95 percent of this heat loss can be determined from

$$\dot{Q}_{\text{insulation}} = \frac{T_{\infty 1} - T_{\infty 2}}{R_{\text{total, insulation}}} \longrightarrow (0.05 \times 976.1) \text{ W} = \frac{(235 - 20) \text{ °C}}{\left(0.03079 + \frac{\ln(D_3 / 0.12)}{0.23876} + \frac{0.02274}{D_3}\right) \text{ °C/W}}$$

whose solution is

$$D_3 = 0.3355 \text{ m} \longrightarrow \text{thickness} = \frac{D_3 - D_2}{2} = \frac{33.55 - 12}{2} = \mathbf{10.78 \text{ cm}}$$

(b) The thickness of the insulation needed that would maintain the outer surface of the insulation at a maximum temperature of 40°C can be determined from

$$\dot{Q}_{\text{insulation}} = \frac{T_{\infty 1} - T_{\infty 2}}{R_{\text{total,insulation}}} = \frac{T_2 - T_{\infty 2}}{R_{o,\text{insulation}}}$$

$$\rightarrow \frac{(235 - 20)^{\circ}\text{C}}{\left(0.03079 + \frac{\ln(D_3 / 0.12)}{0.23876} + \frac{0.02274}{D_3}\right)^{\circ}\text{C/W}} = \frac{(40 - 20)^{\circ}\text{C}}{\frac{0.02274}{D_3}^{\circ}\text{C/W}}$$

whose solution is

$$D_3 = 0.1644 \text{ m} \rightarrow \text{thickness} = \frac{D_3 - D_2}{2} = \frac{16.44 - 12}{2} = \mathbf{2.22 \text{ cm}}$$

3-180 A 6-m-diameter spherical tank filled with liquefied natural gas (LNG) at -160°C is exposed to ambient air. The time for the LNG temperature to rise to -150°C is to be determined.

Assumptions 1 Heat transfer can be considered to be steady since the specified thermal conditions at the boundaries do not change with time significantly. **2** Heat transfer is one-dimensional since there is thermal symmetry about the midpoint. **3** Radiation is accounted for in the combined heat transfer coefficient. **3** The combined heat transfer coefficient is constant and uniform over the entire surface. **4** The temperature of the thin-shelled spherical tank is said to be nearly equal to the temperature of the LNG inside, and thus thermal resistance of the tank and the internal convection resistance are negligible.

Properties The density and specific heat of LNG are given to be 425 kg/m³ and 3.475 kJ/kg·°C, respectively. The thermal conductivity of super insulation is given to be $k = 0.00008 \text{ W/m}\cdot^{\circ}\text{C}$.

Analysis The inner and outer surface areas of the insulated tank and the volume of the LNG are

$$A_1 = \pi D_1^2 = \pi(4 \text{ m})^2 = 50.27 \text{ m}^2$$

$$A_2 = \pi D_2^2 = \pi(4.10 \text{ m})^2 = 52.81 \text{ m}^2$$

$$V_1 = \pi D_1^3 / 6 = \pi(4 \text{ m})^3 / 6 = 33.51 \text{ m}^3$$

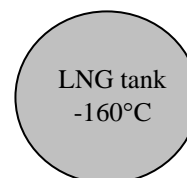
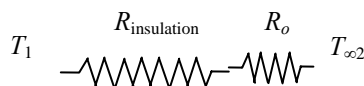

The rate of heat transfer to the LNG is

$$R_{\text{insulation}} = \frac{r_2 - r_1}{4\pi k r_1 r_2} = \frac{(2.05 - 2.0) \text{ m}}{4\pi(0.00008 \text{ W/m}\cdot^{\circ}\text{C})(2.0 \text{ m})(2.05 \text{ m})} = 12.13071^{\circ}\text{C/W}$$

$$R_o = \frac{1}{h_o A} = \frac{1}{(22 \text{ W/m}^2\cdot^{\circ}\text{C})(52.81 \text{ m}^2)} = 0.00086^{\circ}\text{C/W}$$

$$R_{\text{total}} = R_o + R_{\text{insulation}} = 0.00086 + 12.13071 = 12.13157^{\circ}\text{C/W}$$

$$\dot{Q} = \frac{T_{\infty 2} - T_{\text{LNG}}}{R_{\text{total}}} = \frac{[24 - (-155)]^{\circ}\text{C}}{12.13157^{\circ}\text{C/W}} = 14.75 \text{ W}$$

We used average LNG temperature in heat transfer rate calculation. The amount of heat transfer to increase the LNG temperature from -160°C to -150°C is

$$m = \rho V_1 = (425 \text{ kg/m}^3)(33.51 \text{ m}^3) = 14,242 \text{ kg}$$

$$Q = mc_p \Delta T = (14,242 \text{ kg})(3.475 \text{ kJ/kg}\cdot^{\circ}\text{C})[(-150) - (-160)^{\circ}\text{C}] = 4.95 \times 10^5 \text{ kJ}$$

Assuming that heat will be lost from the LNG at an average rate of 15.17 W, the time period for the LNG temperature to rise to -150°C becomes

$$\Delta t = \frac{Q}{\dot{Q}} = \frac{4.95 \times 10^5 \text{ kJ}}{0.01475 \text{ kW}} = 3.355 \times 10^7 \text{ s} = 9320 \text{ h} = \mathbf{388 \text{ days}}$$

3-181 A hot plate is to be cooled by attaching aluminum fins of square cross section on one side. The number of fins needed to triple the rate of heat transfer is to be determined.

Assumptions 1 Steady operating conditions exist. 2 The temperature along the fins varies in one direction only (normal to the plate). 3 Heat transfer from the fin tips is negligible. 4 The heat transfer coefficient is constant and uniform over the entire fin surface. 5 The thermal properties of the fins are constant. 6 The heat transfer coefficient accounts for the effect of radiation from the fins.

Properties The thermal conductivity of the aluminum fins is given to be $k = 237 \text{ W/m}\cdot^\circ\text{C}$.

Analysis Noting that the cross-sectional areas of the fins are constant, the efficiency of the square cross-section fins can be determined to be

$$m = \sqrt{\frac{hp}{kA_c}} = \sqrt{\frac{4ha}{ka^2}} = \sqrt{\frac{4(20 \text{ W/m}^2\cdot^\circ\text{C})(0.002 \text{ m})}{(237 \text{ W/m}\cdot^\circ\text{C})(0.002 \text{ m})^2}} = 12.99 \text{ m}^{-1}$$

$$\eta_{\text{fin}} = \frac{\tanh mL}{mL} = \frac{\tanh(12.99 \text{ m}^{-1} \times 0.04 \text{ m})}{12.99 \text{ m}^{-1} \times 0.04 \text{ m}} = 0.919$$

The finned and unfinned surface areas, and heat transfer rates from these areas are

$$\begin{aligned} A_{\text{fin}} &= n_{\text{fin}} \times 4 \times (0.002 \text{ m})(0.04 \text{ m}) = 0.00032n_{\text{fin}} \text{ m}^2 \\ A_{\text{unfinned}} &= (0.15 \text{ m})(0.20 \text{ m}) - n_{\text{fin}}(0.002 \text{ m})(0.002 \text{ m}) \\ &= 0.03 - 0.000004n_{\text{fin}} \text{ m}^2 \\ \dot{Q}_{\text{finned}} &= \eta_{\text{fin}} \dot{Q}_{\text{fin,max}} = \eta_{\text{fin}} hA_{\text{fin}}(T_b - T_\infty) \\ &= 0.919(20 \text{ W/m}^2\cdot^\circ\text{C})(0.00032n_{\text{fin}} \text{ m}^2)(85 - 25)^\circ\text{C} \\ &= 0.35328n_{\text{fin}} \text{ W} \\ \dot{Q}_{\text{unfinned}} &= hA_{\text{unfinned}}(T_b - T_\infty) = (20 \text{ W/m}^2\cdot^\circ\text{C})(0.03 - 0.000004n_{\text{fin}} \text{ m}^2)(85 - 25)^\circ\text{C} \\ &= 36 - 0.0048n_{\text{fin}} \text{ W} \end{aligned}$$

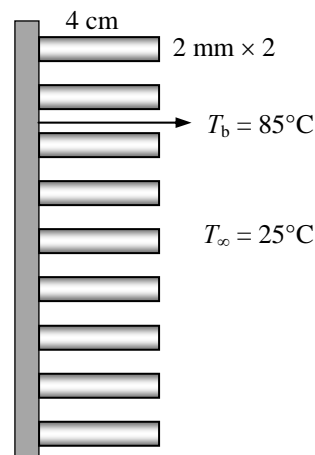

Then the total heat transfer from the finned plate becomes

$$\dot{Q}_{\text{total,fin}} = \dot{Q}_{\text{finned}} + \dot{Q}_{\text{unfinned}} = 0.35328n_{\text{fin}} + 36 - 0.0048n_{\text{fin}} \text{ W}$$

The rate of heat transfer if there were no fin attached to the plate would be

$$\begin{aligned} A_{\text{no fin}} &= (0.15 \text{ m})(0.20 \text{ m}) = 0.03 \text{ m}^2 \\ \dot{Q}_{\text{no fin}} &= hA_{\text{no fin}}(T_b - T_\infty) = (20 \text{ W/m}^2\cdot^\circ\text{C})(0.03 \text{ m}^2)(85 - 25)^\circ\text{C} = 36 \text{ W} \end{aligned}$$

The number of fins can be determined from the overall fin effectiveness equation

$$\varepsilon_{\text{fin}} = \frac{\dot{Q}_{\text{fin}}}{\dot{Q}_{\text{no fin}}} \longrightarrow 3 = \frac{0.35328n_{\text{fin}} + 36 - 0.0048n_{\text{fin}}}{36} \longrightarrow n_{\text{fin}} = \mathbf{207}$$

3-182 EES Prob. 3-181 is reconsidered. The number of fins as a function of the increase in the heat loss by fins relative to no fin case (i.e., overall effectiveness of the fins) is to be plotted.

Analysis The problem is solved using EES, and the solution is given below.

"GIVEN"

A_surface=0.15*0.20 [m^2]
 T_b=85 [C]; k=237 [W/m-C]
 side=0.002 [m]; L=0.04 [m]
 T_infinity=25 [C]
 h=20 [W/m^2-C]
 epsilon_fin=3

"ANALYSIS"

A_c=side^2
 p=4*side
 a=sqrt((h*p)/(k*A_c))
 eta_fin=tanh(a*L)/(a*L)
 A_fin=n_fin*4*side*L
 A_unfinned=A_surface-n_fin*side^2
 Q_dot_finned=eta_fin*h*A_fin*(T_b-T_infinity)
 Q_dot_unfinned=h*A_unfinned*(T_b-T_infinity)
 Q_dot_total_fin=Q_dot_finned+Q_dot_unfinned
 Q_dot_nofin=h*A_surface*(T_b-T_infinity)
 epsilon_fin=Q_dot_total_fin/Q_dot_nofin

ϵ_{fin}	n_{fin}
1.5	51.72
1.75	77.59
2	103.4
2.25	129.3
2.5	155.2
2.75	181
3	206.9
3.25	232.8
3.5	258.6
3.75	284.5
4	310.3
4.25	336.2
4.5	362.1
4.75	387.9
5	413.8

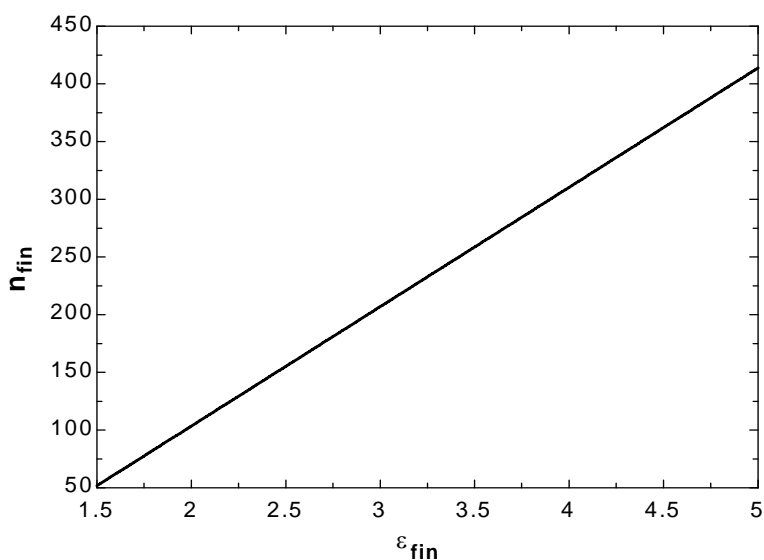

3-183 A spherical tank containing iced water is buried underground. The rate of heat transfer to the tank is to be determined for the insulated and uninsulated ground surface cases.

Assumptions 1 Steady operating conditions exist. 2 Heat transfer is two-dimensional (no change in the axial direction). 3 Thermal conductivity of the soil is constant. 4 The tank surface is assumed to be at the same temperature as the iced water because of negligible resistance through the steel.

Properties The thermal conductivity of the soil is given to be $k = 0.55 \text{ W/m}\cdot\text{C}$.

Analysis The shape factor for this configuration is given in Table 3-7 to be

$$S = \frac{2\pi D}{1 - 0.25 \frac{D}{z}} = \frac{2\pi(1.4 \text{ m})}{1 - 0.25 \frac{1.4 \text{ m}}{2.4 \text{ m}}} = 10.30 \text{ m}$$

Then the steady rate of heat transfer from the tank becomes

$$\dot{Q} = Sk(T_1 - T_2) = (10.30 \text{ m})(0.55 \text{ W/m}\cdot\text{C})(18 - 0)\text{C} = \mathbf{102 \text{ W}}$$

If the ground surface is insulated,

$$S = \frac{2\pi D}{1 + 0.25 \frac{D}{z}} = \frac{2\pi(1.4 \text{ m})}{1 + 0.25 \frac{1.4 \text{ m}}{2.4 \text{ m}}} = 7.68 \text{ m}$$

$$\dot{Q} = Sk(T_1 - T_2) = (7.68 \text{ m})(0.55 \text{ W/m}\cdot\text{C})(18 - 0)\text{C} = \mathbf{76 \text{ W}}$$

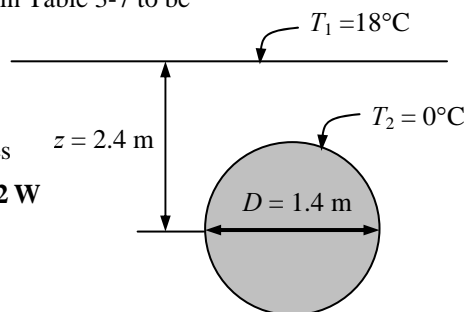

3-184 A cylindrical tank containing liquefied natural gas (LNG) is placed at the center of a square solid bar. The rate of heat transfer to the tank and the LNG temperature at the end of a one-month period are to be determined.

Assumptions 1 Steady operating conditions exist. 2 Heat transfer is two-dimensional (no change in the axial direction). 3 Thermal conductivity of the bar is constant. 4 The tank surface is at the same temperature as the LNG.

Properties The thermal conductivity of the bar is given to be $k = 0.0002 \text{ W/m}\cdot\text{C}$. The density and the specific heat of LNG are given to be 425 kg/m^3 and $3.475 \text{ kJ/kg}\cdot\text{C}$, respectively.

Analysis The shape factor for this configuration is given in Table 3-7 to be

$$S = \frac{2\pi L}{\ln\left(\frac{1.08w}{D}\right)} = \frac{2\pi(1.9 \text{ m})}{\ln\left(1.08 \frac{1.4 \text{ m}}{0.6 \text{ m}}\right)} = 12.92 \text{ m}$$

Then the steady rate of heat transfer to the tank becomes

$$\dot{Q} = Sk(T_1 - T_2) = (12.92 \text{ m})(0.0002 \text{ W/m}\cdot\text{C})[12 - (-160)]\text{C} = \mathbf{0.4444 \text{ W}}$$

The mass of LNG is

$$m = \rho V = \rho \pi \frac{D^3}{6} = (425 \text{ kg/m}^3)\pi \frac{(0.6 \text{ m})^3}{6} = 48.07 \text{ kg}$$

The amount heat transfer to the tank for a one-month period is

$$Q = \dot{Q}\Delta t = (0.4444 \text{ W})(30 \times 24 \times 3600 \text{ s}) = 1.152 \times 10^6 \text{ J}$$

Then the temperature of LNG at the end of the month becomes

$$Q = mc_p(T_1 - T_2)$$

$$1.152 \times 10^6 \text{ J} = (48.07 \text{ kg})(3475 \text{ J/kg}\cdot\text{C})[(-160) - T_2]\text{C}$$

$$T_2 = \mathbf{-153.1\text{C}}$$

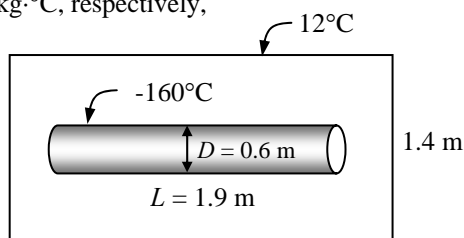

3-185 A typical section of a building wall is considered. The temperature on the interior brick surface is to be determined.

Assumptions 1 Steady operating conditions exist.

Properties The thermal conductivities are given to be $k_{23b} = 50$ W/m·K, $k_{23a} = 0.03$ W/m·K, $k_{12} = 0.5$ W/m·K, $k_{34} = 1.0$ W/m·K.

Analysis We consider 1 m² of wall area. The thermal resistances are

$$R_{12} = \frac{t_{12}}{k_{12}} = \frac{0.01 \text{ m}}{(0.5 \text{ W/m} \cdot \text{°C})} = 0.02 \text{ m}^2 \cdot \text{°C/W}$$

$$\begin{aligned} R_{23a} &= t_{23} \frac{L_a}{k_{23a}(L_a + L_b)} \\ &= (0.08 \text{ m}) \frac{0.6 \text{ m}}{(0.03 \text{ W/m} \cdot \text{°C})(0.6 + 0.005)} = 2.645 \text{ m}^2 \cdot \text{°C/W} \end{aligned}$$

$$\begin{aligned} R_{23b} &= t_{23} \frac{L_b}{k_{23b}(L_a + L_b)} \\ &= (0.08 \text{ m}) \frac{0.005 \text{ m}}{(50 \text{ W/m} \cdot \text{°C})(0.6 + 0.005)} = 1.32 \times 10^{-5} \text{ m}^2 \cdot \text{°C/W} \end{aligned}$$

$$R_{34} = \frac{t_{34}}{k_{34}} = \frac{0.1 \text{ m}}{(1.0 \text{ W/m} \cdot \text{°C})} = 0.1 \text{ m}^2 \cdot \text{°C/W}$$

The total thermal resistance and the rate of heat transfer are

$$\begin{aligned} R_{\text{total}} &= R_{12} + \left(\frac{R_{23a} R_{23b}}{R_{23a} + R_{23b}} \right) + R_{34} \\ &= 0.02 + 2.645 \left(\frac{(2.645)(1.32 \times 10^{-5})}{2.645 + 1.32 \times 10^{-5}} \right) + 0.1 = 0.120 \text{ m}^2 \cdot \text{°C/W} \end{aligned}$$

$$\dot{q} = \frac{T_4 - T_1}{R_{\text{total}}} = \frac{(35 - 20) \text{°C}}{0.120 \text{ m}^2 \cdot \text{°C/W}} = \mathbf{125 \text{ W/m}^2}$$

The temperature on the interior brick surface is

$$\dot{q} = \frac{T_4 - T_3}{R_{34}} \longrightarrow 125 \text{ W/m}^2 = \frac{(35 - T_3) \text{°C}}{0.1 \text{ m}^2 \cdot \text{°C/W}} \longrightarrow T_3 = \mathbf{22.5 \text{°C}}$$

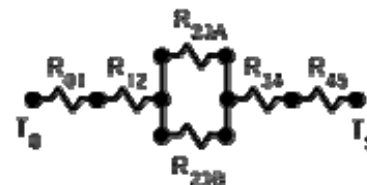
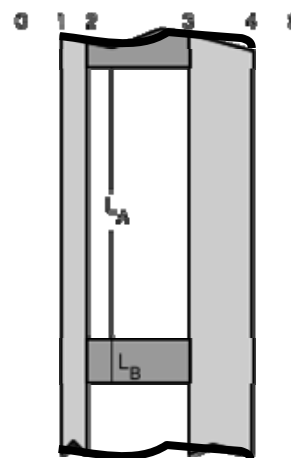

3-186 Ten rectangular aluminum fins are placed on the outside surface of an electronic device. The rate of heat loss from the electronic device to the surrounding air and the fin effectiveness are to be determined.

Assumptions **1** Steady operating conditions exist. **2** The temperature along the fins varies in one direction only (normal to the plate). **3** The heat transfer coefficient is constant and uniform over the entire fin surface. **4** The thermal properties of the fins are constant. **5** The heat transfer coefficient accounts for the effect of radiation from the fins.

Properties The thermal conductivity of the aluminum fin is given to be $k = 203 \text{ W/m}\cdot\text{K}$.

Analysis The fin efficiency is to be determined using Fig. 3-42 in the text.

$$\xi = L_c^{3/2} \sqrt{h/(kA_p)} = (L + t/2) \sqrt{h/(kt)} = (0.020 + 0.004/2) \sqrt{\frac{100}{(203)(0.004)}} = 0.244 \longrightarrow \eta_{\text{fin}} = 0.93$$

The rate of heat loss can be determined as follows

$$A_{\text{fin}} = 2 \times 10(0.020 \times 0.100 + 0.004 \times 0.020) = 0.0416 \text{ m}^2$$

$$A_{\text{base}} = 10(0.100 \times 0.004) = 0.004 \text{ m}^2$$

$$\eta_{\text{fin}} = \frac{\dot{Q}_{\text{fin}}}{\dot{Q}_{\text{fin, max}}} = \frac{\dot{Q}_{\text{fin}}}{hA_{\text{fin}}(T_b - T_\infty)} \longrightarrow 0.93 = \frac{\dot{Q}_{\text{fin}}}{(100)(0.0416)(60 - 20)} \longrightarrow \dot{Q}_{\text{fin}} = 155 \text{ W}$$

$$\dot{Q}_{\text{base}} = hA_{\text{base}}(T_b - T_\infty) = (100)(0.004)(60 - 20) = 16 \text{ W}$$

$$\dot{Q}_{\text{total}} = \dot{Q}_{\text{fin}} + \dot{Q}_{\text{base}} = 155 + 16 = \mathbf{171 \text{ W}}$$

The fin effectiveness is

$$\varepsilon_{\text{fin}} = \frac{\dot{Q}_{\text{fin}}}{\dot{Q}_{\text{no fin}}} = \frac{\dot{Q}_{\text{fin}}}{hA_{\text{base, no fin}}(T_b - T_\infty)} = \frac{171}{(100)(0.080 \times 0.100)(60 - 20)} = \mathbf{5.3}$$

3-187 One wall of a refrigerated warehouse is made of three layers. The rates of heat transfer across the warehouse without and with the metal bolts, and the percent change in the rate of heat transfer across the wall due to metal bolts are to be determined.

Assumptions 1 Steady operating conditions exist. **2** Heat transfer coefficients are constant.

Properties The thermal conductivities are given to be $k_{Al} = 200 \text{ W/m}\cdot\text{K}$, $k_{\text{fiberglass}} = 0.038 \text{ W/m}\cdot\text{K}$, $k_{\text{gypsum}} = 0.48 \text{ W/m}\cdot\text{K}$, and $k_{\text{bolts}} = 43 \text{ W/m}\cdot\text{K}$.

Analysis (a) The rate of heat transfer through the warehouse is

$$U_1 = \frac{1}{\frac{1}{h_i} + \frac{L_{Al}}{k_{Al}} + \frac{L_{fg}}{k_{fg}} + \frac{L_{gy}}{k_{gy}} + \frac{1}{h_o}}$$

$$= \frac{1}{\frac{1}{40 \text{ W/m}^2 \cdot \text{C}} + \frac{0.01 \text{ m}}{200 \text{ W/m}\cdot\text{C}} + \frac{0.08 \text{ m}}{0.038 \text{ W/m}\cdot\text{C}} + \frac{0.03 \text{ m}}{0.48 \text{ W/m}\cdot\text{C}} + \frac{1}{40 \text{ W/m}^2 \cdot \text{C}}} = 0.451 \text{ W/m}^2 \cdot \text{C}$$

$$\dot{Q}_1 = U_1 A (T_o - T_i) = (0.451 \text{ W/m}^2 \cdot \text{C})(5 \times 10 \text{ m}^2)[20 - (-10) \text{ C}] = \mathbf{676 \text{ W}}$$

(b) The rate of heat transfer with the consideration of metal bolts is

$$\dot{Q}_1 = U_1 A_1 (T_o - T_i) = (0.451) [10 \times 5 - 400 \times 0.25\pi(0.02)^2] [20 - (-10)] = 674.8 \text{ W}$$

$$U_2 = \frac{1}{\frac{1}{h_i} + \frac{L_{bolts}}{k_{bolts}} + \frac{1}{h_o}} = \frac{1}{\frac{1}{40 \text{ W/m}^2 \cdot \text{C}} + \frac{0.12 \text{ m}}{43 \text{ W/m}\cdot\text{C}} + \frac{1}{40 \text{ W/m}^2 \cdot \text{C}}} = 18.94 \text{ W/m}^2 \cdot \text{C}$$

$$\dot{Q}_2 = U_2 A_2 (T_o - T_i) = (18.94 \text{ W/m}^2 \cdot \text{C}) [400 \times 0.25\pi(0.02)^2 \text{ m}^2] [20 - (-10) \text{ C}] = 71.4 \text{ W}$$

$$\dot{Q} = \dot{Q}_1 + \dot{Q}_2 = 674.8 + 71.4 = \mathbf{746 \text{ W}}$$

(c) The percent change in the rate of heat transfer across the wall due to metal bolts is

$$\% \text{ change} = \frac{746 - 676}{676} = 0.103 = \mathbf{10.3\%}$$

3-188 An agitated vessel is used for heating an aqueous solution by saturated steam condensing in the jacket outside the vessel. The temperature of the outlet stream is to be determined.

Assumptions 1 Steady operating conditions exist. **2** Heat transfer coefficients are constant.

Properties The thermal conductivity of steel is given to be $k = 43 \text{ W/m}\cdot\text{K}$.

Analysis (a) A heat balance on the system gives

$$\dot{m}c_p(T - T_{in}) = UA(T_{\text{steam}} - T)$$

$$(500 / 60 \text{ kg/s})(4180 \text{ J/kg}\cdot\text{C})(T - 15) \text{ C} = U(12 \text{ m}^2)(115 - T)$$

where

$$U = \frac{1}{\frac{1}{h_i} + \frac{L}{k} + \frac{1}{h_o}} = \frac{1}{\frac{1}{5500 \text{ W/m}^2 \cdot \text{C}} + \frac{0.015 \text{ m}}{43 \text{ W/m}\cdot\text{C}} + \frac{1}{10,000 \text{ W/m}^2 \cdot \text{C}}} = 1585 \text{ W/m}^2 \cdot \text{C}$$

Substituting,

$$(500 / 60 \text{ kg/s})(4180 \text{ J/kg}\cdot\text{C})(T - 15) \text{ C} = (1585 \text{ W/m}^2 \cdot \text{C})(12 \text{ m}^2)(115 - T)$$

$$T = \mathbf{50.3 \text{ C}}$$

3-189 A square cross-section bar consists of a copper layer and an epoxy layer. The rates of heat transfer in different directions are to be determined.

Assumptions 1 Steady operating conditions exist. **2** Heat transfer is one-dimensional.

Properties The thermal conductivities of copper and epoxy are given to be 400 and 0.4 W/m·K, respectively.

Analysis (a) Noting that the resistances in this case are in parallel, the heat transfer from front to back is

$$R = \left[\left(\frac{kA}{L} \right)_{Cu} + \left(\frac{kA}{L} \right)_{Ep} \right]^{-1}$$

$$= \left[\left(\frac{(400 \text{ W/m} \cdot \text{K})(0.02 \times 0.01) \text{ m}^2}{0.1 \text{ m}} \right) + \left(\frac{(0.4 \text{ W/m} \cdot \text{K})(0.02 \times 0.01) \text{ m}^2}{0.1 \text{ m}} \right) \right]^{-1}$$

$$= 1.249 \text{ K/W}$$

$$\dot{Q} = \frac{\Delta T}{R} = \frac{50 \text{ K}}{1.249 \text{ K/W}} = \mathbf{40.03 \text{ W}}$$

(b) Noting that the resistances in this case are in series, the heat transfer from left to right is

$$R = R_{Cu} + R_{Ep} = \left(\frac{L}{kA} \right)_{Cu} + \left(\frac{L}{kA} \right)_{Ep}$$

$$= \left(\frac{0.01 \text{ m}}{(400 \text{ W/m} \cdot \text{K})(0.02 \times 0.1) \text{ m}^2} \right) + \left(\frac{0.01 \text{ m}}{(0.4 \text{ W/m} \cdot \text{K})(0.02 \times 0.1) \text{ m}^2} \right) = 12.50 \text{ K/W}$$

$$\dot{Q} = \frac{\Delta T}{R} = \frac{50 \text{ K}}{12.50 \text{ K/W}} = \mathbf{4.0 \text{ W}}$$

(c) Noting that the resistances in this case are in parallel, the heat transfer from top to bottom is

$$R = \left[\left(\frac{kA}{L} \right)_{Cu} + \left(\frac{kA}{L} \right)_{Ep} \right]^{-1}$$

$$= \left[\left(\frac{(400 \text{ W/m} \cdot \text{K})(0.01 \times 0.1) \text{ m}^2}{0.02 \text{ m}} \right) + \left(\frac{(0.4 \text{ W/m} \cdot \text{K})(0.01 \times 0.1) \text{ m}^2}{0.02 \text{ m}} \right) \right]^{-1} = 0.04995 \text{ K/W}$$

$$\dot{Q} = \frac{\Delta T}{R} = \frac{50 \text{ K}}{0.04995 \text{ K/W}} = \mathbf{1001 \text{ W}}$$

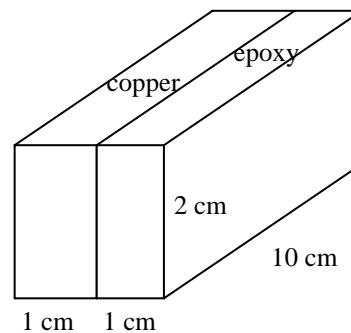

3-190 A spherical vessel is used to store a fluid. The thermal resistances, the rate of heat transfer, and the temperature difference across the insulation layer are to be determined.

Assumptions 1 Steady operating conditions exist. 2 Heat transfer is one-dimensional.

Properties The thermal conductivity of the insulation is given to be 0.20 W/m·K.

Analysis (a) The thermal resistances are

$$R_i = \frac{1}{h_i A_i} = \frac{1}{(40 \text{ W/m}^2 \cdot \text{K})\pi(3 \text{ m})^2} = \mathbf{8.84 \times 10^{-4} \text{ K/W}}$$

$$R_{ins} = \frac{r_2 - r_1}{4\pi r_1 r_2 k} = \frac{(1.55 - 1.5) \text{ m}}{4\pi(1.5 \text{ m})(1.55 \text{ m})(0.2 \text{ W/m} \cdot \text{K})} = \mathbf{8.56 \times 10^{-3} \text{ K/W}}$$

$$R_o = \frac{1}{h_o A_o} = \frac{1}{(10 \text{ W/m}^2 \cdot \text{K})\pi(3.10 \text{ m})^2} = \mathbf{3.31 \times 10^{-3} \text{ K/W}}$$

(b) The rate of heat transfer is

$$\dot{Q} = \frac{\Delta T}{R_i + R_{ins} + R_o} = \frac{(22 - 0) \text{ K}}{(8.84 \times 10^{-4} + 8.56 \times 10^{-3} + 3.31 \times 10^{-3}) \text{ K/W}} = \mathbf{1725 \text{ W}}$$

(c) The temperature difference across the insulation layer is

$$\dot{Q} = \frac{\Delta T_{ins}}{R_{ins}} \longrightarrow 1725 \text{ W} = \frac{\Delta T_{ins}}{8.56 \times 10^{-3} \text{ K/W}} \longrightarrow \Delta T_{ins} = \mathbf{14.8 \text{ K}}$$

3-191 A room is maintained at a certain temperature by a heated wall and the heating is achieved by heat flux or heat generation in the wall. The variation of temperature and heat flux across the wall in each case is to be plotted and the temperatures at the two surfaces for both cases are to be determined.

Assumptions 1 Steady operating conditions exist. 2 Heat transfer is one-dimensional.

Properties The thermal conductivity of the wall is given to be 2 W/m·K.

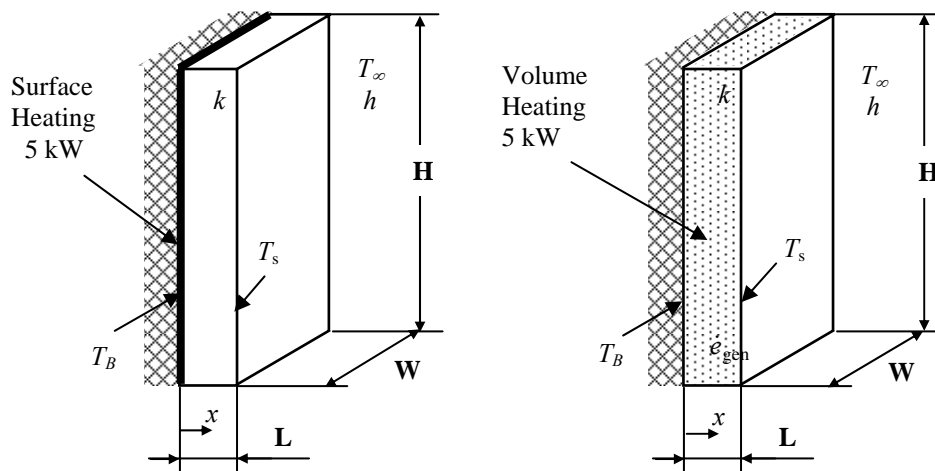

Analysis (a) The graphs show the variation of temperature and heat flux across the wall for each case:

(b) The temperature at the surface is same for both cases since energy balance does not depend on where in the wall the heat is generated. It is determined from

$$T_s = T_\infty + \frac{\dot{Q}}{Ah}$$

$$= 15^\circ\text{C} + \frac{5000 \text{ W}}{(2 \times 3 \text{ m}^2)(30 \text{ W/m}^2 \cdot ^\circ\text{C})}$$

$$= \mathbf{42.8^\circ\text{C}}$$

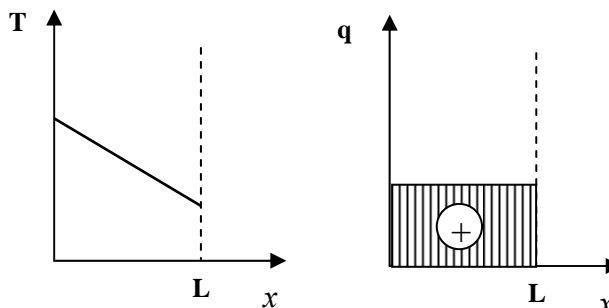

(c) The temperature at the back of the wall will be different for each case. For heat flux case, it is determined from

$$\dot{Q} = kA \frac{T_B - T_s}{L}$$

$$5000 \text{ W} = (2 \text{ W/m} \cdot ^\circ\text{C})(2 \times 3 \text{ m}^2) \frac{(T_B - 42.8)^\circ\text{C}}{0.05 \text{ m}}$$

$$T_B = \mathbf{63.6^\circ\text{C}}$$

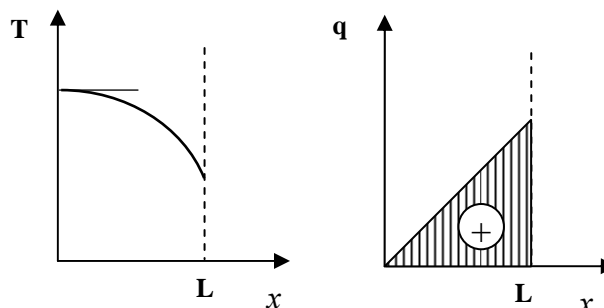

For heat generation case, the temperature is determined from Eq. 2-73 in the text

$$\dot{e}_{\text{gen}} = \frac{\dot{Q}}{V} = \frac{5000 \text{ W}}{(2 \times 3 \times 0.05) \text{ m}^3} = 16,667 \text{ W/m}^3$$

$$T_B = T_s + \frac{\dot{e}_{\text{gen}} L^2}{2k} = 42.8^\circ\text{C} + \frac{(16,667 \text{ W/m}^3)(0.05 \text{ m})^2}{2(2 \text{ W/m} \cdot ^\circ\text{C})} = \mathbf{53.2^\circ\text{C}}$$

Fundamentals of Engineering (FE) Exam Problems

3-192 A 2.5-m-high, 4-m-wide, and 20-cm-thick wall of a house has a thermal resistance of $0.0125^\circ\text{C}/\text{W}$. The thermal conductivity of the wall is

- (a) $0.72 \text{ W}/\text{m}\cdot^\circ\text{C}$ (b) $1.1 \text{ W}/\text{m}\cdot^\circ\text{C}$ (c) $1.6 \text{ W}/\text{m}\cdot^\circ\text{C}$ (d) $16 \text{ W}/\text{m}\cdot^\circ\text{C}$ (e) $32 \text{ W}/\text{m}\cdot^\circ\text{C}$

Answer (c) $1.6 \text{ W}/\text{m}\cdot^\circ\text{C}$

Solution Solved by EES Software. Solutions can be verified by copying-and-pasting the following lines on a blank EES screen.

```
Height=2.5 [m]
Width=4 [m]
L=0.20 [m]
R_wall=0.0125 [C/W]
A=Height*Width
R_wall=L/(k*A)
```

"Some Wrong Solutions with Common Mistakes"

$R_{\text{wall}}=L/W1_k$ "Not using area in the equation"

3-193 Consider two walls, A and B , with the same surface areas and the same temperature drops across their thicknesses. The ratio of thermal conductivities is $k_A/k_B = 4$ and the ratio of the wall thicknesses is $L_A/L_B = 2$. The ratio of heat transfer rates through the walls \dot{Q}_A / \dot{Q}_B is

- (a) 0.5 (b) 1 (c) 2 (d) 4 (e) 8

Answer (c) 2

Solution Solved by EES Software. Solutions can be verified by copying-and-pasting the following lines on a blank EES screen.

```
k_A\k_B=4
L_A\L_B=2
Q_dot_A\Q_dot_B=k_A\k_B*(1/L_A\L_B) "From Fourier's Law of Heat Conduction"
```

3-194 Heat is lost at a rate of 275 W per m^2 area of a 15-cm-thick wall with a thermal conductivity of $k=1.1 \text{ W/m}\cdot\text{C}$. The temperature drop across the wall is

- (a) 37.5°C (b) 27.5°C (c) 16.0°C (d) 8.0°C (e) 4.0°C

Answer (a) 37.5°C

Solution Solved by EES Software. Solutions can be verified by copying-and-pasting the following lines on a blank EES screen.

```
L=0.15 [m]
k=1.1 [W/m-C]
q=275 [W/m^2]
q=k*DELTA_T/L
```

3-195 Consider a wall that consists of two layers, *A* and *B*, with the following values: $k_A = 0.8 \text{ W/m}\cdot\text{C}$, $L_A = 8 \text{ cm}$, $k_B = 0.2 \text{ W/m}\cdot\text{C}$, $L_B = 5 \text{ cm}$. If the temperature drop across the wall is 18°C, the rate of heat transfer through the wall per unit area of the wall is

- (a) 180 W/m^2 (b) 153 W/m^2 (c) 89.6 W/m^2 (d) 72.0 W/m^2 (e) 51.4 W/m^2

Answer (e) 51.4 W/m^2

Solution Solved by EES Software. Solutions can be verified by copying-and-pasting the following lines on a blank EES screen.

```
k_A=0.8 [W/m-C]
L_A=0.08 [m]
k_B=0.2 [W/m-C]
L_B=0.05 [m]
DELTA_T=18 [C]
R_total=L_A/k_A+L_B/k_B
q_dot=DELTA_T/R_total
```

"Some Wrong Solutions with Common Mistakes"

W1_q_dot=DELTA_T/(L_A/k_A) "Considering layer A only"

W2_q_dot=DELTA_T/(L_B/k_B) "Considering layer B only"

3-196 A plane furnace surface at 150°C covered with 1-cm-thick insulation is exposed to air at 30°C, and the combined heat transfer coefficient is 25 W/m²·°C. The thermal conductivity of insulation is 0.04 W/m·°C. The rate of heat loss from the surface per unit surface area is

- (a) 35 W (b) 414 W (c) 300 W (d) 480 W (e) 128 W

Answer (b) 414 W

Solution Solved by EES Software. Solutions can be verified by copying-and-pasting the following lines on a blank EES screen.

```
Ts=150
Tinf=30
h=25
L=0.01
K=0.04
Rconv=1/h
Rins=L/K
Rtotal=Rconv+Rins
Q=(Ts-Tinf)/(Rconv+Rins)
```

"Some Wrong Solutions with Common Mistakes:"

```
W1_Q=(Ts-Tinf)/Rins "Disregarding convection"
W2_Q=(Ts-Tinf)/Rconv "Disregarding insulation"
W3_Q=(Ts-Tinf)*(Rconv+Rins) "Multiplying by resistances"
```

3-197 A room at 20°C air temperature is losing heat to the outdoor air at 0°C at a rate of 1000 W through a 2.5-m-high and 4-m-long wall. Now the wall is insulated with 2-cm-thick insulation with a conductivity of 0.02 W/m·°C. Determine the rate of heat loss from the room through this wall after insulation. Assume the heat transfer coefficients on the inner and outer surface of the wall, the room air temperature, and the outdoor air temperature to remain unchanged. Also, disregard radiation.

- (a) 20 W (b) 561 W (c) 388 W (d) 167 W (e) 200 W

Answer (d) 167 W

Solution Solved by EES Software. Solutions can be verified by copying-and-pasting the following lines on a blank EES screen.

```
Tin=20
Tout=0
Q=1000
A=2.5*4
L=0.02
k=0.02
Rins=L/(k*A)
Q=(Tin-Tout)/R
Qnew=(Tin-Tout)/(R+Rins)
```

"Some Wrong Solutions with Common Mistakes:"

```
W1_Q=(Tin-Tout)/Rins "Disregarding original resistance"
W2_Q=(Tin-Tout)*(R+L/k) "Disregarding area"
W3_Q=(Tin-Tout)*(R+Rins) "Multiplying by resistances"
```

3-198 Consider a 1.5-m-high and 2-m-wide triple pane window. The thickness of each glass layer ($k = 0.80$ W/m. $^{\circ}$ C) is 0.5 cm, and the thickness of each air space ($k = 0.025$ W/m. $^{\circ}$ C) is 1 cm. If the inner and outer surface temperatures of the window are 10 $^{\circ}$ C and 0 $^{\circ}$ C, respectively, the rate of heat loss through the window is

- (a) 75 W (b) 12 W (c) 46 W (d) 25 W (e) 37 W

Answer: (e) 37 W

Solution Solved by EES Software. Solutions can be verified by copying-and-pasting the following lines on a blank EES screen.

"Using the thermal resistances per unit area, Q can be expressed as $Q=A*\Delta T/R_{total}$ "

```
Lglass=0.005 {m}
kglass=0.80 {W/mC}
Rglass=Lglass/kglass
Lair=0.01 {m}
kair=0.025 {W/mC}
Rair=Lair/kair
A=1.5*2
T1=10
T2=0
Q=A*(T1-T2)/(3*Rglass+2*Rair)
```

"Some Wrong Solutions with Common Mistakes:"

```
W1_Q=(T1-T2)/(3*Rglass+2*Rair) "Not using area"
W2_Q=A*(T1-Tinf)*(3*Rglass+2*Rair) "Multiplying resistance instead of dividing"
W3_Q=A*(T1-T2)/(Rglass+Rair) "Using one layer only"
W4_Q=(T1-T2)/(3*Rglass+2*Rair)/A "Dividing by area instead of multiplying"
```

3-199 Consider a furnace wall made of sheet metal at an average temperature of 800 $^{\circ}$ C exposed to air at 40 $^{\circ}$ C. The combined heat transfer coefficient is 200 W/m 2 . $^{\circ}$ C inside the furnace, and 80 W/m 2 . $^{\circ}$ C outside. If the thermal resistance of the furnace wall is negligible, the rate of heat loss from the furnace per unit surface area is

- (a) 48.0 kW/m 2 (b) 213 kW/m 2 (c) 91.2 kW/m 2 (d) 151 kW/m 2 (e) 43.4 kW/m 2

Answer (e) 43.4 kW/m 2

Solution Solved by EES Software. Solutions can be verified by copying-and-pasting the following lines on a blank EES screen.

```
Ti=800
To=40
hi=200
ho=80
Rconv1=1/hi
Rconv2=1/ho
Rtotal=Rconv1+ Rconv2
Q=(Ti-To)/Rtotal
```

"Some Wrong Solutions with Common Mistakes:"

```
W1_Q=(Ti+To)/Rtotal "Adding temperatures"
W2_Q=(hi+ho)*(Ti-To) "Adding convection coefficients"
W3_Q=(hi-ho)*(Ti-To) "Subtracting convection coefficients"
```

3-200 Consider a jacket made of 5 layers of 0.1-mm-thick cotton fabric ($k = 0.060 \text{ W/m}\cdot^\circ\text{C}$) with a total of 4 layers of 1-mm-thick air space ($k = 0.026 \text{ W/m}\cdot^\circ\text{C}$) in between. Assuming the inner surface temperature of the jacket is 25°C and the surface area normal to the direction of heat transfer is 1.1 m^2 , determine the rate of heat loss through the jacket when the temperature of the outdoors is 0°C and the heat transfer coefficient on the outer surface is $18 \text{ W/m}^2\cdot^\circ\text{C}$.

- (a) 6 W (b) 115 W (c) 126 W (d) 287 W (e) 170 W

Answer (c) 126 W

Solution Solved by EES Software. Solutions can be verified by copying-and-pasting the following lines on a blank EES screen.

"Using the thermal resistance concept, Q can be expressed as $Q=A*\Delta T/R_{total}$ "

Lcotton=0.0001 {m}
kcotton=0.06 {W/mC}
Rcotton=Lcotton/kcotton

Lair=0.001 {m}
kair=0.026 {W/mC}
Rair=Lair/kair

A=1.1

h=18

Rconv=1/h

T1=25

Tinf=0

$Q=A*(T1-Tinf)/(5*Rcotton+4*Rair+Rconv)$

"Some Wrong Solutions with Common Mistakes:"

W1_Q=(T1-Tinf)/(5*Rcotton+4*Rair+Rconv) "Not using area"

W2_Q=A*(T1-Tinf)*(5*Rcotton+4*Rair+Rconv) "Multiplying resistance instead of dividing"

W3_Q=A*(T1-Tinf)/(Rcotton+Rair+Rconv) "Using one layer only"

W4_Q=A*(T1-Tinf)/(5*Rcotton+4*Rair) "Disregarding convection"

3-201 Consider two metal plates pressed against each other. Other things being equal, which of the measures below will cause the thermal contact resistance to increase?

- (a) Cleaning the surfaces to make them shinier
(b) Pressing the plates against each other with a greater force
(c) Filling the gap with a conducting fluid
(d) Using softer metals
(e) Coating the contact surfaces with a thin layer of soft metal such as tin

Answer (a) Cleaning the surfaces to make them shinier

3-202 A 10-m-long, 5-cm-outer-radius cylindrical steam pipe is covered with 3-cm thick cylindrical insulation with a thermal conductivity of 0.05 W/m·°C. If the rate of heat loss from the pipe is 1000 W, the temperature drop across the insulation is

- (a) 163°C (b) 600°C (c) 48°C (d) 79°C (e) 150°C

Answer (e) 150°C

Solution Solved by EES Software. Solutions can be verified by copying-and-pasting the following lines on a blank EES screen.

```
R1=0.05
S=0.03
R2=0.08
L=10
K=0.05
Q=1000
R=ln(r2/r1)/(2*pi*L*k)
dT=Q*R
```

"Some Wrong Solutions with Common Mistakes:"

```
W1_T=Q/k "Wrong relation"
RR1=ln(s/r1)/(2*pi*L*k)
W2_T=Q*RR1 "Wrong radius"
RR2=s/k
W3_T=Q*RR2 "Wrong radius"
```

3-203 Steam at 200°C flows in a cast iron pipe ($k = 80$ W/m·°C) whose inner and outer diameters are $D_1 = 0.20$ m and $D_2 = 0.22$ m, respectively. The pipe is covered with 2-cm-thick glass wool insulation ($k = 0.05$ W/m·°C). The heat transfer coefficient at the inner surface is 75 W/m²·°C. If the temperature at the interface of the iron pipe and the insulation is 194°C, the temperature at the outer surface of the insulation is

- (a) 32°C (b) 45°C (c) 51°C (d) 75°C (e) 100°C

Answer (b) 45°C

Solution Solved by EES Software. Solutions can be verified by copying-and-pasting the following lines on a blank EES screen.

```
T_steam=200 [C]
k_pipe=80 [W/m-C]
k_ins=0.05 [W/m-C]
D1=0.20 [m]; r1=D1/2
D2=0.22 [m]; r2=D2/2
t_ins=0.02 [m]
r3=r2+t_ins
L=1 [m] "Consider a unit length of pipe"
h1=75 [W/m^2-C]
T2=194 [C]

A1=2*pi*r1*L
R_conv1=1/(h1*A1)
R_1=ln(r2/r1)/(2*pi*k_pipe*L)
R_2=ln(r3/r2)/(2*pi*k_ins*L)
Q_dot=(T_steam-T2)/(R_conv1+R_1)
Q_dot=(T2-T3)/R_2
```

3-204 A 6-m-diameter spherical tank is filled with liquid oxygen at -184°C . The tank is thin-shelled and its temperature can be taken to be the same as the oxygen temperature. The tank is insulated with 5-cm-thick super insulation that has an effective thermal conductivity of $0.00015\text{ W/m}\cdot^{\circ}\text{C}$. The tank is exposed to ambient air at 15°C with a heat transfer coefficient of $14\text{ W/m}^2\cdot^{\circ}\text{C}$. The rate of heat transfer to the tank is
 (a) 11 W (b) 29 W (c) 57 W (d) 68 W (e) 315,000 W

Answer (d) 68 W

Solution Solved by EES Software. Solutions can be verified by copying-and-pasting the following lines on a blank EES screen.

```
D=6 [m]
L_ins=0.05 [m]
T_O2=-184 [C]
k_ins=0.00015 [W/m-C]
T_infinity=15 [C]
h=14 [W/m^2-C]

A=pi*D^2
R_ins=L_ins/(k_ins*A)
R_conv=1/(h*A)
Q_dot=(T_infinity-T_O2)/(R_ins+R_conv)
```

"Some Wrong Solutions with Common Mistakes"

```
W1_Q_dot=(T_infinity-T_O2)/R_ins "Ignoring convection resistance"
W2_Q_dot=(T_infinity-T_O2)/R_conv "Ignoring insulation resistance"
W3_Q_dot=(T_infinity+T_O2)/(R_ins+R_conv) "Adding temperatures instead of subtracting"
```

3-205 A 6-m diameter spherical tank is filled with liquid oxygen ($\rho = 1141\text{ kg/m}^3$, $c_p = 1.71\text{ kJ/kg}\cdot^{\circ}\text{C}$) at -184°C . It is observed that the temperature of oxygen increases to -183°C in a 144-hour period. The average rate of heat transfer to the tank is

(a) 249 W (b) 426 W (c) 570 W (d) 1640 W (e) 2207 W

Answer (b) 426 W

Solution Solved by EES Software. Solutions can be verified by copying-and-pasting the following lines on a blank EES screen.

```
D=6 [m]
rho=1141 [kg/m^3]
c_p=1710 [J/kg-C]
T1=-184 [C]
T2=-183 [C]
time=144*3600 [s]

V=pi*D^3/6
m=rho*V
Q=m*c_p*(T2-T1)
Q_dot=Q/time
```

"Some Wrong Solutions with Common Mistakes"

```
W1_Q_dot=Q "Using amount of heat transfer as the answer"
Q1=m*(T2-T1)
W2_Q_dot=Q1/time "Not using specific heat in the equation"
```

3-206 A hot plane surface at 100°C is exposed to air at 25°C with a combined heat transfer coefficient of $20 \text{ W/m}^2\cdot^{\circ}\text{C}$. The heat loss from the surface is to be reduced by half by covering it with sufficient insulation with a thermal conductivity of $0.10 \text{ W/m}\cdot^{\circ}\text{C}$. Assuming the heat transfer coefficient to remain constant, the required thickness of insulation is

- (a) 0.1 cm (b) 0.5 cm (c) 1.0 cm (d) 2.0 cm (e) 5 cm

Answer (b) 0.5 cm

Solution Solved by EES Software. Solutions can be verified by copying-and-pasting the following lines on a blank EES screen.

```
Ts=100
Tinf=25
h=20
k=0.1
Rconv=1/h
Rins=L/k
Rtotal=Rconv+Rins
Q1=h*(Ts-Tinf)
Q2=(Ts-Tinf)/(Rconv+Rins)
Q2=Q1/2
```

3-207 Consider a 4.5-m-long, 3.0-m-high, and 0.22-m-thick wall made of concrete ($k = 1.1 \text{ W/m}\cdot^{\circ}\text{C}$). The design temperatures of the indoor and outdoor air are 24°C and 3°C , respectively, and the heat transfer coefficients on the inner and outer surfaces are 10 and $20 \text{ W/m}^2\cdot^{\circ}\text{C}$. If a polyurethane foam insulation ($k = 0.03 \text{ W/m}\cdot^{\circ}\text{C}$) is to be placed on the inner surface of the wall to increase the inner surface temperature of the wall to 22°C , the required thickness of the insulation is

- (a) 3.3 cm (b) 3.0 cm (c) 2.7 cm (d) 2.4 cm (e) 2.1 cm

Answer (e) 2.1 cm

Solution Solved by EES Software. Solutions can be verified by copying-and-pasting the following lines on a blank EES screen.

```
Length=4.5 [m]
Height=3.0 [m]
L=0.22 [m]
T_infinity1=24 [C]
T_infinity2=3 [C]
h1=10 [W/m^2-C]
h2=20 [W/m^2-C]
k_wall=1.1 [W/m-C]
k_ins=0.03 [W/m-C]
T1=22 [C]

A=Length*Height
R_conv1=1/(h1*A)
R_wall=L/(k_wall*A)
R_conv2=1/(h2*A)
R_ins=L_ins/(k_ins*A)
Q_dot=(T_infinity1-T_infinity2)/(R_conv1+R_wall+R_ins+R_conv2)
Q_dot=(T_infinity1-T1)/R_conv1
```

3-208 Steam at 200°C flows in a cast iron pipe ($k = 80 \text{ W/m}\cdot\text{°C}$) whose inner and outer diameters are $D_1 = 0.20 \text{ m}$ and $D_2 = 0.22 \text{ m}$. The pipe is exposed to room air at 25°C. The heat transfer coefficients at the inner and outer surfaces of the pipe are 75 and $20 \text{ W/m}^2\cdot\text{°C}$, respectively. The pipe is to be covered with glass wool insulation ($k = 0.05 \text{ W/m}\cdot\text{°C}$) to decrease the heat loss from the steam by 90 percent. The required thickness of the insulation is

- (a) 1.1 cm (b) 3.4 cm (c) 5.2 cm (d) 7.9 cm (e) 14.4 cm

Answer (b) 3.4 cm

Solution Solved by EES Software. Solutions can be verified by copying-and-pasting the following lines on a blank EES screen.

T_steam=200 [C]

T_infinity=25 [C]

k_pipe=80 [W/m-C]

D1=0.20 [m]; r1=D1/2

D2=0.22 [m]; r2=D2/2

h1=75 [W/m^2-C]

h2=20 [W/m^2-C]

k_ins=0.05 [W/m-C]

f=0.90

L=1 [m] "Consider a unit length of pipe"

A1=2*pi*r1*L

R_conv1=1/(h1*A1)

R_1=ln(r2/r1)/(2*pi*k_pipe*L)

A2=2*pi*r2*L

R_conv2=1/(h2*A2)

Q_dot_old=(T_steam-T_infinity)/(R_conv1+R_1+R_conv2)

r3=r2+t_ins

R_2=ln(r3/r2)/(2*pi*k_ins*L)

A3=2*pi*r3*L

R_conv2_new=1/(h2*A3)

Q_dot_new=(1-f)*Q_dot_old

Q_dot_new=(T_steam-T_infinity)/(R_conv1+R_1+R_2+R_conv2_new)

"Some Wrong Solutions with Common Mistakes"

W1_t_ins=r3 "Using outer radius as the result"

3-209 A 50-cm-diameter spherical tank is filled with iced water at 0°C. The tank is thin-shelled and its temperature can be taken to be the same as the ice temperature. The tank is exposed to ambient air at 20°C with a heat transfer coefficient of 12 W/m²·°C. The tank is to be covered with glass wool insulation ($k = 0.05$ W/m·°C) to decrease the heat gain to the iced water by 90 percent. The required thickness of the insulation is

- (a) 4.6 cm (b) 6.7 cm (c) 8.3 cm (d) 25.0 cm (e) 29.6 cm

Answer (a) 4.6 cm

Solution Solved by EES Software. Solutions can be verified by copying-and-pasting the following lines on a blank EES screen.

```
T_ice=0 [C]
T_infinity=20 [C]
D1=0.50 [m]
r1=D1/2
h=12 [W/m^2-C]
k_ins=0.05 [W/m-C]
f=0.90
```

```
A=pi*D1^2
Q_dot_old=h*A*(T_infinity-T_ice)
r2=r1+t_ins
R_ins=(r2-r1)/(4*pi*r1*r2*k_ins)
D2=2*r2
A2=pi*D2^2
R_conv=1/(h*A2)
Q_dot_new=(1-f)*Q_dot_old
Q_dot_new=(T_infinity-T_ice)/(R_ins+R_conv)
```

"Some Wrong Solutions with Common Mistakes"

```
W1_t_ins=r2 "Using outer radius as the result"
```

3-210 Heat is generated steadily in a 3-cm-diameter spherical ball. The ball is exposed to ambient air at 26°C with a heat transfer coefficient of 7.5 W/m²·°C. The ball is to be covered with a material of thermal conductivity 0.15 W/m·°C. The thickness of the covering material that will maximize heat generation within the ball while maintaining ball surface temperature constant is

- (a) 0.5 cm (b) 1.0 cm (c) 1.5 cm (d) 2.0 cm (e) 2.5 cm

Answer (e) 2.5 cm

Solution Solved by EES Software. Solutions can be verified by copying-and-pasting the following lines on a blank EES screen.

$$D=0.03 \text{ [m]}$$

$$r=D/2$$

$$T_{\infty}=26 \text{ [C]}$$

$$h=7.5 \text{ [W/m}^2\text{-C]}$$

$$k=0.15 \text{ [W/m-C]}$$

$$r_{cr}=(2*k)/h \quad r_{cr}=(2*k)/h \text{ "critical radius of insulation for a sphere"}$$

$$\text{thickness}=r_{cr}-r$$

"Some Wrong Solutions with Common Mistakes"

$$W_{r_{cr}}=k/h$$

$$W1_{\text{thickness}}=W_{r_{cr}}-r \text{ "Using the equation for cylinder"}$$

3-211 A 1-cm-diameter, 30-cm long fin made of aluminum ($k = 237 \text{ W/m}\cdot\text{°C}$) is attached to a surface at 80°C. The surface is exposed to ambient air at 22°C with a heat transfer coefficient of 11 W/m²·°C. If the fin can be assumed to be very long, the rate of heat transfer from the fin is

- (a) 2.2 W (b) 3.0 W (c) 3.7 W (d) 4.0 W (e) 4.7 W

Answer (e) 4.7 W

Solution Solved by EES Software. Solutions can be verified by copying-and-pasting the following lines on a blank EES screen.

$$D=0.01 \text{ [m]}$$

$$L=0.30 \text{ [m]}$$

$$k=237 \text{ [W/m-C]}$$

$$T_b=80 \text{ [C]}$$

$$T_{\infty}=22 \text{ [C]}$$

$$h=11 \text{ [W/m}^2\text{-C]}$$

$$p=\pi*D$$

$$A_c=\pi*D^2/4$$

$$Q_{dot}=\text{sqrt}(h*p*k*A_c)*(T_b-T_{\infty})$$

"Some Wrong Solutions with Common Mistakes"

$$a=\text{sqrt}((h*p)/(k*A_c))$$

$$W1_{Q_{dot}}=\text{sqrt}(h*p*k*A_c)*(T_b-T_{\infty})*\text{tanh}(a*L) \text{ "Using the relation for insulated fin tip"}$$

3-212 A 1-cm-diameter, 30-cm-long fin made of aluminum ($k = 237 \text{ W/m}\cdot\text{C}$) is attached to a surface at 80°C . The surface is exposed to ambient air at 22°C with a heat transfer coefficient of $11 \text{ W/m}^2\cdot\text{C}$. If the fin can be assumed to be very long, its efficiency is

- (a) 0.60 (b) 0.67 (c) 0.72 (d) 0.77 (e) 0.88

Answer (d) 0.77

Solution Solved by EES Software. Solutions can be verified by copying-and-pasting the following lines on a blank EES screen.

```
D=0.01 [m]
L=0.30 [m]
k=237 [W/m-C]
T_b=80 [C]
T_infinity=22 [C]
h=11 [W/m^2-C]
p=pi*D
A_c=pi*D^2/4
a=sqrt((h*p)/(k*A_c))
eta_fin=1/(a*L)
```

"Some Wrong Solutions with Common Mistakes"

W1_eta_fin=tanh(a*L)/(a*L) "Using the relation for insulated fin tip"

3-213 A hot surface at 80°C in air at 20°C is to be cooled by attaching 10-cm-long and 1-cm-diameter cylindrical fins. The combined heat transfer coefficient is $30 \text{ W/m}^2\cdot\text{C}$, and heat transfer from the fin tip is negligible. If the fin efficiency is 0.75, the rate of heat loss from 100 fins is

- (a) 325 W (b) 707 W (c) 566 W (d) 424 W (e) 754 W

Answer (d) 424 W

Solution Solved by EES Software. Solutions can be verified by copying-and-pasting the following lines on a blank EES screen.

```
N=100
Ts=80
Tinf=20
L=0.1
D=0.01
h=30
Eff=0.75
A=N*pi*D*L
Q=Eff*h*A*(Ts-Tinf)
```

"Some Wrong Solutions with Common Mistakes:"

W1_Q= h*A*(Ts-Tinf) "Using Qmax"

W2_Q= h*A*(Ts-Tinf)/Eff "Dividing by fin efficiency"

W3_Q= Eff*h*A*(Ts+Tinf) "Adding temperatures"

W4_Q= Eff*h*(pi*D^2/4)*L*N*(Ts-Tinf) "Wrong area"

3-214 A cylindrical pin fin of diameter 1 cm and length 5 cm with negligible heat loss from the tip has an effectiveness of 15. If the fin base temperature is 280°C, the environment temperature is 20°C, and the heat transfer coefficient is 85 W/m²·°C, the rate of heat loss from this fin is

- (a) 2 W (b) 188 W (c) 26 W (d) 521 W (e) 547 W

Answer (c) 26 W

Solution Solved by EES Software. Solutions can be verified by copying-and-pasting the following lines on a blank EES screen.

"The relation between for heat transfer from a fin is $Q = h \cdot A_{\text{base}} \cdot (T_b - T_{\text{inf}}) \cdot \text{Effectiveness}$ "

D=0.01 {m}

L=0.05 {m}

Tb=280

Tinf=20

h=85

Effect=15

$Q = h \cdot (\pi \cdot D^2 / 4) \cdot (T_b - T_{\text{inf}}) \cdot \text{Effect}$

"Some Wrong Solutions with Common Mistakes:"

W1_Q= h*(pi*D*L)*(Tb-Tinf)*Effect "Using fin area "

W2_Q= h*(pi*D^2/4)*(Tb-Tinf) "Not using effectiveness"

W3_Q= Q+W1_Q "Using wrong relation"

3-215 A cylindrical pin fin of diameter 0.6 cm and length of 3 cm with negligible heat loss from the tip has an efficiency of 0.7. The effectiveness of this fin is

- (a) 0.3 (b) 0.7 (c) 2 (d) 8 (e) 14

Answer (e) 14

Solution Solved by EES Software. Solutions can be verified by copying-and-pasting the following lines on a blank EES screen.

"The relation between fin efficiency and fin effectiveness is $\text{effect} = (A_{\text{fin}} / A_{\text{base}}) \cdot \text{Efficiency}$ "

D=0.6 {cm}

L=3 {cm}

Effici=0.7

$\text{Effect} = (\pi \cdot D \cdot L) / (\pi \cdot D^2 / 4) \cdot \text{Effici}$

"Some Wrong Solutions with Common Mistakes:"

W1_Effect= Effici "Taking it equal to efficiency"

W2_Effect= (D/L)*Effici "Using wrong ratio"

W3_Effect= 1-Effici "Using wrong relation"

W4_Effect= (pi*D*L/(pi*D))*Effici "Using area over perimeter"

- 3-216** A 3-cm-long, 2 mm \times 2 mm rectangular cross-section aluminum fin ($k = 237 \text{ W/m}\cdot\text{C}$) is attached to a surface. If the fin efficiency is 65 percent, the effectiveness of this single fin is
 (a) 39 (b) 30 (c) 24 (d) 18 (e) 7

Answer (a) 39

Solution Solved by EES Software. Solutions can be verified by copying-and-pasting the following lines on a blank EES screen.

```
L=0.03 [m]
s=0.002 [m]
k=237 [W/m-C]
eta_fin=0.65
A_fin=4*s*L
A_b=s*s
epsilon_fin=A_fin/A_b*eta_fin
```

- 3-217** Aluminum square pin fins ($k = 237 \text{ W/m}\cdot\text{C}$) of 3-cm-long, 2 mm \times 2 mm cross-section with a total number of 150 are attached to an 8-cm-long, 6-cm-wide surface. If the fin efficiency is 65 percent, the overall fin effectiveness for the surface is
 (a) 1.03 (b) 2.30 (c) 5.75 (d) 8.38 (e) 12.6

Answer (c) 5.75

Solution Solved by EES Software. Solutions can be verified by copying-and-pasting the following lines on a blank EES screen.

```
s=0.002 [m]
L=0.03 [m]
k=237 [W/m-C]
n_fin=150
Length=0.08 [m]
Width=0.06 [m]
eta_fin=0.65

A_fin=n_fin*4*s*L
A_nofin=Length*Width
A_unfin=A_nofin-n_fin*s*s
epsilon_fin_overall=(A_unfin+eta_fin*A_fin)/A_nofin
```

"Some Wrong Solutions with Common Mistakes"

W1_epsilon_fin_overall=(A_unfin+A_fin)/A_nofin "Ignoring fin efficiency"

A_fin1=4*s*L

A_nofin1=Length*Width

A_unfin1=A_nofin1-s*s

W2_epsilon_fin_overall=(A_unfin1+eta_fin*A_fin1)/A_nofin1 "Considering a single fin in calculations"

3-218 Two finned surfaces with long fins are identical, except that the convection heat transfer coefficient for the first finned surface is twice that of the second one. What statement below is accurate for the efficiency and effectiveness of the first finned surface relative to the second one?

- (a) higher efficiency and higher effectiveness
- (b) higher efficiency but lower effectiveness
- (c) lower efficiency but higher effectiveness
- (d) lower efficiency and lower effectiveness
- (e) equal efficiency and equal effectiveness

Answer (d) lower efficiency and lower effectiveness

Solution The efficiency of long fin is given by $\eta = \sqrt{kA_c / hp} / L$, which is inversely proportional to convection coefficient h . Therefore, efficiency of first finned surface with higher h will be lower. This is also the case for effectiveness since effectiveness is proportional to efficiency, $\varepsilon = \eta(A_{fin} / A_{base})$.

3-219 A 20-cm-diameter hot sphere at 120°C is buried in the ground with a thermal conductivity of 1.2 W/m·°C. The distance between the center of the sphere and the ground surface is 0.8 m, and the ground surface temperature is 15°C. The rate of heat loss from the sphere is

- (a) 169 W
- (b) 20 W
- (c) 217 W
- (d) 312 W
- (e) 1.8 W

Answer (a) 169 W

Solution Solved by EES Software. Solutions can be verified by copying-and-pasting the following lines on a blank EES screen.

```
D=0.2
T1=120
T2=15
K=1.2
Z=0.8
S=2*pi*D/(1-0.25*D/z)
Q=S*k*(T1-T2)
```

"Some Wrong Solutions with Common Mistakes:"

```
A=pi*D^2
W1_Q=2*pi*z/ln(4*z/D) "Using the relation for cylinder"
W2_Q=k*A*(T1-T2)/z "Using wrong relation"
W3_Q= S*k*(T1+T2) "Adding temperatures"
W4_Q= S*k*A*(T1-T2) "Multiplying by area also"
```

3-220 A 25-cm-diameter, 2.4-m-long vertical cylinder containing ice at 0°C is buried right under the ground. The cylinder is thin-shelled and is made of a high thermal conductivity material. The surface temperature and the thermal conductivity of the ground are 18°C and 0.85 W/m·°C, respectively. The rate of heat transfer to the cylinder is

- (a) 37.2 W (b) 63.2 W (c) 158 W (d) 480 W (e) 1210 W

Answer (b) 63.2 W

Solution Solved by EES Software. Solutions can be verified by copying-and-pasting the following lines on a blank EES screen.

```
D=0.25 [m]
L=2.4 [m]
T_ice=0 [C]
T_ground=18 [C]
k=0.85 [W/m-C]

S=(2*pi*L)/ln((4*L)/D)
Q_dot=S*k*(T_ground-T_ice)
```

3-221 Hot water ($c = 4.179$ kJ/kg·K) flows through a 200 m long PVC ($k = 0.092$ W/m·K) pipe whose inner diameter D is 2 cm and outer diameter is 2.5 cm at a rate of 1 kg/s, entering at 40°C. If the entire interior surface of this pipe is maintained at 35°C and the entire exterior surface at 20°C, the outlet temperature of water is

- (a) 39°C (b) 38°C (c) 37°C (d) 36°C (e) 35°C

Answer (b) 38°C

Solution Solved by EES Software. Solutions can be verified by copying-and-pasting the following lines on a blank EES screen.

```
do=2.5 [cm]
di=2.0 [cm]
k=0.092 [W/m-C]
T2=35 [C]
T1=20 [C]
Q=2*pi*k*l*(T2-T1)/LN(do/di)
Tin=40 [C]
c=4179 [J/kg-K]
m=1 [kg/s]
l=200 [m]
Q=m*c*(Tin-Tout)
```

3-222 Heat transfer rate through the wall of a circular tube with convection acting on the outer surface is

given per unit of its length by $\dot{q} = \frac{2\pi L(T_i - T_o)}{\frac{\ln(r_o/r_i)}{k} + \frac{1}{r_o h}}$ where i refers to the inner tube surface and o the outer

tube surface. Increasing r_o will reduce the heat transfer as long as

- (a) $r_o < k/h$ (b) $r_o = k/h$ (c) $r_o > k/h$ (d) $r_o > 2k/h$
 (e) increasing r_o will always reduce the heat transfer

Answer (c) $r_o > k/h$

3-223 The walls of a food storage facility are made of a 2-cm-thick layer of wood ($k = 0.1$ W/m·K) in contact with a 5-cm-thick layer of polyurethane foam ($k = 0.03$ W/m·K). If the temperature of the surface of the wood is -10°C and the temperature of the surface of the polyurethane foam is 20°C , the temperature of the surface where the two layers are in contact is

- (a) -7°C (b) -2°C (c) 3°C (d) 8°C (e) 11°C

Answer (a) -7°C

Solution Solved by EES Software. Solutions can be verified by copying-and-pasting the following lines on a blank EES screen.

```
kw=0.1 [W/m-C]
tkw=0.02 [m]
Tw=-10 [C]
kf=0.03 [W/m-C]
tkf=0.05 [W/m-C]
Tf=20 [C]
T=((kw*Tw/tkw)+(kf*Tf/tkf))/((kw/tkw)+(kf/tkf))
```

3-224 A typical section of a building wall is shown in the figure. This section extends in and out of the page and is repeated in the vertical direction. The correct thermal resistance circuit for this wall is

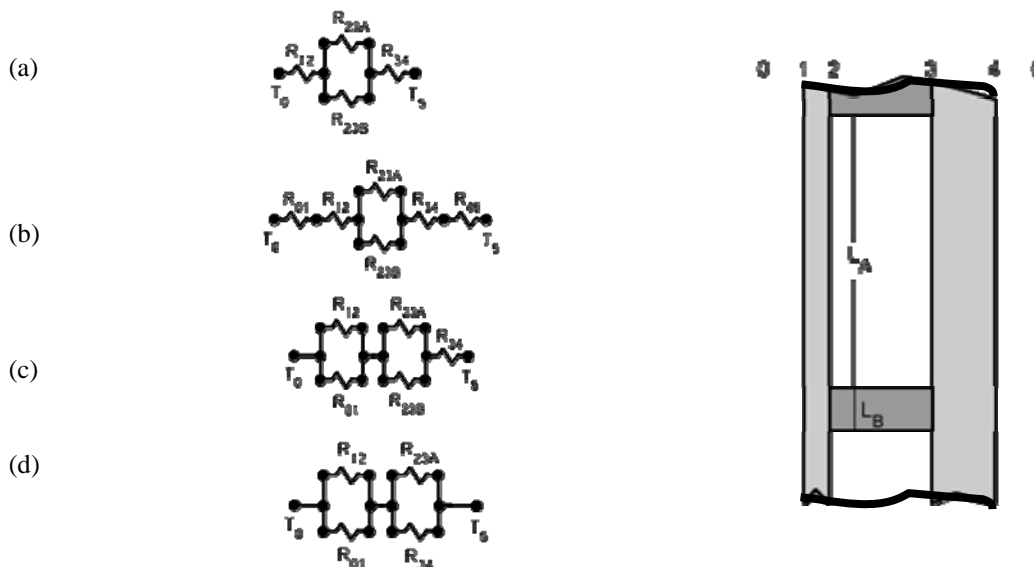

Answer (b)

3-225 The 700 m^2 ceiling of a building has a thermal resistance of $0.2 \text{ m}^2 \cdot \text{K}/\text{W}$. The rate at which heat is lost through this ceiling on a cold winter day when the ambient temperature is -10°C and the interior is at 20°C is

- (a) 56 MW (b) 72 MW (c) 87 MW (d) 105 MW (e) 118 MW

Answer (d) 105 MW

Solution Solved by EES Software. Solutions can be verified by copying-and-pasting the following lines on a blank EES screen.

```
R=0.2 [m^2-C/W]
A=700 [m^2]
T_1=20 [C]
T_2=-10 [C]
Q=A*(T_2-T_1)/R
```

3-226 A 1 m-inner diameter liquid oxygen storage tank at a hospital keeps the liquid oxygen at 90 K. This tank consists of a 0.5-cm thick aluminum ($k = 170 \text{ W/m}\cdot\text{K}$) shell whose exterior is covered with a 10-cm-thick layer of insulation ($k = 0.02 \text{ W/m}\cdot\text{K}$). The insulation is exposed to the ambient air at 20°C and the heat transfer coefficient on the exterior side of the insulation is $5 \text{ W/m}^2\cdot\text{K}$. The rate at which the liquid oxygen gains heat is

- (a) 141 W (b) 176 W (c) 181 W (d) 201 W (e) 221 W

Answer (b) 176 W

Solution Solved by EES Software. Solutions can be verified by copying-and-pasting the following lines on a blank EES screen.

```
R1=0.5 [m]
R2=0.55 [m]
R3=0.65 [m]
k1=170 [W/m-K]
k2=0.02 [W/m-K]
h=5[W/m^2-K]
T2=293 [K]
T1=90 [K]
R12=(R2-R1)/(4*pi*k1*R1*R2)
R23=(R3-R2)/(4*pi*k2*R2*R3)
R45=1/(h*4*pi*R3^2)
Re=R12+R23+R45
Q=(T2-T1)/Re
```

3-227 A 1-m-inner diameter liquid oxygen storage tank at a hospital keeps the liquid oxygen at 90 K. This tank consists of a 0.5-cm-thick aluminum ($k = 170 \text{ W/m}\cdot\text{K}$) shell whose exterior is covered with a 10-cm-thick layer of insulation ($k = 0.02 \text{ W/m}\cdot\text{K}$). The insulation is exposed to the ambient air at 20°C and the heat transfer coefficient on the exterior side of the insulation is $5 \text{ W/m}^2\cdot\text{K}$. The temperature of the exterior surface of the insulation is

- (a) 13°C (b) 9°C (c) 2°C (d) -3°C (e) -12°C

Answer (a) 13°C

Solution Solved by EES Software. Solutions can be verified by copying-and-pasting the following lines on a blank EES screen.

```
R1=0.5 [m]
R2=0.55 [m]
R3=0.65 [m]
k1=170 [W/m-K]
k2=0.02 [W/m-K]
h=5[W/m^2-K]
T2=293 [K]
T1=90 [K]
R12=(R2-R1)/(4*pi*k1*R1*R2)
R23=(R3-R2)/(4*pi*k2*R2*R3)
R45=1/(h*4*pi*R3^2)
Re=R12+R23+R45
Q=(T2-T1)/Re
Q=(T2-T3)/R45
```

3-228 The fin efficiency is defined as the ratio of the actual heat transfer from the fin to

- (a) The heat transfer from the same fin with an adiabatic tip
- (b) The heat transfer from an equivalent fin which is infinitely long
- (c) The heat transfer from the same fin if the temperature along the entire length of the fin is the same as the base temperature
- (d) The heat transfer through the base area of the same fin
- (e) None of the above

Answer: (c)

3-229 Computer memory chips are mounted on a finned metallic mount to protect them from overheating. A 512 MB memory chip dissipates 5 W of heat to air at 25°C. If the temperature of this chip is not exceed 50°C, the overall heat transfer coefficient – area product of the finned metal mount must be at least

- (a) 0.2 W/°C
- (b) 0.3 W/°C
- (c) 0.4 W/°C
- (d) 0.5 W/°C
- (e) 0.6 W/°C

Answer (a) 0.2 W/°C

Solution Solved by EES Software. Solutions can be verified by copying-and-pasting the following lines on a blank EES screen.

```
T_1=50 [C]
T_2=25 [C]
Q=5 [W]
Q=UA*(T_1-T_2)
```

3-230 In the United States, building insulation is specified by the R-value (thermal resistance in h·ft²·°F/Btu units). A home owner decides to save on the cost of heating the home by adding additional insulation in the attic. If the total R-value is increased from 15 to 25, the home owner can expect the heat loss through the ceiling to be reduced by

- (a) 25%
- (b) 40%
- (c) 50%
- (d) 60%
- (e) 75%

Answer (b) 40%

Solution Solved by EES Software. Solutions can be verified by copying-and-pasting the following lines on a blank EES screen.

```
R_1=15
R_2=25
DeltaT=1 "Any value can be chosen"
Q1=DeltaT/R_1
Q2=DeltaT/R_2
Reduction%=100*(Q1-Q2)/Q1
```

3-231 Coffee houses frequently serve coffee in a paper cup that has a corrugated paper jacket surrounding the cup like that shown here. This corrugated jacket

- (a) serves to keep the coffee hot
- (b) increases the coffee-to-surrounding thermal resistance
- (c) lowers the temperature where the hand clasps the cup
- (d) all of the above
- (e) none of the above

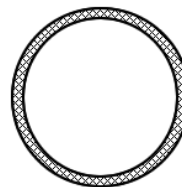

Answer (d) all of the above

3-232 A triangular shaped fin on a motorcycle engine is 0.5-cm thick at its base and 3-cm long (normal distance between the base and the tip of the triangle), and is made of aluminum ($k = 150 \text{ W/m}\cdot\text{K}$). This fin is exposed to air with a convective heat transfer coefficient of $30 \text{ W/m}^2\cdot\text{K}$ acting on its surfaces. The efficiency of the fin is 50 percent. If the fin base temperature is 130°C and the air temperature is 25°C , the heat transfer from this fin per unit width is

- (a) 32 W/m
- (b) 47 W/m
- (c) 68 W/m
- (d) 82 W/m
- (e) 95 W/m

Answer (e) 95 W/m

Solution Solved by EES Software. Solutions can be verified by copying-and-pasting the following lines on a blank EES screen.

```

h=30 [W/m-K]
b=0.005 [m]
l=0.03 [m]
eff=0.5
Ta=25 [C]
Tb=130 [C]
A=2*(l^2+(b/2)^2)^0.5
Qideal=h*A*(Tb-Ta)
Q=eff*Qideal

```

3-233 A plane brick wall ($k = 0.7 \text{ W/m}\cdot\text{K}$) is 10 cm thick. The thermal resistance of this wall per unit of wall area is

- (a) $0.143 \text{ m}^2\cdot\text{K/W}$
- (b) $0.250 \text{ m}^2\cdot\text{K/W}$
- (c) $0.327 \text{ m}^2\cdot\text{K/W}$
- (d) $0.448 \text{ m}^2\cdot\text{K/W}$
- (e) $0.524 \text{ m}^2\cdot\text{K/W}$

Answer (a) $0.143 \text{ m}^2\cdot\text{K/W}$

Solution Solved by EES Software. Solutions can be verified by copying-and-pasting the following lines on a blank EES screen.

```

k=0.7 [W/m-K]
t=0.1 [m]
R=t/k

```

3-234 The equivalent thermal resistance for the thermal circuit shown here is

- (a) $R_{12}R_{01} + R_{23A}R_{23B} + R_{34}$
- (b) $R_{12}R_{01} + \left(\frac{R_{23A}R_{23B}}{R_{23A} + R_{23B}} \right) + R_{34}$
- (c) $\left(\frac{R_{12}R_{01}}{R_{12} + R_{01}} \right) + \left(\frac{R_{23A}R_{23B}}{R_{23A} + R_{23B}} \right) + \frac{1}{R_{34}}$
- (d) $\left(\frac{R_{12}R_{01}}{R_{12} + R_{01}} \right) + \left(\frac{R_{23A}R_{23B}}{R_{23A} + R_{23B}} \right) + R_{34}$
- (e) None of them

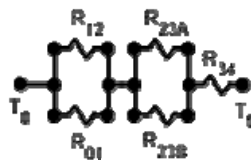

Answer (d)

3-235 ... 3-241 Design and Essay Problems



Chapter 4

TRANSIENT HEAT CONDUCTION

Lumped System Analysis

4-1C In heat transfer analysis, some bodies are observed to behave like a "lump" whose entire body temperature remains essentially uniform at all times during a heat transfer process. The temperature of such bodies can be taken to be a function of time only. Heat transfer analysis which utilizes this idealization is known as the lumped system analysis. It is applicable when the Biot number (the ratio of conduction resistance within the body to convection resistance at the surface of the body) is less than or equal to 0.1.

4-2C The lumped system analysis is more likely to be applicable for the body cooled naturally since the Biot number is proportional to the convection heat transfer coefficient, which is proportional to the air velocity. Therefore, the Biot number is more likely to be less than 0.1 for the case of natural convection.

4-3C The lumped system analysis is more likely to be applicable for the body allowed to cool in the air since the Biot number is proportional to the convection heat transfer coefficient, which is larger in water than it is in air because of the larger thermal conductivity of water. Therefore, the Biot number is more likely to be less than 0.1 for the case of the solid cooled in the air

4-4C The temperature drop of the potato during the second minute will be less than 4°C since the temperature of a body approaches the temperature of the surrounding medium asymptotically, and thus it changes rapidly at the beginning, but slowly later on.

4-5C The temperature rise of the potato during the second minute will be less than 5°C since the temperature of a body approaches the temperature of the surrounding medium asymptotically, and thus it changes rapidly at the beginning, but slowly later on.

4-6C Biot number represents the ratio of conduction resistance within the body to convection resistance at the surface of the body. The Biot number is more likely to be larger for poorly conducting solids since such bodies have larger resistances against heat conduction.

4-7C The heat transfer is proportional to the surface area. Two half pieces of the roast have a much larger surface area than the single piece and thus a higher rate of heat transfer. As a result, the two half pieces will cook much faster than the single large piece.

4-8C The cylinder will cool faster than the sphere since heat transfer rate is proportional to the surface area, and the sphere has the smallest area for a given volume.

4-9C The lumped system analysis is more likely to be applicable in air than in water since the convection heat transfer coefficient and thus the Biot number is much smaller in air.

4-10C The lumped system analysis is more likely to be applicable for a golden apple than for an actual apple since the thermal conductivity is much larger and thus the Biot number is much smaller for gold.

4-11C The lumped system analysis is more likely to be applicable to slender bodies than the well-rounded bodies since the characteristic length (ratio of volume to surface area) and thus the Biot number is much smaller for slender bodies.

4-12 Relations are to be obtained for the characteristic lengths of a large plane wall of thickness $2L$, a very long cylinder of radius r_o and a sphere of radius r_o .

Analysis Relations for the characteristic lengths of a large plane wall of thickness $2L$, a very long cylinder of radius r_o and a sphere of radius r_o are

$$L_{c,wall} = \frac{V}{A_{\text{surface}}} = \frac{2LA}{2A} = L$$

$$L_{c,cylinder} = \frac{V}{A_{\text{surface}}} = \frac{\pi r_o^2 h}{2\pi r_o h} = \frac{r_o}{2}$$

$$L_{c,sphere} = \frac{V}{A_{\text{surface}}} = \frac{4\pi r_o^3 / 3}{4\pi r_o^2} = \frac{r_o}{3}$$

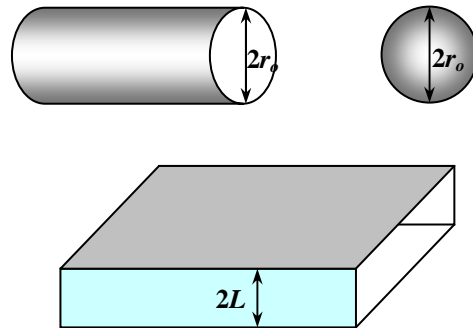

4-13 A relation for the time period for a lumped system to reach the average temperature $(T_i + T_\infty)/2$ is to be obtained.

Analysis The relation for time period for a lumped system to reach the average temperature $(T_i + T_\infty)/2$ can be determined as

$$\frac{T(t) - T_\infty}{T_i - T_\infty} = e^{-bt} \longrightarrow \frac{\frac{T_i + T_\infty}{2} - T_\infty}{T_i - T_\infty} = e^{-bt}$$

$$\frac{T_i - T_\infty}{2(T_i - T_\infty)} = e^{-bt} \longrightarrow \frac{1}{2} = e^{-bt}$$

$$-bt = -\ln 2 \longrightarrow t = \frac{\ln 2}{b} = \frac{0.693}{b}$$

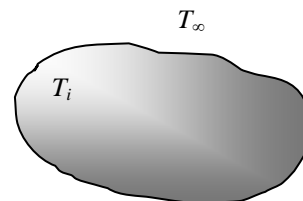

4-14 The temperature of a gas stream is to be measured by a thermocouple. The time it takes to register 99 percent of the initial ΔT is to be determined.

Assumptions **1** The junction is spherical in shape with a diameter of $D = 0.0012$ m. **2** The thermal properties of the junction are constant. **3** The heat transfer coefficient is constant and uniform over the entire surface. **4** Radiation effects are negligible. **5** The Biot number is $Bi < 0.1$ so that the lumped system analysis is applicable (this assumption will be verified).

Properties The properties of the junction are given to be $k = 35$ W/m \cdot °C, $\rho = 8500$ kg/m 3 , and $c_p = 320$ J/kg \cdot °C.

Analysis The characteristic length of the junction and the Biot number are

$$L_c = \frac{V}{A_{\text{surface}}} = \frac{\pi D^3 / 6}{\pi D^2} = \frac{D}{6} = \frac{0.0012 \text{ m}}{6} = 0.0002 \text{ m}$$

$$Bi = \frac{hL_c}{k} = \frac{(90 \text{ W/m}^2 \cdot \text{°C})(0.0002 \text{ m})}{(35 \text{ W/m} \cdot \text{°C})} = 0.00051 < 0.1$$

Since $Bi < 0.1$, the lumped system analysis is applicable. Then the time period for the thermocouple to read 99% of the initial temperature difference is determined from

$$\frac{T(t) - T_\infty}{T_i - T_\infty} = 0.01$$

$$b = \frac{hA}{\rho c_p V} = \frac{h}{\rho c_p L_c} = \frac{90 \text{ W/m}^2 \cdot \text{°C}}{(8500 \text{ kg/m}^3)(320 \text{ J/kg} \cdot \text{°C})(0.0002 \text{ m})} = 0.1654 \text{ s}^{-1}$$

$$\frac{T(t) - T_\infty}{T_i - T_\infty} = e^{-bt} \longrightarrow 0.01 = e^{-(0.1654 \text{ s}^{-1})t} \longrightarrow t = \mathbf{27.8 \text{ s}}$$

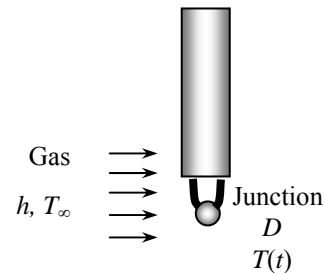

4-15E A number of brass balls are to be quenched in a water bath at a specified rate. The temperature of the balls after quenching and the rate at which heat needs to be removed from the water in order to keep its temperature constant are to be determined.

Assumptions 1 The balls are spherical in shape with a radius of $r_o = 1$ in. **2** The thermal properties of the balls are constant. **3** The heat transfer coefficient is constant and uniform over the entire surface. **4** The Biot number is $Bi < 0.1$ so that the lumped system analysis is applicable (this assumption will be verified).

Properties The thermal conductivity, density, and specific heat of the brass balls are given to be $k = 64.1$ Btu/h.ft.°F, $\rho = 532$ lbm/ft³, and $c_p = 0.092$ Btu/lbm.°F.

Analysis (a) The characteristic length and the Biot number for the brass balls are

$$L_c = \frac{\mathcal{V}}{A_s} = \frac{\pi D^3 / 6}{\pi D^2} = \frac{D}{6} = \frac{2 / 12 \text{ ft}}{6} = 0.02778 \text{ ft}$$

$$Bi = \frac{hL_c}{k} = \frac{(42 \text{ Btu/h.ft}^2 \cdot \text{°F})(0.02778 \text{ ft})}{(64.1 \text{ Btu/h.ft.} \cdot \text{°F})} = 0.01820 < 0.1$$

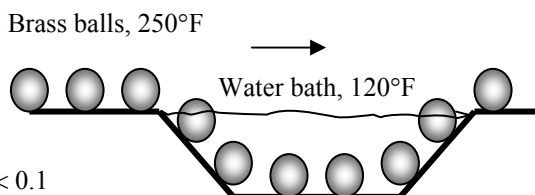

The lumped system analysis is applicable since $Bi < 0.1$. Then the temperature of the balls after quenching becomes

$$b = \frac{hA_s}{\rho c_p \mathcal{V}} = \frac{h}{\rho c_p L_c} = \frac{42 \text{ Btu/h.ft}^2 \cdot \text{°F}}{(532 \text{ lbm/ft}^3)(0.092 \text{ Btu/lbm.} \cdot \text{°F})(0.02778 \text{ ft})} = 30.9 \text{ h}^{-1} = 0.00858 \text{ s}^{-1}$$

$$\frac{T(t) - T_\infty}{T_i - T_\infty} = e^{-bt} \longrightarrow \frac{T(t) - 120}{250 - 120} = e^{-(0.00858 \text{ s}^{-1})(120 \text{ s})} \longrightarrow T(t) = \mathbf{166 \text{ °F}}$$

(b) The total amount of heat transfer from a ball during a 2-minute period is

$$m = \rho \mathcal{V} = \rho \frac{\pi D^3}{6} = (532 \text{ lbm/ft}^3) \frac{\pi (2 / 12 \text{ ft})^3}{6} = 1.290 \text{ lbm}$$

$$Q = mc_p [T_i - T(t)] = (1.29 \text{ lbm})(0.092 \text{ Btu/lbm.} \cdot \text{°F})(250 - 166) \text{ °F} = 9.97 \text{ Btu}$$

Then the rate of heat transfer from the balls to the water becomes

$$\dot{Q}_{total} = \dot{n}_{ball} Q_{ball} = (120 \text{ balls/min}) \times (9.97 \text{ Btu}) = \mathbf{1196 \text{ Btu/min}}$$

Therefore, heat must be removed from the water at a rate of 1196 Btu/min in order to keep its temperature constant at 120°F.

4-16E A number of aluminum balls are to be quenched in a water bath at a specified rate. The temperature of balls after quenching and the rate at which heat needs to be removed from the water in order to keep its temperature constant are to be determined.

Assumptions **1** The balls are spherical in shape with a radius of $r_o = 1$ in. **2** The thermal properties of the balls are constant. **3** The heat transfer coefficient is constant and uniform over the entire surface. **4** The Biot number is $Bi < 0.1$ so that the lumped system analysis is applicable (this assumption will be verified).

Properties The thermal conductivity, density, and specific heat of the aluminum balls are $k = 137$ Btu/h.ft.°F, $\rho = 168$ lbm/ft³, and $c_p = 0.216$ Btu/lbm.°F (Table A-3E).

Analysis (a) The characteristic length and the Biot number for the aluminum balls are

$$L_c = \frac{\mathcal{V}}{A} = \frac{\pi D^3 / 6}{\pi D^2} = \frac{D}{6} = \frac{2 / 12 \text{ ft}}{6} = 0.02778 \text{ ft}$$

$$Bi = \frac{hL_c}{k} = \frac{(42 \text{ Btu/h.ft}^2 \cdot \text{°F})(0.02778 \text{ ft})}{(137 \text{ Btu/h.ft.°F})} = 0.00852 < 0.1$$

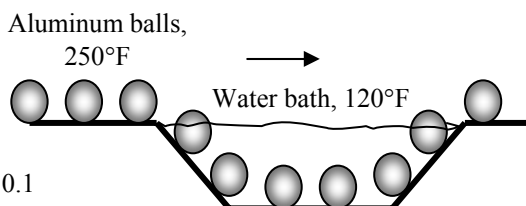

The lumped system analysis is applicable since $Bi < 0.1$. Then the temperature of the balls after quenching becomes

$$b = \frac{hA_s}{\rho c_p \mathcal{V}} = \frac{h}{\rho c_p L_c} = \frac{42 \text{ Btu/h.ft}^2 \cdot \text{°F}}{(168 \text{ lbm/ft}^3)(0.216 \text{ Btu/lbm.°F})(0.02778 \text{ ft})} = 41.66 \text{ h}^{-1} = 0.01157 \text{ s}^{-1}$$

$$\frac{T(t) - T_\infty}{T_i - T_\infty} = e^{-bt} \longrightarrow \frac{T(t) - 120}{250 - 120} = e^{-(0.01157 \text{ s}^{-1})(120 \text{ s})} \longrightarrow T(t) = \mathbf{152^\circ\text{F}}$$

(b) The total amount of heat transfer from a ball during a 2-minute period is

$$m = \rho \mathcal{V} = \rho \frac{\pi D^3}{6} = (168 \text{ lbm/ft}^3) \frac{\pi (2 / 12 \text{ ft})^3}{6} = 0.4072 \text{ lbm}$$

$$Q = mc_p [T_i - T(t)] = (0.4072 \text{ lbm})(0.216 \text{ Btu/lbm.°F})(250 - 152)^\circ\text{F} = 8.62 \text{ Btu}$$

Then the rate of heat transfer from the balls to the water becomes

$$\dot{Q}_{total} = \dot{n}_{ball} Q_{ball} = (120 \text{ balls/min}) \times (8.62 \text{ Btu}) = \mathbf{1034 \text{ Btu/min}}$$

Therefore, heat must be removed from the water at a rate of 1034 Btu/min in order to keep its temperature constant at 120°F.

4-17 Milk in a thin-walled glass container is to be warmed up by placing it into a large pan filled with hot water. The warming time of the milk is to be determined.

Assumptions **1** The glass container is cylindrical in shape with a radius of $r_0 = 3$ cm. **2** The thermal properties of the milk are taken to be the same as those of water. **3** Thermal properties of the milk are constant at room temperature. **4** The heat transfer coefficient is constant and uniform over the entire surface. **5** The Biot number in this case is large (much larger than 0.1). However, the lumped system analysis is still applicable since the milk is stirred constantly, so that its temperature remains uniform at all times.

Properties The thermal conductivity, density, and specific heat of the milk at 20°C are $k = 0.598$ W/m $\cdot^\circ\text{C}$, $\rho = 998$ kg/m 3 , and $c_p = 4.182$ kJ/kg $\cdot^\circ\text{C}$ (Table A-9).

Analysis The characteristic length and Biot number for the glass of milk are

$$L_c = \frac{\mathcal{V}}{A_s} = \frac{\pi r_o^2 L}{2\pi r_o L + 2\pi r_o^2} = \frac{\pi(0.03 \text{ m})^2 (0.07 \text{ m})}{2\pi(0.03 \text{ m})(0.07 \text{ m}) + 2\pi(0.03 \text{ m})^2} = 0.01050 \text{ m}$$

$$Bi = \frac{hL_c}{k} = \frac{(120 \text{ W/m}^2 \cdot ^\circ\text{C})(0.0105 \text{ m})}{(0.598 \text{ W/m} \cdot ^\circ\text{C})} = 2.107 > 0.1$$

For the reason explained above we can use the lumped system analysis to determine how long it will take for the milk to warm up to 38°C :

$$b = \frac{hA_s}{\rho c_p \mathcal{V}} = \frac{h}{\rho c_p L_c} = \frac{120 \text{ W/m}^2 \cdot ^\circ\text{C}}{(998 \text{ kg/m}^3)(4182 \text{ J/kg} \cdot ^\circ\text{C})(0.0105 \text{ m})} = 0.002738 \text{ s}^{-1}$$

$$\frac{T(t) - T_\infty}{T_i - T_\infty} = e^{-bt} \longrightarrow \frac{38 - 60}{3 - 60} = e^{-(0.002738 \text{ s}^{-1})t} \longrightarrow t = \mathbf{348 \text{ s} = 5.8 \text{ min}}$$

Therefore, it will take about 6 minutes to warm the milk from 3 to 38°C .

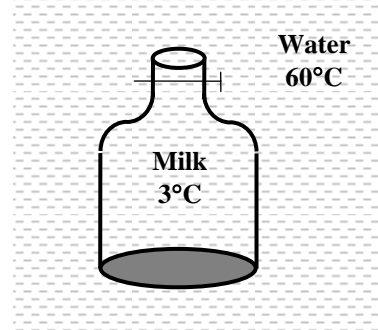

4-18 A thin-walled glass containing milk is placed into a large pan filled with hot water to warm up the milk. The warming time of the milk is to be determined.

Assumptions **1** The glass container is cylindrical in shape with a radius of $r_0 = 3$ cm. **2** The thermal properties of the milk are taken to be the same as those of water. **3** Thermal properties of the milk are constant at room temperature. **4** The heat transfer coefficient is constant and uniform over the entire surface. **5** The Biot number in this case is large (much larger than 0.1). However, the lumped system analysis is still applicable since the milk is stirred constantly, so that its temperature remains uniform at all times.

Properties The thermal conductivity, density, and specific heat of the milk at 20°C are $k = 0.598$ W/m $\cdot^\circ\text{C}$, $\rho = 998$ kg/m 3 , and $c_p = 4.182$ kJ/kg $\cdot^\circ\text{C}$ (Table A-9).

Analysis The characteristic length and Biot number for the glass of milk are

$$L_c = \frac{\mathcal{V}}{A_s} = \frac{\pi r_0^2 L}{2\pi r_0 L + 2\pi r_0^2} = \frac{\pi(0.03 \text{ m})^2(0.07 \text{ m})}{2\pi(0.03 \text{ m})(0.07 \text{ m}) + 2\pi(0.03 \text{ m})^2} = 0.01050 \text{ m}$$

$$Bi = \frac{hL_c}{k} = \frac{(240 \text{ W/m}^2\cdot^\circ\text{C})(0.01050 \text{ m})}{(0.598 \text{ W/m}\cdot^\circ\text{C})} = 4.21 > 0.1$$

For the reason explained above we can use the lumped system analysis to determine how long it will take for the milk to warm up to 38°C :

$$b = \frac{hA_s}{\rho c_p \mathcal{V}} = \frac{h}{\rho c_p L_c} = \frac{240 \text{ W/m}^2\cdot^\circ\text{C}}{(998 \text{ kg/m}^3)(4182 \text{ J/kg}\cdot^\circ\text{C})(0.01050 \text{ m})} = 0.005477 \text{ s}^{-1}$$

$$\frac{T(t) - T_\infty}{T_i - T_\infty} = e^{-bt} \longrightarrow \frac{38 - 60}{3 - 60} = e^{-(0.005477 \text{ s}^{-1})t} \longrightarrow t = 174 \text{ s} = 2.9 \text{ min}$$

Therefore, it will take about 3 minutes to warm the milk from 3 to 38°C .

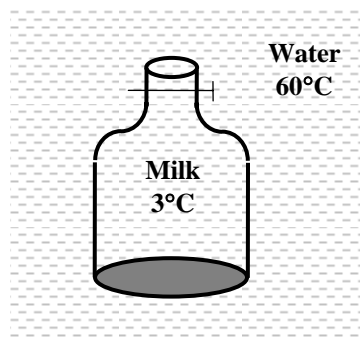

4-19 A long copper rod is cooled to a specified temperature. The cooling time is to be determined.

Assumptions **1** The thermal properties of the geometry are constant. **2** The heat transfer coefficient is constant and uniform over the entire surface.

Properties The properties of copper are $k = 401$ W/m $\cdot^\circ\text{C}$, $\rho = 8933$ kg/m 3 , and $c_p = 0.385$ kJ/kg $\cdot^\circ\text{C}$ (Table A-3).

Analysis For cylinder, the characteristic length and the Biot number are

$$L_c = \frac{\mathcal{V}}{A_{\text{surface}}} = \frac{(\pi D^2 / 4)L}{\pi DL} = \frac{D}{4} = \frac{0.02 \text{ m}}{4} = 0.005 \text{ m}$$

$$Bi = \frac{hL_c}{k} = \frac{(200 \text{ W/m}^2\cdot^\circ\text{C})(0.005 \text{ m})}{(401 \text{ W/m}\cdot^\circ\text{C})} = 0.0025 < 0.1$$

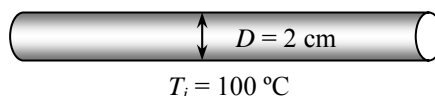

Since $Bi < 0.1$, the lumped system analysis is applicable. Then the cooling time is determined from

$$b = \frac{hA}{\rho c_p \mathcal{V}} = \frac{h}{\rho c_p L_c} = \frac{200 \text{ W/m}^2\cdot^\circ\text{C}}{(8933 \text{ kg/m}^3)(385 \text{ J/kg}\cdot^\circ\text{C})(0.005 \text{ m})} = 0.01163 \text{ s}^{-1}$$

$$\frac{T(t) - T_\infty}{T_i - T_\infty} = e^{-bt} \longrightarrow \frac{25 - 20}{100 - 20} = e^{-(0.01163 \text{ s}^{-1})t} \longrightarrow t = 238 \text{ s} = 4.0 \text{ min}$$

4-20 The heating times of a sphere, a cube, and a rectangular prism with similar dimensions are to be determined.

Assumptions 1 The thermal properties of the geometries are constant. **2** The heat transfer coefficient is constant and uniform over the entire surface.

Properties The properties of silver are given to be $k = 429 \text{ W/m}\cdot\text{°C}$, $\rho = 10,500 \text{ kg/m}^3$, and $c_p = 0.235 \text{ kJ/kg}\cdot\text{°C}$.

Analysis For sphere, the characteristic length and the Biot number are

$$L_c = \frac{V}{A_{\text{surface}}} = \frac{\pi D^3 / 6}{\pi D^2} = \frac{D}{6} = \frac{0.05 \text{ m}}{6} = 0.008333 \text{ m}$$

$$Bi = \frac{hL_c}{k} = \frac{(12 \text{ W/m}^2\cdot\text{°C})(0.008333 \text{ m})}{(429 \text{ W/m}\cdot\text{°C})} = 0.00023 < 0.1$$

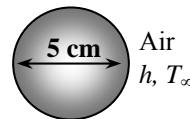

Since $Bi < 0.1$, the lumped system analysis is applicable. Then the time period for the sphere temperature to reach to 25°C is determined from

$$b = \frac{hA}{\rho c_p V} = \frac{h}{\rho c_p L_c} = \frac{12 \text{ W/m}^2\cdot\text{°C}}{(10,500 \text{ kg/m}^3)(235 \text{ J/kg}\cdot\text{°C})(0.008333 \text{ m})} = 0.0005836 \text{ s}^{-1}$$

$$\frac{T(t) - T_\infty}{T_i - T_\infty} = e^{-bt} \longrightarrow \frac{25 - 33}{0 - 33} = e^{-(0.0005836 \text{ s}^{-1})t} \longrightarrow t = 2428 \text{ s} = \mathbf{40.5 \text{ min}}$$

Cube:

$$L_c = \frac{V}{A_{\text{surface}}} = \frac{L^3}{6L^2} = \frac{L}{6} = \frac{0.05 \text{ m}}{6} = 0.008333 \text{ m}$$

$$Bi = \frac{hL_c}{k} = \frac{(12 \text{ W/m}^2\cdot\text{°C})(0.008333 \text{ m})}{(429 \text{ W/m}\cdot\text{°C})} = 0.00023 < 0.1$$

$$b = \frac{hA}{\rho c_p V} = \frac{h}{\rho c_p L_c} = \frac{12 \text{ W/m}^2\cdot\text{°C}}{(10,500 \text{ kg/m}^3)(235 \text{ J/kg}\cdot\text{°C})(0.008333 \text{ m})} = 0.0005836 \text{ s}^{-1}$$

$$\frac{T(t) - T_\infty}{T_i - T_\infty} = e^{-bt} \longrightarrow \frac{25 - 33}{0 - 33} = e^{-(0.0005836 \text{ s}^{-1})t} \longrightarrow t = 2428 \text{ s} = \mathbf{40.5 \text{ min}}$$

Rectangular prism:

$$L_c = \frac{V}{A_{\text{surface}}} = \frac{(0.04 \text{ m})(0.05 \text{ m})(0.06 \text{ m})}{2(0.04 \text{ m})(0.05 \text{ m}) + 2(0.04 \text{ m})(0.06 \text{ m}) + 2(0.05 \text{ m})(0.06 \text{ m})} = 0.008108 \text{ m}$$

$$Bi = \frac{hL_c}{k} = \frac{(12 \text{ W/m}^2\cdot\text{°C})(0.008108 \text{ m})}{(429 \text{ W/m}\cdot\text{°C})} = 0.00023 < 0.1$$

$$b = \frac{hA}{\rho c_p V} = \frac{h}{\rho c_p L_c} = \frac{12 \text{ W/m}^2\cdot\text{°C}}{(10,500 \text{ kg/m}^3)(235 \text{ J/kg}\cdot\text{°C})(0.008108 \text{ m})} = 0.0005998 \text{ s}^{-1}$$

$$\frac{T(t) - T_\infty}{T_i - T_\infty} = e^{-bt} \longrightarrow \frac{25 - 33}{0 - 33} = e^{-(0.0005998 \text{ s}^{-1})t} \longrightarrow t = 2363 \text{ s} = \mathbf{39.4 \text{ min}}$$

The heating times are same for the sphere and cube while it is smaller in rectangular prism.

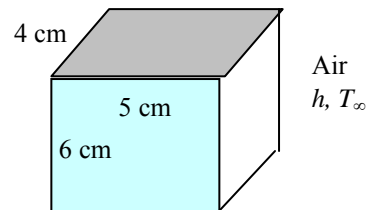
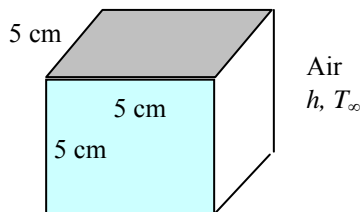

4-21E A person shakes a can of drink in a iced water to cool it. The cooling time of the drink is to be determined.

Assumptions **1** The can containing the drink is cylindrical in shape with a radius of $r_o = 1.25$ in. **2** The thermal properties of the drink are taken to be the same as those of water. **3** Thermal properties of the drink are constant at room temperature. **4** The heat transfer coefficient is constant and uniform over the entire surface. **5** The Biot number in this case is large (much larger than 0.1). However, the lumped system analysis is still applicable since the drink is stirred constantly, so that its temperature remains uniform at all times.

Properties The density and specific heat of water at room temperature are $\rho = 62.22$ lbm/ft³, and $c_p = 0.999$ Btu/lbm.°F (Table A-9E).

Analysis Application of lumped system analysis in this case gives

$$L_c = \frac{V}{A_s} = \frac{\pi r_o^2 L}{2\pi r_o L + 2\pi r_o^2} = \frac{\pi(1.25/12 \text{ ft})^2 (5/12 \text{ ft})}{2\pi(1.25/12 \text{ ft})(5/12 \text{ ft}) + 2\pi(1.25/12 \text{ ft})^2} = 0.04167 \text{ ft}$$

$$b = \frac{hA_s}{\rho c_p V} = \frac{h}{\rho c_p L_c} = \frac{30 \text{ Btu/h}\cdot\text{ft}^2\cdot^\circ\text{F}}{(62.22 \text{ lbm/ft}^3)(0.999 \text{ Btu/lbm}\cdot^\circ\text{F})(0.04167 \text{ ft})} = 11.583 \text{ h}^{-1} = 0.00322 \text{ s}^{-1}$$

$$\frac{T(t) - T_\infty}{T_i - T_\infty} = e^{-bt} \longrightarrow \frac{40 - 32}{90 - 32} = e^{-(0.00322 \text{ s}^{-1})t} \longrightarrow t = \mathbf{615 \text{ s}}$$

Therefore, it will take 10 minutes and 15 seconds to cool the canned drink to 45°F.

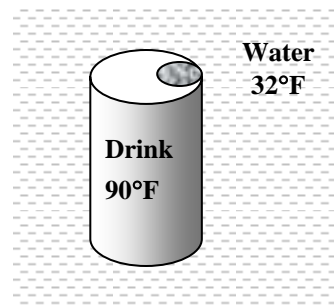

4-22 An iron whose base plate is made of an aluminum alloy is turned on. The time for the plate temperature to reach 140°C and whether it is realistic to assume the plate temperature to be uniform at all times are to be determined.

Assumptions **1** 85 percent of the heat generated in the resistance wires is transferred to the plate. **2** The thermal properties of the plate are constant. **3** The heat transfer coefficient is constant and uniform over the entire surface.

Properties The density, specific heat, and thermal diffusivity of the aluminum alloy plate are given to be $\rho = 2770 \text{ kg/m}^3$, $c_p = 875 \text{ kJ/kg}\cdot^{\circ}\text{C}$, and $\alpha = 7.3 \times 10^{-5} \text{ m}^2/\text{s}$. The thermal conductivity of the plate can be determined from $k = \alpha\rho c_p = 177 \text{ W/m}\cdot^{\circ}\text{C}$ (or it can be read from Table A-3).

Analysis The mass of the iron's base plate is

$$m = \rho V = \rho LA = (2770 \text{ kg/m}^3)(0.005 \text{ m})(0.03 \text{ m}^2) = 0.4155 \text{ kg}$$

Noting that only 85 percent of the heat generated is transferred to the plate, the rate of heat transfer to the iron's base plate is

$$\dot{Q}_{\text{in}} = 0.85 \times 1000 \text{ W} = 850 \text{ W}$$

The temperature of the plate, and thus the rate of heat transfer from the plate, changes during the process. Using the average plate temperature, the average rate of heat loss from the plate is determined from

$$\dot{Q}_{\text{loss}} = hA(T_{\text{plate,ave}} - T_{\infty}) = (12 \text{ W/m}^2\cdot^{\circ}\text{C})(0.03 \text{ m}^2) \left(\frac{140 + 22}{2} - 22 \right)^{\circ}\text{C} = 21.2 \text{ W}$$

Energy balance on the plate can be expressed as

$$E_{\text{in}} - E_{\text{out}} = \Delta E_{\text{plate}} \rightarrow \dot{Q}_{\text{in}} \Delta t - \dot{Q}_{\text{out}} \Delta t = \Delta E_{\text{plate}} = mc_p \Delta T_{\text{plate}}$$

Solving for Δt and substituting,

$$\Delta t = \frac{mc_p \Delta T_{\text{plate}}}{\dot{Q}_{\text{in}} - \dot{Q}_{\text{out}}} = \frac{(0.4155 \text{ kg})(875 \text{ J/kg}\cdot^{\circ}\text{C})(140 - 22)^{\circ}\text{C}}{(850 - 21.2) \text{ J/s}} = \mathbf{51.8 \text{ s}}$$

which is the time required for the plate temperature to reach 140°C . To determine whether it is realistic to assume the plate temperature to be uniform at all times, we need to calculate the Biot number,

$$L_c = \frac{V}{A_s} = \frac{LA}{A} = L = 0.005 \text{ m}$$

$$Bi = \frac{hL_c}{k} = \frac{(12 \text{ W/m}^2\cdot^{\circ}\text{C})(0.005 \text{ m})}{(177.0 \text{ W/m}\cdot^{\circ}\text{C})} = 0.00034 < 0.1$$

It is realistic to assume uniform temperature for the plate since $Bi < 0.1$.

Discussion This problem can also be solved by obtaining the differential equation from an energy balance on the plate for a differential time interval, and solving the differential equation. It gives

$$T(t) = T_{\infty} + \frac{\dot{Q}_{\text{in}}}{hA} \left(1 - \exp\left(-\frac{hA}{mc_p} t\right) \right)$$

Substituting the known quantities and solving for t again gives 51.8 s.

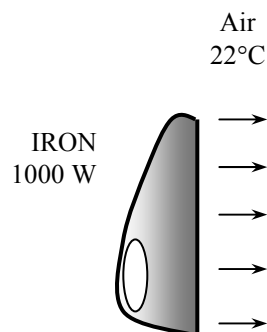

4-23 EES Prob. 4-22 is reconsidered. The effects of the heat transfer coefficient and the final plate temperature on the time it will take for the plate to reach this temperature are to be investigated.

Analysis The problem is solved using EES, and the solution is given below.

"GIVEN"

E_dot=1000 [W]
 L=0.005 [m]
 A=0.03 [m^2]
 T_infinity=22 [C]
 T_i=T_infinity
 h=12 [W/m^2-C]
 f_heat=0.85
 T_f=140 [C]

"PROPERTIES"

rho=2770 [kg/m^3]
 C_p=875 [J/kg-C]
 alpha=7.3E-5 [m^2/s]

"ANALYSIS"

V=L*A
 m=rho*V
 Q_dot_in=f_heat*E_dot
 Q_dot_out=h*A*(T_ave-T_infinity)
 T_ave=1/2*(T_i+T_f)
 (Q_dot_in-Q_dot_out)*time=m*C_p*(T_f-T_i) "energy balance on the plate"

h [W/m².C]	time [s]
5	51
7	51.22
9	51.43
11	51.65
13	51.88
15	52.1
17	52.32
19	52.55
21	52.78
23	53.01
25	53.24

T_f [C]	time [s]
30	3.428
40	7.728
50	12.05
60	16.39
70	20.74
80	25.12
90	29.51
100	33.92
110	38.35
120	42.8

130	47.28
140	51.76
150	56.27
160	60.8
170	65.35
180	69.92
190	74.51
200	79.12

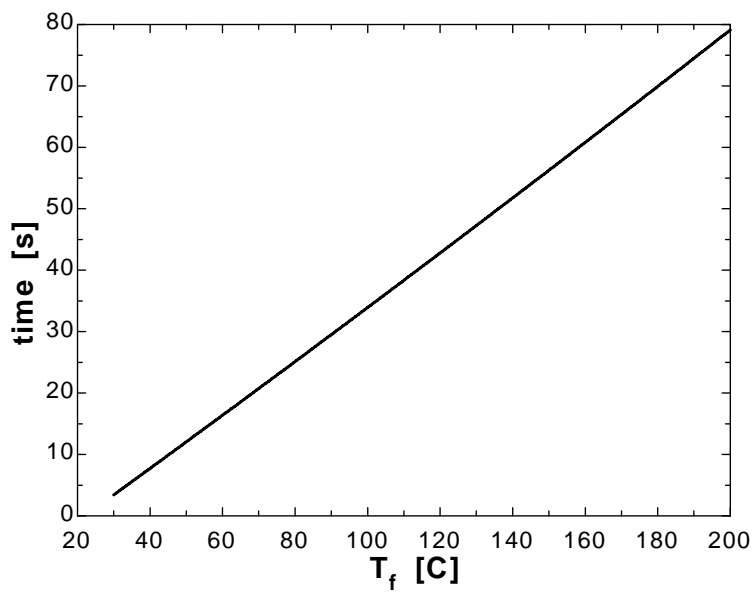
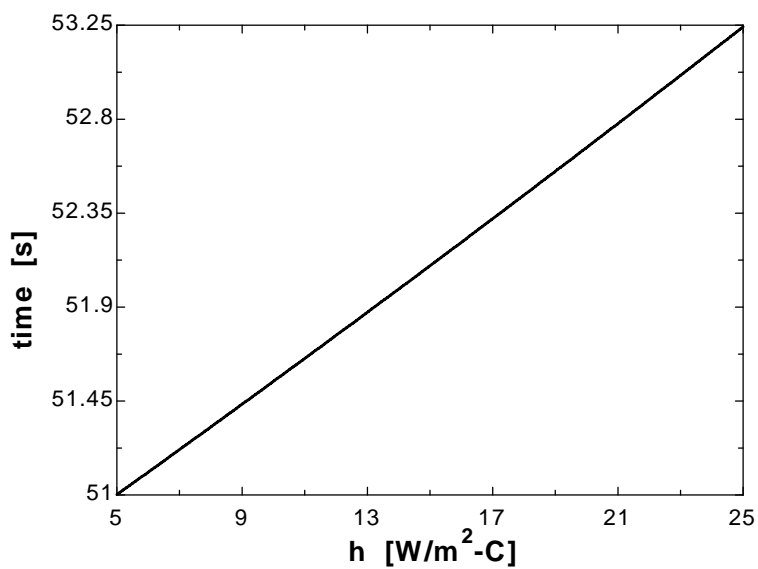

4-24 Ball bearings leaving the oven at a uniform temperature of 900°C are exposed to air for a while before they are dropped into the water for quenching. The time they can stand in the air before their temperature falls below 850°C is to be determined.

Assumptions **1** The bearings are spherical in shape with a radius of $r_o = 0.6$ cm. **2** The thermal properties of the bearings are constant. **3** The heat transfer coefficient is constant and uniform over the entire surface. **4** The Biot number is $\text{Bi} < 0.1$ so that the lumped system analysis is applicable (this assumption will be verified).

Properties The thermal conductivity, density, and specific heat of the bearings are given to be $k = 15.1$ $\text{W/m}\cdot^{\circ}\text{C}$, $\rho = 8085$ kg/m^3 , and $c_p = 0.480$ $\text{kJ/kg}\cdot^{\circ}\text{C}$.

Analysis The characteristic length of the steel ball bearings and Biot number are

$$L_c = \frac{V}{A_s} = \frac{\pi D^3 / 6}{\pi D^2} = \frac{D}{6} = \frac{0.012 \text{ m}}{6} = 0.002 \text{ m}$$

$$\text{Bi} = \frac{hL_c}{k} = \frac{(125 \text{ W/m}^2 \cdot ^{\circ}\text{C})(0.002 \text{ m})}{(15.1 \text{ W/m}\cdot^{\circ}\text{C})} = 0.0166 < 0.1$$

Therefore, the lumped system analysis is applicable. Then the allowable time is determined to be

$$b = \frac{hA_s}{\rho c_p V} = \frac{h}{\rho c_p L_c} = \frac{125 \text{ W/m}^2 \cdot ^{\circ}\text{C}}{(8085 \text{ kg/m}^3)(480 \text{ J/kg}\cdot^{\circ}\text{C})(0.002 \text{ m})} = 0.01610 \text{ s}^{-1}$$

$$\frac{T(t) - T_{\infty}}{T_i - T_{\infty}} = e^{-bt} \longrightarrow \frac{850 - 30}{900 - 30} = e^{-(0.0161 \text{ s}^{-1})t} \longrightarrow t = \mathbf{3.68 \text{ s}}$$

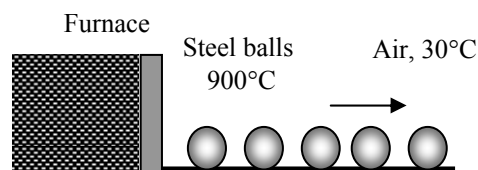

The result indicates that the ball bearing can stay in the air about 4 s before being dropped into the water.

4-25 A number of carbon steel balls are to be annealed by heating them first and then allowing them to cool slowly in ambient air at a specified rate. The time of annealing and the total rate of heat transfer from the balls to the ambient air are to be determined.

Assumptions 1 The balls are spherical in shape with a radius of $r_o = 4$ mm. 2 The thermal properties of the balls are constant. 3 The heat transfer coefficient is constant and uniform over the entire surface. 4 The Biot number is $Bi < 0.1$ so that the lumped system analysis is applicable (this assumption will be verified).

Properties The thermal conductivity, density, and specific heat of the balls are given to be $k = 54$ W/m·°C, $\rho = 7833$ kg/m³, and $c_p = 0.465$ kJ/kg·°C.

Analysis The characteristic length of the balls and the Biot number are

$$L_c = \frac{V}{A_s} = \frac{\pi D^3 / 6}{\pi D^2} = \frac{D}{6} = \frac{0.008 \text{ m}}{6} = 0.0013 \text{ m}$$

$$Bi = \frac{hL_c}{k} = \frac{(75 \text{ W/m}^2 \cdot \text{°C})(0.0013 \text{ m})}{(54 \text{ W/m} \cdot \text{°C})} = 0.0018 < 0.1$$

Therefore, the lumped system analysis is applicable. Then the time for the annealing process is determined to be

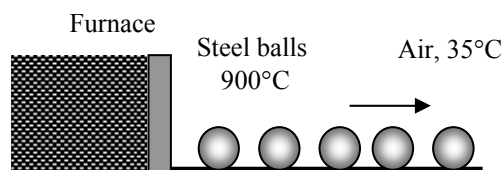

$$b = \frac{hA_s}{\rho c_p V} = \frac{h}{\rho c_p L_c} = \frac{75 \text{ W/m}^2 \cdot \text{°C}}{(7833 \text{ kg/m}^3)(465 \text{ J/kg} \cdot \text{°C})(0.0013 \text{ m})} = 0.01584 \text{ s}^{-1}$$

$$\frac{T(t) - T_\infty}{T_i - T_\infty} = e^{-bt} \longrightarrow \frac{100 - 35}{900 - 35} = e^{-(0.01584 \text{ s}^{-1})t} \longrightarrow t = 163 \text{ s} = 2.7 \text{ min}$$

The amount of heat transfer from a single ball is

$$m = \rho V = \rho \frac{\pi D^3}{6} = (7833 \text{ kg/m}^3) \frac{\pi (0.008 \text{ m})^3}{6} = 0.0021 \text{ kg}$$

$$Q = mc_p [T_f - T_i] = (0.0021 \text{ kg})(465 \text{ J/kg} \cdot \text{°C})(900 - 100)^\circ\text{C} = 781 \text{ J} = 0.781 \text{ kJ (per ball)}$$

Then the total rate of heat transfer from the balls to the ambient air becomes

$$\dot{Q} = \dot{n}_{\text{ball}} Q = (2500 \text{ balls/h}) \times (0.781 \text{ kJ/ball}) = 1,953 \text{ kJ/h} = 543 \text{ W}$$

4-26 EES Prob. 4-25 is reconsidered. The effect of the initial temperature of the balls on the annealing time and the total rate of heat transfer is to be investigated.

Analysis The problem is solved using EES, and the solution is given below.

"GIVEN"

$$D=0.008 \text{ [m]}$$

$$T_i=900 \text{ [C]}$$

$$T_f=100 \text{ [C]}$$

$$T_{\text{infinity}}=35 \text{ [C]}$$

$$h=75 \text{ [W/m}^2\text{-C]}$$

$$n_{\text{dot_ball}}=2500 \text{ [1/h]}$$

"PROPERTIES"

$$\rho=7833 \text{ [kg/m}^3\text{]}$$

$$k=54 \text{ [W/m-C]}$$

$$C_p=465 \text{ [J/kg-C]}$$

$$\alpha=1.474\text{E-}6 \text{ [m}^2\text{/s]}$$

"ANALYSIS"

$$A=\pi \cdot D^2$$

$$V=\pi \cdot D^3/6$$

$$L_c=V/A$$

$$Bi=(h \cdot L_c)/k \text{ "if } Bi < 0.1, \text{ the lumped sytem analysis is applicable"}$$

$$b=(h \cdot A)/(\rho \cdot C_p \cdot V)$$

$$(T_f - T_{\text{infinity}})/(T_i - T_{\text{infinity}}) = \exp(-b \cdot \text{time})$$

$$m=\rho \cdot V$$

$$Q=m \cdot C_p \cdot (T_i - T_f)$$

$$Q_{\text{dot}}=n_{\text{dot_ball}} \cdot Q \cdot \text{Convert(J/h, W)}$$

T_i [C]	time [s]	Q [W]
500	127.4	271.2
550	134	305.1
600	140	339
650	145.5	372.9
700	150.6	406.9
750	155.3	440.8
800	159.6	474.7
850	163.7	508.6
900	167.6	542.5
950	171.2	576.4
1000	174.7	610.3

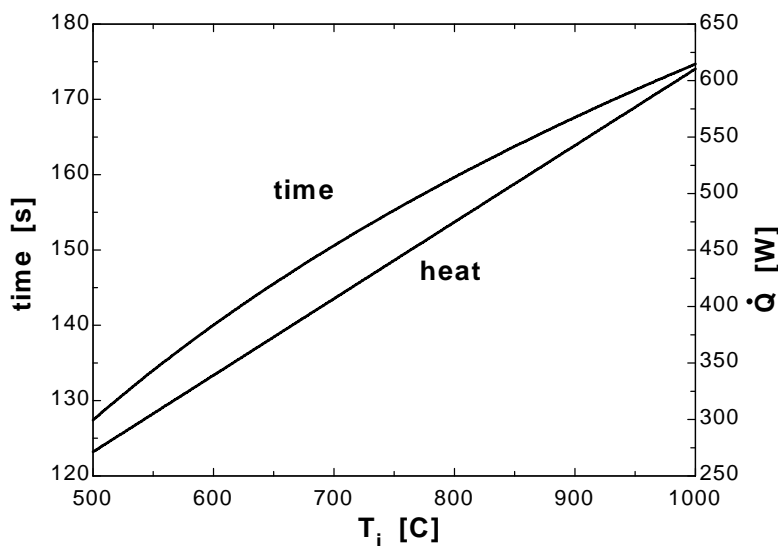

4-27 An electronic device is on for 5 minutes, and off for several hours. The temperature of the device at the end of the 5-min operating period is to be determined for the cases of operation with and without a heat sink.

Assumptions 1 The device and the heat sink are isothermal. **2** The thermal properties of the device and of the sink are constant. **3** The heat transfer coefficient is constant and uniform over the entire surface.

Properties The specific heat of the device is given to be $c_p = 850 \text{ J/kg}\cdot^\circ\text{C}$. The specific heat of the aluminum sink is $903 \text{ J/kg}\cdot^\circ\text{C}$ (Table A-3), but can be taken to be $850 \text{ J/kg}\cdot^\circ\text{C}$ for simplicity in analysis.

Analysis (a) Approximate solution

This problem can be solved approximately by using an average temperature for the device when evaluating the heat loss. An energy balance on the device can be expressed as

$$E_{\text{in}} - E_{\text{out}} + E_{\text{generation}} = \Delta E_{\text{device}} \longrightarrow -\dot{Q}_{\text{out}} \Delta t + \dot{E}_{\text{generation}} \Delta t = mc_p \Delta T_{\text{device}}$$

$$\text{or,} \quad \dot{E}_{\text{generation}} \Delta t - hA_s \left(\frac{T + T_\infty}{2} - T_\infty \right) \Delta t = mc_p (T - T_\infty)$$

Substituting the given values,

$$(20 \text{ J/s})(5 \times 60 \text{ s}) - (12 \text{ W/m}^2 \cdot ^\circ\text{C})(0.0004 \text{ m}^2) \left(\frac{T - 25}{2} \right)^\circ\text{C}(5 \times 60 \text{ s}) = (0.02 \text{ kg})(850 \text{ J/kg}\cdot^\circ\text{C})(T - 25)^\circ\text{C}$$

which gives $T = \mathbf{363.6^\circ\text{C}}$

If the device were attached to an aluminum heat sink, the temperature of the device would be

$$\begin{aligned} (20 \text{ J/s})(5 \times 60 \text{ s}) - (12 \text{ W/m}^2 \cdot ^\circ\text{C})(0.0084 \text{ m}^2) \left(\frac{T - 25}{2} \right)^\circ\text{C}(5 \times 60 \text{ s}) \\ = (0.20 + 0.02) \text{ kg} \times (850 \text{ J/kg}\cdot^\circ\text{C})(T - 25)^\circ\text{C} \end{aligned}$$

which gives $T = \mathbf{54.7^\circ\text{C}}$

Note that the temperature of the electronic device drops considerably as a result of attaching it to a heat sink.

(b) Exact solution

This problem can be solved exactly by obtaining the differential equation from an energy balance on the device for a differential time interval dt . We will get

$$\frac{d(T - T_\infty)}{dt} + \frac{hA_s}{mc_p} (T - T_\infty) = \frac{\dot{E}_{\text{generation}}}{mc_p}$$

It can be solved to give

$$T(t) = T_\infty + \frac{\dot{E}_{\text{generation}}}{hA_s} \left(1 - \exp\left(-\frac{hA_s}{mc_p} t\right) \right)$$

Substituting the known quantities and solving for t gives $\mathbf{363.4^\circ\text{C}}$ for the first case and $\mathbf{54.6^\circ\text{C}}$ for the second case, which are practically identical to the results obtained from the approximate analysis.

Electronic
device
20 W

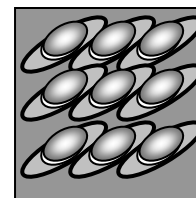

Transient Heat Conduction in Large Plane Walls, Long Cylinders, and Spheres

4-28C A cylinder whose diameter is small relative to its length can be treated as an infinitely long cylinder. When the diameter and length of the cylinder are comparable, it is not proper to treat the cylinder as being infinitely long. It is also not proper to use this model when finding the temperatures near the bottom or top surfaces of a cylinder since heat transfer at those locations can be two-dimensional.

4-29C Yes. A plane wall whose one side is insulated is equivalent to a plane wall that is twice as thick and is exposed to convection from both sides. The midplane in the latter case will behave like an insulated surface because of thermal symmetry.

4-30C The solution for determination of the one-dimensional transient temperature distribution involves many variables that make the graphical representation of the results impractical. In order to reduce the number of parameters, some variables are grouped into dimensionless quantities.

4-31C The Fourier number is a measure of heat conducted through a body relative to the heat stored. Thus a large value of Fourier number indicates faster propagation of heat through body. Since Fourier number is proportional to time, doubling the time will also double the Fourier number.

4-32C This case can be handled by setting the heat transfer coefficient h to infinity ∞ since the temperature of the surrounding medium in this case becomes equivalent to the surface temperature.

4-33C The maximum possible amount of heat transfer will occur when the temperature of the body reaches the temperature of the medium, and can be determined from $Q_{\max} = mc_p (T_{\infty} - T_i)$.

4-34C When the Biot number is less than 0.1, the temperature of the sphere will be nearly uniform at all times. Therefore, it is more convenient to use the lumped system analysis in this case.

4-35 A student calculates the total heat transfer from a spherical copper ball. It is to be determined whether his/her result is reasonable.

Assumptions The thermal properties of the copper ball are constant at room temperature.

Properties The density and specific heat of the copper ball are $\rho = 8933 \text{ kg/m}^3$, and $c_p = 0.385 \text{ kJ/kg}\cdot^{\circ}\text{C}$ (Table A-3).

Analysis The mass of the copper ball and the maximum amount of heat transfer from the copper ball are

$$m = \rho V = \rho \left(\frac{\pi D^3}{6} \right) = (8933 \text{ kg/m}^3) \left[\frac{\pi (0.18 \text{ m})^3}{6} \right] = 27.28 \text{ kg}$$

$$Q_{\max} = mc_p [T_i - T_{\infty}] = (27.28 \text{ kg})(0.385 \text{ kJ/kg}\cdot^{\circ}\text{C})(200 - 25)^{\circ}\text{C} = 1838 \text{ kJ}$$

Discussion The student's result of 3150 kJ is **not reasonable** since it is greater than the maximum possible amount of heat transfer.

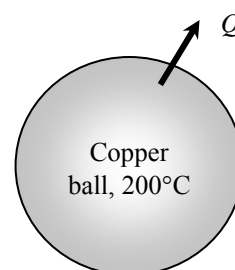

4-36 Tomatoes are placed into cold water to cool them. The heat transfer coefficient and the amount of heat transfer are to be determined.

Assumptions 1 The tomatoes are spherical in shape. **2** Heat conduction in the tomatoes is one-dimensional because of symmetry about the midpoint. **3** The thermal properties of the tomatoes are constant. **4** The heat transfer coefficient is constant and uniform over the entire surface. **5** The Fourier number is $\tau > 0.2$ so that the one-term approximate solutions (or the transient temperature charts) are applicable (this assumption will be verified).

Properties The properties of the tomatoes are given to be $k = 0.59 \text{ W/m}\cdot\text{°C}$, $\alpha = 0.141 \times 10^{-6} \text{ m}^2/\text{s}$, $\rho = 999 \text{ kg/m}^3$ and $c_p = 3.99 \text{ kJ/kg}\cdot\text{°C}$.

Analysis The Fourier number is

$$\tau = \frac{\alpha t}{r_o^2} = \frac{(0.141 \times 10^{-6} \text{ m}^2/\text{s})(2 \times 3600 \text{ s})}{(0.04 \text{ m})^2} = 0.635$$

which is greater than 0.2. Therefore one-term solution is applicable. The ratio of the dimensionless temperatures at the surface and center of the tomatoes are

$$\frac{\theta_{s,\text{sph}}}{\theta_{0,\text{sph}}} = \frac{\frac{T_s - T_\infty}{T_i - T_\infty}}{\frac{T_0 - T_\infty}{T_i - T_\infty}} = \frac{T_s - T_\infty}{T_0 - T_\infty} = \frac{A_1 e^{-\lambda_1^2 \tau} \frac{\sin(\lambda_1)}{\lambda_1}}{A_1 e^{-\lambda_1^2 \tau}} = \frac{\sin(\lambda_1)}{\lambda_1}$$

Substituting,

$$\frac{7.1 - 7}{10 - 7} = \frac{\sin(\lambda_1)}{\lambda_1} \longrightarrow \lambda_1 = 3.0401$$

From Table 4-2, the corresponding Biot number and the heat transfer coefficient are

$$\text{Bi} = 31.1$$

$$\text{Bi} = \frac{hr_o}{k} \longrightarrow h = \frac{k\text{Bi}}{r_o} = \frac{(0.59 \text{ W/m}\cdot\text{°C})(31.1)}{(0.04 \text{ m})} = \mathbf{459 \text{ W/m}^2\cdot\text{°C}}$$

The maximum amount of heat transfer is

$$m = 8\rho V = 8\rho\pi D^3 / 6 = 8(999 \text{ kg/m}^3)[\pi(0.08 \text{ m})^3 / 6] = 2.143 \text{ kg}$$

$$Q_{\text{max}} = mc_p [T_i - T_\infty] = (2.143 \text{ kg})(3.99 \text{ kJ/kg}\cdot\text{°C})(30 - 7)\text{°C} = 196.6 \text{ kJ}$$

Then the actual amount of heat transfer becomes

$$\left(\frac{Q}{Q_{\text{max}}}\right)_{\text{cyl}} = 1 - 3 \left(\frac{T_0 - T_\infty}{T_i - T_\infty}\right) \frac{\sin \lambda_1 - \lambda_1 \cos \lambda_1}{\lambda_1^3} = 1 - 3 \left(\frac{10 - 7}{30 - 7}\right) \frac{\sin(3.0401) - (3.0401) \cos(3.0401)}{(3.0401)^3} = 0.9565$$

$$Q = 0.9565 Q_{\text{max}}$$

$$Q = 0.9565(196.6 \text{ kJ}) = \mathbf{188 \text{ kJ}}$$

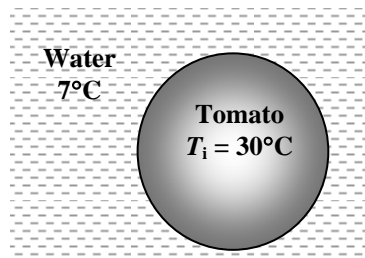

4-37 An egg is dropped into boiling water. The cooking time of the egg is to be determined. \surd

Assumptions **1** The egg is spherical in shape with a radius of $r_o = 2.75$ cm. **2** Heat conduction in the egg is one-dimensional because of symmetry about the midpoint. **3** The thermal properties of the egg are constant. **4** The heat transfer coefficient is constant and uniform over the entire surface. **4** The Fourier number is $\tau > 0.2$ so that the one-term approximate solutions (or the transient temperature charts) are applicable (this assumption will be verified).

Properties The thermal conductivity and diffusivity of the eggs are given to be $k = 0.6$ W/m. $^{\circ}$ C and $\alpha = 0.14 \times 10^{-6}$ m 2 /s.

Analysis The Biot number for this process is

$$Bi = \frac{hr_o}{k} = \frac{(1400 \text{ W/m}^2 \cdot ^{\circ}\text{C})(0.0275 \text{ m})}{(0.6 \text{ W/m} \cdot ^{\circ}\text{C})} = 64.2$$

The constants λ_1 and A_1 corresponding to this Biot number are, from Table 4-2,

$$\lambda_1 = 3.0877 \quad \text{and} \quad A_1 = 1.9969$$

Then the Fourier number becomes

$$\theta_{0,sph} = \frac{T_0 - T_{\infty}}{T_i - T_{\infty}} = A_1 e^{-\lambda_1^2 \tau} \longrightarrow \frac{70 - 97}{8 - 97} = (1.9969) e^{-(3.0877)^2 \tau} \longrightarrow \tau = 0.198 \approx 0.2$$

Therefore, the one-term approximate solution (or the transient temperature charts) is applicable. Then the time required for the temperature of the center of the egg to reach 70 $^{\circ}$ C is determined to be

$$t = \frac{\tau_o^2}{\alpha} = \frac{(0.198)(0.0275 \text{ m})^2}{(0.14 \times 10^{-6} \text{ m}^2/\text{s})} = 1070 \text{ s} = \mathbf{17.8 \text{ min}}$$

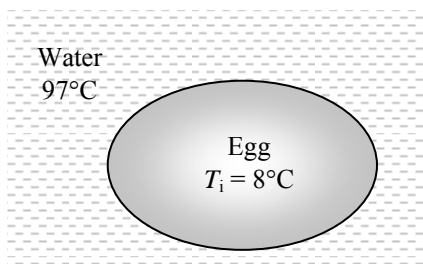

4-38 EES Prob. 4-37 is reconsidered. The effect of the final center temperature of the egg on the time it will take for the center to reach this temperature is to be investigated.

Analysis The problem is solved using EES, and the solution is given below.

"GIVEN"

D=0.055 [m]
 T_i=8 [C]
 T_o=70 [C]
 T_{infinity}=97 [C]
 h=1400 [W/m²-C]

"PROPERTIES"

k=0.6 [W/m-C]
 alpha=0.14E-6 [m²/s]

"ANALYSIS"

Bi=(h*r_o)/k
 r_o=D/2
 "From Table 4-2 corresponding to this Bi number, we read"
 lambda₁=1.9969
 A₁=3.0863
 (T_o-T_{infinity})/(T_i-T_{infinity})=A₁*exp(-lambda₁²*tau)
 time=(tau*r_o²)/alpha*Convert(s, min)

T _o [C]	time [min]
50	39.86
55	42.4
60	45.26
65	48.54
70	52.38
75	57
80	62.82
85	70.68
90	82.85
95	111.1

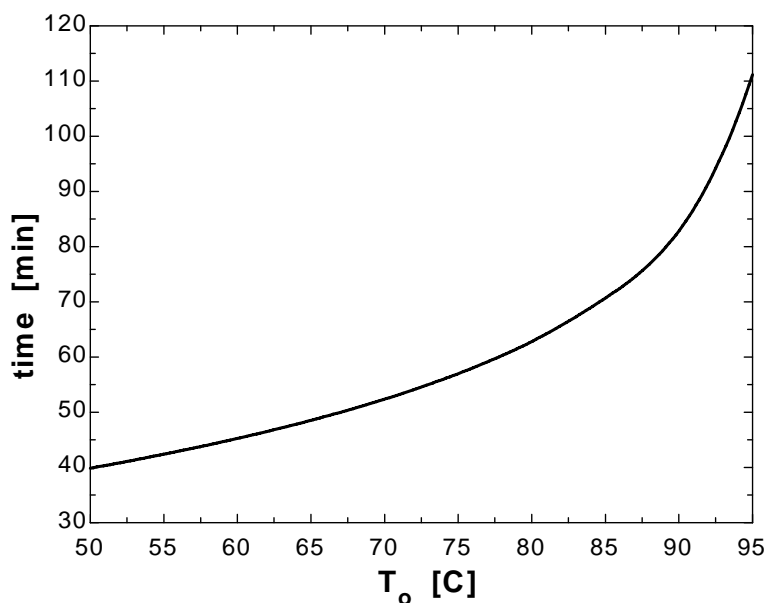

4-39 Large brass plates are heated in an oven. The surface temperature of the plates leaving the oven is to be determined.

Assumptions 1 Heat conduction in the plate is one-dimensional since the plate is large relative to its thickness and there is thermal symmetry about the center plane. **3** The thermal properties of the plate are constant. **4** The heat transfer coefficient is constant and uniform over the entire surface. **5** The Fourier number is $\tau > 0.2$ so that the one-term approximate solutions (or the transient temperature charts) are applicable (this assumption will be verified).

Properties The properties of brass at room temperature are given to be $k = 110 \text{ W/m}\cdot\text{°C}$, $\alpha = 33.9 \times 10^{-6} \text{ m}^2/\text{s}$

Analysis The Biot number for this process is

$$Bi = \frac{hL}{k} = \frac{(80 \text{ W/m}^2 \cdot \text{°C})(0.015 \text{ m})}{(110 \text{ W/m}\cdot\text{°C})} = 0.0109$$

The constants λ_1 and A_1 corresponding to this Biot number are, from Table 4-2,

$$\lambda_1 = 0.1035 \quad \text{and} \quad A_1 = 1.0018$$

The Fourier number is

$$\tau = \frac{\alpha t}{L^2} = \frac{(33.9 \times 10^{-6} \text{ m}^2/\text{s})(10 \text{ min} \times 60 \text{ s/min})}{(0.015 \text{ m})^2} = 90.4 > 0.2$$

Therefore, the one-term approximate solution (or the transient temperature charts) is applicable. Then the temperature at the surface of the plates becomes

$$\theta(L, t)_{\text{wall}} = \frac{T(x, t) - T_\infty}{T_i - T_\infty} = A_1 e^{-\lambda_1^2 \tau} \cos(\lambda_1 L / L) = (1.0018) e^{-(0.1035)^2 (90.4)} \cos(0.1035) = 0.378$$

$$\frac{T(L, t) - 700}{25 - 700} = 0.378 \longrightarrow T(L, t) = \mathbf{445 \text{ °C}}$$

Discussion This problem can be solved easily using the lumped system analysis since $Bi < 0.1$, and thus the lumped system analysis is applicable. It gives

$$\alpha = \frac{k}{\rho c_p} \rightarrow \rho c_p = \frac{k}{\alpha} = \frac{110 \text{ W/m}\cdot\text{°C}}{33.9 \times 10^{-6} \text{ m}^2/\text{s}} = 3.245 \times 10^6 \text{ W}\cdot\text{s/m}^3 \cdot \text{°C}$$

$$b = \frac{hA}{\rho V c_p} = \frac{hA}{\rho(LA)c_p} = \frac{h}{\rho L c_p} = \frac{h}{L(k/\alpha)} = \frac{80 \text{ W/m}^2 \cdot \text{°C}}{(0.015 \text{ m})(3.245 \times 10^6 \text{ W}\cdot\text{s/m}^3 \cdot \text{°C})} = 0.001644 \text{ s}^{-1}$$

$$\frac{T(t) - T_\infty}{T_i - T_\infty} = e^{-bt} \rightarrow T(t) = T_\infty + (T_i - T_\infty) e^{-bt} = 700 \text{ °C} + (25 - 700 \text{ °C}) e^{-(0.001644 \text{ s}^{-1})(600 \text{ s})} = \mathbf{448 \text{ °C}}$$

which is almost identical to the result obtained above.

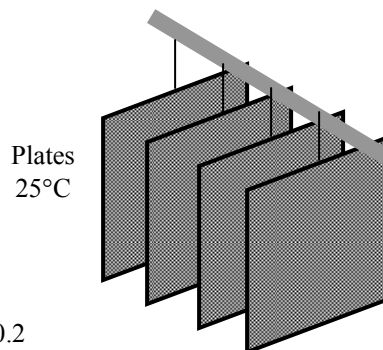

4-40 EES Prob. 4-39 is reconsidered. The effects of the temperature of the oven and the heating time on the final surface temperature of the plates are to be investigated.

Analysis The problem is solved using EES, and the solution is given below.

"GIVEN"

L=0.03/2 [m]
 T_i=25 [C]
 T_{infinity}=700 [C]
 time=10 [min]
 h=80 [W/m²-C]

"PROPERTIES"

k=110 [W/m-C]
 alpha=33.9E-6 [m²/s]

"ANALYSIS"

Bi=(h*L)/k

"From Table 4-2, corresponding to this Bi number, we read"

lambda_1=0.1039

A_1=1.0018

tau=(alpha*time*Convert(min, s))/L²

(T_L-T_{infinity})/(T_i-T_{infinity})=A_1*exp(-lambda_1²*tau)*Cos(lambda_1*L/L)

T _∞ [C]	T _L [C]
500	321.6
525	337.2
550	352.9
575	368.5
600	384.1
625	399.7
650	415.3
675	430.9
700	446.5
725	462.1
750	477.8
775	493.4
800	509
825	524.6
850	540.2
875	555.8
900	571.4

time [min]	T _L [C]
2	146.7
4	244.8
6	325.5
8	391.9
10	446.5
12	491.5
14	528.5
16	558.9

18	583.9
20	604.5
22	621.4
24	635.4
26	646.8
28	656.2
30	664

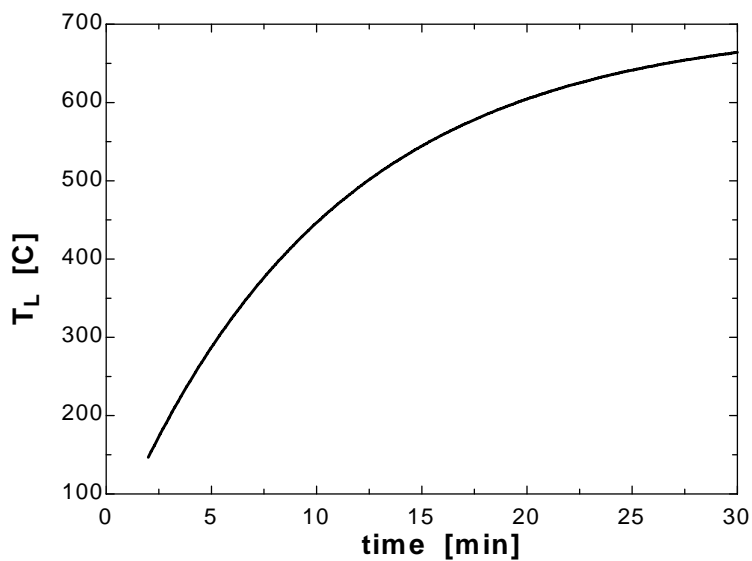
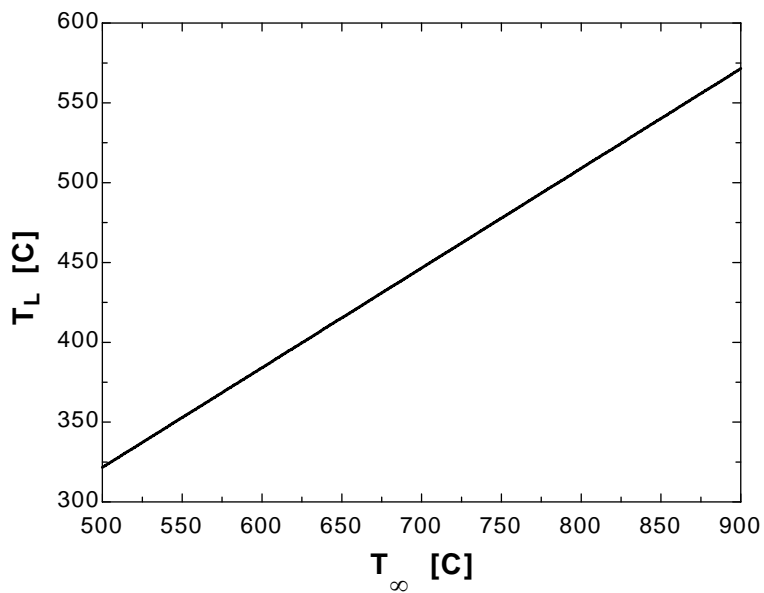

4-41 A long cylindrical shaft at 400°C is allowed to cool slowly. The center temperature and the heat transfer per unit length of the cylinder are to be determined.

Assumptions **1** Heat conduction in the shaft is one-dimensional since it is long and it has thermal symmetry about the center line. **2** The thermal properties of the shaft are constant. **3** The heat transfer coefficient is constant and uniform over the entire surface. **4** The Fourier number is $\tau > 0.2$ so that the one-term approximate solutions (or the transient temperature charts) are applicable (this assumption will be verified).

Properties The properties of stainless steel 304 at room temperature are given to be $k = 14.9 \text{ W/m}\cdot\text{°C}$, $\rho = 7900 \text{ kg/m}^3$, $c_p = 477 \text{ J/kg}\cdot\text{°C}$, $\alpha = 3.95 \times 10^{-6} \text{ m}^2/\text{s}$

Analysis First the Biot number is calculated to be

$$Bi = \frac{hr_o}{k} = \frac{(60 \text{ W/m}^2\cdot\text{°C})(0.175 \text{ m})}{(14.9 \text{ W/m}\cdot\text{°C})} = 0.705$$

Air
 $T_\infty = 150^\circ\text{C}$

The constants λ_1 and A_1 corresponding to this Biot number are, from Table 4-2,

$$\lambda_1 = 1.0904 \quad \text{and} \quad A_1 = 1.1548$$

The Fourier number is

$$\tau = \frac{\alpha t}{L^2} = \frac{(3.95 \times 10^{-6} \text{ m}^2/\text{s})(20 \times 60 \text{ s})}{(0.175 \text{ m})^2} = 0.1548$$

which is very close to the value of 0.2. Therefore, the one-term approximate solution (or the transient temperature charts) can still be used, with the understanding that the error involved will be a little more than 2 percent. Then the temperature at the center of the shaft becomes

$$\theta_{0,cyl} = \frac{T_0 - T_\infty}{T_i - T_\infty} = A_1 e^{-\lambda_1^2 \tau} = (1.1548) e^{-(1.0904)^2 (0.1548)} = 0.9607$$

$$\frac{T_0 - 150}{400 - 150} = 0.9607 \longrightarrow T_0 = \mathbf{390^\circ\text{C}}$$

The maximum heat can be transferred from the cylinder per meter of its length is

$$m = \rho V = \rho \pi r_o^2 L = (7900 \text{ kg/m}^3) [\pi (0.175 \text{ m})^2 (1 \text{ m})] = 760.1 \text{ kg}$$

$$Q_{\max} = mc_p [T_\infty - T_i] = (760.1 \text{ kg})(0.477 \text{ kJ/kg}\cdot\text{°C})(400 - 150)^\circ\text{C} = 90,640 \text{ kJ}$$

Once the constant $J_1 = 0.4679$ is determined from Table 4-3 corresponding to the constant $\lambda_1 = 1.0904$, the actual heat transfer becomes

$$\left(\frac{Q}{Q_{\max}} \right)_{cyl} = 1 - 2 \left(\frac{T_o - T_\infty}{T_i - T_\infty} \right) \frac{J_1(\lambda_1)}{\lambda_1} = 1 - 2 \left(\frac{390 - 150}{400 - 150} \right) \frac{0.4679}{1.0904} = 0.1761$$

$$Q = 0.1761(90,640 \text{ kJ}) = \mathbf{15,960 \text{ kJ}}$$

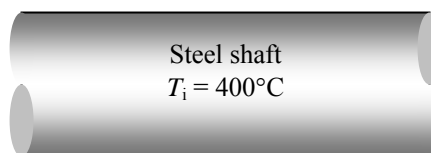

4-42 EES Prob. 4-41 is reconsidered. The effect of the cooling time on the final center temperature of the shaft and the amount of heat transfer is to be investigated.

Analysis The problem is solved using EES, and the solution is given below.

"GIVEN"

$r_o=0.35/2$ [m]
 $T_i=400$ [C]
 $T_{\infty}=150$ [C]
 $h=60$ [W/m²-C]
 $\text{time}=20$ [min]

"PROPERTIES"

$k=14.9$ [W/m-C]
 $\rho=7900$ [kg/m³]
 $C_p=477$ [J/kg-C]
 $\alpha=3.95E-6$ [m²/s]

"ANALYSIS"

$Bi=(h*r_o)/k$

"From Table 4-2 corresponding to this Bi number, we read"

$\lambda_1=1.0935$

$A_1=1.1558$

$J_1=0.4709$ "From Table 4-3, corresponding to λ_1 "

$\tau=(\alpha*\text{time}*Convert(\text{min}, \text{s}))/r_o^2$

$(T_o-T_{\infty})/(T_i-T_{\infty})=A_1*\exp(-\lambda_1^2*\tau)$

$L=1$ "[m], 1 m length of the cylinder is considered"

$V=\pi*r_o^2*L$

$m=\rho*V$

$Q_{\max}=m*C_p*(T_i-T_{\infty})*Convert(\text{J}, \text{kJ})$

$Q/Q_{\max}=1-2*(T_o-T_{\infty})/(T_i-T_{\infty})*J_1/\lambda_1$

time [min]	T_o [C]	Q [kJ]
5	425.9	4491
10	413.4	8386
15	401.5	12105
20	390.1	15656
25	379.3	19046
30	368.9	22283
35	359	25374
40	349.6	28325
45	340.5	31142
50	331.9	33832
55	323.7	36401
60	315.8	38853

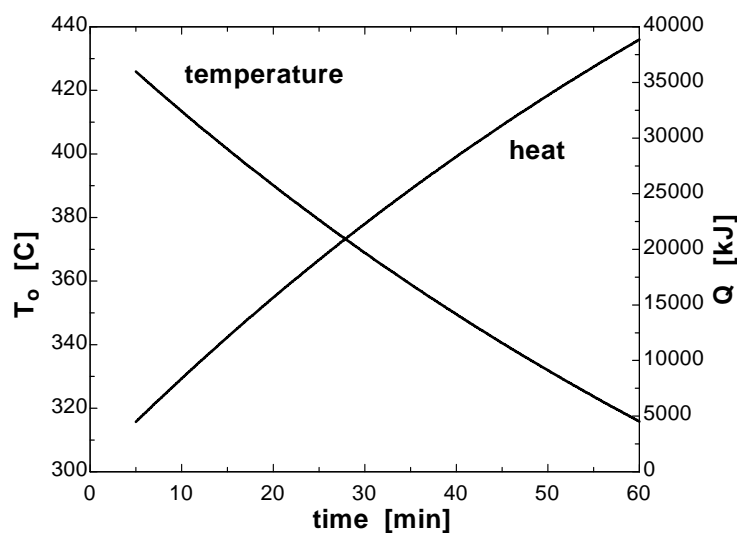

4-43E Long cylindrical steel rods are heat-treated in an oven. Their centerline temperature when they leave the oven is to be determined.

Assumptions 1 Heat conduction in the rods is one-dimensional since the rods are long and they have thermal symmetry about the center line. **2** The thermal properties of the rod are constant. **3** The heat transfer coefficient is constant and uniform over the entire surface. **4** The Fourier number is $\tau > 0.2$ so that the one-term approximate solutions (or the transient temperature charts) are applicable (this assumption will be verified).

Properties The properties of AISI stainless steel rods are given to be $k = 7.74 \text{ Btu/h}\cdot\text{ft}\cdot^\circ\text{F}$, $\alpha = 0.135 \text{ ft}^2/\text{h}$.

Analysis The time the steel rods stays in the oven can be determined from

$$t = \frac{\text{length}}{\text{velocity}} = \frac{21 \text{ ft}}{7 \text{ ft/min}} = 3 \text{ min} = 180 \text{ s}$$

The Biot number is

$$Bi = \frac{hr_o}{k} = \frac{(20 \text{ Btu/h}\cdot\text{ft}^2\cdot^\circ\text{F})(2/12 \text{ ft})}{(7.74 \text{ Btu/h}\cdot\text{ft}\cdot^\circ\text{F})} = 0.4307$$

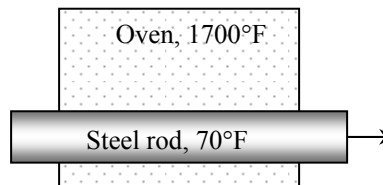

The constants λ_1 and A_1 corresponding to this Biot number are, from Table 4-2,

$$\lambda_1 = 0.8790 \quad \text{and} \quad A_1 = 1.0996$$

The Fourier number is

$$\tau = \frac{\alpha t}{r_o^2} = \frac{(0.135 \text{ ft}^2/\text{h})(3/60 \text{ h})}{(2/12 \text{ ft})^2} = 0.243$$

Then the temperature at the center of the rods becomes

$$\theta_{0,\text{cyl}} = \frac{T_0 - T_\infty}{T_i - T_\infty} = A_1 e^{-\lambda_1^2 \tau} = (1.0996)e^{-(0.8790)^2(0.243)} = 0.911$$

$$\frac{T_0 - 1700}{70 - 1700} = 0.911 \longrightarrow T_0 = \mathbf{215^\circ\text{F}}$$

4-44 Steaks are cooled by passing them through a refrigeration room. The time of cooling is to be determined.

Assumptions 1 Heat conduction in the steaks is one-dimensional since the steaks are large relative to their thickness and there is thermal symmetry about the center plane. **3** The thermal properties of the steaks are constant. **4** The heat transfer coefficient is constant and uniform over the entire surface. **5** The Fourier number is $\tau > 0.2$ so that the one-term approximate solutions (or the transient temperature charts) are applicable (this assumption will be verified).

Properties The properties of steaks are given to be $k = 0.45 \text{ W/m}\cdot\text{°C}$ and $\alpha = 0.91 \times 10^{-7} \text{ m}^2/\text{s}$

Analysis The Biot number is

$$Bi = \frac{hL}{k} = \frac{(9 \text{ W/m}^2 \cdot \text{°C})(0.01 \text{ m})}{(0.45 \text{ W/m}\cdot\text{°C})} = 0.200$$

The constants λ_1 and A_1 corresponding to this Biot number are, from Table 4-2,

$$\lambda_1 = 0.4328 \quad \text{and} \quad A_1 = 1.0311$$

The Fourier number is

$$\frac{T(L, t) - T_\infty}{T_i - T_\infty} = A_1 e^{-\lambda_1^2 \tau} \cos(\lambda_1 L / L)$$

$$\frac{2 - (-11)}{25 - (-11)} = (1.0311) e^{-(0.4328)^2 \tau} \cos(0.4328) \longrightarrow \tau = 5.085 > 0.2$$

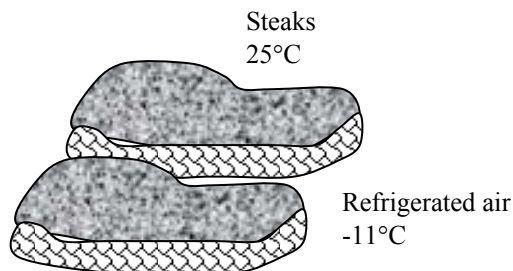

Therefore, the one-term approximate solution (or the transient temperature charts) is applicable. Then the length of time for the steaks to be kept in the refrigerator is determined to be

$$t = \frac{\tau L^2}{\alpha} = \frac{(5.085)(0.01 \text{ m})^2}{0.91 \times 10^{-7} \text{ m}^2/\text{s}} = 5590 \text{ s} = \mathbf{93.1 \text{ min}}$$

4-45 A long cylindrical wood log is exposed to hot gases in a fireplace. The time for the ignition of the wood is to be determined.

Assumptions 1 Heat conduction in the wood is one-dimensional since it is long and it has thermal symmetry about the center line. 2 The thermal properties of the wood are constant. 3 The heat transfer coefficient is constant and uniform over the entire surface. 4 The Fourier number is $\tau > 0.2$ so that the one-term approximate solutions (or the transient temperature charts) are applicable (this assumption will be verified).

Properties The properties of wood are given to be $k = 0.17 \text{ W/m}\cdot^\circ\text{C}$, $\alpha = 1.28 \times 10^{-7} \text{ m}^2/\text{s}$

Analysis The Biot number is

$$Bi = \frac{hr_o}{k} = \frac{(13.6 \text{ W/m}^2\cdot^\circ\text{C})(0.05 \text{ m})}{(0.17 \text{ W/m}\cdot^\circ\text{C})} = 4.00$$

The constants λ_1 and A_1 corresponding to this Biot number are, from Table 4-2,

$$\lambda_1 = 1.9081 \quad \text{and} \quad A_1 = 1.4698$$

Once the constant J_0 is determined from Table 4-3 corresponding to the constant $\lambda_1 = 1.9081$, the Fourier number is determined to be

$$\frac{T(r_o, t) - T_\infty}{T_i - T_\infty} = A_1 e^{-\lambda_1^2 \tau} J_0(\lambda_1 r_o / r_o)$$

$$\frac{420 - 550}{15 - 550} = (1.4698) e^{-(1.9081)^2 \tau} (0.2771) \longrightarrow \tau = 0.142$$

which is not above the value of 0.2 but it is close. We use one-term approximate solution (or the transient temperature charts) knowing that the result may be somewhat in error. Then the length of time before the log ignites is

$$t = \frac{\tau r_o^2}{\alpha} = \frac{(0.142)(0.05 \text{ m})^2}{(1.28 \times 10^{-7} \text{ m}^2/\text{s})} = 2770 \text{ s} = \mathbf{46.2 \text{ min}}$$

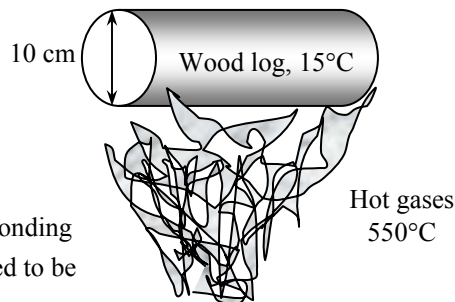

4-46 A rib is roasted in an oven. The heat transfer coefficient at the surface of the rib, the temperature of the outer surface of the rib and the amount of heat transfer when it is rare done are to be determined. The time it will take to roast this rib to medium level is also to be determined.

Assumptions 1 The rib is a homogeneous spherical object. **2** Heat conduction in the rib is one-dimensional because of symmetry about the midpoint. **3** The thermal properties of the rib are constant. **4** The heat transfer coefficient is constant and uniform over the entire surface. **5** The Fourier number is $\tau > 0.2$ so that the one-term approximate solutions (or the transient temperature charts) are applicable (this assumption will be verified).

Properties The properties of the rib are given to be $k = 0.45 \text{ W/m}\cdot\text{C}$, $\rho = 1200 \text{ kg/m}^3$, $c_p = 4.1 \text{ kJ/kg}\cdot\text{C}$, and $\alpha = 0.91 \times 10^{-7} \text{ m}^2/\text{s}$.

Analysis (a) The radius of the roast is determined to be

$$m = \rho V \longrightarrow V = \frac{m}{\rho} = \frac{3.2 \text{ kg}}{1200 \text{ kg/m}^3} = 0.002667 \text{ m}^3$$

$$V = \frac{4}{3} \pi r_o^3 \longrightarrow r_o = \sqrt[3]{\frac{3V}{4\pi}} = \sqrt[3]{\frac{3(0.002667 \text{ m}^3)}{4\pi}} = 0.08603 \text{ m}$$

The Fourier number is

$$\tau = \frac{\alpha t}{r_o^2} = \frac{(0.91 \times 10^{-7} \text{ m}^2/\text{s})(2 \times 3600 + 45 \times 60) \text{ s}}{(0.08603 \text{ m})^2} = 0.1217$$

which is somewhat below the value of 0.2. Therefore, the one-term approximate solution (or the transient temperature charts) can still be used, with the understanding that the error involved will be a little more than 2 percent. Then the one-term solution can be written in the form

$$\theta_{0,sph} = \frac{T_0 - T_\infty}{T_i - T_\infty} = A_1 e^{-\lambda_1^2 \tau} \longrightarrow \frac{60 - 163}{4.5 - 163} = 0.65 = A_1 e^{-\lambda_1^2 (0.1217)}$$

It is determined from Table 4-2 by trial and error that this equation is satisfied when $Bi = 30$, which corresponds to $\lambda_1 = 3.0372$ and $A_1 = 1.9898$. Then the heat transfer coefficient can be determined from

$$Bi = \frac{hr_o}{k} \longrightarrow h = \frac{kBi}{r_o} = \frac{(0.45 \text{ W/m}\cdot\text{C})(30)}{(0.08603 \text{ m})} = \mathbf{156.9 \text{ W/m}^2\cdot\text{C}}$$

This value seems to be larger than expected for problems of this kind. This is probably due to the Fourier number being less than 0.2.

(b) The temperature at the surface of the rib is

$$\theta(r_o, t)_{sph} = \frac{T(r_o, t) - T_\infty}{T_i - T_\infty} = A_1 e^{-\lambda_1^2 \tau} \frac{\sin(\lambda_1 r_o / r_o)}{\lambda_1 r_o / r_o} = (1.9898) e^{-(3.0372)^2 (0.1217)} \frac{\sin(3.0372 \text{ rad})}{3.0372}$$

$$\frac{T(r_o, t) - 163}{4.5 - 163} = 0.0222 \longrightarrow T(r_o, t) = \mathbf{159.5 \text{ C}}$$

(c) The maximum possible heat transfer is

$$Q_{\max} = mc_p (T_\infty - T_i) = (3.2 \text{ kg})(4.1 \text{ kJ/kg}\cdot\text{C})(163 - 4.5)^\circ\text{C} = 2080 \text{ kJ}$$

Then the actual amount of heat transfer becomes

$$\frac{Q}{Q_{\max}} = 1 - 3\theta_{0,sph} \frac{\sin(\lambda_1) - \lambda_1 \cos(\lambda_1)}{\lambda_1^3} = 1 - 3(0.65) \frac{\sin(3.0372) - (3.0372) \cos(3.0372)}{(3.0372)^3} = 0.783$$

$$Q = 0.783 Q_{\max} = (0.783)(2080 \text{ kJ}) = \mathbf{1629 \text{ kJ}}$$

(d) The cooking time for medium-done rib is determined to be

$$\theta_{0,sph} = \frac{T_0 - T_\infty}{T_i - T_\infty} = A_1 e^{-\lambda_1^2 \tau} \longrightarrow \frac{71 - 163}{4.5 - 163} = (1.9898) e^{-(3.0372)^2 \tau} \longrightarrow \tau = 0.1336$$

$$t = \frac{\tau r_o^2}{\alpha} = \frac{(0.1336)(0.08603 \text{ m})^2}{(0.91 \times 10^{-7} \text{ m}^2/\text{s})} = 10,866 \text{ s} = 181 \text{ min} \cong \mathbf{3 \text{ hr}}$$

This result is close to the listed value of 3 hours and 20 minutes. The difference between the two results is due to the Fourier number being less than 0.2 and thus the error in the one-term approximation.

Discussion The temperature of the outer parts of the rib is greater than that of the inner parts of the rib after it is taken out of the oven. Therefore, there will be a heat transfer from outer parts of the rib to the inner parts as a result of this temperature difference. The recommendation is logical.

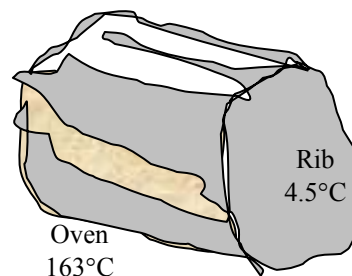

4-47 A rib is roasted in an oven. The heat transfer coefficient at the surface of the rib, the temperature of the outer surface of the rib and the amount of heat transfer when it is well-done are to be determined. The time it will take to roast this rib to medium level is also to be determined.

Assumptions 1 The rib is a homogeneous spherical object. **2** Heat conduction in the rib is one-dimensional because of symmetry about the midpoint. **3** The thermal properties of the rib are constant. **4** The heat transfer coefficient is constant and uniform over the entire surface. **5** The Fourier number is $\tau > 0.2$ so that the one-term approximate solutions (or the transient temperature charts) are applicable (this assumption will be verified).

Properties The properties of the rib are given to be $k = 0.45 \text{ W/m}\cdot\text{°C}$, $\rho = 1200 \text{ kg/m}^3$, $c_p = 4.1 \text{ kJ/kg}\cdot\text{°C}$, and $\alpha = 0.91 \times 10^{-7} \text{ m}^2/\text{s}$

Analysis (a) The radius of the rib is determined to be

$$m = \rho V \longrightarrow V = \frac{m}{\rho} = \frac{3.2 \text{ kg}}{1200 \text{ kg/m}^3} = 0.00267 \text{ m}^3$$

$$V = \frac{4}{3} \pi r_o^3 \longrightarrow r_o = \sqrt[3]{\frac{3V}{4\pi}} = \sqrt[3]{\frac{3(0.00267 \text{ m}^3)}{4\pi}} = 0.08603 \text{ m}$$

The Fourier number is

$$\tau = \frac{\alpha t}{r_o^2} = \frac{(0.91 \times 10^{-7} \text{ m}^2/\text{s})(4 \times 3600 + 15 \times 60) \text{ s}}{(0.08603 \text{ m})^2} = 0.1881$$

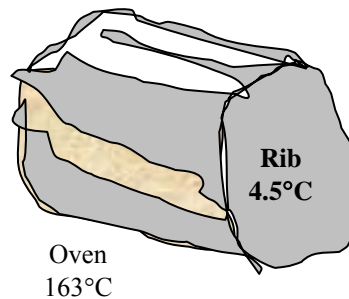

which is somewhat below the value of 0.2. Therefore, the one-term approximate solution (or the transient temperature charts) can still be used, with the understanding that the error involved will be a little more than 2 percent. Then the one-term solution formulation can be written in the form

$$\theta_{0,sph} = \frac{T_0 - T_\infty}{T_i - T_\infty} = A_1 e^{-\lambda_1^2 \tau} \longrightarrow \frac{77 - 163}{4.5 - 163} = 0.543 = A_1 e^{-\lambda_1^2 (0.1881)}$$

It is determined from Table 4-2 by trial and error that this equation is satisfied when $Bi = 4.3$, which corresponds to $\lambda_1 = 2.4900$ and $A_1 = 1.7402$. Then the heat transfer coefficient can be determined from.

$$Bi = \frac{hr_o}{k} \longrightarrow h = \frac{kBi}{r_o} = \frac{(0.45 \text{ W/m}\cdot\text{°C})(4.3)}{(0.08603 \text{ m})} = \mathbf{22.5 \text{ W/m}^2 \cdot \text{°C}}$$

(b) The temperature at the surface of the rib is

$$\theta(r_o, t)_{sph} = \frac{T(r_o, t) - T_\infty}{T_i - T_\infty} = A_1 e^{-\lambda_1^2 \tau} \frac{\sin(\lambda_1 r_o / r_o)}{\lambda_1 r_o / r_o} = (1.7402) e^{-(2.49)^2 (0.1881)} \frac{\sin(2.49)}{2.49}$$

$$\frac{T(r_o, t) - 163}{4.5 - 163} = 0.132 \longrightarrow T(r_o, t) = \mathbf{142.1 \text{ °C}}$$

(c) The maximum possible heat transfer is

$$Q_{\max} = mc_p (T_\infty - T_i) = (3.2 \text{ kg})(4.1 \text{ kJ/kg}\cdot\text{°C})(163 - 4.5) \text{ °C} = 2080 \text{ kJ}$$

Then the actual amount of heat transfer becomes

$$\frac{Q}{Q_{\max}} = 1 - 3\theta_{0,sph} \frac{\sin(\lambda_1) - \lambda_1 \cos(\lambda_1)}{\lambda_1^3} = 1 - 3(0.543) \frac{\sin(2.49) - (2.49) \cos(2.49)}{(2.49)^3} = 0.727$$

$$Q = 0.727 Q_{\max} = (0.727)(2080 \text{ kJ}) = \mathbf{1512 \text{ kJ}}$$

(d) The cooking time for medium-done rib is determined to be

$$\theta_{0,sph} = \frac{T_0 - T_\infty}{T_i - T_\infty} = A_1 e^{-\lambda_1^2 \tau} \longrightarrow \frac{71 - 163}{4.5 - 163} = (1.7402) e^{-(2.49)^2 \tau} \longrightarrow \tau = 0.177$$

$$t = \frac{\tau r_o^2}{\alpha} = \frac{(0.177)(0.08603 \text{ m})^2}{(0.91 \times 10^{-7} \text{ m}^2/\text{s})} = 14,400 \text{ s} = 240 \text{ min} = \mathbf{4 \text{ hr}}$$

This result is close to the listed value of 4 hours and 15 minutes. The difference between the two results is probably due to the Fourier number being less than 0.2 and thus the error in the one-term approximation.

Discussion The temperature of the outer parts of the rib is greater than that of the inner parts of the rib after it is taken out of the oven. Therefore, there will be a heat transfer from outer parts of the rib to the inner parts as a result of this temperature difference. The recommendation is logical.

4-48 An egg is dropped into boiling water. The cooking time of the egg is to be determined.

Assumptions **1** The egg is spherical in shape with a radius of $r_0 = 2.75$ cm. **2** Heat conduction in the egg is one-dimensional because of symmetry about the midpoint. **3** The thermal properties of the egg are constant. **4** The heat transfer coefficient is constant and uniform over the entire surface. **5** The Fourier number is $\tau > 0.2$ so that the one-term approximate solutions (or the transient temperature charts) are applicable (this assumption will be verified).

Properties The thermal conductivity and diffusivity of the eggs can be approximated by those of water at room temperature to be $k = 0.607$ W/m \cdot °C, $\alpha = k / \rho c_p = 0.146 \times 10^{-6}$ m²/s (Table A-9).

Analysis The Biot number is

$$Bi = \frac{hr_o}{k} = \frac{(800 \text{ W/m}^2 \cdot \text{°C})(0.0275 \text{ m})}{(0.607 \text{ W/m} \cdot \text{°C})} = 36.2$$

The constants λ_1 and A_1 corresponding to this Biot number are, from Table 4-2,

$$\lambda_1 = 3.0533 \quad \text{and} \quad A_1 = 1.9925$$

Then the Fourier number and the time period become

$$\theta_{0,sph} = \frac{T_0 - T_\infty}{T_i - T_\infty} = A_1 e^{-\lambda_1^2 \tau} \longrightarrow \frac{60 - 100}{8 - 100} = (1.9925) e^{-(3.0533)^2 \tau} \longrightarrow \tau = 0.1633$$

which is somewhat below the value of 0.2. Therefore, the one-term approximate solution (or the transient temperature charts) can still be used, with the understanding that the error involved will be a little more than 2 percent. Then the length of time for the egg to be kept in boiling water is determined to be

$$t = \frac{\tau_o^2}{\alpha} = \frac{(0.1633)(0.0275 \text{ m})^2}{0.146 \times 10^{-6} \text{ m}^2/\text{s}} = 846 \text{ s} = \mathbf{14.1 \text{ min}}$$

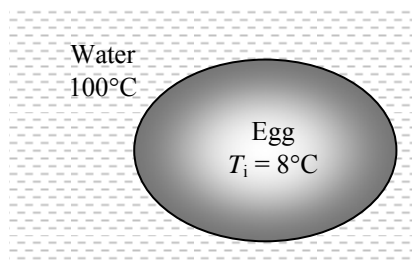

4-49 An egg is cooked in boiling water. The cooking time of the egg is to be determined for a location at 1610-m elevation.

Assumptions 1 The egg is spherical in shape with a radius of $r_o = 2.75$ cm. **2** Heat conduction in the egg is one-dimensional because of symmetry about the midpoint. **3** The thermal properties of the egg and heat transfer coefficient are constant. **4** The heat transfer coefficient is constant and uniform over the entire surface. **5** The Fourier number is $\tau > 0.2$ so that the one-term approximate solutions (or the transient temperature charts) are applicable (this assumption will be verified).

Properties The thermal conductivity and diffusivity of the eggs can be approximated by those of water at room temperature to be $k = 0.607$ W/m \cdot °C, $\alpha = k / \rho c_p = 0.146 \times 10^{-6}$ m²/s (Table A-9).

Analysis The Biot number is

$$Bi = \frac{hr_o}{k} = \frac{(800 \text{ W/m}^2 \cdot \text{°C})(0.0275 \text{ m})}{(0.607 \text{ W/m} \cdot \text{°C})} = 36.2$$

The constants λ_1 and A_1 corresponding to this Biot number are, from Table 4-2,

$$\lambda_1 = 3.0533 \quad \text{and} \quad A_1 = 1.9925$$

Then the Fourier number and the time period become

$$\theta_{0,sph} = \frac{T_0 - T_\infty}{T_i - T_\infty} = A_1 e^{-\lambda_1^2 \tau} \longrightarrow \frac{60 - 94.4}{8 - 94.4} = (1.9925) e^{-(3.0533)^2 \tau} \longrightarrow \tau = 0.1727$$

which is somewhat below the value of 0.2. Therefore, the one-term approximate solution (or the transient temperature charts) can still be used, with the understanding that the error involved will be a little more than 2 percent. Then the length of time for the egg to be kept in boiling water is determined to be

$$t = \frac{\tau r_o^2}{\alpha} = \frac{(0.1727)(0.0275 \text{ m})^2}{(0.146 \times 10^{-6} \text{ m}^2/\text{s})} = 895 \text{ s} = \mathbf{14.9 \text{ min}}$$

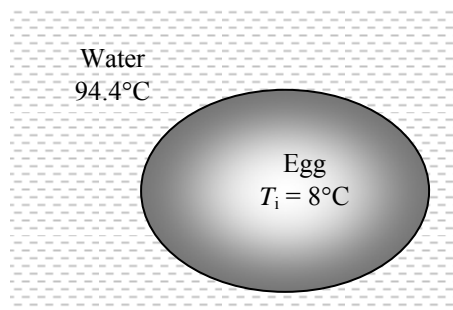

4-50 A hot dog is dropped into boiling water, and temperature measurements are taken at certain time intervals. The thermal diffusivity and thermal conductivity of the hot dog and the convection heat transfer coefficient are to be determined.

Assumptions **1** Heat conduction in the hot dog is one-dimensional since it is long and it has thermal symmetry about the centerline. **2** The thermal properties of the hot dog are constant. **3** The heat transfer coefficient is constant and uniform over the entire surface. **4** The Fourier number is $\tau > 0.2$ so that the one-term approximate solutions (or the transient temperature charts) are applicable (this assumption will be verified).

Properties The properties of hot dog available are given to be $\rho = 980 \text{ kg/m}^3$ and $c_p = 3900 \text{ J/kg}\cdot^\circ\text{C}$.

Analysis (a) From Fig. 4-16b we have

$$\left. \begin{aligned} \frac{T - T_\infty}{T_0 - T_\infty} &= \frac{88 - 94}{59 - 94} = 0.17 \\ \frac{r}{r_o} &= \frac{r_o}{r_o} = 1 \end{aligned} \right\} \frac{1}{Bi} = \frac{k}{hr_o} = 0.15$$

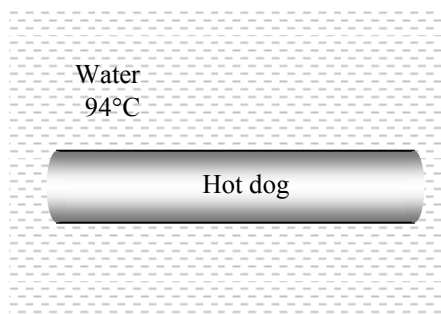

The Fourier number is determined from Fig. 4-16a to be

$$\left. \begin{aligned} \frac{1}{Bi} &= \frac{k}{hr_o} = 0.15 \\ \frac{T_0 - T_\infty}{T_i - T_\infty} &= \frac{59 - 94}{20 - 94} = 0.47 \end{aligned} \right\} \tau = \frac{\alpha t}{r_o^2} = 0.20$$

The thermal diffusivity of the hot dog is determined to be

$$\frac{\alpha t}{r_o^2} = 0.20 \longrightarrow \alpha = \frac{0.2r_o^2}{t} = \frac{(0.2)(0.011 \text{ m})^2}{120 \text{ s}} = \mathbf{2.017 \times 10^{-7} \text{ m}^2/\text{s}}$$

(b) The thermal conductivity of the hot dog is determined from

$$k = \alpha \rho c_p = (2.017 \times 10^{-7} \text{ m}^2/\text{s})(980 \text{ kg/m}^3)(3900 \text{ J/kg}\cdot^\circ\text{C}) = \mathbf{0.771 \text{ W/m}\cdot^\circ\text{C}}$$

(c) From part (a) we have $\frac{1}{Bi} = \frac{k}{hr_o} = 0.15$. Then,

$$\frac{k}{h} = 0.15r_o = (0.15)(0.011 \text{ m}) = 0.00165 \text{ m}$$

Therefore, the heat transfer coefficient is

$$\frac{k}{h} = 0.00165 \longrightarrow h = \frac{0.771 \text{ W/m}\cdot^\circ\text{C}}{0.00165 \text{ m}} = \mathbf{467 \text{ W/m}^2\cdot^\circ\text{C}}$$

4-51 Using the data and the answers given in Prob. 4-50, the center and the surface temperatures of the hot dog 4 min after the start of the cooking and the amount of heat transferred to the hot dog are to be determined.

Assumptions **1** Heat conduction in the hot dog is one-dimensional since it is long and it has thermal symmetry about the center line. **2** The thermal properties of the hot dog are constant. **3** The heat transfer coefficient is constant and uniform over the entire surface. **4** The Fourier number is $\tau > 0.2$ so that the one-term approximate solutions (or the transient temperature charts) are applicable (this assumption will be verified).

Properties The properties of hot dog and the convection heat transfer coefficient are given or obtained in P4-47 to be $k = 0.771 \text{ W/m}\cdot\text{C}$, $\rho = 980 \text{ kg/m}^3$, $c_p = 3900 \text{ J/kg}\cdot\text{C}$, $\alpha = 2.017 \times 10^{-7} \text{ m}^2/\text{s}$, and $h = 467 \text{ W/m}^2\cdot\text{C}$.

Analysis The Biot number is

$$Bi = \frac{hr_o}{k} = \frac{(467 \text{ W/m}^2\cdot\text{C})(0.011 \text{ m})}{(0.771 \text{ W/m}\cdot\text{C})} = 6.66$$

The constants λ_1 and A_1 corresponding to this Biot number are, from Table 4-2,

$$\lambda_1 = 2.0785 \quad \text{and} \quad A_1 = 1.5357$$

The Fourier number is

$$\tau = \frac{\alpha t}{L^2} = \frac{(2.017 \times 10^{-7} \text{ m}^2/\text{s})(4 \text{ min} \times 60 \text{ s/min})}{(0.011 \text{ m})^2} = 0.4001 > 0.2$$

Then the temperature at the center of the hot dog is determined to be

$$\theta_{0,cyl} = \frac{T_0 - T_\infty}{T_i - T_\infty} = A_1 e^{-\lambda_1^2 \tau} = (1.5357) e^{-(2.0785)^2 (0.4001)} = 0.2727$$

$$\frac{T_0 - 94}{20 - 94} = 0.2727 \longrightarrow T_0 = \mathbf{73.8^\circ\text{C}}$$

From Table 4-3 we read $J_0 = 0.1789$ corresponding to the constant $\lambda_1 = 2.0785$. Then the temperature at the surface of the hot dog becomes

$$\frac{T(r_o, t) - T_\infty}{T_i - T_\infty} = A_1 e^{-\lambda_1^2 \tau} J_0(\lambda_1 r_o / r_o) = (1.5357) e^{-(2.0785)^2 (0.4001)} (0.1789) = 0.04878$$

$$\frac{T(r_o, t) - 94}{20 - 94} = 0.04878 \longrightarrow T(r_o, t) = \mathbf{90.4^\circ\text{C}}$$

The maximum possible amount of heat transfer is

$$m = \rho V = \rho \pi r_o^2 L = (980 \text{ kg/m}^3) [\pi (0.011 \text{ m})^2 (0.125 \text{ m})] = 0.04657 \text{ kg}$$

$$Q_{\max} = mc_p (T_i - T_\infty) = (0.04657 \text{ kg})(3900 \text{ J/kg}\cdot\text{C})(94 - 20)^\circ\text{C} = 13,440 \text{ J}$$

From Table 4-3 we read $J_1 = 0.5701$ corresponding to the constant $\lambda_1 = 2.0785$. Then the actual heat transfer becomes

$$\left(\frac{Q}{Q_{\max}} \right)_{cyl} = 1 - 2\theta_{0,cyl} \frac{J_1(\lambda_1)}{\lambda_1} = 1 - 2(0.2727) \frac{0.5701}{2.0785} = 0.8504$$

$$Q = 0.8504(13,440 \text{ kJ}) = \mathbf{11,430 \text{ kJ}}$$

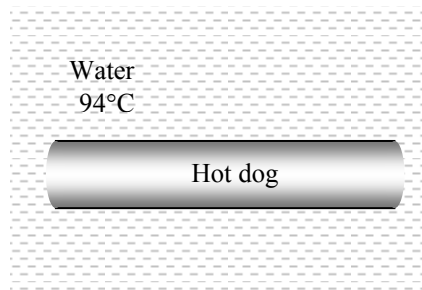

4-52E Whole chickens are to be cooled in the racks of a large refrigerator. Heat transfer coefficient that will enable to meet temperature constraints of the chickens while keeping the refrigeration time to a minimum is to be determined.

Assumptions **1** The chicken is a homogeneous spherical object. **2** Heat conduction in the chicken is one-dimensional because of symmetry about the midpoint. **3** The thermal properties of the chicken are constant. **4** The heat transfer coefficient is constant and uniform over the entire surface. **5** The Fourier number is $\tau > 0.2$ so that the one-term approximate solutions (or the transient temperature charts) are applicable (this assumption will be verified).

Properties The properties of the chicken are given to be $k = 0.26 \text{ Btu/h}\cdot\text{ft}\cdot^\circ\text{F}$, $\rho = 74.9 \text{ lbm/ft}^3$, $c_p = 0.98 \text{ Btu/lbm}\cdot^\circ\text{F}$, and $\alpha = 0.0035 \text{ ft}^2/\text{h}$.

Analysis The radius of the chicken is determined to be

$$m = \rho V \longrightarrow V = \frac{m}{\rho} = \frac{5 \text{ lbm}}{74.9 \text{ lbm/ft}^3} = 0.06676 \text{ ft}^3$$

$$V = \frac{4}{3}\pi r_o^3 \longrightarrow r_o = \sqrt[3]{\frac{3V}{4\pi}} = \sqrt[3]{\frac{3(0.06676 \text{ ft}^3)}{4\pi}} = 0.2517 \text{ ft}$$

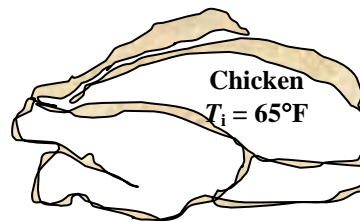

From Fig. 4-17b we have

$$\left. \begin{aligned} \frac{T - T_\infty}{T_0 - T_\infty} &= \frac{35 - 5}{45 - 5} = 0.75 \\ \frac{x}{r_o} &= \frac{r_o}{r_o} = 1 \end{aligned} \right\} \frac{1}{Bi} = \frac{k}{hr_o} = 2$$

Then the heat transfer coefficients becomes

$$h = \frac{k}{2r_o} = \frac{0.26 \text{ Btu/ft}\cdot^\circ\text{F}}{2(0.2517 \text{ ft})} = \mathbf{0.516 \text{ Btu/h}\cdot\text{ft}^2\cdot^\circ\text{F}}$$

4-53 A person puts apples into the freezer to cool them quickly. The center and surface temperatures of the apples, and the amount of heat transfer from each apple in 1 h are to be determined.

Assumptions 1 The apples are spherical in shape with a diameter of 9 cm. **2** Heat conduction in the apples is one-dimensional because of symmetry about the midpoint. **3** The thermal properties of the apples are constant. **4** The heat transfer coefficient is constant and uniform over the entire surface. **5** The Fourier number is $\tau > 0.2$ so that the one-term approximate solutions (or the transient temperature charts) are applicable (this assumption will be verified).

Properties The properties of the apples are given to be $k = 0.418 \text{ W/m}\cdot^\circ\text{C}$, $\rho = 840 \text{ kg/m}^3$, $c_p = 3.81 \text{ kJ/kg}\cdot^\circ\text{C}$, and $\alpha = 1.3 \times 10^{-7} \text{ m}^2/\text{s}$.

Analysis The Biot number is

$$Bi = \frac{hr_o}{k} = \frac{(8 \text{ W/m}^2\cdot^\circ\text{C})(0.045 \text{ m})}{(0.418 \text{ W/m}\cdot^\circ\text{C})} = 0.861$$

The constants λ_1 and A_1 corresponding to this Biot number are, from Table 4-2,

$$\lambda_1 = 1.476 \quad \text{and} \quad A_1 = 1.2390$$

The Fourier number is

$$\tau = \frac{\alpha t}{r_o^2} = \frac{(1.3 \times 10^{-7} \text{ m}^2/\text{s})(1 \text{ h} \times 3600 \text{ s/h})}{(0.045 \text{ m})^2} = 0.231 > 0.2$$

Then the temperature at the center of the apples becomes

$$\theta_{0,sph} = \frac{T_0 - T_\infty}{T_i - T_\infty} = A_1 e^{-\lambda_1^2 \tau} \longrightarrow \frac{T_0 - (-15)}{20 - (-15)} = (1.239) e^{-(1.476)^2 (0.231)} = 0.749 \longrightarrow T_0 = \mathbf{11.2^\circ\text{C}}$$

The temperature at the surface of the apples is

$$\theta(r_o, t)_{sph} = \frac{T(r_o, t) - T_\infty}{T_i - T_\infty} = A_1 e^{-\lambda_1^2 \tau} \frac{\sin(\lambda_1 r_o / r_o)}{\lambda_1 r_o / r_o} = (1.239) e^{-(1.476)^2 (0.231)} \frac{\sin(1.476 \text{ rad})}{1.476} = 0.505$$

$$\frac{T(r_o, t) - (-15)}{20 - (-15)} = 0.505 \longrightarrow T(r_o, t) = \mathbf{2.7^\circ\text{C}}$$

The maximum possible heat transfer is

$$m = \rho V = \rho \frac{4}{3} \pi r_o^3 = (840 \text{ kg/m}^3) \left[\frac{4}{3} \pi (0.045 \text{ m})^3 \right] = 0.3206 \text{ kg}$$

$$Q_{\max} = mc_p (T_i - T_\infty) = (0.3206 \text{ kg})(3.81 \text{ kJ/kg}\cdot^\circ\text{C})[20 - (-15)]^\circ\text{C} = 42.75 \text{ kJ}$$

Then the actual amount of heat transfer becomes

$$\frac{Q}{Q_{\max}} = 1 - 3\theta_{0,sph} \frac{\sin(\lambda_1) - \lambda_1 \cos(\lambda_1)}{\lambda_1^3} = 1 - 3(0.749) \frac{\sin(1.476 \text{ rad}) - (1.476) \cos(1.476 \text{ rad})}{(1.476)^3} = 0.402$$

$$Q = 0.402 Q_{\max} = (0.402)(42.75 \text{ kJ}) = \mathbf{17.2 \text{ kJ}}$$

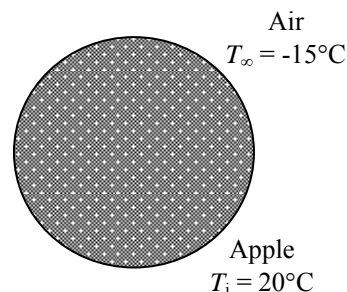

4-54 EES Prob. 4-53 is reconsidered. The effect of the initial temperature of the apples on the final center and surface temperatures and the amount of heat transfer is to be investigated.

Analysis The problem is solved using EES, and the solution is given below.

"GIVEN"

T_infinity=-15 [C]
 T_i=20 [C]
 h=8 [W/m^2-C]
 r_o=0.09/2 [m]
 time=1*3600 [s]

"PROPERTIES"

k=0.513 [W/m-C]
 rho=840 [kg/m^3]
 C_p=3.6 [kJ/kg-C]
 alpha=1.3E-7 [m^2/s]

"ANALYSIS"

Bi=(h*r_o)/k

"From Table 4-2 corresponding to this Bi number, we read"

lambda_1=1.3525

A_1=1.1978

tau=(alpha*time)/r_o^2

(T_o-T_infinity)/(T_i-T_infinity)=A_1*exp(-lambda_1^2*tau)

(T_r-T_infinity)/(T_i-T_infinity)=A_1*exp(-lambda_1^2*tau)*Sin(lambda_1*r_o/r_o)/(lambda_1*r_o/r_o)

V=4/3*pi*r_o^3

m=rho*V

Q_max=m*C_p*(T_i-T_infinity)

Q/Q_max=1-3*(T_o-T_infinity)/(T_i-T_infinity)*(Sin(lambda_1)-lambda_1*Cos(lambda_1))/lambda_1^3

T _i [C]	T _o [C]	T _r [C]	Q [kJ]
2	-1.658	-5.369	6.861
4	-0.08803	-4.236	7.668
6	1.482	-3.103	8.476
8	3.051	-1.97	9.283
10	4.621	-0.8371	10.09
12	6.191	0.296	10.9
14	7.76	1.429	11.7
16	9.33	2.562	12.51
18	10.9	3.695	13.32
20	12.47	4.828	14.13
22	14.04	5.961	14.93
24	15.61	7.094	15.74
26	17.18	8.227	16.55
28	18.75	9.36	17.35
30	20.32	10.49	18.16

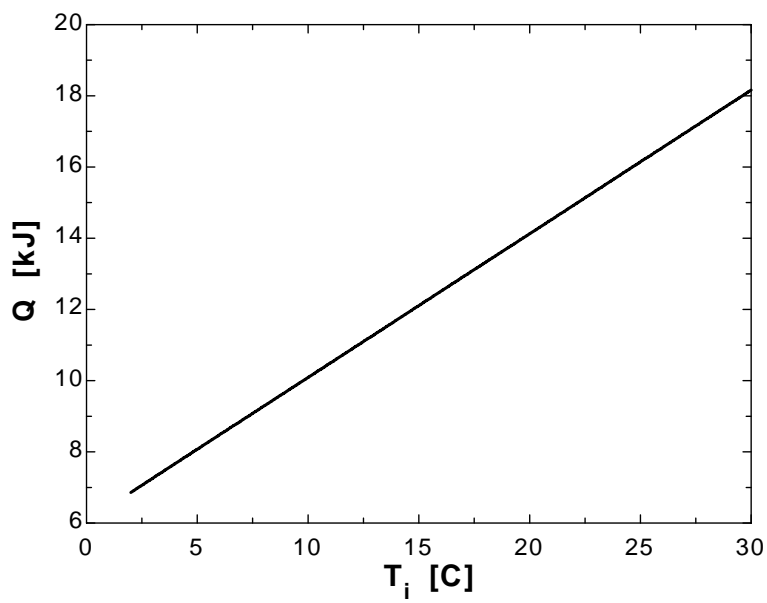
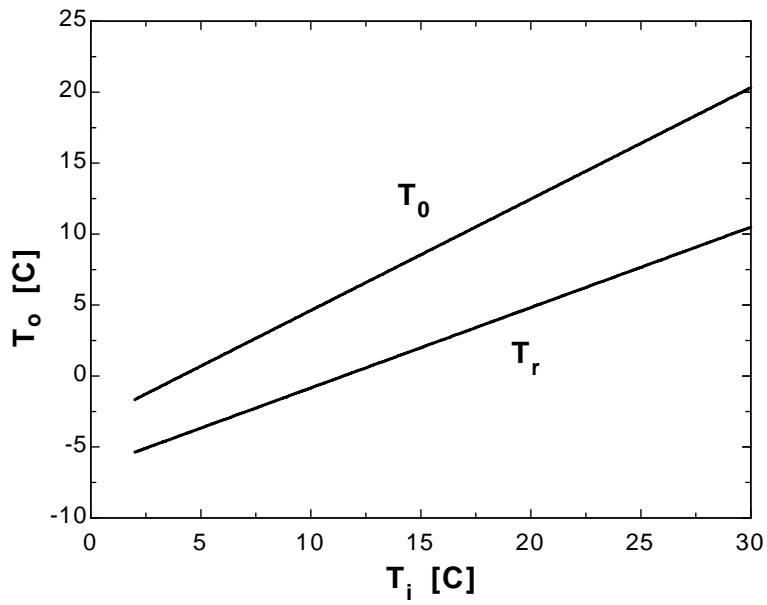

4-55 An orange is exposed to very cold ambient air. It is to be determined whether the orange will freeze in 4 h in subfreezing temperatures.

Assumptions **1** The orange is spherical in shape with a diameter of 8 cm. **2** Heat conduction in the orange is one-dimensional because of symmetry about the midpoint. **3** The thermal properties of the orange are constant, and are those of water. **4** The heat transfer coefficient is constant and uniform over the entire surface. **5** The Fourier number is $\tau > 0.2$ so that the one-term approximate solutions (or the transient temperature charts) are applicable (this assumption will be verified).

Properties The properties of the orange are approximated by those of water at the average temperature of about 5°C, $k = 0.571 \text{ W/m}\cdot\text{°C}$ and $\alpha = k / \rho c_p = 0.571 / (999.9 \times 4205) = 0.136 \times 10^{-6} \text{ m}^2/\text{s}$ (Table A-9).

Analysis The Biot number is

$$Bi = \frac{hr_o}{k} = \frac{(15 \text{ W/m}^2\cdot\text{°C})(0.04 \text{ m})}{(0.571 \text{ W/m}\cdot\text{°C})} = 1.051 \approx 1.0$$

The constants λ_1 and A_1 corresponding to this Biot number are, from Table 4-2,

$$\lambda_1 = 1.5708 \quad \text{and} \quad A_1 = 1.2732$$

The Fourier number is

$$\tau = \frac{\alpha t}{r_o^2} = \frac{(0.136 \times 10^{-6} \text{ m}^2/\text{s})(4 \text{ h} \times 3600 \text{ s/h})}{(0.04 \text{ m})^2} = 1.224 > 0.2$$

Therefore, the one-term approximate solution (or the transient temperature charts) is applicable. Then the temperature at the surface of the oranges becomes

$$\theta(r_o, t)_{sph} = \frac{T(r_o, t) - T_\infty}{T_i - T_\infty} = A_1 e^{-\lambda_1^2 \tau} \frac{\sin(\lambda_1 r_o / r_o)}{\lambda_1 r_o / r_o} = (1.2732) e^{-(1.5708)^2 (1.224)} \frac{\sin(1.5708 \text{ rad})}{1.5708} = 0.0396$$

$$\frac{T(r_o, t) - (-6)}{15 - (-6)} = 0.0396 \longrightarrow T(r_o, t) = -5.2 \text{ °C}$$

which is less than 0°C. Therefore, the oranges will freeze.

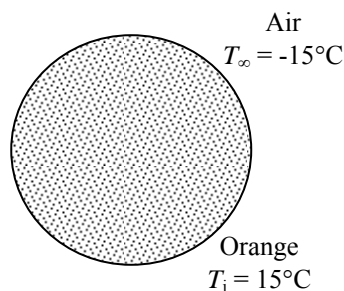

4-56 A hot baked potato is taken out of the oven and wrapped so that no heat is lost from it. The time the potato is baked in the oven and the final equilibrium temperature of the potato after it is wrapped are to be determined.

Assumptions 1 The potato is spherical in shape with a diameter of 9 cm. **2** Heat conduction in the potato is one-dimensional because of symmetry about the midpoint. **3** The thermal properties of the potato are constant. **4** The heat transfer coefficient is constant and uniform over the entire surface. **5** The Fourier number is $\tau > 0.2$ so that the one-term approximate solutions (or the transient temperature charts) are applicable (this assumption will be verified).

Properties The properties of the potato are given to be $k = 0.6$ W/m·°C, $\rho = 1100$ kg/m³, $c_p = 3.9$ kJ/kg·°C, and $\alpha = 1.4 \times 10^{-7}$ m²/s.

Analysis (a) The Biot number is

$$Bi = \frac{hr_o}{k} = \frac{(40 \text{ W/m}^2 \cdot \text{°C})(0.045 \text{ m})}{(0.6 \text{ W/m} \cdot \text{°C})} = 3$$

The constants λ_1 and A_1 corresponding to this Biot number are, from Table 4-2,

$$\lambda_1 = 2.2889 \quad \text{and} \quad A_1 = 1.6227$$

Then the Fourier number and the time period become

$$\theta_{o,sph} = \frac{T_o - T_\infty}{T_i - T_\infty} = A_1 e^{-\lambda_1^2 \tau} \longrightarrow \frac{70 - 170}{25 - 170} = 0.69 = (1.6227) e^{-(2.2889)^2 \tau} \longrightarrow \tau = 0.163$$

which is not greater than 0.2 but it is close. We may use one-term approximation knowing that the result may be somewhat in error. Then the baking time of the potatoes is determined to be

$$t = \frac{\tau_o^2}{\alpha} = \frac{(0.163)(0.045 \text{ m})^2}{1.4 \times 10^{-7} \text{ m}^2/\text{s}} = 2358 \text{ s} = \mathbf{39.3 \text{ min}}$$

(b) The maximum amount of heat transfer is

$$m = \rho V = \rho \frac{4}{3} \pi r_o^3 = (1100 \text{ kg/m}^3) \left[\frac{4}{3} \pi (0.045 \text{ m})^3 \right] = 0.420 \text{ kg}$$

$$Q_{\max} = mc_p (T_\infty - T_i) = (0.420 \text{ kg})(3.900 \text{ kJ/kg} \cdot \text{°C})(170 - 25) \text{°C} = 237 \text{ kJ}$$

Then the actual amount of heat transfer becomes

$$\frac{Q}{Q_{\max}} = 1 - 3\theta_{o,sph} \frac{\sin(\lambda_1) - \lambda_1 \cos(\lambda_1)}{\lambda_1^3} = 1 - 3(0.69) \frac{\sin(2.2889) - (2.2889) \cos(2.2889)}{(2.2889)^3} = 0.610$$

$$Q = 0.610 Q_{\max} = (0.610)(237 \text{ kJ}) = \mathbf{145 \text{ kJ}}$$

The final equilibrium temperature of the potato after it is wrapped is

$$Q = mc_p (T_{eqv} - T_i) \longrightarrow T_{eqv} = T_i + \frac{Q}{mc_p} = 25 \text{°C} + \frac{145 \text{ kJ}}{(0.420 \text{ kg})(3.9 \text{ kJ/kg} \cdot \text{°C})} = \mathbf{114 \text{°C}}$$

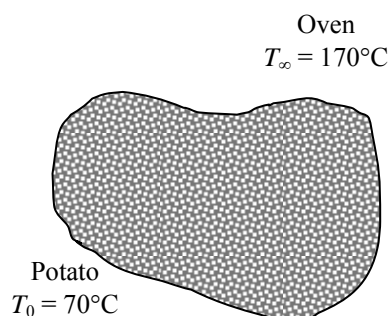

4-57 The center temperature of potatoes is to be lowered to 6°C during cooling. The cooling time and if any part of the potatoes will suffer chilling injury during this cooling process are to be determined.

Assumptions 1 The potatoes are spherical in shape with a radius of $r_o = 3$ cm. **2** Heat conduction in the potato is one-dimensional in the radial direction because of the symmetry about the midpoint. **3** The thermal properties of the potato are constant. **4** The heat transfer coefficient is constant and uniform over the entire surface. **5** The Fourier number is $\tau > 0.2$ so that the one-term approximate solutions (or the transient temperature charts) are applicable (this assumption will be verified).

Properties The thermal conductivity and thermal diffusivity of potatoes are given to be $k = 0.50$ W/m·°C and $\alpha = 0.13 \times 10^{-6}$ m²/s.

Analysis First we find the Biot number:

$$Bi = \frac{hr_o}{k} = \frac{(19 \text{ W/m}^2 \cdot \text{°C})(0.03 \text{ m})}{0.50 \text{ W/m} \cdot \text{°C}} = 1.14$$

From Table 4-2 we read, for a sphere, $\lambda_1 = 1.635$ and $A_1 = 1.302$. Substituting these values into the one-term solution gives

$$\theta_0 = \frac{T_0 - T_\infty}{T_i - T_\infty} = A_1 e^{-\lambda_1^2 \tau} \rightarrow \frac{6 - 2}{25 - 2} = 1.302 e^{-(1.635)^2 \tau} \rightarrow \tau = 0.753$$

which is greater than 0.2 and thus the one-term solution is applicable. Then the cooling time becomes

$$\tau = \frac{\alpha t}{r_o^2} \longrightarrow t = \frac{\tau r_o^2}{\alpha} = \frac{(0.753)(0.03 \text{ m})^2}{0.13 \times 10^{-6} \text{ m}^2/\text{s}} = 5213 \text{ s} = \mathbf{1.45 \text{ h}}$$

The lowest temperature during cooling will occur on the surface ($r/r_o = 1$), and is determined to be

$$\frac{T(r) - T_\infty}{T_i - T_\infty} = A_1 e^{-\lambda_1^2 \tau} \frac{\sin(\lambda_1 r / r_o)}{\lambda_1 r / r_o} \rightarrow \frac{T(r_o) - T_\infty}{T_i - T_\infty} = \theta_0 \frac{\sin(\lambda_1 r_o / r_o)}{\lambda_1 r_o / r_o} = \frac{T_o - T_\infty}{T_i - T_\infty} \frac{\sin(\lambda_1 r_o / r_o)}{\lambda_1 r_o / r_o}$$

$$\text{Substituting, } \frac{T(r_o) - 2}{25 - 2} = \left(\frac{6 - 2}{25 - 2} \right) \frac{\sin(1.635 \text{ rad})}{1.635} \longrightarrow T(r_o) = 4.44^\circ\text{C}$$

which is above the temperature range of 3 to 4 °C for chilling injury for potatoes. Therefore, **no part** of the potatoes will experience chilling injury during this cooling process.

Alternative solution We could also solve this problem using transient temperature charts as follows:

$$\left. \begin{aligned} \frac{1}{Bi} &= \frac{k}{hr_o} = \frac{0.50 \text{ W/m} \cdot \text{°C}}{(19 \text{ W/m}^2 \cdot \text{°C})(0.03 \text{ m})} = 0.877 \\ \frac{T_0 - T_\infty}{T_i - T_\infty} &= \frac{6 - 2}{25 - 2} = 0.174 \end{aligned} \right\} \tau = \frac{\alpha t}{r_o^2} = 0.75 \quad (\text{Fig. 4-17a})$$

$$\text{Therefore, } t = \frac{\tau r_o^2}{\alpha} = \frac{(0.75)(0.03)^2}{0.13 \times 10^{-6} \text{ m}^2/\text{s}} = 5192 \text{ s} = \mathbf{1.44 \text{ h}}$$

The surface temperature is determined from

$$\left. \begin{aligned} \frac{1}{Bi} &= \frac{k}{hr_o} = 0.877 \\ \frac{r}{r_o} &= 1 \end{aligned} \right\} \frac{T(r) - T_\infty}{T_o - T_\infty} = 0.6 \quad (\text{Fig. 4-17b})$$

$$\text{which gives } T_{\text{surface}} = T_\infty + 0.6(T_o - T_\infty) = 2 + 0.6(6 - 2) = 4.4^\circ\text{C}$$

The slight difference between the two results is due to the reading error of the charts.

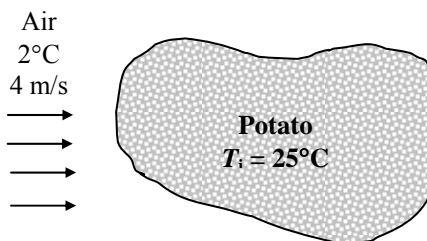

4-58E The center temperature of oranges is to be lowered to 40°F during cooling. The cooling time and if any part of the oranges will freeze during this cooling process are to be determined.

Assumptions 1 The oranges are spherical in shape with a radius of $r_o = 1.25 \text{ in} = 0.1042 \text{ ft}$. **2** Heat conduction in the orange is one-dimensional in the radial direction because of the symmetry about the midpoint. **3** The thermal properties of the orange are constant. **4** The heat transfer coefficient is constant and uniform over the entire surface. **5** The Fourier number is $\tau > 0.2$ so that the one-term approximate solutions (or the transient temperature charts) are applicable (this assumption will be verified).

Properties The thermal conductivity and thermal diffusivity of oranges are given to be $k = 0.26 \text{ Btu/h}\cdot\text{ft}\cdot^\circ\text{F}$ and $\alpha = 1.4 \times 10^{-6} \text{ ft}^2/\text{s}$.

Analysis First we find the Biot number:

$$Bi = \frac{hr_o}{k} = \frac{(4.6 \text{ Btu/h}\cdot\text{ft}^2\cdot^\circ\text{F})(1.25/12 \text{ ft})}{0.26 \text{ Btu/h}\cdot\text{ft}\cdot^\circ\text{C}} = 1.843$$

From Table 4-2 we read, for a sphere, $\lambda_1 = 1.9569$ and $A_1 = 1.447$. Substituting these values into the one-term solution gives

$$\theta_0 = \frac{T_0 - T_\infty}{T_i - T_\infty} = A_1 e^{-\lambda_1^2 \tau} \rightarrow \frac{40 - 25}{78 - 25} = 1.447 e^{-(1.9569)^2 \tau} \rightarrow \tau = 0.426$$

which is greater than 0.2 and thus the one-term solution is applicable. Then the cooling time becomes

$$\tau = \frac{\alpha t}{r_o^2} \rightarrow t = \frac{r_o^2 \tau}{\alpha} = \frac{(0.426)(1.25/12 \text{ ft})^2}{1.4 \times 10^{-6} \text{ ft}^2/\text{s}} = 3302 \text{ s} = \mathbf{55.0 \text{ min}}$$

The lowest temperature during cooling will occur on the surface ($r/r_o = 1$), and is determined to be

$$\frac{T(r) - T_\infty}{T_i - T_\infty} = A_1 e^{-\lambda_1^2 \tau} \frac{\sin(\lambda_1 r / r_o)}{\lambda_1 r / r_o} \rightarrow \frac{T(r_o) - T_\infty}{T_i - T_\infty} = \theta_0 \frac{\sin(\lambda_1 r_o / r_o)}{\lambda_1 r_o / r_o} = \frac{T_o - T_\infty}{T_i - T_\infty} \frac{\sin(\lambda_1 r_o / r_o)}{\lambda_1 r_o / r_o}$$

$$\text{Substituting, } \frac{T(r_o) - 25}{78 - 25} = \left(\frac{40 - 25}{78 - 25} \right) \frac{\sin(1.9569 \text{ rad})}{1.9569} \rightarrow T(r_o) = 32.1^\circ\text{F}$$

which is above the freezing temperature of 31°C for oranges. Therefore, no part of the oranges will freeze during this cooling process.

Alternative solution We could also solve this problem using transient temperature charts as follows:

$$\left. \begin{aligned} \frac{1}{Bi} = \frac{k}{hr_o} = \frac{0.26 \text{ Btu/h}\cdot\text{ft}\cdot^\circ\text{F}}{(4.6 \text{ Btu/h}\cdot\text{ft}^2\cdot^\circ\text{F})(1.25/12 \text{ ft})} = 0.543 \\ \frac{T_0 - T_\infty}{T_i - T_\infty} = \frac{40 - 25}{78 - 25} = 0.283 \end{aligned} \right\} \tau = \frac{\alpha t}{r_o^2} = 0.43 \quad (\text{Fig. 4-17a})$$

$$\text{Therefore, } t = \frac{\tau r_o^2}{\alpha} = \frac{(0.43)(1.25/12 \text{ ft})^2}{1.4 \times 10^{-6} \text{ ft}^2/\text{s}} = 3333 \text{ s} = 55.6 \text{ min}$$

The lowest temperature during cooling will occur on the surface ($r/r_o = 1$) of the oranges is determined to be

$$\left. \begin{aligned} \frac{1}{Bi} = \frac{k}{hr_o} = 0.543 \\ \frac{r}{r_o} = 1 \end{aligned} \right\} \frac{T(r) - T_\infty}{T_0 - T_\infty} = 0.45 \quad (\text{Fig. 4-17b})$$

$$\text{which gives } T_{\text{surface}} = T_\infty + 0.45(T_0 - T_\infty) = 25 + 0.45(40 - 25) = 31.8^\circ\text{F}$$

The slight difference between the two results is due to the reading error of the charts.

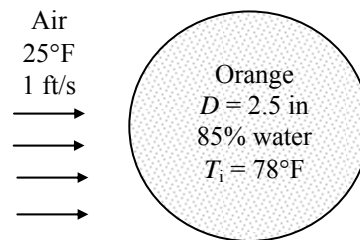

4-59 The center temperature of a beef carcass is to be lowered to 4°C during cooling. The cooling time and if any part of the carcass will suffer freezing injury during this cooling process are to be determined.

Assumptions 1 The beef carcass can be approximated as a cylinder with insulated top and base surfaces having a radius of $r_o = 12$ cm and a height of $H = 1.4$ m. **2** Heat conduction in the carcass is one-dimensional in the radial direction because of the symmetry about the centerline. **3** The thermal properties of the carcass are constant. **4** The heat transfer coefficient is constant and uniform over the entire surface. **5** The Fourier number is $\tau > 0.2$ so that the one-term approximate solutions (or the transient temperature charts) are applicable (this assumption will be verified).

Properties The thermal conductivity and thermal diffusivity of carcass are given to be $k = 0.47$ W/m·°C and $\alpha = 0.13 \times 10^{-6}$ m²/s.

Analysis First we find the Biot number:

$$Bi = \frac{hr_o}{k} = \frac{(22 \text{ W/m}^2 \cdot \text{°C})(0.12 \text{ m})}{0.47 \text{ W/m} \cdot \text{°C}} = 5.62$$

From Table 4-2 we read, for a cylinder, $\lambda_1 = 2.027$ and $A_1 = 1.517$. Substituting these values into the one-term solution gives

$$\theta_0 = \frac{T_0 - T_\infty}{T_i - T_\infty} = A_1 e^{-\lambda_1^2 \tau} \rightarrow \frac{4 - (-10)}{37 - (-10)} = 1.517 e^{-(2.027)^2 \tau} \rightarrow \tau = 0.396$$

which is greater than 0.2 and thus the one-term solution is applicable.

Then the cooling time becomes

$$\tau = \frac{\alpha t}{r_o^2} \rightarrow t = \frac{\tau r_o^2}{\alpha} = \frac{(0.396)(0.12 \text{ m})^2}{0.13 \times 10^{-6} \text{ m}^2/\text{s}} = 43,865 \text{ s} = \mathbf{12.2 \text{ h}}$$

The lowest temperature during cooling will occur on the surface ($r/r_o = 1$), and is determined to be

$$\frac{T(r) - T_\infty}{T_i - T_\infty} = A_1 e^{-\lambda_1^2 \tau} J_0(\lambda_1 r / r_o) \rightarrow \frac{T(r_o) - T_\infty}{T_i - T_\infty} = \theta_0 J_0(\lambda_1 r / r_o) = \frac{T_0 - T_\infty}{T_i - T_\infty} J_0(\lambda_1 r_o / r_o)$$

$$\text{Substituting, } \frac{T(r_o) - (-10)}{37 - (-10)} = \left(\frac{4 - (-10)}{37 - (-10)} \right) J_0(\lambda_1) = 0.2979 \times 0.2084 = 0.0621 \rightarrow T(r_o) = -7.1^\circ\text{C}$$

which is below the freezing temperature of -1.7°C . Therefore, the outer part of the beef carcass will freeze during this cooling process.

Alternative solution We could also solve this problem using transient temperature charts as follows:

$$\left. \begin{aligned} \frac{1}{Bi} = \frac{k}{hr_o} &= \frac{0.47 \text{ W/m} \cdot \text{°C}}{(22 \text{ W/m}^2 \cdot \text{°C})(0.12 \text{ m})} = 0.178 \\ \frac{T_0 - T_\infty}{T_i - T_\infty} &= \frac{4 - (-10)}{37 - (-10)} = 0.298 \end{aligned} \right\} \tau = \frac{\alpha t}{r_o^2} = 0.4 \quad (\text{Fig. 4-16a})$$

$$\text{Therefore, } t = \frac{\tau r_o^2}{\alpha} = \frac{(0.4)(0.12 \text{ m})^2}{0.13 \times 10^{-6} \text{ m}^2/\text{s}} = 44,308 \text{ s} \cong 12.3 \text{ h}$$

The surface temperature is determined from

$$\left. \begin{aligned} \frac{1}{Bi} = \frac{k}{hr_o} &= 0.178 \\ \frac{r}{r_o} &= 1 \end{aligned} \right\} \frac{T(r) - T_\infty}{T_0 - T_\infty} = 0.17 \quad (\text{Fig. 4-16b})$$

$$\text{which gives } T_{\text{surface}} = T_\infty + 0.17(T_0 - T_\infty) = -10 + 0.17[4 - (-10)] = -7.6^\circ\text{C}$$

The difference between the two results is due to the reading error of the charts.

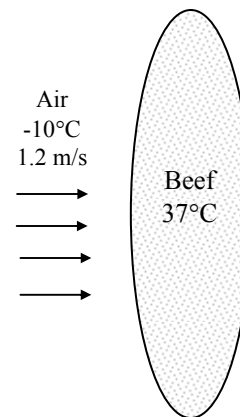

4-60 The center temperature of meat slabs is to be lowered to -18°C during cooling. The cooling time and the surface temperature of the slabs at the end of the cooling process are to be determined.

Assumptions 1 The meat slabs can be approximated as very large plane walls of half-thickness $L = 11.5$ cm. **2** Heat conduction in the meat slabs is one-dimensional because of the symmetry about the centerplane.

3 The thermal properties of the meat slabs are constant. **4** The heat transfer coefficient is constant and uniform over the entire surface. **5** The Fourier number is $\tau > 0.2$ so that the one-term approximate solutions (or the transient temperature charts) are applicable (this assumption will be verified). **6** The phase change effects are not considered, and thus the actual cooling time will be much longer than the value determined.

Properties The thermal conductivity and thermal diffusivity of meat slabs are given to be $k = 0.47 \text{ W/m}\cdot^{\circ}\text{C}$ and $\alpha = 0.13 \times 10^{-6} \text{ m}^2/\text{s}$. These properties will be used for both fresh and frozen meat.

Analysis First we find the Biot number:

$$\text{Bi} = \frac{hr_o}{k} = \frac{(20 \text{ W/m}^2 \cdot ^{\circ}\text{C})(0.115 \text{ m})}{0.47 \text{ W/m}\cdot^{\circ}\text{C}} = 4.89$$

From Table 4-2 we read, for a plane wall, $\lambda_1 = 1.308$ and $A_1 = 1.239$. Substituting these values into the one-term solution gives

$$\theta_0 = \frac{T_o - T_{\infty}}{T_i - T_{\infty}} = A_1 e^{-\lambda_1^2 \tau} \rightarrow \frac{-18 - (-30)}{7 - (-30)} = 1.239 e^{-(1.308)^2 \tau} \rightarrow \tau = 0.783$$

which is greater than 0.2 and thus the one-term solution is applicable.

Then the cooling time becomes

$$\tau = \frac{\alpha t}{L^2} \rightarrow t = \frac{\tau L^2}{\alpha} = \frac{(0.783)(0.115 \text{ m})^2}{0.13 \times 10^{-6} \text{ m}^2/\text{s}} = 79,650 \text{ s} = \mathbf{22.1 \text{ h}}$$

The lowest temperature during cooling will occur on the surface ($x/L = 1$), and is determined to be

$$\frac{T(x) - T_{\infty}}{T_i - T_{\infty}} = A_1 e^{-\lambda_1^2 \tau} \cos(\lambda_1 x / L) \rightarrow \frac{T(L) - T_{\infty}}{T_i - T_{\infty}} = \theta_0 \cos(\lambda_1 L / L) = \frac{T_o - T_{\infty}}{T_i - T_{\infty}} \cos(\lambda_1)$$

Substituting,

$$\frac{T(L) - (-30)}{7 - (-30)} = \left(\frac{-18 - (-30)}{7 - (-30)} \right) \cos(\lambda_1) = 0.3243 \times 0.2598 = 0.08425 \rightarrow T(L) = \mathbf{-26.9^{\circ}\text{C}}$$

which is close to the temperature of the refrigerated air.

Alternative solution We could also solve this problem using transient temperature charts as follows:

$$\left. \begin{aligned} \frac{1}{\text{Bi}} = \frac{k}{hL} &= \frac{0.47 \text{ W/m}\cdot^{\circ}\text{C}}{(20 \text{ W/m}^2 \cdot ^{\circ}\text{C})(0.115 \text{ m})} = 0.204 \\ \frac{T_o - T_{\infty}}{T_i - T_{\infty}} &= \frac{-18 - (-30)}{7 - (-30)} = 0.324 \end{aligned} \right\} \tau = \frac{\alpha t}{L^2} = 0.75 \quad (\text{Fig. 4-15a})$$

$$\text{Therefore, } t = \frac{\tau L^2}{\alpha} = \frac{(0.75)(0.115 \text{ m})^2}{0.13 \times 10^{-6} \text{ m}^2/\text{s}} = 76,300 \text{ s} \cong 21.2 \text{ h}$$

The surface temperature is determined from

$$\left. \begin{aligned} \frac{1}{\text{Bi}} = \frac{k}{hL} &= 0.204 \\ \frac{x}{L} &= 1 \end{aligned} \right\} \frac{T(x) - T_{\infty}}{T_o - T_{\infty}} = 0.22 \quad (\text{Fig. 4-15b})$$

$$\text{which gives } T_{\text{surface}} = T_{\infty} + 0.22(T_o - T_{\infty}) = -30 + 0.22[-18 - (-30)] = \mathbf{-27.4^{\circ}\text{C}}$$

The slight difference between the two results is due to the reading error of the charts.

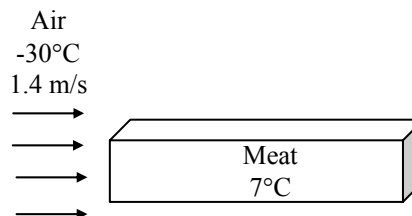

4-61E The center temperature of meat slabs is to be lowered to 36°F during 12-h of cooling. The average heat transfer coefficient during this cooling process is to be determined.

Assumptions 1 The meat slabs can be approximated as very large plane walls of half-thickness $L = 3$ -in. **2** Heat conduction in the meat slabs is one-dimensional because of symmetry about the centerplane. **3** The thermal properties of the meat slabs are constant. **4** The heat transfer coefficient is constant and uniform over the entire surface. **5** The Fourier number is $\tau > 0.2$ so that the one-term approximate solutions (or the transient temperature charts) are applicable (this assumption will be verified).

Properties The thermal conductivity and thermal diffusivity of meat slabs are given to be $k = 0.26$ Btu/h·ft·°F and $\alpha = 1.4 \times 10^{-6}$ ft²/s.

Analysis The average heat transfer coefficient during this cooling process is determined from the transient temperature charts for a flat plate as follows:

$$\left. \begin{aligned} \tau &= \frac{\alpha t}{L^2} = \frac{(1.4 \times 10^{-6} \text{ ft}^2/\text{s})(12 \times 3600 \text{ s})}{(3/12 \text{ ft})^2} = 0.968 \\ \frac{T_0 - T_\infty}{T_i - T_\infty} &= \frac{36 - 23}{50 - 23} = 0.481 \end{aligned} \right\} \frac{1}{Bi} = 0.7 \quad (\text{Fig. 4-15a})$$

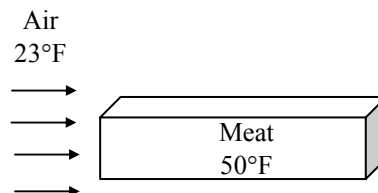

Therefore,

$$h = \frac{kBi}{L} = \frac{(0.26 \text{ Btu/h}\cdot\text{ft}\cdot\text{°F})(1/0.7)}{(3/12) \text{ ft}} = \mathbf{1.5 \text{ Btu/h}\cdot\text{ft}^2\cdot\text{°F}}$$

Discussion We could avoid the uncertainty associated with the reading of the charts and obtain a more accurate result by using the one-term solution relation for an infinite plane wall, but it would require a trial and error approach since the Bi number is not known.

4-62 Chickens are to be chilled by holding them in agitated brine for 2.75 h. The center and surface temperatures of the chickens are to be determined, and if any part of the chickens will freeze during this cooling process is to be assessed.

Assumptions **1** The chickens are spherical in shape. **2** Heat conduction in the chickens is one-dimensional in the radial direction because of symmetry about the midpoint. **3** The thermal properties of the chickens are constant. **4** The heat transfer coefficient is constant and uniform over the entire surface. **5** The Fourier number is $\tau > 0.2$ so that the one-term approximate solutions (or the transient temperature charts) are applicable (this assumption will be verified). **6** The phase change effects are not considered, and thus the actual the temperatures will be much higher than the values determined since a considerable part of the cooling process will occur during phase change (freezing of chicken).

Properties The thermal conductivity, thermal diffusivity, and density of chickens are given to be $k = 0.45$ W/m \cdot °C, $\alpha = 0.13 \times 10^{-6}$ m 2 /s, and $\rho = 950$ kg/m 3 . These properties will be used for both fresh and frozen chicken.

Analysis We first find the volume and equivalent radius of the chickens:

$$V = m / \rho = 1700\text{g} / (0.95\text{g/cm}^3) = 1789\text{cm}^3$$

$$r_o = \left(\frac{3}{4\pi} V \right)^{1/3} = \left(\frac{3}{4\pi} 1789\text{cm}^3 \right)^{1/3} = 7.53\text{cm} = 0.0753\text{m}$$

Then the Biot and Fourier numbers become

$$\text{Bi} = \frac{hr_o}{k} = \frac{(440\text{ W/m}^2 \cdot \text{°C})(0.0753\text{ m})}{0.45\text{ W/m} \cdot \text{°C}} = 73.6$$

$$\tau = \frac{\alpha t}{r_o^2} = \frac{(0.13 \times 10^{-6}\text{ m}^2/\text{s})(2.75 \times 3600\text{ s})}{(0.0753\text{ m})^2} = 0.2270$$

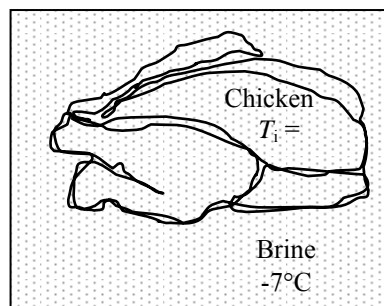

Note that $\tau = 0.2270 > 0.2$, and thus the one-term solution is applicable. From Table 4-2 we read, for a sphere, $\lambda_1 = 3.094$ and $A_1 = 1.998$. Substituting these values into the one-term solution gives

$$\theta_0 = \frac{T_0 - T_\infty}{T_i - T_\infty} = A_1 e^{-\lambda_1^2 \tau} \rightarrow \frac{T_0 - (-7)}{15 - (-7)} = 1.998 e^{-(3.094)^2 (0.2270)} = 0.2274 \rightarrow T_0 = -2.0^\circ\text{C}$$

The lowest temperature during cooling will occur on the surface ($r/r_o = 1$), and is determined to be

$$\frac{T(r) - T_\infty}{T_i - T_\infty} = A_1 e^{-\lambda_1^2 \tau} \frac{\sin(\lambda_1 r / r_o)}{\lambda_1 r / r_o} \rightarrow \frac{T(r_o) - T_\infty}{T_i - T_\infty} = \theta_0 \frac{\sin(\lambda_1 r_o / r_o)}{\lambda_1 r_o / r_o} = \frac{T_0 - T_\infty}{T_i - T_\infty} \frac{\sin(\lambda_1 r_o / r_o)}{\lambda_1 r_o / r_o}$$

$$\text{Substituting, } \frac{T(r_o) - (-7)}{15 - (-7)} = 0.2274 \frac{\sin(3.094\text{ rad})}{3.094} \rightarrow T(r_o) = -6.9^\circ\text{C}$$

Most parts of chicken will freeze during this process since the freezing point of chicken is -2.8°C .

Discussion We could also solve this problem using transient temperature charts, but the data in this case falls at a point on the chart which is very difficult to read:

$$\left. \begin{aligned} \tau = \frac{\alpha t}{r_o^2} &= \frac{(0.13 \times 10^{-6}\text{ m}^2/\text{s})(2.75 \times 3600\text{ s})}{(0.0753\text{ m})^2} = 0.227 \\ \frac{1}{\text{Bi}} &= \frac{k}{hr_o} = \frac{0.45\text{ W/m} \cdot \text{°C}}{(440\text{ W/m}^2 \cdot \text{°C})(0.0753\text{ m})} = 0.0136 \end{aligned} \right\} \frac{T_0 - T_\infty}{T_i - T_\infty} = 0.15 \dots 0.30 \text{ ?? (Fig. 4-17)}$$

Transient Heat Conduction in Semi-Infinite Solids

4-63C A semi-infinite medium is an idealized body which has a single exposed plane surface and extends to infinity in all directions. The earth and thick walls can be considered to be semi-infinite media.

4-64C A thick plane wall can be treated as a semi-infinite medium if all we are interested in is the variation of temperature in a region near one of the surfaces for a time period during which the temperature in the mid section of the wall does not experience any change.

4-65C The total amount of heat transfer from a semi-infinite solid up to a specified time t_0 can be determined by integration from

$$Q = \int_0^{t_0} Ah[T(0, t) - T_\infty] dt$$

where the surface temperature $T(0, t)$ is obtained from Eq. 4-47 by substituting $x = 0$.

4-66 The water pipes are buried in the ground to prevent freezing. The minimum burial depth at a particular location is to be determined.

Assumptions 1 The temperature in the soil is affected by the thermal conditions at one surface only, and thus the soil can be considered to be a semi-infinite medium with a specified surface temperature. **2** The thermal properties of the soil are constant.

Properties The thermal properties of the soil are given to be $k = 0.35 \text{ W/m}\cdot^\circ\text{C}$ and $\alpha = 0.15 \times 10^{-6} \text{ m}^2/\text{s}$.

Analysis The length of time the snow pack stays on the ground is

$$t = (60 \text{ days})(24 \text{ hr/days})(3600 \text{ s/hr}) = 5.184 \times 10^6 \text{ s}$$

$$T_s = -8^\circ\text{C}$$

The surface is kept at -8°C at all times. The depth at which freezing at 0°C occurs can be determined from the analytical solution,

$$\frac{T(x, t) - T_i}{T_s - T_i} = \text{erfc}\left(\frac{x}{\sqrt{\alpha t}}\right)$$

$$\frac{0 - 8}{-8 - 8} = \text{erfc}\left(\frac{x}{2\sqrt{(0.15 \times 10^{-6} \text{ m}^2/\text{s})(5.184 \times 10^6 \text{ s})}}\right)$$

$$0.5 = \text{erfc}\left(\frac{x}{1.7636}\right)$$

Then from Table 4-4 we get $\frac{x}{1.7636} = 0.4796 \longrightarrow x = \mathbf{0.846 \text{ m}}$

Discussion The solution could also be determined using the chart, but it would be subject to reading error.

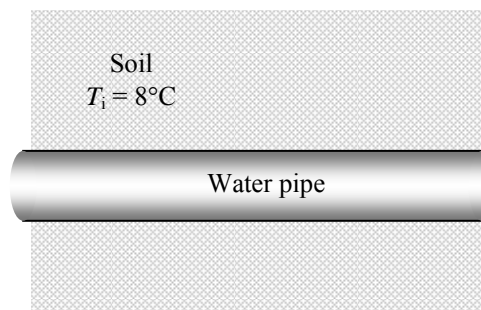

4-67 An area is subjected to cold air for a 10-h period. The soil temperatures at distances 0, 10, 20, and 50 cm from the earth's surface are to be determined.

Assumptions 1 The temperature in the soil is affected by the thermal conditions at one surface only, and thus the soil can be considered to be a semi-infinite medium with a specified surface temperature. **2** The thermal properties of the soil are constant.

Properties The thermal properties of the soil are given to be $k = 0.9 \text{ W/m}\cdot^\circ\text{C}$ and $\alpha = 1.6 \times 10^{-5} \text{ m}^2/\text{s}$.

Analysis The one-dimensional transient temperature distribution in the ground can be determined from

$$\frac{T(x,t) - T_i}{T_\infty - T_i} = \text{erfc}\left(\frac{x}{2\sqrt{\alpha t}}\right) - \exp\left(\frac{hx}{k} + \frac{h^2 \alpha t}{k^2}\right) \left[\text{erfc}\left(\frac{x}{2\sqrt{\alpha t}} + \frac{h\sqrt{\alpha t}}{k}\right) \right] \quad \begin{array}{l} \longrightarrow \\ \longrightarrow \\ \longrightarrow \\ \longrightarrow \end{array} \begin{array}{l} \text{Winds} \\ \\ \\ T_\infty = -10^\circ\text{C} \end{array}$$

where

$$\frac{h\sqrt{\alpha t}}{k} = \frac{(40 \text{ W/m}^2 \cdot ^\circ\text{C})\sqrt{(1.6 \times 10^{-5} \text{ m}^2/\text{s})(10 \times 3600 \text{ s})}}{0.9 \text{ W/m}\cdot^\circ\text{C}} = 33.7$$

$$\frac{h^2 \alpha t}{k^2} = \left(\frac{h\sqrt{\alpha t}}{k}\right)^2 = 33.7^2 = 1138$$

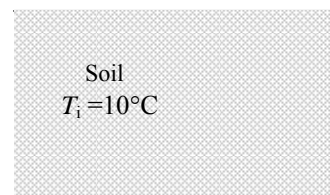

Then we conclude that the last term in the temperature distribution relation above must be zero regardless of x despite the exponential term tending to infinity since (1) $\text{erfc}(\eta) \rightarrow 0$ for $\eta > 4$ (see Table 4-4) and (2) the term has to remain less than 1 to have physically meaningful solutions. That is,

$$\exp\left(\frac{hx}{k} + \frac{h^2 \alpha t}{k^2}\right) \left[\text{erfc}\left(\frac{x}{2\sqrt{\alpha t}} + \frac{h\sqrt{\alpha t}}{k}\right) \right] = \exp\left(\frac{hx}{k} + 1138\right) \left[\text{erfc}\left(\frac{x}{2\sqrt{\alpha t}} + 33.7\right) \right] \cong 0$$

Therefore, the temperature distribution relation simplifies to

$$\frac{T(x,t) - T_i}{T_\infty - T_i} = \text{erfc}\left(\frac{x}{2\sqrt{\alpha t}}\right) \rightarrow T(x,t) = T_i + (T_\infty - T_i) \text{erfc}\left(\frac{x}{2\sqrt{\alpha t}}\right)$$

Then the temperatures at 0, 10, 20, and 50 cm depth from the ground surface become

$$x = 0: \quad T(0, 10 \text{ h}) = T_i + (T_\infty - T_i) \text{erfc}\left(\frac{0}{2\sqrt{\alpha t}}\right) = T_i + (T_\infty - T_i) \text{erfc}(0) = T_i + (T_\infty - T_i) \times 1 = T_\infty = -10^\circ\text{C}$$

$$x = 0.1 \text{ m}: \quad T(0.1 \text{ m}, 10 \text{ h}) = 10 + (-10 - 10) \text{erfc}\left(\frac{0.1 \text{ m}}{2\sqrt{(1.6 \times 10^{-5} \text{ m}^2/\text{s})(10 \text{ h} \times 3600 \text{ s/h})}}\right) \\ = 10 - 20 \text{erfc}(0.066) = 10 - 20 \times 0.9257 = -8.5^\circ\text{C}$$

$$x = 0.2 \text{ m}: \quad T(0.2 \text{ m}, 10 \text{ h}) = 10 + (-10 - 10) \text{erfc}\left(\frac{0.2 \text{ m}}{2\sqrt{(1.6 \times 10^{-5} \text{ m}^2/\text{s})(10 \text{ h} \times 3600 \text{ s/h})}}\right) \\ = 10 - 20 \text{erfc}(0.132) = 10 - 20 \times 0.8519 = -7.0^\circ\text{C}$$

$$x = 0.5 \text{ m}: \quad T(0.5 \text{ m}, 10 \text{ h}) = 10 + (-10 - 10) \text{erfc}\left(\frac{0.5 \text{ m}}{2\sqrt{(1.6 \times 10^{-5} \text{ m}^2/\text{s})(10 \text{ h} \times 3600 \text{ s/h})}}\right) \\ = 10 - 20 \text{erfc}(0.329) = 10 - 20 \times 0.6418 = -2.8^\circ\text{C}$$

4-68 EES Prob. 4-67 is reconsidered. The soil temperature as a function of the distance from the earth's surface is to be plotted.

Analysis The problem is solved using EES, and the solution is given below.

"GIVEN"

T_i=10 [C]
 T_{infinity}=-10 [C]
 h=40 [W/m²-C]
 time=10*3600 [s]
 x=0.1 [m]

"PROPERTIES"

k=0.9 [W/m-C]
 alpha=1.6E-5 [m²/s]

"ANALYSIS"

$(T_x - T_i) / (T_{\text{infinity}} - T_i) = \text{erfc}(x / (2 * \sqrt{\alpha * \text{time}})) - \exp((h * x) / k + (h^2 * \alpha * \text{time}) / k^2) * \text{erfc}(x / (2 * \sqrt{\alpha * \text{time}})) + (h * \sqrt{\alpha * \text{time}}) / k$

x [m]	T _x [C]
0	-9.666
0.05	-8.923
0.1	-8.183
0.15	-7.447
0.2	-6.716
0.25	-5.993
0.3	-5.277
0.35	-4.572
0.4	-3.878
0.45	-3.197
0.5	-2.529
0.55	-1.877
0.6	-1.24
0.65	-0.6207
0.7	-0.01894
0.75	0.5643
0.8	1.128
0.85	1.672
0.9	2.196
0.95	2.7
1	3.183

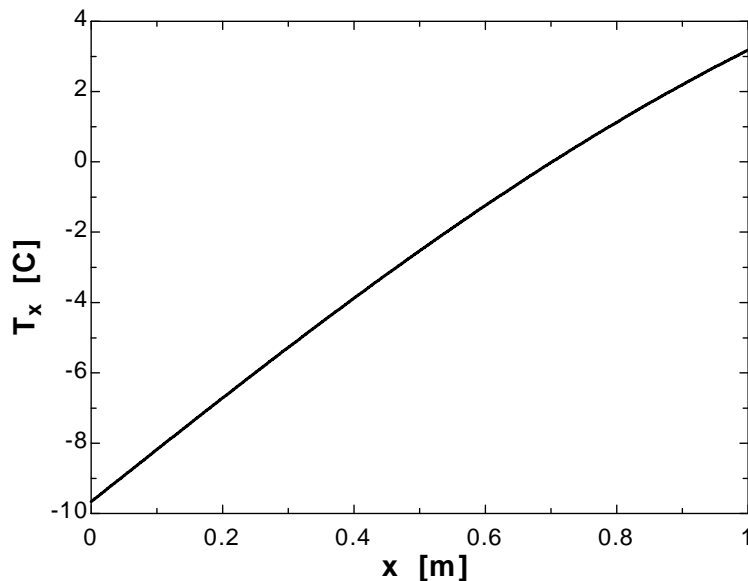

4-69 An aluminum block is subjected to heat flux. The surface temperature of the block is to be determined.

Assumptions **1** All heat flux is absorbed by the block. **2** Heat loss from the block is disregarded (and thus the result obtained is the maximum temperature). **3** The block is sufficiently thick to be treated as a semi-infinite solid, and the properties of the block are constant.

Properties Thermal conductivity and diffusivity of aluminum at room temperature are $k = 237 \text{ W/m}\cdot\text{°C}$ and $\alpha = 97.1 \times 10^{-6} \text{ m}^2/\text{s}$.

Analysis This is a transient conduction problem in a semi-infinite medium subjected to constant surface heat flux, and the surface temperature can be determined to be

$$T_s = T_i + \frac{\dot{q}_s}{k} \sqrt{\frac{4\alpha t}{\pi}} = 20^\circ\text{C} + \frac{4000 \text{ W/m}^2}{237 \text{ W/m}\cdot\text{°C}} \sqrt{\frac{4(9.71 \times 10^{-5} \text{ m}^2/\text{s})(30 \times 60 \text{ s})}{\pi}} = 28.0^\circ\text{C}$$

Then the temperature rise of the surface becomes

$$\Delta T_s = 28 - 20 = \mathbf{8.0^\circ\text{C}}$$

4-70 The contact surface temperatures when a bare footed person steps on aluminum and wood blocks are to be determined.

Assumptions **1** Both bodies can be treated as the semi-infinite solids. **2** Heat loss from the solids is disregarded. **3** The properties of the solids are constant.

Properties The $\sqrt{k\rho c_p}$ value is $24 \text{ kJ/m}^2\cdot\text{°C}$ for aluminum, $0.38 \text{ kJ/m}^2\cdot\text{°C}$ for wood, and $1.1 \text{ kJ/m}^2\cdot\text{°C}$ for the human flesh.

Analysis The surface temperature is determined from Eq. 4-49 to be

$$T_s = \frac{\sqrt{(k\rho c_p)_{\text{human}}} T_{\text{human}} + \sqrt{(k\rho c_p)_{\text{Al}}} T_{\text{Al}}}{\sqrt{(k\rho c_p)_{\text{human}}} + \sqrt{(k\rho c_p)_{\text{Al}}}} = \frac{(1.1 \text{ kJ/m}^2\cdot\text{°C})(32^\circ\text{C}) + (24 \text{ kJ/m}^2\cdot\text{°C})(20^\circ\text{C})}{(1.1 \text{ kJ/m}^2\cdot\text{°C}) + (24 \text{ kJ/m}^2\cdot\text{°C})} = \mathbf{20.5^\circ\text{C}}$$

In the case of wood block, we obtain

$$\begin{aligned} T_s &= \frac{\sqrt{(k\rho c_p)_{\text{human}}} T_{\text{human}} + \sqrt{(k\rho c_p)_{\text{wood}}} T_{\text{wood}}}{\sqrt{(k\rho c_p)_{\text{human}}} + \sqrt{(k\rho c_p)_{\text{wood}}}} \\ &= \frac{(1.1 \text{ kJ/m}^2\cdot\text{°C})(32^\circ\text{C}) + (0.38 \text{ kJ/m}^2\cdot\text{°C})(20^\circ\text{C})}{(1.1 \text{ kJ/m}^2\cdot\text{°C}) + (0.38 \text{ kJ/m}^2\cdot\text{°C})} \\ &= \mathbf{28.9^\circ\text{C}} \end{aligned}$$

4-71E The walls of a furnace made of concrete are exposed to hot gases at the inner surfaces. The time it will take for the temperature of the outer surface of the furnace to change is to be determined.

Assumptions 1 The temperature in the wall is affected by the thermal conditions at inner surfaces only and the convection heat transfer coefficient inside is given to be very large. Therefore, the wall can be considered to be a semi-infinite medium with a specified surface temperature of 1800°F. **2** The thermal properties of the concrete wall are constant.

Properties The thermal properties of the concrete are given to be $k = 0.64 \text{ Btu/h}\cdot\text{ft}\cdot^\circ\text{F}$ and $\alpha = 0.023 \text{ ft}^2/\text{h}$.

Analysis The one-dimensional transient temperature distribution in the wall for that time period can be determined from

$$\frac{T(x,t) - T_i}{T_s - T_i} = \text{erfc}\left(\frac{x}{2\sqrt{\alpha t}}\right)$$

But,

$$\frac{T(x,t) - T_i}{T_s - T_i} = \frac{70.1 - 70}{1800 - 70} = 0.00006 \rightarrow 0.00006 = \text{erfc}(2.85) \quad (\text{Table 4-4})$$

Therefore,

$$\frac{x}{2\sqrt{\alpha t}} = 2.85 \rightarrow t = \frac{x^2}{4 \times (2.85)^2 \alpha} = \frac{(1.2 \text{ ft})^2}{4 \times (2.85)^2 (0.023 \text{ ft}^2/\text{h})} = 1.93 \text{ h} = \mathbf{116 \text{ min}}$$

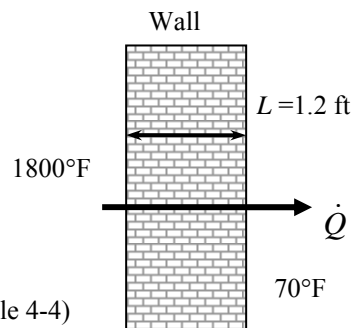

4-72 A thick wood slab is exposed to hot gases for a period of 5 minutes. It is to be determined whether the wood will ignite.

Assumptions 1 The wood slab is treated as a semi-infinite medium subjected to convection at the exposed surface. **2** The thermal properties of the wood slab are constant. **3** The heat transfer coefficient is constant and uniform over the entire surface.

Properties The thermal properties of the wood are $k = 0.17 \text{ W/m}\cdot^\circ\text{C}$ and $\alpha = 1.28 \times 10^{-7} \text{ m}^2/\text{s}$.

Analysis The one-dimensional transient temperature distribution in the wood can be determined from

$$\frac{T(x,t) - T_i}{T_\infty - T_i} = \text{erfc}\left(\frac{x}{2\sqrt{\alpha t}}\right) - \exp\left(\frac{hx}{k} + \frac{h^2 \alpha t}{k^2}\right) \left[\text{erfc}\left(\frac{x}{2\sqrt{\alpha t}} + \frac{h\sqrt{\alpha t}}{k}\right) \right]$$

where

$$\frac{h\sqrt{\alpha t}}{k} = \frac{(35 \text{ W/m}^2 \cdot ^\circ\text{C}) \sqrt{(1.28 \times 10^{-7} \text{ m}^2/\text{s})(5 \times 60 \text{ s})}}{0.17 \text{ W/m}\cdot^\circ\text{C}} = 1.276$$

$$\frac{h^2 \alpha t}{k^2} = \left(\frac{h\sqrt{\alpha t}}{k}\right)^2 = 1.276^2 = 1.628$$

Noting that $x = 0$ at the surface and using Table 4-4 for *erfc* values,

$$\begin{aligned} \frac{T(x,t) - 25}{550 - 25} &= \text{erfc}(0) - \exp(0 + 1.628) \text{erfc}(0 + 1.276) \\ &= 1 - (5.0937)(0.0712) \\ &= 0.637 \end{aligned}$$

Solving for $T(x, t)$ gives

$$T(x, t) = \mathbf{360^\circ\text{C}}$$

which is less than the ignition temperature of 450°C. Therefore, the wood will not ignite.

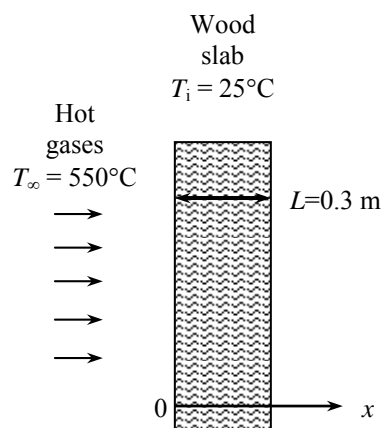

4-73 The outer surfaces of a large cast iron container filled with ice are exposed to hot water. The time before the ice starts melting and the rate of heat transfer to the ice are to be determined.

Assumptions 1 The temperature in the container walls is affected by the thermal conditions at outer surfaces only and the convection heat transfer coefficient outside is given to be very large. Therefore, the wall can be considered to be a semi-infinite medium with a specified surface temperature. **2** The thermal properties of the wall are constant.

Properties The thermal properties of the cast iron are given to be $k = 52 \text{ W/m}\cdot^\circ\text{C}$ and $\alpha = 1.70 \times 10^{-5} \text{ m}^2/\text{s}$.

Analysis The one-dimensional transient temperature distribution in the wall for that time period can be determined from

$$\frac{T(x,t) - T_i}{T_s - T_i} = \text{erfc}\left(\frac{x}{2\sqrt{\alpha t}}\right)$$

But,

$$\frac{T(x,t) - T_i}{T_s - T_i} = \frac{0.1 - 0}{60 - 0} = 0.00167 \rightarrow 0.00167 = \text{erfc}(2.226) \quad (\text{Table 4-4})$$

Therefore,

$$\frac{x}{2\sqrt{\alpha t}} = 2.226 \rightarrow t = \frac{x^2}{4 \times (2.226)^2 \alpha} = \frac{(0.05 \text{ m})^2}{4(2.226)^2 (1.7 \times 10^{-5} \text{ m}^2/\text{s})} = \mathbf{7.4 \text{ s}}$$

The rate of heat transfer to the ice when steady operation conditions are reached can be determined by applying the thermal resistance network concept as

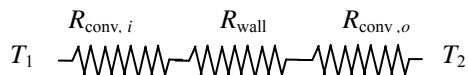

$$R_{\text{conv},i} = \frac{1}{h_i A} = \frac{1}{(250 \text{ W/m}^2 \cdot ^\circ\text{C})(1.2 \times 2 \text{ m}^2)} = 0.00167^\circ\text{C/W}$$

$$R_{\text{wall}} = \frac{L}{kA} = \frac{0.05 \text{ m}}{(52 \text{ W/m}\cdot^\circ\text{C})(1.2 \times 2 \text{ m}^2)} = 0.00040^\circ\text{C/W}$$

$$R_{\text{conv},o} = \frac{1}{h_o A} = \frac{1}{(\infty)(1.2 \times 2 \text{ m}^2)} \cong 0^\circ\text{C/W}$$

$$R_{\text{total}} = R_{\text{conv},i} + R_{\text{wall}} + R_{\text{conv},o} = 0.00167 + 0.00040 + 0 = 0.00207^\circ\text{C/W}$$

$$\dot{Q} = \frac{T_2 - T_1}{R_{\text{total}}} = \frac{(60 - 0)^\circ\text{C}}{0.00207^\circ\text{C/W}} = \mathbf{28,990 \text{ W}}$$

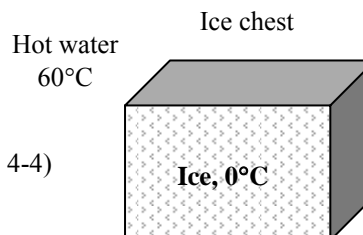

Transient Heat Conduction in Multidimensional Systems

4-74C The product solution enables us to determine the dimensionless temperature of two- or three-dimensional heat transfer problems as the product of dimensionless temperatures of one-dimensional heat transfer problems. The dimensionless temperature for a two-dimensional problem is determined by determining the dimensionless temperatures in both directions, and taking their product.

4-75C The dimensionless temperature for a three-dimensional heat transfer is determined by determining the dimensionless temperatures of one-dimensional geometries whose intersection is the three dimensional geometry, and taking their product.

4-76C This short cylinder is physically formed by the intersection of a long cylinder and a plane wall. The dimensionless temperatures at the center of plane wall and at the center of the cylinder are determined first. Their product yields the dimensionless temperature at the center of the short cylinder.

4-77C The heat transfer in this short cylinder is one-dimensional since there is no heat transfer in the axial direction. The temperature will vary in the radial direction only.

4-78 A short cylinder is allowed to cool in atmospheric air. The temperatures at the centers of the cylinder and the top surface as well as the total heat transfer from the cylinder for 15 min of cooling are to be determined.

Assumptions 1 Heat conduction in the short cylinder is two-dimensional, and thus the temperature varies in both the axial x - and the radial r - directions. **2** The thermal properties of the cylinder are constant. **3** The heat transfer coefficient is constant and uniform over the entire surface. **4** The Fourier number is $\tau > 0.2$ so that the one-term approximate solutions (or the transient temperature charts) are applicable (this assumption will be verified).

Properties The thermal properties of brass are given to be $\rho = 8530 \text{ kg/m}^3$, $c_p = 0.389 \text{ kJ/kg}\cdot^\circ\text{C}$, $k = 110 \text{ W/m}\cdot^\circ\text{C}$, and $\alpha = 3.39 \times 10^{-5} \text{ m}^2/\text{s}$.

Analysis This short cylinder can physically be formed by the intersection of a long cylinder of radius $D/2 = 4 \text{ cm}$ and a plane wall of thickness $2L = 15 \text{ cm}$. We measure x from the midplane.

(a) The Biot number is calculated for the plane wall to be

$$Bi = \frac{hL}{k} = \frac{(40 \text{ W/m}^2\cdot^\circ\text{C})(0.075 \text{ m})}{(110 \text{ W/m}\cdot^\circ\text{C})} = 0.02727$$

The constants λ_1 and A_1 corresponding to this Biot number are, from Table 4-2,

$$\lambda_1 = 0.1620 \quad \text{and} \quad A_1 = 1.0045$$

The Fourier number is

$$\tau = \frac{\alpha t}{L^2} = \frac{(3.39 \times 10^{-5} \text{ m}^2/\text{s})(15 \text{ min} \times 60 \text{ s/min})}{(0.075 \text{ m})^2} = 5.424 > 0.2$$

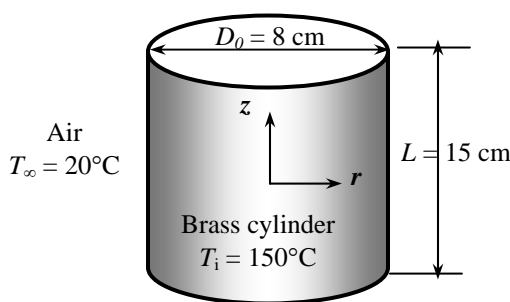

Therefore, the one-term approximate solution (or the transient temperature charts) is applicable. Then the dimensionless temperature at the center of the plane wall is determined from

$$\theta_{0,wall} = \frac{T_0 - T_\infty}{T_i - T_\infty} = A_1 e^{-\lambda_1^2 \tau} = (1.0045) e^{-(0.1620)^2 (5.424)} = 0.871$$

We repeat the same calculations for the long cylinder,

$$Bi = \frac{hr_o}{k} = \frac{(40 \text{ W/m}^2\cdot^\circ\text{C})(0.04 \text{ m})}{(110 \text{ W/m}\cdot^\circ\text{C})} = 0.01455$$

$$\lambda_1 = 0.1677 \quad \text{and} \quad A_1 = 1.0036$$

$$\tau = \frac{\alpha t}{r_o^2} = \frac{(3.39 \times 10^{-5} \text{ m}^2/\text{s})(15 \times 60 \text{ s})}{(0.04 \text{ m})^2} = 19.069 > 0.2$$

$$\theta_{o,cyl} = \frac{T_o - T_\infty}{T_i - T_\infty} = A_1 e^{-\lambda_1^2 \tau} = (1.0036) e^{-(0.1677)^2 (19.069)} = 0.587$$

Then the center temperature of the short cylinder becomes

$$\left[\frac{T(0,0,t) - T_\infty}{T_i - T_\infty} \right]_{\text{short cylinder}} = \theta_{o,wall} \times \theta_{o,cyl} = 0.871 \times 0.587 = 0.511$$

$$\frac{T(0,0,t) - 20}{150 - 20} = 0.511 \longrightarrow T(0,0,t) = \mathbf{86.4^\circ\text{C}}$$

(b) The center of the top surface of the cylinder is still at the center of the long cylinder ($r = 0$), but at the outer surface of the plane wall ($x = L$). Therefore, we first need to determine the dimensionless temperature at the surface of the wall.

$$\theta(L, t)_{wall} = \frac{T(x, t) - T_{\infty}}{T_i - T_{\infty}} = A_1 e^{-\lambda_1^2 \tau} \cos(\lambda_1 L / L) = (1.0045) e^{-(0.1620)^2 (5.424)} \cos(0.1620) = 0.860$$

Then the center temperature of the top surface of the cylinder becomes

$$\left[\frac{T(L, 0, t) - T_{\infty}}{T_i - T_{\infty}} \right]_{short\ cylinder} = \theta(L, t)_{wall} \times \theta_{o, cyl} = 0.860 \times 0.587 = 0.505$$

$$\frac{T(L, 0, t) - 20}{150 - 20} = 0.505 \longrightarrow T(L, 0, t) = \mathbf{85.6^{\circ}C}$$

(c) We first need to determine the maximum heat can be transferred from the cylinder

$$m = \rho V = \rho \pi r_o^2 L = (8530 \text{ kg/m}^3) [\pi (0.04 \text{ m})^2 (0.15 \text{ m})] = 6.43 \text{ kg}$$

$$Q_{max} = mc_p (T_i - T_{\infty}) = (6.43 \text{ kg})(0.389 \text{ kJ/kg} \cdot ^{\circ}\text{C})(150 - 20)^{\circ}\text{C} = 325 \text{ kJ}$$

Then we determine the dimensionless heat transfer ratios for both geometries as

$$\left(\frac{Q}{Q_{max}} \right)_{wall} = 1 - \theta_{o, wall} \frac{\sin(\lambda_1)}{\lambda_1} = 1 - (0.871) \frac{\sin(0.1620)}{0.1620} = 0.133$$

$$\left(\frac{Q}{Q_{max}} \right)_{cyl} = 1 - 2\theta_{o, cyl} \frac{J_1(\lambda_1)}{\lambda_1} = 1 - 2(0.587) \frac{0.0835}{0.1677} = 0.415$$

The heat transfer ratio for the short cylinder is

$$\left(\frac{Q}{Q_{max}} \right)_{short\ cylinder} = \left(\frac{Q}{Q_{max}} \right)_{plane\ wall} + \left(\frac{Q}{Q_{max}} \right)_{long\ cylinder} \left[1 - \left(\frac{Q}{Q_{max}} \right)_{plane\ wall} \right] = 0.133 + (0.415)(1 - 0.133) = 0.493$$

Then the total heat transfer from the short cylinder during the first 15 minutes of cooling becomes

$$Q = 0.493 Q_{max} = (0.493)(325 \text{ kJ}) = \mathbf{160 \text{ kJ}}$$

4-79 EES Prob. 4-78 is reconsidered. The effect of the cooling time on the center temperature of the cylinder, the center temperature of the top surface of the cylinder, and the total heat transfer is to be investigated.

Analysis The problem is solved using EES, and the solution is given below.

"GIVEN"

D=0.08 [m]
 $r_o = D/2$
 height=0.15 [m]
 $L = \text{height}/2$
 $T_i = 150$ [C]
 $T_{\text{infinity}} = 20$ [C]
 $h = 40$ [W/m²-C]
 time=15 [min]

"PROPERTIES"

$k = 110$ [W/m-C]
 $\rho = 8530$ [kg/m³]
 $C_p = 0.389$ [kJ/kg-C]
 $\alpha = 3.39E-5$ [m²/s]

"ANALYSIS"

"(a)"

"This short cylinder can physically be formed by the intersection of a long cylinder of radius r_o and a plane wall of thickness $2L$ "

"For plane wall"

$Bi_w = (h \cdot L)/k$

"From Table 4-2 corresponding to this Bi number, we read"

$\lambda_{1_w} = 0.1620$ "w stands for wall"

$A_{1_w} = 1.0045$

$\tau_w = (\alpha \cdot \text{time} \cdot \text{Convert}(\text{min}, \text{s}))/L^2$

$\theta_{o_w} = A_{1_w} \cdot \exp(-\lambda_{1_w}^2 \cdot \tau_w)$ " $\theta_{o_w} = (T_{o_w} - T_{\text{infinity}})/(T_i - T_{\text{infinity}})$ "

"For long cylinder"

$Bi_c = (h \cdot r_o)/k$ "c stands for cylinder"

"From Table 4-2 corresponding to this Bi number, we read"

$\lambda_{1_c} = 0.1677$

$A_{1_c} = 1.0036$

$\tau_c = (\alpha \cdot \text{time} \cdot \text{Convert}(\text{min}, \text{s}))/r_o^2$

$\theta_{o_c} = A_{1_c} \cdot \exp(-\lambda_{1_c}^2 \cdot \tau_c)$ " $\theta_{o_c} = (T_{o_c} - T_{\text{infinity}})/(T_i - T_{\text{infinity}})$ "

$(T_{o_o} - T_{\text{infinity}})/(T_i - T_{\text{infinity}}) = \theta_{o_w} \cdot \theta_{o_c}$ "center temperature of short cylinder"

"(b)"

$\theta_{L_w} = A_{1_w} \cdot \exp(-\lambda_{1_w}^2 \cdot \tau_w) \cdot \text{Cos}(\lambda_{1_w} \cdot L/L)$ " $\theta_{L_w} = (T_{L_w} - T_{\text{infinity}})/(T_i - T_{\text{infinity}})$ "

$(T_{L_o} - T_{\text{infinity}})/(T_i - T_{\text{infinity}}) = \theta_{L_w} \cdot \theta_{o_c}$ "center temperature of the top surface"

"(c)"

$V = \pi \cdot r_o^2 \cdot (2 \cdot L)$

$m = \rho \cdot V$

$Q_{\text{max}} = m \cdot C_p \cdot (T_i - T_{\text{infinity}})$

$Q_w = 1 - \theta_{o_w} \cdot \text{Sin}(\lambda_{1_w})/\lambda_{1_w}$ " $Q_w = (Q/Q_{\text{max}})_w$ "

$Q_c = 1 - 2 \cdot \theta_{o_c} \cdot J_1/\lambda_{1_c}$ " $Q_c = (Q/Q_{\text{max}})_c$ "

$J_1 = 0.0835$ "From Table 4-3, at λ_{1_c} "

$Q/Q_{\text{max}} = Q_w + Q_c \cdot (1 - Q_w)$ "total heat transfer"

time [min]	$T_{o,o}$ [C]	$T_{L,o}$ [C]	Q [kJ]
5	124.5	123.2	65.97
10	103.4	102.3	118.5
15	86.49	85.62	160.3
20	73.03	72.33	193.7
25	62.29	61.74	220.3
30	53.73	53.29	241.6
35	46.9	46.55	258.5
40	41.45	41.17	272
45	37.11	36.89	282.8
50	33.65	33.47	291.4
55	30.88	30.74	298.2
60	28.68	28.57	303.7

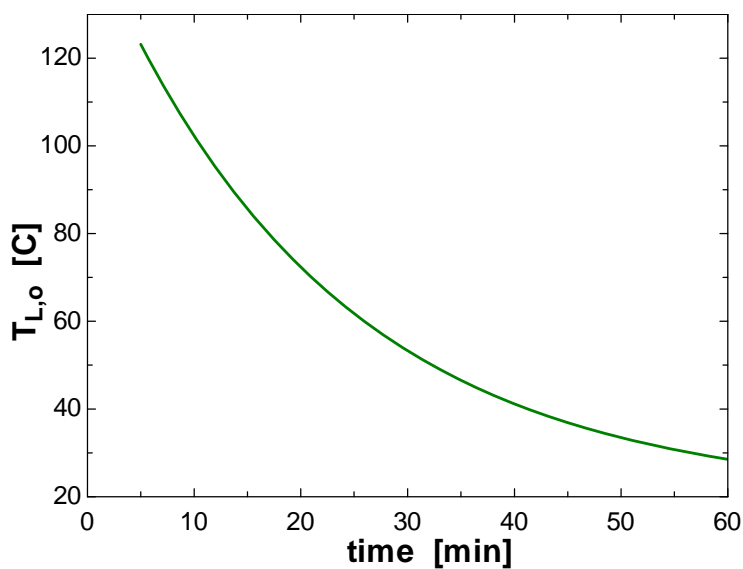
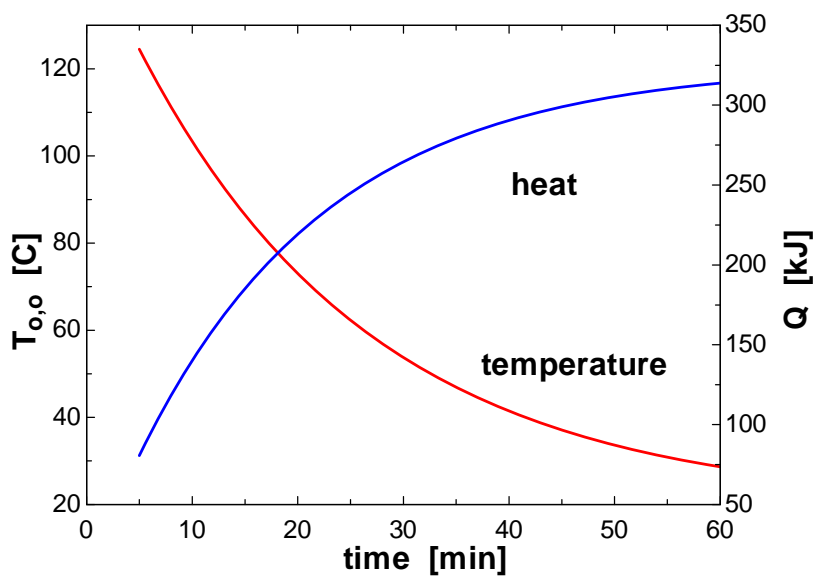

4-80 A semi-infinite aluminum cylinder is cooled by water. The temperature at the center of the cylinder 5 cm from the end surface is to be determined.

Assumptions 1 Heat conduction in the semi-infinite cylinder is two-dimensional, and thus the temperature varies in both the axial x - and the radial r - directions. **2** The thermal properties of the cylinder are constant. **3** The heat transfer coefficient is constant and uniform over the entire surface. **4** The Fourier number is $\tau > 0.2$ so that the one-term approximate solutions (or the transient temperature charts) are applicable (this assumption will be verified).

Properties The thermal properties of aluminum are given to be $k = 237 \text{ W/m}\cdot^\circ\text{C}$ and $\alpha = 9.71 \times 10^{-5} \text{ m}^2/\text{s}$.

Analysis This semi-infinite cylinder can physically be formed by the intersection of a long cylinder of radius $r_o = D/2 = 7.5 \text{ cm}$ and a semi-infinite medium. The dimensionless temperature 5 cm from the surface of a semi-infinite medium is first determined from

$$\begin{aligned} \frac{T(x,t) - T_i}{T_\infty - T_i} &= \text{erfc}\left(\frac{x}{\sqrt{\alpha t}}\right) - \exp\left(\frac{hx}{k} + \frac{h^2 \alpha t}{k^2}\right) \left[\text{erfc}\left(\frac{x}{2\sqrt{\alpha t}} + \frac{h\sqrt{\alpha t}}{k}\right) \right] \\ &= \text{erfc}\left(\frac{0.05}{2\sqrt{(9.71 \times 10^{-5})(8 \times 60)}}\right) - \exp\left(\frac{(140)(0.05)}{237} + \frac{(140)^2(9.71 \times 10^{-5})(8 \times 60)}{(237)^2}\right) \\ &\quad \times \left[\text{erfc}\left(\frac{0.05}{2\sqrt{(9.71 \times 10^{-5})(8 \times 60)}} + \frac{(140)\sqrt{(9.71 \times 10^{-5})(8 \times 60)}}{237}\right) \right] \\ &= \text{erfc}(0.1158) - \exp(0.0458) \text{erfc}(0.2433) = 0.8699 - (1.0468)(0.7308) = 0.1049 \end{aligned}$$

$$\theta_{\text{semi-inf}} = \frac{T(x,t) - T_\infty}{T_i - T_\infty} = 1 - 0.1049 = 0.8951$$

The Biot number is calculated for the long cylinder to be

$$Bi = \frac{hr_o}{k} = \frac{(140 \text{ W/m}^2 \cdot ^\circ\text{C})(0.075 \text{ m})}{237 \text{ W/m}\cdot^\circ\text{C}} = 0.0443$$

The constants λ_1 and A_1 corresponding to this Biot number are, from Table 4-2,

$$\lambda_1 = 0.2948 \quad \text{and} \quad A_1 = 1.0110$$

The Fourier number is

$$\tau = \frac{\alpha t}{r_o^2} = \frac{(9.71 \times 10^{-5} \text{ m}^2/\text{s})(8 \times 60 \text{ s})}{(0.075 \text{ m})^2} = 8.286 > 0.2$$

Therefore, the one-term approximate solution (or the transient temperature charts) is applicable. Then the dimensionless temperature at the center of the plane wall is determined from

$$\theta_{o,\text{cyl}} = \frac{T_o - T_\infty}{T_i - T_\infty} = A_1 e^{-\lambda_1^2 \tau} = (1.0110) e^{-(0.2948)^2 (8.286)} = 0.4921$$

The center temperature of the semi-infinite cylinder then becomes

$$\begin{aligned} \left[\frac{T(x,0,t) - T_\infty}{T_i - T_\infty} \right]_{\text{semi-infinite cylinder}} &= \theta_{\text{semi-inf}}(x,t) \times \theta_{o,\text{cyl}} = 0.8951 \times 0.4921 = 0.4405 \\ \left[\frac{T(x,0,t) - 10}{115 - 10} \right]_{\text{semi-infinite cylinder}} &= 0.4405 \longrightarrow T(x,0,t) = \mathbf{56.3^\circ\text{C}} \end{aligned}$$

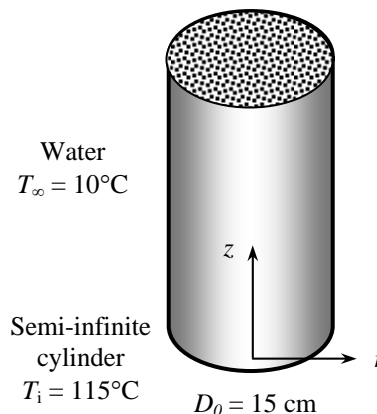

4-81E A hot dog is dropped into boiling water. The center temperature of the hot dog is to be determined by treating hot dog as a finite cylinder and also as an infinitely long cylinder.

Assumptions 1 When treating hot dog as a finite cylinder, heat conduction in the hot dog is two-dimensional, and thus the temperature varies in both the axial x - and the radial r - directions. When treating hot dog as an infinitely long cylinder, heat conduction is one-dimensional in the radial r - direction. **2** The thermal properties of the hot dog are constant. **3** The heat transfer coefficient is constant and uniform over the entire surface. **4** The Fourier number is $\tau > 0.2$ so that the one-term approximate solutions (or the transient temperature charts) are applicable (this assumption will be verified).

Properties The thermal properties of the hot dog are given to be $k = 0.44 \text{ Btu/h}\cdot\text{ft}\cdot^\circ\text{F}$, $\rho = 61.2 \text{ lbm/ft}^3$, $c_p = 0.93 \text{ Btu/lbm}\cdot^\circ\text{F}$, and $\alpha = 0.0077 \text{ ft}^2/\text{h}$.

Analysis (a) This hot dog can physically be formed by the intersection of a long cylinder of radius $r_o = D/2 = (0.4/12) \text{ ft}$ and a plane wall of thickness $2L = (5/12) \text{ ft}$. The distance x is measured from the midplane.

After 5 minutes

First the Biot number is calculated for the plane wall to be

$$Bi = \frac{hL}{k} = \frac{(120 \text{ Btu/h}\cdot\text{ft}^2\cdot^\circ\text{F})(2.5/12 \text{ ft})}{(0.44 \text{ Btu/h}\cdot\text{ft}\cdot^\circ\text{F})} = 56.8$$

The constants λ_1 and A_1 corresponding to this Biot number are, from Table 4-2,

$$\lambda_1 = 1.5421 \quad \text{and} \quad A_1 = 1.2728$$

The Fourier number is

$$\tau = \frac{\alpha t}{L^2} = \frac{(0.0077 \text{ ft}^2/\text{h})(5/60 \text{ h})}{(2.5/12 \text{ ft})^2} = 0.015 < 0.2 \quad (\text{Be cautious!})$$

Then the dimensionless temperature at the center of the plane wall is determined from

$$\theta_{0,\text{wall}} = \frac{T_0 - T_\infty}{T_i - T_\infty} = A_1 e^{-\lambda_1^2 \tau} = (1.2728) e^{-(1.5421)^2 (0.015)} = 1.228$$

We repeat the same calculations for the long cylinder,

$$Bi = \frac{hr_o}{k} = \frac{(120 \text{ Btu/h}\cdot\text{ft}^2\cdot^\circ\text{F})(0.4/12 \text{ ft})}{(0.44 \text{ Btu/h}\cdot\text{ft}\cdot^\circ\text{F})} = 9.1$$

$$\lambda_1 = 2.1589 \quad \text{and} \quad A_1 = 1.5618$$

$$\tau = \frac{\alpha t}{r_o^2} = \frac{(0.0077 \text{ ft}^2/\text{h})(5/60 \text{ h})}{(0.4/12 \text{ ft})^2} = 0.578 > 0.2$$

$$\theta_{o,\text{cyl}} = \frac{T_o - T_\infty}{T_i - T_\infty} = A_1 e^{-\lambda_1^2 \tau} = (1.5618) e^{-(2.1589)^2 (0.578)} = 0.106$$

Then the center temperature of the short cylinder becomes

$$\left[\frac{T(0,0,t) - T_\infty}{T_i - T_\infty} \right]_{\text{short cylinder}} = \theta_{o,\text{wall}} \times \theta_{o,\text{cyl}} = 1.228 \times 0.106 = 0.130$$

$$\frac{T(0,0,t) - 212}{40 - 212} = 0.130 \longrightarrow T(0,0,t) = \mathbf{190^\circ\text{F}}$$

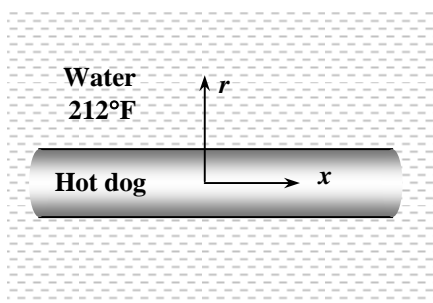

After 10 minutes

$$\tau = \frac{\alpha t}{L^2} = \frac{(0.0077 \text{ ft}^2/\text{h})(10/60 \text{ h})}{(2.5/12 \text{ ft})^2} = 0.03 < 0.2 \quad (\text{Be cautious!})$$

$$\theta_{0,\text{wall}} = \frac{T_0 - T_\infty}{T_i - T_\infty} = A_1 e^{-\lambda_1^2 \tau} = (1.2728)e^{-(1.5421)^2(0.03)} = 1.185$$

$$\tau = \frac{\alpha t}{r_o^2} = \frac{(0.0077 \text{ ft}^2/\text{h})(10/60 \text{ h})}{(0.4/12 \text{ ft})^2} = 1.156 > 0.2$$

$$\theta_{0,\text{cyl}} = \frac{T_0 - T_\infty}{T_i - T_\infty} = A_1 e^{-\lambda_1^2 \tau} = (1.5618)e^{-(2.1589)^2(1.156)} = 0.0071$$

$$\left[\frac{T(0,0,t) - T_\infty}{T_i - T_\infty} \right]_{\text{short cylinder}} = \theta_{0,\text{wall}} \times \theta_{0,\text{cyl}} = 1.185 \times 0.0071 = 0.0084$$

$$\frac{T(0,0,t) - 212}{40 - 212} = 0.0084 \longrightarrow T(0,0,t) = \mathbf{211^\circ\text{F}}$$

After 15 minutes

$$\tau = \frac{\alpha t}{L^2} = \frac{(0.0077 \text{ ft}^2/\text{h})(15/60 \text{ h})}{(2.5/12 \text{ ft})^2} = 0.045 < 0.2 \quad (\text{Be cautious!})$$

$$\theta_{0,\text{wall}} = \frac{T_0 - T_\infty}{T_i - T_\infty} = A_1 e^{-\lambda_1^2 \tau} = (1.2728)e^{-(1.5421)^2(0.045)} = 1.143$$

$$\tau = \frac{\alpha t}{r_o^2} = \frac{(0.0077 \text{ ft}^2/\text{h})(15/60 \text{ h})}{(0.4/12 \text{ ft})^2} = 1.734 > 0.2$$

$$\theta_{0,\text{cyl}} = \frac{T_0 - T_\infty}{T_i - T_\infty} = A_1 e^{-\lambda_1^2 \tau} = (1.5618)e^{-(2.1589)^2(1.734)} = 0.00048$$

$$\left[\frac{T(0,0,t) - T_\infty}{T_i - T_\infty} \right]_{\text{short cylinder}} = \theta_{0,\text{wall}} \times \theta_{0,\text{cyl}} = 1.143 \times 0.00048 = 0.00055$$

$$\frac{T(0,0,t) - 212}{40 - 212} = 0.00055 \longrightarrow T(0,0,t) = \mathbf{212^\circ\text{F}}$$

(b) Treating the hot dog as an infinitely long cylinder will not change the results obtained in the part (a) since dimensionless temperatures for the plane wall is 1 for all cases.

4-82E A hot dog is dropped into boiling water. The center temperature of the hot dog is to be determined by treating hot dog as a finite cylinder and an infinitely long cylinder.

Assumptions 1 When treating hot dog as a finite cylinder, heat conduction in the hot dog is two-dimensional, and thus the temperature varies in both the axial x - and the radial r - directions. When treating hot dog as an infinitely long cylinder, heat conduction is one-dimensional in the radial r - direction. **2** The thermal properties of the hot dog are constant. **3** The heat transfer coefficient is constant and uniform over the entire surface. **4** The Fourier number is $\tau > 0.2$ so that the one-term approximate solutions (or the transient temperature charts) are applicable (this assumption will be verified).

Properties The thermal properties of the hot dog are given to be $k = 0.44 \text{ Btu/h}\cdot\text{ft}\cdot^\circ\text{F}$, $\rho = 61.2 \text{ lbm/ft}^3$, $c_p = 0.93 \text{ Btu/lbm}\cdot^\circ\text{F}$, and $\alpha = 0.0077 \text{ ft}^2/\text{h}$.

Analysis (a) This hot dog can physically be formed by the intersection of a long cylinder of radius $r_o = D/2 = (0.4/12) \text{ ft}$ and a plane wall of thickness $2L = (5/12) \text{ ft}$. The distance x is measured from the midplane.

After 5 minutes

First the Biot number is calculated for the plane wall to be

$$Bi = \frac{hL}{k} = \frac{(120 \text{ Btu/h}\cdot\text{ft}^2\cdot^\circ\text{F})(2.5/12 \text{ ft})}{(0.44 \text{ Btu/h}\cdot\text{ft}\cdot^\circ\text{F})} = 56.8$$

The constants λ_1 and A_1 corresponding to this Biot number are, from Table 4-2,

$$\lambda_1 = 1.5421 \quad \text{and} \quad A_1 = 1.2728$$

The Fourier number is

$$\tau = \frac{\alpha t}{L^2} = \frac{(0.0077 \text{ ft}^2/\text{h})(5/60 \text{ h})}{(2.5/12 \text{ ft})^2} = 0.015 < 0.2 \quad (\text{Be cautious!})$$

Then the dimensionless temperature at the center of the plane wall is determined from

$$\theta_{0,\text{wall}} = \frac{T_0 - T_\infty}{T_i - T_\infty} = A_1 e^{-\lambda_1^2 \tau} = (1.2728) e^{-(1.5421)^2 (0.015)} = 1.228$$

We repeat the same calculations for the long cylinder,

$$Bi = \frac{hr_o}{k} = \frac{(120 \text{ Btu/h}\cdot\text{ft}^2\cdot^\circ\text{F})(0.4/12 \text{ ft})}{(0.44 \text{ Btu/h}\cdot\text{ft}\cdot^\circ\text{F})} = 9.1$$

$$\lambda_1 = 2.1589 \quad \text{and} \quad A_1 = 1.5618$$

$$\tau = \frac{\alpha t}{r_o^2} = \frac{(0.0077 \text{ ft}^2/\text{h})(5/60 \text{ h})}{(0.4/12 \text{ ft})^2} = 0.578 > 0.2$$

$$\theta_{0,\text{cyl}} = \frac{T_0 - T_\infty}{T_i - T_\infty} = A_1 e^{-\lambda_1^2 \tau} = (1.5618) e^{-(2.1589)^2 (0.578)} = 0.106$$

Then the center temperature of the short cylinder becomes

$$\left[\frac{T(0,0,t) - T_\infty}{T_i - T_\infty} \right]_{\text{short cylinder}} = \theta_{o,\text{wall}} \times \theta_{o,\text{cyl}} = 1.228 \times 0.106 = 0.130$$

$$\frac{T(0,0,t) - 202}{40 - 202} = 0.130 \longrightarrow T(0,0,t) = \mathbf{181^\circ\text{F}}$$

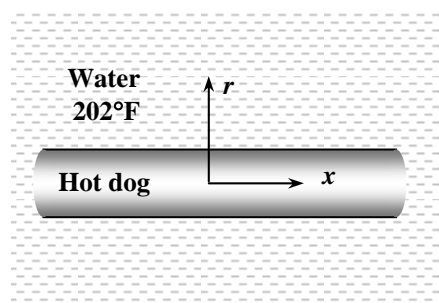

After 10 minutes

$$\tau = \frac{\alpha t}{L^2} = \frac{(0.0077 \text{ ft}^2/\text{h})(10/60 \text{ h})}{(2.5/12 \text{ ft})^2} = 0.03 < 0.2 \quad (\text{Be cautious!})$$

$$\theta_{0,\text{wall}} = \frac{T_0 - T_\infty}{T_i - T_\infty} = A_1 e^{-\lambda_1^2 \tau} = (1.2728)e^{-(1.5421)^2(0.03)} = 1.185$$

$$\tau = \frac{\alpha t}{r_o^2} = \frac{(0.0077 \text{ ft}^2/\text{h})(10/60 \text{ h})}{(0.4/12 \text{ ft})^2} = 1.156 > 0.2$$

$$\theta_{0,\text{cyl}} = \frac{T_0 - T_\infty}{T_i - T_\infty} = A_1 e^{-\lambda_1^2 \tau} = (1.5618)e^{-(2.1589)^2(1.156)} = 0.007$$

$$\left[\frac{T(0,0,t) - T_\infty}{T_i - T_\infty} \right]_{\text{short cylinder}} = \theta_{0,\text{wall}} \times \theta_{0,\text{cyl}} = 1.185 \times 0.0071 = 0.0084$$

$$\frac{T(0,0,t) - 202}{40 - 202} = 0.0084 \longrightarrow T(0,0,t) = \mathbf{201^\circ\text{F}}$$

After 15 minutes

$$\tau = \frac{\alpha t}{L^2} = \frac{(0.0077 \text{ ft}^2/\text{h})(15/60 \text{ h})}{(2.5/12 \text{ ft})^2} = 0.045 < 0.2 \quad (\text{Be cautious!})$$

$$\theta_{0,\text{wall}} = \frac{T_0 - T_\infty}{T_i - T_\infty} = A_1 e^{-\lambda_1^2 \tau} = (1.2728)e^{-(1.5421)^2(0.045)} = 1.143$$

$$\tau = \frac{\alpha t}{r_o^2} = \frac{(0.0077 \text{ ft}^2/\text{h})(15/60 \text{ h})}{(0.4/12 \text{ ft})^2} = 1.734 > 0.2$$

$$\theta_{0,\text{cyl}} = \frac{T_0 - T_\infty}{T_i - T_\infty} = A_1 e^{-\lambda_1^2 \tau} = (1.5618)e^{-(2.1589)^2(1.734)} = 0.00048$$

$$\left[\frac{T(0,0,t) - T_\infty}{T_i - T_\infty} \right]_{\text{short cylinder}} = \theta_{0,\text{wall}} \times \theta_{0,\text{cyl}} = 1.143 \times 0.00048 = 0.00055$$

$$\frac{T(0,0,t) - 202}{40 - 202} = 0.00055 \longrightarrow T(0,0,t) = \mathbf{202^\circ\text{F}}$$

(b) Treating the hot dog as an infinitely long cylinder will not change the results obtained in the part (a) since dimensionless temperatures for the plane wall is 1 for all cases.

4-83 A rectangular ice block is placed on a table. The time the ice block starts melting is to be determined.

Assumptions **1** Heat conduction in the ice block is two-dimensional, and thus the temperature varies in both x - and y - directions. **2** The thermal properties of the ice block are constant. **3** The heat transfer coefficient is constant and uniform over the entire surface. **4** The Fourier number is $\tau > 0.2$ so that the one-term approximate solutions (or the transient temperature charts) are applicable (this assumption will be verified).

Properties The thermal properties of the ice are given to be $k = 2.22 \text{ W/m}\cdot\text{°C}$ and $\alpha = 0.124 \times 10^{-7} \text{ m}^2/\text{s}$.

Analysis This rectangular ice block can be treated as a short rectangular block that can physically be formed by the intersection of two infinite plane wall of thickness $2L = 4 \text{ cm}$ and an infinite plane wall of thickness $2L = 10 \text{ cm}$. We measure x from the bottom surface of the block since this surface represents the adiabatic center surface of the plane wall of thickness $2L = 10 \text{ cm}$. Since the melting starts at the corner of the top surface, we need to determine the time required to melt ice block which will happen when the temperature drops below 0°C at this location. The Biot numbers and the corresponding constants are first determined to be

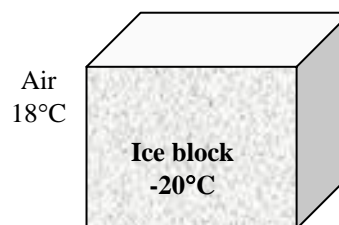

$$Bi_{\text{wall},1} = \frac{hL_1}{k} = \frac{(12 \text{ W/m}^2\cdot\text{°C})(0.02 \text{ m})}{(2.22 \text{ W/m}\cdot\text{°C})} = 0.1081 \longrightarrow \lambda_1 = 0.3208 \quad \text{and} \quad A_1 = 1.0173$$

$$Bi_{\text{wall},3} = \frac{hL_3}{k} = \frac{(12 \text{ W/m}^2\cdot\text{°C})(0.05 \text{ m})}{(2.22 \text{ W/m}\cdot\text{°C})} = 0.2703 \longrightarrow \lambda_1 = 0.4951 \quad \text{and} \quad A_1 = 1.0408$$

The ice will start melting at the corners because of the maximum exposed surface area there. Noting that $\tau = \alpha t / L^2$ and assuming that $\tau > 0.2$ in all dimensions so that the one-term approximate solution for transient heat conduction is applicable, the product solution method can be written for this problem as

$$\begin{aligned} \theta(L_1, L_2, L_3, t)_{\text{block}} &= \theta(L_1, t)_{\text{wall},1}^2 \theta(L_3, t)_{\text{wall},2} \\ \frac{0-18}{-20-18} &= \left[A_1 e^{-\lambda_1^2 \tau} \cos(\lambda_1 L_1 / L_1) \right]^2 \left[A_1 e^{-\lambda_1^2 \tau} \cos(\lambda_1 L_3 / L_3) \right] \\ 0.4737 &= \left\{ (1.0173) \exp \left[-(0.3208)^2 \frac{(0.124 \times 10^{-7})t}{(0.02)^2} \right] \cos(0.3208) \right\}^2 \\ &\quad \times \left\{ (1.0408) \exp \left[-(0.4951)^2 \frac{(0.124 \times 10^{-7})t}{(0.05)^2} \right] \cos(0.4951) \right\} \end{aligned}$$

$$\longrightarrow t = 77,500 \text{ s} = 1292 \text{ min} = \mathbf{21.5 \text{ hours}}$$

Therefore, the ice will start melting in about 21 hours.

Discussion Note that

$$\tau = \frac{\alpha t}{L^2} = \frac{(0.124 \times 10^{-7} \text{ m}^2/\text{s})(77,500 \text{ s/h})}{(0.05 \text{ m})^2} = 0.384 > 0.2$$

and thus the assumption of $\tau > 0.2$ for the applicability of the one-term approximate solution is verified.

4-84 EES Prob. 4-83 is reconsidered. The effect of the initial temperature of the ice block on the time period before the ice block starts melting is to be investigated.

Analysis The problem is solved using EES, and the solution is given below.

"GIVEN"

2*L_1=0.04 [m]
 L_2=L_1
 2*L_3=0.10 [m]
 T_i=-20 [C]
 T_infinity=18 [C]
 h=12 [W/m^2-C]
 T_L1_L2_L3=0 [C]

"PROPERTIES"

k=2.22 [W/m-C]
 alpha=0.124E-7 [m^2/s]

"ANALYSIS"

"This block can physically be formed by the intersection of two infinite plane wall of thickness 2L=4 cm and an infinite plane wall of thickness 2L=10 cm"

"For the two plane walls"

Bi_w1=(h*L_1)/k

"From Table 4-2 corresponding to this Bi number, we read"

lambda_1_w1=0.3208 "w stands for wall"

A_1_w1=1.0173

time*Convert(min, s)=tau_w1*L_1^2/alpha

"For the third plane wall"

Bi_w3=(h*L_3)/k

"From Table 4-2 corresponding to this Bi number, we read"

lambda_1_w3=0.4951

A_1_w3=1.0408

time*Convert(min, s)=tau_w3*L_3^2/alpha

theta_L_w1=A_1_w1*exp(-lambda_1_w1^2*tau_w1)*Cos(lambda_1_w1*L_1/L_1)

"theta_L_w1=(T_L_w1-T_infinity)/(T_i-T_infinity)"

theta_L_w3=A_1_w3*exp(-lambda_1_w3^2*tau_w3)*Cos(lambda_1_w3*L_3/L_3)

"theta_L_w3=(T_L_w3-T_infinity)/(T_i-T_infinity)"

(T_L1_L2_L3-T_infinity)/(T_i-T_infinity)=theta_L_w1^2*theta_L_w3 "corner temperature"

T _i [C]	time [min]
-26	1614
-24	1512
-22	1405
-20	1292
-18	1173
-16	1048
-14	914.9
-12	773.3
-10	621.9
-8	459.4
-6	283.7
-4	92.84

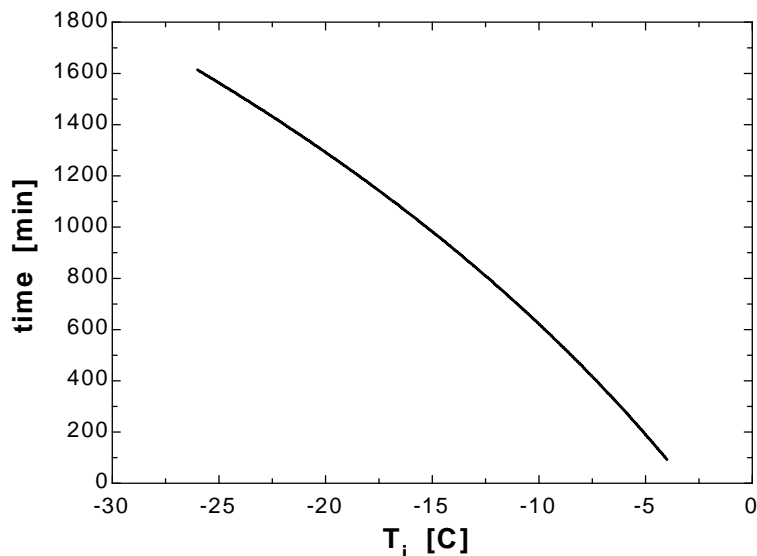

4-85 A cylindrical ice block is placed on a table. The initial temperature of the ice block to avoid melting for 2 h is to be determined.

Assumptions 1 Heat conduction in the ice block is two-dimensional, and thus the temperature varies in both x - and r - directions. **2** Heat transfer from the base of the ice block to the table is negligible. **3** The thermal properties of the ice block are constant. **4** The heat transfer coefficient is constant and uniform over the entire surface. **5** The Fourier number is $\tau > 0.2$ so that the one-term approximate solutions (or the transient temperature charts) are applicable (this assumption will be verified).

Properties The thermal properties of the ice are given to be $k = 2.22 \text{ W/m}\cdot\text{°C}$ and $\alpha = 0.124 \times 10^{-7} \text{ m}^2/\text{s}$.

Analysis This cylindrical ice block can be treated as a short cylinder that can physically be formed by the intersection of a long cylinder of diameter $D = 2 \text{ cm}$ and an infinite plane wall of thickness $2L = 4 \text{ cm}$. We measure x from the bottom surface of the block since this surface represents the adiabatic center surface of the plane wall of thickness $2L = 4 \text{ cm}$. The melting starts at the outer surfaces of the top surface when the temperature drops below 0°C at this location. The Biot numbers, the corresponding constants, and the Fourier numbers are

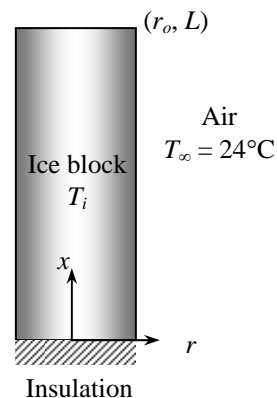

$$Bi_{\text{wall}} = \frac{hL}{k} = \frac{(13 \text{ W/m}^2 \cdot \text{°C})(0.02 \text{ m})}{(2.22 \text{ W/m}\cdot\text{°C})} = 0.1171 \longrightarrow \lambda_1 = 0.3319 \quad \text{and} \quad A_1 = 1.0187$$

$$Bi_{\text{cyl}} = \frac{hr_o}{k} = \frac{(13 \text{ W/m}^2 \cdot \text{°C})(0.01 \text{ m})}{(2.22 \text{ W/m}\cdot\text{°C})} = 0.05856 \longrightarrow \lambda_1 = 0.3393 \quad \text{and} \quad A_1 = 1.0144$$

$$\tau_{\text{wall}} = \frac{\alpha t}{L^2} = \frac{(0.124 \times 10^{-7} \text{ m}^2/\text{s})(3 \text{ h} \times 3600 \text{ s/h})}{(0.02 \text{ m})^2} = 0.3348 > 0.2$$

$$\tau_{\text{cyl}} = \frac{\alpha t}{r_o^2} = \frac{(0.124 \times 10^{-7} \text{ m}^2/\text{s})(3 \text{ h} \times 3600 \text{ s/h})}{(0.01 \text{ m})^2} = 1.3392 > 0.2$$

Note that $\tau > 0.2$ in all dimensions and thus the one-term approximate solution for transient heat conduction is applicable. The product solution for this problem can be written as

$$\begin{aligned} \theta(L, r_o, t)_{\text{block}} &= \theta(L, t)_{\text{wall}} \theta(r_o, t)_{\text{cyl}} \\ \frac{0 - 24}{T_i - 24} &= \left[A_1 e^{-\lambda_1^2 \tau} \cos(\lambda_1 L / L) \right] \left[A_1 e^{-\lambda_1^2 \tau} J_0(\lambda_1 r_o / r_o) \right] \\ \frac{0 - 24}{T_i - 24} &= \left[(1.0187) e^{-(0.3319)^2 (0.3348)} \cos(0.3319) \right] \left[(1.0146) e^{-(0.3393)^2 (1.3392)} (0.9708) \right] \end{aligned}$$

which gives $T_i = -6.6^\circ\text{C}$

Therefore, the ice will not start melting for at least 3 hours if its initial temperature is -6.6°C or below.

4-86 A cubic block and a cylindrical block are exposed to hot gases on all of their surfaces. The center temperatures of each geometry in 10, 20, and 60 min are to be determined.

Assumptions 1 Heat conduction in the cubic block is three-dimensional, and thus the temperature varies in all x -, y -, and z - directions. **2** Heat conduction in the cylindrical block is two-dimensional, and thus the temperature varies in both axial x - and radial r - directions. **3** The thermal properties of the granite are constant. **4** The heat transfer coefficient is constant and uniform over the entire surface. **5** The Fourier number is $\tau > 0.2$ so that the one-term approximate solutions (or the transient temperature charts) are applicable (this assumption will be verified).

Properties The thermal properties of the granite are given to be $k = 2.5 \text{ W/m}\cdot\text{°C}$ and $\alpha = 1.15 \times 10^{-6} \text{ m}^2/\text{s}$.

Analysis:

Cubic block: This cubic block can physically be formed by the intersection of three infinite plane walls of thickness $2L = 5 \text{ cm}$.

After 10 minutes: The Biot number, the corresponding constants, and the Fourier number are

$$Bi = \frac{hL}{k} = \frac{(40 \text{ W/m}^2\cdot\text{°C})(0.025 \text{ m})}{(2.5 \text{ W/m}\cdot\text{°C})} = 0.400 \longrightarrow \lambda_1 = 0.5932 \quad \text{and} \quad A_1 = 1.0580$$

$$\tau = \frac{\alpha t}{L^2} = \frac{(1.15 \times 10^{-6} \text{ m}^2/\text{s})(10 \text{ min} \times 60 \text{ s/min})}{(0.025 \text{ m})^2} = 1.104 > 0.2$$

To determine the center temperature, the product solution can be written as

$$\begin{aligned} \theta(0,0,0,t)_{\text{block}} &= [\theta(0,t)_{\text{wall}}]^3 \\ \frac{T(0,0,0,t) - T_\infty}{T_i - T_\infty} &= \left(A_1 e^{-\lambda_1^2 \tau} \right)^3 \\ \frac{T(0,0,0,t) - 500}{20 - 500} &= \left\{ (1.0580) e^{-(0.5932)^2 (1.104)} \right\}^3 = 0.369 \\ T(0,0,0,t) &= \mathbf{323^\circ\text{C}} \end{aligned}$$

5 cm \times 5 cm \times 5 cm

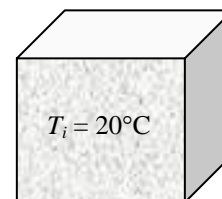

Hot gases
500°C

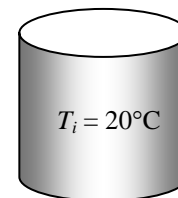

After 20 minutes

$$\tau = \frac{\alpha t}{L^2} = \frac{(1.15 \times 10^{-6} \text{ m}^2/\text{s})(20 \text{ min} \times 60 \text{ s/min})}{(0.025 \text{ m})^2} = 2.208 > 0.2$$

$$\frac{T(0,0,0,t) - 500}{20 - 500} = \left\{ (1.0580) e^{-(0.5932)^2 (2.208)} \right\}^3 = 0.115 \longrightarrow T(0,0,0,t) = \mathbf{445^\circ\text{C}}$$

After 60 minutes

$$\tau = \frac{\alpha t}{L^2} = \frac{(1.15 \times 10^{-6} \text{ m}^2/\text{s})(60 \text{ min} \times 60 \text{ s/min})}{(0.025 \text{ m})^2} = 6.624 > 0.2$$

$$\frac{T(0,0,0,t) - 500}{20 - 500} = \left\{ (1.0580) e^{-(0.5932)^2 (6.624)} \right\}^3 = 0.00109 \longrightarrow T(0,0,0,t) = \mathbf{500^\circ\text{C}}$$

Note that $\tau > 0.2$ in all dimensions and thus the one-term approximate solution for transient heat conduction is applicable.

Cylinder: This cylindrical block can physically be formed by the intersection of a long cylinder of radius $r_o = D/2 = 2.5$ cm and a plane wall of thickness $2L = 5$ cm.

After 10 minutes: The Biot number and the corresponding constants for the long cylinder are

$$Bi = \frac{hr_o}{k} = \frac{(40 \text{ W/m}^2 \cdot \text{°C})(0.025 \text{ m})}{(2.5 \text{ W/m} \cdot \text{°C})} = 0.400 \longrightarrow \lambda_1 = 0.8516 \quad \text{and} \quad A_1 = 1.0931$$

To determine the center temperature, the product solution can be written as

$$\begin{aligned} \theta(0,0,t)_{block} &= [\theta(0,t)_{wall}] [\theta(0,t)_{cyl}] \\ \frac{T(0,0,t) - T_\infty}{T_i - T_\infty} &= \left(A_1 e^{-\lambda_1^2 \tau} \right)_{wall} \left(A_1 e^{-\lambda_1^2 \tau} \right)_{cyl} \\ \frac{T(0,0,t) - 500}{20 - 500} &= \left\{ (1.0580) e^{-(0.5932)^2 (1.104)} \right\} \left\{ (1.0931) e^{-(0.8516)^2 (1.104)} \right\} = 0.352 \longrightarrow T(0,0,t) = \mathbf{331^\circ\text{C}} \end{aligned}$$

After 20 minutes

$$\frac{T(0,0,t) - 500}{20 - 500} = \left\{ (1.0580) e^{-(0.5932)^2 (2.208)} \right\} \left\{ (1.0931) e^{-(0.8516)^2 (2.208)} \right\} = 0.107 \longrightarrow T(0,0,t) = \mathbf{449^\circ\text{C}}$$

After 60 minutes

$$\frac{T(0,0,t) - 500}{20 - 500} = \left\{ (1.0580) e^{-(0.5932)^2 (6.624)} \right\} \left\{ (1.0931) e^{-(0.8516)^2 (6.624)} \right\} = 0.00092 \longrightarrow T(0,0,t) = \mathbf{500^\circ\text{C}}$$

Note that $\tau > 0.2$ in all dimensions and thus the one-term approximate solution for transient heat conduction is applicable.

4-87 A cubic block and a cylindrical block are exposed to hot gases on all of their surfaces. The center temperatures of each geometry in 10, 20, and 60 min are to be determined.

Assumptions 1 Heat conduction in the cubic block is three-dimensional, and thus the temperature varies in all x -, y -, and z - directions. **2** Heat conduction in the cylindrical block is two-dimensional, and thus the temperature varies in both axial x - and radial r - directions. **3** The thermal properties of the granite are constant. **4** The heat transfer coefficient is constant and uniform over the entire surface. **5** The Fourier number is $\tau > 0.2$ so that the one-term approximate solutions (or the transient temperature charts) are applicable (this assumption will be verified).

Properties The thermal properties of the granite are $k = 2.5 \text{ W/m}\cdot\text{°C}$ and $\alpha = 1.15 \times 10^{-6} \text{ m}^2/\text{s}$.

Analysis:

Cubic block: This cubic block can physically be formed by the intersection of three infinite plane wall of thickness $2L = 5 \text{ cm}$. Two infinite plane walls are exposed to the hot gases with a heat transfer coefficient of $h = 40 \text{ W/m}^2\cdot\text{°C}$ and one with $h = 80 \text{ W/m}^2\cdot\text{°C}$.

After 10 minutes: The Biot number and the corresponding constants for $h = 40 \text{ W/m}^2\cdot\text{°C}$ are

$$Bi = \frac{hL}{k} = \frac{(40 \text{ W/m}^2\cdot\text{°C})(0.025 \text{ m})}{(2.5 \text{ W/m}\cdot\text{°C})} = 0.400 \longrightarrow \lambda_1 = 0.5932 \quad \text{and} \quad A_1 = 1.0580$$

The Biot number and the corresponding constants for $h = 80 \text{ W/m}^2\cdot\text{°C}$ are

$$Bi = \frac{hL}{k} = \frac{(80 \text{ W/m}^2\cdot\text{°C})(0.025 \text{ m})}{(2.5 \text{ W/m}\cdot\text{°C})} = 0.800$$

$$\longrightarrow \lambda_1 = 0.7910 \quad \text{and} \quad A_1 = 1.1016$$

The Fourier number is

$$\tau = \frac{\alpha t}{L^2} = \frac{(1.15 \times 10^{-6} \text{ m}^2/\text{s})(10 \text{ min} \times 60 \text{ s/min})}{(0.025 \text{ m})^2} = 1.104 > 0.2$$

To determine the center temperature, the product solution method can be written as

$$\begin{aligned} \theta(0,0,0,t)_{\text{block}} &= [\theta(0,t)_{\text{wall}}]^2 [\theta(0,t)_{\text{wall}}] \\ \frac{T(0,0,0,t) - T_\infty}{T_i - T_\infty} &= \left(A_1 e^{-\lambda_1^2 \tau} \right)^2 \left(A_1 e^{-\lambda_1^2 \tau} \right) \\ \frac{T(0,0,0,t) - 500}{20 - 500} &= \left\{ (1.0580) e^{-(0.5932)^2 (1.104)} \right\}^2 \left\{ (1.1016) e^{-(0.7910)^2 (1.104)} \right\} = 0.284 \end{aligned}$$

$$T(0,0,0,t) = 364^\circ\text{C}$$

After 20 minutes

$$\tau = \frac{\alpha t}{L^2} = \frac{(1.15 \times 10^{-6} \text{ m}^2/\text{s})(20 \text{ min} \times 60 \text{ s/min})}{(0.025 \text{ m})^2} = 2.208 > 0.2$$

$$\frac{T(0,0,0,t) - 500}{20 - 500} = \left\{ (1.0580) e^{-(0.5932)^2 (2.208)} \right\}^2 \left\{ (1.1016) e^{-(0.7910)^2 (2.208)} \right\} = 0.0654$$

$$\longrightarrow T(0,0,0,t) = 469^\circ\text{C}$$

5 cm × 5 cm × 5 cm

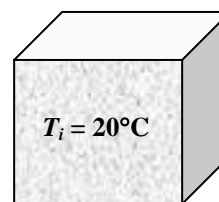

Hot gases
500°C

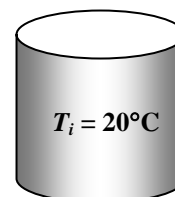

After 60 minutes

$$\tau = \frac{\alpha t}{L^2} = \frac{(1.15 \times 10^{-6} \text{ m}^2/\text{s})(60 \text{ min} \times 60 \text{ s/min})}{(0.025 \text{ m})^2} = 6.624 > 0.2$$

$$\frac{T(0,0,0,t) - 500}{20 - 500} = \left\{ (1.0580)e^{-(0.5932)^2(6.624)} \right\}^2 \left\{ (1.1016)e^{-(0.7910)^2(6.624)} \right\} = 0.000186$$

$$\longrightarrow T(0,0,0,t) = \mathbf{500^\circ\text{C}}$$

Note that $\tau > 0.2$ in all dimensions and thus the one-term approximate solution for transient heat conduction is applicable.

Cylinder: This cylindrical block can physically be formed by the intersection of a long cylinder of radius $r_o = D/2 = 2.5$ cm exposed to the hot gases with a heat transfer coefficient of $h = 40 \text{ W/m}^2 \cdot ^\circ\text{C}$ and a plane wall of thickness $2L = 5$ cm exposed to the hot gases with $h = 80 \text{ W/m}^2 \cdot ^\circ\text{C}$.

After 10 minutes: The Biot number and the corresponding constants for the long cylinder are

$$Bi = \frac{hr_o}{k} = \frac{(40 \text{ W/m}^2 \cdot ^\circ\text{C})(0.025 \text{ m})}{(2.5 \text{ W/m} \cdot ^\circ\text{C})} = 0.400 \longrightarrow \lambda_1 = 0.8516 \text{ and } A_1 = 1.0931$$

To determine the center temperature, the product solution method can be written as

$$\begin{aligned} \theta(0,0,t)_{\text{block}} &= [\theta(0,t)_{\text{wall}}][\theta(0,t)_{\text{cyl}}] \\ \frac{T(0,0,t) - T_\infty}{T_i - T_\infty} &= \left(A_1 e^{-\lambda_1^2 \tau} \right)_{\text{wall}} \left(A_1 e^{-\lambda_1^2 \tau} \right)_{\text{cyl}} \\ \frac{T(0,0,t) - 500}{20 - 500} &= \left\{ (1.1016)e^{-(0.7910)^2(1.104)} \right\} \left\{ (1.0931)e^{-(0.8516)^2(1.104)} \right\} = 0.271 \\ T(0,0,t) &= \mathbf{370^\circ\text{C}} \end{aligned}$$

After 20 minutes

$$\frac{T(0,0,t) - 500}{20 - 500} = \left\{ (1.1016)e^{-(0.7910)^2(2.208)} \right\} \left\{ (1.0931)e^{-(0.8516)^2(2.208)} \right\} = 0.06094 \longrightarrow T(0,0,t) = \mathbf{471^\circ\text{C}}$$

After 60 minutes

$$\frac{T(0,0,t) - 500}{20 - 500} = \left\{ (1.1016)e^{-(0.7910)^2(6.624)} \right\} \left\{ (1.0931)e^{-(0.8516)^2(6.624)} \right\} = 0.0001568 \longrightarrow T(0,0,t) = \mathbf{500^\circ\text{C}}$$

Note that $\tau > 0.2$ in all dimensions and thus the one-term approximate solution for transient heat conduction is applicable.

4-88 A cylindrical aluminum block is heated in a furnace. The length of time the block should be kept in the furnace and the amount of heat transfer to the block are to be determined.

Assumptions 1 Heat conduction in the cylindrical block is two-dimensional, and thus the temperature varies in both axial x - and radial r - directions. **2** The thermal properties of the aluminum are constant. **3** The heat transfer coefficient is constant and uniform over the entire surface. **4** The Fourier number is $\tau > 0.2$ so that the one-term approximate solutions (or the transient temperature charts) are applicable (it will be verified).

Properties The thermal properties of the aluminum block are given to be $k = 236 \text{ W/m}\cdot\text{°C}$, $\rho = 2702 \text{ kg/m}^3$, $c_p = 0.896 \text{ kJ/kg}\cdot\text{°C}$, and $\alpha = 9.75 \times 10^{-5} \text{ m}^2/\text{s}$.

Analysis This cylindrical aluminum block can physically be formed by the intersection of an infinite plane wall of thickness $2L = 20 \text{ cm}$, and a long cylinder of radius $r_o = D/2 = 7.5 \text{ cm}$. The Biot numbers and the corresponding constants are first determined to be

$$Bi = \frac{hL}{k} = \frac{(80 \text{ W/m}^2\cdot\text{°C})(0.1 \text{ m})}{(236 \text{ W/m}\cdot\text{°C})} = 0.0339 \quad \longrightarrow \lambda_1 = 0.1811 \quad \text{and} \quad A_1 = 1.0056$$

$$Bi = \frac{hr_o}{k} = \frac{(80 \text{ W/m}^2\cdot\text{°C})(0.075 \text{ m})}{236 \text{ W/m}\cdot\text{°C}} = 0.0254 \quad \longrightarrow \lambda_1 = 0.2217 \quad \text{and} \quad A_1 = 1.0063$$

Noting that $\tau = \alpha t / L^2$ and assuming $\tau > 0.2$ in all dimensions and thus the one-term approximate solution for transient heat conduction is applicable, the product solution for this problem can be written as

$$\begin{aligned} \theta(0,0,t)_{\text{block}} &= \theta(0,t)_{\text{wall}} \theta(0,t)_{\text{cyl}} = \left(A_1 e^{-\lambda_1^2 \tau} \right)_{\text{wall}} \left(A_1 e^{-\lambda_1^2 \tau} \right)_{\text{cyl}} \\ \frac{300-1200}{20-1200} &= \left\{ (1.0056) \exp \left[- (0.1811)^2 \frac{(9.75 \times 10^{-5}) t}{(0.1)^2} \right] \right\} \times \left\{ (1.0063) \exp \left[- (0.2217)^2 \frac{(9.75 \times 10^{-5}) t}{(0.075)^2} \right] \right\} \\ &= 0.7627 \end{aligned}$$

Solving for the time t gives

$$t = 241 \text{ s} = \mathbf{4.0 \text{ min.}}$$

We note that

$$\begin{aligned} \tau_{\text{wall}} &= \frac{\alpha t}{L^2} = \frac{(9.75 \times 10^{-5} \text{ m}^2/\text{s})(241 \text{ s})}{(0.1 \text{ m})^2} = 2.350 > 0.2 \\ \tau_{\text{cyl}} &= \frac{\alpha t}{r_o^2} = \frac{(9.75 \times 10^{-5} \text{ m}^2/\text{s})(241 \text{ s})}{(0.075 \text{ m})^2} = 4.177 > 0.2 \end{aligned}$$

and thus the assumption of $\tau > 0.2$ for the applicability of the one-term approximate solution is verified. The dimensionless temperatures at the center are

$$\begin{aligned} \theta(0,t)_{\text{wall}} &= \left(A_1 e^{-\lambda_1^2 \tau} \right)_{\text{wall}} = (1.0056) \exp \left[- (0.1811)^2 (2.350) \right] = 0.9310 \\ \theta(0,t)_{\text{cyl}} &= \left(A_1 e^{-\lambda_1^2 \tau} \right)_{\text{cyl}} = (1.0063) \exp \left[- (0.2217)^2 (4.177) \right] = 0.8195 \end{aligned}$$

The maximum amount of heat transfer is

$$\begin{aligned} m &= \rho \mathcal{V} = \rho \pi r_o^2 L = (2702 \text{ kg/m}^3) \left[\pi (0.075 \text{ m})^2 (0.2 \text{ m}) \right] = 9.550 \text{ kg} \\ Q_{\text{max}} &= mc_p (T_i - T_\infty) = (9.550 \text{ kg})(0.896 \text{ kJ/kg}\cdot\text{°C})(20 - 1200)\text{°C} = 10,100 \text{ kJ} \end{aligned}$$

Then we determine the dimensionless heat transfer ratios for both geometries as

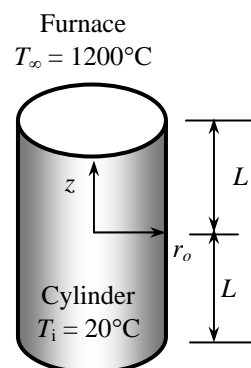

$$\left(\frac{Q}{Q_{\max}}\right)_{\text{wall}} = 1 - \theta_{o,\text{wall}} \frac{\sin(\lambda_1)}{\lambda_1} = 1 - (0.9310) \frac{\sin(0.1811)}{0.1811} = 0.07408$$

$$\left(\frac{Q}{Q_{\max}}\right)_{\text{cyl}} = 1 - 2\theta_{o,\text{cyl}} \frac{J_1(\lambda_1)}{\lambda_1} = 1 - 2(0.8195) \frac{0.1101}{0.2217} = 0.1860$$

The heat transfer ratio for the short cylinder is

$$\begin{aligned} \left(\frac{Q}{Q_{\max}}\right)_{\text{short cylinder}} &= \left(\frac{Q}{Q_{\max}}\right)_{\text{plane wall}} + \left(\frac{Q}{Q_{\max}}\right)_{\text{long cylinder}} \left[1 - \left(\frac{Q}{Q_{\max}}\right)_{\text{plane wall}} \right] \\ &= 0.07408 + (0.1860)(1 - 0.07408) = 0.2463 \end{aligned}$$

Then the total heat transfer from the short cylinder as it is cooled from 300°C at the center to 20°C becomes

$$Q = 0.2463 Q_{\max} = (0.2463)(10,100 \text{ kJ}) = \mathbf{2490 \text{ kJ}}$$

which is identical to the heat transfer to the cylinder as the cylinder at 20°C is heated to 300°C at the center.

4-89 A cylindrical aluminum block is heated in a furnace. The length of time the block should be kept in the furnace and the amount of heat transferred to the block are to be determined.

Assumptions **1** Heat conduction in the cylindrical block is two-dimensional, and thus the temperature varies in both axial x - and radial r - directions. **2** Heat transfer from the bottom surface of the block is negligible. **3** The thermal properties of the aluminum are constant. **4** The heat transfer coefficient is constant and uniform over the entire surface. **5** The Fourier number is $\tau > 0.2$ so that the one-term approximate solutions (or the transient temperature charts) are applicable (this assumption will be verified).

Properties The thermal properties of the aluminum block are given to be $k = 236 \text{ W/m}\cdot^\circ\text{C}$, $\rho = 2702 \text{ kg/m}^3$, $c_p = 0.896 \text{ kJ/kg}\cdot^\circ\text{C}$, and $\alpha = 9.75 \times 10^{-5} \text{ m}^2/\text{s}$.

Analysis This cylindrical aluminum block can physically be formed by the intersection of an infinite plane wall of thickness $2L = 40 \text{ cm}$ and a long cylinder of radius $r_o = D/2 = 7.5 \text{ cm}$. Note that the height of the short cylinder represents the half thickness of the infinite plane wall where the bottom surface of the short cylinder is adiabatic. The Biot numbers and corresponding constants are first determined to be

$$Bi = \frac{hL}{k} = \frac{(80 \text{ W/m}^2\cdot^\circ\text{C})(0.2 \text{ m})}{(236 \text{ W/m}\cdot^\circ\text{C})} = 0.0678 \rightarrow \lambda_1 = 0.2568 \text{ and } A_1 = 1.0110$$

$$Bi = \frac{hr_o}{k} = \frac{(80 \text{ W/m}^2\cdot^\circ\text{C})(0.075 \text{ m})}{(236 \text{ W/m}\cdot^\circ\text{C})} = 0.0254 \rightarrow \lambda_1 = 0.2217 \text{ and } A_1 = 1.0063$$

Noting that $\tau = \alpha t / L^2$ and assuming $\tau > 0.2$ in all dimensions and thus the one-term approximate solution for transient heat conduction is applicable, the product solution for this problem can be written as

$$\begin{aligned} \theta(0,0,t)_{\text{block}} &= \theta(0,t)_{\text{wall}} \theta(0,t)_{\text{cyl}} = \left(A_1 e^{-\lambda_1^2 \tau} \right)_{\text{wall}} \left(A_1 e^{-\lambda_1^2 \tau} \right)_{\text{cyl}} \\ \frac{300-1200}{20-1200} &= \left\{ (1.0110) \exp \left[- (0.2568)^2 \frac{(9.75 \times 10^{-5}) t}{(0.2)^2} \right] \right\} \left\{ (1.0063) \exp \left[- (0.2217)^2 \frac{(9.75 \times 10^{-5}) t}{(0.075)^2} \right] \right\} \\ &= 0.7627 \end{aligned}$$

Solving for the time t gives

$$t = 285 \text{ s} = \mathbf{4.7 \text{ min.}}$$

We note that

$$\tau_{\text{wall}} = \frac{\alpha t}{L^2} = \frac{(9.75 \times 10^{-5} \text{ m}^2/\text{s})(285 \text{ s})}{(0.2 \text{ m})^2} = 0.6947 > 0.2$$

$$\tau_{\text{cyl}} = \frac{\alpha t}{r_o^2} = \frac{(9.75 \times 10^{-5} \text{ m}^2/\text{s})(285 \text{ s})}{(0.075 \text{ m})^2} = 4.940 > 0.2$$

and thus the assumption of $\tau > 0.2$ for the applicability of the one-term approximate solution is verified. The dimensionless temperatures at the center are

$$\theta(0,t)_{\text{wall}} = \left(A_1 e^{-\lambda_1^2 \tau} \right)_{\text{wall}} = (1.0110) \exp \left[- (0.2568)^2 (0.6947) \right] = 0.9658$$

$$\theta(0,t)_{\text{cyl}} = \left(A_1 e^{-\lambda_1^2 \tau} \right)_{\text{cyl}} = (1.0063) \exp \left[- (0.2217)^2 (4.940) \right] = 0.7897$$

The maximum amount of heat transfer is

$$\begin{aligned} m &= \rho \mathcal{V} = \rho \pi r_o L = (2702 \text{ kg/m}^3) \left[\pi (0.075 \text{ m})^2 (0.2 \text{ m}) \right] = 9.55 \text{ kg} \\ Q_{\text{max}} &= mc_p (T_i - T_\infty) = (9.55 \text{ kg})(0.896 \text{ kJ/kg}\cdot^\circ\text{C})(20 - 1200)^\circ\text{C} = 10,100 \text{ kJ} \end{aligned}$$

Then we determine the dimensionless heat transfer ratios for both geometries as

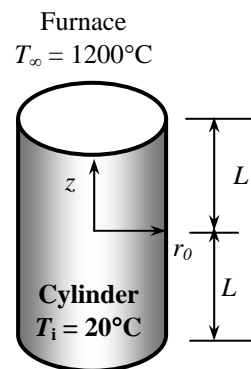

$$\left(\frac{Q}{Q_{\max}}\right)_{\text{wall}} = 1 - \theta_{o,\text{wall}} \frac{\sin(\lambda_1)}{\lambda_1} = 1 - (0.9658) \frac{\sin(0.2568)}{0.2568} = 0.04477$$

$$\left(\frac{Q}{Q_{\max}}\right)_{\text{cyl}} = 1 - 2\theta_{o,\text{cyl}} \frac{J_1(\lambda_1)}{\lambda_1} = 1 - 2(0.7897) \frac{0.1101}{0.2217} = 0.2156$$

The heat transfer ratio for the short cylinder is

$$\begin{aligned} \left(\frac{Q}{Q_{\max}}\right)_{\text{short cylinder}} &= \left(\frac{Q}{Q_{\max}}\right)_{\text{plane wall}} + \left(\frac{Q}{Q_{\max}}\right)_{\text{long cylinder}} \left[1 - \left(\frac{Q}{Q_{\max}}\right)_{\text{plane wall}} \right] \\ &= 0.04477 + (0.2156)(1 - 0.04477) = 0.2507 \end{aligned}$$

Then the total heat transfer from the short cylinder as it is cooled from 300°C at the center to 20°C becomes

$$Q = 0.2507 Q_{\max} = (0.2507)(10,100 \text{ kJ}) = \mathbf{2530 \text{ kJ}}$$

which is identical to the heat transfer to the cylinder as the cylinder at 20°C is heated to 300°C at the center.

4-90 EES Prob. 4-88 is reconsidered. The effect of the final center temperature of the block on the heating time and the amount of heat transfer is to be investigated.

Analysis The problem is solved using EES, and the solution is given below.

"GIVEN"

L=0.20 [m]
 $2*r_o=0.15$ [m]
 $T_i=20$ [C]
 $T_{infinity}=1200$ [C]
 $T_{o_o}=300$ [C]
 $h=80$ [W/m²-C]

"PROPERTIES"

$k=236$ [W/m-C]
 $\rho=2702$ [kg/m³]
 $C_p=0.896$ [kJ/kg-C]
 $\alpha=9.75E-5$ [m²/s]

"ANALYSIS"

"This short cylinder can physically be formed by the intersection of a long cylinder of radius r_o and a plane wall of thickness $2L$ "

"For plane wall"

$Bi_w=(h*L)/k$

"From Table 4-1 corresponding to this Bi number, we read"

$\lambda_{1_w}=0.2568$ "w stands for wall"

$A_{1_w}=1.0110$

$\tau_w=(\alpha*time)/L^2$

$\theta_{o_w}=A_{1_w}*exp(-\lambda_{1_w}^2*\tau_w)$ " $\theta_{o_w}=(T_{o_w}-T_{infinity})/(T_i-T_{infinity})$ "

"For long cylinder"

$Bi_c=(h*r_o)/k$ "c stands for cylinder"

"From Table 4-2 corresponding to this Bi number, we read"

$\lambda_{1_c}=0.2217$

$A_{1_c}=1.0063$

$\tau_c=(\alpha*time)/r_o^2$

$\theta_{o_c}=A_{1_c}*exp(-\lambda_{1_c}^2*\tau_c)$ " $\theta_{o_c}=(T_{o_c}-T_{infinity})/(T_i-T_{infinity})$ "
 $(T_{o_o}-T_{infinity})/(T_i-T_{infinity})=\theta_{o_w}*\theta_{o_c}$ "center temperature of cylinder"

$V=\pi*r_o^2*L$

$m=\rho*V$

$Q_{max}=m*C_p*(T_{infinity}-T_i)$

$Q_w=1-\theta_{o_w}*Sin(\lambda_{1_w})/\lambda_{1_w}$ " $Q_w=(Q/Q_{max})_w$ "

$Q_c=1-2*\theta_{o_c}*J_1/\lambda_{1_c}$ " $Q_c=(Q/Q_{max})_c$ "

$J_1=0.1101$ "From Table 4-3, at λ_{1_c} "

$Q/Q_{max}=Q_w+Q_c*(1-Q_w)$ "total heat transfer"

$T_{o,o}$ [C]	time [s]	Q [kJ]
50	42.43	430.3
100	86.33	850.6
150	132.3	1271
200	180.4	1691
250	231.1	2111
300	284.5	2532
350	340.9	2952
400	400.8	3372
450	464.5	3793
500	532.6	4213
550	605.8	4633
600	684.9	5053
650	770.8	5474
700	864.9	5894
750	968.9	6314
800	1085	6734
850	1217	7155
900	1369	7575
950	1549	7995
1000	1770	8416

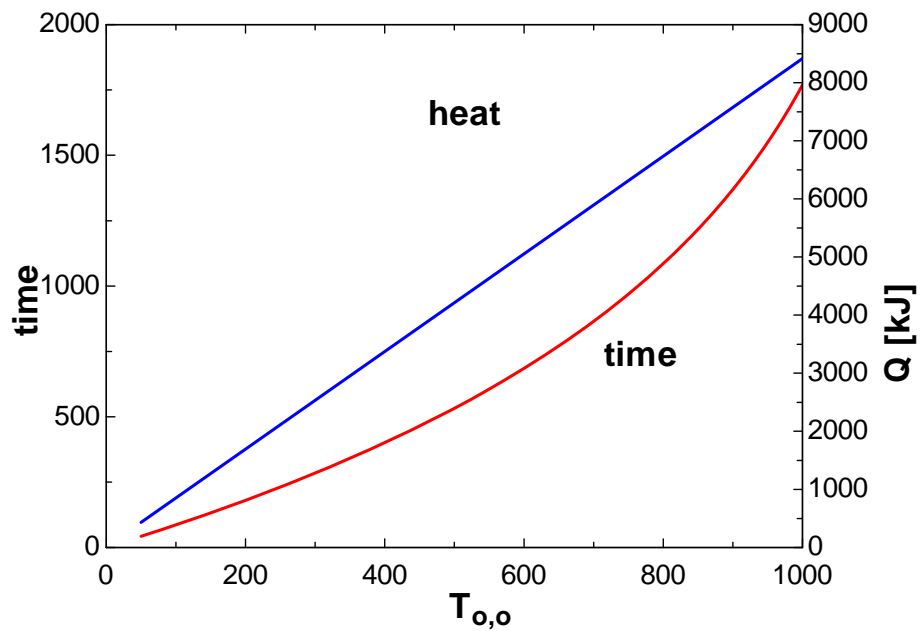

Special Topic: Refrigeration and Freezing of Foods

4-91C The common kinds of microorganisms are bacteria, yeasts, molds, and viruses. The undesirable changes caused by microorganisms are off-flavors and colors, slime production, changes in the texture and appearances, and the spoilage of foods.

4-92C Microorganisms are the prime cause for the spoilage of foods. Refrigeration prevents or delays the spoilage of foods by reducing the rate of growth of microorganisms. Freezing extends the storage life of foods for months by preventing the growths of microorganisms.

4-93C The environmental factors that affect the growth rate of microorganisms are the temperature, the relative humidity, the oxygen level of the environment, and air motion.

4-94C Cooking kills the microorganisms in foods, and thus prevents spoilage of foods. It is important to raise the internal temperature of a roast in an oven above 70°C since most microorganisms, including some that cause diseases, may survive temperatures below 70°C.

4-95C The contamination of foods with microorganisms can be prevented or minimized by (1) preventing contamination by following strict sanitation practices such as washing hands and using fine filters in ventilation systems, (2) inhibiting growth by altering the environmental conditions, and (3) destroying the organisms by heat treatment or chemicals.

The growth of microorganisms in foods can be retarded by keeping the temperature below 4°C and relative humidity below 60 percent. Microorganisms can be destroyed by heat treatment, chemicals, ultraviolet light, and solar radiation.

4-96C (a) High air motion retards the growth of microorganisms in foods by keeping the food surfaces dry, and creating an undesirable environment for the microorganisms. (b) Low relative humidity (dry) environments also retard the growth of microorganisms by depriving them of water that they need to grow. Moist air supplies the microorganisms with the water they need, and thus encourages their growth. Relative humidities below 60 percent prevent the growth rate of most microorganisms on food surfaces.

4-97C Cooling the carcass with refrigerated air is at -10°C would certainly reduce the cooling time, but this proposal should be rejected since it will cause the outer parts of the carcasses to freeze, which is undesirable. Also, the refrigeration unit will consume more power to reduce the temperature to -10°C, and thus it will have a lower efficiency.

4-98C The freezing time could be decreased by (a) lowering the temperature of the refrigerated air, (b) increasing the velocity of air, (c) increasing the capacity of the refrigeration system, and (d) decreasing the size of the meat boxes.

4-99C The rate of freezing can affect color, tenderness, and drip. Rapid freezing increases tenderness and reduces the tissue damage and the amount of drip after thawing.

4-100C This claim is reasonable since the lower the storage temperature, the longer the storage life of beef. This is because some water remains unfrozen even at subfreezing temperatures, and the lower the temperature, the smaller the unfrozen water content of the beef.

4-101C A refrigerated shipping dock is a refrigerated space where the orders are assembled and shipped out. Such docks save valuable storage space from being used for shipping purpose, and provide a more acceptable working environment for the employees. The refrigerated shipping docks are usually maintained at 1.5°C, and therefore the air that flows into the freezer during shipping is already cooled to about 1.5°C. This reduces the refrigeration load of the cold storage rooms.

4-102C (a) The heat transfer coefficient during immersion cooling is much higher, and thus the cooling time during immersion chilling is much lower than that during forced air chilling. (b) The cool air chilling can cause a moisture loss of 1 to 2 percent while water immersion chilling can actually cause moisture absorption of 4 to 15 percent. (c) The chilled water circulated during immersion cooling encourages microbial growth, and thus immersion chilling is associated with more microbial growth. The problem can be minimized by adding chloride to the water.

4-103C The proper storage temperature of frozen poultry is about -18°C or below. The primary freezing methods of poultry are the air blast tunnel freezing, cold plates, immersion freezing, and cryogenic cooling.

4-104C The factors, which affect the quality of frozen, fish are the condition of the fish before freezing, the freezing method, and the temperature and humidity during storage and transportation, and the length of storage time.

4-105 The chilling room of a meat plant with a capacity of 350 beef carcasses is considered. The cooling load and the air flow rate are to be determined.

Assumptions 1 Steady operating conditions exist. **2** Specific heats of beef carcass and air are constant.

Properties The density and specific heat of air at 0°C are given to be 1.28 kg/m³ and 1.0 kJ/kg·°C. The specific heat of beef carcass is given to be 3.14 kJ/kg·°C.

Analysis (a) The amount of beef mass that needs to be cooled per unit time is

$$\begin{aligned}\dot{m}_{beef} &= (\text{Total beef mass cooled})/(\text{cooling time}) \\ &= (350 \times 220 \text{ kg/carcass})/(12 \text{ h} \times 3600 \text{ s}) = 1.782 \text{ kg/s}\end{aligned}$$

The product refrigeration load can be viewed as the energy that needs to be removed from the beef carcass as it is cooled from 35 to 16°C at a rate of 2.27 kg/s, and is determined to be

$$\begin{aligned}\dot{Q}_{beef} &= (\dot{m}c_p\Delta T)_{beef} \\ &= (1.782 \text{ kg/s})(3.14 \text{ kJ/kg}\cdot^\circ\text{C})(35 - 16)^\circ\text{C} = 106 \text{ kW}\end{aligned}$$

Then the total refrigeration load of the chilling room becomes

$$\dot{Q}_{\text{total, chilling room}} = \dot{Q}_{beef} + \dot{Q}_{fan} + \dot{Q}_{lights} + \dot{Q}_{\text{heat gain}} = 106 + 22 + 2 + 14 = \mathbf{144 \text{ kW}}$$

(b) Heat is transferred to air at the rate determined above, and the temperature of air rises from -2.2°C to 0.5°C as a result. Therefore, the mass flow rate of air is

$$\dot{m}_{air} = \frac{\dot{Q}_{air}}{(c_p\Delta T)_{air}} = \frac{144 \text{ kW}}{(1.0 \text{ kJ/kg}\cdot^\circ\text{C})(0.5 - (-2.2)^\circ\text{C})} = 53.3 \text{ kg/s}$$

Then the volume flow rate of air becomes

$$\dot{V}_{air} = \frac{\dot{m}_{air}}{\rho_{air}} = \frac{53.3 \text{ kg/s}}{1.28 \text{ kg/m}^3} = \mathbf{41.7 \text{ m}^3/\text{s}}$$

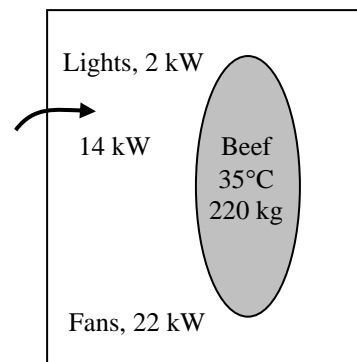

4-106 Turkeys are to be frozen by submerging them into brine at -29°C . The time it will take to reduce the temperature of turkey breast at a depth of 3.8 cm to -18°C and the amount of heat transfer per turkey are to be determined.

Assumptions 1 Steady operating conditions exist. **2** The thermal properties of turkeys are constant.

Properties It is given that the specific heats of turkey are 2.98 and 1.65 kJ/kg $\cdot^{\circ}\text{C}$ above and below the freezing point of -2.8°C , respectively, and the latent heat of fusion of turkey is 214 kJ/kg.

Analysis The time required to freeze the turkeys from 1°C to -18°C with brine at -29°C can be determined directly from Fig. 4-54 to be

$$t \cong 180 \text{ min.} \cong \mathbf{3 \text{ hours}}$$

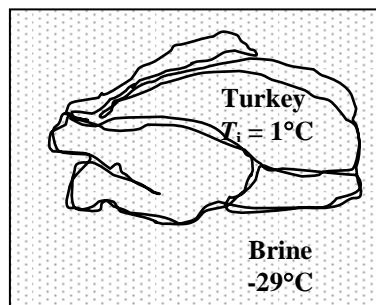

(a) Assuming the entire water content of turkey is frozen, the amount of heat that needs to be removed from the turkey as it is cooled from 1°C to -18°C is

$$\text{Cooling to } -2.8^{\circ}\text{C}: Q_{\text{cooling,fresh}} = (mc_p \Delta T)_{\text{fresh}} = (7 \text{ kg})(2.98 \text{ kJ/kg} \cdot ^{\circ}\text{C})[1 - (-2.8)^{\circ}\text{C}] = 79.3 \text{ kJ}$$

$$\text{Freezing at } -2.8^{\circ}\text{C}: Q_{\text{freezing}} = mh_{\text{latent}} = (7 \text{ kg})(214 \text{ kJ/kg}) = 1498 \text{ kJ}$$

$$\text{Cooling } -18^{\circ}\text{C}: Q_{\text{cooling,frozen}} = (mc_p \Delta T)_{\text{frozen}} = (7 \text{ kg})(1.65 \text{ kJ/kg} \cdot ^{\circ}\text{C})[-2.8 - (-18)]^{\circ}\text{C} = 175.6 \text{ kJ}$$

Therefore, the total amount of heat removal per turkey is

$$Q_{\text{total}} = Q_{\text{cooling,fresh}} + Q_{\text{freezing}} + Q_{\text{cooling,frozen}} = 79.3 + 1498 + 175.6 \cong \mathbf{1753 \text{ kJ}}$$

(b) Assuming only 90 percent of the water content of turkey is frozen, the amount of heat that needs to be removed from the turkey as it is cooled from 1°C to -18°C is

$$\text{Cooling to } -2.8^{\circ}\text{C}: Q_{\text{cooling,fresh}} = (mc_p \Delta T)_{\text{fresh}} = (7 \text{ kg})(2.98 \text{ kJ/kg} \cdot ^{\circ}\text{C})[1 - (-2.8)^{\circ}\text{C}] = 79.3 \text{ kJ}$$

$$\text{Freezing at } -2.8^{\circ}\text{C}: Q_{\text{freezing}} = mh_{\text{latent}} = (7 \times 0.9 \text{ kg})(214 \text{ kJ/kg}) = 1348 \text{ kJ}$$

$$\text{Cooling } -18^{\circ}\text{C}: Q_{\text{cooling,frozen}} = (mc_p \Delta T)_{\text{frozen}} = (7 \times 0.9 \text{ kg})(1.65 \text{ kJ/kg} \cdot ^{\circ}\text{C})[-2.8 - (-18)]^{\circ}\text{C} = 158 \text{ kJ}$$

$$Q_{\text{cooling,unfrozen}} = (mc_p \Delta T)_{\text{fresh}} = (7 \times 0.1 \text{ kg})(2.98 \text{ kJ/kg} \cdot ^{\circ}\text{C})[-2.8 - (-18)^{\circ}\text{C}] = 31.7 \text{ kJ}$$

Therefore, the total amount of heat removal per turkey is

$$Q_{\text{total}} = Q_{\text{cooling,fresh}} + Q_{\text{freezing}} + Q_{\text{cooling,frozen\&unfrozen}} = 79.3 + 1348 + 158 + 31.7 = \mathbf{1617 \text{ kJ}}$$

4-107 Chickens are to be cooled by chilled water in an immersion chiller. The rate of heat removal from the chicken and the mass flow rate of water are to be determined.

Assumptions 1 Steady operating conditions exist. 2 The thermal properties of chickens are constant.

Properties The specific heat of chicken are given to be 3.54 kJ/kg.°C. The specific heat of water is 4.18 kJ/kg.°C (Table A-9).

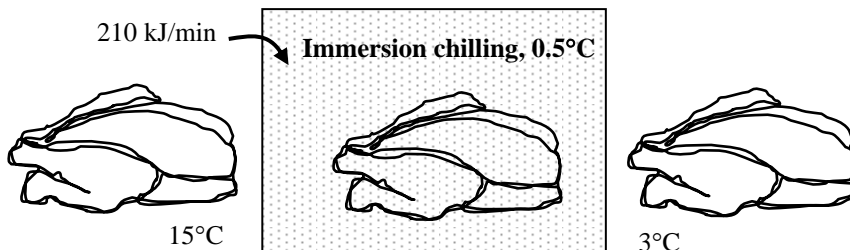

Analysis (a) Chickens are dropped into the chiller at a rate of 500 per hour. Therefore, chickens can be considered to flow steadily through the chiller at a mass flow rate of

$$\dot{m}_{\text{chicken}} = (500 \text{ chicken/h})(2.2 \text{ kg/chicken}) = 1100 \text{ kg/h} = 0.3056 \text{ kg/s}$$

Then the rate of heat removal from the chickens as they are cooled from 15°C to 3°C at this rate becomes

$$\dot{Q}_{\text{chicken}} = (\dot{m}c_p\Delta T)_{\text{chicken}} = (0.3056 \text{ kg/s})(3.54 \text{ kJ/kg}\cdot^{\circ}\text{C})(15 - 3)^{\circ}\text{C} = \mathbf{13.0 \text{ kW}}$$

(b) The chiller gains heat from the surroundings as a rate of 210 kJ/min = 3.5 kJ/s. Then the total rate of heat gain by the water is

$$\dot{Q}_{\text{water}} = \dot{Q}_{\text{chicken}} + \dot{Q}_{\text{heat gain}} = 13.0 + 3.5 = 16.5 \text{ kW}$$

Noting that the temperature rise of water is not to exceed 2°C as it flows through the chiller, the mass flow rate of water must be at least

$$\dot{m}_{\text{water}} = \frac{\dot{Q}_{\text{water}}}{(c_p\Delta T)_{\text{water}}} = \frac{16.5 \text{ kW}}{(4.18 \text{ kJ/kg}\cdot^{\circ}\text{C})(2^{\circ}\text{C})} = \mathbf{1.97 \text{ kg/s}}$$

If the mass flow rate of water is less than this value, then the temperature rise of water will have to be more than 2°C.

4-108E Chickens are to be frozen by refrigerated air. The cooling time of the chicken is to be determined for the cases of cooling air being at -40°F and -80°F.

Assumptions 1 Steady operating conditions exist. 2 The thermal properties of chickens are constant.

Analysis The time required to reduce the inner surface temperature of the chickens from 32°F to 25°F with refrigerated air at -40°F is determined from Fig. 4-53 to be

$$t \cong \mathbf{2.3 \text{ hours}}$$

If the air temperature were -80°F, the freezing time would be

$$t \cong \mathbf{1.4 \text{ hours}}$$

Therefore, the time required to cool the chickens to 25°F is reduced considerably when the refrigerated air temperature is decreased.

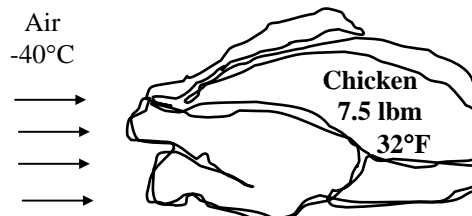

4-109 The center temperature of meat slabs is to be lowered by chilled air to below 5°C while the surface temperature remains above -1°C to avoid freezing. The average heat transfer coefficient during this cooling process is to be determined.

Assumptions **1** The meat slabs can be approximated as very large plane walls of half-thickness $L = 5\text{-cm}$. **2** Heat conduction in the meat slabs is one-dimensional because of symmetry about the centerplane. **3** The thermal properties of the meat slab are constant. **4** The heat transfer coefficient is constant and uniform over the entire surface. **5** The Fourier number is $\tau > 0.2$ so that the one-term approximate solutions (or the transient temperature charts) are applicable (this assumption will be verified).

Properties The thermal properties of the beef slabs are given to be $\rho = 1090\text{ kg/m}^3$, $c_p = 3.54\text{ kJ/kg}\cdot^{\circ}\text{C}$, $k = 0.47\text{ W/m}\cdot^{\circ}\text{C}$, and $\alpha = 0.13 \times 10^{-6}\text{ m}^2/\text{s}$.

Analysis The lowest temperature in the steak will occur at the surfaces and the highest temperature at the center at a given time since the inner part of the steak will be last place to be cooled. In the limiting case, the surface temperature at $x = L = 5\text{ cm}$ from the center will be -1°C while the mid plane temperature is 5°C in an environment at -12°C . Then from Fig. 4-15b we obtain

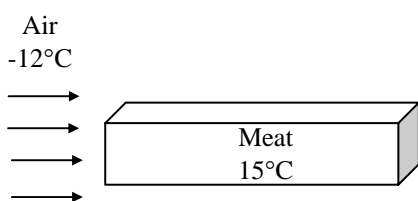
$$\left. \begin{aligned} \frac{x}{L} = \frac{5\text{ cm}}{5\text{ cm}} = 1 \\ \frac{T(L, t) - T_{\infty}}{T_o - T_{\infty}} = \frac{-1 - (-12)}{5 - (-12)} = 0.65 \end{aligned} \right\} \frac{1}{\text{Bi}} = \frac{k}{hL} = 0.95$$

which gives

$$h = \frac{k}{L} \text{Bi} = \frac{0.47\text{ W/m}\cdot^{\circ}\text{C}}{0.05\text{ m}} \left(\frac{1}{0.95} \right) = \mathbf{9.9\text{ W/m}^2\cdot^{\circ}\text{C}}$$

Therefore, the convection heat transfer coefficient should be kept below this value to satisfy the constraints on the temperature of the steak during refrigeration. We can also meet the constraints by using a lower heat transfer coefficient, but doing so would extend the refrigeration time unnecessarily.

Discussion We could avoid the uncertainty associated with the reading of the charts and obtain a more accurate result by using the one-term solution relation for an infinite plane wall, but it would require a trial and error approach since the Bi number is not known.

Review Problems

4-110 Two large steel plates are stuck together because of the freezing of the water between the two plates. Hot air is blown over the exposed surface of the plate on the top to melt the ice. The length of time the hot air should be blown is to be determined.

Assumptions 1 Heat conduction in the plates is one-dimensional since the plate is large relative to its thickness and there is thermal symmetry about the center plane. **3** The thermal properties of the steel plates are constant. **4** The heat transfer coefficient is constant and uniform over the entire surface. **5** The Fourier number is $\tau > 0.2$ so that the one-term approximate solutions (or the transient temperature charts) are applicable (this assumption will be verified).

Properties The thermal properties of steel plates are given to be $k = 43 \text{ W/m}\cdot^\circ\text{C}$ and $\alpha = 1.17 \times 10^{-5} \text{ m}^2/\text{s}$

Analysis The characteristic length of the plates and the Biot number are

$$L_c = \frac{V}{A_s} = L = 0.02 \text{ m}$$

$$Bi = \frac{hL_c}{k} = \frac{(40 \text{ W/m}^2\cdot^\circ\text{C})(0.02 \text{ m})}{(43 \text{ W/m}\cdot^\circ\text{C})} = 0.019 < 0.1$$

Since $Bi < 0.1$, the lumped system analysis is applicable. Therefore,

$$b = \frac{hA_s}{\rho c_p V} = \frac{h}{\rho c_p L_c} = \frac{40 \text{ W/m}^2\cdot^\circ\text{C}}{(3.675 \times 10^6 \text{ J/m}^3\cdot^\circ\text{C})(0.02 \text{ m})} = 0.000544 \text{ s}^{-1}$$

$$\frac{T(t) - T_\infty}{T_i - T_\infty} = e^{-bt} \longrightarrow \frac{0 - 50}{-15 - 50} = e^{-(0.000544 \text{ s}^{-1})t} \longrightarrow t = \mathbf{482 \text{ s} = 8.0 \text{ min}}$$

$$\text{where } \rho c_p = \frac{k}{\alpha} = \frac{43 \text{ W/m}\cdot^\circ\text{C}}{1.17 \times 10^{-5} \text{ m}^2/\text{s}} = 3.675 \times 10^6 \text{ J/m}^3\cdot^\circ\text{C}$$

Alternative solution: This problem can also be solved using the transient chart Fig. 4-15a,

$$\left. \begin{aligned} \frac{1}{Bi} &= \frac{1}{0.019} = 52.6 \\ \frac{T_0 - T_\infty}{T_i - T_\infty} &= \frac{0 - 50}{-15 - 50} = 0.769 \end{aligned} \right\} \tau = \frac{\alpha t}{r_o^2} = 15 > 0.2$$

Then,

$$t = \frac{\tau r_o^2}{\alpha} = \frac{(15)(0.02 \text{ m})^2}{(1.17 \times 10^{-5} \text{ m}^2/\text{s})} = \mathbf{513 \text{ s}}$$

The difference is due to the reading error of the chart.

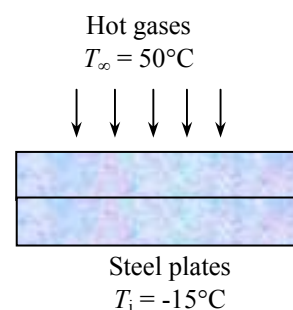

4-111 A curing kiln is heated by injecting steam into it and raising its inner surface temperature to a specified value. It is to be determined whether the temperature at the outer surfaces of the kiln changes during the curing period.

Assumptions 1 The temperature in the wall is affected by the thermal conditions at inner surfaces only and the convection heat transfer coefficient inside is very large. Therefore, the wall can be considered to be a semi-infinite medium with a specified surface temperature of 45°C. **2** The thermal properties of the concrete wall are constant.

Properties The thermal properties of the concrete wall are given to be $k = 0.9 \text{ W/m}\cdot\text{°C}$ and $\alpha = 0.23 \times 10^{-5} \text{ m}^2/\text{s}$.

Analysis We determine the temperature at a depth of $x = 0.3 \text{ m}$ in 2.5 h using the analytical solution,

$$\frac{T(x, t) - T_i}{T_s - T_i} = \text{erfc}\left(\frac{x}{2\sqrt{\alpha t}}\right)$$

Substituting,

$$\begin{aligned} \frac{T(x, t) - 6}{42 - 6} &= \text{erfc}\left(\frac{0.3 \text{ m}}{2\sqrt{(0.23 \times 10^{-5} \text{ m}^2/\text{s})(2.5 \text{ h} \times 3600 \text{ s/h})}}\right) \\ &= \text{erfc}(1.043) = 0.1402 \\ T(x, t) &= \mathbf{11.0^\circ\text{C}} \end{aligned}$$

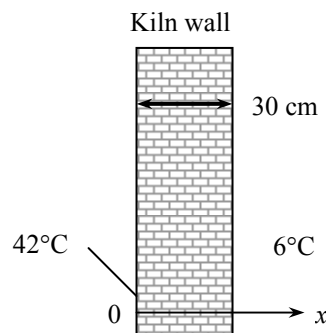

which is greater than the initial temperature of 6°C. Therefore, heat will propagate through the 0.3 m thick wall in 2.5 h, and thus it may be desirable to insulate the outer surface of the wall to save energy.

4-112 The water pipes are buried in the ground to prevent freezing. The minimum burial depth at a particular location is to be determined.

Assumptions 1 The temperature in the soil is affected by the thermal conditions at one surface only, and thus the soil can be considered to be a semi-infinite medium with a specified surface temperature of -10°C. **2** The thermal properties of the soil are constant.

Properties The thermal properties of the soil are given to be $k = 0.7 \text{ W/m}\cdot\text{°C}$ and $\alpha = 1.4 \times 10^{-5} \text{ m}^2/\text{s}$.

Analysis The depth at which the temperature drops to 0°C in 75 days is determined using the analytical solution,

$$\frac{T(x, t) - T_i}{T_s - T_i} = \text{erfc}\left(\frac{x}{2\sqrt{\alpha t}}\right)$$

Substituting and using Table 4-4, we obtain

$$\begin{aligned} \frac{0 - 15}{-10 - 15} &= \text{erfc}\left(\frac{x}{2\sqrt{(1.4 \times 10^{-5} \text{ m}^2/\text{s})(75 \text{ day} \times 24 \text{ h/day} \times 3600 \text{ s/h})}}\right) \\ &\longrightarrow x = \mathbf{7.05 \text{ m}} \end{aligned}$$

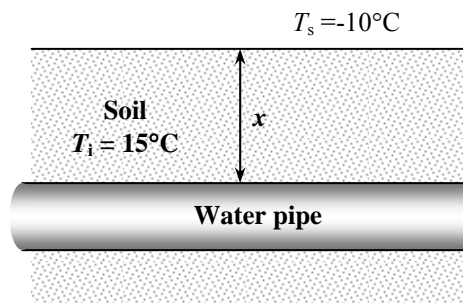

Therefore, the pipes must be buried at a depth of at least 7.05 m.

4-113 A hot dog is to be cooked by dropping it into boiling water. The time of cooking is to be determined.

Assumptions 1 Heat conduction in the hot dog is two-dimensional, and thus the temperature varies in both the axial x - and the radial r - directions. **2** The thermal properties of the hot dog are constant. **4** The heat transfer coefficient is constant and uniform over the entire surface. **5** The Fourier number is $\tau > 0.2$ so that the one-term approximate solutions (or the transient temperature charts) are applicable (this assumption will be verified).

Properties The thermal properties of the hot dog are given to be $k = 0.76 \text{ W/m}\cdot\text{°C}$, $\rho = 980 \text{ kg/m}^3$, $c_p = 3.9 \text{ kJ/kg}\cdot\text{°C}$, and $\alpha = 2 \times 10^{-7} \text{ m}^2/\text{s}$.

Analysis This hot dog can physically be formed by the intersection of an infinite plane wall of thickness $2L = 12 \text{ cm}$, and a long cylinder of radius $r_o = D/2 = 1 \text{ cm}$. The Biot numbers and corresponding constants are first determined to be

$$Bi = \frac{hL}{k} = \frac{(600 \text{ W/m}^2\cdot\text{°C})(0.06 \text{ m})}{(0.76 \text{ W/m}\cdot\text{°C})} = 47.37 \longrightarrow \lambda_1 = 1.5380 \quad \text{and} \quad A_1 = 1.2726$$

$$Bi = \frac{hr_o}{k} = \frac{(600 \text{ W/m}^2\cdot\text{°C})(0.01 \text{ m})}{(0.76 \text{ W/m}\cdot\text{°C})} = 7.895 \longrightarrow \lambda_1 = 2.1249 \quad \text{and} \quad A_1 = 1.5514$$

Noting that $\tau = \alpha t / L^2$ and assuming $\tau > 0.2$ in all dimensions and thus the one-term approximate solution for transient heat conduction is applicable, the product solution for this problem can be written as

$$\theta(0,0,t)_{block} = \theta(0,t)_{wall} \theta(0,t)_{cyl} = \left(A_1 e^{-\lambda_1^2 \tau} \right) \left(A_1 e^{-\lambda_1^2 \tau} \right)$$

$$\frac{80 - 100}{5 - 100} = \left\{ (1.2726) \exp \left[- (1.5380)^2 \frac{(2 \times 10^{-7}) t}{(0.06)^2} \right] \right\}$$

$$\times \left\{ (1.5514) \exp \left[- (2.1249)^2 \frac{(2 \times 10^{-7}) t}{(0.01)^2} \right] \right\} = 0.2105$$

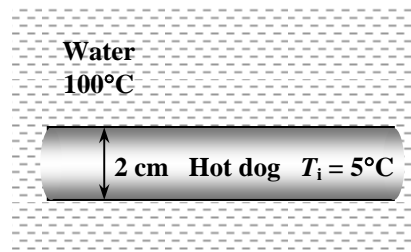

which gives

$$t = 244 \text{ s} = 4.1 \text{ min}$$

Therefore, it will take about 4.1 min for the hot dog to cook. Note that

$$\tau_{cyl} = \frac{\alpha t}{r_o^2} = \frac{(2 \times 10^{-7} \text{ m}^2/\text{s})(244 \text{ s})}{(0.01 \text{ m})^2} = 0.49 > 0.2$$

and thus the assumption $\tau > 0.2$ for the applicability of the one-term approximate solution is verified.

Discussion This problem could also be solved by treating the hot dog as an infinite cylinder since heat transfer through the end surfaces will have little effect on the mid section temperature because of the large distance.

4-114 A long roll of large 1-Mn manganese steel plate is to be quenched in an oil bath at a specified rate. The temperature of the sheet metal after quenching and the rate at which heat needs to be removed from the oil in order to keep its temperature constant are to be determined.

Assumptions 1 The thermal properties of the steel plate are constant. 2 The heat transfer coefficient is constant and uniform over the entire surface. 3 The Biot number is $Bi < 0.1$ so that the lumped system analysis is applicable (this assumption will be checked).

Properties The properties of the steel plate are $k = 60.5 \text{ W/m}\cdot\text{°C}$, $\rho = 7854 \text{ kg/m}^3$, and $c_p = 434 \text{ J/kg}\cdot\text{°C}$ (Table A-3).

Analysis The characteristic length of the steel plate and the Biot number are

$$L_c = \frac{V}{A_s} = L = 0.0025 \text{ m}$$

$$Bi = \frac{hL_c}{k} = \frac{(860 \text{ W/m}^2\cdot\text{°C})(0.0025 \text{ m})}{60.5 \text{ W/m}\cdot\text{°C}} = 0.036 < 0.1$$

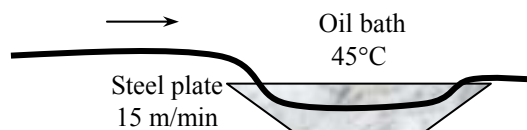

Since $Bi < 0.1$, the lumped system analysis is applicable. Therefore,

$$b = \frac{hA_s}{\rho c_p V} = \frac{h}{\rho c_p L_c} = \frac{860 \text{ W/m}^2\cdot\text{°C}}{(7854 \text{ kg/m}^3)(434 \text{ J/kg}\cdot\text{°C})(0.0025 \text{ m})} = 0.10092 \text{ s}^{-1}$$

$$\text{time} = \frac{\text{length}}{\text{velocity}} = \frac{9 \text{ m}}{15 \text{ m/min}} = 0.6 \text{ min} = 36 \text{ s}$$

Then the temperature of the sheet metal when it leaves the oil bath is determined to be

$$\frac{T(t) - T_\infty}{T_i - T_\infty} = e^{-bt} \longrightarrow \frac{T(t) - 45}{820 - 45} = e^{-(0.10092 \text{ s}^{-1})(36 \text{ s})} \longrightarrow T(t) = \mathbf{65.5^\circ\text{C}}$$

The mass flow rate of the sheet metal through the oil bath is

$$\dot{m} = \rho \dot{V} = \rho w t V = (7854 \text{ kg/m}^3)(2 \text{ m})(0.005 \text{ m})(15 \text{ m/min}) = 1178 \text{ kg/min}$$

Then the rate of heat transfer from the sheet metal to the oil bath and thus the rate at which heat needs to be removed from the oil in order to keep its temperature constant at 45°C becomes

$$\dot{Q} = \dot{m} c_p [T(t) - T_\infty] = (1178 \text{ kg/min})(434 \text{ J/kg}\cdot\text{°C})(65.5 - 45)^\circ\text{C} = 1.048 \times 10^7 \text{ J/min} = \mathbf{175 \text{ kW}}$$

4-115E A stuffed turkey is cooked in an oven. The average heat transfer coefficient at the surface of the turkey, the temperature of the skin of the turkey in the oven and the total amount of heat transferred to the turkey in the oven are to be determined.

Assumptions 1 The turkey is a homogeneous spherical object. **2** Heat conduction in the turkey is one-dimensional because of symmetry about the midpoint. **3** The thermal properties of the turkey are constant. **4** The heat transfer coefficient is constant and uniform over the entire surface. **5** The Fourier number is $\tau > 0.2$ so that the one-term approximate solutions are applicable (this assumption will be verified).

Properties The properties of the turkey are given to be $k = 0.26$ Btu/h.ft.°F, $\rho = 75$ lbm/ft³, $c_p = 0.98$ Btu/lbm.°F, and $\alpha = 0.0035$ ft²/h.

Analysis (a) Assuming the turkey to be spherical in shape, its radius is determined to be

$$m = \rho V \longrightarrow V = \frac{m}{\rho} = \frac{14 \text{ lbm}}{75 \text{ lbm/ft}^3} = 0.1867 \text{ ft}^3$$

$$V = \frac{4}{3} \pi r_o^3 \longrightarrow r_o = \sqrt[3]{\frac{3V}{4\pi}} = \sqrt[3]{\frac{3(0.1867 \text{ ft}^3)}{4\pi}} = 0.3545 \text{ ft}$$

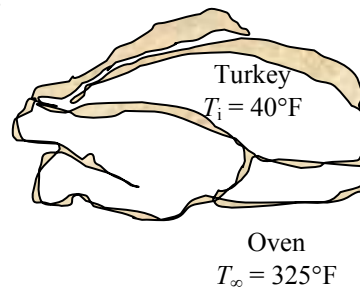

The Fourier number is
$$\tau = \frac{\alpha t}{r_o^2} = \frac{(3.5 \times 10^{-3} \text{ ft}^2/\text{h})(5 \text{ h})}{(0.3545 \text{ ft})^2} = 0.1392$$

which is close to 0.2 but a little below it. Therefore, assuming the one-term approximate solution for transient heat conduction to be applicable, the one-term solution formulation at one-third the radius from the center of the turkey can be expressed as

$$\theta(x, t)_{sph} = \frac{T(x, t) - T_\infty}{T_i - T_\infty} = A_1 e^{-\lambda_1^2 \tau} \frac{\sin(\lambda_1 r / r_o)}{\lambda_1 r / r_o}$$

$$\frac{185 - 325}{40 - 325} = 0.491 = A_1 e^{-\lambda_1^2 (0.14)} \frac{\sin(0.333 \lambda_1)}{0.333 \lambda_1}$$

By trial and error, it is determined from Table 4-2 that the equation above is satisfied when $Bi = 20$ corresponding to $\lambda_1 = 2.9857$ and $A_1 = 1.9781$. Then the heat transfer coefficient can be determined from

$$Bi = \frac{hr_o}{k} \longrightarrow h = \frac{kBi}{r_o} = \frac{(0.26 \text{ Btu/h.ft.}^\circ\text{F})(20)}{(0.3545 \text{ ft})} = \mathbf{14.7 \text{ Btu/h.ft}^2 \cdot ^\circ\text{F}}$$

(b) The temperature at the surface of the turkey is

$$\frac{T(r_o, t) - 325}{40 - 325} = A_1 e^{-\lambda_1^2 \tau} \frac{\sin(\lambda_1 r_o / r_o)}{\lambda_1 r_o / r_o} = (1.9781) e^{-(2.9857)^2 (0.14)} \frac{\sin(2.9857)}{2.9857} = 0.02953$$

$$\longrightarrow T(r_o, t) = \mathbf{317^\circ\text{F}}$$

(c) The maximum possible heat transfer is

$$Q_{\max} = mc_p (T_\infty - T_i) = (14 \text{ lbm})(0.98 \text{ Btu/lbm.}^\circ\text{F})(325 - 40)^\circ\text{F} = 3910 \text{ Btu}$$

Then the actual amount of heat transfer becomes

$$\frac{Q}{Q_{\max}} = 1 - 3\theta_{o,sph} \frac{\sin(\lambda_1) - \lambda_1 \cos(\lambda_1)}{\lambda_1^3} = 1 - 3(0.491) \frac{\sin(2.9857) - (2.9857) \cos(2.9857)}{(2.9857)^3} = 0.828$$

$$Q = 0.828 Q_{\max} = (0.828)(3910 \text{ Btu}) = \mathbf{3240 \text{ Btu}}$$

Discussion The temperature of the outer parts of the turkey will be greater than that of the inner parts when the turkey is taken out of the oven. Then heat will continue to be transferred from the outer parts of the turkey to the inner as a result of temperature difference. Therefore, after 5 minutes, the thermometer reading will probably be more than 185°F.

4-116 The trunks of some dry oak trees are exposed to hot gases. The time for the ignition of the trunks is to be determined.

Assumptions **1** Heat conduction in the trunks is one-dimensional since it is long and it has thermal symmetry about the center line. **2** The thermal properties of the trunks are constant. **3** The heat transfer coefficient is constant and uniform over the entire surface. **4** The Fourier number is $\tau > 0.2$ so that the one-term approximate solutions (or the transient temperature charts) are applicable (this assumption will be verified).

Properties The properties of the trunks are given to be $k = 0.17 \text{ W/m}\cdot\text{°C}$ and $\alpha = 1.28 \times 10^{-7} \text{ m}^2/\text{s}$.

Analysis We treat the trunks of the trees as an infinite cylinder since heat transfer is primarily in the radial direction. Then the Biot number becomes

$$Bi = \frac{hr_o}{k} = \frac{(65 \text{ W/m}^2\cdot\text{°C})(0.1 \text{ m})}{(0.17 \text{ W/m}\cdot\text{°C})} = 38.24$$

The constants λ_1 and A_1 corresponding to this Biot number are, from Table 4-2,

$$\lambda_1 = 2.3420 \quad \text{and} \quad A_1 = 1.5989$$

The Fourier number is

$$\tau = \frac{\alpha t}{r_o^2} = \frac{(1.28 \times 10^{-7} \text{ m}^2/\text{s})(4 \text{ h} \times 3600 \text{ s/h})}{(0.1 \text{ m})^2} = 0.184$$

which is slightly below 0.2 but close to it. Therefore, assuming the one-term approximate solution for transient heat conduction to be applicable, the temperature at the surface of the trees in 4 h becomes

$$\theta(r_o, t)_{cyl} = \frac{T(r_o, t) - T_\infty}{T_i - T_\infty} = A_1 e^{-\lambda_1^2 \tau} J_0(\lambda_1 r / r_o)$$

$$\frac{T(r_o, t) - 520}{30 - 520} = (1.5989) e^{-(2.3420)^2 (0.184)} (0.0332) = 0.01935 \longrightarrow T(r_o, t) = \mathbf{511^\circ\text{C}} > 410^\circ\text{C}$$

Therefore, the trees will ignite. (Note: J_0 is read from Table 4-3).

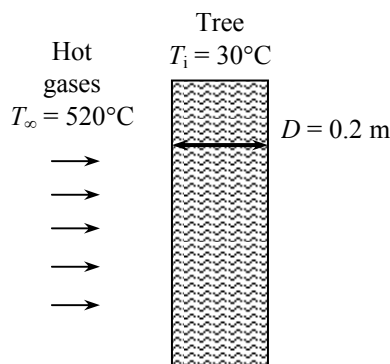

4-117 A spherical watermelon that is cut into two equal parts is put into a freezer. The time it will take for the center of the exposed cut surface to cool from 25 to 3°C is to be determined.

Assumptions **1** The temperature of the exposed surfaces of the watermelon is affected by the convection heat transfer at those surfaces only. Therefore, the watermelon can be considered to be a semi-infinite medium **2** The thermal properties of the watermelon are constant.

Properties The thermal properties of the water is closely approximated by those of water at room temperature, $k = 0.607 \text{ W/m}\cdot\text{°C}$ and $\alpha = k / \rho c_p = 0.146 \times 10^{-6} \text{ m}^2/\text{s}$ (Table A-9).

Analysis We use the transient chart in Fig. 4-29 in this case for convenience (instead of the analytic solution),

$$\left. \begin{aligned} 1 - \frac{T(x, t) - T_\infty}{T_i - T_\infty} &= 1 - \frac{3 - (-12)}{25 - (-12)} = 0.595 \\ \xi &= \frac{x}{2\sqrt{\alpha t}} = 0 \end{aligned} \right\} \frac{h\sqrt{\alpha t}}{k} = 1$$

$$\text{Therefore, } t = \frac{(1)^2 k^2}{h^2 \alpha} = \frac{(0.607 \text{ W/m}\cdot\text{°C})^2}{(22 \text{ W/m}^2\cdot\text{°C})^2 (0.146 \times 10^{-6} \text{ m}^2/\text{s})} = 5214 \text{ s} = \mathbf{86.9 \text{ min}}$$

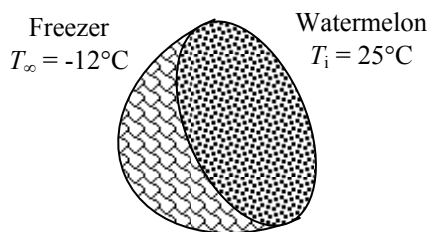

4-118 A cylindrical rod is dropped into boiling water. The thermal diffusivity and the thermal conductivity of the rod are to be determined.

Assumptions 1 Heat conduction in the rod is one-dimensional since the rod is sufficiently long, and thus temperature varies in the radial direction only. **2** The thermal properties of the rod are constant.

Properties The thermal properties of the rod available are given to be $\rho = 3700 \text{ kg/m}^3$ and $C_p = 920 \text{ J/kg}\cdot^\circ\text{C}$.

Analysis From Fig. 4-16b we have

$$\left. \begin{aligned} \frac{T - T_\infty}{T_0 - T_\infty} &= \frac{93 - 100}{75 - 100} = 0.28 \\ \frac{x}{r_o} &= \frac{r_o}{r_o} = 1 \end{aligned} \right\} \frac{1}{Bi} = \frac{k}{hr_o} = 0.25$$

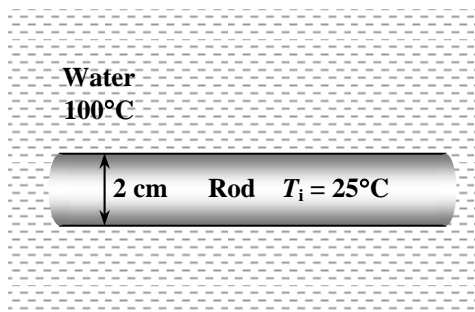

From Fig. 4-16a we have

$$\left. \begin{aligned} \frac{1}{Bi} &= \frac{k}{hr_o} = 0.25 \\ \frac{T_o - T_\infty}{T_i - T_\infty} &= \frac{75 - 100}{25 - 100} = 0.33 \end{aligned} \right\} \tau = \frac{\alpha t}{r_o^2} = 0.40$$

Then the thermal diffusivity and the thermal conductivity of the material become

$$\alpha = \frac{0.40 r_o^2}{t} = \frac{(0.40)(0.01 \text{ m})^2}{3 \text{ min} \times 60 \text{ s/min}} = 2.22 \times 10^{-7} \text{ m}^2/\text{s}$$

$$\alpha = \frac{k}{\rho c_p} \longrightarrow k = \alpha \rho c_p = (2.22 \times 10^{-7} \text{ m}^2/\text{s})(3700 \text{ kg/m}^3)(920 \text{ J/kg}\cdot^\circ\text{C}) = 0.756 \text{ W/m}\cdot^\circ\text{C}$$

4-119 The time it will take for the diameter of a raindrop to reduce to a certain value as it falls through ambient air is to be determined.

Assumptions 1 The water temperature remains constant. **2** The thermal properties of the water are constant.

Properties The density and heat of vaporization of the water are $\rho = 1000 \text{ kg/m}^3$ and $h_{fg} = 2490 \text{ kJ/kg}$ (Table A-9).

Analysis The initial and final masses of the raindrop are

$$m_i = \rho V_i = \rho \frac{4}{3} \pi r_i^3 = (1000 \text{ kg/m}^3) \frac{4}{3} \pi (0.0025 \text{ m})^3 = 0.0000654 \text{ kg}$$

$$m_f = \rho V_f = \rho \frac{4}{3} \pi r_f^3 = (1000 \text{ kg/m}^3) \frac{4}{3} \pi (0.0015 \text{ m})^3 = 0.0000141 \text{ kg}$$

whose difference is

$$m = m_i - m_f = 0.0000654 - 0.0000141 = 0.0000513 \text{ kg}$$

The amount of heat transfer required to cause this much evaporation is

$$Q = (0.0000513 \text{ kg})(2490 \text{ kJ/kg}) = 0.1278 \text{ kJ}$$

The average heat transfer surface area and the rate of heat transfer are

$$A_s = \frac{4\pi(r_i^2 + r_f^2)}{2} = \frac{4\pi[(0.0025 \text{ m})^2 + (0.0015 \text{ m})^2]}{2} = 5.341 \times 10^{-5} \text{ m}^2$$

$$\dot{Q} = hA_s(T_i - T_\infty) = (400 \text{ W/m}^2\cdot^\circ\text{C})(5.341 \times 10^{-5} \text{ m}^2)(18 - 5)^\circ\text{C} = 0.2777 \text{ J/s}$$

Then the time required for the raindrop to experience this reduction in size becomes

$$\dot{Q} = \frac{Q}{\Delta t} \longrightarrow \Delta t = \frac{Q}{\dot{Q}} = \frac{127.8 \text{ J}}{0.2777 \text{ J/s}} = 460 \text{ s} = 7.7 \text{ min}$$

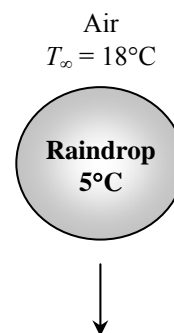

4-120E A plate, a long cylinder, and a sphere are exposed to cool air. The center temperature of each geometry is to be determined.

Assumptions 1 Heat conduction in each geometry is one-dimensional. **2** The thermal properties of the bodies are constant. **3** The heat transfer coefficient is constant and uniform over the entire surface. **4** The Fourier number is $\tau > 0.2$ so that the one-term approximate solutions (or the transient temperature charts) are applicable (this assumption will be verified).

Properties The properties of bronze are given to be $k = 15 \text{ Btu/h}\cdot\text{ft}\cdot^\circ\text{F}$ and $\alpha = 0.333 \text{ ft}^2/\text{h}$.

Analysis After 5 minutes

Plate: First the Biot number is calculated to be

$$Bi = \frac{hL}{k} = \frac{(7 \text{ Btu/h}\cdot\text{ft}^2\cdot^\circ\text{F})(0.5/12 \text{ ft})}{(15 \text{ Btu/h}\cdot\text{ft}\cdot^\circ\text{F})} = 0.01944$$

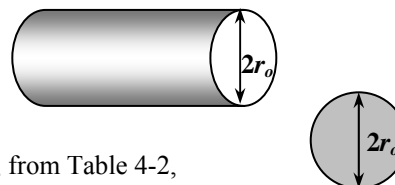

The constants λ_1 and A_1 corresponding to this Biot number are, from Table 4-2,

$$\lambda_1 = 0.1387 \quad \text{and} \quad A_1 = 1.0032$$

The Fourier number is

$$\tau = \frac{\alpha t}{L^2} = \frac{(0.333 \text{ ft}^2/\text{h})(5 \text{ min}/60 \text{ min/h})}{(0.5/12 \text{ ft})^2} = 15.98 > 0.2$$

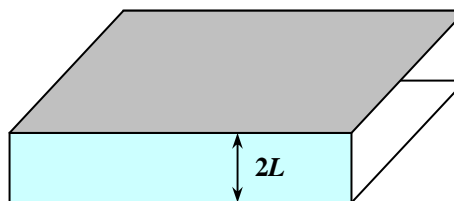

Then the center temperature of the plate becomes

$$\theta_{o,\text{wall}} = \frac{T_0 - T_\infty}{T_i - T_\infty} = A_1 e^{-\lambda_1^2 \tau} \longrightarrow \frac{T_0 - 75}{400 - 75} = (1.0032)e^{-(0.1387)^2(15.98)} = 0.738 \longrightarrow T_0 = 315^\circ\text{F}$$

Cylinder:

$$Bi = 0.01944 \xrightarrow{\text{Table 4-2}} \lambda_1 = 0.1962 \quad \text{and} \quad A_1 = 1.0049$$

$$\theta_{o,\text{cyl}} = \frac{T_0 - T_\infty}{T_i - T_\infty} = A_1 e^{-\lambda_1^2 \tau} \longrightarrow \frac{T_0 - 75}{400 - 75} = (1.0049)e^{-(0.1962)^2(15.98)} = 0.543 \longrightarrow T_0 = 252^\circ\text{F}$$

Sphere:

$$Bi = 0.01944 \xrightarrow{\text{Table 4-2}} \lambda_1 = 0.2405 \quad \text{and} \quad A_1 = 1.0058$$

$$\theta_{o,\text{sph}} = \frac{T_0 - T_\infty}{T_i - T_\infty} = A_1 e^{-\lambda_1^2 \tau} \longrightarrow \frac{T_0 - 75}{400 - 75} = (1.0058)e^{-(0.2405)^2(15.98)} = 0.399 \longrightarrow T_0 = 205^\circ\text{F}$$

After 10 minutes

$$\tau = \frac{\alpha t}{L^2} = \frac{(0.333 \text{ ft}^2/\text{h})(10 \text{ min}/60 \text{ min/h})}{(0.5/12 \text{ ft})^2} = 31.97 > 0.2$$

Plate:

$$\theta_{o,\text{wall}} = \frac{T_0 - T_\infty}{T_i - T_\infty} = A_1 e^{-\lambda_1^2 \tau} \longrightarrow \frac{T_0 - 75}{400 - 75} = (1.0032)e^{-(0.1387)^2(31.97)} = 0.542 \longrightarrow T_0 = 251^\circ\text{F}$$

Cylinder:

$$\theta_{o,\text{cyl}} = \frac{T_0 - T_\infty}{T_i - T_\infty} = A_1 e^{-\lambda_1^2 \tau} \longrightarrow \frac{T_0 - 75}{400 - 75} = (1.0049)e^{-(0.1962)^2(31.97)} = 0.293 \longrightarrow T_0 = 170^\circ\text{F}$$

Sphere:

$$\theta_{o,\text{sph}} = \frac{T_0 - T_\infty}{T_i - T_\infty} = A_1 e^{-\lambda_1^2 \tau} \longrightarrow \frac{T_0 - 75}{400 - 75} = (1.0058)e^{-(0.2405)^2(31.97)} = 0.158 \longrightarrow T_0 = 126^\circ\text{F}$$

After 30 minutes

$$\tau = \frac{\alpha t}{L^2} = \frac{(0.333 \text{ ft}^2/\text{h})(30 \text{ min}/60 \text{ min/h})}{(0.5/12 \text{ ft})^2} = 95.9 > 0.2$$

Plate:

$$\theta_{0,\text{wall}} = \frac{T_0 - T_\infty}{T_i - T_\infty} = A_1 e^{-\lambda_1^2 \tau} \longrightarrow \frac{T_0 - 75}{400 - 75} = (1.0032)e^{-(0.1387)^2(95.9)} = 0.159 \longrightarrow T_0 = \mathbf{127^\circ\text{F}}$$

Cylinder:

$$\theta_{0,\text{cyl}} = \frac{T_0 - T_\infty}{T_i - T_\infty} = A_1 e^{-\lambda_1^2 \tau} \longrightarrow \frac{T_0 - 75}{400 - 75} = (1.0049)e^{-(0.1962)^2(95.9)} = 0.025 \longrightarrow T_0 = \mathbf{83^\circ\text{F}}$$

Sphere:

$$\theta_{0,\text{sph}} = \frac{T_0 - T_\infty}{T_i - T_\infty} = A_1 e^{-\lambda_1^2 \tau} \longrightarrow \frac{T_0 - 75}{400 - 75} = (1.0058)e^{-(0.2405)^2(95.9)} = 0.00392 \longrightarrow T_0 = \mathbf{76^\circ\text{F}}$$

The sphere has the largest surface area through which heat is transferred per unit volume, and thus the highest rate of heat transfer. Consequently, the center temperature of the sphere is always the lowest.

4-121E A plate, a long cylinder, and a sphere are exposed to cool air. The center temperature of each geometry is to be determined.

Assumptions 1 Heat conduction in each geometry is one-dimensional. **2** The thermal properties of the geometries are constant. **3** The heat transfer coefficient is constant and uniform over the entire surface. **4** The Fourier number is $\tau > 0.2$ so that the one-term approximate solutions (or the transient temperature charts) are applicable (this assumption will be verified).

Properties The properties of cast iron are given to be $k = 29 \text{ Btu/h}\cdot\text{ft}\cdot^\circ\text{F}$ and $\alpha = 0.61 \text{ ft}^2/\text{h}$.

Analysis After 5 minutes

Plate: First the Biot number is calculated to be

$$Bi = \frac{hL}{k} = \frac{(7 \text{ Btu/h}\cdot\text{ft}^2\cdot^\circ\text{F})(0.5/12 \text{ ft})}{(29 \text{ Btu/h}\cdot\text{ft}\cdot^\circ\text{F})} = 0.01006 \cong 0.01$$

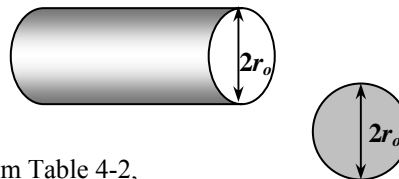

The constants λ_1 and A_1 corresponding to this Biot number are, from Table 4-2,

$$\lambda_1 = 0.0998 \quad \text{and} \quad A_1 = 1.0017$$

The Fourier number is

$$\tau = \frac{\alpha t}{L^2} = \frac{(0.61 \text{ ft}^2/\text{h})(5 \text{ min}/60 \text{ min/h})}{(0.5/12 \text{ ft})^2} = 29.28 > 0.2$$

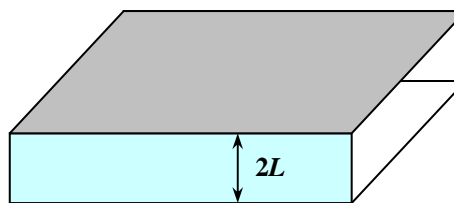

Then the center temperature of the plate becomes

$$\theta_{0,\text{wall}} = \frac{T_0 - T_\infty}{T_i - T_\infty} = A_1 e^{-\lambda_1^2 \tau} \longrightarrow \frac{T_0 - 75}{400 - 75} = (1.0017) e^{-(0.0998)^2 (29.28)} = 0.748 \longrightarrow T_0 = \mathbf{318^\circ\text{F}}$$

Cylinder:

$$Bi = 0.01 \xrightarrow{\text{Table 4-2}} \lambda_1 = 0.1412 \quad \text{and} \quad A_1 = 1.0025$$

$$\theta_{0,\text{cyl}} = \frac{T_0 - T_\infty}{T_i - T_\infty} = A_1 e^{-\lambda_1^2 \tau} \longrightarrow \frac{T_0 - 75}{400 - 75} = (1.0025) e^{-(0.1412)^2 (29.28)} = 0.559 \longrightarrow T_0 = \mathbf{257^\circ\text{F}}$$

Sphere:

$$Bi = 0.01 \xrightarrow{\text{Table 4-2}} \lambda_1 = 0.1730 \quad \text{and} \quad A_1 = 1.0030$$

$$\theta_{0,\text{sph}} = \frac{T_0 - T_\infty}{T_i - T_\infty} = A_1 e^{-\lambda_1^2 \tau} \longrightarrow \frac{T_0 - 75}{400 - 75} = (1.0030) e^{-(0.1730)^2 (29.28)} = 0.418 \longrightarrow T_0 = \mathbf{211^\circ\text{F}}$$

After 10 minutes

$$\tau = \frac{\alpha t}{L^2} = \frac{(0.61 \text{ ft}^2/\text{h})(10 \text{ min}/60 \text{ min/h})}{(0.5/12 \text{ ft})^2} = 58.56 > 0.2$$

Plate:

$$\theta_{0,\text{wall}} = \frac{T_0 - T_\infty}{T_i - T_\infty} = A_1 e^{-\lambda_1^2 \tau} \longrightarrow \frac{T_0 - 75}{400 - 75} = (1.0017) e^{-(0.0998)^2 (58.56)} = 0.559 \longrightarrow T_0 = \mathbf{257^\circ\text{F}}$$

Cylinder:

$$\theta_{0,\text{cyl}} = \frac{T_0 - T_\infty}{T_i - T_\infty} = A_1 e^{-\lambda_1^2 \tau} \longrightarrow \frac{T_0 - 75}{400 - 75} = (1.0025) e^{-(0.1412)^2 (58.56)} = 0.312 \longrightarrow T_0 = \mathbf{176^\circ\text{F}}$$

Sphere:

$$\theta_{0,\text{sph}} = \frac{T_0 - T_\infty}{T_i - T_\infty} = A_1 e^{-\lambda_1^2 \tau} \longrightarrow \frac{T_0 - 75}{400 - 75} = (1.0030) e^{-(0.1730)^2 (58.56)} = 0.174 \longrightarrow T_0 = \mathbf{132^\circ\text{F}}$$

After 30 minutes

$$\tau = \frac{\alpha t}{L^2} = \frac{(0.61 \text{ ft}^2/\text{h})(30 \text{ min}/60 \text{ min/h})}{(0.5/12 \text{ ft})^2} = 175.68 > 0.2$$

Plate:

$$\theta_{0,\text{wall}} = \frac{T_0 - T_\infty}{T_i - T_\infty} = A_1 e^{-\lambda_1^2 \tau} \longrightarrow \frac{T_0 - 75}{400 - 75} = (1.0017)e^{-(0.0998)^2(175.68)} = 0.174 \longrightarrow T_0 = \mathbf{132^\circ\text{F}}$$

Cylinder:

$$\theta_{0,\text{cyl}} = \frac{T_0 - T_\infty}{T_i - T_\infty} = A_1 e^{-\lambda_1^2 \tau} \longrightarrow \frac{T_0 - 75}{400 - 75} = (1.0025)e^{-(0.1412)^2(175.68)} = 0.030 \longrightarrow T_0 = \mathbf{84.8^\circ\text{F}}$$

Sphere:

$$\theta_{0,\text{sph}} = \frac{T_0 - T_\infty}{T_i - T_\infty} = A_1 e^{-\lambda_1^2 \tau} \longrightarrow \frac{T_0 - 75}{400 - 75} = (1.0030)e^{-(0.1730)^2(175.68)} = 0.0052 \longrightarrow T_0 = \mathbf{76.7^\circ\text{F}}$$

The sphere has the largest surface area through which heat is transferred per unit volume, and thus the highest rate of heat transfer. Consequently, the center temperature of the sphere is always the lowest.

4-122E EES Prob. 4-120E is reconsidered. The center temperature of each geometry as a function of the cooling time is to be plotted.

Analysis The problem is solved using EES, and the solution is given below.

"GIVEN"

2*L=1/12 [ft]
 2*r_o_c=1/12 [ft] "c stands for cylinder"
 2*r_o_s=1/12 [ft] "s stands for sphere"
 T_i=400 [F]
 T_infinity=75 [F]
 h=7 [Btu/h-ft^2-F]
 time=5 [min]

"PROPERTIES"

k=15 [Btu/h-ft-F]
 alpha=0.61*Convert(ft^2/h, ft^2/min) "[ft^2/min]"

"ANALYSIS"

"For plane wall"

Bi_w=(h*L)/k
 "From Table 4-2 corresponding to this Bi number, we read"
 lambda_1_w=0.0998
 A_1_w=1.0017
 tau_w=(alpha*time)/L^2
 (T_o_w-T_infinity)/(T_i-T_infinity)=A_1_w*exp(-lambda_1_w^2*tau_w)

"For long cylinder"

Bi_c=(h*r_o_c)/k
 "From Table 4-2 corresponding to this Bi number, we read"
 lambda_1_c=0.1412
 A_1_c=1.0025
 tau_c=(alpha*time)/r_o_c^2
 (T_o_c-T_infinity)/(T_i-T_infinity)=A_1_c*exp(-lambda_1_c^2*tau_c)

"For sphere"

Bi_s=(h*r_o_s)/k
 "From Table 4-2 corresponding to this Bi number, we read"
 lambda_1_s=0.1730
 A_1_s=1.0030
 tau_s=(alpha*time)/r_o_s^2
 (T_o_s-T_infinity)/(T_i-T_infinity)=A_1_s*exp(-lambda_1_s^2*tau_s)

time [min]	T _{o,w} [F]	T _{o,c} [F]	T _{o,s} [F]
5	318.2	256.7	210.7
10	256.7	176.4	131.5
15	210.7	131.5	98.52
20	176.4	106.5	84.79
25	150.7	92.59	79.08
30	131.6	84.81	76.7
35	117.3	80.47	75.71
40	106.6	78.05	75.29
45	98.59	76.7	75.12
50	92.62	75.95	75.05
55	88.16	75.53	75.02
60	84.83	75.3	75.01

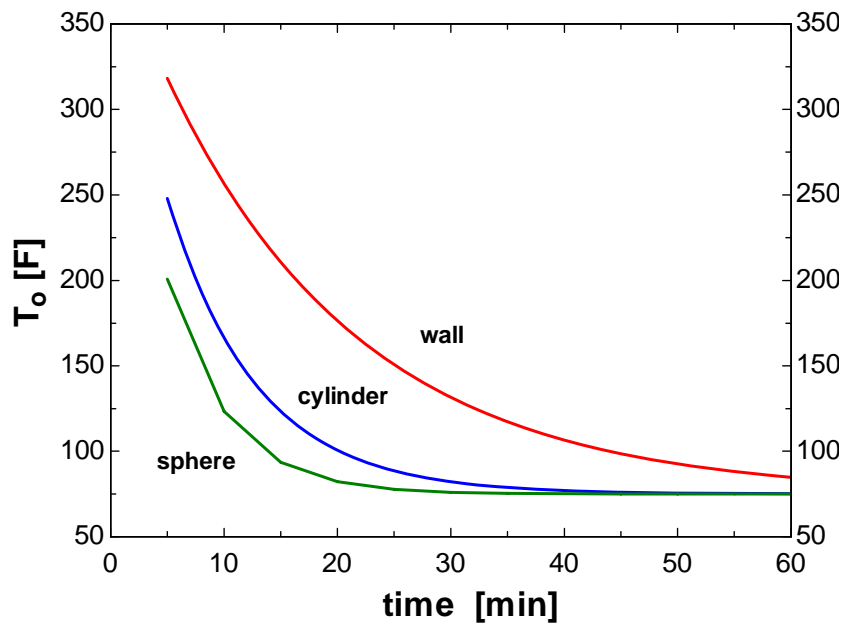

4-123 Internal combustion engine valves are quenched in a large oil bath. The time it takes for the valve temperature to drop to specified temperatures and the maximum heat transfer are to be determined.

Assumptions 1 The thermal properties of the valves are constant. **2** The heat transfer coefficient is constant and uniform over the entire surface. **3** Depending on the size of the oil bath, the oil bath temperature will increase during quenching. However, an average constant temperature as specified in the problem will be used. **4** The Biot number is $Bi < 0.1$ so that the lumped system analysis is applicable (this assumption will be verified).

Properties The thermal conductivity, density, and specific heat of the balls are given to be $k = 48$ W/m·°C, $\rho = 7840$ kg/m³, and $c_p = 440$ J/kg·°C.

Analysis (a) The characteristic length of the balls and the Biot number are

$$L_c = \frac{V}{A_s} = \frac{1.8(\pi D^2 L / 4)}{2\pi DL} = \frac{1.8D}{8} = \frac{1.8(0.008 \text{ m})}{8} = 0.0018 \text{ m}$$

$$Bi = \frac{hL_c}{k} = \frac{(800 \text{ W/m}^2 \cdot \text{°C})(0.0018 \text{ m})}{48 \text{ W/m} \cdot \text{°C}} = 0.03 < 0.1$$

Therefore, we can use lumped system analysis. Then the time for a final valve temperature of 400°C becomes

$$b = \frac{hA_s}{\rho c_p V} = \frac{8h}{1.8\rho c_p D} = \frac{8(800 \text{ W/m}^2 \cdot \text{°C})}{1.8(7840 \text{ kg/m}^3)(440 \text{ J/kg} \cdot \text{°C})(0.008 \text{ m})} = 0.1288 \text{ s}^{-1}$$

$$\frac{T(t) - T_\infty}{T_i - T_\infty} = e^{-bt} \longrightarrow \frac{400 - 50}{800 - 50} = e^{-(0.1288 \text{ s}^{-1})t} \longrightarrow t = \mathbf{5.9 \text{ s}}$$

(b) The time for a final valve temperature of 200°C is

$$\frac{T(t) - T_\infty}{T_i - T_\infty} = e^{-bt} \longrightarrow \frac{200 - 50}{800 - 50} = e^{-(0.1288 \text{ s}^{-1})t} \longrightarrow t = \mathbf{12.5 \text{ s}}$$

(c) The time for a final valve temperature of 51°C is

$$\frac{T(t) - T_\infty}{T_i - T_\infty} = e^{-bt} \longrightarrow \frac{51 - 50}{800 - 50} = e^{-(0.1288 \text{ s}^{-1})t} \longrightarrow t = \mathbf{51.4 \text{ s}}$$

(d) The maximum amount of heat transfer from a single valve is determined from

$$m = \rho V = \rho \frac{1.8\pi D^2 L}{4} = (7840 \text{ kg/m}^3) \frac{1.8\pi(0.008 \text{ m})^2 (0.10 \text{ m})}{4} = 0.0709 \text{ kg}$$

$$Q = mc_p [T_f - T_i] = (0.0709 \text{ kg})(440 \text{ J/kg} \cdot \text{°C})(800 - 50)^\circ\text{C} = 23,400 \text{ J} = \mathbf{23.4 \text{ kJ}} \text{ (per valve)}$$

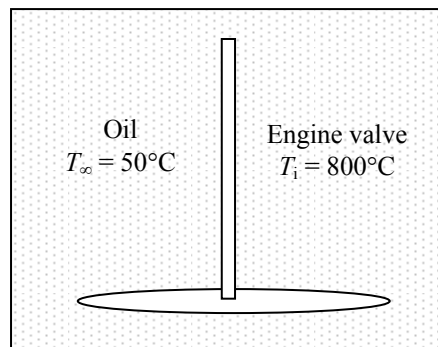

4-124 A watermelon is placed into a lake to cool it. The heat transfer coefficient at the surface of the watermelon and the temperature of the outer surface of the watermelon are to be determined.

Assumptions 1 The watermelon is a homogeneous spherical object. **2** Heat conduction in the watermelon is one-dimensional because of symmetry about the midpoint. **3** The thermal properties of the watermelon are constant. **4** The heat transfer coefficient is constant and uniform over the entire surface. **5** The Fourier number is $\tau > 0.2$ so that the one-term approximate solutions (or the transient temperature charts) are applicable (this assumption will be verified).

Properties The properties of the watermelon are given to be $k = 0.618 \text{ W/m}\cdot\text{°C}$, $\alpha = 0.15 \times 10^{-6} \text{ m}^2/\text{s}$, $\rho = 995 \text{ kg/m}^3$ and $c_p = 4.18 \text{ kJ/kg}\cdot\text{°C}$.

Analysis The Fourier number is

$$\tau = \frac{\alpha t}{r_o^2} = \frac{(0.15 \times 10^{-6} \text{ m}^2/\text{s})[(4 \times 60 + 40 \text{ min}) \times 60 \text{ s/min}]}{(0.10 \text{ m})^2} = 0.252$$

which is greater than 0.2. Then the one-term solution can be written in the form

$$\theta_{0,\text{sph}} = \frac{T_0 - T_\infty}{T_i - T_\infty} = A_1 e^{-\lambda_1^2 \tau} \longrightarrow \frac{20 - 15}{35 - 15} = 0.25 = A_1 e^{-\lambda_1^2 (0.252)}$$

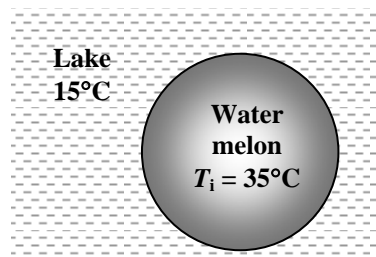

It is determined from Table 4-2 by trial and error that this equation is satisfied when $Bi = 10$, which corresponds to $\lambda_1 = 2.8363$ and $A_1 = 1.9249$. Then the heat transfer coefficient can be determined from

$$Bi = \frac{hr_o}{k} \longrightarrow h = \frac{kBi}{r_o} = \frac{(0.618 \text{ W/m}\cdot\text{°C})(10)}{(0.10 \text{ m})} = \mathbf{61.8 \text{ W/m}^2\cdot\text{°C}}$$

The temperature at the surface of the watermelon is

$$\theta(r_o, t)_{\text{sph}} = \frac{T(r_o, t) - T_\infty}{T_i - T_\infty} = A_1 e^{-\lambda_1^2 \tau} \frac{\sin(\lambda_1 r_o / r_o)}{\lambda_1 r_o / r_o} = (1.9249) e^{-(2.8363)^2 (0.252)} \frac{\sin(2.8363 \text{ rad})}{2.8363}$$

$$\frac{T(r_o, t) - 15}{35 - 15} = 0.0269 \longrightarrow T(r_o, t) = \mathbf{15.5 \text{ °C}}$$

4-125 Large food slabs are cooled in a refrigeration room. Center temperatures are to be determined for different foods.

Assumptions 1 Heat conduction in the slabs is one-dimensional since the slab is large relative to its thickness and there is thermal symmetry about the center plane. **3** The thermal properties of the slabs are constant. **4** The heat transfer coefficient is constant and uniform over the entire surface. **5** The Fourier number is $\tau > 0.2$ so that the one-term approximate solutions (or the transient temperature charts) are applicable (this assumption will be verified).

Properties The properties of foods are given to be $k = 0.233 \text{ W/m}\cdot^\circ\text{C}$ and $\alpha = 0.11 \times 10^{-6} \text{ m}^2/\text{s}$ for margarine, $k = 0.082 \text{ W/m}\cdot^\circ\text{C}$ and $\alpha = 0.10 \times 10^{-6} \text{ m}^2/\text{s}$ for white cake, and $k = 0.106 \text{ W/m}\cdot^\circ\text{C}$ and $\alpha = 0.12 \times 10^{-6} \text{ m}^2/\text{s}$ for chocolate cake.

Analysis (a) In the case of margarine, the Biot number is

$$Bi = \frac{hL}{k} = \frac{(25 \text{ W/m}^2 \cdot ^\circ\text{C})(0.05 \text{ m})}{(0.233 \text{ W/m}\cdot^\circ\text{C})} = 5.365$$

Air
 $T_\infty = 0^\circ\text{C}$

The constants λ_1 and A_1 corresponding to this Biot number are, from Table 4-2,

$$\lambda_1 = 1.3269 \quad \text{and} \quad A_1 = 1.2431$$

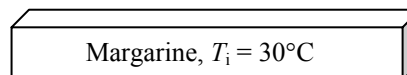

The Fourier number is $\tau = \frac{\alpha t}{L^2} = \frac{(0.11 \times 10^{-6} \text{ m}^2/\text{s})(6 \text{ h} \times 3600 \text{ s/h})}{(0.05 \text{ m})^2} = 0.9504 > 0.2$

Therefore, the one-term approximate solution (or the transient temperature charts) is applicable. Then the temperature at the center of the box if the box contains margarine becomes

$$\theta(0, t)_{\text{wall}} = \frac{T(0, t) - T_\infty}{T_i - T_\infty} = A_1 e^{-\lambda_1^2 \tau} = (1.2431) e^{-(1.3269)^2 (0.9504)}$$

$$\frac{T(0, t) - 0}{30 - 0} = 0.233 \longrightarrow T(0, t) = \mathbf{7.0^\circ\text{C}}$$

(b) Repeating the calculations for white cake,

$$Bi = \frac{hL}{k} = \frac{(25 \text{ W/m}^2 \cdot ^\circ\text{C})(0.05 \text{ m})}{(0.082 \text{ W/m}\cdot^\circ\text{C})} = 15.24 \longrightarrow \lambda_1 = 1.4641 \quad \text{and} \quad A_1 = 1.2661$$

$$\tau = \frac{\alpha t}{L^2} = \frac{(0.10 \times 10^{-6} \text{ m}^2/\text{s})(6 \text{ h} \times 3600 \text{ s/h})}{(0.05 \text{ m})^2} = 0.864 > 0.2$$

$$\theta(0, t)_{\text{wall}} = \frac{T(0, t) - T_\infty}{T_i - T_\infty} = A_1 e^{-\lambda_1^2 \tau} = (1.2661) e^{-(1.4641)^2 (0.864)}$$

$$\frac{T(0, t) - 0}{30 - 0} = 0.199 \longrightarrow T(0, t) = \mathbf{6.0^\circ\text{C}}$$

(c) Repeating the calculations for chocolate cake,

$$Bi = \frac{hL}{k} = \frac{(25 \text{ W/m}^2 \cdot ^\circ\text{C})(0.05 \text{ m})}{(0.106 \text{ W/m}\cdot^\circ\text{C})} = 11.79 \longrightarrow \lambda_1 = 1.4409 \quad \text{and} \quad A_1 = 1.2634$$

$$\tau = \frac{\alpha t}{L^2} = \frac{(0.12 \times 10^{-6} \text{ m}^2/\text{s})(6 \text{ h} \times 3600 \text{ s/h})}{(0.05 \text{ m})^2} = 1.0368 > 0.2$$

$$\theta(0, t)_{\text{wall}} = \frac{T(0, t) - T_\infty}{T_i - T_\infty} = A_1 e^{-\lambda_1^2 \tau} = (1.2634) e^{-(1.4409)^2 (1.0368)}$$

$$\frac{T(0, t) - 0}{30 - 0} = 0.147 \longrightarrow T(0, t) = \mathbf{4.4^\circ\text{C}}$$

4-126 A cold cylindrical concrete column is exposed to warm ambient air during the day. The time it will take for the surface temperature to rise to a specified value, the amounts of heat transfer for specified values of center and surface temperatures are to be determined.

Assumptions 1 Heat conduction in the column is one-dimensional since it is long and it has thermal symmetry about the center line. 2 The thermal properties of the column are constant. 3 The heat transfer coefficient is constant and uniform over the entire surface. 4 The Fourier number is $\tau > 0.2$ so that the one-term approximate solutions (or the transient temperature charts) are applicable (this assumption will be verified).

Properties The properties of concrete are given to be $k = 0.79 \text{ W/m}\cdot^\circ\text{C}$, $\alpha = 5.94 \times 10^{-7} \text{ m}^2/\text{s}$, $\rho = 1600 \text{ kg/m}^3$ and $c_p = 0.84 \text{ kJ/kg}\cdot^\circ\text{C}$

Analysis (a) The Biot number is

$$Bi = \frac{hr_o}{k} = \frac{(14 \text{ W/m}^2\cdot^\circ\text{C})(0.15 \text{ m})}{(0.79 \text{ W/m}\cdot^\circ\text{C})} = 2.658$$

The constants λ_1 and A_1 corresponding to this Biot number are, from Table 4-2,

$$\lambda_1 = 1.7240 \quad \text{and} \quad A_1 = 1.3915$$

Once the constant $J_0 = 0.3841$ is determined from Table 4-3 corresponding to the constant λ_1 , the Fourier number is determined to be

$$\frac{T(r_o, t) - T_\infty}{T_i - T_\infty} = A_1 e^{-\lambda_1^2 \tau} J_0(\lambda_1 r_o / r_o) \longrightarrow \frac{27 - 28}{14 - 28} = (1.3915) e^{-(1.7240)^2 \tau} (0.3841) \longrightarrow \tau = 0.6771$$

which is above the value of 0.2. Therefore, the one-term approximate solution (or the transient temperature charts) can be used. Then the time it will take for the column surface temperature to rise to 27°C becomes

$$t = \frac{\tau r_o^2}{\alpha} = \frac{(0.6771)(0.15 \text{ m})^2}{5.94 \times 10^{-7} \text{ m}^2/\text{s}} = 25,650 \text{ s} = \mathbf{7.1 \text{ hours}}$$

(b) The heat transfer to the column will stop when the center temperature of column reaches to the ambient temperature, which is 28°C . That is, we are asked to determine the maximum heat transfer between the ambient air and the column.

$$m = \rho V = \rho \pi r_o^2 L = (1600 \text{ kg/m}^3)[\pi(0.15 \text{ m})^2(4 \text{ m})] = 452.4 \text{ kg}$$

$$Q_{\max} = mc_p [T_\infty - T_i] = (452.4 \text{ kg})(0.84 \text{ kJ/kg}\cdot^\circ\text{C})(28 - 14)^\circ\text{C} = \mathbf{5320 \text{ kJ}}$$

(c) To determine the amount of heat transfer until the surface temperature reaches to 27°C , we first determine

$$\frac{T(0, t) - T_\infty}{T_i - T_\infty} = A_1 e^{-\lambda_1^2 \tau} = (1.3915) e^{-(1.7240)^2 (0.6771)} = 0.1860$$

Once the constant $J_1 = 0.5787$ is determined from Table 4-3 corresponding to the constant λ_1 , the amount of heat transfer becomes

$$\left(\frac{Q}{Q_{\max}} \right)_{\text{cyl}} = 1 - 2 \left(\frac{T_0 - T_\infty}{T_i - T_\infty} \right) \frac{J_1(\lambda_1)}{\lambda_1} = 1 - 2 \times 0.1860 \times \frac{0.5787}{1.7240} = 0.875$$

$$Q = 0.875 Q_{\max}$$

$$Q = 0.875(5320 \text{ kJ}) = \mathbf{4660 \text{ kJ}}$$

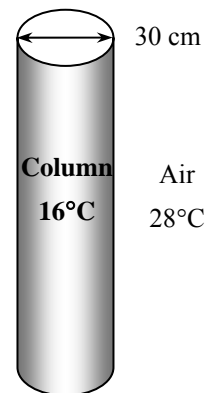

4-127 Long aluminum wires are extruded and exposed to atmospheric air. The time it will take for the wire to cool, the distance the wire travels, and the rate of heat transfer from the wire are to be determined.

Assumptions 1 Heat conduction in the wires is one-dimensional in the radial direction. **2** The thermal properties of the aluminum are constant. **3** The heat transfer coefficient is constant and uniform over the entire surface. **4** The Biot number is $Bi < 0.1$ so that the lumped system analysis is applicable (this assumption will be verified).

Properties The properties of aluminum are given to be $k = 236 \text{ W/m}\cdot\text{°C}$, $\rho = 2702 \text{ kg/m}^3$, $c_p = 0.896 \text{ kJ/kg}\cdot\text{°C}$, and $\alpha = 9.75 \times 10^{-5} \text{ m}^2/\text{s}$.

Analysis (a) The characteristic length of the wire and the Biot number are

$$L_c = \frac{V}{A_s} = \frac{\pi r_o^2 L}{2\pi r_o L} = \frac{r_o}{2} = \frac{0.0015 \text{ m}}{2} = 0.00075 \text{ m}$$

$$Bi = \frac{hL_c}{k} = \frac{(35 \text{ W/m}^2\cdot\text{°C})(0.00075 \text{ m})}{236 \text{ W/m}\cdot\text{°C}} = 0.00011 < 0.1$$

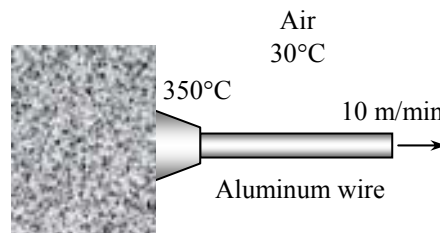

Since $Bi < 0.1$, the lumped system analysis is applicable. Then,

$$b = \frac{hA_s}{\rho c_p V} = \frac{h}{\rho c_p L_c} = \frac{35 \text{ W/m}^2\cdot\text{°C}}{(2702 \text{ kg/m}^3)(896 \text{ J/kg}\cdot\text{°C})(0.00075 \text{ m})} = 0.0193 \text{ s}^{-1}$$

$$\frac{T(t) - T_\infty}{T_i - T_\infty} = e^{-bt} \longrightarrow \frac{50 - 30}{350 - 30} = e^{-(0.0193 \text{ s}^{-1})t} \longrightarrow t = \mathbf{144 \text{ s}}$$

(b) The wire travels a distance of

$$\text{velocity} = \frac{\text{length}}{\text{time}} \rightarrow \text{length} = (10 / 60 \text{ m/s})(144 \text{ s}) = \mathbf{24 \text{ m}}$$

This distance can be reduced by cooling the wire in a water or oil bath.

(c) The mass flow rate of the extruded wire through the air is

$$\dot{m} = \rho \dot{V} = \rho(\pi r_o^2)V = (2702 \text{ kg/m}^3)\pi(0.0015 \text{ m})^2(10 \text{ m/min}) = 0.191 \text{ kg/min}$$

Then the rate of heat transfer from the wire to the air becomes

$$\dot{Q} = \dot{m}c_p[T(t) - T_\infty] = (0.191 \text{ kg/min})(0.896 \text{ kJ/kg}\cdot\text{°C})(350 - 50)\text{°C} = 51.3 \text{ kJ/min} = \mathbf{856 \text{ W}}$$

4-128 Long copper wires are extruded and exposed to atmospheric air. The time it will take for the wire to cool, the distance the wire travels, and the rate of heat transfer from the wire are to be determined.

Assumptions 1 Heat conduction in the wires is one-dimensional in the radial direction. **2** The thermal properties of the copper are constant. **3** The heat transfer coefficient is constant and uniform over the entire surface. **4** The Biot number is $Bi < 0.1$ so that the lumped system analysis is applicable (this assumption will be verified).

Properties The properties of copper are given to be $k = 386 \text{ W/m}\cdot\text{°C}$, $\rho = 8950 \text{ kg/m}^3$, $c_p = 0.383 \text{ kJ/kg}\cdot\text{°C}$, and $\alpha = 1.13 \times 10^{-4} \text{ m}^2/\text{s}$.

Analysis (a) The characteristic length of the wire and the Biot number are

$$L_c = \frac{V}{A_s} = \frac{\pi r_o^2 L}{2\pi r_o L} = \frac{r_o}{2} = \frac{0.0015 \text{ m}}{2} = 0.00075 \text{ m}$$

$$Bi = \frac{hL_c}{k} = \frac{(35 \text{ W/m}^2\cdot\text{°C})(0.00075 \text{ m})}{386 \text{ W/m}\cdot\text{°C}} = 0.000068 < 0.1$$

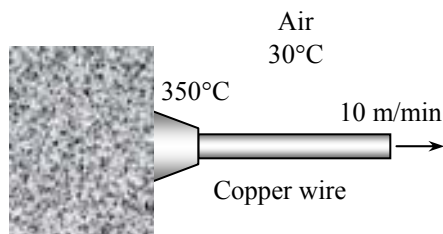

Since $Bi < 0.1$ the lumped system analysis is applicable. Then,

$$b = \frac{hA_s}{\rho c_p V} = \frac{h}{\rho c_p L_c} = \frac{35 \text{ W/m}^2\cdot\text{°C}}{(8950 \text{ kg/m}^3)(383 \text{ J/kg}\cdot\text{°C})(0.00075 \text{ m})} = 0.0136 \text{ s}^{-1}$$

$$\frac{T(t) - T_\infty}{T_i - T_\infty} = e^{-bt} \longrightarrow \frac{50 - 30}{350 - 30} = e^{-(0.0136 \text{ s}^{-1})t} \longrightarrow t = \mathbf{204 \text{ s}}$$

(b) The wire travels a distance of

$$\text{velocity} = \frac{\text{length}}{\text{time}} \longrightarrow \text{length} = \left(\frac{10 \text{ m/min}}{60 \text{ s/min}} \right) (204 \text{ s}) = \mathbf{34 \text{ m}}$$

This distance can be reduced by cooling the wire in a water or oil bath.

(c) The mass flow rate of the extruded wire through the air is

$$\dot{m} = \rho \dot{V} = \rho(\pi r_o^2) V = (8950 \text{ kg/m}^3) \pi (0.0015 \text{ m})^2 (10 \text{ m/min}) = 0.633 \text{ kg/min}$$

Then the rate of heat transfer from the wire to the air becomes

$$\dot{Q} = \dot{m} c_p [T(t) - T_\infty] = (0.633 \text{ kg/min})(0.383 \text{ kJ/kg}\cdot\text{°C})(350 - 50)^\circ\text{C} = 72.7 \text{ kJ/min} = \mathbf{1212 \text{ W}}$$

4-129 A brick house made of brick that was initially cold is exposed to warm atmospheric air at the outer surfaces. The time it will take for the temperature of the inner surfaces of the house to start changing is to be determined.

Assumptions 1 The temperature in the wall is affected by the thermal conditions at outer surfaces only, and thus the wall can be considered to be a semi-infinite medium with a specified outer surface temperature of 18°C. **2** The thermal properties of the brick wall are constant.

Properties The thermal properties of the brick are given to be $k = 0.72 \text{ W/m}\cdot\text{°C}$ and $\alpha = 0.45 \times 10^{-6} \text{ m}^2/\text{s}$.

Analysis The exact analytical solution to this problem is

$$\frac{T(x, t) - T_i}{T_s - T_i} = \text{erfc}\left(\frac{x}{\sqrt{\alpha t}}\right)$$

Substituting,

$$\frac{5.1 - 5}{15 - 5} = 0.01 = \text{erfc}\left(\frac{0.3 \text{ m}}{2\sqrt{(0.45 \times 10^{-6} \text{ m}^2/\text{s})t}}\right)$$

Noting from Table 4-4 that $0.01 = \text{erfc}(1.8215)$, the time is determined to be

$$\left(\frac{0.3 \text{ m}}{2\sqrt{(0.45 \times 10^{-6} \text{ m}^2/\text{s})t}}\right) = 1.8215 \longrightarrow t = 15,070 \text{ s} = \mathbf{251 \text{ min}}$$

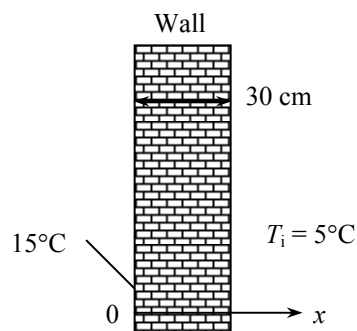

4-130 A thick wall is exposed to cold outside air. The wall temperatures at distances 15, 30, and 40 cm from the outer surface at the end of 2-hour cooling period are to be determined.

Assumptions 1 The temperature in the wall is affected by the thermal conditions at outer surfaces only. Therefore, the wall can be considered to be a semi-infinite medium **2** The thermal properties of the wall are constant.

Properties The thermal properties of the brick are given to be $k = 0.72 \text{ W/m}\cdot\text{°C}$ and $\alpha = 1.6 \times 10^{-7} \text{ m}^2/\text{s}$.

Analysis For a 15 cm distance from the outer surface, from Fig. 4-29 we have

$$\left. \begin{aligned} \frac{h\sqrt{\alpha t}}{k} &= \frac{(20 \text{ W/m}^2\cdot\text{°C})\sqrt{(1.6 \times 10^{-6} \text{ m}^2/\text{s})(2 \times 3600 \text{ s})}}{0.72 \text{ W/m}\cdot\text{°C}} = 2.98 \\ \eta &= \frac{x}{2\sqrt{\alpha t}} = \frac{0.15 \text{ m}}{2\sqrt{(1.6 \times 10^{-6} \text{ m}^2/\text{s})(2 \times 3600 \text{ s})}} = 0.70 \end{aligned} \right\} 1 - \frac{T - T_\infty}{T_i - T_\infty} = 0.25$$

$$1 - \frac{T - (-3)}{18 - (-3)} = 0.25 \longrightarrow T = \mathbf{12.8^\circ\text{C}}$$

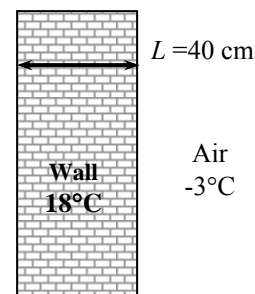

For a 30 cm distance from the outer surface, from Fig. 4-29 we have

$$\left. \begin{aligned} \frac{h\sqrt{\alpha t}}{k} &= \frac{(20 \text{ W/m}^2\cdot\text{°C})\sqrt{(1.6 \times 10^{-6} \text{ m}^2/\text{s})(2 \times 3600 \text{ s})}}{0.72 \text{ W/m}\cdot\text{°C}} = 2.98 \\ \eta &= \frac{x}{2\sqrt{\alpha t}} = \frac{0.3 \text{ m}}{2\sqrt{(1.6 \times 10^{-6} \text{ m}^2/\text{s})(2 \times 3600 \text{ s})}} = 1.40 \end{aligned} \right\} 1 - \frac{T - T_\infty}{T_i - T_\infty} = 0.038$$

$$1 - \frac{T - (-3)}{18 - (-3)} = 0.038 \longrightarrow T = \mathbf{17.2^\circ\text{C}}$$

For a 40 cm distance from the outer surface, that is for the inner surface, from Fig. 4-29 we have

$$\left. \begin{aligned} \frac{h\sqrt{\alpha t}}{k} &= \frac{(20 \text{ W/m}^2\cdot\text{°C})\sqrt{(1.6 \times 10^{-6} \text{ m}^2/\text{s})(2 \times 3600 \text{ s})}}{0.72 \text{ W/m}\cdot\text{°C}} = 2.98 \\ \eta &= \frac{x}{2\sqrt{\alpha t}} = \frac{0.4 \text{ m}}{2\sqrt{(1.6 \times 10^{-6} \text{ m}^2/\text{s})(2 \times 3600 \text{ s})}} = 1.87 \end{aligned} \right\} 1 - \frac{T - T_\infty}{T_i - T_\infty} = 0$$

$$1 - \frac{T - (-3)}{18 - (-3)} = 0 \longrightarrow T = \mathbf{18.0^\circ\text{C}}$$

Discussion This last result shows that the semi-infinite medium assumption is a valid one.

4-131 The engine block of a car is allowed to cool in atmospheric air. The temperatures at the center of the top surface and at the corner after a specified period of cooling are to be determined.

Assumptions 1 Heat conduction in the block is three-dimensional, and thus the temperature varies in all three directions. **2** The thermal properties of the block are constant. **3** The heat transfer coefficient is constant and uniform over the entire surface. **4** The Fourier number is $\tau > 0.2$ so that the one-term approximate solutions (or the transient temperature charts) are applicable (this assumption will be verified).

Properties The thermal properties of cast iron are given to be $k = 52 \text{ W/m}\cdot^\circ\text{C}$ and $\alpha = 1.7 \times 10^{-5} \text{ m}^2/\text{s}$.

Analysis This rectangular block can physically be formed by the intersection of two infinite plane walls of thickness $2L = 40 \text{ cm}$ (call planes A and B) and an infinite plane wall of thickness $2L = 80 \text{ cm}$ (call plane C). We measure x from the center of the block.

(a) The Biot number is calculated for each of the plane wall to be

$$Bi_A = Bi_B = \frac{hL}{k} = \frac{(6 \text{ W/m}^2 \cdot ^\circ\text{C})(0.2 \text{ m})}{(52 \text{ W/m}\cdot^\circ\text{C})} = 0.0231$$

$$Bi_C = \frac{hL}{k} = \frac{(6 \text{ W/m}^2 \cdot ^\circ\text{C})(0.4 \text{ m})}{(52 \text{ W/m}\cdot^\circ\text{C})} = 0.0462$$

The constants λ_1 and A_1 corresponding to these Biot numbers are, from Table 4-2,

$$\lambda_{1(A,B)} = 0.150 \quad \text{and} \quad A_{1(A,B)} = 1.0038$$

$$\lambda_{1(C)} = 0.212 \quad \text{and} \quad A_{1(C)} = 1.0076$$

The Fourier numbers are

$$\tau_{A,B} = \frac{\alpha t}{L^2} = \frac{(1.70 \times 10^{-5} \text{ m}^2/\text{s})(45 \text{ min} \times 60 \text{ s/min})}{(0.2 \text{ m})^2} = 1.1475 > 0.2$$

$$\tau_C = \frac{\alpha t}{L^2} = \frac{(1.70 \times 10^{-5} \text{ m}^2/\text{s})(45 \text{ min} \times 60 \text{ s/min})}{(0.4 \text{ m})^2} = 0.2869 > 0.2$$

The center of the top surface of the block (whose sides are 80 cm and 40 cm) is at the center of the plane wall with $2L = 80 \text{ cm}$, at the center of the plane wall with $2L = 40 \text{ cm}$, and at the surface of the plane wall with $2L = 40 \text{ cm}$. The dimensionless temperatures are

$$\theta_{o,\text{wall(A)}} = \frac{T_0 - T_\infty}{T_i - T_\infty} = A_1 e^{-\lambda_1^2 \tau} = (1.0038) e^{-(0.150)^2 (1.1475)} = 0.9782$$

$$\theta(L, t)_{\text{wall(B)}} = \frac{T(x, t) - T_\infty}{T_i - T_\infty} = A_1 e^{-\lambda_1^2 \tau} \cos(\lambda_1 L / L) = (1.0038) e^{-(0.150)^2 (1.1475)} \cos(0.150) = 0.9672$$

$$\theta_{o,\text{wall(C)}} = \frac{T_0 - T_\infty}{T_i - T_\infty} = A_1 e^{-\lambda_1^2 \tau} = (1.0076) e^{-(0.212)^2 (0.2869)} = 0.9947$$

Then the center temperature of the top surface of the cylinder becomes

$$\left[\frac{T(L, 0, 0, t) - T_\infty}{T_i - T_\infty} \right]_{\text{short cylinder}} = \theta(L, t)_{\text{wall(B)}} \times \theta_{o,\text{wall(A)}} \times \theta_{o,\text{wall(C)}} = 0.9672 \times 0.9782 \times 0.9947 = 0.9411$$

$$\frac{T(L, 0, 0, t) - 17}{150 - 17} = 0.9411 \longrightarrow T(L, 0, 0, t) = \mathbf{142.2^\circ\text{C}}$$

Air
17°C

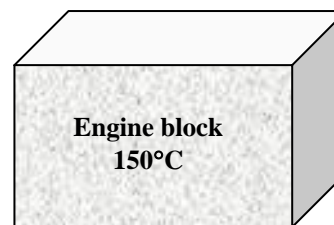

(b) The corner of the block is at the surface of each plane wall. The dimensionless temperature for the surface of the plane walls with $2L = 40$ cm is determined in part (a). The dimensionless temperature for the surface of the plane wall with $2L = 80$ cm is determined from

$$\theta(L, t)_{\text{wall(C)}} = \frac{T(x, t) - T_\infty}{T_i - T_\infty} = A_1 e^{-\lambda_1^2 \tau} \cos(\lambda_1 L / L) = (1.0076) e^{-(0.212)^2 (0.2869)} \cos(0.212) = 0.9724$$

Then the corner temperature of the block becomes

$$\left[\frac{T(L, L, L, t) - T_\infty}{T_i - T_\infty} \right]_{\text{short cylinder}} = \theta(L, t)_{\text{wall,C}} \times \theta(L, t)_{\text{wall,B}} \times \theta(L, t)_{\text{wall,A}} = 0.9724 \times 0.9672 \times 0.9672 = 0.9097$$

$$\frac{T(L, L, L, t) - 17}{150 - 17} = 0.9097 \longrightarrow T(L, L, L, t) = \mathbf{138.0^\circ\text{C}}$$

4-132 A man is found dead in a room. The time passed since his death is to be estimated.

Assumptions 1 Heat conduction in the body is two-dimensional, and thus the temperature varies in both radial r - and x - directions. **2** The thermal properties of the body are constant. **3** The heat transfer coefficient is constant and uniform over the entire surface. **4** The human body is modeled as a cylinder. **5** The Fourier number is $\tau > 0.2$ so that the one-term approximate solutions (or the transient temperature charts) are applicable (this assumption will be verified).

Properties The thermal properties of body are given to be $k = 0.62$ W/m \cdot °C and $\alpha = 0.15 \times 10^{-6}$ m 2 /s.

Analysis A short cylinder can be formed by the intersection of a long cylinder of radius $D/2 = 14$ cm and a plane wall of thickness $2L = 180$ cm. We measure x from the midplane. The temperature of the body is specified at a point that is at the center of the plane wall but at the surface of the cylinder. The Biot numbers and the corresponding constants are first determined to be

$$Bi_{\text{wall}} = \frac{hL}{k} = \frac{(9 \text{ W/m}^2 \cdot \text{°C})(0.90 \text{ m})}{(0.62 \text{ W/m} \cdot \text{°C})} = 13.06$$

$$\longrightarrow \lambda_1 = 1.4495 \quad \text{and} \quad A_1 = 1.2644$$

$$Bi_{\text{cyl}} = \frac{hr_o}{k} = \frac{(9 \text{ W/m}^2 \cdot \text{°C})(0.14 \text{ m})}{(0.62 \text{ W/m} \cdot \text{°C})} = 2.03$$

$$\longrightarrow \lambda_1 = 1.6052 \quad \text{and} \quad A_1 = 1.3408$$

Noting that $\tau = \alpha t / L^2$ for the plane wall and $\tau = \alpha t / r_o^2$ for cylinder and $J_0(1.6052) = 0.4524$ from Table 4-3, and assuming that $\tau > 0.2$ in all dimensions so that the one-term approximate solution for transient heat conduction is applicable, the product solution method can be written for this problem as

$$\theta(0, r_0, t)_{\text{block}} = \theta(0, t)_{\text{wall}} \theta(r_0, t)_{\text{cyl}}$$

$$\frac{23 - 16}{36 - 16} = (A_1 e^{-\lambda_1^2 \tau}) \left[A_1 e^{-\lambda_1^2 \tau} J_0(\lambda_1 r / r_0) \right]$$

$$0.40 = \left\{ (1.2644) \exp \left[- (1.4495)^2 \frac{(0.15 \times 10^{-6}) t}{(0.90)^2} \right] \right\}$$

$$\times \left\{ (1.3408) \exp \left[- (1.6052)^2 \frac{(0.15 \times 10^{-6}) t}{(0.14)^2} \right] (0.4524) \right\}$$

$$\longrightarrow t = 32,404 \text{ s} = \mathbf{9.0 \text{ hours}}$$

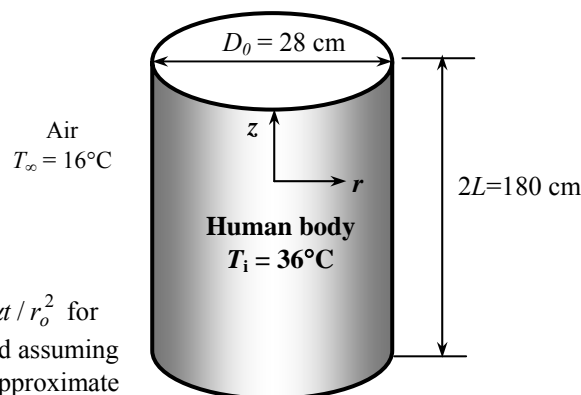

4-133 An exothermic process occurs uniformly throughout a sphere. The variation of temperature with time is to be obtained. The steady-state temperature of the sphere and the time needed for the sphere to reach the average of its initial and final (steady) temperatures are to be determined.

Assumptions 1 The sphere may be approximated as a lumped system. **2** The thermal properties of the sphere are constant. **3** The heat transfer coefficient is constant and uniform over the entire surface.

Properties The properties of sphere are given to be $k = 300 \text{ W/m}\cdot\text{K}$, $c_p = 400 \text{ J/kg}\cdot\text{K}$, $\rho = 7500 \text{ kg/m}^3$.

Analysis (a) First, we check the applicability of lumped system as follows:

$$L_c = \frac{V}{A_{\text{surface}}} = \frac{\pi D^3 / 6}{\pi D^2} = \frac{D}{6} = \frac{0.10 \text{ m}}{6} = 0.0167 \text{ m}$$

$$Bi = \frac{hL_c}{k} = \frac{(250 \text{ W/m}^2\cdot\text{C})(0.0167 \text{ m})}{300 \text{ W/m}\cdot\text{C}} = 0.014 < 0.1$$

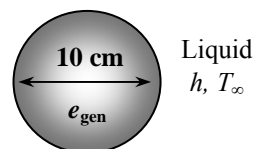

Since $Bi < 0.1$, the lumped system analysis is applicable. An energy balance on the system may be written to give

$$\dot{e}_{\text{gen}} V = hA(T - T_{\infty}) + mc \frac{dT}{dt}$$

$$\dot{e}_{\text{gen}} (\pi D^3 / 6) = h\pi D^2 (T - T_{\infty}) + \rho(\pi D^3 / 6) \frac{dT}{dt}$$

$$(1.2 \times 10^6) \pi (0.10)^3 / 6 = (250) \pi (0.10)^2 (T - 20) + (7500) [\pi (0.10)^3 / 6] (400) \frac{dT}{dt}$$

$$20,000 = 250T - 5000 + 50,000 \frac{dT}{dt}$$

$$\frac{dT}{dt} = 0.5 - 0.005T$$

(b) Now, we use integration to get the variation of sphere temperature with time

$$\frac{dT}{dt} = 0.5 - 0.005T$$

$$\frac{dT}{0.5 - 0.005T} = dt \longrightarrow \int_{20}^T \frac{dT}{0.5 - 0.005T} = \int_0^t dt$$

$$-\frac{1}{0.005} \ln(0.5 - 0.005T) \Big|_{20}^T = t \Big|_0^t = t$$

$$\ln\left(\frac{0.5 - 0.005T}{0.5 - 0.005 \times 20}\right) = -0.005t \longrightarrow \frac{0.5 - 0.005T}{0.4} = e^{-0.005t}$$

$$0.005T = 0.5 - 0.4e^{-0.005t} \longrightarrow T = 100 - 80e^{-0.005t}$$

We obtain the steady-state temperature by setting time to infinity:

$$T = 100 - 80e^{-0.005t} = 100 - e^{-\infty} = \mathbf{100^{\circ}\text{C}}$$

or $\frac{dT}{dt} = 0 \longrightarrow 0.5 - 0.005T = 0 \longrightarrow T = 100^{\circ}\text{C}$

(c) The time needed for the sphere to reach the average of its initial and final (steady) temperatures is determined from

$$T = 100 - 80e^{-0.005t}$$

$$\frac{20 + 100}{2} = 100 - 80e^{-0.005t} \longrightarrow t = \mathbf{139 \text{ s}}$$

4-134 Large steel plates are quenched in an oil reservoir. The quench time is to be determined.

Assumptions 1 The thermal properties of the plates are constant. **2** The heat transfer coefficient is constant and uniform over the entire surface.

Properties The properties of steel plates are given to be $k = 45 \text{ W/m}\cdot\text{K}$, $\rho = 7800 \text{ kg/m}^3$, and $c_p = 470 \text{ J/kg}\cdot\text{K}$.

Analysis For sphere, the characteristic length and the Biot number are

$$L_c = \frac{\mathcal{V}}{A_{\text{surface}}} = \frac{L}{2} = \frac{0.01 \text{ m}}{2} = 0.005 \text{ m}$$

$$Bi = \frac{hL_c}{k} = \frac{(400 \text{ W/m}^2\cdot\text{C})(0.005 \text{ m})}{45 \text{ W/m}\cdot\text{C}} = 0.044 < 0.1$$

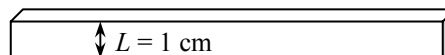

Since $Bi < 0.1$, the lumped system analysis is applicable. Then the cooling time is determined from

$$b = \frac{hA}{\rho c_p \mathcal{V}} = \frac{h}{\rho c_p L_c} = \frac{400 \text{ W/m}^2\cdot\text{C}}{(7800 \text{ kg/m}^3)(470 \text{ J/kg}\cdot\text{C})(0.005 \text{ m})} = 0.02182 \text{ s}^{-1}$$

$$\frac{T(t) - T_\infty}{T_i - T_\infty} = e^{-bt} \longrightarrow \frac{100 - 30}{600 - 30} = e^{-(0.02182 \text{ s}^{-1})t} \longrightarrow t = 96 \text{ s} = \mathbf{1.6 \text{ min}}$$

4-135 Aluminum wires leaving the extruder at a specified rate are cooled in air. The necessary length of the wire is to be determined.

Assumptions 1 The thermal properties of the geometry are constant. **2** The heat transfer coefficient is constant and uniform over the entire surface.

Properties The properties of aluminum are $k = 237 \text{ W/m}\cdot\text{C}$, $\rho = 2702 \text{ kg/m}^3$, and $c_p = 0.903 \text{ kJ/kg}\cdot\text{C}$ (Table A-3).

Analysis For a long cylinder, the characteristic length and the Biot number are

$$L_c = \frac{\mathcal{V}}{A_{\text{surface}}} = \frac{(\pi D^2 / 4)L}{\pi DL} = \frac{D}{4} = \frac{0.003 \text{ m}}{4} = 0.00075 \text{ m}$$

$$Bi = \frac{hL_c}{k} = \frac{(50 \text{ W/m}^2\cdot\text{C})(0.00075 \text{ m})}{237 \text{ W/m}\cdot\text{C}} = 0.00016 < 0.1$$

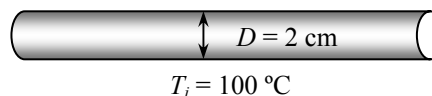

Since $Bi < 0.1$, the lumped system analysis is applicable. Then the cooling time is determined from

$$b = \frac{hA}{\rho c_p \mathcal{V}} = \frac{h}{\rho c_p L_c} = \frac{50 \text{ W/m}^2\cdot\text{C}}{(2702 \text{ kg/m}^3)(903 \text{ J/kg}\cdot\text{C})(0.00075 \text{ m})} = 0.02732 \text{ s}^{-1}$$

$$\frac{T(t) - T_\infty}{T_i - T_\infty} = e^{-bt} \longrightarrow \frac{50 - 25}{350 - 25} = e^{-(0.02732 \text{ s}^{-1})t} \longrightarrow t = 93.9 \text{ s}$$

Then the necessary length of the wire in the cooling section is determined to be

$$\text{Length} = \frac{t}{V} = \frac{(93.9 / 60) \text{ min}}{10 \text{ m/min}} = \mathbf{0.157 \text{ m}}$$

Fundamentals of Engineering (FE) Exam Problems

4-136 Copper balls ($\rho = 8933 \text{ kg/m}^3$, $k = 401 \text{ W/m}\cdot\text{°C}$, $c_p = 385 \text{ J/kg}\cdot\text{°C}$, $\alpha = 1.166 \times 10^{-4} \text{ m}^2/\text{s}$) initially at 200°C are allowed to cool in air at 30°C for a period of 2 minutes. If the balls have a diameter of 2 cm and the heat transfer coefficient is $80 \text{ W/m}^2\cdot\text{°C}$, the center temperature of the balls at the end of cooling is

- (a) 104°C (b) 87°C (c) 198°C (d) 126°C (e) 152°C

Answer (a) 104°C

Solution Solved by EES Software. Solutions can be verified by copying-and-pasting the following lines on a blank EES screen.

```
D=0.02 [m]
Cp=385 [J/kg-K]
rho= 8933 [kg/m^3]
k=401 [W/m-K]
V=pi*D^3/6
A=pi*D^2
m=rho*V
h=80 [W/m^2-C]
Ti=200 [C]
Tinf=30 [C]
b=h*A/(rho*V*Cp)
time=2*60 [s]
Bi=h*(V/A)/k
```

"Lumped system analysis is applicable. Applying the lumped system analysis equation:"
 $(T-T_{\text{inf}})/(T_i-T_{\text{inf}})=\exp(-b \cdot \text{time})$

"Some Wrong Solutions with Common Mistakes:"

$(W1_T-0)/(T_i-0)=\exp(-b \cdot \text{time})$ "Tinf is ignored"

$(-W2_T+T_{\text{inf}})/(T_i-T_{\text{inf}})=\exp(-b \cdot \text{time})$ "Sign error"

$(W3_T-T_i)/(T_{\text{inf}}-T_i)=\exp(-b \cdot \text{time})$ "Switching T_i and T_{inf} "

$(W4_T-T_{\text{inf}})/(T_i-T_{\text{inf}})=\exp(-b \cdot \text{time}/60)$ "Using minutes instead of seconds"

4-137 A 10-cm-inner diameter, 30-cm long can filled with water initially at 25°C is put into a household refrigerator at 3°C. The heat transfer coefficient on the surface of the can is 14 W/m²·°C. Assuming that the temperature of the water remains uniform during the cooling process, the time it takes for the water temperature to drop to 5°C is

- (a) 0.55 h (b) 1.17 h (c) 2.09 h (d) 3.60 h (e) 4.97 h

Answer (e) 4.97 h

Solution Solved by EES Software. Solutions can be verified by copying-and-pasting the following lines on a blank EES screen.

```
D=0.10 [m]
L=0.30 [m]
T_i=25 [C]
T_infinity=3 [C]
T_f=5 [C]
h=14 [W/m^2-C]
A_s=pi*D*L
V=pi*D^2/4*L
rho=1000 [kg/m^3]
c_p=4180 [J/kg-C]
b=(h*A_s)/(rho*c_p*V)
(T_f-T_infinity)/(T_i-T_infinity)=exp(-b*t)
t_hour=t*Convert(s, h)
```

4-138 An 18-cm-long, 16-cm-wide, and 12-cm-high hot iron block ($\rho = 7870 \text{ kg/m}^3$, $c_p = 447 \text{ J/kg}\cdot^\circ\text{C}$) initially at 20°C is placed in an oven for heat treatment. The heat transfer coefficient on the surface of the block is 100 W/m²·°C. If it is required that the temperature of the block rises to 750°C in a 25-min period, the oven must be maintained at

- (a) 750°C (b) 830°C (c) 875°C (d) 910°C (e) 1000°C

Answer (d) 910°C

Solution Solved by EES Software. Solutions can be verified by copying-and-pasting the following lines on a blank EES screen.

```
Length=0.18 [m]
Width=0.16 [m]
Height=0.12 [m]
rho=7870 [kg/m^3]
c_p=447 [J/kg-C]
T_i=20 [C]
T_f=750 [C]
h=100 [W/m^2-C]
t=25*60 [s]
A_s=2*Length*Width+2*Length*Height+2*Width*Height
V=Length*Width*Height
b=(h*A_s)/(rho*c_p*V)
(T_f-T_infinity)/(T_i-T_infinity)=exp(-b*t)
```

4-139 A small chicken ($k = 0.45 \text{ W/m}\cdot\text{C}$, $\alpha = 0.15 \times 10^{-6} \text{ m}^2/\text{s}$) can be approximated as an 11.25-cm-diameter solid sphere. The chicken is initially at a uniform temperature of 8°C and is to be cooked in an oven maintained at 220°C with a heat transfer coefficient of $80 \text{ W/m}^2\cdot\text{C}$. With this idealization, the temperature at the center of the chicken after a 90-min period is

- (a) 25°C (b) 61°C (c) 89°C (d) 122°C (e) 168°C

Answer (e) 168°C

Solution Solved by EES Software. Solutions can be verified by copying-and-pasting the following lines on a blank EES screen.

```
k=0.45 [W/m-C]
alpha=0.15E-6 [m^2/s]
D=0.1125 [m]
T_i=8 [C]
T_infinity=220 [C]
h=80 [W/m^2-C]
t=90*60 [s]
```

```
r_0=D/2
Bi=(h*r_0)/k "The coefficients lambda_1 and A_1 corresponding to the calculated Bi number of 10
are obtained from Table 4-2 of the text as"
lambda_1=2.8363
A_1=1.9249
tau=(alpha*t)/r_0^2
(T_0-T_infinity)/(T_i-T_infinity)=A_1*exp(-lambda_1^2*tau)
```

"Some Wrong Solutions with Common Mistakes"

```
lambda_1a=1.4289
A_1a=1.2620
(W1_T_0-T_infinity)/(T_i-T_infinity)=A_1a*exp(-lambda_1a^2*tau) "Using coefficients for plane
wall in Table 4-2"
lambda_1b=2.1795
A_1b=1.5677
(W2_T_0-T_infinity)/(T_i-T_infinity)=A_1b*exp(-lambda_1b^2*tau) "Using coefficients for cylinder
in Table 4-2"
```

4-140 In a production facility, large plates made of stainless steel ($k = 15 \text{ W/m}\cdot\text{C}$, $\alpha = 3.91 \times 10^{-6} \text{ m}^2/\text{s}$) of 40 cm thickness are taken out of an oven at a uniform temperature of 750°C . The plates are placed in a water bath that is kept at a constant temperature of 20°C with a heat transfer coefficient of $600 \text{ W/m}^2\cdot\text{C}$. The time it takes for the surface temperature of the plates to drop to 100°C is

- (a) 0.28 h (b) 0.99 h (c) 2.05 h (d) 3.55 h (e) 5.33 h

Answer (b) 0.99 h

Solution Solved by EES Software. Solutions can be verified by copying-and-pasting the following lines on a blank EES screen.

```
k=15 [W/m-C]
alpha=3.91E-6 [m^2/s]
2*L=0.4 [m]
T_i=750 [C]
T_infinity=20 [C]
h=600 [W/m^2-C]
T_s=100 [C]
```

$Bi=(h*L)/k$ "The coefficients λ_1 and A_1 corresponding to the calculated Bi number of 8 are obtained from Table 4-2 of the text as"

$\lambda_1=1.3978$

$A_1=1.2570$

$\tau=(\alpha*t)/L^2$

$(T_s-T_\infty)/(T_i-T_\infty)=A_1*\exp(-\lambda_1^2*\tau)*\cos(\lambda_1)$

"Some Wrong Solutions with Common Mistakes"

$\tau_1=(\alpha*W1_t)/L^2$

$(T_s-T_\infty)/(T_i-T_\infty)=A_1*\exp(-\lambda_1^2*\tau_1)$ "Using the relation for center temperature"

4-141 A long 18-cm-diameter bar made of hardwood ($k = 0.159 \text{ W/m}\cdot\text{C}$, $\alpha = 1.75 \times 10^{-7} \text{ m}^2/\text{s}$) is exposed to air at 30°C with a heat transfer coefficient of $8.83 \text{ W/m}^2\cdot\text{C}$. If the center temperature of the bar is measured to be 15°C after a period of 3-hours, the initial temperature of the bar is

- (a) 11.9°C (b) 4.9°C (c) 1.7°C (d) 0°C (e) -9.2°C

Answer (b) 4.9°C

Solution Solved by EES Software. Solutions can be verified by copying-and-pasting the following lines on a blank EES screen.

```
D=0.18 [m]
k=0.159 [W/m-C]
alpha=1.75E-7 [m^2/s]
T_infinity=30 [C]
h=8.83 [W/m^2-C]
T_0=15 [C]
t=3*3600 [s]
```

```
r_0=D/2
```

```
Bi=(h*r_0)/k "The coefficients lambda_1 and A_1 corresponding to the calculated Bi = 5 are
obtained from Table 4-2 of the text as"
```

```
lambda_1=1.9898
```

```
A_1=1.5029
```

```
tau=(alpha*t)/r_0^2
```

```
(T_0-T_infinity)/(T_i-T_infinity)=A_1*exp(-lambda_1^2*tau)
```

```
"Some Wrong Solutions with Common Mistakes"
```

```
lambda_1a=1.3138
```

```
A_1a=1.2403
```

```
(T_0-T_infinity)/(W1_T_i-T_infinity)=A_1a*exp(-lambda_1a^2*tau) "Using coefficients for plane
wall in Table 4-2"
```

```
lambda_1b=2.5704
```

```
A_1b=1.7870
```

```
(T_0-T_infinity)/(W2_T_i-T_infinity)=A_1b*exp(-lambda_1b^2*tau) "Using coefficients for sphere
in Table 4-2"
```

4-142 A potato may be approximated as a 5.7-cm-diameter solid sphere with the properties $\rho = 910 \text{ kg/m}^3$, $c_p = 4.25 \text{ kJ/kg}\cdot^\circ\text{C}$, $k = 0.68 \text{ W/m}\cdot^\circ\text{C}$, and $\alpha = 1.76 \times 10^{-7} \text{ m}^2/\text{s}$. Twelve such potatoes initially at 25°C are to be cooked by placing them in an oven maintained at 250°C with a heat transfer coefficient of $95 \text{ W/m}^2\cdot^\circ\text{C}$. The amount of heat transfer to the potatoes during a 30-min period is

- (a) 77 kJ (b) 483 kJ (c) 927 kJ (d) 970 kJ (e) 1012 kJ

Answer (c) 927 kJ

Solution Solved by EES Software. Solutions can be verified by copying-and-pasting the following lines on a blank EES screen.

```

D=0.057 [m]
rho=910 [kg/m^3]
c_p=4250 [J/kg-C]
k=0.68 [W/m-C]
alpha=1.76E-7 [m^2/s]
n=12
T_i=25 [C]
T_infinity=250 [C]
h=95 [W/m^2-C]
t=30*60 [s]

r_0=D/2
Bi=(h*r_0)/k "The coefficients lambda_1 and A_1 corresponding to the calculated Bi = 4 are
obtained from Table 4-2 of the text as"
lambda_1=2.4556
A_1=1.7202
tau=(alpha*t)/r_0^2
Theta_0=A_1*exp(-lambda_1^2*tau)
V=pi*D^3/6
Q_max=n*rho*V*c_p*(T_infinity-T_i)
Q=Q_max*(1-3*Theta_0*(sin(lambda_1)-lambda_1*cos(lambda_1))/lambda_1^3)

"Some Wrong Solutions with Common Mistakes"
W1_Q=Q_max "Using Q_max as the result"
W2_Q=Q_max*(1-Theta_0*(sin(lambda_1))/lambda_1) "Using the relation for plane wall"
W2_Q_max=rho*V*c_p*(T_infinity-T_i)
W3_Q=W2_Q_max*(1-3*Theta_0*(sin(lambda_1)-lambda_1*cos(lambda_1))/lambda_1^3) "Not
multiplying with the number of potatoes"

```

4-143 A potato that may be approximated as a 5.7-cm-diameter solid sphere with the properties $\rho = 910$ kg/m³, $c_p = 4.25$ kJ/kg·°C, $k = 0.68$ W/m·°C, and $\alpha = 1.76 \times 10^{-7}$ m²/s. Twelve such potatoes initially at 25°C are to be cooked by placing them in an oven maintained at 250°C with a heat transfer coefficient of 95 W/m²·°C. The amount of heat transfer to the potatoes by the time the center temperature reaches 100°C is

- (a) 56 kJ (b) 666 kJ (c) 838 kJ (d) 940 kJ (e) 1088 kJ

Answer (b) 666 kJ

Solution Solved by EES Software. Solutions can be verified by copying-and-pasting the following lines on a blank EES screen.

```
D=0.057 [m]
rho=910 [kg/m^3]
c_p=4250 [J/kg-C]
k=0.68 [W/m-C]
alpha=1.76E-7 [m^2/s]
n=12
T_i=25 [C]
T_infinity=250 [C]
h=95 [W/m^2-C]
T_0=100 [C]
r_0=D/2
Bi=(h*r_0)/k "The coefficients lambda_1 and A_1 corresponding to the calculated Bi = 4 are obtained from
Table 4-2 of the text as"
lambda_1=2.4556
A_1=1.7202
Theta_0=(T_0-T_infinity)/(T_i-T_infinity)
V=pi*D^3/6
Q_max=n*rho*V*c_p*(T_infinity-T_i)
Q=Q_max*(1-3*Theta_0*(sin(lambda_1)-lambda_1*cos(lambda_1))/lambda_1^3)
"Some Wrong Solutions with Common Mistakes"
W1_Q=Q_max "Using Q_max as the result"
W2_Q=Q_max*(1-Theta_0*(sin(lambda_1))/lambda_1) "Using the relation for plane wall"
W3_Q_max=rho*V*c_p*(T_infinity-T_i)
W3_Q=W3_Q_max*(1-3*Theta_0*(sin(lambda_1)-lambda_1*cos(lambda_1))/lambda_1^3) "Not multiplying
with the number of potatoes"
```

4-144 A large chunk of tissue at 35°C with a thermal diffusivity of 1×10^{-7} m²/s is dropped into iced water. The water is well-stirred so that the surface temperature of the tissue drops to 0°C at time zero and remains at 0°C at all times. The temperature of the tissue after 4 minutes at a depth of 1 cm is

- (a) 5°C (b) 30°C (c) 25°C (d) 20°C (e) 10°C

Answer (a) 30°C

Solution Solved by EES Software. Solutions can be verified by copying-and-pasting the following lines on a blank EES screen.

```
X=0.01 [m]
Alpha=1E-7 [m^2/s]
Ti=35 [C]
Ts=0 [C]
time=4*60 [s]
a=0.5*x/sqrt(alpha*time)
b=erfc(a)
(T-Ti)/(Ts-Ti)=b
```

4-145 Consider a 7.6-cm-long and 3-cm-diameter cylindrical lamb meat chunk ($\rho = 1030 \text{ kg/m}^3$, $c_p = 3.49 \text{ kJ/kg}\cdot^\circ\text{C}$, $k = 0.456 \text{ W/m}\cdot^\circ\text{C}$, $\alpha = 1.3 \times 10^{-7} \text{ m}^2/\text{s}$). Such a meat chunk initially at 2°C is dropped into boiling water at 95°C with a heat transfer coefficient of $1200 \text{ W/m}^2\cdot^\circ\text{C}$. The time it takes for the center temperature of the meat chunk to rise to 75°C is

- (a) 136 min (b) 21.2 min (c) 13.6 min (d) 11.0 min (e) 8.5 min

Answer (d) 11.0 min

Solution Solved by EES Software. Solutions can be verified by copying-and-pasting the following lines on a blank EES screen.

```
2*L=0.076 [m]
D=0.03 [m]
rho=1030 [kg/m^3]
c_p=3490 [J/kg-C]
k=0.456 [W/m-C]
alpha=1.3E-7 [m^2/s]
T_i=2 [C]
T_infinity=95 [C]
h=1200 [W/m^2-C]
T_0=75 [C]
```

```
Bi_wall=(h*L)/k
lambda_1_wall=1.5552 "for Bi_wall = 100 from Table 4-2"
A_1_wall=1.2731
r_0=D/2
Bi_cyl=(h*r_0)/k
lambda_1_cyl=2.3455 "for Bi_cyl = 40 from Table 4-2"
A_1_cyl=1.5993
tau_wall=(alpha*t)/L^2
theta_wall=A_1_wall*exp(-lambda_1_wall^2*tau_wall)
tau_cyl=(alpha*t)/r_0^2
theta_cyl=A_1_cyl*exp(-lambda_1_cyl^2*tau_cyl)
theta=theta_wall*theta_cyl
theta=(T_0-T_infinity)/(T_i-T_infinity)
```

"Some Wrong Solutions with Common Mistakes"

```
tau_wall_w=(alpha*W1_t)/L^2
theta_wall_w=A_1_wall*exp(-lambda_1_wall^2*tau_wall_w)
theta_wall_w=(T_0-T_infinity)/(T_i-T_infinity) "Considering only large plane wall solution"
tau_cyl_w=(alpha*W2_t)/r_0^2
theta_cyl_w=A_1_cyl*exp(-lambda_1_cyl^2*tau_cyl_w)
theta_cyl_w=(T_0-T_infinity)/(T_i-T_infinity) "Considering only long cylinder solution"
```

4-146 Consider a 7.6-cm-long and 3-cm-diameter cylindrical lamb meat chunk ($\rho = 1030 \text{ kg/m}^3$, $c_p = 3.49 \text{ kJ/kg}\cdot^\circ\text{C}$, $k = 0.456 \text{ W/m}\cdot^\circ\text{C}$, $\alpha = 1.3 \times 10^{-7} \text{ m}^2/\text{s}$). Such a meat chunk initially at 2°C is dropped into boiling water at 95°C with a heat transfer coefficient of $1200 \text{ W/m}^2\cdot^\circ\text{C}$. The amount of heat transfer during the first 8 minutes of cooking is

- (a) 71 kJ (b) 227 kJ (c) 238 kJ (d) 269 kJ (e) 307 kJ

Answer (c) 269 kJ

Solution Solved by EES Software. Solutions can be verified by copying-and-pasting the following lines on a blank EES screen.

```

2*L=0.076 [m]
D=0.03 [m]
n=15
rho=1030 [kg/m^3]
c_p=3490 [J/kg-C]
k=0.456 [W/m-C]
alpha=1.3E-7 [m^2/s]
T_i=2 [C]
T_infinity=95 [C]
h=1200 [W/m^2-C]
t=8*60 [s]

Bi_wall=(h*L)/k
lambda_1_wall=1.5552 "for Bi_wall = 100 from Table 4-2"
A_1_wall=1.2731
tau_wall=(alpha*t)/L^2
theta_wall=A_1_wall*exp(-lambda_1_wall^2*tau_wall)
Q\Q_max_wall=1-theta_wall*sin(lambda_1_wall)/lambda_1_wall

r_0=D/2
Bi_cyl=(h*r_0)/k
lambda_1_cyl=2.3455 "for Bi_cyl = 40 from Table 4-2"
A_1_cyl=1.5993
tau_cyl=(alpha*t)/r_0^2
theta_cyl=A_1_cyl*exp(-lambda_1_cyl^2*tau_cyl)
J_1=0.5309 "For xi = lambda_a_cyl = 2.3455 from Table 4-2"

Q\Q_max_cyl=1-2*theta_cyl*J_1/lambda_1_cyl
V=pi*D^2/4*(2*L)
Q_max=n*rho*V*c_p*(T_infinity-T_i)
Q\Q_max=Q\Q_max_wall+Q\Q_max_cyl*(1-Q\Q_max_wall)
Q=Q_max*Q\Q_max

```

"Some Wrong Solutions with Common Mistakes"

```

W1_Q=Q_max "Using Q_max as the result"
W2_Q=Q_max*Q\Q_max_wall "Considering large plane wall only"
W3_Q=Q_max*Q\Q_max_cyl "Considering long cylinder only"

```

4-147 Carbon steel balls ($\rho = 7830 \text{ kg/m}^3$, $k = 64 \text{ W/m}\cdot\text{C}$, $c_p = 434 \text{ J/kg}\cdot\text{C}$) initially at 150°C are quenched in an oil bath at 20°C for a period of 3 minutes. If the balls have a diameter of 5 cm and the convection heat transfer coefficient is $450 \text{ W/m}^2\cdot\text{C}$, the center temperature of the balls after quenching will be (Hint: Check the Biot number).

- (a) 27.4°C (b) 143°C (c) 12.7°C (d) 48.2°C (e) 76.9°C

Answer (a) 27.4°C

Solution Solved by EES Software. Solutions can be verified by copying-and-pasting the following lines on a blank EES screen.

```
D=0.05 [m]
Cp=434 [J/kg-K]
rho= 7830 [kg/m^3]
k=64 [W/m-K]
V=pi*D^3/6
A=pi*D^2
m=rho*V
h=450 [W/m^2-C]
Ti=150 [C]
Tinf=20 [C]
b=h*A/(rho*V*Cp)
time=3*60 [s]
Bi=h*(V/A)/k
```

"Applying the lumped system analysis equation:"

$$(T-T_{\text{inf}})/(T_i-T_{\text{inf}})=\exp(-b*\text{time})$$

"Some Wrong Solutions with Common Mistakes:"

$$(W1_T-0)/(T_i-0)=\exp(-b*\text{time}) \text{ "Tinf is ignored"}$$

$$(-W2_T+T_{\text{inf}})/(T_i-T_{\text{inf}})=\exp(-b*\text{time}) \text{ "Sign error"}$$

$$(W3_T-T_i)/(T_{\text{inf}}-T_i)=\exp(-b*\text{time}) \text{ "Switching } T_i \text{ and } T_{\text{inf}}"$$

$$(W4_T-T_{\text{inf}})/(T_i-T_{\text{inf}})=\exp(-b*\text{time}/60) \text{ "Using minutes instead of seconds"}$$

7-148 A 6-cm-diameter 13-cm-high canned drink ($\rho = 977 \text{ kg/m}^3$, $k = 0.607 \text{ W/m}\cdot\text{C}$, $c_p = 4180 \text{ J/kg}\cdot\text{C}$) initially at 25°C is to be cooled to 5°C by dropping it into iced water at 0°C . Total surface area and volume of the drink are $A_s = 301.6 \text{ cm}^2$ and $V = 367.6 \text{ cm}^3$. If the heat transfer coefficient is $120 \text{ W/m}^2\cdot\text{C}$, determine how long it will take for the drink to cool to 5°C . Assume the can is agitated in water and thus the temperature of the drink changes uniformly with time.

- (a) 1.5 min (b) 8.7 min (c) 11.1 min (d) 26.6 min (e) 6.7 min

Answer (c) 11.1 min

Solution Solved by EES Software. Solutions can be verified by copying-and-pasting the following lines on a blank EES screen.

```
D=0.06 [m]
L=0.13 [m]
Cp=4180 [J/kg-K]
rho= 977 [kg/m^3]
k=0.607 [W/m-K]
V=pi*L*D^2/4
A=2*pi*D^2/4+pi*D*L
m=rho*V
h=120 [W/m^2-C]
Ti=25 [C]
Tinf=0 [C]
T=5 [C]
b=h*A/(rho*V*Cp)
```

"Lumped system analysis is applicable. Applying the lumped system analysis equation:"

```
(T-Tinf)/(Ti-Tinf)=exp(-b*time)
t_min=time/60
```

"Some Wrong Solutions with Common Mistakes:"

```
(T-0)/(Ti-0)=exp(-b*W1_time); W1_t=W1_time/60 "Tinf is ignored"
(T-Tinf)/(Ti-Tinf)=exp(-b*W2_time); W2_t=W2_time/60 "Sign error"
(T-Ti)/(Tinf-Ti)=exp(-b*W3_time); W3_t=W3_time/60 "Switching Ti and Tinf"
(T-Tinf)/(Ti-Tinf)=exp(-b*W4_time) "Using seconds instead of minutes"
```

4-149 Lumped system analysis of transient heat conduction situations is valid when the Biot number is

- (a) very small (b) approximately one (c) very large
(d) any real number (e) cannot say unless the Fourier number is also known.

Answer (a) very small

4-150 Polyvinylchloride automotive body panels ($k = 0.092 \text{ W/m}\cdot\text{K}$, $c_p = 1.05 \text{ kJ/kg}\cdot\text{K}$, $\rho = 1714 \text{ kg/m}^3$), 3-mm thick, emerge from an injection molder at 120°C . They need to be cooled to 40°C by exposing both sides of the panels to 20°C air before they can be handled. If the convective heat transfer coefficient is $30 \text{ W/m}^2\cdot\text{K}$ and radiation is not considered, the time that the panels must be exposed to air before they can be handled is

- (a) 1.6 min (b) 2.4 min (c) 2.8 min (d) 3.5 min (e) 4.2 min

Answer (b) 2.4 min

Solution Solved by EES Software. Solutions can be verified by copying-and-pasting the following lines on a blank EES screen.

```
T=40 [C]
Ti=120 [C]
Ta=20 [C]
r=1714 [kg/m^3]
k=0.092 [W/m-K]
c=1050 [J/kg-K]
h=30 [W/m^2-K]
L=0.003 [m]
Lc=L/2
b=h/(r*c*Lc)
(T-Ta)/(Ti-Ta)=exp(-b*time)
```

4-151 A steel casting cools to 90 percent of the original temperature difference in 30 min in still air. The time it takes to cool this same casting to 90 percent of the original temperature difference in a moving air stream whose convective heat transfer coefficient is 5 times that of still air is

- (a) 3 min (b) 6 min (c) 9 min (d) 12 min (e) 15 min

Answer (b) 6 min

Solution Solved by EES Software. Solutions can be verified by copying-and-pasting the following lines on a blank EES screen.

```
t1=30 [min]
per=0.9
a=ln(per)/t1
t2=ln(per)/(5*a)
```

4-152 The Biot number can be thought of as the ratio of

- (a) the conduction thermal resistance to the convective thermal resistance
 (b) the convective thermal resistance to the conduction thermal resistance
 (c) the thermal energy storage capacity to the conduction thermal resistance
 (d) the thermal energy storage capacity to the convection thermal resistance
 (e) None of the above

Answer (a)

4-153 When water, as in a pond or lake, is heated by warm air above it, it remains stable, does not move, and forms a warm layer of water on top of a cold layer. Consider a deep lake ($k = 0.6 \text{ W/m}\cdot\text{K}$, $c_p = 4.179 \text{ kJ/kg}\cdot\text{K}$) that is initially at a uniform temperature of 2°C and has its surface temperature suddenly increased to 20°C by a spring weather front. The temperature of the water 1 m below the surface 400 hours after this change is

- (a) 2.1°C (b) 4.2°C (c) 6.3°C (d) 8.4°C (e) 10.2°C

Answer (b) 4.2°C

Solution Solved by EES Software. Solutions can be verified by copying-and-pasting the following lines on a blank EES screen.

```
k=0.6 [W/m-C]
c=4179 [J/kg-C]
rho=1000 [kg/m^3]
T_i=2 [C]
T_s=20 [C]
x=1 [m]
time=400*3600 [s]
alpha=k/(rho*c)
xi=x/(2*sqrt(alpha*time))
(T-T_i)/(T_s-T_i)=erfc(xi)
```

4-154 The 40-cm-thick roof of a large room made of concrete ($k = 0.79 \text{ W/m}\cdot^\circ\text{C}$, $\alpha = 5.88 \times 10^{-7} \text{ m}^2/\text{s}$) is initially at a uniform temperature of 15°C . After a heavy snow storm, the outer surface of the roof remains covered with snow at -5°C . The roof temperature at 18.2 cm distance from the outer surface after a period of 2 hours is

- (a) 14.0°C (b) 12.5°C (c) 7.8°C (d) 0°C (e) -5.0°C

Answer (a) 14.0°C

Solution Solved by EES Software. Solutions can be verified by copying-and-pasting the following lines on a blank EES screen.

```
Thickness=0.40 [m]
k=0.79 [W/m-C]
alpha=5.88E-7 [m^2/s]
T_i=15 [C]
T_s=-5 [C]
x=0.182 [m]
time=2*3600 [s]
xi=x/(2*sqrt(alpha*time))
(T-T_i)/(T_s-T_i)=erfc(xi)
```

4-155 ... 4-158 Design and Essay Problems



Chapter 5

NUMERICAL METHODS IN HEAT CONDUCTION

Why Numerical Methods

5-1C Analytical solution methods are limited to *highly simplified problems in simple geometries*. The geometry must be such that its entire surface can be described mathematically in a coordinate system by setting the variables equal to constants. Also, heat transfer problems can not be solved analytically if the *thermal conditions* are not sufficiently simple. For example, the consideration of the variation of thermal conductivity with temperature, the variation of the heat transfer coefficient over the surface, or the radiation heat transfer on the surfaces can make it impossible to obtain an analytical solution. Therefore, analytical solutions are limited to problems that are simple or can be simplified with reasonable approximations.

5-2C The *analytical solutions* are based on (1) driving the governing differential equation by performing an energy balance on a differential volume element, (2) expressing the boundary conditions in the proper mathematical form, and (3) solving the differential equation and applying the boundary conditions to determine the integration constants. The *numerical solution* methods are based on replacing the *differential equations* by *algebraic equations*. In the case of the popular *finite difference* method, this is done by replacing the *derivatives* by *differences*. The analytical methods are simple and they provide solution functions applicable to the entire medium, but they are limited to simple problems in simple geometries. The numerical methods are usually more involved and the solutions are obtained at a number of points, but they are applicable to any geometry subjected to any kind of thermal conditions.

5-3C The *energy balance method* is based on *subdividing* the medium into a sufficient number of volume elements, and then applying an *energy balance* on each element. The formal *finite difference method* is based on replacing derivatives by their finite difference approximations. For a specified nodal network, these two methods will result in the same set of equations.

5-4C In practice, we are most likely to use a software package to solve heat transfer problems even when analytical solutions are available since we can do parametric studies very easily and present the results graphically by the press of a button. Besides, once a person is used to solving problems numerically, it is very difficult to go back to solving differential equations by hand.

5-5C The experiments will most likely prove engineer B right since an approximate solution of a more realistic model is more accurate than the exact solution of a crude model of an actual problem.

Finite Difference Formulation of Differential Equations

5-6C A point at which the finite difference formulation of a problem is obtained is called a *node*, and all the nodes for a problem constitute the *nodal network*. The region about a node whose properties are represented by the property values at the nodal point is called the *volume element*. The distance between two consecutive nodes is called the *nodal spacing*, and a differential equation whose derivatives are replaced by differences is called a *difference equation*.

5-7 We consider three consecutive nodes $n-1$, n , and $n+1$ in a plain wall. Using Eq. 5-6, the first derivative of temperature dT/dx at the midpoints $n-1/2$ and $n+1/2$ of the sections surrounding the node n can be expressed as

$$\left. \frac{dT}{dx} \right|_{n-\frac{1}{2}} \cong \frac{T_n - T_{n-1}}{\Delta x} \quad \text{and} \quad \left. \frac{dT}{dx} \right|_{n+\frac{1}{2}} \cong \frac{T_{n+1} - T_n}{\Delta x}$$

Noting that second derivative is simply the derivative of the first derivative, the second derivative of temperature at node n can be expressed as

$$\begin{aligned} \left. \frac{d^2T}{dx^2} \right|_n &\cong \frac{\left. \frac{dT}{dx} \right|_{n+\frac{1}{2}} - \left. \frac{dT}{dx} \right|_{n-\frac{1}{2}}}{\Delta x} \\ &= \frac{\frac{T_{n+1} - T_n}{\Delta x} - \frac{T_n - T_{n-1}}{\Delta x}}{\Delta x} = \frac{T_{n-1} - 2T_n + T_{n+1}}{\Delta x^2} \end{aligned}$$

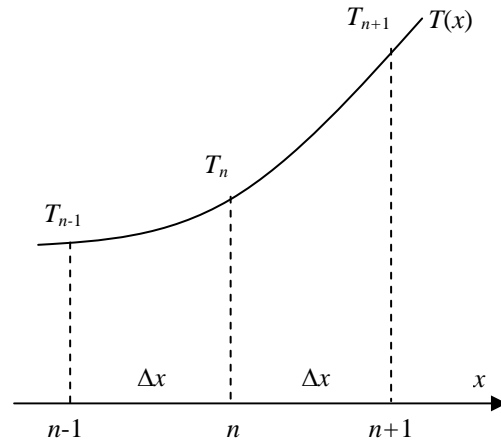

which is the *finite difference representation* of the *second derivative* at a general internal node n . Note that the second derivative of temperature at a node n is expressed in terms of the temperatures at node n and its two neighboring nodes

5-8 The finite difference formulation of steady two-dimensional heat conduction in a medium with heat generation and constant thermal conductivity is given by

$$\frac{T_{m-1,n} - 2T_{m,n} + T_{m+1,n}}{\Delta x^2} + \frac{T_{m,n-1} - 2T_{m,n} + T_{m,n+1}}{\Delta y^2} + \frac{\dot{e}_{m,n}}{k} = 0$$

in rectangular coordinates. This relation can be modified for the three-dimensional case by simply adding another index j to the temperature in the z direction, and another difference term for the z direction as

$$\frac{T_{m-1,n,j} - 2T_{m,n,j} + T_{m+1,n,j}}{\Delta x^2} + \frac{T_{m,n-1,j} - 2T_{m,n,j} + T_{m,n+1,j}}{\Delta y^2} + \frac{T_{m,n,j-1} - 2T_{m,n,j} + T_{m,n,j+1}}{\Delta z^2} + \frac{\dot{e}_{m,n,j}}{k} = 0$$

5-9 A plane wall with variable heat generation and constant thermal conductivity is subjected to uniform heat flux \dot{q}_0 at the left (node 0) and convection at the right boundary (node 4). Using the finite difference form of the 1st derivative, the finite difference formulation of the boundary nodes is to be determined.

Assumptions 1 Heat transfer through the wall is steady since there is no indication of change with time. 2 Heat transfer is one-dimensional since the plate is large relative to its thickness. 3 Thermal conductivity is constant and there is nonuniform heat generation in the medium. 4 Radiation heat transfer is negligible.

Analysis The boundary conditions at the left and right boundaries can be expressed analytically as

$$\begin{aligned} \text{at } x = 0: \quad & -k \frac{dT(0)}{dx} = q_0 \\ \text{at } x = L: \quad & -k \frac{dT(L)}{dx} = h[T(L) - T_\infty] \end{aligned}$$

Replacing derivatives by differences using values at the closest nodes, the finite difference form of the 1st derivative of temperature at the boundaries (nodes 0 and 4) can be expressed as

$$\left. \frac{dT}{dx} \right|_{\text{left}, m=0} \cong \frac{T_1 - T_0}{\Delta x} \quad \text{and} \quad \left. \frac{dT}{dx} \right|_{\text{right}, m=4} \cong \frac{T_4 - T_3}{\Delta x}$$

Substituting, the finite difference formulation of the boundary nodes become

$$\begin{aligned} \text{at } x = 0: \quad & -k \frac{T_1 - T_0}{\Delta x} = q_0 \\ \text{at } x = L: \quad & -k \frac{T_4 - T_3}{\Delta x} = h[T_4 - T_\infty] \end{aligned}$$

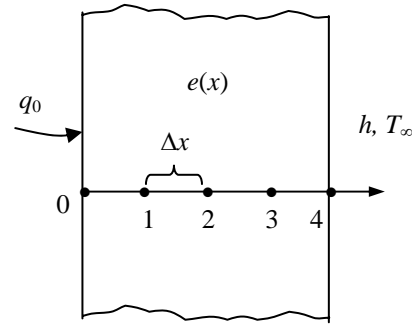

5-10 A plane wall with variable heat generation and constant thermal conductivity is subjected to insulation at the left (node 0) and radiation at the right boundary (node 5). Using the finite difference form of the 1st derivative, the finite difference formulation of the boundary nodes is to be determined.

Assumptions 1 Heat transfer through the wall is steady since there is no indication of change with time. 2 Heat transfer is one-dimensional since the plate is large relative to its thickness. 3 Thermal conductivity is constant and there is nonuniform heat generation in the medium. 4 Convection heat transfer is negligible.

Analysis The boundary conditions at the left and right boundaries can be expressed analytically as

$$\begin{aligned} \text{At } x = 0: \quad & -k \frac{dT(0)}{dx} = 0 \quad \text{or} \quad \frac{dT(0)}{dx} = 0 \\ \text{At } x = L: \quad & -k \frac{dT(L)}{dx} = \varepsilon \sigma [T^4(L) - T_{surr}^4] \end{aligned}$$

Replacing derivatives by differences using values at the closest nodes, the finite difference form of the 1st derivative of temperature at the boundaries (nodes 0 and 5) can be expressed as

$$\left. \frac{dT}{dx} \right|_{\text{left}, m=0} \cong \frac{T_1 - T_0}{\Delta x} \quad \text{and} \quad \left. \frac{dT}{dx} \right|_{\text{right}, m=5} \cong \frac{T_5 - T_4}{\Delta x}$$

Substituting, the finite difference formulation of the boundary nodes become

$$\begin{aligned} \text{At } x = 0: \quad & -k \frac{T_1 - T_0}{\Delta x} = 0 \quad \text{or} \quad T_1 = T_0 \\ \text{At } x = L: \quad & -k \frac{T_5 - T_4}{\Delta x} = \varepsilon \sigma [T_5^4 - T_{surr}^4] \end{aligned}$$

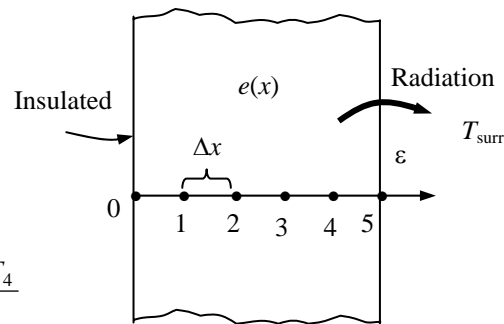

One-Dimensional Steady Heat Conduction

5-11C The finite difference form of a heat conduction problem by the *energy balance method* is obtained by *subdividing* the medium into a sufficient number of volume elements, and then applying an *energy balance* on each element. This is done by first *selecting* the nodal points (or nodes) at which the temperatures are to be determined, and then *forming elements* (or control volumes) over the nodes by drawing lines through the midpoints between the nodes. The properties *at the node* such as the temperature and the rate of heat generation represent the *average* properties of the element. The temperature is assumed to vary *linearly* between the nodes, especially when expressing heat conduction between the elements using Fourier's law.

5-12C In the energy balance formulation of the finite difference method, it is recommended that all heat transfer at the boundaries of the volume element be assumed to be *into* the volume element even for steady heat conduction. This is a valid recommendation even though it seems to violate the conservation of energy principle since the assumed direction of heat conduction at the surfaces of the volume elements has no effect on the formulation, and some heat conduction terms turn out to be negative.

5-13C In the finite difference formulation of a problem, an insulated boundary is best handled by replacing the insulation by a mirror, and treating the node on the boundary as an *interior* node. Also, a thermal symmetry line and an insulated boundary are treated the same way in the finite difference formulation.

5-14C A node on an insulated boundary can be treated as an interior node in the finite difference formulation of a plane wall by replacing the insulation on the boundary by a *mirror*, and considering the reflection of the medium as its extension. This way the node next to the boundary node appears on both sides of the boundary node because of symmetry, converting it into an interior node.

5-15C In a medium in which the finite difference formulation of a general interior node is given in its simplest form as

$$\frac{T_{m-1} - 2T_m + T_{m+1}}{\Delta x^2} + \frac{\dot{e}_m}{k} = 0$$

(a) heat transfer in this medium is **steady**, (b) it is **one-dimensional**, (c) there **is** heat generation, (d) the nodal spacing is **constant**, and (e) the thermal conductivity is **constant**.

5-16 A plane wall with no heat generation is subjected to specified temperature at the left (node 0) and heat flux at the right boundary (node 8). The finite difference formulation of the boundary nodes and the finite difference formulation for the rate of heat transfer at the left boundary are to be determined.

Assumptions 1 Heat transfer through the wall is given to be steady, and the thermal conductivity to be constant. **2** Heat transfer is one-dimensional since the plate is large relative to its thickness. **3** There is no heat generation in the medium.

Analysis Using the energy balance approach and taking the direction of all heat transfers to be towards the node under consideration, the finite difference formulations become

Left boundary node: $T_0 = 30$

Right boundary node:

$$kA \frac{T_7 - T_8}{\Delta x} + \dot{q}_0 A = 0 \quad \text{or} \quad k \frac{T_7 - T_8}{\Delta x} + 1200 = 0$$

Heat transfer at left surface: $\dot{Q}_{\text{left surface}} + kA \frac{T_1 - T_0}{\Delta x} = 0$

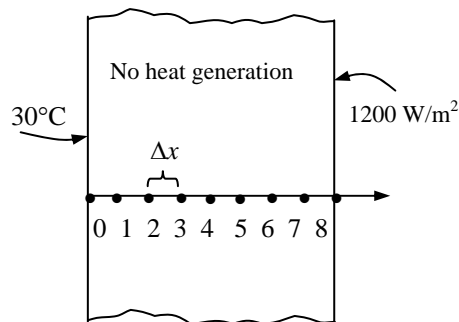

5-17 A plane wall with variable heat generation and constant thermal conductivity is subjected to uniform heat flux \dot{q}_0 at the left (node 0) and convection at the right boundary (node 4). The finite difference formulation of the boundary nodes is to be determined.

Assumptions 1 Heat transfer through the wall is given to be steady, and the thermal conductivity to be constant. **2** Heat transfer is one-dimensional since the plate is large relative to its thickness. **3** Radiation heat transfer is negligible.

Analysis Using the energy balance approach and taking the direction of all heat transfers to be towards the node under consideration, the finite difference formulations become

$$\text{Left boundary node: } \dot{q}_0 A + kA \frac{T_1 - T_0}{\Delta x} + \dot{e}_0 (A\Delta x / 2) = 0$$

$$\text{Right boundary node: } kA \frac{T_3 - T_4}{\Delta x} + hA(T_\infty - T_4) + \dot{e}_4 (A\Delta x / 2) = 0$$

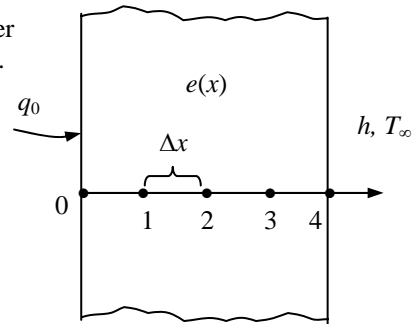

5-18 A plane wall with variable heat generation and constant thermal conductivity is subjected to insulation at the left (node 0) and radiation at the right boundary (node 5). The finite difference formulation of the boundary nodes is to be determined.

Assumptions 1 Heat transfer through the wall is given to be steady and one-dimensional, and the thermal conductivity to be constant. **2** Convection heat transfer is negligible.

Analysis Using the energy balance approach and taking the direction of all heat transfers to be towards the node under consideration, the finite difference formulations become

$$\text{Left boundary node: } kA \frac{T_1 - T_0}{\Delta x} + \dot{e}_0 (A\Delta x / 2) = 0$$

$$\text{Right boundary node: } \varepsilon \sigma A (T_{\text{surr}}^4 - T_5^4) + kA \frac{T_4 - T_5}{\Delta x} + \dot{e}_5 (A\Delta x / 2) = 0$$

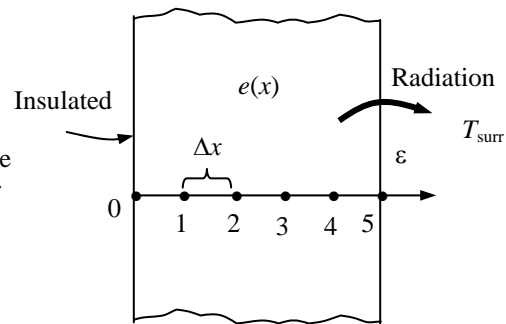

5-19 A plane wall with variable heat generation and constant thermal conductivity is subjected to combined convection, radiation, and heat flux at the left (node 0) and specified temperature at the right boundary (node 5). The finite difference formulation of the left boundary node (node 0) and the finite difference formulation for the rate of heat transfer at the right boundary (node 5) are to be determined.

Assumptions 1 Heat transfer through the wall is given to be steady and one-dimensional. **2** The thermal conductivity is given to be constant.

Analysis Using the energy balance approach and taking the direction of all heat transfers to be towards the node under consideration, the finite difference formulations become

Left boundary node (all temperatures are in K):

$$\varepsilon\sigma A(T_{\text{surr}}^4 - T_0^4) + hA(T_\infty - T_0) + kA\frac{T_1 - T_0}{\Delta x} + \dot{q}_0 A + \dot{e}_0(A\Delta x/2) = 0$$

$$\text{Heat transfer at right surface: } \dot{Q}_{\text{right surface}} + kA\frac{T_4 - T_5}{\Delta x} + \dot{e}_5(A\Delta x/2) = 0$$

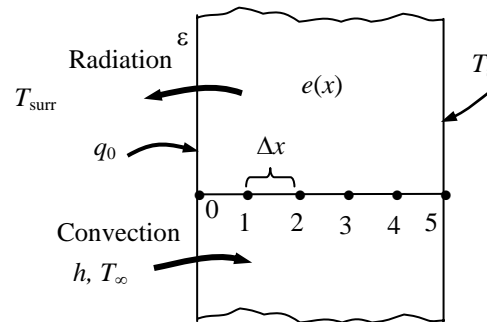

5-20 A composite plane wall consists of two layers A and B in perfect contact at the interface where node 1 is. The wall is insulated at the left (node 0) and subjected to radiation at the right boundary (node 2). The complete finite difference formulation of this problem is to be obtained.

Assumptions 1 Heat transfer through the wall is given to be steady and one-dimensional, and the thermal conductivity to be constant. **2** Convection heat transfer is negligible. **3** There is no heat generation.

Analysis Using the energy balance approach and taking the direction of all heat transfers to be towards the node under consideration, the finite difference formulations become

$$\text{Node 0 (at left boundary): } k_A A \frac{T_1 - T_0}{\Delta x} = 0 \rightarrow T_1 = T_0$$

$$\text{Node 1 (at the interface): } k_A A \frac{T_0 - T_1}{\Delta x} + k_B A \frac{T_2 - T_1}{\Delta x} = 0$$

$$\text{Node 2 (at right boundary): } \varepsilon\sigma A(T_{\text{surr}}^4 - T_2^4) + k_B A \frac{T_1 - T_2}{\Delta x} = 0$$

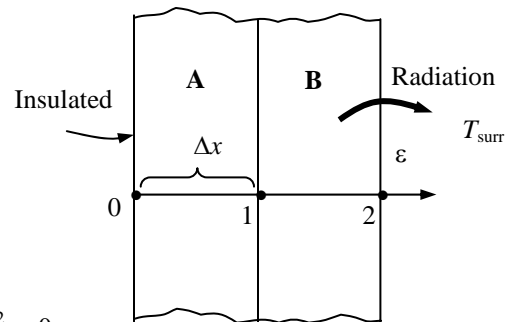

5-21 A plane wall with variable heat generation and variable thermal conductivity is subjected to specified heat flux \dot{q}_0 and convection at the left boundary (node 0) and radiation at the right boundary (node 5). The complete finite difference formulation of this problem is to be obtained.

Assumptions 1 Heat transfer through the wall is given to be steady and one-dimensional, and the thermal conductivity and heat generation to be variable. **2** Convection heat transfer at the right surface is negligible.

Analysis Using the energy balance approach and taking the direction of all heat transfers to be towards the node under consideration, the finite difference formulations become

Node 0 (at left boundary):

$$\dot{q}_0 A + hA(T_\infty - T_0) + k_0 A \frac{T_1 - T_0}{\Delta x} + \dot{e}_0 (A\Delta x / 2) = 0$$

Node 1 (at the mid plane):
$$k_1 A \frac{T_0 - T_1}{\Delta x} + k_1 A \frac{T_2 - T_1}{\Delta x} + \dot{e}_1 (A\Delta x) = 0$$

Node 2 (at right boundary):
$$\varepsilon \sigma A (T_{\text{surr}}^4 - T_2^4) + k_2 A \frac{T_1 - T_2}{\Delta x} + \dot{e}_2 (A\Delta x / 2) = 0$$

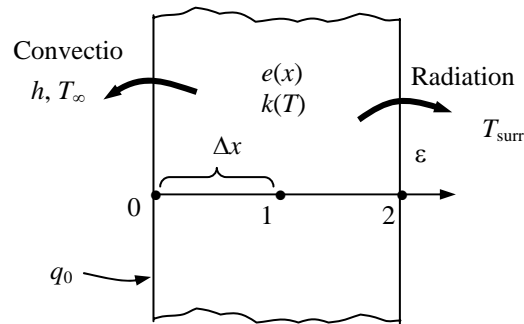

5-22 A pin fin with negligible heat transfer from its tip is considered. The complete finite difference formulation for the determination of nodal temperatures is to be obtained.

Assumptions 1 Heat transfer through the pin fin is given to be steady and one-dimensional, and the thermal conductivity to be constant. **2** Convection heat transfer coefficient is constant and uniform. **3** Radiation heat transfer is negligible. **4** Heat loss from the fin tip is given to be negligible.

Analysis The nodal network consists of 3 nodes, and the base temperature T_0 at node 0 is specified. Therefore, there are two unknowns T_1 and T_2 , and we need two equations to determine them. Using the energy balance approach and taking the direction of all heat transfers to be towards the node under consideration, the finite difference formulations become

Node 1 (at midpoint):
$$kA \frac{T_0 - T_1}{\Delta x} + kA \frac{T_2 - T_1}{\Delta x} + hp\Delta x(T_\infty - T_1) = 0$$

Node 2 (at fin tip):
$$kA \frac{T_1 - T_2}{\Delta x} + h(p\Delta x / 2)(T_\infty - T_2) = 0$$

where $A = \pi D^2 / 4$ is the cross-sectional area and $p = \pi D$ is the perimeter of the fin.

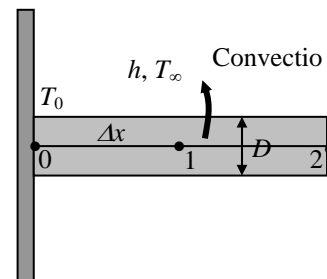

5-23 A pin fin with negligible heat transfer from its tip is considered. The complete finite difference formulation for the determination of nodal temperatures is to be obtained.

Assumptions 1 Heat transfer through the pin fin is given to be steady and one-dimensional, and the thermal conductivity to be constant. **2** Convection heat transfer coefficient is constant and uniform. **3** Heat loss from the fin tip is given to be negligible.

Analysis The nodal network consists of 3 nodes, and the base temperature T_0 at node 0 is specified. Therefore, there are two unknowns T_1 and T_2 , and we need two equations to determine them. Using the energy balance approach and taking the direction of all heat transfers to be towards the node under consideration, the finite difference formulations become

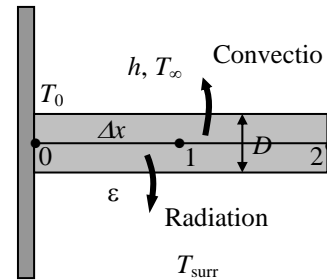

Node 1 (at midpoint):

$$kA \frac{T_0 - T_1}{\Delta x} + kA \frac{T_2 - T_1}{\Delta x} + h(p\Delta x)(T_\infty - T_1) + \varepsilon\sigma(p\Delta x)\left[(T_{\text{surr}} + 273)^4 - (T_1 + 273)^4\right] = 0$$

Node 2 (at fin tip):

$$kA \frac{T_1 - T_2}{\Delta x} + h(p\Delta x/2)(T_\infty - T_2) + \varepsilon\sigma(p\Delta x/2)\left[(T_{\text{surr}} + 273)^4 - (T_2 + 273)^4\right] = 0$$

where $A = \pi D^2 / 4$ is the cross-sectional area and $p = \pi D$ is the perimeter of the fin.

5-24 A uranium plate is subjected to insulation on one side and convection on the other. The finite difference formulation of this problem is to be obtained, and the nodal temperatures under steady conditions are to be determined.

Assumptions 1 Heat transfer through the wall is steady since there is no indication of change with time. **2** Heat transfer is one-dimensional since the plate is large relative to its thickness. **3** Thermal conductivity is constant. **4** Radiation heat transfer is negligible.

Properties The thermal conductivity is given to be $k = 28 \text{ W/m}\cdot^\circ\text{C}$.

Analysis The number of nodes is specified to be $M = 6$. Then the nodal spacing Δx becomes

$$\Delta x = \frac{L}{M-1} = \frac{0.05 \text{ m}}{6-1} = 0.01 \text{ m}$$

This problem involves 6 unknown nodal temperatures, and thus we need to have 6 equations to determine them uniquely. Node 0 is on insulated boundary, and thus we can treat it as an interior node by using the mirror image concept. Nodes 1, 2, 3, and 4 are interior nodes, and thus for them we can use the general finite difference relation expressed as

$$\frac{T_{m-1} - 2T_m + T_{m+1}}{\Delta x^2} + \frac{\dot{e}_m}{k} = 0, \quad \text{for } m = 0, 1, 2, 3, \text{ and } 4$$

Finally, the finite difference equation for node 5 on the right surface subjected to convection is obtained by applying an energy balance on the half volume element about node 5 and taking the direction of all heat transfers to be towards the node under consideration:

$$\text{Node 0 (Left surface - insulated): } \frac{T_1 - 2T_0 + T_1}{\Delta x^2} + \frac{\dot{e}}{k} = 0$$

$$\text{Node 1 (interior): } \frac{T_0 - 2T_1 + T_2}{\Delta x^2} + \frac{\dot{e}}{k} = 0$$

$$\text{Node 2 (interior): } \frac{T_1 - 2T_2 + T_3}{\Delta x^2} + \frac{\dot{e}}{k} = 0$$

$$\text{Node 3 (interior): } \frac{T_2 - 2T_3 + T_4}{\Delta x^2} + \frac{\dot{e}}{k} = 0$$

$$\text{Node 4 (interior): } \frac{T_3 - 2T_4 + T_5}{\Delta x^2} + \frac{\dot{e}}{k} = 0$$

$$\text{Node 5 (right surface - convection): } h(T_\infty - T_5) + k \frac{T_4 - T_5}{\Delta x} + \dot{e}(\Delta x/2) = 0$$

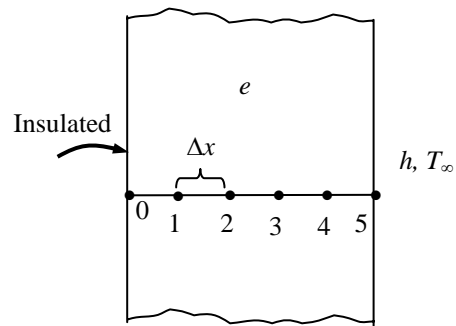

where $\Delta x = 0.01 \text{ m}$, $\dot{e} = 6 \times 10^5 \text{ W/m}^3$, $k = 28 \text{ W/m}\cdot^\circ\text{C}$, $h = 60 \text{ W/m}^2 \cdot^\circ\text{C}$, and $T_\infty = 30^\circ\text{C}$. This system of 6 equations with six unknown temperatures constitute the finite difference formulation of the problem.

(b) The 6 nodal temperatures under steady conditions are determined by solving the 6 equations above simultaneously with an equation solver to be

$$T_0 = 556.8^\circ\text{C}, \quad T_1 = 555.7^\circ\text{C}, \quad T_2 = 552.5^\circ\text{C}, \quad T_3 = 547.1^\circ\text{C}, \quad T_4 = 539.6^\circ\text{C}, \quad \text{and } T_5 = 530.0^\circ\text{C}$$

Discussion This problem can be solved analytically by solving the differential equation as described in Chap. 2, and the analytical (exact) solution can be used to check the accuracy of the numerical solution above.

5-25 A long triangular fin attached to a surface is considered. The nodal temperatures, the rate of heat transfer, and the fin efficiency are to be determined numerically using 6 equally spaced nodes.

Assumptions 1 Heat transfer along the fin is given to be steady, and the temperature along the fin to vary in the x direction only so that $T = T(x)$. **2** Thermal conductivity is constant.

Properties The thermal conductivity is given to be $k = 180 \text{ W/m}\cdot^\circ\text{C}$. The emissivity of the fin surface is 0.9.

Analysis The fin length is given to be $L = 5 \text{ cm}$, and the number of nodes is specified to be $M = 6$. Therefore, the nodal spacing Δx is

$$\Delta x = \frac{L}{M-1} = \frac{0.05 \text{ m}}{6-1} = 0.01 \text{ m}$$

The temperature at node 0 is given to be $T_0 = 200^\circ\text{C}$, and the temperatures at the remaining 5 nodes are to be determined. Therefore, we need to have 5 equations to determine them uniquely. Nodes 1, 2, 3, and 4 are interior nodes, and the finite difference formulation for a *general interior node* m is obtained by applying an energy balance on the volume element of this node. Noting that heat transfer is steady and there is no heat generation in the fin and assuming heat transfer to be into the medium from all sides, the energy balance can be expressed as

$$\sum_{\text{all sides}} \dot{Q} = 0 \rightarrow kA_{\text{left}} \frac{T_{m-1} - T_m}{\Delta x} + kA_{\text{right}} \frac{T_{m+1} - T_m}{\Delta x} + hA_{\text{conv}}(T_\infty - T_m) + \varepsilon\sigma A_{\text{surface}}[T_{\text{surr}}^4 - (T_m + 273)^4] = 0$$

Note that heat transfer areas are different for each node in this case, and using geometrical relations, they can be expressed as

$$A_{\text{left}} = (\text{Height} \times \text{width})_{@m-1/2} = 2w[L - (m-1/2)\Delta x] \tan \theta$$

$$A_{\text{right}} = (\text{Height} \times \text{width})_{@m+1/2} = 2w[L - (m+1/2)\Delta x] \tan \theta$$

$$A_{\text{surface}} = 2 \times \text{Length} \times \text{width} = 2w(\Delta x / \cos \theta)$$

Substituting,

$$2kw[L - (m-0.5)\Delta x] \tan \theta \frac{T_{m-1} - T_m}{\Delta x} + 2kw[L - (m+0.5)\Delta x] \tan \theta \frac{T_{m+1} - T_m}{\Delta x} + 2w(\Delta x / \cos \theta) \{h(T_\infty - T_m) + \varepsilon\sigma[T_{\text{surr}}^4 - (T_m + 273)^4]\} = 0$$

Dividing each term by $2kwL \tan \theta / \Delta x$ gives

$$\left[1 - (m-1/2)\frac{\Delta x}{L}\right](T_{m-1} - T_m) + \left[1 - (m+1/2)\frac{\Delta x}{L}\right](T_{m+1} - T_m) + \frac{h(\Delta x)^2}{kL \sin \theta}(T_\infty - T_m) + \frac{\varepsilon\sigma(\Delta x)^2}{kL \sin \theta}[T_{\text{surr}}^4 - (T_m + 273)^4] = 0$$

Substituting,

$$m = 1: \quad \left[1 - 0.5\frac{\Delta x}{L}\right](T_0 - T_1) + \left[1 - 1.5\frac{\Delta x}{L}\right](T_2 - T_1) + \frac{h(\Delta x)^2}{kL \sin \theta}(T_\infty - T_1) + \frac{\varepsilon\sigma(\Delta x)^2}{kL \sin \theta}[T_{\text{surr}}^4 - (T_1 + 273)^4] = 0$$

$$m = 2: \quad \left[1 - 1.5\frac{\Delta x}{L}\right](T_1 - T_2) + \left[1 - 2.5\frac{\Delta x}{L}\right](T_3 - T_2) + \frac{h(\Delta x)^2}{kL \sin \theta}(T_\infty - T_2) + \frac{\varepsilon\sigma(\Delta x)^2}{kL \sin \theta}[T_{\text{surr}}^4 - (T_2 + 273)^4] = 0$$

$$m = 3: \quad \left[1 - 2.5\frac{\Delta x}{L}\right](T_2 - T_3) + \left[1 - 3.5\frac{\Delta x}{L}\right](T_4 - T_3) + \frac{h(\Delta x)^2}{kL \sin \theta}(T_\infty - T_3) + \frac{\varepsilon\sigma(\Delta x)^2}{kL \sin \theta}[T_{\text{surr}}^4 - (T_3 + 273)^4] = 0$$

$$m = 4: \quad \left[1 - 3.5\frac{\Delta x}{L}\right](T_3 - T_4) + \left[1 - 4.5\frac{\Delta x}{L}\right](T_5 - T_4) + \frac{h(\Delta x)^2}{kL \sin \theta}(T_\infty - T_4) + \frac{\varepsilon\sigma(\Delta x)^2}{kL \sin \theta}[T_{\text{surr}}^4 - (T_4 + 273)^4] = 0$$

An energy balance on the 5th node gives the 5th equation,

$$m = 5: \quad 2k \frac{\Delta x}{2} \tan \theta \frac{T_4 - T_5}{\Delta x} + 2h \frac{\Delta x/2}{\cos \theta} (T_\infty - T_5) + 2\varepsilon\sigma \frac{\Delta x/2}{\cos \theta} [T_{\text{surr}}^4 - (T_5 + 273)^4] = 0$$

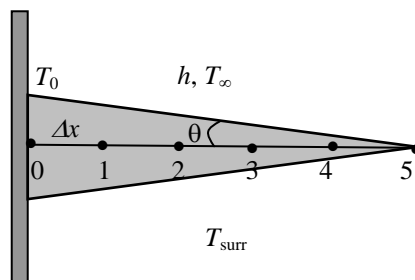

Solving the 5 equations above simultaneously for the 5 unknown nodal temperatures gives

$$T_1 = 177.0^\circ\text{C}, \quad T_2 = 174.1^\circ\text{C}, \quad T_3 = 171.2^\circ\text{C}, \quad T_4 = 168.4^\circ\text{C}, \quad \text{and} \quad T_5 = 165.5^\circ\text{C}$$

(b) The total rate of heat transfer from the fin is simply the sum of the heat transfer from each volume element to the ambient, and for $w = 1$ m it is determined from

$$\dot{Q}_{\text{fin}} = \sum_{m=0}^5 \dot{Q}_{\text{element},m} = \sum_{m=0}^5 hA_{\text{surface},m}(T_m - T_\infty) + \sum_{m=0}^5 \varepsilon\sigma A_{\text{surface},m}[(T_m + 273)^4 - T_{\text{surr}}^4]$$

Noting that the heat transfer surface area is $w\Delta x / \cos \theta$ for the boundary nodes 0 and 5, and twice as large for the interior nodes 1, 2, 3, and 4, we have

$$\begin{aligned} \dot{Q}_{\text{fin}} &= h \frac{w\Delta x}{\cos \theta} [(T_0 - T_\infty) + 2(T_1 - T_\infty) + 2(T_2 - T_\infty) + 2(T_3 - T_\infty) + 2(T_4 - T_\infty) + (T_5 - T_\infty)] \\ &\quad + \varepsilon\sigma \frac{w\Delta x}{\cos \theta} \{ [(T_0 + 273)^4 - T_{\text{surr}}^4] + 2[(T_1 + 273)^4 - T_{\text{surr}}^4] + 2[(T_2 + 273)^4 - T_{\text{surr}}^4] + 2[(T_3 + 273)^4 - T_{\text{surr}}^4] \\ &\quad + 2[(T_4 + 273)^4 - T_{\text{surr}}^4] + [(T_5 + 273)^4 - T_{\text{surr}}^4] \} \\ &= \mathbf{537 \text{ W}} \end{aligned}$$

5-26 EES Prob. 5-25 is reconsidered. The effect of the fin base temperature on the fin tip temperature and the rate of heat transfer from the fin is to be investigated.

Analysis The problem is solved using EES, and the solution is given below.

"GIVEN"

$$k=180 \text{ [W/m-C]}$$

$$L=0.05 \text{ [m]}$$

$$b=0.01 \text{ [m]}$$

$$w=1 \text{ [m]}$$

$$T_0=180 \text{ [C]}$$

$$T_{\text{infinity}}=25 \text{ [C]}$$

$$h=25 \text{ [W/m}^2\text{-C]}$$

$$T_{\text{surr}}=290 \text{ [K]}$$

$$M=6$$

$$\text{epsilon}=0.9$$

$$\tan(\theta)=(0.5*b)/L$$

$$\sigma=5.67E-8 \text{ [W/m}^2\text{-K}^4] \text{ "Stefan-Boltzmann constant"}$$

"ANALYSIS"

"(a)"

$$\Delta x=L/(M-1)$$

"Using the finite difference method, the five equations for the temperatures at 5 nodes are determined to be"

$$(1-0.5*\Delta x/L)*(T_0-T_1)+(1-1.5*\Delta x/L)*(T_2-T_1)+(h*\Delta x^2)/(k*L*\sin(\theta))*(T_{\text{infinity}}-T_1)+(\text{epsilon}*\sigma*\Delta x^2)/(k*L*\sin(\theta))*(T_{\text{surr}}^4-(T_1+273)^4)=0 \text{ "for mode 1"}$$

$$(1-1.5*\Delta x/L)*(T_1-T_2)+(1-2.5*\Delta x/L)*(T_3-T_2)+(h*\Delta x^2)/(k*L*\sin(\theta))*(T_{\text{infinity}}-T_2)+(\text{epsilon}*\sigma*\Delta x^2)/(k*L*\sin(\theta))*(T_{\text{surr}}^4-(T_2+273)^4)=0 \text{ "for mode 2"}$$

$$(1-2.5*\Delta x/L)*(T_2-T_3)+(1-3.5*\Delta x/L)*(T_4-T_3)+(h*\Delta x^2)/(k*L*\sin(\theta))*(T_{\text{infinity}}-T_3)+(\text{epsilon}*\sigma*\Delta x^2)/(k*L*\sin(\theta))*(T_{\text{surr}}^4-(T_3+273)^4)=0 \text{ "for mode 3"}$$

$$(1-3.5*\Delta x/L)*(T_3-T_4)+(1-4.5*\Delta x/L)*(T_5-T_4)+(h*\Delta x^2)/(k*L*\sin(\theta))*(T_{\text{infinity}}-T_4)+(\text{epsilon}*\sigma*\Delta x^2)/(k*L*\sin(\theta))*(T_{\text{surr}}^4-(T_4+273)^4)=0 \text{ "for mode 4"}$$

$$2*k*\Delta x/2*\tan(\theta)*(T_4-T_5)/\Delta x+2*h*(0.5*\Delta x)/\cos(\theta)*(T_{\text{infinity}}-T_5)+2*\text{epsilon}*\sigma*(0.5*\Delta x)/\cos(\theta)*(T_{\text{surr}}^4-(T_5+273)^4)=0 \text{ "for mode 5"}$$

$$T_{\text{tip}}=T_5$$

"(b)"

$$Q_{\text{dot fin}}=C+D \text{ "where"}$$

$$C=h*(w*\Delta x)/\cos(\theta)*((T_0-T_{\text{infinity}})+2*(T_1-T_{\text{infinity}})+2*(T_2-T_{\text{infinity}})+2*(T_3-T_{\text{infinity}})+2*(T_4-T_{\text{infinity}})+(T_5-T_{\text{infinity}}))$$

$$D=\text{epsilon}*\sigma*(w*\Delta x)/\cos(\theta)*(((T_0+273)^4-T_{\text{surr}}^4)+2*((T_1+273)^4-T_{\text{surr}}^4)+2*((T_2+273)^4-T_{\text{surr}}^4)+2*((T_3+273)^4-T_{\text{surr}}^4)+2*((T_4+273)^4-T_{\text{surr}}^4)+((T_5+273)^4-T_{\text{surr}}^4))$$

T_0 [C]	T_{tip} [C]	Q_{fin} [W]
100	93.51	239.8
105	98.05	256.8
110	102.6	274
115	107.1	291.4
120	111.6	309
125	116.2	326.8
130	120.7	344.8
135	125.2	363.1
140	129.7	381.5
145	134.2	400.1
150	138.7	419
155	143.2	438.1
160	147.7	457.5
165	152.1	477.1
170	156.6	496.9
175	161.1	517
180	165.5	537.3
185	170	557.9
190	174.4	578.7
195	178.9	599.9
200	183.3	621.2

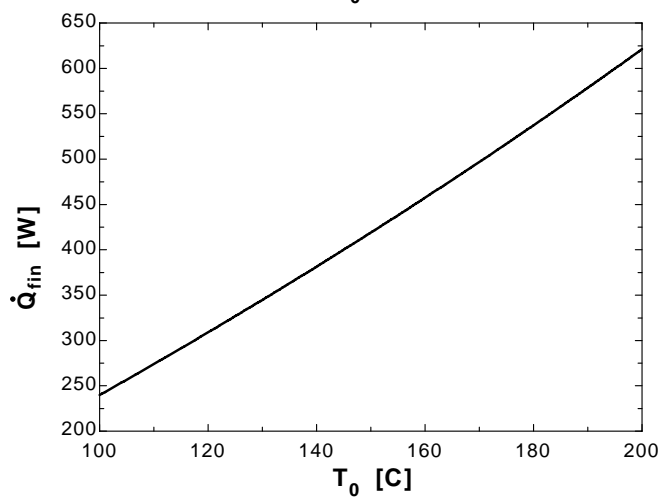
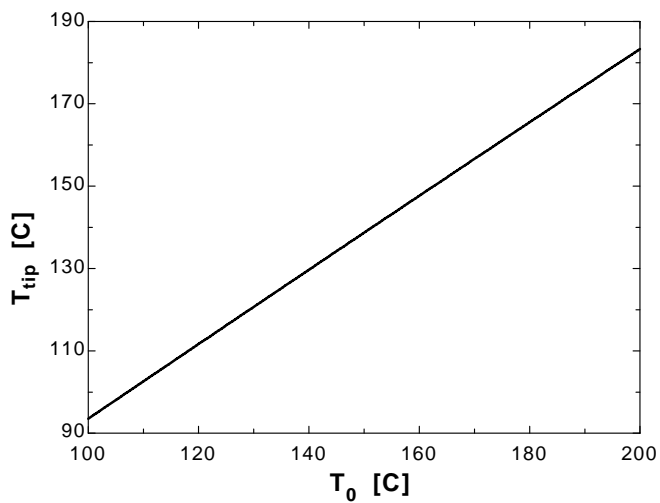

5-27 A plane wall is subjected to specified temperature on one side and convection on the other. The finite difference formulation of this problem is to be obtained, and the nodal temperatures under steady conditions as well as the rate of heat transfer through the wall are to be determined.

Assumptions **1** Heat transfer through the wall is given to be steady and one-dimensional. **2** Thermal conductivity is constant. **3** There is no heat generation. **4** Radiation heat transfer is negligible.

Properties The thermal conductivity is given to be $k = 2.3 \text{ W/m}\cdot\text{°C}$.

Analysis The nodal spacing is given to be $\Delta x = 0.1 \text{ m}$. Then the number of nodes M becomes

$$M = \frac{L}{\Delta x} + 1 = \frac{0.4 \text{ m}}{0.1 \text{ m}} + 1 = 5$$

The left surface temperature is given to be $T_0 = 95^\circ\text{C}$. This problem involves 4 unknown nodal temperatures, and thus we need to have 4 equations to determine them uniquely. Nodes 1, 2, and 3 are interior nodes, and thus for them we can use the general finite difference relation expressed as

$$\frac{T_{m-1} - 2T_m + T_{m+1}}{\Delta x^2} + \frac{\dot{e}_m}{k} = 0 \rightarrow T_{m-1} - 2T_m + T_{m+1} = 0 \quad (\text{since } \dot{e} = 0), \quad \text{for } m = 0, 1, 2, \text{ and } 3$$

The finite difference equation for node 4 on the right surface subjected to convection is obtained by applying an energy balance on the half volume element about node 4 and taking the direction of all heat transfers to be towards the node under consideration:

$$\text{Node 1 (interior):} \quad T_0 - 2T_1 + T_2 = 0$$

$$\text{Node 2 (interior):} \quad T_1 - 2T_2 + T_3 = 0$$

$$\text{Node 3 (interior):} \quad T_2 - 2T_3 + T_4 = 0$$

$$\text{Node 4 (right surface - convection):} \quad h(T_\infty - T_4) + k \frac{T_3 - T_4}{\Delta x} = 0$$

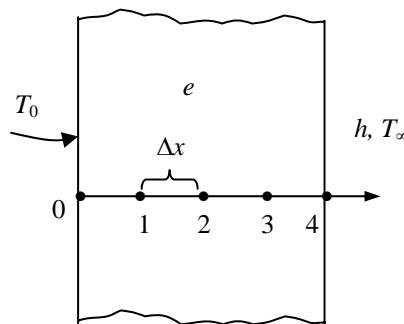

where $\Delta x = 0.1 \text{ m}$, $k = 2.3 \text{ W/m}\cdot\text{°C}$, $h = 18 \text{ W/m}^2 \cdot \text{°C}$, $T_0 = 95^\circ\text{C}$ and $T_\infty = 15^\circ\text{C}$.

The system of 4 equations with 4 unknown temperatures constitute the finite difference formulation of the problem.

(b) The nodal temperatures under steady conditions are determined by solving the 4 equations above simultaneously with an equation solver to be

$$T_1 = 79.8^\circ\text{C}, \quad T_2 = 64.7^\circ\text{C}, \quad T_3 = 49.5^\circ\text{C}, \quad \text{and} \quad T_4 = 34.4^\circ\text{C}$$

(c) The rate of heat transfer through the wall is simply convection heat transfer at the right surface,

$$\dot{Q}_{\text{wall}} = \dot{Q}_{\text{conv}} = hA(T_4 - T_\infty) = (18 \text{ W/m}^2 \cdot \text{°C})(20 \text{ m}^2)(34.37 - 15)^\circ\text{C} = 6970 \text{ W}$$

Discussion This problem can be solved analytically by solving the differential equation as described in Chap. 2, and the analytical (exact) solution can be used to check the accuracy of the numerical solution above.

5-28 A plate is subjected to specified heat flux on one side and specified temperature on the other. The finite difference formulation of this problem is to be obtained, and the unknown surface temperature under steady conditions is to be determined.

Assumptions 1 Heat transfer through the base plate is given to be steady. 2 Heat transfer is one-dimensional since the plate is large relative to its thickness. 3 There is no heat generation in the plate. 4 Radiation heat transfer is negligible. 5 The entire heat generated by the resistance heaters is transferred through the plate.

Properties The thermal conductivity is given to be $k = 20 \text{ W/m}\cdot^\circ\text{C}$.

Analysis The nodal spacing is given to be $\Delta x = 0.2 \text{ cm}$. Then the number of nodes M becomes

$$M = \frac{L}{\Delta x} + 1 = \frac{0.6 \text{ cm}}{0.2 \text{ cm}} + 1 = 4$$

The right surface temperature is given to be $T_3 = 85^\circ\text{C}$. This problem involves 3 unknown nodal temperatures, and thus we need to have 3 equations to determine them uniquely. Nodes 1 and 2 are interior nodes, and thus for them we can use the general finite difference relation expressed as

$$\frac{T_{m-1} - 2T_m + T_{m+1}}{\Delta x^2} + \frac{\dot{e}_m}{k} = 0 \rightarrow T_{m-1} - 2T_m + T_{m+1} = 0 \quad (\text{since } \dot{e} = 0), \quad \text{for } m = 1 \text{ and } 2$$

The finite difference equation for node 0 on the left surface subjected to uniform heat flux is obtained by applying an energy balance on the half volume element about node 0 and taking the direction of all heat transfers to be towards the node under consideration:

$$\text{Node 0 (left surface - heat flux):} \quad \dot{q}_0 + k \frac{T_1 - T_0}{\Delta x} = 0$$

$$\text{Node 1 (interior):} \quad T_0 - 2T_1 + T_2 = 0$$

$$\text{Node 2 (interior):} \quad T_1 - 2T_2 + T_3 = 0$$

where $\Delta x = 0.2 \text{ cm}$, $k = 20 \text{ W/m}\cdot^\circ\text{C}$, $T_3 = 85^\circ\text{C}$, and $\dot{q}_0 = \dot{Q}_0 / A = (800 \text{ W}) / (0.0160 \text{ m}^2) = 50,000 \text{ W/m}^2$. The system of 3 equations with 3 unknown temperatures constitute the finite difference formulation of the problem.

(b) The nodal temperatures under steady conditions are determined by solving the 3 equations above simultaneously with an equation solver to be

$$T_0 = 100^\circ\text{C}, \quad T_1 = 95^\circ\text{C}, \quad \text{and} \quad T_2 = 90^\circ\text{C}$$

Discussion This problem can be solved analytically by solving the differential equation as described in Chap. 2, and the analytical (exact) solution can be used to check the accuracy of the numerical solution above.

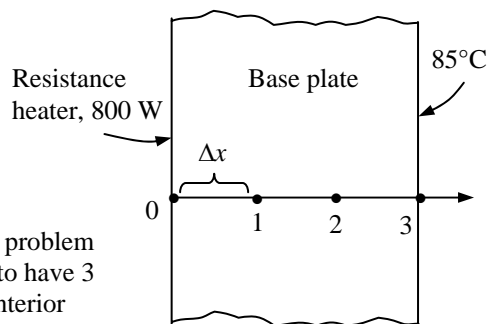

5-29 A plane wall is subjected to specified heat flux and specified temperature on one side, and no conditions on the other. The finite difference formulation of this problem is to be obtained, and the temperature of the other side under steady conditions is to be determined.

Assumptions 1 Heat transfer through the plate is given to be steady and one-dimensional. **2** There is no heat generation in the plate.

Properties The thermal conductivity is given to be $k = 2.5 \text{ W/m}\cdot\text{°C}$.

Analysis The nodal spacing is given to be $\Delta x = 0.06 \text{ m}$.

Then the number of nodes M becomes

$$M = \frac{L}{\Delta x} + 1 = \frac{0.3 \text{ m}}{0.06 \text{ m}} + 1 = 6$$

Nodes 1, 2, 3, and 4 are interior nodes, and thus for them we can use the general finite difference relation expressed as

$$\frac{T_{m-1} - 2T_m + T_{m+1}}{\Delta x^2} + \frac{\dot{e}_m}{k} = 0 \rightarrow T_{m+1} - 2T_m + T_{m-1} = 0 \quad (\text{since } \dot{e} = 0), \quad \text{for } m = 1, 2, 3, \text{ and } 4$$

The finite difference equation for node 0 on the left surface is obtained by applying an energy balance on the half volume element about node 0 and taking the direction of all heat transfers to be towards the node under consideration,

$$\dot{q}_0 + k \frac{T_1 - T_0}{\Delta x} = 0 \quad \longrightarrow \quad 350 \text{ W/m}^2 + (2.5 \text{ W/m}\cdot\text{°C}) \frac{T_1 - 60^\circ\text{C}}{0.06 \text{ m}} = 0 \quad \longrightarrow \quad T_1 = 51.6^\circ\text{C}$$

Other nodal temperatures are determined from the general interior node relation as follows:

$$\begin{aligned} m = 1: & \quad T_2 = 2T_1 - T_0 = 2 \times 51.6 - 60 = 43.2^\circ\text{C} \\ m = 2: & \quad T_3 = 2T_2 - T_1 = 2 \times (43.2) - 51.6 = 34.8^\circ\text{C} \\ m = 3: & \quad T_4 = 2T_3 - T_2 = 2 \times (34.8) - (43.2) = 26.4^\circ\text{C} \\ m = 4: & \quad T_5 = 2T_4 - T_3 = 2 \times (26.4) - (34.8) = 18^\circ\text{C} \end{aligned}$$

Therefore, the temperature of the other surface will be 18°C

Discussion This problem can be solved analytically by solving the differential equation as described in Chap. 2, and the analytical (exact) solution can be used to check the accuracy of the numerical solution above.

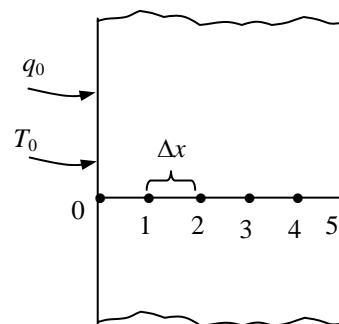

5-30E A large plate lying on the ground is subjected to convection and radiation. Finite difference formulation is to be obtained, and the top and bottom surface temperatures under steady conditions are to be determined.

Assumptions 1 Heat transfer through the plate is given to be steady and one-dimensional. **2** There is no heat generation in the plate and the soil. **3** Thermal contact resistance at plate-soil interface is negligible.

Properties The thermal conductivity of the plate and the soil are given to be $k_{\text{plate}} = 7.2 \text{ Btu/h}\cdot\text{ft}\cdot^\circ\text{F}$ and $k_{\text{soil}} = 0.49 \text{ Btu/h}\cdot\text{ft}\cdot^\circ\text{F}$.

Analysis The nodal spacing is given to be $\Delta x_1 = 1 \text{ in.}$ in the plate, and be $\Delta x_2 = 0.6 \text{ ft}$ in the soil. Then the number of nodes becomes

$$M = \left(\frac{L}{\Delta x}\right)_{\text{plate}} + \left(\frac{L}{\Delta x}\right)_{\text{soil}} + 1 = \frac{5 \text{ in}}{1 \text{ in}} + \frac{3 \text{ ft}}{0.6 \text{ ft}} + 1 = 11$$

The temperature at node 10 (bottom of the soil) is given to be $T_{10} = 50^\circ\text{F}$. Nodes 1, 2, 3, and 4 in the plate and 6, 7, 8, and 9 in the soil are interior nodes, and thus for them we can use the general finite difference relation expressed as

$$\frac{T_{m-1} - 2T_m + T_{m+1}}{\Delta x^2} + \frac{\dot{e}_m}{k} = 0 \rightarrow T_{m-1} - 2T_m + T_{m+1} = 0 \quad (\text{since } \dot{e} = 0)$$

The finite difference equation for node 0 on the left surface and node 5 at the interface are obtained by applying an energy balance on their respective volume elements and taking the direction of all heat transfers to be towards the node under consideration:

$$\text{Node 0 (top surface): } h(T_\infty - T_0) + \varepsilon\sigma[T_{\text{sky}}^4 - (T_0 + 460)^4] + k_{\text{plate}} \frac{T_1 - T_0}{\Delta x_1} = 0$$

$$\text{Node 1 (interior): } T_0 - 2T_1 + T_2 = 0$$

$$\text{Node 2 (interior): } T_1 - 2T_2 + T_3 = 0$$

$$\text{Node 3 (interior): } T_2 - 2T_3 + T_4 = 0$$

$$\text{Node 4 (interior): } T_3 - 2T_4 + T_5 = 0$$

$$\text{Node 5 (interface): } k_{\text{plate}} \frac{T_4 - T_5}{\Delta x_1} + k_{\text{soil}} \frac{T_6 - T_5}{\Delta x_2} = 0$$

$$\text{Node 6 (interior): } T_5 - 2T_6 + T_7 = 0$$

$$\text{Node 7 (interior): } T_6 - 2T_7 + T_8 = 0$$

$$\text{Node 8 (interior): } T_7 - 2T_8 + T_9 = 0$$

$$\text{Node 9 (interior): } T_8 - 2T_9 + T_{10} = 0$$

where $\Delta x_1 = 1/12 \text{ ft}$, $\Delta x_2 = 0.6 \text{ ft}$, $k_{\text{plate}} = 7.2 \text{ Btu/h}\cdot\text{ft}\cdot^\circ\text{F}$, $k_{\text{soil}} = 0.49 \text{ Btu/h}\cdot\text{ft}\cdot^\circ\text{F}$, $h = 3.5 \text{ Btu/h}\cdot\text{ft}^2\cdot^\circ\text{F}$, $T_{\text{sky}} = 510 \text{ R}$, $\varepsilon = 0.6$, $T_\infty = 80^\circ\text{F}$, and $T_{10} = 50^\circ\text{F}$.

This system of 10 equations with 10 unknowns constitute the finite difference formulation of the problem.

(b) The temperatures are determined by solving equations above to be

$$T_0 = \mathbf{74.71^\circ\text{F}}, \quad T_1 = 74.67^\circ\text{F}, \quad T_2 = 74.62^\circ\text{F}, \quad T_3 = 74.58^\circ\text{F}, \quad T_4 = 74.53^\circ\text{F},$$

$$T_5 = \mathbf{74.48^\circ\text{F}}, \quad T_6 = 69.6^\circ\text{F}, \quad T_7 = 64.7^\circ\text{F}, \quad T_8 = 59.8^\circ\text{F}, \quad T_9 = 54.9^\circ\text{F}$$

Discussion Note that the plate is essentially isothermal at about 74.6°F . Also, the temperature in each layer varies linearly and thus we could solve this problem by considering 3 nodes only (one at the interface and two at the boundaries).

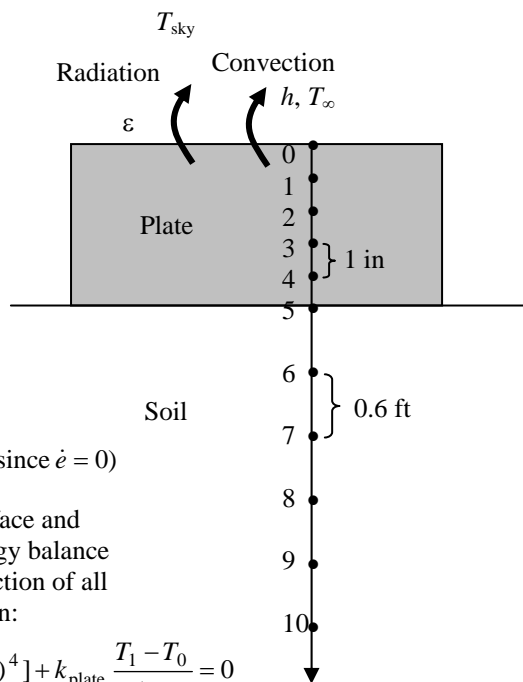

5-31E A large plate lying on the ground is subjected to convection from its exposed surface. The finite difference formulation of this problem is to be obtained, and the top and bottom surface temperatures under steady conditions are to be determined.

Assumptions 1 Heat transfer through the plate is given to be steady and one-dimensional. 2 There is no heat generation in the plate and the soil. 3 The thermal contact resistance at the plate-soil interface is negligible. 4 Radiation heat transfer is negligible.

Properties The thermal conductivity of the plate and the soil are given to be $k_{\text{plate}} = 7.2 \text{ Btu/h}\cdot\text{ft}\cdot^\circ\text{F}$ and $k_{\text{soil}} = 0.49 \text{ Btu/h}\cdot\text{ft}\cdot^\circ\text{F}$.

Analysis The nodal spacing is given to be $\Delta x_1 = 1 \text{ in.}$ in the plate, and be $\Delta x_2 = 0.6 \text{ ft}$ in the soil. Then the number of nodes becomes

$$M = \left(\frac{L}{\Delta x}\right)_{\text{plate}} + \left(\frac{L}{\Delta x}\right)_{\text{soil}} + 1 = \frac{5 \text{ in}}{1 \text{ in}} + \frac{3 \text{ ft}}{0.6 \text{ ft}} + 1 = 11$$

The temperature at node 10 (bottom of the soil) is given to be $T_{10} = 50^\circ\text{F}$. Nodes 1, 2, 3, and 4 in the plate and 6, 7, 8, and 9 in the soil are interior nodes, and thus for them we can use the general finite difference relation expressed as

$$\frac{T_{m-1} - 2T_m + T_{m+1}}{\Delta x^2} + \frac{\dot{e}_m}{k} = 0 \rightarrow T_{m-1} - 2T_m + T_{m+1} = 0 \quad (\text{since } \dot{e} = 0)$$

The finite difference equation for node 0 on the left surface and node 5 at the interface are obtained by applying an energy balance on their respective volume elements and taking the direction of all heat transfers to be towards the node under consideration:

$$\text{Node 0 (top surface):} \quad h(T_\infty - T_0) + k_{\text{plate}} \frac{T_1 - T_0}{\Delta x_1} = 0$$

$$\text{Node 1 (interior):} \quad T_0 - 2T_1 + T_2 = 0$$

$$\text{Node 2 (interior):} \quad T_1 - 2T_2 + T_3 = 0$$

$$\text{Node 3 (interior):} \quad T_2 - 2T_3 + T_4 = 0$$

$$\text{Node 4 (interior):} \quad T_3 - 2T_4 + T_5 = 0$$

$$\text{Node 5 (interface):} \quad k_{\text{plate}} \frac{T_4 - T_5}{\Delta x_1} + k_{\text{soil}} \frac{T_6 - T_5}{\Delta x_2} = 0$$

$$\text{Node 6 (interior):} \quad T_5 - 2T_6 + T_7 = 0$$

$$\text{Node 7 (interior):} \quad T_6 - 2T_7 + T_8 = 0$$

$$\text{Node 8 (interior):} \quad T_7 - 2T_8 + T_9 = 0$$

$$\text{Node 9 (interior):} \quad T_8 - 2T_9 + T_{10} = 0$$

where $\Delta x_1 = 1/12 \text{ ft}$, $\Delta x_2 = 0.6 \text{ ft}$, $k_{\text{plate}} = 7.2 \text{ Btu/h}\cdot\text{ft}\cdot^\circ\text{F}$, $k_{\text{soil}} = 0.49 \text{ Btu/h}\cdot\text{ft}\cdot^\circ\text{F}$, $h = 3.5 \text{ Btu/h}\cdot\text{ft}^2\cdot^\circ\text{F}$, $T_\infty = 80^\circ\text{F}$, and $T_{10} = 50^\circ\text{F}$.

This system of 10 equations with 10 unknowns constitute the finite difference formulation of the problem.

(b) The temperatures are determined by solving equations above to be

$$T_0 = \mathbf{78.67^\circ\text{F}}, \quad T_1 = 78.62^\circ\text{F}, \quad T_2 = 78.57^\circ\text{F}, \quad T_3 = 78.51^\circ\text{F}, \quad T_4 = 78.46^\circ\text{F},$$

$$T_5 = \mathbf{78.41^\circ\text{F}}, \quad T_6 = 72.7^\circ\text{F}, \quad T_7 = 67.0^\circ\text{F}, \quad T_8 = 61.4^\circ\text{F}, \quad T_9 = 55.7^\circ\text{F}$$

Discussion Note that the plate is essentially isothermal at about 78.6°F . Also, the temperature in each layer varies linearly and thus we could solve this problem by considering 3 nodes only (one at the interface and two at the boundaries).

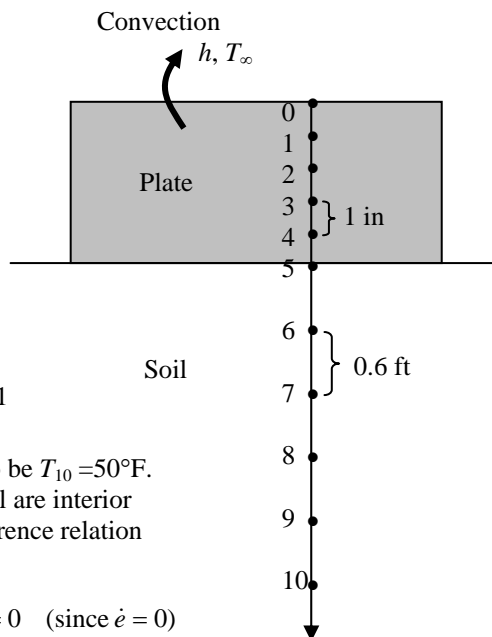

5-32 The handle of a stainless steel spoon partially immersed in boiling water loses heat by convection and radiation. The finite difference formulation of the problem is to be obtained, and the tip temperature of the spoon as well as the rate of heat transfer from the exposed surfaces are to be determined.

Assumptions 1 Heat transfer through the handle of the spoon is given to be steady and one-dimensional. **2** Thermal conductivity and emissivity are constant. **3** Convection heat transfer coefficient is constant and uniform.

Properties The thermal conductivity and emissivity are given to be $k = 15.1 \text{ W/m}\cdot^\circ\text{C}$ and $\varepsilon = 0.6$.

Analysis The nodal spacing is given to be $\Delta x = 3 \text{ cm}$. Then the number of nodes M becomes

$$M = \frac{L}{\Delta x} + 1 = \frac{18 \text{ cm}}{3 \text{ cm}} + 1 = 7$$

The base temperature at node 0 is given to be $T_0 = 95^\circ\text{C}$. This problem involves 6 unknown nodal temperatures, and thus we need to have 6 equations to determine them uniquely. Nodes 1, 2, 3, 4, and 5 are interior nodes, and thus for them we can use the general finite difference relation expressed as

$$kA \frac{T_{m-1} - T_m}{\Delta x} + kA \frac{T_{m+1} - T_m}{\Delta x} + h(p\Delta x)(T_\infty - T_m) + \varepsilon\sigma(p\Delta x)[T_{\text{surr}}^4 - (T_m + 273)^4] = 0$$

or $T_{m-1} - 2T_m + T_{m+1} + h(p\Delta x^2 / kA)(T_\infty - T_m) + \varepsilon\sigma(p\Delta x^2 / kA)[T_{\text{surr}}^4 - (T_m + 273)^4] = 0, m = 1, 2, 3, 4, 5$

The finite difference equation for node 6 at the fin tip is obtained by applying an energy balance on the half volume element about node 6. Then,

$$m=1: T_0 - 2T_1 + T_2 + h(p\Delta x^2 / kA)(T_\infty - T_1) + \varepsilon\sigma(p\Delta x^2 / kA)[T_{\text{surr}}^4 - (T_1 + 273)^4] = 0$$

$$m=2: T_1 - 2T_2 + T_3 + h(p\Delta x^2 / kA)(T_\infty - T_2) + \varepsilon\sigma(p\Delta x^2 / kA)[T_{\text{surr}}^4 - (T_2 + 273)^4] = 0$$

$$m=3: T_2 - 2T_3 + T_4 + h(p\Delta x^2 / kA)(T_\infty - T_3) + \varepsilon\sigma(p\Delta x^2 / kA)[T_{\text{surr}}^4 - (T_3 + 273)^4] = 0$$

$$m=4: T_3 - 2T_4 + T_5 + h(p\Delta x^2 / kA)(T_\infty - T_4) + \varepsilon\sigma(p\Delta x^2 / kA)[T_{\text{surr}}^4 - (T_4 + 273)^4] = 0$$

$$m=5: T_4 - 2T_5 + T_6 + h(p\Delta x^2 / kA)(T_\infty - T_5) + \varepsilon\sigma(p\Delta x^2 / kA)[T_{\text{surr}}^4 - (T_5 + 273)^4] = 0$$

$$\text{Node 6: } kA \frac{T_5 - T_6}{\Delta x} + h(p\Delta x / 2 + A)(T_\infty - T_6) + \varepsilon\sigma(p\Delta x / 2 + A)[T_{\text{surr}}^4 - (T_6 + 273)^4] = 0$$

where $\Delta x = 0.03 \text{ m}$, $k = 15.1 \text{ W/m}\cdot^\circ\text{C}$, $\varepsilon = 0.6$, $T_\infty = 25^\circ\text{C}$, $T_0 = 95^\circ\text{C}$, $T_{\text{surr}} = 295 \text{ K}$, $h = 13 \text{ W/m}^2 \cdot^\circ\text{C}$

and $A = (1 \text{ cm})(0.2 \text{ cm}) = 0.2 \text{ cm}^2 = 0.2 \times 10^{-4} \text{ m}^2$ and $p = 2(1 + 0.2 \text{ cm}) = 2.4 \text{ cm} = 0.024 \text{ m}$

The system of 6 equations with 6 unknowns constitute the finite difference formulation of the problem.

(b) The nodal temperatures under steady conditions are determined by solving the 6 equations above simultaneously with an equation solver to be

$$T_1 = 49.0^\circ\text{C}, \quad T_2 = 33.0^\circ\text{C}, \quad T_3 = 27.4^\circ\text{C}, \quad T_4 = 25.5^\circ\text{C}, \quad T_5 = 24.8^\circ\text{C}, \quad \text{and } T_6 = \mathbf{24.6^\circ\text{C}},$$

(c) The total rate of heat transfer from the spoon handle is simply the sum of the heat transfer from each nodal element, and is determined from

$$\dot{Q}_{\text{fin}} = \sum_{m=0}^6 \dot{Q}_{\text{element},m} = \sum_{m=0}^6 hA_{\text{surface},m}(T_m - T_\infty) + \sum_{m=0}^6 \varepsilon\sigma A_{\text{surface},m}[(T_m + 273)^4 - T_{\text{surr}}^4] = \mathbf{0.92 \text{ W}}$$

where $A_{\text{surface},m} = p\Delta x / 2$ for node 0, $A_{\text{surface},m} = p\Delta x / 2 + A$ for node 6, and $A_{\text{surface},m} = p\Delta x$ for other nodes.

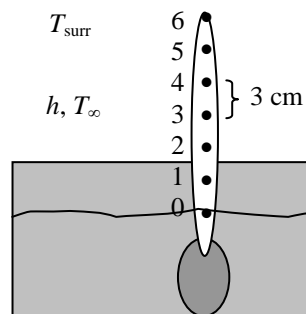

5-33 The handle of a stainless steel spoon partially immersed in boiling water loses heat by convection and radiation. The finite difference formulation of the problem for all nodes is to be obtained, and the temperature of the tip of the spoon as well as the rate of heat transfer from the exposed surfaces of the spoon are to be determined.

Assumptions 1 Heat transfer through the handle of the spoon is given to be steady and one-dimensional. **2** The thermal conductivity and emissivity are constant. **3** Heat transfer coefficient is constant and uniform.

Properties The thermal conductivity and emissivity are given to be $k = 15.1 \text{ W/m}\cdot\text{C}$ and $\varepsilon = 0.6$.

Analysis The nodal spacing is given to be $\Delta x = 1.5 \text{ cm}$. Then the number of nodes M becomes

$$M = \frac{L}{\Delta x} + 1 = \frac{18 \text{ cm}}{1.5 \text{ cm}} + 1 = 13$$

The base temperature at node 0 is given to be $T_0 = 95^\circ\text{C}$. This problem involves 12 unknown nodal temperatures, and thus we need to have 12 equations to determine them uniquely. Nodes 1 through 12 are interior nodes, and thus for them we can use the general finite difference relation expressed as

$$kA \frac{T_{m-1} - T_m}{\Delta x} + kA \frac{T_{m+1} - T_m}{\Delta x} + h(p\Delta x)(T_\infty - T_m) + \varepsilon\sigma(p\Delta x)[T_{\text{surr}}^4 - (T_m + 273)^4] = 0$$

or $T_{m-1} - 2T_m + T_{m+1} + h(p\Delta x^2 / kA)(T_\infty - T_m) + \varepsilon\sigma(p\Delta x^2 / kA)[T_{\text{surr}}^4 - (T_m + 273)^4] = 0$, $m = 1-12$

The finite difference equation for node 12 at the fin tip is obtained by applying an energy balance on the half volume element about node 12. Then,

$$m = 1: T_0 - 2T_1 + T_2 + h(p\Delta x^2 / kA)(T_\infty - T_1) + \varepsilon\sigma(p\Delta x^2 / kA)[T_{\text{surr}}^4 - (T_1 + 273)^4] = 0$$

$$m = 2: T_1 - 2T_2 + T_3 + h(p\Delta x^2 / kA)(T_\infty - T_2) + \varepsilon\sigma(p\Delta x^2 / kA)[T_{\text{surr}}^4 - (T_2 + 273)^4] = 0$$

$$m = 3: T_2 - 2T_3 + T_4 + h(p\Delta x^2 / kA)(T_\infty - T_3) + \varepsilon\sigma(p\Delta x^2 / kA)[T_{\text{surr}}^4 - (T_3 + 273)^4] = 0$$

$$m = 4: T_3 - 2T_4 + T_5 + h(p\Delta x^2 / kA)(T_\infty - T_4) + \varepsilon\sigma(p\Delta x^2 / kA)[T_{\text{surr}}^4 - (T_4 + 273)^4] = 0$$

$$m = 5: T_4 - 2T_5 + T_6 + h(p\Delta x^2 / kA)(T_\infty - T_5) + \varepsilon\sigma(p\Delta x^2 / kA)[T_{\text{surr}}^4 - (T_5 + 273)^4] = 0$$

$$m = 6: T_5 - 2T_6 + T_7 + h(p\Delta x^2 / kA)(T_\infty - T_6) + \varepsilon\sigma(p\Delta x^2 / kA)[T_{\text{surr}}^4 - (T_6 + 273)^4] = 0$$

$$m = 7: T_6 - 2T_7 + T_8 + h(p\Delta x^2 / kA)(T_\infty - T_7) + \varepsilon\sigma(p\Delta x^2 / kA)[T_{\text{surr}}^4 - (T_7 + 273)^4] = 0$$

$$m = 8: T_7 - 2T_8 + T_9 + h(p\Delta x^2 / kA)(T_\infty - T_8) + \varepsilon\sigma(p\Delta x^2 / kA)[T_{\text{surr}}^4 - (T_8 + 273)^4] = 0$$

$$m = 9: T_8 - 2T_9 + T_{10} + h(p\Delta x^2 / kA)(T_\infty - T_9) + \varepsilon\sigma(p\Delta x^2 / kA)[T_{\text{surr}}^4 - (T_9 + 273)^4] = 0$$

$$m = 10: T_9 - 2T_{10} + T_{11} + h(p\Delta x^2 / kA)(T_\infty - T_{10}) + \varepsilon\sigma(p\Delta x^2 / kA)[T_{\text{surr}}^4 - (T_{10} + 273)^4] = 0$$

$$m = 11: T_{10} - 2T_{11} + T_{12} + h(p\Delta x^2 / kA)(T_\infty - T_{11}) + \varepsilon\sigma(p\Delta x^2 / kA)[T_{\text{surr}}^4 - (T_{11} + 273)^4] = 0$$

$$\text{Node 12: } kA \frac{T_{11} - T_{12}}{\Delta x} + h(p\Delta x / 2 + A)(T_\infty - T_{12}) + \varepsilon\sigma(p\Delta x / 2 + A)[T_{\text{surr}}^4 - (T_{12} + 273)^4] = 0$$

where $\Delta x = 0.03 \text{ m}$, $k = 15.1 \text{ W/m}\cdot\text{C}$, $\varepsilon = 0.6$, $T_\infty = 25^\circ\text{C}$, $T_0 = 95^\circ\text{C}$, $T_{\text{surr}} = 295 \text{ K}$, $h = 13 \text{ W/m}^2\cdot\text{C}$

$$A = (1 \text{ cm})(0.2 \text{ cm}) = 0.2 \text{ cm}^2 = 0.2 \times 10^{-4} \text{ m}^2 \quad \text{and} \quad p = 2(1 + 0.2 \text{ cm}) = 2.4 \text{ cm} = 0.024 \text{ m}$$

(b) The nodal temperatures under steady conditions are determined by solving the equations above to be

$$T_1 = 65.2^\circ\text{C}, \quad T_2 = 48.1^\circ\text{C}, \quad T_3 = 38.2^\circ\text{C}, \quad T_4 = 32.4^\circ\text{C}, \quad T_5 = 29.1^\circ\text{C}, \quad T_6 = 27.1^\circ\text{C}, \quad T_7 = 26.0^\circ\text{C},$$

$$T_8 = 25.3^\circ\text{C}, \quad T_9 = 24.9^\circ\text{C}, \quad T_{10} = 24.7^\circ\text{C}, \quad T_{11} = 24.6^\circ\text{C}, \quad T_{12} = \mathbf{24.6^\circ\text{C}}$$

(c) The total rate of heat transfer from the spoon handle is the sum of the heat transfer from each element,

$$\dot{Q}_{\text{fin}} = \sum_{m=0}^{12} \dot{Q}_{\text{element},m} = \sum_{m=0}^{12} hA_{\text{surface},m}(T_m - T_\infty) + \sum_{m=0}^{12} \varepsilon\sigma A_{\text{surface},m}[(T_m + 273)^4 - T_{\text{surr}}^4] = \mathbf{0.83 \text{ W}}$$

where $A_{\text{surface},m} = p\Delta x / 2$ for node 0, $A_{\text{surface},m} = p\Delta x / 2 + A$ for node 13, and $A_{\text{surface},m} = p\Delta x$ for other nodes.

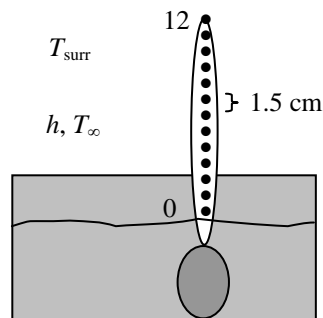

5-34 EES Prob. 5-33 is reconsidered. The effects of the thermal conductivity and the emissivity of the spoon material on the temperature at the spoon tip and the rate of heat transfer from the exposed surfaces of the spoon are to be investigated.

Analysis The problem is solved using EES, and the solution is given below.

"GIVEN"

k=15.1 [W/m-C]
 epsilon=0.6
 T_0=95 [C]
 T_infinity=25 [C]
 w=0.002 [m]
 s=0.01 [m]
 L=0.18 [m]
 h=13 [W/m^2-C]
 T_surr=295 [K]
 DELTAX=0.015 [m]
 sigma=5.67E-8 [W/m^2-K^4] "Stefan-Boltzmann constant"

"ANALYSIS"

"(b)"

M=L/DELTAx+1 "Number of nodes"

A=w*s

p=2*(w+s)

"Using the finite difference method, 12 equations for the unknown temperatures at 12 nodes are determined to be"

$T_0 - 2T_1 + T_2 + h^2(p \Delta x^2)/(kA)(T_\infty - T_1) + \epsilon \sigma (p \Delta x^2)/(kA)(T_{surr}^4 - (T_1 + 273)^4) = 0$ "mode 1"
 $T_1 - 2T_2 + T_3 + h^2(p \Delta x^2)/(kA)(T_\infty - T_2) + \epsilon \sigma (p \Delta x^2)/(kA)(T_{surr}^4 - (T_2 + 273)^4) = 0$ "mode 2"
 $T_2 - 2T_3 + T_4 + h^2(p \Delta x^2)/(kA)(T_\infty - T_3) + \epsilon \sigma (p \Delta x^2)/(kA)(T_{surr}^4 - (T_3 + 273)^4) = 0$ "mode 3"
 $T_3 - 2T_4 + T_5 + h^2(p \Delta x^2)/(kA)(T_\infty - T_4) + \epsilon \sigma (p \Delta x^2)/(kA)(T_{surr}^4 - (T_4 + 273)^4) = 0$ "mode 4"
 $T_4 - 2T_5 + T_6 + h^2(p \Delta x^2)/(kA)(T_\infty - T_5) + \epsilon \sigma (p \Delta x^2)/(kA)(T_{surr}^4 - (T_5 + 273)^4) = 0$ "mode 5"
 $T_5 - 2T_6 + T_7 + h^2(p \Delta x^2)/(kA)(T_\infty - T_6) + \epsilon \sigma (p \Delta x^2)/(kA)(T_{surr}^4 - (T_6 + 273)^4) = 0$ "mode 6"
 $T_6 - 2T_7 + T_8 + h^2(p \Delta x^2)/(kA)(T_\infty - T_7) + \epsilon \sigma (p \Delta x^2)/(kA)(T_{surr}^4 - (T_7 + 273)^4) = 0$ "mode 7"
 $T_7 - 2T_8 + T_9 + h^2(p \Delta x^2)/(kA)(T_\infty - T_8) + \epsilon \sigma (p \Delta x^2)/(kA)(T_{surr}^4 - (T_8 + 273)^4) = 0$ "mode 8"
 $T_8 - 2T_9 + T_{10} + h^2(p \Delta x^2)/(kA)(T_\infty - T_9) + \epsilon \sigma (p \Delta x^2)/(kA)(T_{surr}^4 - (T_9 + 273)^4) = 0$ "mode 9"
 $T_9 - 2T_{10} + T_{11} + h^2(p \Delta x^2)/(kA)(T_\infty - T_{10}) + \epsilon \sigma (p \Delta x^2)/(kA)(T_{surr}^4 - (T_{10} + 273)^4) = 0$ "mode 10"
 $T_{10} - 2T_{11} + T_{12} + h^2(p \Delta x^2)/(kA)(T_\infty - T_{11}) + \epsilon \sigma (p \Delta x^2)/(kA)(T_{surr}^4 - (T_{11} + 273)^4) = 0$ "mode 11"
 $kA(T_{11} - T_{12})/\Delta x + h(p \Delta x/2 + A)(T_\infty - T_{12}) + \epsilon \sigma (p \Delta x/2 + A)(T_{surr}^4 - (T_{12} + 273)^4) = 0$ "mode 12"

T_tip=T_12

"(c)"

A_s_0=p*DELTAx/2

A_s_12=p*DELTAx/2+A

A_s=p*DELTAx

$$\begin{aligned}
Q_{\text{dot}} &= Q_{\text{dot}_0} + Q_{\text{dot}_1} + Q_{\text{dot}_2} + Q_{\text{dot}_3} + Q_{\text{dot}_4} + Q_{\text{dot}_5} + Q_{\text{dot}_6} + Q_{\text{dot}_7} + Q_{\text{dot}_8} + \\
&Q_{\text{dot}_9} + Q_{\text{dot}_{10}} + Q_{\text{dot}_{11}} + Q_{\text{dot}_{12}} \\
Q_{\text{dot}_0} &= h \cdot A_{s_0} \cdot (T_0 - T_{\text{infinity}}) + \epsilon \cdot \sigma \cdot A_{s_0} \cdot ((T_0 + 273)^4 - T_{\text{surr}}^4) \\
Q_{\text{dot}_1} &= h \cdot A_{s_1} \cdot (T_1 - T_{\text{infinity}}) + \epsilon \cdot \sigma \cdot A_{s_1} \cdot ((T_1 + 273)^4 - T_{\text{surr}}^4) \\
Q_{\text{dot}_2} &= h \cdot A_{s_2} \cdot (T_2 - T_{\text{infinity}}) + \epsilon \cdot \sigma \cdot A_{s_2} \cdot ((T_2 + 273)^4 - T_{\text{surr}}^4) \\
Q_{\text{dot}_3} &= h \cdot A_{s_3} \cdot (T_3 - T_{\text{infinity}}) + \epsilon \cdot \sigma \cdot A_{s_3} \cdot ((T_3 + 273)^4 - T_{\text{surr}}^4) \\
Q_{\text{dot}_4} &= h \cdot A_{s_4} \cdot (T_4 - T_{\text{infinity}}) + \epsilon \cdot \sigma \cdot A_{s_4} \cdot ((T_4 + 273)^4 - T_{\text{surr}}^4) \\
Q_{\text{dot}_5} &= h \cdot A_{s_5} \cdot (T_5 - T_{\text{infinity}}) + \epsilon \cdot \sigma \cdot A_{s_5} \cdot ((T_5 + 273)^4 - T_{\text{surr}}^4) \\
Q_{\text{dot}_6} &= h \cdot A_{s_6} \cdot (T_6 - T_{\text{infinity}}) + \epsilon \cdot \sigma \cdot A_{s_6} \cdot ((T_6 + 273)^4 - T_{\text{surr}}^4) \\
Q_{\text{dot}_7} &= h \cdot A_{s_7} \cdot (T_7 - T_{\text{infinity}}) + \epsilon \cdot \sigma \cdot A_{s_7} \cdot ((T_7 + 273)^4 - T_{\text{surr}}^4) \\
Q_{\text{dot}_8} &= h \cdot A_{s_8} \cdot (T_8 - T_{\text{infinity}}) + \epsilon \cdot \sigma \cdot A_{s_8} \cdot ((T_8 + 273)^4 - T_{\text{surr}}^4) \\
Q_{\text{dot}_9} &= h \cdot A_{s_9} \cdot (T_9 - T_{\text{infinity}}) + \epsilon \cdot \sigma \cdot A_{s_9} \cdot ((T_9 + 273)^4 - T_{\text{surr}}^4) \\
Q_{\text{dot}_{10}} &= h \cdot A_{s_{10}} \cdot (T_{10} - T_{\text{infinity}}) + \epsilon \cdot \sigma \cdot A_{s_{10}} \cdot ((T_{10} + 273)^4 - T_{\text{surr}}^4) \\
Q_{\text{dot}_{11}} &= h \cdot A_{s_{11}} \cdot (T_{11} - T_{\text{infinity}}) + \epsilon \cdot \sigma \cdot A_{s_{11}} \cdot ((T_{11} + 273)^4 - T_{\text{surr}}^4) \\
Q_{\text{dot}_{12}} &= h \cdot A_{s_{12}} \cdot (T_{12} - T_{\text{infinity}}) + \epsilon \cdot \sigma \cdot A_{s_{12}} \cdot ((T_{12} + 273)^4 - T_{\text{surr}}^4)
\end{aligned}$$

k [W/m.C]	T_{tip} [C]	Q [W]
10	24.38	0.6889
30.53	25.32	1.156
51.05	27.28	1.482
71.58	29.65	1.745
92.11	32.1	1.969
112.6	34.51	2.166
133.2	36.82	2.341
153.7	39	2.498
174.2	41.06	2.641
194.7	42.98	2.772
215.3	44.79	2.892
235.8	46.48	3.003
256.3	48.07	3.106
276.8	49.56	3.202
297.4	50.96	3.291
317.9	52.28	3.374
338.4	53.52	3.452
358.9	54.69	3.526
379.5	55.8	3.595
400	56.86	3.66

ε	T_{tip} [C]	Q [W]
0.1	25.11	0.722
0.15	25.03	0.7333
0.2	24.96	0.7445
0.25	24.89	0.7555
0.3	24.82	0.7665
0.35	24.76	0.7773
0.4	24.7	0.7881
0.45	24.64	0.7987
0.5	24.59	0.8092
0.55	24.53	0.8197
0.6	24.48	0.83
0.65	24.43	0.8403
0.7	24.39	0.8504

0.75	24.34	0.8605
0.8	24.3	0.8705
0.85	24.26	0.8805
0.9	24.22	0.8904
0.95	24.18	0.9001
1	24.14	0.9099

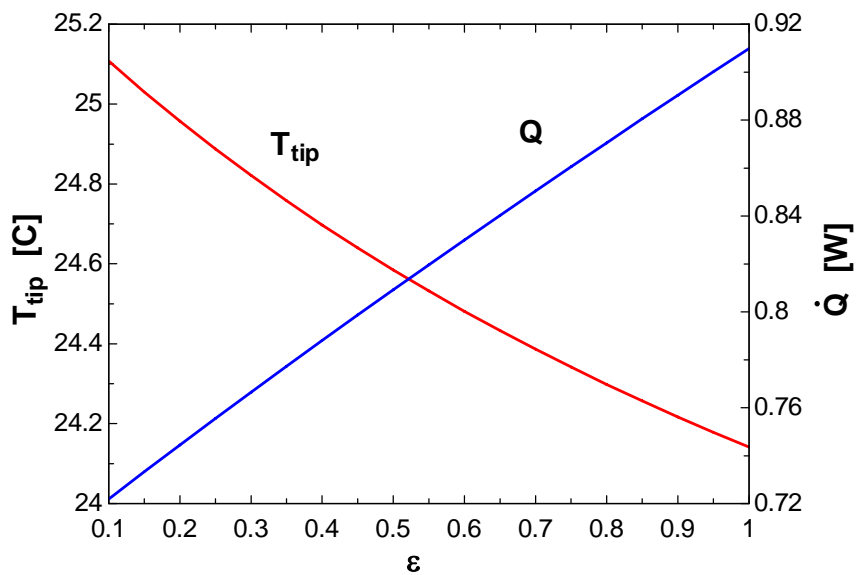
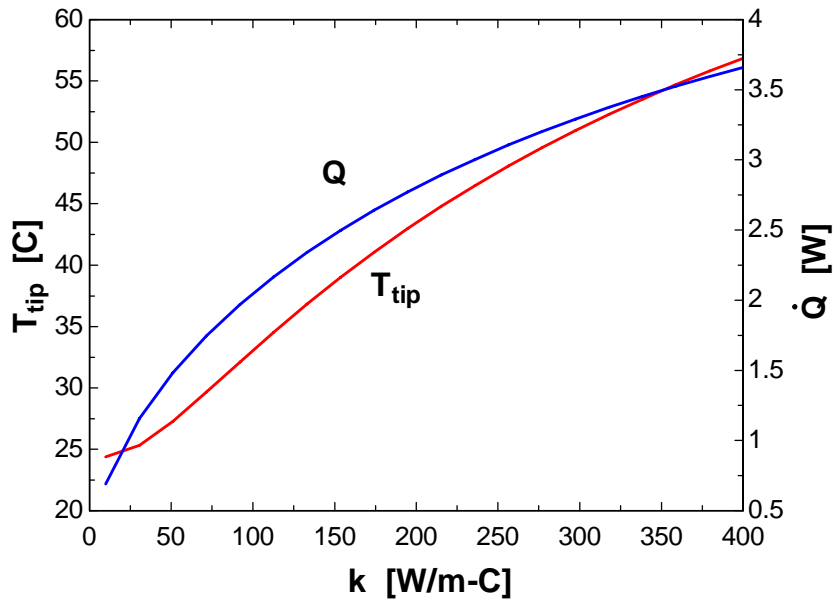

5-35 One side of a hot vertical plate is to be cooled by attaching aluminum fins of rectangular profile. The finite difference formulation of the problem for all nodes is to be obtained, and the nodal temperatures, the rate of heat transfer from a single fin and from the entire surface of the plate are to be determined.

Assumptions **1** Heat transfer along the fin is given to be steady and one-dimensional. **2** The thermal conductivity is constant. **3** Combined convection and radiation heat transfer coefficient is constant and uniform.

Properties The thermal conductivity is given to be $k = 237 \text{ W/m}\cdot\text{°C}$.

Analysis (a) The nodal spacing is given to be $\Delta x = 0.5$ cm. Then the number of nodes M becomes

$$M = \frac{L}{\Delta x} + 1 = \frac{2 \text{ cm}}{0.5 \text{ cm}} + 1 = 5$$

The base temperature at node 0 is given to be $T_0 = 80^\circ\text{C}$. This problem involves 4 unknown nodal temperatures, and thus we need to have 4 equations to determine them uniquely. Nodes 1, 2, and 3 are interior nodes, and thus for them we can use the general finite difference relation expressed as

$$kA \frac{T_{m-1} - T_m}{\Delta x} + kA \frac{T_{m+1} - T_m}{\Delta x} + h(p\Delta x)(T_\infty - T_m) = 0 \rightarrow T_{m-1} - 2T_m + T_{m+1} + h(p\Delta x^2 / kA)(T_\infty - T_m) = 0$$

The finite difference equation for node 4 at the fin tip is obtained by applying an energy balance on the half volume element about that node. Then,

$$m=1: T_0 - 2T_1 + T_2 + h(p\Delta x^2 / kA)(T_\infty - T_1) = 0$$

$$m=2: T_1 - 2T_2 + T_3 + h(p\Delta x^2 / kA)(T_\infty - T_2) = 0$$

$$m=3: T_2 - 2T_3 + T_4 + h(p\Delta x^2 / kA)(T_\infty - T_3) = 0$$

$$\text{Node 4: } kA \frac{T_3 - T_4}{\Delta x} + h(p\Delta x / 2 + A)(T_\infty - T_4) = 0$$

where $\Delta x = 0.005 \text{ m}$, $k = 237 \text{ W/m}\cdot\text{°C}$, $T_\infty = 35^\circ\text{C}$, $T_0 = 80^\circ\text{C}$, $h = 30 \text{ W/m}^2 \cdot \text{°C}$

and $A = (3 \text{ m})(0.003 \text{ m}) = 0.009 \text{ m}^2$ and $p = 2(3 + 0.003 \text{ m}) = 6.006 \text{ m}$.

This system of 4 equations with 4 unknowns constitute the finite difference formulation of the problem.

(b) The nodal temperatures under steady conditions are determined by solving the 4 equations above simultaneously with an equation solver to be

$$T_1 = 79.64^\circ\text{C}, \quad T_2 = 79.38^\circ\text{C}, \quad T_3 = 79.21^\circ\text{C}, \quad T_4 = 79.14^\circ\text{C}$$

(c) The rate of heat transfer from a single fin is simply the sum of the heat transfer from each nodal element,

$$\begin{aligned} \dot{Q}_{\text{fin}} &= \sum_{m=0}^4 \dot{Q}_{\text{element},m} = \sum_{m=0}^4 hA_{\text{surface},m}(T_m - T_\infty) \\ &= hp(\Delta x / 2)(T_0 - T_\infty) + hp\Delta x(T_1 + T_2 + T_3 - 3T_\infty) + h(p\Delta x / 2 + A)(T_4 - T_\infty) = 172 \text{ W} \end{aligned}$$

(d) The number of fins on the surface is

$$\text{No. of fins} = \frac{\text{Plate height}}{\text{Fin thickness} + \text{fin spacing}} = \frac{2 \text{ m}}{(0.003 + 0.004) \text{ m}} = 286 \text{ fins}$$

Then the rate of heat transfer from the fins, the unfinned portion, and the entire finned surface become

$$\dot{Q}_{\text{fin, total}} = (\text{No. of fins})\dot{Q}_{\text{fin}} = 286(172 \text{ W}) = 49,192 \text{ W}$$

$$\dot{Q}_{\text{unfinned}} = hA_{\text{unfinned}}(T_0 - T_\infty) = (30 \text{ W/m}^2 \cdot \text{°C})(286 \times 3 \text{ m} \times 0.004 \text{ m})(80 - 35)^\circ\text{C} = 4633 \text{ W}$$

$$\dot{Q}_{\text{total}} = \dot{Q}_{\text{fin, total}} + \dot{Q}_{\text{unfinned}} = 49,192 + 4633 = 53,825 \text{ W} \cong 53.8 \text{ kW}$$

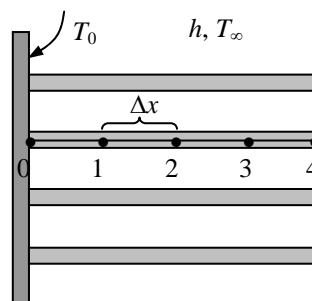

5-36 One side of a hot vertical plate is to be cooled by attaching aluminum pin fins. The finite difference formulation of the problem for all nodes is to be obtained, and the nodal temperatures, the rate of heat transfer from a single fin and from the entire surface of the plate are to be determined.

Assumptions **1** Heat transfer along the fin is given to be steady and one-dimensional. **2** The thermal conductivity is constant. **3** Combined convection and radiation heat transfer coefficient is constant and uniform.

Properties The thermal conductivity is given to be $k = 237 \text{ W/m}\cdot^\circ\text{C}$.

Analysis (a) The nodal spacing is given to be $\Delta x = 0.5 \text{ cm}$. Then the number of nodes M becomes

$$M = \frac{L}{\Delta x} + 1 = \frac{3 \text{ cm}}{0.5 \text{ cm}} + 1 = 7$$

The base temperature at node 0 is given to be $T_0 = 100^\circ\text{C}$. This problem involves 6 unknown nodal temperatures, and thus we need to have 6 equations to determine them uniquely. Nodes 1, 2, 3, 4, and 5 are interior nodes, and thus for them we can use the general finite difference relation expressed as

$$kA \frac{T_{m-1} - T_m}{\Delta x} + kA \frac{T_{m+1} - T_m}{\Delta x} + h(p\Delta x)(T_\infty - T_m) = 0 \rightarrow T_{m-1} - 2T_m + T_{m+1} + h(p\Delta x^2 / kA)(T_\infty - T_m) = 0$$

The finite difference equation for node 6 at the fin tip is obtained by applying an energy balance on the half volume element about that node. Then,

$$m=1: T_0 - 2T_1 + T_2 + h(p\Delta x^2 / kA)(T_\infty - T_1) = 0$$

$$m=2: T_1 - 2T_2 + T_3 + h(p\Delta x^2 / kA)(T_\infty - T_2) = 0$$

$$m=3: T_2 - 2T_3 + T_4 + h(p\Delta x^2 / kA)(T_\infty - T_3) = 0$$

$$m=4: T_3 - 2T_4 + T_5 + h(p\Delta x^2 / kA)(T_\infty - T_4) = 0$$

$$m=5: T_4 - 2T_5 + T_6 + h(p\Delta x^2 / kA)(T_\infty - T_5) = 0$$

$$\text{Node 6: } kA \frac{T_5 - T_6}{\Delta x} + h(p\Delta x / 2 + A)(T_\infty - T_6) = 0$$

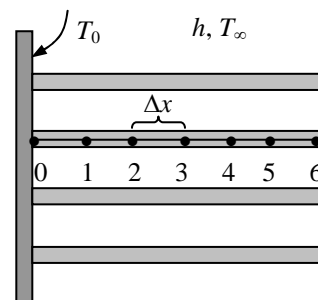

where $\Delta x = 0.005 \text{ m}$, $k = 237 \text{ W/m}\cdot^\circ\text{C}$, $T_\infty = 30^\circ\text{C}$, $T_0 = 100^\circ\text{C}$, $h = 35 \text{ W/m}^2\cdot^\circ\text{C}$

and $A = \pi D^2 / 4 = \pi(0.25 \text{ cm})^2 / 4 = 0.0491 \text{ cm}^2 = 0.0491 \times 10^{-4} \text{ m}^2$
 $p = \pi D = \pi(0.0025 \text{ m}) = 0.00785 \text{ m}$

(b) The nodal temperatures under steady conditions are determined by solving the 6 equations above simultaneously with an equation solver to be

$$T_1 = 97.9^\circ\text{C}, \quad T_2 = 96.1^\circ\text{C}, \quad T_3 = 94.7^\circ\text{C}, \quad T_4 = 93.8^\circ\text{C}, \quad T_5 = 93.1^\circ\text{C}, \quad T_6 = 92.9^\circ\text{C}$$

(c) The rate of heat transfer from a single fin is simply the sum of the heat transfer from the nodal elements,

$$\begin{aligned} \dot{Q}_{\text{fin}} &= \sum_{m=0}^6 \dot{Q}_{\text{element}, m} = \sum_{m=0}^6 hA_{\text{surface}, m} (T_m - T_\infty) \\ &= hp\Delta x / 2(T_0 - T_\infty) + hp\Delta x(T_1 + T_2 + T_3 + T_4 + T_5 - 5T_\infty) + h(p\Delta x / 2 + A)(T_6 - T_\infty) = \mathbf{0.5496 \text{ W}} \end{aligned}$$

(d) The number of fins on the surface is $\text{No. of fins} = \frac{1 \text{ m}^2}{(0.006 \text{ m})(0.006 \text{ m})} = 27,778 \text{ fins}$

Then the rate of heat transfer from the fins, the unfinned portion, and the entire finned surface become

$$\dot{Q}_{\text{fin, total}} = (\text{No. of fins})\dot{Q}_{\text{fin}} = 27,778(0.5496 \text{ W}) = 15,267 \text{ W}$$

$$\dot{Q}_{\text{unfinned}} = hA_{\text{unfinned}}(T_0 - T_\infty) = (35 \text{ W/m}^2\cdot^\circ\text{C})(1 - 27,778 \times 0.0491 \times 10^{-4} \text{ m}^2)(100 - 30)^\circ\text{C} = 2116 \text{ W}$$

$$\dot{Q}_{\text{total}} = \dot{Q}_{\text{fin, total}} + \dot{Q}_{\text{unfinned}} = 15,267 + 2116 = \mathbf{17,383 \text{ W} \cong 17.4 \text{ kW}}$$

5-37 One side of a hot vertical plate is to be cooled by attaching copper pin fins. The finite difference formulation of the problem for all nodes is to be obtained, and the nodal temperatures, the rate of heat transfer from a single fin and from the entire surface of the plate are to be determined.

Assumptions 1 Heat transfer along the fin is given to be steady and one-dimensional. **2** The thermal conductivity is constant. **3** Combined convection and radiation heat transfer coefficient is constant and uniform.

Properties The thermal conductivity is given to be $k = 386 \text{ W/m}\cdot^\circ\text{C}$.

Analysis (a) The nodal spacing is given to be $\Delta x = 0.5 \text{ cm}$. Then the number of nodes M becomes

$$M = \frac{L}{\Delta x} + 1 = \frac{3 \text{ cm}}{0.5 \text{ cm}} + 1 = 7$$

The base temperature at node 0 is given to be $T_0 = 100^\circ\text{C}$. This problem involves 6 unknown nodal temperatures, and thus we need to have 6 equations to determine them uniquely. Nodes 1, 2, 3, 4, and 5 are interior nodes, and thus for them we can use the general finite difference relation expressed as

$$kA \frac{T_{m-1} - T_m}{\Delta x} + kA \frac{T_{m+1} - T_m}{\Delta x} + h(p\Delta x)(T_\infty - T_m) = 0 \rightarrow T_{m-1} - 2T_m + T_{m+1} + h(p\Delta x^2 / kA)(T_\infty - T_m) = 0$$

The finite difference equation for node 6 at the fin tip is obtained by applying an energy balance on the half volume element about that node. Then,

$$m=1: T_0 - 2T_1 + T_2 + h(p\Delta x^2 / kA)(T_\infty - T_1) = 0$$

$$m=2: T_1 - 2T_2 + T_3 + h(p\Delta x^2 / kA)(T_\infty - T_2) = 0$$

$$m=3: T_2 - 2T_3 + T_4 + h(p\Delta x^2 / kA)(T_\infty - T_3) = 0$$

$$m=4: T_3 - 2T_4 + T_5 + h(p\Delta x^2 / kA)(T_\infty - T_4) = 0$$

$$m=5: T_4 - 2T_5 + T_6 + h(p\Delta x^2 / kA)(T_\infty - T_5) = 0$$

$$\text{Node 6: } kA \frac{T_5 - T_6}{\Delta x} + h(p\Delta x / 2 + A)(T_\infty - T_6) = 0$$

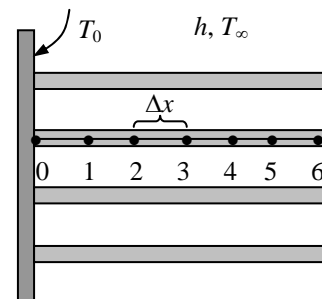

Where $\Delta x = 0.005 \text{ m}$, $k = 386 \text{ W/m}\cdot^\circ\text{C}$, $T_\infty = 30^\circ\text{C}$, $T_0 = 100^\circ\text{C}$, $h = 35 \text{ W/m}^2\cdot^\circ\text{C}$

and $A = \pi D^2 / 4 = \pi(0.25 \text{ cm})^2 / 4 = 0.0491 \text{ cm}^2 = 0.0491 \times 10^{-4} \text{ m}^2$
 $p = \pi D = \pi(0.0025 \text{ m}) = 0.00785 \text{ m}$

(b) The nodal temperatures under steady conditions are determined by solving the 6 equations above simultaneously with an equation solver to be

$$T_1 = 98.6^\circ\text{C}, \quad T_2 = 97.5^\circ\text{C}, \quad T_3 = 96.7^\circ\text{C}, \quad T_4 = 96.0^\circ\text{C}, \quad T_5 = 95.7^\circ\text{C}, \quad T_6 = 95.5^\circ\text{C}$$

(c) The rate of heat transfer from a single fin is simply the sum of the heat transfer from the nodal elements,

$$\begin{aligned} \dot{Q}_{\text{fin}} &= \sum_{m=0}^6 \dot{Q}_{\text{element}, m} = \sum_{m=0}^6 hA_{\text{surface}, m} (T_m - T_\infty) \\ &= hp\Delta x / 2(T_0 - T_\infty) + hp\Delta x(T_1 + T_2 + T_3 + T_4 + T_5 - 5T_\infty) + h(p\Delta x / 2 + A)(T_6 - T_\infty) = \mathbf{0.5641 \text{ W}} \end{aligned}$$

(d) The number of fins on the surface is $\text{No. of fins} = \frac{1 \text{ m}^2}{(0.006 \text{ m})(0.006 \text{ m})} = 27,778 \text{ fins}$

Then the rate of heat transfer from the fins, the unfinned portion, and the entire finned surface become

$$\dot{Q}_{\text{fin, total}} = (\text{No. of fins})\dot{Q}_{\text{fin}} = 27,778(0.5641 \text{ W}) = 15,670 \text{ W}$$

$$\dot{Q}_{\text{unfinned}} = hA_{\text{unfinned}}(T_0 - T_\infty) = (35 \text{ W/m}^2\cdot^\circ\text{C})(1 - 27,778 \times 0.0491 \times 10^{-4} \text{ m}^2)(100 - 30)^\circ\text{C} = 2116 \text{ W}$$

$$\dot{Q}_{\text{total}} = \dot{Q}_{\text{fin, total}} + \dot{Q}_{\text{unfinned}} = 15,670 + 2116 = \mathbf{17,786 \text{ W} \cong 17.8 \text{ kW}}$$

5-38 Two cast iron steam pipes are connected to each other through two 1-cm thick flanges, and heat is lost from the flanges by convection and radiation. The finite difference formulation of the problem for all nodes is to be obtained, and the temperature of the tip of the flange as well as the rate of heat transfer from the exposed surfaces of the flange are to be determined.

Assumptions 1 Heat transfer through the flange is stated to be steady and one-dimensional. **2** The thermal conductivity and emissivity are constants. **3** Convection heat transfer coefficient is constant and uniform.

Properties The thermal conductivity and emissivity are given to be $k = 52 \text{ W/m}\cdot^\circ\text{C}$ and $\varepsilon = 0.8$.

Analysis (a) The distance between nodes 0 and 1 is the thickness of the pipe, $\Delta x_1 = 0.4 \text{ cm} = 0.004 \text{ m}$. The nodal spacing along the flange is given to be $\Delta x_2 = 1 \text{ cm} = 0.01 \text{ m}$. Then the number of nodes M becomes

$$M = \frac{L}{\Delta x} + 2 = \frac{5 \text{ cm}}{1 \text{ cm}} + 2 = 7$$

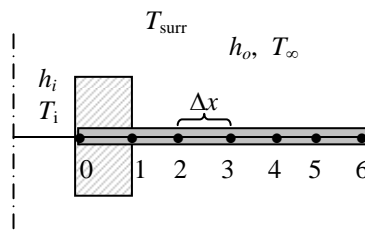

This problem involves 7 unknown nodal temperatures, and thus we need to have 7 equations to determine them uniquely. Noting that the total thickness of the flange is $t = 0.02 \text{ m}$, the heat conduction area at any location along the flange is $A_{\text{cond}} = 2\pi r t$ where the values of radii at the nodes and between the nodes (the mid points) are

$$r_0 = 0.046 \text{ m}, r_1 = 0.05 \text{ m}, r_2 = 0.06 \text{ m}, r_3 = 0.07 \text{ m}, r_4 = 0.08 \text{ m}, r_5 = 0.09 \text{ m}, r_6 = 0.10 \text{ m}$$

$$r_{01} = 0.048 \text{ m}, r_{12} = 0.055 \text{ m}, r_{23} = 0.065 \text{ m}, r_{34} = 0.075 \text{ m}, r_{45} = 0.085 \text{ m}, r_{56} = 0.095 \text{ m}$$

Then the finite difference equations for each node are obtained from the energy balance to be as follows:

$$\text{Node 0: } h_i(2\pi r_0)(T_i - T_0) + k(2\pi r_{01})\frac{T_1 - T_0}{\Delta x_1} = 0$$

Node 1:

$$k(2\pi r_{01})\frac{T_0 - T_1}{\Delta x_1} + k(2\pi r_{12})\frac{T_2 - T_1}{\Delta x_2} + 2[2\pi(r_1 + r_{12})/2](\Delta x_2/2)\{h(T_\infty - T_1) + \varepsilon\sigma[T_{\text{surr}}^4 - (T_1 + 273)^4]\} = 0$$

$$\text{Node 2: } k(2\pi r_{12})\frac{T_1 - T_2}{\Delta x_2} + k(2\pi r_{23})\frac{T_3 - T_2}{\Delta x_2} + 2(2\pi r_2 \Delta x_2)\{h(T_\infty - T_2) + \varepsilon\sigma[T_{\text{surr}}^4 - (T_2 + 273)^4]\} = 0$$

$$\text{Node 3: } k(2\pi r_{23})\frac{T_2 - T_3}{\Delta x_2} + k(2\pi r_{34})\frac{T_4 - T_3}{\Delta x_2} + 2(2\pi r_3 \Delta x_2)\{h(T_\infty - T_3) + \varepsilon\sigma[T_{\text{surr}}^4 - (T_3 + 273)^4]\} = 0$$

$$\text{Node 4: } k(2\pi r_{34})\frac{T_3 - T_4}{\Delta x_2} + k(2\pi r_{45})\frac{T_5 - T_4}{\Delta x_2} + 2(2\pi r_4 \Delta x_2)\{h(T_\infty - T_4) + \varepsilon\sigma[T_{\text{surr}}^4 - (T_4 + 273)^4]\} = 0$$

$$\text{Node 5: } k(2\pi r_{45})\frac{T_4 - T_5}{\Delta x_2} + k(2\pi r_{56})\frac{T_6 - T_5}{\Delta x_2} + 2(2\pi r_5 \Delta x_2)\{h(T_\infty - T_5) + \varepsilon\sigma[T_{\text{surr}}^4 - (T_5 + 273)^4]\} = 0$$

$$\text{Node 6: } k(2\pi r_{56})\frac{T_5 - T_6}{\Delta x_2} + 2[2\pi(\Delta x_2/2)(r_{56} + r_6)/2 + 2\pi r_6 t]\{h(T_\infty - T_6) + \varepsilon\sigma[T_{\text{surr}}^4 - (T_6 + 273)^4]\} = 0$$

where $\Delta x_1 = 0.004 \text{ m}$, $\Delta x_2 = 0.01 \text{ m}$, $k = 52 \text{ W/m}\cdot^\circ\text{C}$, $\varepsilon = 0.8$, $T_\infty = 8^\circ\text{C}$, $T_{\text{in}} = 200^\circ\text{C}$, $T_{\text{surr}} = 290 \text{ K}$ and $h = 25 \text{ W/m}^2\cdot^\circ\text{C}$, $h_i = 180 \text{ W/m}^2\cdot^\circ\text{C}$, $\sigma = 5.67 \times 10^{-8} \text{ W/m}^2\cdot\text{K}^4$.

The system of 7 equations with 7 unknowns constitutes the finite difference formulation of the problem.

(b) The nodal temperatures under steady conditions are determined by solving the 7 equations above simultaneously with an equation solver to be

$$T_0 = 119.7^\circ\text{C}, T_1 = 118.6^\circ\text{C}, T_2 = 116.3^\circ\text{C}, T_3 = 114.3^\circ\text{C}, T_4 = 112.7^\circ\text{C}, T_5 = 111.2^\circ\text{C}, \text{ and } T_6 = \mathbf{109.9^\circ\text{C}}$$

(c) Knowing the inner surface temperature, the rate of heat transfer from the flange under steady conditions is simply the rate of heat transfer from the steam to the pipe at flange section

$$\dot{Q}_{\text{fin}} = \sum_{m=1}^6 \dot{Q}_{\text{element}, m} = \sum_{m=1}^6 h A_{\text{surface}, m} (T_m - T_\infty) + \sum_{m=1}^6 \varepsilon \sigma A_{\text{surface}, m} [(T_m + 273)^4 - T_{\text{surr}}^4] = \mathbf{83.6 \text{ W}}$$

where $A_{\text{surface}, m}$ are as given above for different nodes.

5-39 EES Prob. 5-38 is reconsidered. The effects of the steam temperature and the outer heat transfer coefficient on the flange tip temperature and the rate of heat transfer from the exposed surfaces of the flange are to be investigated.

Analysis The problem is solved using EES, and the solution is given below.

"GIVEN"

t_pipe=0.004 [m]
 k=52 [W/m-C]
 epsilon=0.8
 D_o_pipe=0.10 [m]
 t_flange=0.01 [m]
 D_o_flange=0.20 [m]
 T_steam=200 [C]
 h_i=180 [W/m^2-C]
 T_infinity=8 [C]
 h=25 [W/m^2-C]
 T_surr=290 [K]
 DELTAX=0.01 [m]
 sigma=5.67E-8 [W/m^2-K^4] "Stefan-Boltzmann constant"

"ANALYSIS"

"(b)"

DELTAx_1=t_pipe "the distance between nodes 0 and 1"

DELTAx_2=t_flange "nodal spacing along the flange"

L=(D_o_flange-D_o_pipe)/2

M=L/DELTAx_2+2 "Number of nodes"

t=2*t_flange "total thixkness of the flange"

"The values of radii at the nodes and between the nodes /-(the midpoints) are"

r_0=0.046 "[m]"

r_1=0.05 "[m]"

r_2=0.06 "[m]"

r_3=0.07 "[m]"

r_4=0.08 "[m]"

r_5=0.09 "[m]"

r_6=0.10 "[m]"

r_01=0.048 "[m]"

r_12=0.055 "[m]"

r_23=0.065 "[m]"

r_34=0.075 "[m]"

r_45=0.085 "[m]"

r_56=0.095 "[m]"

"Using the finite difference method, the five equations for the unknown temperatures at 7 nodes are determined to be"

$h_i(2\pi r_0)(T_{\text{steam}}-T_0)+k(2\pi r_{01})(T_1-T_0)/\text{DELTA}x_1=0$ "node 0"

$k(2\pi r_{01})(T_0-T_1)/\text{DELTA}x_1+k(2\pi r_{12})(T_2-T_1)/\text{DELTA}x_2+2\pi(r_1+r_{12})/2(\text{DELTA}x_2/2)(h(T_{\text{infinity}}-T_1)+\epsilon\sigma(T_{\text{surr}}^4-(T_1+273)^4))=0$ "node 1"

$k(2\pi r_{12})(T_1-T_2)/\text{DELTA}x_2+k(2\pi r_{23})(T_3-T_2)/\text{DELTA}x_2+2\pi r_2\text{DELTA}x_2(h(T_{\text{infinity}}-T_2)+\epsilon\sigma(T_{\text{surr}}^4-(T_2+273)^4))=0$ "node 2"

$k(2\pi r_{23})(T_2-T_3)/\text{DELTA}x_2+k(2\pi r_{34})(T_4-T_3)/\text{DELTA}x_2+2\pi r_3\text{DELTA}x_2(h(T_{\text{infinity}}-T_3)+\epsilon\sigma(T_{\text{surr}}^4-(T_3+273)^4))=0$ "node 3"

$$k*(2*\pi*t*r_{34})*(T_3-T_4)/\Delta T_{x_2}+k*(2*\pi*t*r_{45})*(T_5-T_4)/\Delta T_{x_2}+2*2*\pi*t*r_4*\Delta T_{x_2}*(h*(T_{\infty}-T_4)+\epsilon*\sigma*(T_{surr}^4-(T_4+273)^4))=0 \text{ "node 4"}$$

$$k*(2*\pi*t*r_{45})*(T_4-T_5)/\Delta T_{x_2}+k*(2*\pi*t*r_{56})*(T_6-T_5)/\Delta T_{x_2}+2*2*\pi*t*r_5*\Delta T_{x_2}*(h*(T_{\infty}-T_5)+\epsilon*\sigma*(T_{surr}^4-(T_5+273)^4))=0 \text{ "node 5"}$$

$$k*(2*\pi*t*r_{56})*(T_5-T_6)/\Delta T_{x_2}+2*(2*\pi*t*(r_{56}+r_6)/2*(\Delta T_{x_2}/2)+2*\pi*t*r_6)*(h*(T_{\infty}-T_6)+\epsilon*\sigma*(T_{surr}^4-(T_6+273)^4))=0 \text{ "node 6"}$$

$$T_{tip}=T_6$$

"(c)"

$$Q_{dot}=Q_{dot_1}+Q_{dot_2}+Q_{dot_3}+Q_{dot_4}+Q_{dot_5}+Q_{dot_6} \text{ "where"}$$

$$Q_{dot_1}=h*2*2*\pi*t*(r_1+r_{12})/2*\Delta T_{x_2}/2*(T_1-T_{\infty})+\epsilon*\sigma*2*2*\pi*t*(r_1+r_{12})/2*\Delta T_{x_2}/2*((T_1+273)^4-T_{surr}^4)$$

$$Q_{dot_2}=h*2*2*\pi*t*r_2*\Delta T_{x_2}/2*(T_2-T_{\infty})+\epsilon*\sigma*2*2*\pi*t*r_2*\Delta T_{x_2}/2*((T_2+273)^4-T_{surr}^4)$$

$$Q_{dot_3}=h*2*2*\pi*t*r_3*\Delta T_{x_2}/2*(T_3-T_{\infty})+\epsilon*\sigma*2*2*\pi*t*r_3*\Delta T_{x_2}/2*((T_3+273)^4-T_{surr}^4)$$

$$Q_{dot_4}=h*2*2*\pi*t*r_4*\Delta T_{x_2}/2*(T_4-T_{\infty})+\epsilon*\sigma*2*2*\pi*t*r_4*\Delta T_{x_2}/2*((T_4+273)^4-T_{surr}^4)$$

$$Q_{dot_5}=h*2*2*\pi*t*r_5*\Delta T_{x_2}/2*(T_5-T_{\infty})+\epsilon*\sigma*2*2*\pi*t*r_5*\Delta T_{x_2}/2*((T_5+273)^4-T_{surr}^4)$$

$$Q_{dot_6}=h*2*(2*\pi*t*(r_{56}+r_6)/2*(\Delta T_{x_2}/2)+2*\pi*t*r_6)*(T_6-T_{\infty})+\epsilon*\sigma*2*(2*\pi*t*(r_{56}+r_6)/2*(\Delta T_{x_2}/2)+2*\pi*t*r_6)*((T_6+273)^4-T_{surr}^4)$$

$T_{steam} [C]$	$T_{tip} [C]$	$Q [W]$
150	84.42	60.83
160	89.57	65.33
170	94.69	69.85
180	99.78	74.4
190	104.8	78.98
200	109.9	83.58
210	114.9	88.21
220	119.9	92.87
230	124.8	97.55
240	129.7	102.3
250	134.6	107
260	139.5	111.8
270	144.3	116.6
280	149.1	121.4
290	153.9	126.2
300	158.7	131.1

$h [W/m^2.C]$	$T_{tip} [C]$	$Q [W]$
15	126.5	68.18
20	117.6	76.42
25	109.9	83.58
30	103.1	89.85
35	97.17	95.38
40	91.89	100.3

45	87.17	104.7
50	82.95	108.6
55	79.14	112.1
60	75.69	115.3

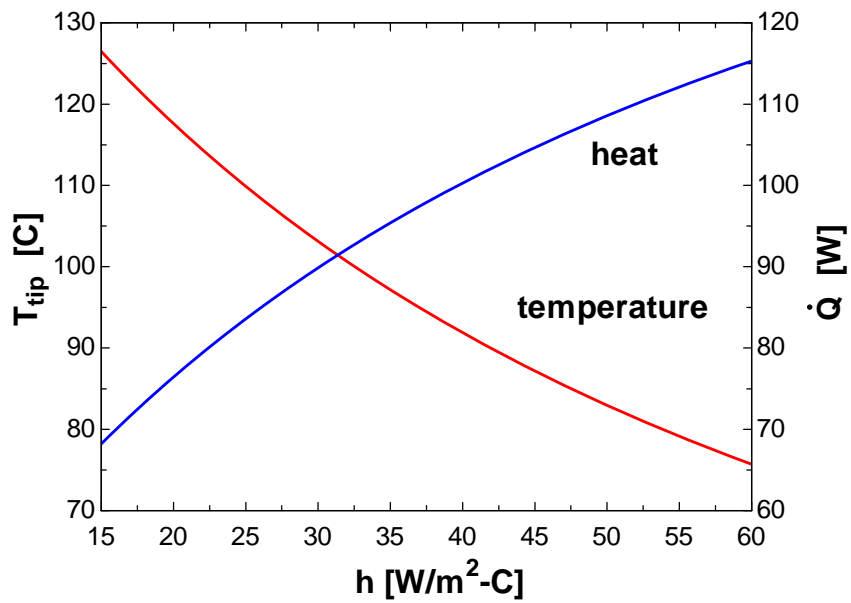
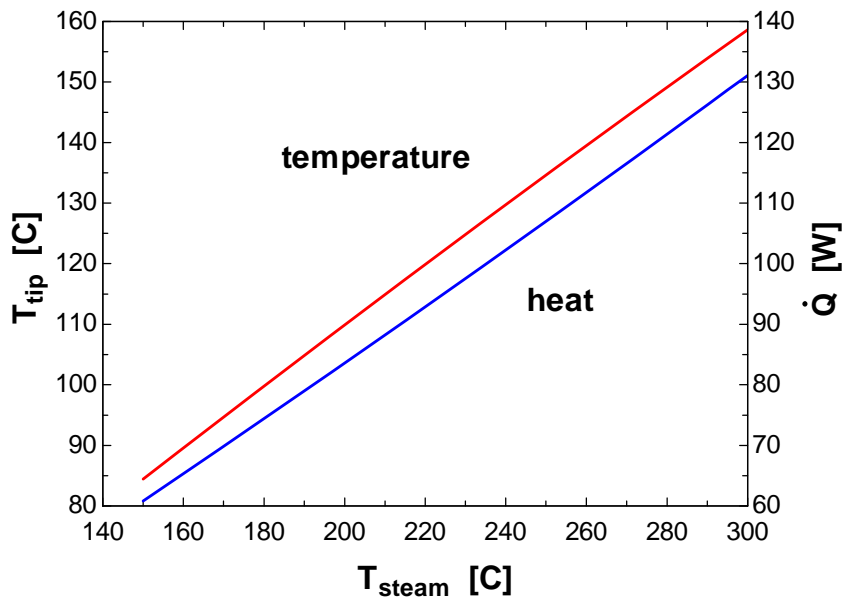

5-40 EES Using EES, the solutions of the systems of algebraic equations are determined to be as follows:

"(a)"

$$\begin{aligned} 3x_1 - x_2 + 3x_3 &= 0 \\ -x_1 + 2x_2 + x_3 &= 3 \\ 2x_1 - x_2 - x_3 &= 2 \end{aligned}$$

Solution: $x_1 = 2, x_2 = 3, x_3 = -1$

"(b)"

$$\begin{aligned} 4x_1 - 2x_2^2 + 0.5x_3 &= -2 \\ x_1^3 - x_2 + x_3 &= 11.964 \\ x_1 + x_2 + x_3 &= 3 \end{aligned}$$

Solution: $x_1 = 2.33, x_2 = 2.29, x_3 = -1.62$

5-41 EES Using EES, the solutions of the systems of algebraic equations are determined to be as follows:

"(a)"

$$\begin{aligned} 3x_1 + 2x_2 - x_3 + x_4 &= 6 \\ x_1 + 2x_2 - x_4 &= -3 \\ -2x_1 + x_2 + 3x_3 + x_4 &= 2 \\ 3x_2 + x_3 - 4x_4 &= -6 \end{aligned}$$

Solution: $x_1 = 13, x_2 = -9, x_3 = 13, x_4 = -2$

"(b)"

$$\begin{aligned} 3x_1 + x_2^2 + 2x_3 &= 8 \\ -x_1^2 + 3x_2 + 2x_3 &= -6.293 \\ 2x_1 - x_2^4 + 4x_3 &= -12 \end{aligned}$$

Solution: $x_1 = 2.825, x_2 = 1.791, x_3 = -1.841$

5-42 EES Using EES, the solutions of the systems of algebraic equations are determined to be as follows:

"(a)"

$$\begin{aligned} 4x_1 - x_2 + 2x_3 + x_4 &= -6 \\ x_1 + 3x_2 - x_3 + 4x_4 &= -1 \\ -x_1 + 2x_2 + 5x_4 &= 5 \\ 2x_2 - 4x_3 - 3x_4 &= -5 \end{aligned}$$

Solution: $x_1 = -2, x_2 = -1, x_3 = 0, x_4 = 1$

"(b)"

$$\begin{aligned} 2x_1 + x_2^4 - 2x_3 + x_4 &= 1 \\ x_1^2 + 4x_2 + 2x_3^2 - 2x_4 &= -3 \\ -x_1 + x_2^4 + 5x_3 &= 10 \\ 3x_1 - x_3^2 + 8x_4 &= 15 \end{aligned}$$

Solution: $x_1 = 0.263, x_2 = -1.15, x_3 = 1.70, x_4 = 2.14$

Two-Dimensional Steady Heat Conduction

5-43C For a medium in which the finite difference formulation of a general interior node is given in its simplest form as $T_{\text{left}} + T_{\text{top}} + T_{\text{right}} + T_{\text{bottom}} - 4T_{\text{node}} + \frac{\dot{e}_{\text{node}} l^2}{k} = 0$:

(a) Heat transfer is steady, (b) heat transfer is two-dimensional, (c) there is heat generation in the medium, (d) the nodal spacing is constant, and (e) the thermal conductivity of the medium is constant.

5-44C For a medium in which the finite difference formulation of a general interior node is given in its simplest form as $T_{\text{node}} = (T_{\text{left}} + T_{\text{top}} + T_{\text{right}} + T_{\text{bottom}}) / 4$:

(a) Heat transfer is steady, (b) heat transfer is two-dimensional, (c) there is no heat generation in the medium, (d) the nodal spacing is constant, and (e) the thermal conductivity of the medium is constant.

5-45C A region that cannot be filled with simple volume elements such as strips for a plane wall, and rectangular elements for two-dimensional conduction is said to have *irregular boundaries*. A practical way of dealing with such geometries in the finite difference method is to replace the elements bordering the irregular geometry by a series of simple volume elements.

5-46 Two dimensional ridges are machined on the cold side of a heat exchanger. The smallest section of the wall is to be identified. A two-dimensional grid is to be constructed and the unknown temperatures in the grid are to be determined.

Assumptions 1 Heat transfer through the body is given to be steady and two-dimensional. 2 Thermal conductivity is constant. 3 There is no heat generation.

Analysis (a) From symmetry, the smallest domain is between the top and the base of one ridge.

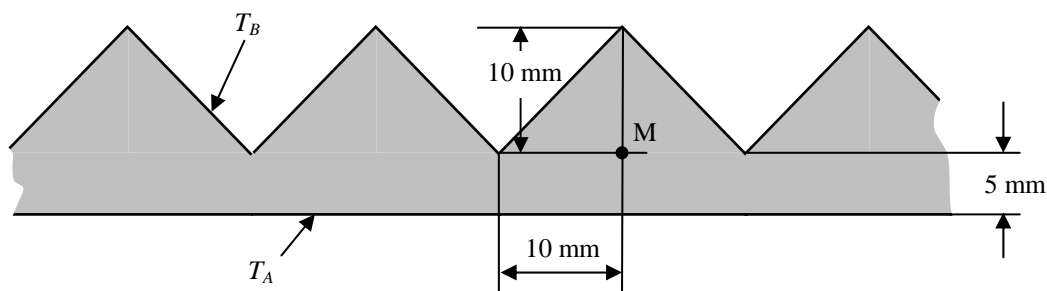

(b) The unknown temperatures at nodes 1, 2, and 3 are to be determined from finite difference formulations

Node 1:

$$k \frac{T_B - T_1}{\Delta x} \Delta x + k \frac{T_2 - T_1}{\Delta x} \frac{\Delta x}{2} + k \frac{T_B - T_1}{\Delta x} \frac{\Delta x}{2} = 0$$

$$2T_B - 2T_1 + T_2 - T_1 + T_B - T_1 = 0$$

$$4T_1 - T_2 = 3T_B = 3 \times 10 = 30$$

Node 2:

$$k \frac{T_1 - T_2}{\Delta x} \frac{\Delta x}{2} + k \frac{T_3 - T_2}{\Delta x} \Delta x + k \frac{T_A - T_2}{\Delta x} \frac{\Delta x}{2} = 0$$

$$T_1 - T_2 + 2T_3 - 2T_2 + T_A - T_2 = 0$$

$$-T_1 + 4T_2 - 2T_3 = T_A = 90$$

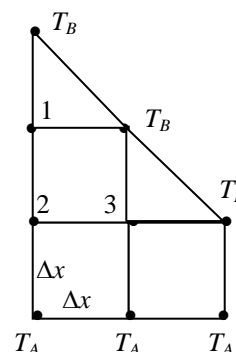

Node 3:

$$4T_3 = T_2 + T_A + T_B + T_B$$

$$-T_2 + 4T_3 = 2T_B + T_A = 2 \times 10 + 90 = 110$$

The matrix equation is

$$\begin{bmatrix} 4 & -1 & 0 \\ -1 & 4 & -2 \\ 0 & -1 & 4 \end{bmatrix} \begin{bmatrix} T_1 \\ T_2 \\ T_3 \end{bmatrix} = \begin{bmatrix} 30 \\ 90 \\ 110 \end{bmatrix}$$

(c) The temperature T_2 is 46.9°C . Then the temperatures T_1 and T_3 are determined from equations 1 and 3.

$$4T_1 - T_2 = 30$$

$$4T_1 - 46.9 = 30 \longrightarrow T_1 = \mathbf{19.2^\circ\text{C}}$$

$$-T_2 + 4T_3 = 110$$

$$-46.9 + 4T_3 = 110 \longrightarrow T_3 = \mathbf{39.2^\circ\text{C}}$$

5-47 A long tube involves two-dimensional heat transfer. The matrix equation is to be written and simplified and the rate of heat loss from the tube is to be determined.

Assumptions 1 Heat transfer from the tube is steady and two-dimensional. 2 Thermal conductivity is constant. 3 There is uniform heat generation.

Analysis (a) The unknown temperatures at nodes 4, 5, and 7 are to be determined from finite difference formulations:

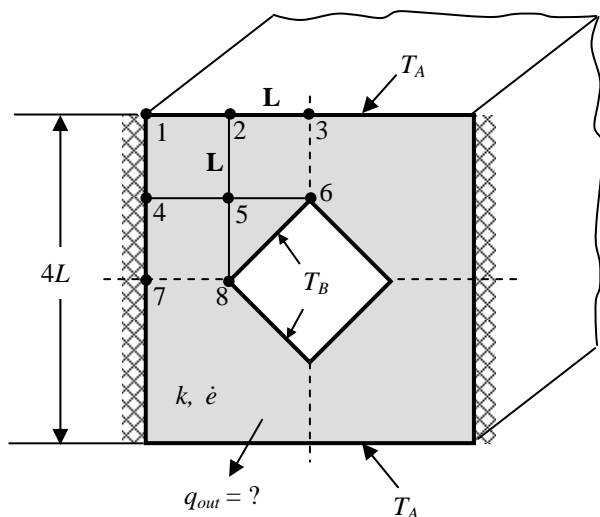

Grid point	T (°C)
1	20
2	20
3	20
4	71.4
5	92.9
6	100
7	105.7
8	100

Node 4:

$$k \frac{T_1 - T_4}{L} \frac{L}{2} + k \frac{T_5 - T_4}{L} L + k \frac{T_7 - T_4}{L} \frac{L}{2} + \dot{e} \frac{L^2}{2} = 0$$

$$(T_1 - T_4) + 2(T_5 - T_4) + (T_7 - T_4) + \dot{e} \frac{L^2}{k} = 0$$

$$-4T_4 + 2T_5 + T_7 = -T_A - \dot{e} \frac{L^2}{k}$$

Node 5:

$$k \frac{T_2 - T_5}{L} L + k \frac{T_6 - T_5}{L} L + k \frac{T_8 - T_5}{L} L + k \frac{T_4 - T_5}{L} L + \dot{e} L^2 = 0$$

$$(T_2 - T_5) + (T_6 - T_5) + (T_8 - T_5) + (T_4 - T_5) + \dot{e} \frac{L^2}{k} = 0$$

$$T_4 - 4T_5 = -T_A - 2T_B - \dot{e} \frac{L^2}{k}$$

Node 7:

$$k \frac{T_4 - T_7}{L} \frac{L}{2} + k \frac{T_8 - T_7}{L} \frac{L}{2} + \dot{e} \frac{L^2}{4} = 0$$

$$(T_4 - T_7) + (T_8 - T_7) + \dot{e} \frac{L^2}{2k} = 0$$

$$T_4 - 2T_7 = -T_B - \dot{e} \frac{L^2}{2k}$$

The matrix equation is

$$\begin{bmatrix} 4 & -2 & -1 \\ -1 & 4 & 0 \\ -1 & 0 & 2 \end{bmatrix} \begin{bmatrix} T_4 \\ T_5 \\ T_7 \end{bmatrix} = \begin{bmatrix} T_A + \dot{e}L^2 / k \\ T_A + 2T_B + \dot{e}L^2 / k \\ T_B + \dot{e}L^2 / 2k \end{bmatrix} = \begin{bmatrix} 100 \\ 300 \\ 140 \end{bmatrix}$$

(b) The rate of heat transfer per unit length is determined as follows

$$q_{\text{out},1} = k \frac{T_4 - T_1}{L} \frac{L}{2} + k \frac{T_3 - T_1}{L} \frac{L}{2} + \dot{e} \frac{L^2}{4} = \frac{10}{2} \frac{(71.4 - 10)}{0.04} + 0 + (5 \times 10^5) \frac{(0.04)^2}{4} = 457 \text{ W/m}$$

$$\begin{aligned} q_{\text{out},2} &= k \frac{T_5 - T_2}{L} L + k \frac{T_1 - T_2}{L} \frac{L}{2} + k \frac{T_3 - T_2}{L} \frac{L}{2} + \dot{e} \frac{L^2}{2} \\ &= (10)(92.9 - 20) + 0 + 0 + (5 \times 10^5) \frac{(0.04)^2}{2} = 1129 \text{ W/m} \end{aligned}$$

$$q_{\text{out},3} = k \frac{T_6 - T_3}{k} \frac{L}{2} + k \frac{T_2 - T_3}{L} \frac{L}{2} + \dot{e} \frac{L^2}{4} = \frac{10}{2} (100 - 20) + 0 + (5 \times 10^5) \frac{(0.04)^2}{4} = 600 \text{ W/m}$$

$$q_{\text{out}} = 4(q_{\text{out},1} + q_{\text{out},2} + q_{\text{out},3}) = 4(457 + 1129 + 600) = \mathbf{8744 \text{ W/m}}$$

5-48 A long solid body is subjected to steady two-dimensional heat transfer. The unknown nodal temperatures and the rate of heat loss from the bottom surface through a 1-m long section are to be determined.

Assumptions 1 Heat transfer through the body is given to be steady and two-dimensional. **2** Heat is generated uniformly in the body. **3** Radiation heat transfer is negligible.

Properties The thermal conductivity is given to be $k = 45 \text{ W/m}\cdot^\circ\text{C}$.

Analysis The nodal spacing is given to be $\Delta x = \Delta y = l = 0.05 \text{ m}$, and the general finite difference form of an interior node for steady two-dimensional heat conduction is expressed as

$$T_{\text{left}} + T_{\text{top}} + T_{\text{right}} + T_{\text{bottom}} - 4T_{\text{node}} + \frac{\dot{e}_{\text{node}} l^2}{k} = 0$$

where

$$\frac{\dot{e}_{\text{node}} l^2}{k} = \frac{\dot{e}_0 l^2}{k} = \frac{(4 \times 10^6 \text{ W/m}^3)(0.05 \text{ m})^2}{45 \text{ W/m}\cdot^\circ\text{C}} = 222.2^\circ\text{C}$$

The finite difference equations for boundary nodes are obtained by applying an energy balance on the volume elements and taking the direction of all heat transfers to be towards the node under consideration:

$$\text{Node 1 (convection): } k \frac{l}{2} \frac{240 - T_1}{l} + kl \frac{290 - T_1}{l} + k \frac{l}{2} \frac{325 - T_1}{l} + hl(T_\infty - T_1) + \frac{\dot{e}_0 l^2}{2k} = 0$$

$$\text{Node 2 (interior): } 350 + 290 + 325 + 290 - 4T_2 + \frac{\dot{e}_0 l^2}{k} = 0$$

$$\text{Node 3 (interior): } 260 + 290 + 240 + 200 - 4T_3 + \frac{\dot{e}_0 l^2}{k} = 0$$

where $k = 45 \text{ W/m}\cdot^\circ\text{C}$, $h = 50 \text{ W/m}^2\cdot^\circ\text{C}$, $\dot{e} = 4 \times 10^6 \text{ W/m}^3$, $T_\infty = 20^\circ\text{C}$

Substituting, $T_1 = 280.3^\circ\text{C}$, $T_2 = 369.3^\circ\text{C}$, $T_3 = 303.1^\circ\text{C}$,

(b) The rate of heat loss from the bottom surface through a 1-m long section is

$$\begin{aligned} \dot{Q} &= \sum_m \dot{Q}_{\text{element},m} = \sum_m hA_{\text{surface},m} (T_m - T_\infty) \\ &= h(l/2)(200 - T_\infty) + hl(240 - T_\infty) + hl(T_1 - T_\infty) + h(l/2)(325 - T_\infty) \\ &= (50 \text{ W/m}^2 \cdot ^\circ\text{C})(0.05 \text{ m} \times 1 \text{ m})[(200 - 20)/2 + (240 - 20) + (280.3 - 20) + (325 - 20)/2]^\circ\text{C} = \mathbf{1807 \text{ W}} \end{aligned}$$

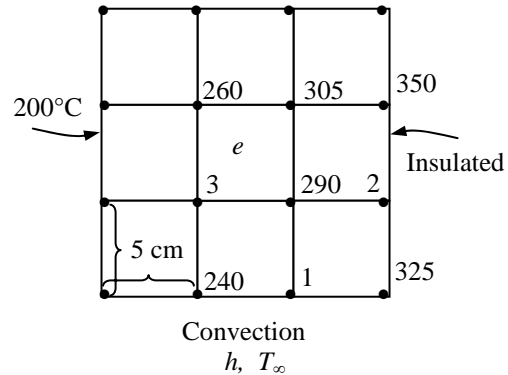

5-49 A long solid body is subjected to steady two-dimensional heat transfer. The unknown nodal temperatures are to be determined.

Assumptions **1** Heat transfer through the body is given to be steady and two-dimensional. **2** There is no heat generation in the body.

Properties The thermal conductivity is given to be $k = 45 \text{ W/m}\cdot\text{C}$.

Analysis The nodal spacing is given to be $\Delta x = \Delta y = l = 0.02 \text{ m}$, and the general finite difference form of an interior node for steady two-dimensional heat conduction for the case of no heat generation is expressed as

$$T_{\text{left}} + T_{\text{top}} + T_{\text{right}} + T_{\text{bottom}} - 4T_{\text{node}} = 0 \rightarrow T_{\text{node}} = (T_{\text{left}} + T_{\text{top}} + T_{\text{right}} + T_{\text{bottom}}) / 4$$

There is symmetry about the horizontal, vertical, and diagonal lines passing through the midpoint, and thus we need to consider only $1/8^{\text{th}}$ of the region. Then,

$$T_1 = T_3 = T_7 = T_9$$

$$T_2 = T_4 = T_6 = T_8$$

Therefore, there are only 3 unknown nodal temperatures, T_1, T_2 , and T_5 , and thus we need only 3 equations to determine them uniquely. Also, we can replace the symmetry lines by insulation and utilize the mirror-image concept when writing the finite difference equations for the interior nodes.

$$\text{Node 1 (interior): } T_1 = (180 + 180 + 2T_2) / 4$$

$$\text{Node 2 (interior): } T_2 = (200 + T_5 + 2T_1) / 4$$

$$\text{Node 5 (interior): } T_5 = 4T_2 / 4 = T_2$$

Solving the equations above simultaneously gives

$$T_1 = T_3 = T_7 = T_9 = \mathbf{185^\circ\text{C}}$$

$$T_2 = T_4 = T_6 = T_8 = \mathbf{190^\circ\text{C}}$$

Discussion Note that taking advantage of symmetry simplified the problem greatly.

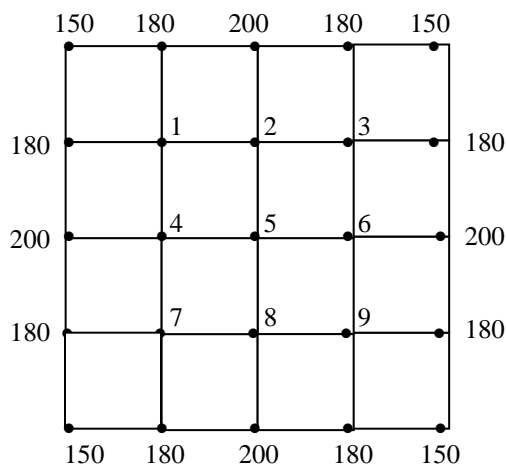

5-50 A long solid body is subjected to steady two-dimensional heat transfer. The unknown nodal temperatures are to be determined.

Assumptions **1** Heat transfer through the body is given to be steady and two-dimensional. **2** There is no heat generation in the body.

Properties The thermal conductivity is given to be $k = 20 \text{ W/m}\cdot^\circ\text{C}$.

Analysis The nodal spacing is given to be $\Delta x = \Delta y = l = 0.01 \text{ m}$, and the general finite difference form of an interior node for steady two-dimensional heat conduction for the case of no heat generation is expressed as

$$T_{\text{left}} + T_{\text{top}} + T_{\text{right}} + T_{\text{bottom}} - 4T_{\text{node}} = 0 \rightarrow T_{\text{node}} = (T_{\text{left}} + T_{\text{top}} + T_{\text{right}} + T_{\text{bottom}}) / 4$$

(a) There is symmetry about the insulated surfaces as well as about the diagonal line. Therefore $T_3 = T_2$, and T_1, T_2 , and T_4 are the only 3 unknown nodal temperatures. Thus we need only 3 equations to determine them uniquely. Also, we can replace the symmetry lines by insulation and utilize the mirror-image concept when writing the finite difference equations for the interior nodes.

$$\text{Node 1 (interior): } T_1 = (180 + 180 + T_2 + T_3) / 4$$

$$\text{Node 2 (interior): } T_2 = (200 + T_4 + 2T_1) / 4$$

$$\text{Node 4 (interior): } T_4 = (2T_2 + 2T_3) / 4$$

$$\text{Also, } T_3 = T_2$$

Solving the equations above simultaneously gives

$$T_2 = T_3 = T_4 = \mathbf{190^\circ\text{C}}$$

$$T_1 = \mathbf{185^\circ\text{C}}$$

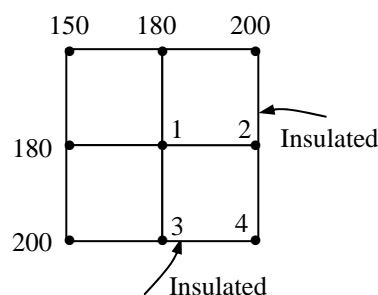

(b) There is symmetry about the insulated surface as well as the diagonal line. Replacing the symmetry lines by insulation, and utilizing the mirror-image concept, the finite difference equations for the interior nodes can be written as

$$\text{Node 1 (interior): } T_1 = (120 + 120 + T_2 + T_3) / 4$$

$$\text{Node 2 (interior): } T_2 = (120 + 120 + T_4 + T_1) / 4$$

$$\text{Node 3 (interior): } T_3 = (140 + 2T_1 + T_4) / 4 = T_2$$

$$\text{Node 4 (interior): } T_4 = (2T_2 + 140 + 2T_3) / 4$$

Solving the equations above simultaneously gives

$$T_1 = T_2 = \mathbf{122.9^\circ\text{C}}$$

$$T_3 = T_4 = \mathbf{128.6^\circ\text{C}}$$

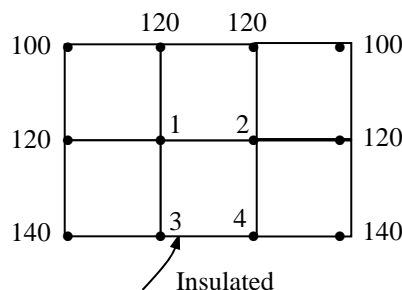

Discussion Note that taking advantage of symmetry simplified the problem greatly.

5-51 Starting with an energy balance on a volume element, the steady two-dimensional finite difference equation for a general interior node in rectangular coordinates for $T(x, y)$ for the case of variable thermal conductivity and uniform heat generation is to be obtained.

Analysis We consider a *volume element* of size $\Delta x \times \Delta y \times 1$ centered about a general interior node (m, n) in a region in which heat is generated at a constant rate of \dot{e} and the thermal conductivity k is variable (see Fig. 5-24 in the text). Assuming the direction of heat conduction to be *towards* the node under consideration at all surfaces, the energy balance on the volume element can be expressed as

$$\dot{Q}_{\text{cond, left}} + \dot{Q}_{\text{cond, top}} + \dot{Q}_{\text{cond, right}} + \dot{Q}_{\text{cond, bottom}} + \dot{G}_{\text{element}} = \frac{\Delta E_{\text{element}}}{\Delta t} = 0$$

for the *steady* case. Again assuming the temperatures between the adjacent nodes to vary linearly and noting that the heat transfer area is $\Delta y \times 1$ in the x direction and $\Delta x \times 1$ in the y direction, the energy balance relation above becomes

$$k_{m,n}(\Delta y \times 1) \frac{T_{m-1,n} - T_{m,n}}{\Delta x} + k_{m,n}(\Delta x \times 1) \frac{T_{m,n+1} - T_{m,n}}{\Delta y} + k_{m,n}(\Delta y \times 1) \frac{T_{m+1,n} - T_{m,n}}{\Delta x} + k_{m,n}(\Delta x \times 1) \frac{T_{m,n-1} - T_{m,n}}{\Delta y} + \dot{e}_0(\Delta x \times \Delta y \times 1) = 0$$

Dividing each term by $\Delta x \times \Delta y \times 1$ and simplifying gives

$$\frac{T_{m-1,n} - 2T_{m,n} + T_{m+1,n}}{\Delta x^2} + \frac{T_{m,n-1} - 2T_{m,n} + T_{m,n+1}}{\Delta y^2} + \frac{\dot{e}_0}{k_{m,n}} = 0$$

For a square mesh with $\Delta x = \Delta y = l$, and the relation above simplifies to

$$T_{m-1,n} + T_{m+1,n} + T_{m,n-1} + T_{m,n+1} - 4T_{m,n} + \frac{\dot{e}_0 l^2}{k_{m,n}} = 0$$

It can also be expressed in the following easy-to-remember form

$$T_{\text{left}} + T_{\text{top}} + T_{\text{right}} + T_{\text{bottom}} - 4T_{\text{node}} + \frac{\dot{e}_0 l^2}{k_{\text{node}}} = 0$$

5-52 A long solid body is subjected to steady two-dimensional heat transfer. The unknown nodal temperatures and the rate of heat loss from the top surface are to be determined.

Assumptions 1 Heat transfer through the body is given to be steady and two-dimensional. **2** Heat is generated uniformly in the body.

Properties The thermal conductivity is given to be $k = 180 \text{ W/m}\cdot^\circ\text{C}$.

Analysis (a) The nodal spacing is given to be $\Delta x = \Delta y = l = 0.1 \text{ m}$, and the general finite difference form of an interior node equation for steady two-dimensional heat conduction for the case of constant heat generation is expressed as

$$T_{\text{left}} + T_{\text{top}} + T_{\text{right}} + T_{\text{bottom}} - 4T_{\text{node}} + \frac{\dot{e}_{\text{node}} l^2}{k} = 0$$

There is symmetry about a vertical line passing through the middle of the region, and thus we need to consider only half of the region. Then,

$$T_1 = T_2 \quad \text{and} \quad T_3 = T_4$$

Therefore, there are only 2 unknown nodal temperatures, T_1 and T_3 , and thus we need only 2 equations to determine them uniquely. Also, we can replace the symmetry lines by insulation and utilize the mirror-image concept when writing the finite difference equations for the interior nodes.

$$\text{Node 1 (interior):} \quad 100 + 120 + T_2 + T_3 - 4T_1 + \frac{\dot{e} l^2}{k} = 0$$

$$\text{Node 3 (interior):} \quad 150 + 200 + T_1 + T_4 - 4T_3 + \frac{\dot{e} l^2}{k} = 0$$

Noting that $T_1 = T_2$ and $T_3 = T_4$ and substituting,

$$220 + T_3 - 3T_1 + \frac{(10^7 \text{ W/m}^3)(0.1 \text{ m})^2}{180 \text{ W/m}\cdot^\circ\text{C}} = 0$$

$$350 + T_1 - 3T_3 + \frac{(10^7 \text{ W/m}^3)(0.1 \text{ m})^2}{180 \text{ W/m}\cdot^\circ\text{C}} = 0$$

The solution of the above system is

$$T_1 = T_2 = \mathbf{404^\circ\text{C}}$$

$$T_3 = T_4 = \mathbf{436.5^\circ\text{C}}$$

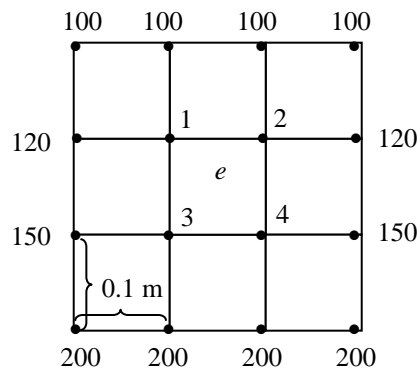

(b) The total rate of heat transfer from the top surface \dot{Q}_{top} can be determined from an energy balance on a volume element at the top surface whose height is $l/2$, length 0.3 m , and depth 1 m :

$$\dot{Q}_{\text{top}} + \dot{e}_0(0.3 \times 1 \times l/2) + \left(2k \frac{l \times 1}{2} \frac{120 - 100}{l} + 2kl \times 1 \frac{T_1 - 100}{l} \right) = 0$$

$$\begin{aligned} \dot{Q}_{\text{top}} &= -(10^7 \text{ W/m}^3)(0.3 \times 0.1/2) \text{ m}^3 - 2(180 \text{ W/m}\cdot^\circ\text{C}) \left(\frac{1 \text{ m}}{2} (120 - 100)^\circ\text{C} + (1 \text{ m})(404 - 100)^\circ\text{C} \right) \\ &= \mathbf{263,040 \text{ W}} \quad (\text{per } m \text{ depth}) \end{aligned}$$

5-53 EES Prob. 5-52 is reconsidered. The effects of the thermal conductivity and the heat generation rate on the temperatures at nodes 1 and 3, and the rate of heat loss from the top surface are to be investigated.

Analysis The problem is solved using EES, and the solution is given below.

"GIVEN"

$$k=180 \text{ [W/m}\cdot\text{C]}$$

$$e_{\text{dot}}=1\text{E}7 \text{ [W/m}^3\text{]}$$

$$\text{DELTA}x=0.10 \text{ [m]}$$

$$\text{DELTA}y=0.10 \text{ [m]}$$

$$d=1 \text{ [m]} \text{ "depth"}$$

"Temperatures at the selected nodes are also given in the figure"

"ANALYSIS"

"(a)"

$$l=\text{DELTA}x$$

$$T_1=T_2 \text{ "due to symmetry"}$$

$$T_3=T_4 \text{ "due to symmetry"}$$

"Using the finite difference method, the two equations for the two unknown temperatures are determined to be"

$$120+120+T_2+T_3-4\cdot T_1+(e_{\text{dot}}\cdot l^2)/k=0$$

$$150+200+T_1+T_4-4\cdot T_3+(e_{\text{dot}}\cdot l^2)/k=0$$

"(b)"

"The rate of heat loss from the top surface can be determined from an energy balance on a volume element whose height is $l/2$, length $3\cdot l$, and depth $d=1 \text{ m}$ "

$$-Q_{\text{dot_top}}+e_{\text{dot}}\cdot(3\cdot l\cdot d\cdot l/2)+2\cdot(k\cdot(l\cdot d)/2\cdot(120-100)/l+k\cdot l\cdot d\cdot(T_1-100)/l)=0$$

k [W/m.C]	T₁ [C]	T₃ [C]	Q_{top} [W]
10	5134	5161	250875
30.53	1772	1799	252671
51.05	1113	1141	254467
71.58	832.3	859.8	256263
92.11	676.6	704.1	258059
112.6	577.7	605.2	259855
133.2	509.2	536.7	261651
153.7	459.1	486.6	263447
174.2	420.8	448.3	265243
194.7	390.5	418	267039
215.3	366	393.5	268836
235.8	345.8	373.3	270632
256.3	328.8	356.3	272428
276.8	314.4	341.9	274224
297.4	301.9	329.4	276020
317.9	291	318.5	277816
338.4	281.5	309	279612
358.9	273	300.5	281408
379.5	265.5	293	283204
400	258.8	286.3	285000

e [W/m^3]	T_1 [C]	T_3 [C]	Q_{top} [W]
100000	136.5	164	18250
5.358E+06	282.6	310.1	149697
1.061E+07	428.6	456.1	281145
1.587E+07	574.7	602.2	412592
2.113E+07	720.7	748.2	544039
2.639E+07	866.8	894.3	675487
3.165E+07	1013	1040	806934
3.691E+07	1159	1186	938382
4.216E+07	1305	1332	1.070E+06
4.742E+07	1451	1479	1.201E+06
5.268E+07	1597	1625	1.333E+06
5.794E+07	1743	1771	1.464E+06
6.319E+07	1889	1917	1.596E+06
6.845E+07	2035	2063	1.727E+06
7.371E+07	2181	2209	1.859E+06
7.897E+07	2327	2355	1.990E+06
8.423E+07	2473	2501	2.121E+06
8.948E+07	2619	2647	2.253E+06
9.474E+07	2765	2793	2.384E+06
1.000E+08	2912	2939	2.516E+06

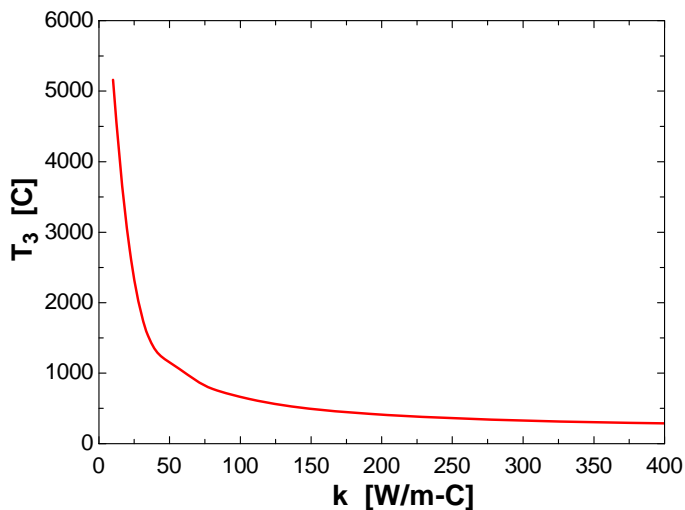
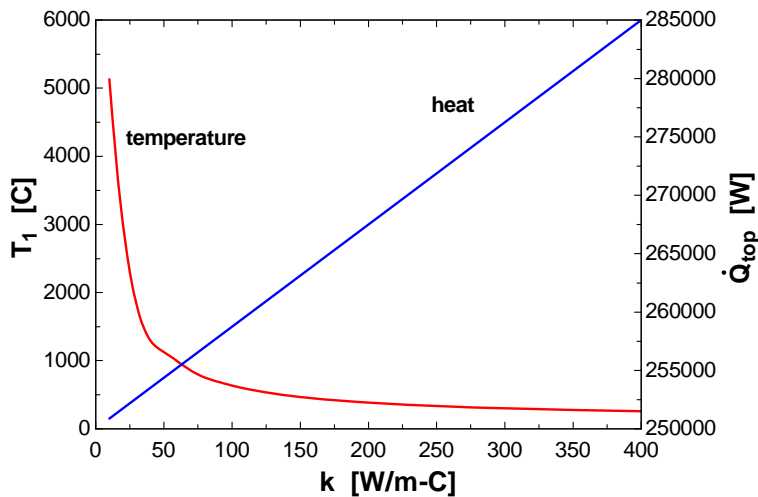

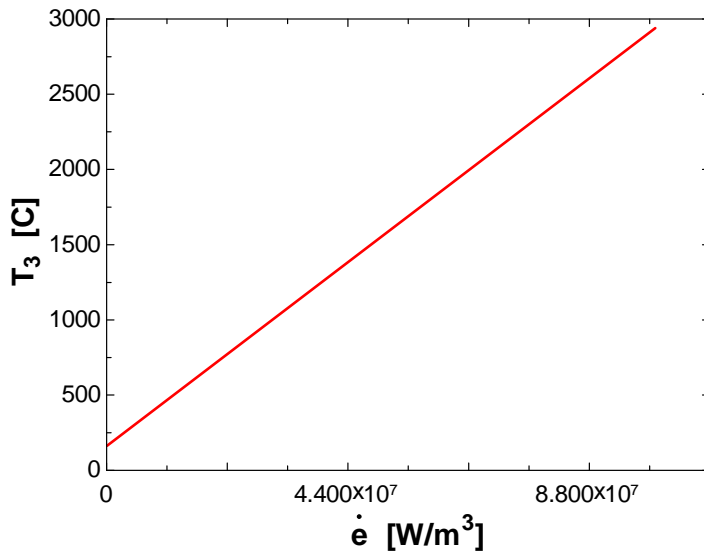
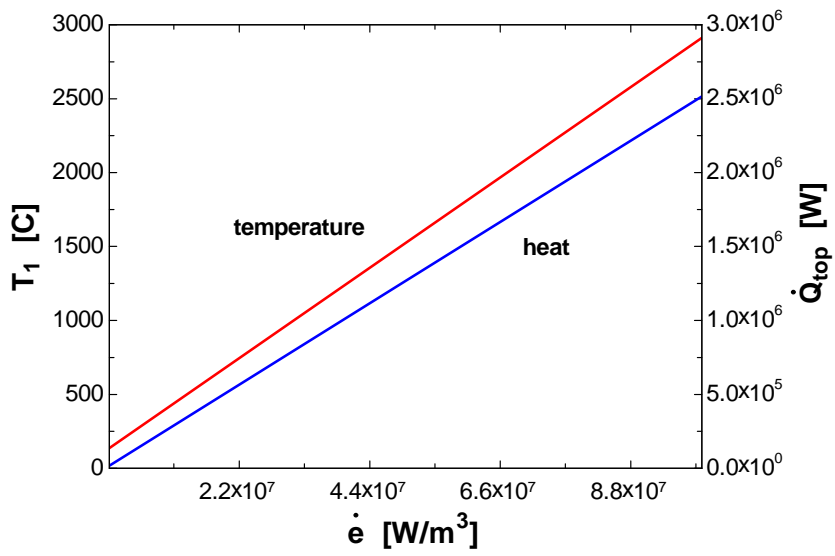

5-54 A long solid body is subjected to steady two-dimensional heat transfer. The unknown nodal temperatures are to be determined.

Assumptions **1** Heat transfer through the body is given to be steady and two-dimensional. **2** There is no heat generation in the body.

Properties The thermal conductivity is given to be $k = 20 \text{ W/m}\cdot^\circ\text{C}$.

Analysis The nodal spacing is given to be $\Delta x = \Delta y = l = 0.01 \text{ m}$, and the general finite difference form of an interior node for steady two-dimensional heat conduction for the case of no heat generation is expressed as

$$T_{\text{left}} + T_{\text{top}} + T_{\text{right}} + T_{\text{bottom}} - 4T_{\text{node}} + \frac{\dot{e}_{\text{node}} l^2}{k} = 0 \longrightarrow T_{\text{left}} + T_{\text{top}} + T_{\text{right}} + T_{\text{bottom}} - 4T_{\text{node}} = 0$$

(a) There is symmetry about a vertical line passing through the nodes 1 and 3. Therefore, $T_3 = T_2$, $T_6 = T_4$, and T_1, T_2, T_4 , and T_5 are the only 4 unknown nodal temperatures, and thus we need only 4 equations to determine them uniquely. Also, we can replace the symmetry lines by insulation and utilize the mirror-image concept when writing the finite difference equations for the interior nodes.

$$\begin{aligned} \text{Node 1 (interior):} & \quad 150 + 150 + 2T_2 - 4T_1 = 0 \\ \text{Node 2 (interior):} & \quad 200 + T_1 + T_5 + T_4 - 4T_2 = 0 \\ \text{Node 4 (interior):} & \quad 250 + 250 + T_2 + T_2 - 4T_4 = 0 \\ \text{Node 5 (interior):} & \quad 4T_2 - 4T_5 = 0 \end{aligned}$$

Solving the 4 equations above simultaneously gives

$$\begin{aligned} T_1 &= \mathbf{175^\circ\text{C}} \\ T_2 = T_3 &= \mathbf{200^\circ\text{C}} \\ T_4 = T_6 &= \mathbf{225^\circ\text{C}} \\ T_5 &= \mathbf{200^\circ\text{C}} \end{aligned}$$

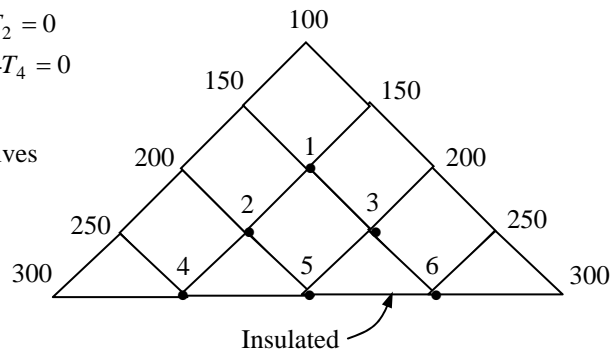

(b) There is symmetry about a vertical line passing through the middle. Therefore, $T_3 = T_2$ and $T_4 = T_1$. Replacing the symmetry lines by insulation and utilizing the mirror-image concept, the finite difference equations for the interior nodes 1 and 2 are determined to be

$$\begin{aligned} \text{Node 1 (interior):} & \quad 50 + 150 + 2T_2 - 4T_1 = 0 \\ \text{Node 2 (interior):} & \quad 50 + 50 + 150 + T_1 - 4T_2 = 0 \end{aligned}$$

Solving the 2 equations above simultaneously gives

$$T_1 = T_4 = \mathbf{92.9^\circ\text{C}}, \quad T_2 = T_3 = \mathbf{85.7^\circ\text{C}}$$

Discussion Note that taking advantage of symmetry simplified the problem greatly.

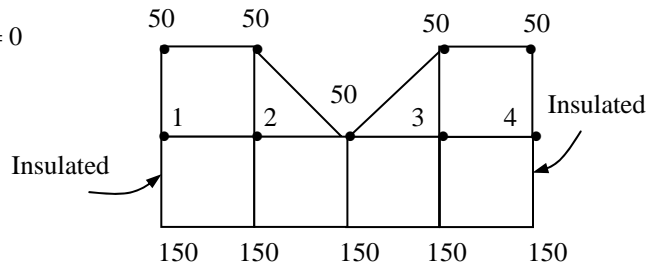

5-55 Heat conduction through a long L-shaped solid bar with specified boundary conditions is considered. The unknown nodal temperatures are to be determined with the finite difference method.

Assumptions 1 Heat transfer through the body is given to be steady and two-dimensional. 2 Thermal conductivity is constant. 3 Heat generation is uniform.

Properties The thermal conductivity is given to be $k = 45 \text{ W/m}\cdot^\circ\text{C}$.

Analysis (a) The nodal spacing is given to be $\Delta x = \Delta y = l = 0.015 \text{ m}$, and the general finite difference form of an interior node for steady two-dimensional heat conduction for the case of constant heat generation is expressed as

$$T_{\text{left}} + T_{\text{top}} + T_{\text{right}} + T_{\text{bottom}} - 4T_{\text{node}} + \frac{\dot{e}_{\text{node}} l^2}{k} = 0$$

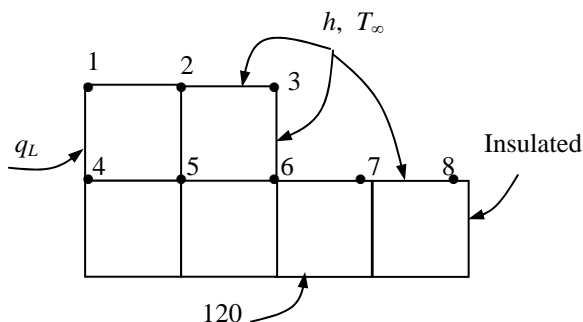

We observe that all nodes are boundary nodes except node 5 that is an interior node. Therefore, we will have to rely on energy balances to obtain the finite difference equations. Using energy balances, the finite difference equations for each of the 8 nodes are obtained as follows:

$$\text{Node 1: } \dot{q}_L \frac{l}{2} + h \frac{l}{2} (T_\infty - T_1) + k \frac{l}{2} \frac{T_2 - T_1}{l} + k \frac{l}{2} \frac{T_4 - T_1}{l} + \dot{e}_0 \frac{l^2}{4} = 0$$

$$\text{Node 2: } hl(T_\infty - T_2) + k \frac{l}{2} \frac{T_1 - T_2}{l} + k \frac{l}{2} \frac{T_3 - T_2}{l} + kl \frac{T_5 - T_2}{l} + \dot{e}_0 \frac{l^2}{2} = 0$$

$$\text{Node 3: } hl(T_\infty - T_3) + k \frac{l}{2} \frac{T_2 - T_3}{l} + k \frac{l}{2} \frac{T_6 - T_3}{l} + \dot{e}_0 \frac{l^2}{4} = 0$$

$$\text{Node 4: } \dot{q}_L l + k \frac{l}{2} \frac{T_1 - T_4}{l} + k \frac{l}{2} \frac{120 - T_4}{l} + kl \frac{T_5 - T_4}{l} + \dot{e}_0 \frac{l^2}{2} = 0$$

$$\text{Node 5: } T_4 + T_2 + T_6 + 120 - 4T_5 + \frac{\dot{e}_0 l^2}{k} = 0$$

$$\text{Node 6: } hl(T_\infty - T_6) + k \frac{l}{2} \frac{T_3 - T_6}{l} + kl \frac{T_5 - T_6}{l} + kl \frac{120 - T_6}{l} + k \frac{l}{2} \frac{T_7 - T_6}{l} + \dot{e}_0 \frac{3l^2}{4} = 0$$

$$\text{Node 7: } hl(T_\infty - T_7) + k \frac{l}{2} \frac{T_6 - T_7}{l} + k \frac{l}{2} \frac{T_8 - T_7}{l} + kl \frac{120 - T_7}{l} + \dot{e}_0 \frac{l^2}{2} = 0$$

$$\text{Node 8: } h \frac{l}{2} (T_\infty - T_8) + k \frac{l}{2} \frac{T_7 - T_8}{l} + k \frac{l}{2} \frac{120 - T_8}{l} + \dot{e}_0 \frac{l^2}{4} = 0$$

where $\dot{e}_0 = 5 \times 10^6 \text{ W/m}^3$, $\dot{q}_L = 8000 \text{ W/m}^2$, $l = 0.015 \text{ m}$, $k = 45 \text{ W/m}\cdot^\circ\text{C}$, $h = 55 \text{ W/m}^2\cdot^\circ\text{C}$, and $T_\infty = 30^\circ\text{C}$. This system of 8 equations with 8 unknowns is the finite difference formulation of the problem.

(b) The 8 nodal temperatures under steady conditions are determined by solving the 8 equations above simultaneously with an equation solver to be

$$T_1 = 163.6^\circ\text{C}, \quad T_2 = 160.5^\circ\text{C}, \quad T_3 = 156.4^\circ\text{C}, \quad T_4 = 154.0^\circ\text{C}, \quad T_5 = 151.0^\circ\text{C}, \quad T_6 = 144.4^\circ\text{C}, \\ T_7 = 134.5^\circ\text{C}, \quad T_8 = 132.6^\circ\text{C}$$

Discussion The accuracy of the solution can be improved by using more nodal points.

5-56E A long solid bar is subjected to steady two-dimensional heat transfer. The unknown nodal temperatures and the rate of heat loss from the bar through a 1-ft long section are to be determined.

Assumptions 1 Heat transfer through the body is given to be steady and two-dimensional. 2 Heat is generated uniformly in the body. 3 The heat transfer coefficient also includes the radiation effects.

Properties The thermal conductivity is given to be $k = 16 \text{ Btu/h}\cdot\text{ft}\cdot^\circ\text{C}$.

Analysis The nodal spacing is given to be $\Delta x = \Delta y = l = 0.25 \text{ ft}$, and the general finite difference form of an interior node for steady two-dimensional heat conduction is expressed as

$$T_{\text{left}} + T_{\text{top}} + T_{\text{right}} + T_{\text{bottom}} - 4T_{\text{node}} + \frac{\dot{e}_{\text{node}} l^2}{k} = 0$$

(a) There is symmetry about the vertical, horizontal, and diagonal lines passing through the center. Therefore, $T_1 = T_3 = T_7 = T_9$ and $T_2 = T_4 = T_6 = T_8$, and T_1, T_2 , and T_5 are the only 3 unknown nodal temperatures, and thus we need only 3 equations to determine them uniquely. Also, we can replace the symmetry lines by insulation and utilize the mirror-image concept for the interior nodes.

The finite difference equations for boundary nodes are obtained by applying an energy balance on the volume elements and taking the direction of all heat transfers to be towards the node under consideration:

$$\text{Node 1 (convection): } 2k \frac{l}{2} \frac{T_2 - T_1}{l} + 2h \frac{l}{2} (T_\infty - T_1) + \frac{\dot{e}_0 l^2}{4} = 0$$

$$\text{Node 2 (convection): } 2k \frac{l}{2} \frac{T_1 - T_2}{l} + kl \frac{T_5 - T_2}{l} + hl(T_\infty - T_2) + \frac{\dot{e}_0 l^2}{2} = 0$$

$$\text{Node 5 (interior): } 4T_2 - 4T_5 + \frac{\dot{e}_0 l^2}{k} = 0$$

where $\dot{e}_0 = 0.19 \times 10^5 \text{ Btu/h}\cdot\text{ft}^3$, $l = 0.25 \text{ ft}$, $k = 16 \text{ Btu/h}\cdot\text{ft}\cdot^\circ\text{F}$, $h = 7.9 \text{ Btu/h}\cdot\text{ft}^2\cdot^\circ\text{F}$, and $T_\infty = 70^\circ\text{F}$. The 3 nodal temperatures under steady conditions are determined by solving the 3 equations above simultaneously with an equation solver to be

$$T_1 = T_3 = T_7 = T_9 = \mathbf{361.89^\circ\text{F}},$$

$$T_2 = T_4 = T_6 = T_8 = \mathbf{379.37^\circ\text{F}}, \quad T_5 = \mathbf{397.93^\circ\text{F}}$$

(b) The rate of heat loss from the bar through a 1-ft long section is determined from an energy balance on one-eighth section of the bar, and multiplying the result by 8:

$$\begin{aligned} \dot{Q} &= 8 \times \dot{Q}_{\text{one-eighth section, conv}} = 8 \times \left[h \frac{l}{2} (T_1 - T_\infty) + h \frac{l}{2} (T_2 - T_\infty) \right] (1 \text{ ft}) = 8 \times h \frac{l}{2} [T_1 + T_2 - 2T_\infty] (1 \text{ ft}) \\ &= 8(7.9 \text{ Btu/h}\cdot\text{ft}^2\cdot^\circ\text{F})(0.25/2 \text{ ft})(1 \text{ ft})[361.89 + 379.37 - 2 \times 70]^\circ\text{F} \\ &= \mathbf{4750 \text{ Btu/h}} \quad (\text{per ft length}) \end{aligned}$$

Discussion Under steady conditions, the rate of heat loss from the bar is equal to the rate of heat generation within the bar per unit length, and is determined to be

$$\dot{Q} = \dot{E}_{\text{gen}} = \dot{e}_0 V = (0.19 \times 10^5 \text{ Btu/h}\cdot\text{ft}^3)(0.5 \text{ ft} \times 0.5 \text{ ft} \times 1 \text{ ft}) = 4750 \text{ Btu/h} \quad (\text{per ft length})$$

which confirms the results obtained by the finite difference method.

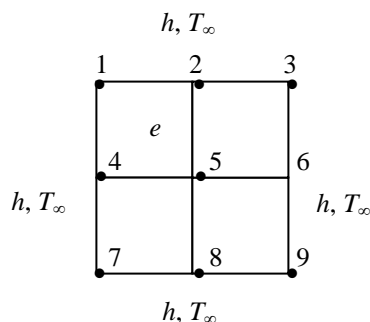

5-57 Heat transfer through a square chimney is considered. The nodal temperatures and the rate of heat loss per unit length are to be determined with the finite difference method.

Assumptions 1 Heat transfer is given to be steady and two-dimensional since the height of the chimney is large relative to its cross-section, and thus heat conduction through the chimney in the axial direction is negligible. It is tempting to simplify the problem further by considering heat transfer in each wall to be one dimensional which would be the case if the walls were thin and thus the corner effects were negligible. This assumption cannot be justified in this case since the walls are very thick and the corner sections constitute a considerable portion of the chimney structure. **2** There is no heat generation in the chimney. **3** Thermal conductivity is constant.

Properties The thermal conductivity and emissivity are given to be $k = 1.4 \text{ W/m}\cdot^\circ\text{C}$ and $\epsilon = 0.9$.

Analysis (a) The most striking aspect of this problem is the apparent symmetry about the horizontal and vertical lines passing through the midpoint of the chimney. Therefore, we need to consider only one-fourth of the geometry in the solution whose nodal network consists of 10 equally spaced nodes. No heat can cross a symmetry line, and thus symmetry lines can be treated as insulated surfaces and thus “mirrors” in the finite-difference formulation. Considering a unit depth and using the energy balance approach for the boundary nodes (again assuming all heat transfer to be into the volume element for convenience), the finite difference formulation is obtained to be

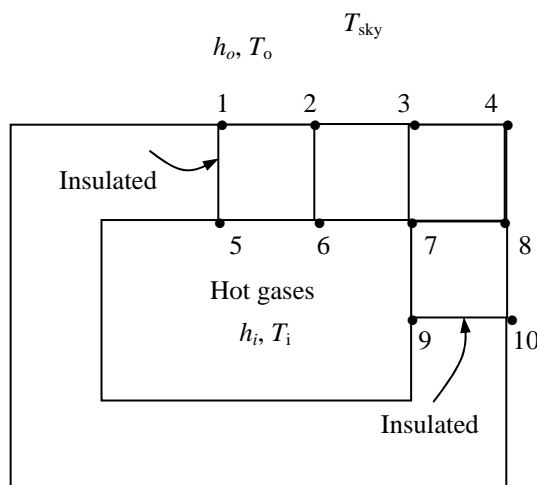

$$\text{Node 1: } h_o \frac{l}{2} (T_o - T_1) + k \frac{l}{2} \frac{T_2 - T_1}{l} + k \frac{l}{2} \frac{T_5 - T_1}{l} + \epsilon \sigma \frac{l}{2} [T_{sky}^4 - (T_1 + 273)^4] = 0$$

$$\text{Node 2: } h_o l (T_o - T_2) + k \frac{l}{2} \frac{T_1 - T_2}{l} + k \frac{l}{2} \frac{T_3 - T_2}{l} + kl \frac{T_6 - T_2}{l} + \epsilon \sigma l [T_{sky}^4 - (T_2 + 273)^4] = 0$$

$$\text{Node 3: } h_o l (T_o - T_3) + k \frac{l}{2} \frac{T_2 - T_3}{l} + k \frac{l}{2} \frac{T_4 - T_3}{l} + kl \frac{T_7 - T_3}{l} + \epsilon \sigma l [T_{sky}^4 - (T_3 + 273)^4] = 0$$

$$\text{Node 4: } h_o l (T_o - T_4) + k \frac{l}{2} \frac{T_3 - T_4}{l} + k \frac{l}{2} \frac{T_8 - T_4}{l} + \epsilon \sigma l [T_{sky}^4 - (T_4 + 273)^4] = 0$$

$$\text{Node 5: } h_i \frac{l}{2} (T_i - T_5) + k \frac{l}{2} \frac{T_6 - T_5}{l} + k \frac{l}{2} \frac{T_1 - T_5}{l} = 0$$

$$\text{Node 6: } h_i l (T_i - T_6) + k \frac{l}{2} \frac{T_5 - T_6}{l} + k \frac{l}{2} \frac{T_7 - T_6}{l} + kl \frac{T_2 - T_6}{l} = 0$$

$$\text{Node 7: } h_i l (T_i - T_7) + k \frac{l}{2} \frac{T_6 - T_7}{l} + k \frac{l}{2} \frac{T_9 - T_7}{l} + kl \frac{T_3 - T_7}{l} + kl \frac{T_8 - T_7}{l} = 0$$

$$\text{Node 8: } h_o l (T_o - T_8) + k \frac{l}{2} \frac{T_4 - T_8}{l} + k \frac{l}{2} \frac{T_{10} - T_8}{l} + kl \frac{T_7 - T_8}{l} + \epsilon \sigma l [T_{sky}^4 - (T_8 + 273)^4] = 0$$

$$\text{Node 9: } h_i \frac{l}{2} (T_i - T_9) + k \frac{l}{2} \frac{T_7 - T_9}{l} + k \frac{l}{2} \frac{T_{10} - T_9}{l} = 0$$

$$\text{Node 10: } h_o \frac{l}{2} (T_o - T_{10}) + k \frac{l}{2} \frac{T_8 - T_{10}}{l} + k \frac{l}{2} \frac{T_9 - T_{10}}{l} + \epsilon \sigma \frac{l}{2} [T_{sky}^4 - (T_{10} + 273)^4] = 0$$

where $l = 0.1 \text{ m}$, $k = 1.4 \text{ W/m}\cdot\text{°C}$, $h_i = 75 \text{ W/m}^2\cdot\text{°C}$, $T_i = 280\text{°C}$, $h_o = 18 \text{ W/m}^2\cdot\text{°C}$, $T_o = 15\text{°C}$, $T_{\text{surr}} = 250 \text{ K}$, $\varepsilon = 0.9$, and $\sigma = 5.67 \times 10^{-8} \text{ W/m}^2\cdot\text{K}^4$. This system of 10 equations with 10 unknowns constitutes the finite difference formulation of the problem.

(b) The 10 nodal temperatures under steady conditions are determined by solving the 10 equations above simultaneously with an equation solver to be

$$T_1 = 94.5\text{°C}, \quad T_2 = 93.0\text{°C}, \quad T_3 = 82.1\text{°C}, \quad T_4 = 36.1\text{°C}, \quad T_5 = 250.6\text{°C},$$

$$T_6 = 249.2\text{°C}, \quad T_7 = 229.7\text{°C}, \quad T_8 = 82.3\text{°C}, \quad T_9 = 261.5\text{°C}, \quad T_{10} = 94.6\text{°C}$$

(c) The rate of heat loss through a 1-m long section of the chimney is determined from

$$\begin{aligned} \dot{Q} &= 4 \sum \dot{Q}_{\text{one-fourth of chimney}} = 4 \sum \dot{Q}_{\text{element, inner surface}} = 4 \sum_m h_i A_{\text{surface},m} (T_i - T_m) \\ &= 4[h_i(l/2)(T_i - T_5) + h_i l(T_i - T_6) + h_i l(T_i - T_7) + h_i(l/2)(T_i - T_9)] \\ &= 4(75 \text{ W/m}^2 \cdot \text{°C})(0.1 \text{ m} \times 1 \text{ m})[(280 - 250.6)/2 + (280 - 249.2) + (280 - 229.7) + (280 - 261.5)/2]\text{°C} \\ &= 3153 \text{ W} \end{aligned}$$

Discussion The rate of heat transfer can also be determined by calculating the heat loss from the outer surface by convection and radiation.

5-58 Heat transfer through a square chimney is considered. The nodal temperatures and the rate of heat loss per unit length are to be determined with the finite difference method.

Assumptions 1 Heat transfer is given to be steady and two-dimensional since the height of the chimney is large relative to its cross-section, and thus heat conduction through the chimney in the axial direction is negligible. It is tempting to simplify the problem further by considering heat transfer in each wall to be one dimensional which would be the case if the walls were thin and thus the corner effects were negligible. This assumption cannot be justified in this case since the walls are very thick and the corner sections constitute a considerable portion of the chimney structure. **2** There is no heat generation in the chimney. **3** Thermal conductivity is constant. **4** Radiation heat transfer is negligible.

Properties The thermal conductivity of chimney is given to be $k = 1.4 \text{ W/m}\cdot^\circ\text{C}$.

Analysis (a) The most striking aspect of this problem is the apparent symmetry about the horizontal and vertical lines passing through the midpoint of the chimney. Therefore, we need to consider only one-fourth of the geometry in the solution whose nodal network consists of 10 equally spaced nodes. No heat can cross a symmetry line, and thus symmetry lines can be treated as insulated surfaces and thus “mirrors” in the finite-difference formulation. Considering a unit depth and using the energy balance approach for the boundary nodes (again assuming all heat transfer to be into the volume element for convenience), the finite difference formulation is obtained to be

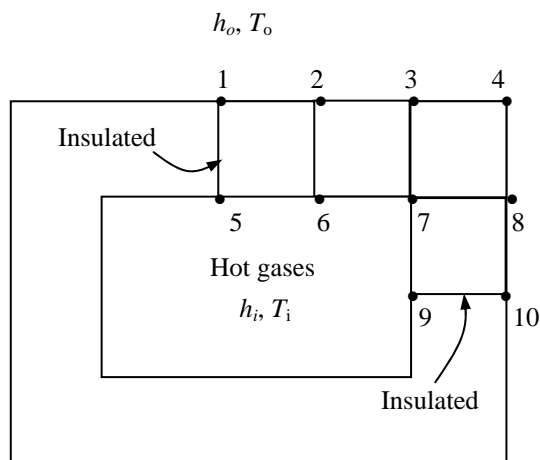

$$\text{Node 1: } h_o \frac{l}{2} (T_o - T_1) + k \frac{l}{2} \frac{T_2 - T_1}{l} + k \frac{l}{2} \frac{T_5 - T_1}{l} = 0$$

$$\text{Node 2: } h_o l (T_o - T_2) + k \frac{l}{2} \frac{T_1 - T_2}{l} + k \frac{l}{2} \frac{T_3 - T_2}{l} + kl \frac{T_6 - T_2}{l} = 0$$

$$\text{Node 3: } h_o l (T_o - T_3) + k \frac{l}{2} \frac{T_2 - T_3}{l} + k \frac{l}{2} \frac{T_4 - T_3}{l} + kl \frac{T_7 - T_3}{l} = 0$$

$$\text{Node 4: } h_o l (T_o - T_4) + k \frac{l}{2} \frac{T_3 - T_4}{l} + k \frac{l}{2} \frac{T_8 - T_4}{l} = 0$$

$$\text{Node 5: } h_i \frac{l}{2} (T_i - T_5) + k \frac{l}{2} \frac{T_6 - T_5}{l} + k \frac{l}{2} \frac{T_1 - T_5}{l} = 0$$

$$\text{Node 6: } h_i l (T_i - T_6) + k \frac{l}{2} \frac{T_5 - T_6}{l} + k \frac{l}{2} \frac{T_7 - T_6}{l} + kl \frac{T_2 - T_6}{l} = 0$$

$$\text{Node 7: } h_i l (T_i - T_7) + k \frac{l}{2} \frac{T_6 - T_7}{l} + k \frac{l}{2} \frac{T_9 - T_7}{l} + kl \frac{T_3 - T_7}{l} + kl \frac{T_8 - T_7}{l} = 0$$

$$\text{Node 8: } h_o l (T_o - T_8) + k \frac{l}{2} \frac{T_4 - T_8}{l} + k \frac{l}{2} \frac{T_{10} - T_8}{l} + kl \frac{T_7 - T_8}{l} = 0$$

$$\text{Node 9: } h_i \frac{l}{2} (T_i - T_9) + k \frac{l}{2} \frac{T_7 - T_9}{l} + k \frac{l}{2} \frac{T_{10} - T_9}{l} = 0$$

$$\text{Node 10: } h_o \frac{l}{2} (T_o - T_{10}) + k \frac{l}{2} \frac{T_8 - T_{10}}{l} + k \frac{l}{2} \frac{T_9 - T_{10}}{l} = 0$$

where $l = 0.1$ m, $k = 1.4$ W/m \cdot °C, $h_i = 75$ W/m 2 ·°C, $T_i = 280$ °C, $h_o = 18$ W/m 2 ·°C, $T_o = 15$ °C, and $\sigma = 5.67 \times 10^{-8}$ W/m 2 ·K 4 . This system of 10 equations with 10 unknowns constitutes the finite difference formulation of the problem.

(b) The 10 nodal temperatures under steady conditions are determined by solving the 10 equations above simultaneously with an equation solver to be

$$T_1 = 118.8^\circ\text{C}, \quad T_2 = 116.7^\circ\text{C}, \quad T_3 = 103.4^\circ\text{C}, \quad T_4 = 53.7^\circ\text{C}, \quad T_5 = 254.4^\circ\text{C}, \\ T_6 = 253.0^\circ\text{C}, \quad T_7 = 235.2^\circ\text{C}, \quad T_8 = 103.5^\circ\text{C}, \quad T_9 = 263.7^\circ\text{C}, \quad T_{10} = 117.6^\circ\text{C}$$

(c) The rate of heat loss through a 1-m long section of the chimney is determined from

$$\begin{aligned} \dot{Q} &= 4 \sum \dot{Q}_{\text{one-fourth of chimney}} = 4 \sum \dot{Q}_{\text{element, inner surface}} = 4 \sum_m h_i A_{\text{surface},m} (T_i - T_m) \\ &= 4[h_i(l/2)(T_i - T_5) + h_i l(T_i - T_6) + h_i l(T_i - T_7) + h_i(l/2)(T_i - T_9)] \\ &= 4(75 \text{ W/m}^2 \cdot ^\circ\text{C})(0.1 \text{ m} \times 1 \text{ m})[(280 - 254.4)/2 + (280 - 253.0) + (280 - 235.2) + (280 - 263.7)/2]^\circ\text{C} \\ &= 2783 \text{ W} \end{aligned}$$

Discussion The rate of heat transfer can also be determined by calculating the heat loss from the outer surface by convection.

5-59 EES Prob. 5-57 is reconsidered. The effects of hot-gas temperature and the outer surface emissivity on the temperatures at the outer corner of the wall and the middle of the inner surface of the right wall, and the rate of heat loss are to be investigated.

Analysis The problem is solved using EES, and the solution is given below.

"GIVEN"

k=1.4 [W/m-C]
 A_flow=0.20*0.40 [m^2]
 t=0.10 [m]
 T_i=280 [C]
 h_i=75 [W/m^2-C]
 T_o=15 [C]
 h_o=18 [W/m^2-C]
 epsilon=0.9
 T_sky=250 [K]
 DELTAX=0.10 [m]
 DELTAY=0.10 [m]
 d=1 [m] "unit depth is considered"
 sigma=5.67E-8 [W/m^2-K^4] "Stefan-Boltzmann constant"

"ANALYSIS"

"(b)"

l=DELTAx

"We consider only one-fourth of the geometry whose nodal network consists of 10 nodes. Using the finite difference method, 10 equations for 10 unknown temperatures are determined to be"

$h_o \cdot l/2 \cdot (T_o - T_1) + k \cdot l/2 \cdot (T_2 - T_1)/l + k \cdot l/2 \cdot (T_5 - T_1)/l + \epsilon \cdot \sigma \cdot l/2 \cdot (T_{sky}^4 - (T_1 + 273)^4) = 0$ "Node 1"
 $h_o \cdot l \cdot (T_o - T_2) + k \cdot l/2 \cdot (T_1 - T_2)/l + k \cdot l/2 \cdot (T_3 - T_2)/l + k \cdot l \cdot (T_6 - T_2)/l + \epsilon \cdot \sigma \cdot l \cdot (T_{sky}^4 - (T_2 + 273)^4) = 0$ "Node 2"
 $h_o \cdot l \cdot (T_o - T_3) + k \cdot l/2 \cdot (T_2 - T_3)/l + k \cdot l/2 \cdot (T_4 - T_3)/l + k \cdot l \cdot (T_7 - T_3)/l + \epsilon \cdot \sigma \cdot l \cdot (T_{sky}^4 - (T_3 + 273)^4) = 0$ "Node 3"
 $h_o \cdot l \cdot (T_o - T_4) + k \cdot l/2 \cdot (T_3 - T_4)/l + k \cdot l/2 \cdot (T_8 - T_4)/l + \epsilon \cdot \sigma \cdot l \cdot (T_{sky}^4 - (T_4 + 273)^4) = 0$ "Node 4"
 $h_i \cdot l/2 \cdot (T_i - T_5) + k \cdot l/2 \cdot (T_6 - T_5)/l + k \cdot l/2 \cdot (T_1 - T_5)/l = 0$ "Node 5"
 $h_i \cdot l \cdot (T_i - T_6) + k \cdot l/2 \cdot (T_5 - T_6)/l + k \cdot l/2 \cdot (T_7 - T_6)/l + k \cdot l \cdot (T_2 - T_6)/l = 0$ "Node 6"
 $h_i \cdot l \cdot (T_i - T_7) + k \cdot l/2 \cdot (T_6 - T_7)/l + k \cdot l/2 \cdot (T_9 - T_7)/l + k \cdot l \cdot (T_3 - T_7)/l + k \cdot l \cdot (T_8 - T_7)/l = 0$ "Node 7"
 $h_o \cdot l \cdot (T_o - T_8) + k \cdot l/2 \cdot (T_4 - T_8)/l + k \cdot l/2 \cdot (T_{10} - T_8)/l + k \cdot l \cdot (T_7 - T_8)/l + \epsilon \cdot \sigma \cdot l \cdot (T_{sky}^4 - (T_8 + 273)^4) = 0$ "Node 8"
 $h_i \cdot l \cdot (T_i - T_9) + k \cdot l/2 \cdot (T_7 - T_9)/l + k \cdot l/2 \cdot (T_{10} - T_9)/l = 0$ "Node 9"
 $h_o \cdot l/2 \cdot (T_o - T_{10}) + k \cdot l/2 \cdot (T_8 - T_{10})/l + k \cdot l/2 \cdot (T_9 - T_{10})/l + \epsilon \cdot \sigma \cdot l/2 \cdot (T_{sky}^4 - (T_{10} + 273)^4) = 0$ "Node 10"

"Right top corner is considered. The locations of nodes are as follows:"

Node 1: Middle of top surface

Node 2: At the right side of node 1

Node 3: At the right side of node 2

Node 4: Corner node

Node 5: The node below node 1, at the middle of inner top surface

Node 6: The node below node 2

Node 7: The node below node 3, at the inner corner

Node 8: The node below node 4

Node 9: The node below node 7, at the middle of inner right surface

Node 10: The node below node 8, at the middle of outer right surface"

T_corner=T_4

T_inner_middle=T_9

"(c)"

"The rate of heat loss through a unit depth $d=1$ m of the chimney is"

$$Q_{\text{dot}}=4*(h_i/2*d*(T_i-T_5)+h_i*l*d*(T_i-T_6)+h_i*l*d*(T_i-T_7)+h_i/2*d*(T_i-T_9))$$

T_i [C]	T_{corner} [C]	$T_{\text{inner, middle}}$ [C]	Q [W]
200	28.38	187	2206
210	29.37	196.3	2323
220	30.35	205.7	2441
230	31.32	215	2559
240	32.28	224.3	2677
250	33.24	233.6	2796
260	34.2	242.9	2914
270	35.14	252.2	3033
280	36.08	261.5	3153
290	37.02	270.8	3272
300	37.95	280.1	3392
310	38.87	289.3	3512
320	39.79	298.6	3632
330	40.7	307.9	3752
340	41.6	317.2	3873
350	42.5	326.5	3994
360	43.39	335.8	4115
370	44.28	345.1	4237
380	45.16	354.4	4358
390	46.04	363.6	4480
400	46.91	372.9	4602

ϵ	T_{corner} [C]	$T_{\text{inner, middle}}$ [C]	Q [W]
0.1	51.09	263.4	2836
0.15	49.87	263.2	2862
0.2	48.7	263.1	2886
0.25	47.58	262.9	2909
0.3	46.5	262.8	2932
0.35	45.46	262.7	2953
0.4	44.46	262.5	2974
0.45	43.5	262.4	2995
0.5	42.56	262.3	3014
0.55	41.66	262.2	3033
0.6	40.79	262.1	3052
0.65	39.94	262	3070
0.7	39.12	261.9	3087
0.75	38.33	261.8	3104
0.8	37.56	261.7	3121
0.85	36.81	261.6	3137
0.9	36.08	261.5	3153
0.95	35.38	261.4	3168
1	34.69	261.3	3183

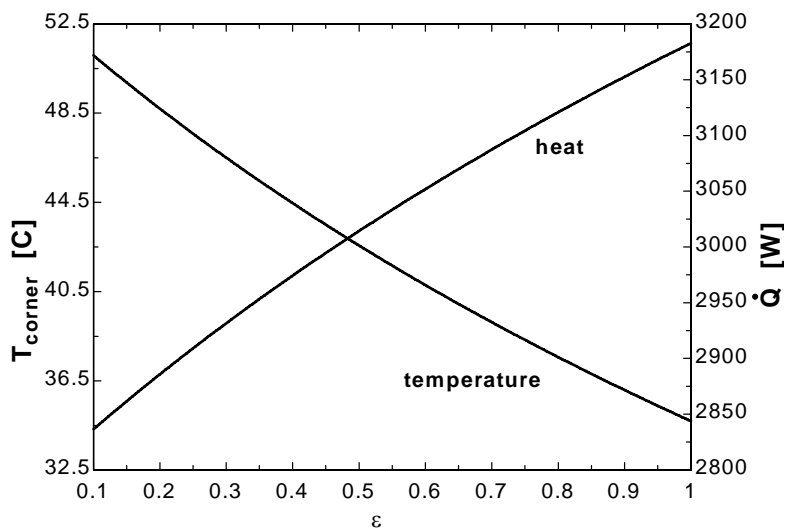
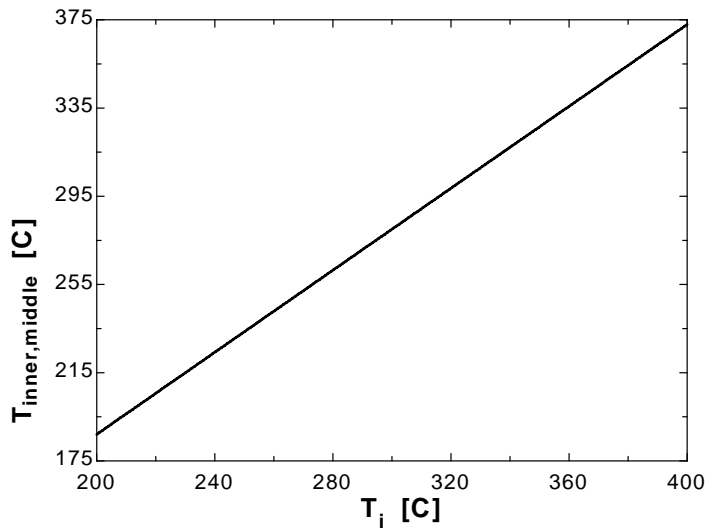
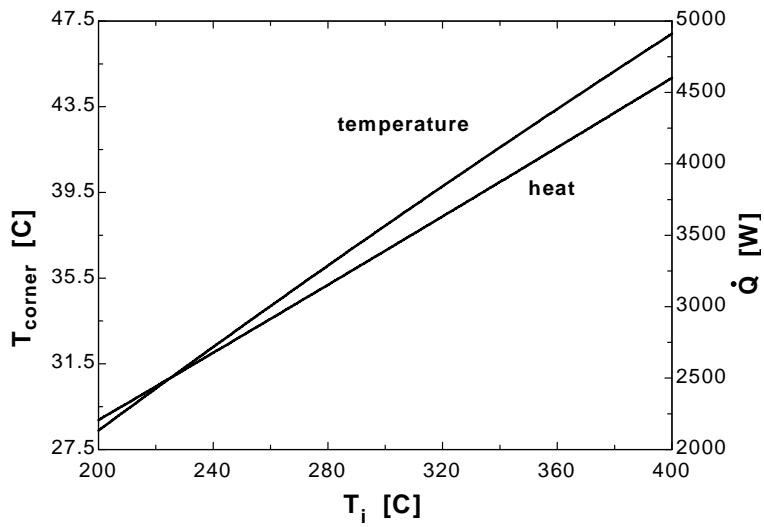

5-60 The exposed surface of a long concrete dam of triangular cross-section is subjected to solar heat flux and convection and radiation heat transfer. The vertical section of the dam is subjected to convection with water. The temperatures at the top, middle, and bottom of the exposed surface of the dam are to be determined.

Assumptions **1** Heat transfer through the dam is given to be steady and two-dimensional. **2** There is no heat generation within the dam. **3** Heat transfer through the base is negligible. **4** Thermal properties and heat transfer coefficients are constant.

Properties The thermal conductivity and solar absorptivity are given to be $k = 0.6 \text{ W/m}\cdot\text{C}$ and $\alpha_s = 0.7$.

Analysis The nodal spacing is given to be $\Delta x = \Delta y = l = 1 \text{ m}$, and all nodes are boundary nodes. Node 5 on the insulated boundary can be treated as an interior node for which $T_{\text{left}} + T_{\text{top}} + T_{\text{right}} + T_{\text{bottom}} - 4T_{\text{node}} = 0$.

Using the energy balance approach and taking the direction of all heat transfer to be towards the node, the finite difference equations for the nodes are obtained to be as follows:

$$\text{Node 1: } h_i \frac{l}{2} (T_i - T_1) + k \frac{l}{2} \frac{T_2 - T_1}{l} + \frac{l/2}{\sin 45} [\alpha_s \dot{q}_s + h_o (T_o - T_1)] = 0$$

$$\text{Node 2: } h_i l (T_i - T_1) + k \frac{l}{2} \frac{T_1 - T_2}{l} + k \frac{l}{2} \frac{T_4 - T_2}{l} + kl \frac{T_3 - T_2}{l} = 0$$

$$\text{Node 3: } kl \frac{T_2 - T_3}{l} + kl \frac{T_5 - T_3}{l} + \frac{l}{\sin 45} [\alpha_s \dot{q}_s + h_o (T_o - T_3)] = 0$$

$$\text{Node 4: } h_i \frac{l}{2} (T_i - T_4) + k \frac{l}{2} \frac{T_2 - T_4}{l} + k \frac{l}{2} \frac{T_5 - T_4}{l} = 0$$

$$\text{Node 5: } T_4 + 2T_3 + T_6 - 4T_5 = 0$$

$$\text{Node 6: } k \frac{l}{2} \frac{T_5 - T_6}{l} + \frac{l/2}{\sin 45} [\alpha_s \dot{q}_s + h_o (T_o - T_6)] = 0$$

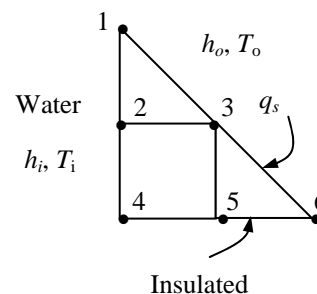

where $l = 1 \text{ m}$, $k = 0.6 \text{ W/m}\cdot\text{C}$, $h_i = 150 \text{ W/m}^2\cdot\text{C}$, $T_i = 15^\circ\text{C}$, $h_o = 30 \text{ W/m}^2\cdot\text{C}$, $T_o = 25^\circ\text{C}$, $\alpha_s = 0.7$, and $\dot{q}_s = 800 \text{ W/m}^2$. The system of 6 equations with 6 unknowns constitutes the finite difference formulation of the problem. The 6 nodal temperatures under steady conditions are determined by solving the 6 equations above simultaneously with an equation solver to be

$$T_1 = T_{\text{top}} = \mathbf{21.3^\circ\text{C}}, \quad T_2 = 15.1^\circ\text{C}, \quad T_3 = T_{\text{middle}} = \mathbf{43.2^\circ\text{C}}$$

$$T_4 = 15.1^\circ\text{C}, \quad T_5 = 36.3^\circ\text{C}, \quad T_6 = T_{\text{bottom}} = \mathbf{43.6^\circ\text{C}}$$

Discussion Note that the highest temperature occurs at a location furthest away from the water, as expected.

5-61E The top and bottom surfaces of a V-grooved long solid bar are maintained at specified temperatures while the left and right surfaces are insulated. The temperature at the middle of the insulated surface is to be determined.

Assumptions 1 Heat transfer through the bar is given to be steady and two-dimensional. **2** There is no heat generation within the bar. **3** Thermal properties are constant.

Analysis The nodal spacing is given to be $\Delta x = \Delta y = l = 1$ ft, and the general finite difference form of an interior node for steady two-dimensional heat conduction with no heat generation is expressed as

$$T_{\text{left}} + T_{\text{top}} + T_{\text{right}} + T_{\text{bottom}} - 4T_{\text{node}} + \frac{\dot{e}_{\text{node}} l^2}{k} = 0 \rightarrow T_{\text{left}} + T_{\text{top}} + T_{\text{right}} + T_{\text{bottom}} - 4T_{\text{node}} = 0$$

There is symmetry about the vertical plane passing through the center. Therefore, $T_1 = T_9$, $T_2 = T_{10}$, $T_3 = T_{11}$, $T_4 = T_7$, and $T_5 = T_8$. Therefore, there are only 6 unknown nodal temperatures, and thus we need only 6 equations to determine them uniquely. Also, we can replace the symmetry lines by insulation and utilize the mirror-image concept when writing the finite difference equations for the interior nodes.

The finite difference equations for boundary nodes are obtained by applying an energy balance on the volume elements and taking the direction of all heat transfers to be towards the node under consideration:

$$\text{Node 1: } k \frac{l}{2} \frac{32 - T_1}{l} + kl \frac{32 - T_1}{l} + k \frac{l}{2} \frac{T_2 - T_1}{l} = 0$$

(Note that k and l cancel out)

$$\text{Node 2: } T_1 + 2T_4 + T_3 - 4T_2 = 0$$

$$\text{Node 3: } T_2 + 212 + 2T_5 - 4T_3 = 0$$

$$\text{Node 4: } 2 \times 32 + T_2 + T_5 - 4T_4 = 0$$

$$\text{Node 5: } T_3 + 212 + T_4 + T_6 - 4T_5 = 0$$

$$\text{Node 6: } 32 + 212 + 2T_5 - 4T_6 = 0$$

The 6 nodal temperatures under steady conditions are determined by solving the 6 equations above simultaneously with an equation solver to be

$$T_1 = 44.7^\circ\text{F}, \quad T_2 = 82.8^\circ\text{F}, \quad T_3 = 143.4^\circ\text{F}, \quad T_4 = 71.6^\circ\text{F}, \quad T_5 = 139.4^\circ\text{F}, \quad T_6 = 130.7^\circ\text{F}$$

Therefore, the temperature at the middle of the insulated surface will be $T_2 = 82.8^\circ\text{F}$.

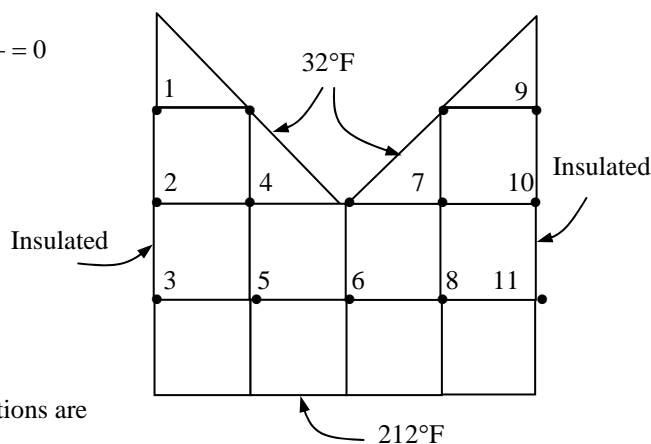

5-62E EES Prob. 5-61E is reconsidered. The effects of the temperatures at the top and bottom surfaces on the temperature in the middle of the insulated surface are to be investigated.

Analysis The problem is solved using EES, and the solution is given below.

"GIVEN"

T_top=32 [F]
T_bottom=212 [F]
DELTAx=1 [ft]
DELTAy=1 [ft]

"ANALYSIS"

l=DELTAx

T_1=T_9 "due to symmetry"

T_2=T_10 "due to symmetry"

T_3=T_11 "due to symmetry"

T_4=T_7 "due to symmetry"

T_5=T_8 "due to symmetry"

"Using the finite difference method, the six equations for the six unknown temperatures are determined to be"

" $k/2*(T_{top}-T_1)/l+k*(T_{top}-T_1)/l+k/2*(T_2-T_1)/l=0$ simplifies to for Node 1"

$1/2*(T_{top}-T_1)+(T_{top}-T_1)+1/2*(T_2-T_1)=0$ "Node 1"

$T_1+2*T_4+T_3-4*T_2=0$ "Node 2"

$T_2+T_{bottom}+2*T_5-4*T_3=0$ "Node 3"

$2*T_{top}+T_2+T_5-4*T_4=0$ "Node 4"

$T_3+T_{bottom}+T_4+T_6-4*T_5=0$ "Node 5"

$T_{top}+T_{bottom}+2*T_5-4*T_6=0$ "Node 6"

T _{top} [F]	T ₂ [F]
32	82.81
41.47	89.61
50.95	96.41
60.42	103.2
69.89	110
79.37	116.8
88.84	123.6
98.32	130.4
107.8	137.2
117.3	144
126.7	150.8
136.2	157.6
145.7	164.4
155.2	171.2
164.6	178
174.1	184.8
183.6	191.6
193.1	198.4
202.5	205.2
212	212

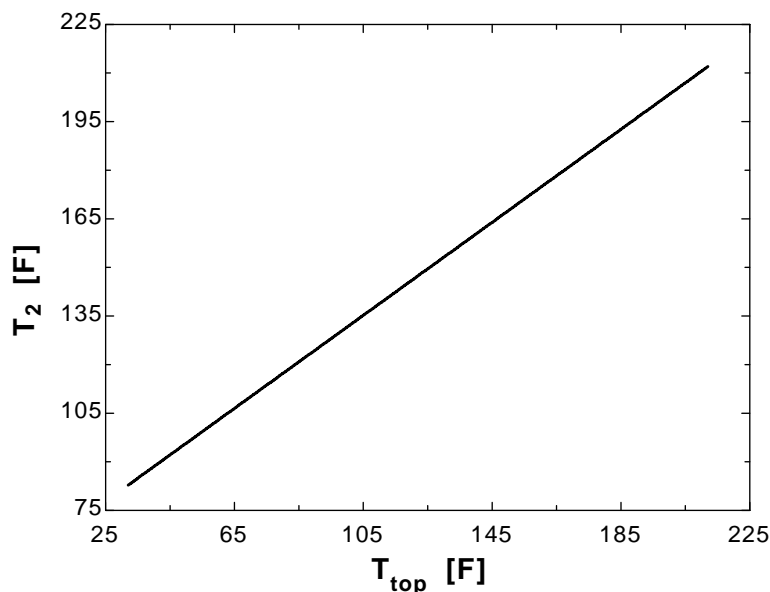

T_{bottom} [F]	T_2 [F]
32	32
41.47	34.67
50.95	37.35
60.42	40.02
69.89	42.7
79.37	45.37
88.84	48.04
98.32	50.72
107.8	53.39
117.3	56.07
126.7	58.74
136.2	61.41
145.7	64.09
155.2	66.76
164.6	69.44
174.1	72.11
183.6	74.78
193.1	77.46
202.5	80.13
212	82.81

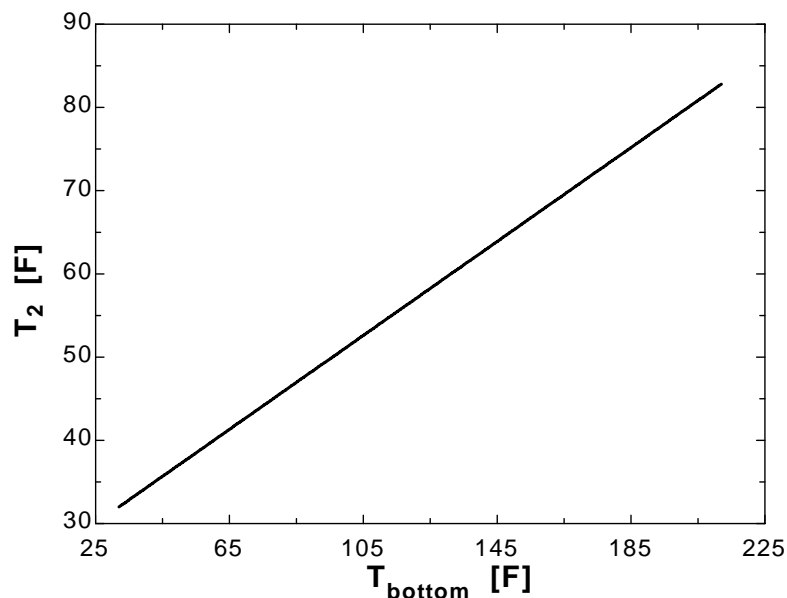

5-63 The top and bottom surfaces of an L-shaped long solid bar are maintained at specified temperatures while the left surface is insulated and the remaining 3 surfaces are subjected to convection. The finite difference formulation of the problem is to be obtained, and the unknown nodal temperatures are to be determined.

Assumptions 1 Heat transfer through the bar is given to be steady and two-dimensional. 2 There is no heat generation within the bar. 3 Thermal properties and heat transfer coefficients are constant. 4 Radiation heat transfer is negligible.

Properties The thermal conductivity is given to be $k = 5 \text{ W/m}\cdot\text{C}$.

Analysis (a) The nodal spacing is given to be $\Delta x = \Delta y = l = 0.1 \text{ m}$, and all nodes are boundary nodes. Node 1 on the insulated boundary can be treated as an interior node for which $T_{\text{left}} + T_{\text{top}} + T_{\text{right}} + T_{\text{bottom}} - 4T_{\text{node}} = 0$. Using the energy balance approach and taking the direction of all heat transfer to be towards the node, the finite difference equations for the nodes are obtained to be as follows:

$$\text{Node 1: } 50 + 120 + 2T_2 - 4T_1 = 0$$

$$\text{Node 2: } hl(T_\infty - T_2) + k \frac{l}{2} \frac{50 - T_2}{l} + k \frac{l}{2} \frac{T_3 - T_2}{l} + kl \frac{T_1 - T_2}{l} + kl \frac{120 - T_2}{l} = 0$$

$$\text{Node 3: } hl(T_\infty - T_3) + k \frac{l}{2} \frac{T_2 - T_3}{l} + k \frac{l}{2} \frac{120 - T_3}{l} = 0$$

where $l = 0.1 \text{ m}$, $k = 5 \text{ W/m}\cdot\text{C}$, $h = 40 \text{ W/m}^2\cdot\text{C}$, and $T_\infty = 25^\circ\text{C}$. This system of 3 equations with 3 unknowns constitute the finite difference formulation of the problem.

(b) The 3 nodal temperatures under steady conditions are determined by solving the 3 equations above simultaneously with an equation solver to be

$$T_1 = 78.8^\circ\text{C}, \quad T_2 = 72.7^\circ\text{C}, \quad T_3 = 64.6^\circ\text{C}$$

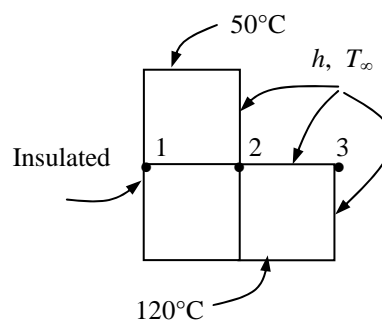

5-64 A rectangular block is subjected to uniform heat flux at the top, and iced water at 0°C at the sides. The steady finite difference formulation of the problem is to be obtained, and the unknown nodal temperatures as well as the rate of heat transfer to the iced water are to be determined.

Assumptions **1** Heat transfer through the body is given to be steady and two-dimensional. **2** There is no heat generation within the block. **3** The heat transfer coefficient is very high so that the temperatures on both sides of the block can be taken to be 0°C . **4** Heat transfer through the bottom surface is negligible.

Properties The thermal conductivity is given to be $k = 23 \text{ W/m}\cdot^\circ\text{C}$.

Analysis The nodal spacing is given to be $\Delta x = \Delta y = l = 0.1 \text{ m}$, and the general finite difference form of an interior node equation for steady 2-D heat conduction is expressed as

$$T_{\text{left}} + T_{\text{top}} + T_{\text{right}} + T_{\text{bottom}} - 4T_{\text{node}} + \frac{\dot{e}_{\text{node}} l^2}{k} = 0$$

$$T_{\text{left}} + T_{\text{top}} + T_{\text{right}} + T_{\text{bottom}} - 4T_{\text{node}} = 0$$

There is symmetry about a vertical line passing through the middle of the region, and we need to consider only half of the region. Note that all side surfaces are at $T_0 = 0^\circ\text{C}$, and there are 8 nodes with unknown temperatures. Replacing the symmetry lines by insulation and utilizing the mirror-image concept, the finite difference equations are obtained to be as follows:

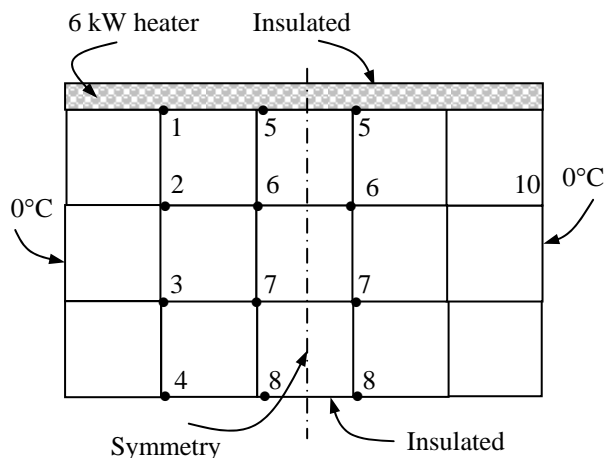

$$\text{Node 1 (heat flux): } \dot{q}_0 l + k \frac{l}{2} \frac{T_0 - T_1}{l} + k \frac{l}{2} \frac{T_5 - T_1}{l} + kl \frac{T_2 - T_1}{l} = 0$$

$$\text{Node 2 (interior): } T_0 + T_1 + T_3 + T_6 - 4T_2 = 0$$

$$\text{Node 3 (interior): } T_0 + T_2 + T_4 + T_7 - 4T_3 = 0$$

$$\text{Node 4 (insulation): } T_0 + 2T_3 + T_8 - 4T_4 = 0$$

$$\text{Node 5 (heat flux): } \dot{q}_0 l + k \frac{l}{2} \frac{T_1 - T_5}{l} + kl \frac{T_6 - T_5}{l} + 0 = 0$$

$$\text{Node 6 (interior): } T_2 + T_5 + T_6 + T_7 - 4T_6 = 0$$

$$\text{Node 7 (interior): } T_3 + T_6 + T_7 + T_8 - 4T_7 = 0$$

$$\text{Node 8 (insulation): } T_4 + 2T_7 + T_8 - 4T_8 = 0$$

where $l = 0.1 \text{ m}$, $k = 23 \text{ W/m}\cdot^\circ\text{C}$, $T_0 = 0^\circ\text{C}$, and $\dot{q}_0 = \dot{Q}_0 / A = (6000 \text{ W}) / (5 \times 0.5 \text{ m}^2) = 2400 \text{ W/m}^2$. This system of 8 equations with 8 unknowns constitutes the finite difference formulation of the problem.

(b) The 8 nodal temperatures under steady conditions are determined by solving the 8 equations above simultaneously with an equation solver to be

$$T_1 = 13.7^\circ\text{C}, T_2 = 7.4^\circ\text{C}, T_3 = 4.7^\circ\text{C}, T_4 = 3.9^\circ\text{C}, T_5 = 19.0^\circ\text{C}, T_6 = 11.3^\circ\text{C}, T_7 = 7.4^\circ\text{C}, T_8 = 6.2^\circ\text{C}$$

(c) The rate of heat transfer from the block to the iced water is 6 kW since all the heat supplied to the block from the top must be equal to the heat transferred from the block. Therefore, $\dot{Q} = 6 \text{ kW}$.

Discussion The rate of heat transfer can also be determined by calculating the heat loss from the side surfaces using the heat conduction relation.

Transient Heat Conduction

5-65C The formulation of a transient heat conduction problem differs from that of a steady heat conduction problem in that the transient problem involves an *additional term* that represents the *change in the energy content* of the medium with time. This additional term $\rho A \Delta x c_p (T_m^{i+1} - T_m^i) / \Delta t$ represent the change in the internal energy content during Δt in the transient finite difference formulation.

5-66C The two basic methods of solution of transient problems based on finite differencing are the *explicit* and the *implicit methods*. The heat transfer terms are expressed at time step i in the explicit method, and at the future time step $i + 1$ in the implicit method as

$$\text{Explicit method: } \sum_{\text{All sides}} \dot{Q}^i + \dot{E}_{\text{gen, element}}^i = \rho \mathbf{V}_{\text{element}} c_p \frac{T_m^{i+1} - T_m^i}{\Delta t}$$

$$\text{Implicit method: } \sum_{\text{All sides}} \dot{Q}^{i+1} + \dot{E}_{\text{gen, element}}^{i+1} = \rho \mathbf{V}_{\text{element}} c_p \frac{T_m^{i+1} - T_m^i}{\Delta t}$$

5-67C The explicit finite difference formulation of a general interior node for transient heat conduction in a plane wall is given by $T_{m-1}^i - 2T_m^i + T_{m+1}^i + \frac{\dot{e}_m \Delta x^2}{k} = \frac{T_m^{i+1} - T_m^i}{\tau}$. The finite difference formulation for the steady case is obtained by simply setting $T_m^{i+1} = T_m^i$ and disregarding the time index i . It yields

$$T_{m-1} - 2T_m + T_{m+1} + \frac{\dot{e}_m \Delta x^2}{k} = 0$$

5-68C The explicit finite difference formulation of a general interior node for transient two-dimensional heat conduction is given by $T_{\text{node}}^{i+1} = \tau(T_{\text{left}}^i + T_{\text{top}}^i + T_{\text{right}}^i + T_{\text{bottom}}^i) + (1 - 4\tau)T_{\text{node}}^i + \tau \frac{\dot{e}_{\text{node}}^i l^2}{k}$. The finite difference formulation for the steady case is obtained by simply setting $T_m^{i+1} = T_m^i$ and disregarding the time index i . It yields

$$T_{\text{left}} + T_{\text{top}} + T_{\text{right}} + T_{\text{bottom}} - 4T_{\text{node}} + \frac{\dot{e}_{\text{node}} l^2}{k} = 0$$

5-69C There is a limitation on the size of the time step Δt in the solution of transient heat conduction problems using the explicit method, but there is no such limitation in the implicit method.

5-70C The general stability criteria for the explicit method of solution of transient heat conduction problems is expressed as follows: *The coefficients of all T_m^i in the T_m^{i+1} expressions (called the primary coefficient) in the simplified expressions must be greater than or equal to zero for all nodes m .*

5-71C For transient one-dimensional heat conduction in a plane wall with both sides of the wall at specified temperatures, the stability criteria for the explicit method can be expressed in its simplest form as

$$\tau = \frac{\alpha \Delta t}{(\Delta x)^2} \leq \frac{1}{2}$$

5-72C For transient one-dimensional heat conduction in a plane wall with specified heat flux on both sides, the stability criteria for the explicit method can be expressed in its simplest form as

$$\tau = \frac{\alpha \Delta t}{(\Delta x)^2} \leq \frac{1}{2}$$

which is identical to the one for the interior nodes. This is because the heat flux boundary conditions have no effect on the stability criteria.

5-73C For transient two-dimensional heat conduction in a rectangular region with insulation or specified temperature boundary conditions, the stability criteria for the explicit method can be expressed in its simplest form as

$$\tau = \frac{\alpha \Delta t}{(\Delta x)^2} \leq \frac{1}{4}$$

which is identical to the one for the interior nodes. This is because the insulation or specified temperature boundary conditions have no effect on the stability criteria.

5-74C The implicit method is unconditionally stable and thus any value of time step Δt can be used in the solution of transient heat conduction problems since there is no danger of instability. However, using a very large value of Δt is equivalent to replacing the time derivative by a very large difference, and thus the solution will not be accurate. Therefore, we should still use the smallest time step practical to minimize the numerical error.

5-75 A plane wall with no heat generation is subjected to specified temperature at the left (node 0) and heat flux at the right boundary (node 6). The explicit transient finite difference formulation of the boundary nodes and the finite difference formulation for the total amount of heat transfer at the left boundary during the first 3 time steps are to be determined.

Assumptions 1 Heat transfer through the wall is given to be transient, and the thermal conductivity to be constant. **2** Heat transfer is one-dimensional since the plate is large relative to its thickness. **3** There is no heat generation in the medium.

Analysis Using the energy balance approach and taking the direction of all heat transfers to be towards the node under consideration, the *explicit* finite difference formulations become

Left boundary node: $T_0^i = T_0 = 50^\circ\text{C}$

Right boundary node: $k \frac{T_5^i - T_6^i}{\Delta x} + \dot{q}_0 = \rho \frac{\Delta x}{2} c_p \frac{T_6^{i+1} - T_6^i}{\Delta t}$

Heat transfer at left surface: $\dot{Q}_{\text{left surface}}^i + kA \frac{T_1^i - T_0}{\Delta x} = \rho A \frac{\Delta x}{2} c_p \frac{T_6^{i+1} - T_6^i}{\Delta t}$

Noting that $Q = \dot{Q}\Delta t = \sum_i \dot{Q}^i \Delta t$, the total amount of heat transfer becomes

$$Q_{\text{left surface}} = \sum_{i=1}^3 \dot{Q}_{\text{left surface}}^i \Delta t = \sum_{i=1}^3 \left(kA \frac{T_0 - T_1^i}{\Delta x} + \rho A \frac{\Delta x}{2} c_p \frac{T_6^{i+1} - T_6^i}{\Delta t} \right) \Delta t$$

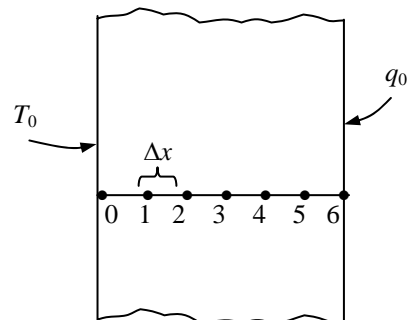

5-76 A plane wall with variable heat generation and constant thermal conductivity is subjected to uniform heat flux \dot{q}_0 at the left (node 0) and convection at the right boundary (node 4). The explicit transient finite difference formulation of the boundary nodes is to be determined.

Assumptions 1 Heat transfer through the wall is given to be transient, and the thermal conductivity to be constant. **2** Heat transfer is one-dimensional since the wall is large relative to its thickness. **3** Radiation heat transfer is negligible.

Analysis Using the energy balance approach and taking the direction of all heat transfers to be towards the node under consideration, the *explicit* finite difference formulations become

Left boundary node:

$$kA \frac{T_1^i - T_0^i}{\Delta x} + \dot{q}_0 A + \dot{e}_0^i (A\Delta x / 2) = \rho A \frac{\Delta x}{2} c_p \frac{T_0^{i+1} - T_0^i}{\Delta t}$$

Right boundary node:

$$kA \frac{T_3^i - T_4^i}{\Delta x} + hA(T_\infty - T_4^i) + \dot{e}_4^i (A\Delta x / 2) = \rho A \frac{\Delta x}{2} c_p \frac{T_4^{i+1} - T_4^i}{\Delta t}$$

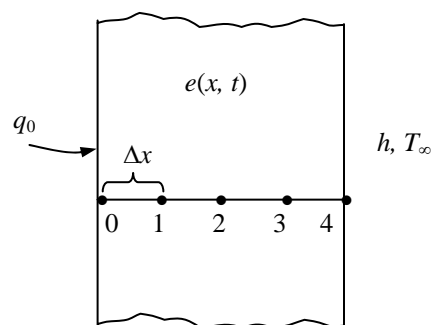

5-77 A plane wall with variable heat generation and constant thermal conductivity is subjected to uniform heat flux \dot{q}_0 at the left (node 0) and convection at the right boundary (node 4). The explicit transient finite difference formulation of the boundary nodes is to be determined.

Assumptions 1 Heat transfer through the wall is given to be transient, and the thermal conductivity to be constant. **2** Heat transfer is one-dimensional since the wall is large relative to its thickness. **3** Radiation heat transfer is negligible.

Analysis Using the energy balance approach and taking the direction of all heat transfers to be towards the node under consideration, the *implicit* finite difference formulations become

Left boundary node:

$$kA \frac{T_1^{i+1} - T_0^{i+1}}{\Delta x} + \dot{q}_0 A + \dot{e}_0^{i+1} (A\Delta x / 2) = \rho A \frac{\Delta x}{2} c_p \frac{T_0^{i+1} - T_0^i}{\Delta t}$$

Right boundary node:

$$kA \frac{T_3^{i+1} - T_4^{i+1}}{\Delta x} + hA(T_\infty^{i+1} - T_4^{i+1}) + \dot{e}_4^{i+1} (A\Delta x / 2) = \rho A \frac{\Delta x}{2} c_p \frac{T_4^{i+1} - T_4^i}{\Delta t}$$

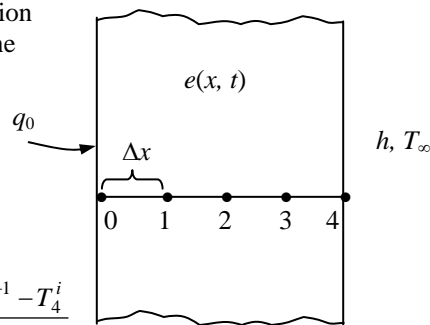

5-78 A plane wall with variable heat generation and constant thermal conductivity is subjected to insulation at the left (node 0) and radiation at the right boundary (node 5). The explicit transient finite difference formulation of the boundary nodes is to be determined.

Assumptions 1 Heat transfer through the wall is given to be transient and one-dimensional, and the thermal conductivity to be constant. **2** Convection heat transfer is negligible.

Analysis Using the energy balance approach and taking the direction of all heat transfers to be towards the node under consideration, the *explicit* transient finite difference formulations become

Left boundary node:

$$kA \frac{T_1^i - T_0^i}{\Delta x} + \dot{e}_0^i A \frac{\Delta x}{2} = \rho A \frac{\Delta x}{2} c_p \frac{T_0^{i+1} - T_0^i}{\Delta t}$$

Right boundary node:

$$\varepsilon \sigma A [(T_{\text{surr}}^i)^4 - (T_5^i)^4] + kA \frac{T_4^i - T_5^i}{\Delta x} + \dot{e}_5^i A \frac{\Delta x}{2} = \rho A \frac{\Delta x}{2} c_p \frac{T_5^{i+1} - T_5^i}{\Delta t}$$

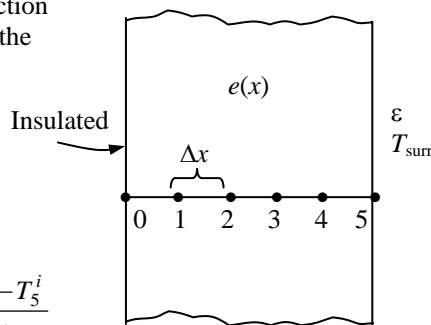

5-79 A plane wall with variable heat generation and constant thermal conductivity is subjected to combined convection, radiation, and heat flux at the left (node 0) and specified temperature at the right boundary (node 4). The explicit finite difference formulation of the left boundary and the finite difference formulation for the total amount of heat transfer at the right boundary are to be determined.

Assumptions 1 Heat transfer through the wall is given to be transient and one-dimensional, and the thermal conductivity to be constant.

Analysis Using the energy balance approach and taking the direction of all heat transfers to be towards the node under consideration, the *explicit* transient finite difference formulations become

Left boundary node:

$$\varepsilon\sigma A [T_{\text{surr}}^4 - (T_0^i)^4] + hA(T_\infty^i - T_0^i) + kA \frac{T_1^i - T_0^i}{\Delta x} + \dot{e}_0^i A \frac{\Delta x}{2} = \rho A \frac{\Delta x}{2} c_p \frac{T_0^{i+1} - T_0^i}{\Delta t}$$

Heat transfer at right surface:

$$\dot{Q}_{\text{right surface}}^i + kA \frac{T_3^i - T_4^i}{\Delta x} + \dot{e}_4^i A \frac{\Delta x}{2} = \rho A \frac{\Delta x}{2} c_p \frac{T_4^{i+1} - T_4^i}{\Delta t}$$

Noting that

$$Q = \dot{Q}\Delta t = \sum_i \dot{Q}^i \Delta t$$

the total amount of heat transfer becomes

$$\begin{aligned} Q_{\text{right surface}} &= \sum_{i=1}^{20} \dot{Q}_{\text{right surface}}^i \Delta t \\ &= \sum_{i=1}^{20} \left(kA \frac{T_4^i - T_3^i}{\Delta x} - \dot{e}_4^i A \frac{\Delta x}{2} + \rho A \frac{\Delta x}{2} c_p \frac{T_4^{i+1} - T_4^i}{\Delta t} \right) \Delta t \end{aligned}$$

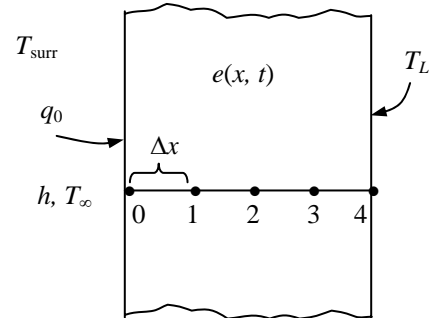

5-80 Starting with an energy balance on a volume element, the two-dimensional transient *explicit* finite difference equation for a general interior node in rectangular coordinates for $T(x, y, t)$ for the case of constant thermal conductivity and no heat generation is to be obtained.

Analysis (See Figure 5-49 in the text). We consider a rectangular region in which heat conduction is significant in the x and y directions, and consider a unit depth of $\Delta z = 1$ in the z direction. There is no heat generation in the medium, and the thermal conductivity k of the medium is constant. Now we divide the x - y plane of the region into a *rectangular mesh* of nodal points which are spaced Δx and Δy apart in the x and y directions, respectively, and consider a general interior node (m, n) whose coordinates are $x = m\Delta x$ and $y = n\Delta y$. Noting that the volume element centered about the general interior node (m, n) involves heat conduction from four sides (right, left, top, and bottom) and expressing them at previous time step i , the transient explicit finite difference formulation for a general interior node can be expressed as

$$\begin{aligned} k(\Delta y \times 1) \frac{T_{m-1,n}^i - T_{m,n}^i}{\Delta x} + k(\Delta x \times 1) \frac{T_{m,n+1}^i - T_{m,n}^i}{\Delta y} + k(\Delta y \times 1) \frac{T_{m+1,n}^i - T_{m,n}^i}{\Delta x} + k(\Delta x \times 1) \frac{T_{m,n-1}^i - T_{m,n}^i}{\Delta y} \\ = \rho(\Delta x \times \Delta y \times 1) c_p \frac{T_{m,n}^{i+1} - T_{m,n}^i}{\Delta t} \end{aligned}$$

Taking a square mesh ($\Delta x = \Delta y = l$) and dividing each term by k gives, after simplifying,

$$T_{m-1,n}^i + T_{m+1,n}^i + T_{m,n+1}^i + T_{m,n-1}^i - 4T_{m,n}^i = \frac{T_{m,n}^{i+1} - T_{m,n}^i}{\tau}$$

where $\alpha = k / \rho c_p$ is the thermal diffusivity of the material and $\tau = \alpha \Delta t / l^2$ is the dimensionless mesh Fourier number. It can also be expressed in terms of the temperatures at the neighboring nodes in the following easy-to-remember form:

$$T_{\text{left}}^i + T_{\text{top}}^i + T_{\text{right}}^i + T_{\text{bottom}}^i - 4T_{\text{node}}^i = \frac{T_{\text{node}}^{i+1} - T_{\text{node}}^i}{\tau}$$

Discussion We note that setting $T_{\text{node}}^{i+1} = T_{\text{node}}^i$ gives the steady finite difference formulation.

5-81 Starting with an energy balance on a volume element, the two-dimensional transient *implicit* finite difference equation for a general interior node in rectangular coordinates for $T(x, y, t)$ for the case of constant thermal conductivity and no heat generation is to be obtained.

Analysis (See Figure 5-49 in the text). We consider a rectangular region in which heat conduction is significant in the x and y directions, and consider a unit depth of $\Delta z = 1$ in the z direction. There is no heat generation in the medium, and the thermal conductivity k of the medium is constant. Now we divide the x - y plane of the region into a *rectangular mesh* of nodal points which are spaced Δx and Δy apart in the x and y directions, respectively, and consider a general interior node (m, n) whose coordinates are $x = m\Delta x$ and $y = n\Delta y$. Noting that the volume element centered about the general interior node (m, n) involves heat conduction from four sides (right, left, top, and bottom) and expressing them at previous time step i , the transient *implicit* finite difference formulation for a general interior node can be expressed as

$$\begin{aligned} k(\Delta y \times 1) \frac{T_{m-1,n}^{i+1} - T_{m,n}^{i+1}}{\Delta x} + k(\Delta x \times 1) \frac{T_{m,n+1}^{i+1} - T_{m,n}^{i+1}}{\Delta y} + k(\Delta y \times 1) \frac{T_{m+1,n}^{i+1} - T_{m,n}^i}{\Delta x} + k(\Delta x \times 1) \frac{T_{m,n-1}^{i+1} - T_{m,n}^{i+1}}{\Delta y} \\ = \rho(\Delta x \times \Delta y \times 1)c_p \frac{T_{m,n}^{i+1} - T_{m,n}^i}{\Delta t} \end{aligned}$$

Taking a square mesh ($\Delta x = \Delta y = l$) and dividing each term by k gives, after simplifying,

$$T_{m-1,n}^{i+1} + T_{m+1,n}^{i+1} + T_{m,n+1}^{i+1} + T_{m,n-1}^{i+1} - 4T_{m,n}^{i+1} = \frac{T_m^{i+1} - T_m^i}{\tau}$$

where $\alpha = k / \rho c_p$ is the thermal diffusivity of the material and $\tau = \alpha \Delta t / l^2$ is the dimensionless mesh Fourier number. It can also be expressed in terms of the temperatures at the neighboring nodes in the following easy-to-remember form:

$$T_{\text{left}}^{i+1} + T_{\text{top}}^{i+1} + T_{\text{right}}^{i+1} + T_{\text{bottom}}^{i+1} - 4T_{\text{node}}^{i+1} = \frac{T_{\text{node}}^{i+1} - T_{\text{node}}^i}{\tau}$$

Discussion We note that setting $T_{\text{node}}^{i+1} = T_{\text{node}}^i$ gives the steady finite difference formulation.

5-82 Starting with an energy balance on a disk volume element, the one-dimensional transient explicit finite difference equation for a general interior node for $T(z, t)$ in a cylinder whose side surface is insulated for the case of constant thermal conductivity with uniform heat generation is to be obtained.

Analysis We consider transient one-dimensional heat conduction in the axial z direction in an insulated cylindrical rod of constant cross-sectional area A with constant heat generation \dot{g}_0 and constant conductivity k with a mesh size of Δz in the z direction. Noting that the volume element of a general interior node m involves heat conduction from two sides and the volume of the element is $V_{\text{element}} = A\Delta z$, the transient explicit finite difference formulation for an interior node can be expressed as

$$kA \frac{T_{m-1}^i - T_m^i}{\Delta x} + kA \frac{T_{m+1}^i - T_m^i}{\Delta x} + \dot{g}_0 A \Delta x = \rho A \Delta x c_p \frac{T_m^{i+1} - T_m^i}{\Delta t}$$

Canceling the surface area A and multiplying by $\Delta x/k$, it simplifies to

$$T_{m-1}^i - 2T_m^i + T_{m+1}^i + \frac{\dot{g}_0 \Delta x^2}{k} = \frac{(\Delta x)^2}{\alpha \Delta t} (T_m^{i+1} - T_m^i)$$

where $\alpha = k / \rho c_p$ is the *thermal diffusivity* of the wall material.

Using the definition of the dimensionless *mesh Fourier number* $\tau = \frac{\alpha \Delta t}{\Delta x^2}$, the last equation reduces to

$$T_{m-1}^i - 2T_m^i + T_{m+1}^i + \frac{\dot{g}_0 \Delta x^2}{k} = \frac{T_m^{i+1} - T_m^i}{\tau}$$

Discussion We note that setting $T_m^{i+1} = T_m^i$ gives the steady finite difference formulation.

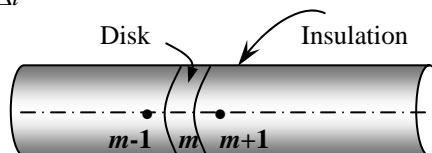

5-83 A composite plane wall consists of two layers A and B in perfect contact at the interface where node 1 is at the interface. The wall is insulated at the left (node 0) and subjected to radiation at the right boundary (node 2). The complete transient explicit finite difference formulation of this problem is to be obtained.

Assumptions **1** Heat transfer through the wall is given to be transient and one-dimensional, and the thermal conductivity to be constant. **2** Convection heat transfer is negligible. **3** There is no heat generation.

Analysis Using the energy balance approach with a unit area $A = 1$ and taking the direction of all heat transfers to be towards the node under consideration, the finite difference formulations become

Node 0 (at left boundary):

$$k_A \frac{T_1^i - T_0^i}{\Delta x} = \rho_A \frac{\Delta x}{2} c_{p,A} \frac{T_0^{i+1} - T_0^i}{\Delta t}$$

Node 1 (at interface):

$$k_A \frac{T_0^i - T_1^i}{\Delta x} + k_B \frac{T_2^i - T_1^i}{\Delta x} = \left(\rho_A \frac{\Delta x}{2} c_{p,A} + \rho_B \frac{\Delta x}{2} c_{p,B} \right) \frac{T_1^{i+1} - T_1^i}{\Delta t}$$

Node 2 (at right boundary):

$$\varepsilon \sigma [T_{\text{surr}}^4 - (T_2^i)^4] + k_B \frac{T_1^i - T_2^i}{\Delta x} = \rho_B \frac{\Delta x}{2} c_{p,B} \frac{T_2^{i+1} - T_2^i}{\Delta t}$$

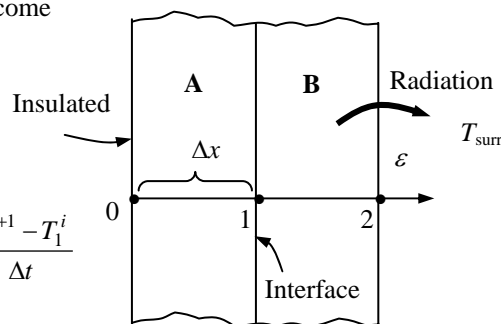

5-84 A pin fin with negligible heat transfer from its tip is considered. The complete explicit finite difference formulation for the determination of nodal temperatures is to be obtained.

Assumptions 1 Heat transfer through the pin fin is given to be steady and one-dimensional, and the thermal conductivity to be constant. 2 Convection heat transfer coefficient is constant and uniform. 3 Heat loss from the fin tip is given to be negligible.

Analysis The nodal network consists of 3 nodes, and the base temperature T_0 at node 0 is specified. Therefore, there are two unknowns T_1 and T_2 , and we need two equations to determine them. Using the energy balance approach and taking the direction of all heat transfers to be towards the node under consideration, the explicit transient finite difference formulations become

Node 1 (at midpoint):

$$\varepsilon\sigma p\Delta x[T_{\text{surr}}^4 - (T_1^i)^4] + hp\Delta x(T_\infty - T_1^i) + kA\frac{T_2^i - T_1^i}{\Delta x} + kA\frac{T_0^i - T_1^i}{\Delta x} = \rho A\Delta x c_p\frac{T_1^{i+1} - T_1^i}{\Delta t}$$

Node 2 (at fin tip):

$$\varepsilon\sigma\left(p\frac{\Delta x}{2}\right)[T_{\text{surr}}^4 - (T_2^i)^4] + h\left(p\frac{\Delta x}{2}\right)(T_\infty - T_2^i) + kA\frac{T_1^i - T_2^i}{\Delta x} = \rho A\frac{\Delta x}{2}c_p\frac{T_2^{i+1} - T_2^i}{\Delta t}$$

where $A = \pi D^2 / 4$ is the cross-sectional area and $p = \pi D$ is the perimeter of the fin.

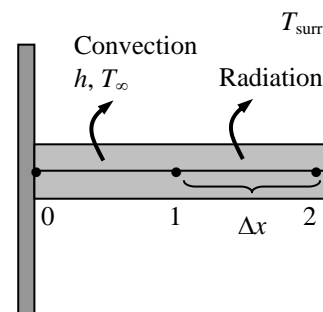

5-85 A pin fin with negligible heat transfer from its tip is considered. The complete finite difference formulation for the determination of nodal temperatures is to be obtained.

Assumptions 1 Heat transfer through the pin fin is given to be steady and one-dimensional, and the thermal conductivity to be constant. 2 Convection heat transfer coefficient is constant and uniform. 3 Heat loss from the fin tip is given to be negligible.

Analysis The nodal network consists of 3 nodes, and the base temperature T_0 at node 0 is specified. Therefore, there are two unknowns T_1 and T_2 , and we need two equations to determine them. Using the energy balance approach and taking the direction of all heat transfers to be towards the node under consideration, the implicit transient finite difference formulations become

$$\text{Node 1: } \varepsilon\sigma p\Delta x[T_{\text{surr}}^4 - (T_1^{i+1})^4] + hp\Delta x(T_\infty - T_1^{i+1}) + kA\frac{T_2^{i+1} - T_1^{i+1}}{\Delta x} + kA\frac{T_0^{i+1} - T_1^{i+1}}{\Delta x} = \rho A\Delta x c_p\frac{T_1^{i+1} - T_1^i}{\Delta t}$$

$$\text{Node 2: } \varepsilon\sigma\left(p\frac{\Delta x}{2}\right)[T_{\text{surr}}^4 - (T_2^{i+1})^4] + h\left(p\frac{\Delta x}{2}\right)(T_\infty - T_2^{i+1}) + kA\frac{T_1^{i+1} - T_2^{i+1}}{\Delta x} = \rho A\frac{\Delta x}{2}c_p\frac{T_2^{i+1} - T_2^i}{\Delta t}$$

where $A = \pi D^2 / 4$ is the cross-sectional area and $p = \pi D$ is the perimeter of the fin.

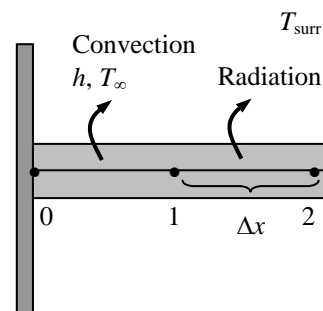

5-86 A uranium plate initially at a uniform temperature is subjected to insulation on one side and convection on the other. The transient finite difference formulation of this problem is to be obtained, and the nodal temperatures after 5 min and under steady conditions are to be determined.

Assumptions **1** Heat transfer is one-dimensional since the plate is large relative to its thickness. **2** Thermal conductivity is constant. **3** Radiation heat transfer is negligible.

Properties The conductivity and diffusivity are given to be $k = 28 \text{ W/m}\cdot^\circ\text{C}$ and $\alpha = 12.5 \times 10^{-6} \text{ m}^2/\text{s}$.

Analysis The nodal spacing is given to be $\Delta x = 0.02 \text{ m}$. Then the number of nodes becomes $M = L/\Delta x + 1 = 0.08/0.02 + 1 = 5$. This problem involves 5 unknown nodal temperatures, and thus we need to have 5 equations. Node 0 is on insulated boundary, and thus we can treat it as an interior node by using the mirror image concept. Nodes 1, 2, and 3 are interior nodes, and thus for them we can use the general explicit finite difference relation expressed as

$$T_{m-1}^i - 2T_m^i + T_{m+1}^i + \frac{\dot{e}_m^i \Delta x^2}{k} = \frac{T_m^{i+1} - T_m^i}{\tau}$$

$$\rightarrow T_m^{i+1} = \tau(T_{m-1}^i + T_{m+1}^i) + (1 - 2\tau)T_m^i + \tau \frac{\dot{e}_m^i \Delta x^2}{k}$$

The finite difference equation for node 4 on the right surface subjected to convection is obtained by applying an energy balance on the half volume element about node 4 and taking the direction of all heat transfers to be towards the node under consideration:

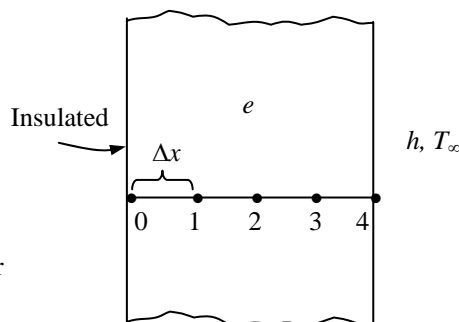

Node 0 (insulated): $T_0^{i+1} = \tau(T_1^i + T_1^i) + (1 - 2\tau)T_0^i + \tau \frac{\dot{e}_0 \Delta x^2}{k}$

Node 1 (interior): $T_1^{i+1} = \tau(T_0^i + T_2^i) + (1 - 2\tau)T_1^i + \tau \frac{\dot{e}_1 \Delta x^2}{k}$

Node 2 (interior): $T_2^{i+1} = \tau(T_1^i + T_3^i) + (1 - 2\tau)T_2^i + \tau \frac{\dot{e}_2 \Delta x^2}{k}$

Node 3 (interior): $T_3^{i+1} = \tau(T_2^i + T_4^i) + (1 - 2\tau)T_3^i + \tau \frac{\dot{e}_3 \Delta x^2}{k}$

Node 4 (convection): $h(T_\infty - T_4^i) + k \frac{T_3^i - T_4^i}{\Delta x} + \dot{e}_4 = \rho \frac{\Delta x}{2} c_p \frac{T_4^{i+1} - T_4^i}{\Delta t}$

or
$$T_4^{i+1} = \left(1 - 2\tau - 2\tau \frac{h\Delta x}{k}\right) T_4^i + 2\tau T_3^i + 2\tau \frac{h\Delta x}{k} T_\infty + \tau \frac{\dot{e}_4 (\Delta x)^2}{k}$$

where $\Delta x = 0.02 \text{ m}$, $\dot{e}_0 = 10^6 \text{ W/m}^3$, $k = 28 \text{ W/m}\cdot^\circ\text{C}$, $h = 35 \text{ W/m}^2\cdot^\circ\text{C}$, $T_\infty = 20^\circ\text{C}$, and $\alpha = 12.5 \times 10^{-6} \text{ m}^2/\text{s}$. The upper limit of the time step Δt is determined from the stability criteria that requires all primary coefficients to be greater than or equal to zero. The coefficient of T_4^i is smaller in this case, and thus the stability criteria for this problem can be expressed as

$$1 - 2\tau - 2\tau \frac{h\Delta x}{k} \geq 0 \rightarrow \tau \leq \frac{1}{2(1 + h\Delta x/k)} \rightarrow \Delta t \leq \frac{\Delta x^2}{2\alpha(1 + h\Delta x/k)}$$

since $\tau = \alpha\Delta t / \Delta x^2$. Substituting the given quantities, the maximum allowable the time step becomes

$$\Delta t \leq \frac{(0.02 \text{ m})^2}{2(12.5 \times 10^{-6} \text{ m}^2/\text{s})[1 + (35 \text{ W/m}^2\cdot^\circ\text{C})(0.02 \text{ m})/(28 \text{ W/m}\cdot^\circ\text{C})]} = 15.6 \text{ s}$$

Therefore, any time step less than 15.6 s can be used to solve this problem. For convenience, let us choose the time step to be $\Delta t = 15$ s. Then the mesh Fourier number becomes

$$\tau = \frac{\alpha \Delta t}{\Delta x^2} = \frac{(12.5 \times 10^{-6} \text{ m}^2/\text{s})(15 \text{ s})}{(0.02 \text{ m})^2} = 0.46875$$

Substituting this value of τ and other given quantities, the nodal temperatures after $5 \times 60 / 15 = 20$ time steps (5 min) are determined to be

After 5 min: $T_0 = 228.9^\circ\text{C}$, $T_1 = 228.4^\circ\text{C}$, $T_2 = 226.8^\circ\text{C}$, $T_3 = 224.0^\circ\text{C}$, and $T_4 = 219.9^\circ\text{C}$

(b) The time needed for transient operation to be established is determined by increasing the number of time steps until the nodal temperatures no longer change. In this case the nodal temperatures under steady conditions are determined to be

$$T_0 = 2420^\circ\text{C}, \quad T_1 = 2413^\circ\text{C}, \quad T_2 = 2391^\circ\text{C}, \quad T_3 = 2356^\circ\text{C}, \quad \text{and} \quad T_4 = 2306^\circ\text{C}$$

Discussion The steady solution can be checked independently by obtaining the steady finite difference formulation, and solving the resulting equations simultaneously.

5-87 EES Prob. 5-86 is reconsidered. The effect of the cooling time on the temperatures of the left and right sides of the plate is to be investigated.

Analysis The problem is solved using EES, and the solution is given below.

"GIVEN"

L=0.08 [m]
 k=28 [W/m-C]
 alpha=12.5E-6 [m^2/s]
 T_i=100 [C]
 g_dot=1E6 [W/m^3]
 T_infinity=20 [C]
 h=35 [W/m^2-C]
 DELTAX=0.02 [m]
 time=300 [s]

"ANALYSIS"

M=L/DELTAx+1 "Number of nodes"
 DELTAAt=15 "[s]"
 tau=(alpha*DELTAAt)/DELTAx^2

"The technique is to store the temperatures in the parametric table and recover them (as old temperatures)

using the variable ROW. The first row contains the initial values so Solve Table must begin at row 2.

Use the DUPLICATE statement to reduce the number of equations that need to be typed.

Column 1

contains the time, column 2 the value of T[1], column 3, the value of T[2], etc., and column 7 the Row."

Time=TableValue(Row-1,#Time)+DELTAAt

Duplicate i=1,5

T_old[i]=TableValue(Row-1,#T[i])

end

"Using the explicit finite difference approach, the six equations for the six unknown temperatures are determined to be"

T[1]=tau*(T_old[2]+T_old[2])+(1-2*tau)*T_old[1]+tau*(g_dot*DELTAx^2)/k "Node 1, insulated"

T[2]=tau*(T_old[1]+T_old[3])+(1-2*tau)*T_old[2]+tau*(g_dot*DELTAx^2)/k "Node 2"

T[3]=tau*(T_old[2]+T_old[4])+(1-2*tau)*T_old[3]+tau*(g_dot*DELTAx^2)/k "Node 3"

T[4]=tau*(T_old[3]+T_old[5])+(1-2*tau)*T_old[4]+tau*(g_dot*DELTAx^2)/k "Node 4"

T[5]=(1-2*tau-

2*tau*(h*DELTAx)/k)*T_old[5]+2*tau*T_old[4]+2*tau*(h*DELTAx)/k*T_infinity+tau*(g_dot*DELTAx^2)/k "Node 4, convection"

Time [s]	T ₁ [C]	T ₂ [C]	T ₃ [C]	T ₄ [C]	T ₅ [C]	Row
0	100	100	100	100	100	1
15	106.7	106.7	106.7	106.7	104.8	2
30	113.4	113.4	113.4	112.5	111.3	3
45	120.1	120.1	119.7	119	117	4
60	126.8	126.6	126.3	125.1	123.3	5
75	133.3	133.2	132.6	131.5	129.2	6
90	139.9	139.6	139.1	137.6	135.5	7
105	146.4	146.2	145.4	144	141.5	8
120	152.9	152.6	151.8	150.2	147.7	9
135	159.3	159.1	158.1	156.5	153.7	10
...
...
3465	1217	1213	1203	1185	1160	232
3480	1220	1216	1206	1188	1163	233
3495	1223	1220	1209	1192	1167	234
3510	1227	1223	1213	1195	1170	235
3525	1230	1227	1216	1198	1173	236
3540	1234	1230	1219	1201	1176	237
3555	1237	1233	1223	1205	1179	238
3570	1240	1237	1226	1208	1183	239
3585	1244	1240	1229	1211	1186	240
3600	1247	1243	1233	1214	1189	241

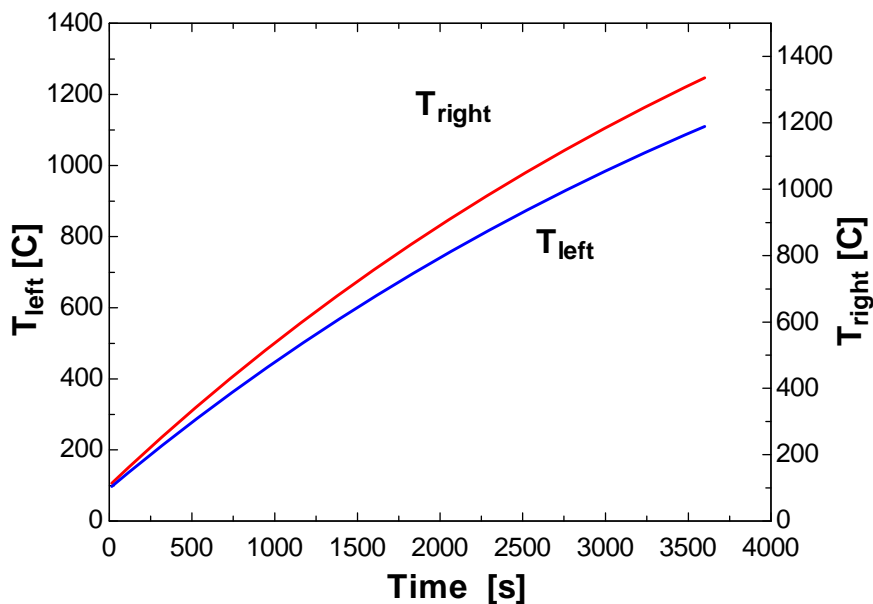

5-88 The passive solar heating of a house through a Trombe wall is studied. The temperature distribution in the wall in 12 h intervals and the amount of heat transfer during the first and second days are to be determined.

Assumptions 1 Heat transfer is one-dimensional since the exposed surface of the wall large relative to its thickness. 2 Thermal conductivity is constant. 3 The heat transfer coefficients are constant.

Properties The wall properties are given to be $k = 0.70 \text{ W/m}\cdot\text{C}$, $\alpha = 0.44 \times 10^{-6} \text{ m}^2/\text{s}$, and $\kappa = 0.76$. The hourly variation of monthly average ambient temperature and solar heat flux incident on a vertical surface is given to be

Time of day	Ambient Temperature, °C	Solar insolation W/m^2
7am-10am	0	375
10am-1pm	4	750
1pm-4pm	6	580
4pm-7pm	1	95
7pm-10pm	-2	0
10pm-1am	-3	0
1am-4am	-4	0
4am-7am	-4	0

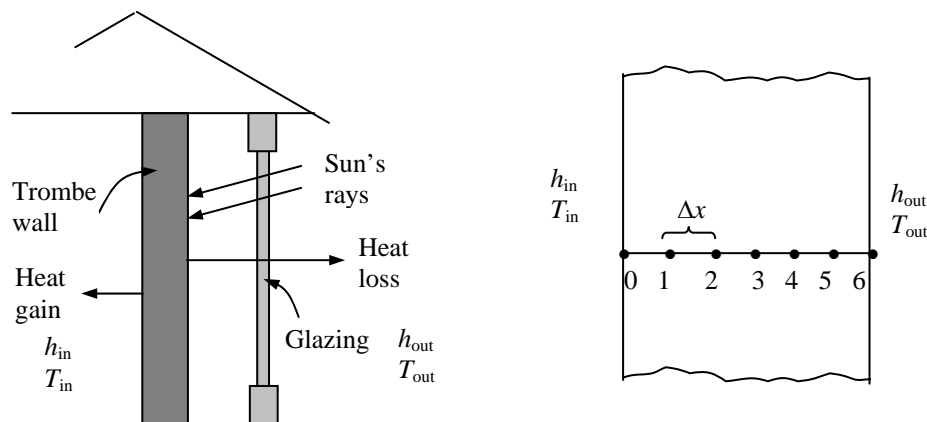

Analysis The nodal spacing is given to be $\Delta x = 0.05 \text{ m}$, Then the number of nodes becomes $M = L / \Delta x + 1 = 0.30 / 0.05 + 1 = 7$. This problem involves 7 unknown nodal temperatures, and thus we need to have 7 equations. Nodes 1, 2, 3, 4, and 5 are interior nodes, and thus for them we can use the general explicit finite difference relation expressed as

$$T_{m-1}^i - 2T_m^i + T_{m+1}^i + \frac{\dot{e}_m^i \Delta x^2}{k} = \frac{T_m^{i+1} - T_m^i}{\tau} \rightarrow T_m^{i+1} = \tau(T_{m-1}^i + T_{m+1}^i) + (1 - 2\tau)T_m^i$$

The finite difference equation for boundary nodes 0 and 6 are obtained by applying an energy balance on the half volume elements and taking the direction of all heat transfers to be towards the node under consideration:

$$\text{Node 0: } h_{in} A (T_{in}^i - T_0^i) + kA \frac{T_1^i - T_0^i}{\Delta x} = \rho A \frac{\Delta x}{2} c_p \frac{T_0^{i+1} - T_0^i}{\Delta t}$$

$$\text{or } T_0^{i+1} = \left(1 - 2\tau - 2\tau \frac{h_{in} \Delta x}{k} \right) T_0^i + 2\tau T_1^i + 2\tau \frac{h_{in} \Delta x}{k} T_{in}^i$$

$$\text{Node 1 (} m = 1 \text{): } T_1^{i+1} = \tau(T_0^i + T_2^i) + (1 - 2\tau)T_1^i$$

$$\text{Node 2 (} m = 2 \text{): } T_2^{i+1} = \tau(T_1^i + T_3^i) + (1 - 2\tau)T_2^i$$

$$\text{Node 3 } (m = 3): \quad T_3^{i+1} = \tau(T_2^i + T_4^i) + (1 - 2\tau)T_3^i$$

$$\text{Node 4 } (m = 4): \quad T_4^{i+1} = \tau(T_3^i + T_5^i) + (1 - 2\tau)T_4^i$$

$$\text{Node 5 } (m = 5): \quad T_5^{i+1} = \tau(T_4^i + T_6^i) + (1 - 2\tau)T_5^i$$

$$\text{Node 6} \quad h_{\text{out}}A(T_{\text{out}}^i - T_6^i) + \kappa A \dot{q}_{\text{solar}}^i + kA \frac{T_5^i - T_6^i}{\Delta x} = \rho A \frac{\Delta x}{2} c_p \frac{T_6^{i+1} - T_6^i}{\Delta t}$$

$$\text{or} \quad T_6^{i+1} = \left(1 - 2\tau - 2\tau \frac{h_{\text{out}} \Delta x}{k}\right) T_6^i + 2\tau T_5^i + 2\tau \frac{h_{\text{out}} \Delta x}{k} T_{\text{out}}^i + 2\tau \frac{\kappa \dot{q}_{\text{solar}}^i \Delta x}{k}$$

where $L = 0.30$ m, $k = 0.70$ W/m \cdot °C, $\alpha = 0.44 \times 10^{-6}$ m²/s, T_{out} and \dot{q}_{solar} are as given in the table, $\kappa = 0.76$ h_{out} = 3.4 W/m²·°C, $T_{\text{in}} = 20$ °C, $h_{\text{in}} = 9.1$ W/m²·°C, and $\Delta x = 0.05$ m.

Next we need to determine the upper limit of the time step Δt from the stability criteria since we are using the explicit method. This requires the identification of the smallest primary coefficient in the system. We know that the boundary nodes are more restrictive than the interior nodes, and thus we examine the formulations of the boundary nodes 0 and 6 only. The smallest and thus the most restrictive primary coefficient in this case is the coefficient of T_0^i in the formulation of node 0 since $h_{\text{in}} > h_{\text{out}}$, and thus

$$1 - 2\tau - 2\tau \frac{h_{\text{in}} \Delta x}{k} < 1 - 2\tau - 2\tau \frac{h_{\text{out}} \Delta x}{k}$$

Therefore, the stability criteria for this problem can be expressed as

$$1 - 2\tau - 2\tau \frac{h_{\text{in}} \Delta x}{k} \geq 0 \quad \rightarrow \quad \tau \leq \frac{1}{2(1 + h_{\text{in}} \Delta x / k)} \quad \rightarrow \quad \Delta t \leq \frac{\Delta x^2}{2\alpha(1 + h_{\text{in}} \Delta x / k)}$$

since $\tau = \alpha \Delta t / \Delta x^2$. Substituting the given quantities, the maximum allowable the time step becomes

$$\Delta t \leq \frac{(0.05 \text{ m})^2}{2(0.44 \times 10^{-6} \text{ m}^2/\text{s})[1 + (9.1 \text{ W/m}^2 \cdot \text{°C})(0.05 \text{ m}) / (0.70 \text{ W/m} \cdot \text{°C})]} = 1722 \text{ s}$$

Therefore, any time step less than 1722 s can be used to solve this problem. For convenience, let us choose the time step to be $\Delta t = 900$ s = 15 min. Then the mesh Fourier number becomes

$$\tau = \frac{\alpha \Delta t}{\Delta x^2} = \frac{(0.44 \times 10^{-6} \text{ m}^2/\text{s})(900 \text{ s})}{(0.05 \text{ m})^2} = 0.1584$$

Initially (at 7 am or $t = 0$), the temperature of the wall is said to vary linearly between 20°C at node 0 and 0°C at node 6. Noting that there are 6 nodal spacing of equal length, the temperature change between two neighboring nodes is $(20 - 0)^\circ\text{C}/6 = 3.33^\circ\text{C}$. Therefore, the initial nodal temperatures are

$$T_0^0 = 20^\circ\text{C}, \quad T_1^0 = 16.66^\circ\text{C}, \quad T_2^0 = 13.33^\circ\text{C}, \quad T_3^0 = 10^\circ\text{C}, \quad T_4^0 = 6.66^\circ\text{C}, \quad T_5^0 = 3.33^\circ\text{C}, \quad T_6^0 = 0^\circ\text{C}$$

Substituting the given and calculated quantities, the nodal temperatures after 6, 12, 18, 24, 30, 36, 42, and 48 h are calculated and presented in the following table and chart.

Time	Time step, i	Nodal temperatures, °C						
		T_0	T_1	T_2	T_3	T_4	T_5	T_6
0 h (7am)	0	20.0	16.7	13.3	10.0	6.66	3.33	0.0
6 h (1 pm)	24	17.5	16.1	15.9	18.1	24.8	38.8	61.5
12 h (7 pm)	48	21.4	22.9	25.8	30.2	34.6	37.2	35.8
18 h (1 am)	72	22.9	24.6	26.0	26.6	26.0	23.5	19.1
24 h (7 am)	96	21.6	22.5	22.7	22.1	20.4	17.7	13.9
30 h (1 pm)	120	21.0	21.8	23.4	26.8	34.1	47.6	68.9
36 h (7 pm)	144	24.1	27.0	31.3	36.4	41.1	43.2	40.9
42 h (1 am)	168	24.7	27.6	29.9	31.1	30.5	27.8	22.6
48 h (7 am)	192	23.0	24.6	25.5	25.2	23.7	20.7	16.3

The rate of heat transfer from the Trombe wall to the interior of the house during each time step is determined from Newton's law of cooling using the average temperature at the inner surface of the wall (node 0) as

$$\dot{Q}_{\text{Trombe wall}}^i = \dot{Q}_{\text{Trombe wall}}^i \Delta t = h_{\text{in}} A (T_0^i - T_{\text{in}}) \Delta t = h_{\text{in}} A [(T_0^i + T_0^{i-1}) / 2 - T_{\text{in}}] \Delta t$$

Therefore, the amount of heat transfer during the first time step ($i = 1$) or during the first 15 min period is $Q_{\text{Trombe wall}}^1 = h_{\text{in}} A [(T_0^1 + T_0^0) / 2 - T_{\text{in}}] \Delta t = (9.1 \text{ W/m}^2 \cdot \text{°C})(2.8 \times 7 \text{ m}^2)[(68.3 + 70) / 2 - 70^\circ\text{C}](0.25 \text{ h}) = -96.8 \text{ kWh}$

The negative sign indicates that heat is transferred to the Trombe wall from the air in the house which represents a heat loss. Then the total heat transfer during a specified time period is determined by adding the heat transfer amounts for each time step as

$$Q_{\text{Trombe wall}} = \sum_{i=1}^I \dot{Q}_{\text{Trombe wall}}^i = \sum_{i=1}^I h_{\text{in}} A [(T_0^i + T_0^{i-1}) / 2 - T_{\text{in}}] \Delta t$$

where I is the total number of time intervals in the specified time period. In this case $I = 48$ for 12 h, 96 for 24 h, etc. Following the approach described above using a computer, the amount of heat transfer between the Trombe wall and the interior of the house is determined to be

$$Q_{\text{Trombe wall}} = -3421 \text{ kWh after 12 h}$$

$$Q_{\text{Trombe wall}} = 1753 \text{ kWh after 24 h}$$

$$Q_{\text{Trombe wall}} = 5393 \text{ kWh after 36 h}$$

$$Q_{\text{Trombe wall}} = 15,230 \text{ kWh after 48 h}$$

Discussion Note that the interior temperature of the Trombe wall drops in early morning hours, but then rises as the solar energy absorbed by the exterior surface diffuses through the wall. The exterior surface temperature of the Trombe wall rises from 0 to 61.5°C in just 6 h because of the solar energy absorbed, but then drops to 13.9°C by next morning as a result of heat loss at night. Therefore, it may be worthwhile to cover the outer surface at night to minimize the heat losses.

Also the house loses 3421 kWh through the Trombe wall the 1st daytime as a result of the low start-up temperature, but delivers about 13,500 kWh of heat to the house the second day. It can be shown that the Trombe wall will deliver even more heat to the house during the 3rd day since it will start the day at a higher average temperature.

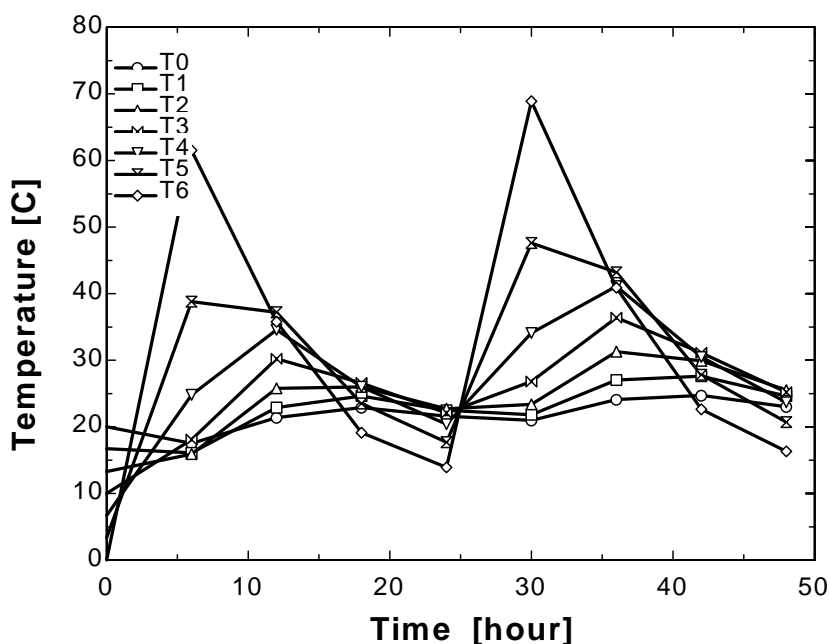

5-89 Heat conduction through a long L-shaped solid bar with specified boundary conditions is considered. The temperature at the top corner (node #3) of the body after 2, 5, and 30 min is to be determined with the transient explicit finite difference method.

Assumptions 1 Heat transfer through the body is given to be transient and two-dimensional. **2** Thermal conductivity is constant. **3** Heat generation is uniform.

Properties The conductivity and diffusivity are given to be $k = 15 \text{ W/m}\cdot\text{°C}$ and $\alpha = 3.2 \times 10^{-6} \text{ m}^2/\text{s}$.

Analysis The nodal spacing is given to be $\Delta x = \Delta y = l = 0.015 \text{ m}$. The explicit finite difference equations are determined on the basis of the energy balance for the transient case expressed as

$$\sum_{\text{All sides}} \dot{Q}^i + \dot{E}_{\text{element}}^i = \rho V_{\text{element}} c_p \frac{T_m^{i+1} - T_m^i}{\Delta t}$$

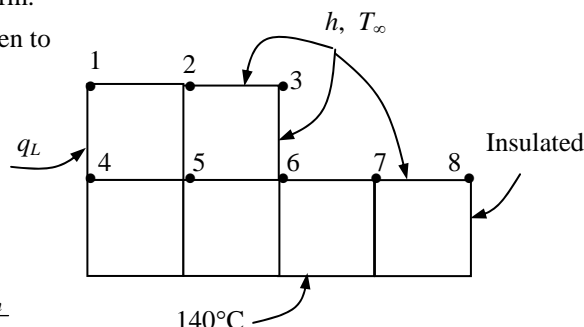

The quantities h, T_∞, \dot{e} , and \dot{q}_R do not change with time, and thus we do not need to use the superscript i for them. Also, the energy balance expressions can be simplified using the definitions of thermal diffusivity $\alpha = k / \rho c_p$ and the dimensionless mesh Fourier number $\tau = \alpha \Delta t / l^2$ where $\Delta x = \Delta y = l$. We note that all nodes are boundary nodes except node 5 that is an interior node. Therefore, we will have to rely on energy balances to obtain the finite difference equations. Using energy balances, the finite difference equations for each of the 8 nodes are obtained as follows:

$$\text{Node 1: } \dot{q}_L \frac{l}{2} + h \frac{l}{2} (T_\infty - T_1^i) + k \frac{l}{2} \frac{T_2^i - T_1^i}{l} + k \frac{l}{2} \frac{T_4^i - T_1^i}{l} + \dot{e}_0 \frac{l^2}{4} = \rho \frac{l^2}{4} c_p \frac{T_1^{i+1} - T_1^i}{\Delta t}$$

$$\text{Node 2: } hl(T_\infty - T_2^i) + k \frac{l}{2} \frac{T_1^i - T_2^i}{l} + k \frac{l}{2} \frac{T_3^i - T_2^i}{l} + kl \frac{T_5^i - T_2^i}{l} + \dot{e}_0 \frac{l^2}{2} = \rho \frac{l^2}{2} c_p \frac{T_2^{i+1} - T_2^i}{\Delta t}$$

$$\text{Node 3: } hl(T_\infty - T_3^i) + k \frac{l}{2} \frac{T_2^i - T_3^i}{l} + k \frac{l}{2} \frac{T_6^i - T_3^i}{l} + \dot{e}_0 \frac{l^2}{4} = \rho \frac{l^2}{4} c_p \frac{T_3^{i+1} - T_3^i}{\Delta t}$$

$$\left(\text{It can be rearranged as } T_3^{i+1} = \left(1 - 4\tau - 4\tau \frac{hl}{k} \right) T_3^i + 2\tau \left(T_4^i + T_6^i + 2 \frac{hl}{k} T_\infty + \frac{\dot{e}_0 l^2}{2k} \right) \right)$$

$$\text{Node 4: } \dot{q}_L l + k \frac{l}{2} \frac{T_1^i - T_4^i}{l} + k \frac{l}{2} \frac{140 - T_4^i}{l} + kl \frac{T_5^i - T_4^i}{l} + \dot{e}_0 \frac{l^2}{2} = \rho \frac{l^2}{2} c_p \frac{T_4^{i+1} - T_4^i}{\Delta t}$$

$$\text{Node 5 (interior): } T_5^{i+1} = \left(1 - 4\tau \right) T_5^i + \tau \left(T_2^i + T_4^i + T_6^i + 140 + \frac{\dot{e}_0 l^2}{k} \right)$$

$$\text{Node 6: } hl(T_\infty - T_6^i) + k \frac{l}{2} \frac{T_3^i - T_6^i}{l} + kl \frac{T_5^i - T_6^i}{l} + kl \frac{140 - T_6^i}{l} + k \frac{l}{2} \frac{T_7^i - T_6^i}{l} + \dot{e}_0 \frac{3l^2}{4} = \rho \frac{3l^2}{4} c_p \frac{T_6^{i+1} - T_6^i}{\Delta t}$$

$$\text{Node 7: } hl(T_\infty - T_7^i) + k \frac{l}{2} \frac{T_6^i - T_7^i}{l} + k \frac{l}{2} \frac{T_8^i - T_7^i}{l} + kl \frac{140 - T_7^i}{l} + \dot{e}_0 \frac{l^2}{2} = \rho \frac{l^2}{2} c_p \frac{T_7^{i+1} - T_7^i}{\Delta t}$$

$$\text{Node 8: } h \frac{l}{2} (T_\infty - T_8^i) + k \frac{l}{2} \frac{T_7^i - T_8^i}{l} + k \frac{l}{2} \frac{140 - T_8^i}{l} + \dot{e}_0 \frac{l^2}{4} = \rho \frac{l^2}{4} c_p \frac{T_8^{i+1} - T_8^i}{\Delta t}$$

where $\dot{e}_0 = 2 \times 10^7 \text{ W/m}^3$, $\dot{q}_L = 8000 \text{ W/m}^2$, $l = 0.015 \text{ m}$, $k = 15 \text{ W/m}\cdot\text{°C}$, $h = 80 \text{ W/m}^2\cdot\text{°C}$, and $T_\infty = 25^\circ\text{C}$.

The upper limit of the time step Δt is determined from the stability criteria that requires the coefficient of T_m^i in the T_m^{i+1} expression (the primary coefficient) be greater than or equal to zero for all nodes. The smallest primary coefficient in the 8 equations above is the coefficient of T_3^i in the T_3^{i+1} expression since it is exposed to most convection per unit volume (this can be verified), and thus the stability criteria for this problem can be expressed as

$$1 - 4\tau - 4\tau \frac{hl}{k} \geq 0 \quad \rightarrow \quad \tau \leq \frac{1}{4(1 + hl/k)} \quad \rightarrow \quad \Delta t \leq \frac{l^2}{4\alpha(1 + hl/k)}$$

since $\tau = \alpha\Delta t / l^2$. Substituting the given quantities, the maximum allowable value of the time step is determined to be

$$\Delta t \leq \frac{(0.015 \text{ m})^2}{4(3.2 \times 10^{-6} \text{ m}^2/\text{s})[1 + (80 \text{ W/m}^2 \cdot \text{°C})(0.015 \text{ m})/(15 \text{ W/m} \cdot \text{°C})]} = 16.3 \text{ s}$$

Therefore, any time step less than 16.3 s can be used to solve this problem. For convenience, we choose the time step to be $\Delta t = 15$ s. Then the mesh Fourier number becomes

$$\tau = \frac{\alpha\Delta t}{l^2} = \frac{(3.2 \times 10^{-6} \text{ m}^2/\text{s})(15 \text{ s})}{(0.015 \text{ m})^2} = 0.2133 \quad (\text{for } \Delta t = 15 \text{ s})$$

Using the specified initial condition as the solution at time $t = 0$ (for $i = 0$), sweeping through the 9 equations above will give the solution at intervals of 15 s. Using a computer, the solution at the upper corner node (node 3) is determined to be **441**, **520**, and **529**°C at 2, 5, and 30 min, respectively. It can be shown that the steady state solution at node 3 is 531°C.

5-90 EES Prob. 5-89 is reconsidered. The temperature at the top corner as a function of heating time is to be plotted.

Analysis The problem is solved using EES, and the solution is given below.

"GIVEN"

T_i=140 [C]
 k=15 [W/m-C]
 alpha=3.2E-6 [m^2/s]
 e_dot=2E7 [W/m^3]
 T_bottom=140 [C]
 T_infinity=25 [C]
 h=80 [W/m^2-C]
 q_dot_L=8000 [W/m^2]
 DELTAX=0.015 [m]
 DELTAY=0.015 [m]
 time=120 [s]

"ANALYSIS"

I=DELTAx
 DELTAt=15 "[s]"
 tau=(alpha*DELTAx)/I^2
 RhoC=k/alpha "RhoC=rho*C"
 "The technique is to store the temperatures in the parametric table and recover them (as old temperatures) using the variable ROW. The first row contains the initial values so Solve Table must begin at row 2.
 Use the DUPLICATE statement to reduce the number of equations that need to be typed.
 Column 1
 contains the time, column 2 the value of T[1], column 3, the value of T[2], etc., and column 10 the Row."
 Time=TableValue('Table 1',Row-1,#Time)+DELTAx
 Duplicate i=1,8
 T_old[i]=TableValue('Table 1',Row-1,#T[i])
 end
 "Using the explicit finite difference approach, the eight equations for the eight unknown temperatures are determined to be"
 q_dot_L*I/2+h*I/2*(T_infinity-T_old[1])+k*I/2*(T_old[2]-T_old[1])/I+k*I/2*(T_old[4]-T_old[1])/I+e_dot*I^2/4=RhoC*I^2/4*(T[1]-T_old[1])/DELTAx "Node 1"
 h*I*(T_infinity-T_old[2])+k*I/2*(T_old[1]-T_old[2])/I+k*I/2*(T_old[3]-T_old[2])/I+k*I*(T_old[5]-T_old[2])/I+e_dot*I^2/2=RhoC*I^2/2*(T[2]-T_old[2])/DELTAx "Node 2"
 h*I*(T_infinity-T_old[3])+k*I/2*(T_old[2]-T_old[3])/I+k*I/2*(T_old[6]-T_old[3])/I+e_dot*I^2/4=RhoC*I^2/4*(T[3]-T_old[3])/DELTAx "Node 3"
 q_dot_L*I+k*I/2*(T_old[1]-T_old[4])/I+k*I/2*(T_bottom-T_old[4])/I+k*I*(T_old[5]-T_old[4])/I+e_dot*I^2/2=RhoC*I^2/2*(T[4]-T_old[4])/DELTAx "Node 4"
 T[5]=(1-4*tau)*T_old[5]+tau*(T_old[2]+T_old[4]+T_old[6]+T_bottom+e_dot*I^2/k) "Node 5"
 h*I*(T_infinity-T_old[6])+k*I/2*(T_old[3]-T_old[6])/I+k*I*(T_old[5]-T_old[6])/I+k*I*(T_bottom-T_old[6])/I+k*I/2*(T_old[7]-T_old[6])/I+e_dot*I^3/4*I^2=RhoC*I^3/4*I^2*(T[6]-T_old[6])/DELTAx "Node 6"
 h*I*(T_infinity-T_old[7])+k*I/2*(T_old[6]-T_old[7])/I+k*I/2*(T_old[8]-T_old[7])/I+k*I*(T_bottom-T_old[7])/I+e_dot*I^2/2=RhoC*I^2/2*(T[7]-T_old[7])/DELTAx "Node 7"
 h*I/2*(T_infinity-T_old[8])+k*I/2*(T_old[7]-T_old[8])/I+k*I/2*(T_bottom-T_old[8])/I+e_dot*I^2/4=RhoC*I^2/4*(T[8]-T_old[8])/DELTAx "Node 8"

Time [s]	T ₁ [C]	T ₂ [C]	T ₃ [C]	T ₄ [C]	T ₅ [C]	T ₆ [C]	T ₇ [C]	T ₈ [C]	Row
0	140	140	140	140	140	140	140	140	1
15	203.5	200.1	196.1	207.4	204	201.4	200.1	200.1	2
30	265	259.7	252.4	258.2	253.7	243.7	232.7	232.5	3
45	319	312.7	300.3	299.9	293.5	275.7	252.4	250.1	4
60	365.5	357.4	340.3	334.6	326.4	300.7	265.2	260.4	5
75	404.6	394.9	373.2	363.6	353.5	320.6	274.1	267	6
90	437.4	426.1	400.3	387.8	375.9	336.7	280.8	271.6	7
105	464.7	451.9	422.5	407.9	394.5	349.9	286	275	8
120	487.4	473.3	440.9	424.5	409.8	360.7	290.1	277.5	9
135	506.2	491	456.1	438.4	422.5	369.6	293.4	279.6	10
...
...
1650	596.3	575.7	528.5	504.6	483.1	411.9	308.8	288.9	111
1665	596.3	575.7	528.5	504.6	483.1	411.9	308.8	288.9	112
1680	596.3	575.7	528.5	504.6	483.1	411.9	308.8	288.9	113
1695	596.3	575.7	528.5	504.6	483.1	411.9	308.8	288.9	114
1710	596.3	575.7	528.5	504.6	483.1	411.9	308.8	288.9	115
1725	596.3	575.7	528.5	504.6	483.1	411.9	308.8	288.9	116
1740	596.3	575.7	528.5	504.6	483.1	411.9	308.8	288.9	117
1755	596.3	575.7	528.5	504.6	483.1	411.9	308.8	288.9	118
1770	596.3	575.7	528.5	504.6	483.1	411.9	308.8	288.9	119
1785	596.3	575.7	528.5	504.6	483.1	411.9	308.8	288.9	120

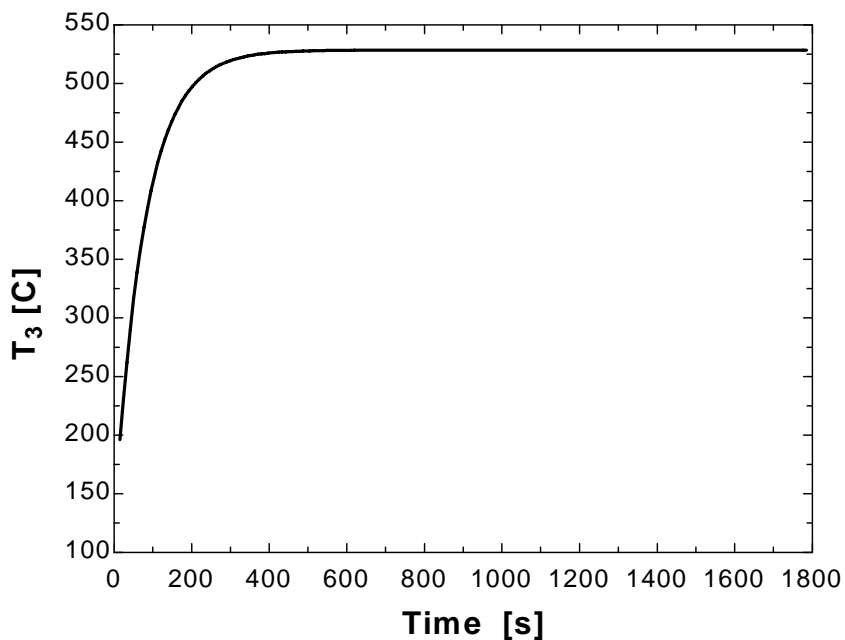

5-91 A long solid bar is subjected to transient two-dimensional heat transfer. The centerline temperature of the bar after 20 min and after steady conditions are established are to be determined.

Assumptions 1 Heat transfer through the body is given to be transient and two-dimensional. **2** Heat is generated uniformly in the body. **3** The heat transfer coefficient also includes the radiation effects.

Properties The conductivity and diffusivity are given to be $k = 28$ W/m·°C and $\alpha = 12 \times 10^{-6}$ m²/s.

Analysis The nodal spacing is given to be $\Delta x = \Delta y = l = 0.1$ m. The explicit finite difference equations are determined on the basis of the energy balance for the transient case expressed as

$$\sum_{\text{All sides}} \dot{Q}^i + \dot{E}_{\text{element}}^i = \rho V_{\text{element}} c_p \frac{T_m^{i+1} - T_m^i}{\Delta t}$$

The quantities h, T_∞ , and \dot{e}_0 do not change with time, and thus we do not need to use the superscript i for them. The general explicit finite difference form of an interior node for transient two-dimensional heat conduction is expressed as

$$T_{\text{node}}^{i+1} = \tau(T_{\text{left}}^i + T_{\text{top}}^i + T_{\text{right}}^i + T_{\text{bottom}}^i) + (1 - 4\tau)T_{\text{node}}^i + \tau \frac{\dot{e}_{\text{node}}^i l^2}{k}$$

There is symmetry about the vertical, horizontal, and diagonal lines passing through the center. Therefore, $T_1 = T_3 = T_7 = T_9$ and $T_2 = T_4 = T_6 = T_8$, and T_1, T_2 , and T_5 are the only 3 unknown nodal temperatures, and thus we need only 3 equations to determine them uniquely. Also, we can replace the symmetry lines by insulation and utilize the mirror-image concept when writing the finite difference equations for the interior nodes. The finite difference equations for boundary nodes are obtained by applying an energy balance on the volume elements and taking the direction of all heat transfers to be towards the node under consideration:

$$\text{Node 1: } hl(T_\infty - T_1^i) + k \frac{l}{2} \frac{T_2^i - T_1^i}{l} + k \frac{l}{2} \frac{T_4^i - T_1^i}{l} + \dot{e}_0 \frac{l^2}{4} = \rho \frac{l^2}{4} c \frac{T_1^{i+1} - T_1^i}{\Delta t}$$

$$\text{Node 2: } h \frac{l}{2} (T_\infty - T_2^i) + k \frac{l}{2} \frac{T_1^i - T_2^i}{l} + k \frac{l}{2} \frac{T_5^i - T_2^i}{l} + \dot{e}_0 \frac{l^2}{4} = \rho \frac{l^2}{4} c \frac{T_2^{i+1} - T_2^i}{\Delta t}$$

$$\text{Node 5 (interior): } T_5^{i+1} = (1 - 4\tau)T_5^i + \tau \left(4T_2^i + \frac{\dot{e}_0 l^2}{k} \right)$$

where $\dot{e}_0 = 8 \times 10^5$ W/m³, $l = 0.1$ m, and $k = 28$ W/m·°C, $h = 45$ W/m²·°C, and $T_\infty = 30^\circ\text{C}$.

The upper limit of the time step Δt is determined from the stability criteria that requires the coefficient of T_m^i in the T_m^{i+1} expression (the primary coefficient) be greater than or equal to zero for all nodes. The smallest primary coefficient in the 3 equations above is the coefficient of T_1^i in the T_1^{i+1} expression since it is exposed to most convection per unit volume (this can be verified), and thus the stability criteria for this problem can be expressed as

$$1 - 4\tau - 4\tau \frac{hl}{k} \geq 0 \rightarrow \tau \leq \frac{1}{4(1 + hl/k)} \rightarrow \Delta t \leq \frac{l^2}{4\alpha(1 + hl/k)}$$

since $\tau = \alpha \Delta t / l^2$. Substituting the given quantities, the maximum allowable value of the time step is determined to be

$$\Delta t \leq \frac{(0.1 \text{ m})^2}{4(12 \times 10^{-6} \text{ m}^2/\text{s})[1 + (45 \text{ W/m}^2 \cdot ^\circ\text{C})(0.1 \text{ m}) / (28 \text{ W/m} \cdot ^\circ\text{C})]} = 179 \text{ s}$$

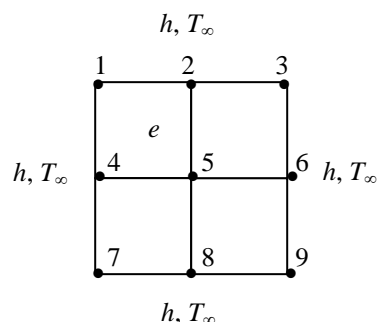

Therefore, any time step less than 179 s can be used to solve this problem. For convenience, we choose the time step to be $\Delta t = 60$ s. Then the mesh Fourier number becomes

$$\tau = \frac{\alpha \Delta t}{l^2} = \frac{(12 \times 10^{-6} \text{ m}^2/\text{s})(60 \text{ s})}{(0.1 \text{ m})^2} = 0.072 \quad (\text{for } \Delta t = 60 \text{ s})$$

Using the specified initial condition as the solution at time $t = 0$ (for $i = 0$), sweeping through the 3 equations above will give the solution at intervals of 1 min. Using a computer, the solution at the center node (node 5) is determined to be 217.2°C, 302.8°C, **379.3°C**, 447.7°C, 508.9°C, 612.4°C, 695.1°C, and 761.2°C at 10, 15, 20, 25, 30, 40, 50, and 60 min, respectively. Continuing in this manner, it is observed that steady conditions are reached in the medium after about 6 hours for which the temperature at the center node is **1023°C**.

5-92E A plain window glass initially at a uniform temperature is subjected to convection on both sides. The transient finite difference formulation of this problem is to be obtained, and it is to be determined how long it will take for the fog on the windows to clear up (i.e., for the inner surface temperature of the window glass to reach 54°F).

Assumptions 1 Heat transfer is one-dimensional since the window is large relative to its thickness. **2** Thermal conductivity is constant. **3** Radiation heat transfer is negligible.

Properties The conductivity and diffusivity are given to be $k = 0.48 \text{ Btu/h}\cdot\text{ft}\cdot^\circ\text{F}$ and $\alpha = 4.2 \times 10^{-6} \text{ ft}^2/\text{s}$.

Analysis The nodal spacing is given to be $\Delta x = 0.125 \text{ in.}$ Then the number of nodes becomes $M = L / \Delta x + 1 = 0.375 / 0.125 + 1 = 4$. This problem involves 4 unknown nodal temperatures, and thus we need to have 4 equations. Nodes 2 and 3 are interior nodes, and thus for them we can use the general explicit finite difference relation expressed as

$$T_{m-1}^i - 2T_m^i + T_{m+1}^i + \frac{\dot{e}_m^i \Delta x^2}{k} = \frac{T_m^{i+1} - T_m^i}{\tau} \rightarrow T_m^{i+1} = \tau(T_{m-1}^i + T_{m+1}^i) + (1 - 2\tau)T_m^i$$

since there is no heat generation. The finite difference equation for nodes 1 and 4 on the surfaces subjected to convection is obtained by applying an energy balance on the half volume element about the node, and taking the direction of all heat transfers to be towards the node under consideration:

$$\text{Node 1 (convection): } h_i(T_i - T_1^i) + k \frac{T_2^i - T_1^i}{\Delta x} = \rho \frac{\Delta x}{2} c_p \frac{T_1^{i+1} - T_1^i}{\Delta t}$$

$$\text{or } T_1^{i+1} = \left(1 - 2\tau - 2\tau \frac{h_i \Delta x}{k}\right) T_1^i + 2\tau T_2^i + 2\tau \frac{h_i \Delta x}{k} T_i$$

$$\text{Node 2 (interior): } T_2^{i+1} = \tau(T_1^i + T_3^i) + (1 - 2\tau)T_2^i$$

$$\text{Node 3 (interior): } T_3^{i+1} = \tau(T_2^i + T_4^i) + (1 - 2\tau)T_3^i$$

$$\text{Node 4 (convection): } h_o(T_o - T_4^i) + k \frac{T_3^i - T_4^i}{\Delta x} = \rho \frac{\Delta x}{2} c_p \frac{T_4^{i+1} - T_4^i}{\Delta t}$$

$$\text{or } T_4^{i+1} = \left(1 - 2\tau - 2\tau \frac{h_o \Delta x}{k}\right) T_4^i + 2\tau T_3^i + 2\tau \frac{h_o \Delta x}{k} T_o$$

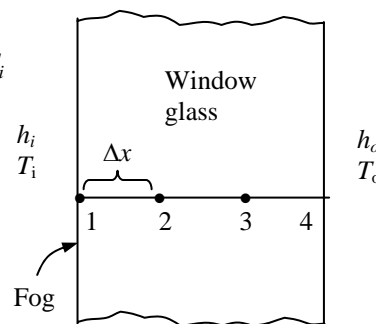

where $\Delta x = 0.125/12 \text{ ft}$, $k = 0.48 \text{ Btu/h}\cdot\text{ft}\cdot^\circ\text{F}$, $h_i = 1.2 \text{ Btu/h}\cdot\text{ft}^2\cdot^\circ\text{F}$, $T_i = 35 + 2*(t/60)^\circ\text{F}$ (t in seconds), $h_o = 2.6 \text{ Btu/h}\cdot\text{ft}^2\cdot^\circ\text{F}$, and $T_o = 35^\circ\text{F}$. The upper limit of the time step Δt is determined from the stability criteria that requires all primary coefficients to be greater than or equal to zero. The coefficient of T_4^i is smaller in this case, and thus the stability criteria for this problem can be expressed as

$$1 - 2\tau - 2\tau \frac{h_o \Delta x}{k} \geq 0 \rightarrow \tau \leq \frac{1}{2(1 + h_o \Delta x / k)} \rightarrow \Delta t \leq \frac{\Delta x^2}{2\alpha(1 + h_o \Delta x / k)}$$

since $\tau = \alpha \Delta t / \Delta x^2$. Substituting the given quantities, the maximum allowable time step becomes

$$\Delta t \leq \frac{(0.125 / 12 \text{ ft})^2}{2(4.2 \times 10^{-6} \text{ ft}^2/\text{s})[1 + (2.6 \text{ Btu/h}\cdot\text{ft}^2\cdot^\circ\text{F})(0.125 / 12 \text{ m}) / (0.48 \text{ Btu/h}\cdot\text{ft}\cdot^\circ\text{F})]} = 12.2 \text{ s}$$

Therefore, any time step less than 12.2 s can be used to solve this problem. For convenience, let us choose the time step to be $\Delta t = 10 \text{ s}$. Then the mesh Fourier number becomes

$$\tau = \frac{\alpha \Delta t}{\Delta x^2} = \frac{(4.2 \times 10^{-6} \text{ ft}^2/\text{s})(10 \text{ s})}{(0.125 / 12 \text{ ft})^2} = 0.3871$$

Substituting this value of τ and other given quantities, the time needed for the inner surface temperature of the window glass to reach 54°F to avoid fogging is determined to be *never*. This is because steady conditions are reached in about 156 min, and the inner surface temperature at that time is determined to be 48.0°F. Therefore, the window will be fogged at all times.

5-93 The formation of fog on the glass surfaces of a car is to be prevented by attaching electric resistance heaters to the inner surfaces. The temperature distribution throughout the glass 15 min after the strip heaters are turned on and also when steady conditions are reached are to be determined using the explicit method.

Assumptions 1 Heat transfer through the glass is given to be transient and two-dimensional. 2 Thermal conductivity is constant. 3 There is heat generation only at the inner surface, which will be treated as prescribed heat flux.

Properties The conductivity and diffusivity are given to be $k = 0.84 \text{ W/m}\cdot^\circ\text{C}$ and $\alpha = 0.39 \times 10^{-6} \text{ m}^2/\text{s}$.

Analysis The nodal spacing is given to be $\Delta x = 0.2 \text{ cm}$ and $\Delta y = 1 \text{ cm}$. The explicit finite difference equations are determined on the basis of the energy balance for the transient case expressed as

$$\sum_{\text{All sides}} \dot{Q}^i + \dot{E}_{\text{gen,element}}^i = \rho \nu_{\text{element}} c_p \frac{T_m^{i+1} - T_m^i}{\Delta t}$$

We consider only 9 nodes because of symmetry. Note that we do not have a square mesh in this case, and thus we will have to rely on energy balances to obtain the finite difference equations. Using energy balances, the finite difference equations for each of the 9 nodes are obtained as follows:

$$\text{Node 1: } h_i \frac{\Delta y}{2} (T_i - T_1^i) + k \frac{\Delta x}{2} \frac{T_4^i - T_1^i}{\Delta y} + k \frac{\Delta y}{2} \frac{T_2^i - T_1^i}{\Delta x} = \rho c_p \frac{\Delta x}{2} \frac{\Delta y}{2} \frac{T_1^{i+1} - T_1^i}{\Delta t}$$

$$\text{Node 2: } k \frac{\Delta y}{2} \frac{T_1^i - T_2^i}{\Delta x} + k \frac{\Delta y}{2} \frac{T_3^i - T_2^i}{\Delta x} + k \Delta x \frac{T_5^i - T_2^i}{\Delta y} = \rho c_p \Delta x \frac{\Delta y}{2} \frac{T_2^{i+1} - T_2^i}{\Delta t}$$

$$\text{Node 3: } h_o \frac{\Delta y}{2} (T_o - T_3^i) + k \frac{\Delta x}{2} \frac{T_6^i - T_3^i}{\Delta y} + k \frac{\Delta y}{2} \frac{T_2^i - T_3^i}{\Delta x} = \rho c_p \frac{\Delta x}{2} \frac{\Delta y}{2} \frac{T_3^{i+1} - T_3^i}{\Delta t}$$

$$\text{Node 4: } h_i \Delta y (T_i - T_4^i) + k \frac{\Delta x}{2} \frac{T_1^i - T_4^i}{\Delta y} + k \frac{\Delta x}{2} \frac{T_7^i - T_4^i}{\Delta y} + k \Delta y \frac{T_5^i - T_4^i}{\Delta x} = \rho c_p \Delta y \frac{\Delta x}{2} \frac{T_4^{i+1} - T_4^i}{\Delta t}$$

$$\text{Node 5: } k \Delta y \frac{T_4^i - T_5^i}{\Delta x} + k \Delta y \frac{T_6^i - T_5^i}{\Delta x} + k \Delta x \frac{T_8^i - T_5^i}{\Delta y} + k \Delta x \frac{T_2^i - T_5^i}{\Delta y} = \rho c_p \Delta x \Delta y \frac{T_5^{i+1} - T_5^i}{\Delta t}$$

$$\text{Node 6: } h_o \Delta y (T_i - T_6^i) + k \frac{\Delta x}{2} \frac{T_3^i - T_6^i}{\Delta y} + k \frac{\Delta x}{2} \frac{T_9^i - T_6^i}{\Delta y} + k \Delta y \frac{T_5^i - T_6^i}{\Delta x} = \rho c_p \Delta y \frac{\Delta x}{2} \frac{T_6^{i+1} - T_6^i}{\Delta t}$$

$$\text{Node 7: } 5 \text{ W} + h_i \frac{\Delta y}{2} (T_i - T_7^i) + k \frac{\Delta x}{2} \frac{T_4^i - T_7^i}{\Delta y} + k \frac{\Delta y}{2} \frac{T_8^i - T_7^i}{\Delta x} = \rho c_p \frac{\Delta x}{2} \frac{\Delta y}{2} \frac{T_7^{i+1} - T_7^i}{\Delta t}$$

$$\text{Node 8: } k \frac{\Delta y}{2} \frac{T_7^i - T_8^i}{\Delta x} + k \frac{\Delta y}{2} \frac{T_9^i - T_8^i}{\Delta x} + k \Delta x \frac{T_5^i - T_8^i}{\Delta y} = \rho c_p \Delta x \frac{\Delta y}{2} \frac{T_8^{i+1} - T_8^i}{\Delta t}$$

$$\text{Node 9: } h_o \frac{\Delta y}{2} (T_o - T_9^i) + k \frac{\Delta x}{2} \frac{T_6^i - T_9^i}{\Delta y} + k \frac{\Delta y}{2} \frac{T_8^i - T_9^i}{\Delta x} = \rho c_p \frac{\Delta x}{2} \frac{\Delta y}{2} \frac{T_9^{i+1} - T_9^i}{\Delta t}$$

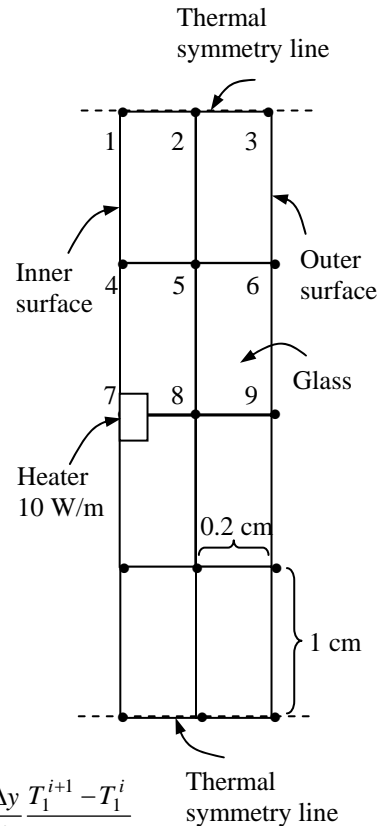

where $k = 0.84 \text{ W/m}\cdot\text{°C}$, $\alpha = k / \rho c = 0.39 \times 10^{-6} \text{ m}^2/\text{s}$, $T_i = T_o = -3^\circ\text{C}$, $h_i = 6 \text{ W/m}^2\cdot\text{°C}$, $h_o = 20 \text{ W/m}^2\cdot\text{°C}$, $\Delta x = 0.002 \text{ m}$, and $\Delta y = 0.01 \text{ m}$.

The upper limit of the time step Δt is determined from the stability criteria that requires the coefficient of T_m^i in the T_m^{i+1} expression (the primary coefficient) be greater than or equal to zero for all nodes. The smallest primary coefficient in the 9 equations above is the coefficient of T_6^i in the T_6^{i+1} expression since it is exposed to most convection per unit volume (this can be verified). The equation for node 6 can be rearranged as

$$T_6^{i+1} = \left[1 - 2\alpha\Delta t \left(\frac{h_o}{k\Delta x} + \frac{1}{\Delta y^2} + \frac{1}{\Delta x^2} \right) \right] T_6^i + 2\alpha\Delta t \left(\frac{h_o}{k\Delta x} T_o + \frac{T_3^i + T_9^i}{\Delta y^2} + \frac{T_5^i}{\Delta x^2} \right)$$

Therefore, the stability criteria for this problem can be expressed as

$$1 - 2\alpha\Delta t \left(\frac{h_o}{k\Delta x} + \frac{1}{\Delta y^2} + \frac{1}{\Delta x^2} \right) \geq 0 \rightarrow \Delta t \leq \frac{1}{2\alpha \left(\frac{h_o}{k\Delta x} + \frac{1}{\Delta y^2} + \frac{1}{\Delta x^2} \right)}$$

Substituting the given quantities, the maximum allowable value of the time step is determined to be

$$\text{or, } \Delta t \leq \frac{1}{2 \times (0.39 \times 10^6 \text{ m}^2/\text{s}) \left(\frac{20 \text{ W/m}^2 \cdot \text{°C}}{(0.84 \text{ W/m} \cdot \text{°C})(0.002 \text{ m})} + \frac{1}{(0.002 \text{ m})^2} + \frac{1}{(0.01 \text{ m})^2} \right)} = 4.7 \text{ s}$$

Therefore, any time step less than 4.8 s can be used to solve this problem. For convenience, we choose the time step to be $\Delta t = 4 \text{ s}$. Then the temperature distribution throughout the glass 15 min after the strip heaters are turned on and when steady conditions are reached are determined to be (from the EES solutions in CD)

$$\begin{aligned} \text{15 min: } \quad T_1 &= -2.4^\circ\text{C}, T_2 = -2.4^\circ\text{C}, T_3 = -2.5^\circ\text{C}, T_4 = -1.8^\circ\text{C}, T_5 = -2.0^\circ\text{C}, \\ &T_6 = -2.7^\circ\text{C}, T_7 = 12.3^\circ\text{C}, T_8 = 10.7^\circ\text{C}, T_9 = 9.6^\circ\text{C} \end{aligned}$$

$$\begin{aligned} \text{Steady-state: } \quad T_1 &= -2.4^\circ\text{C}, T_2 = -2.4^\circ\text{C}, T_3 = -2.5^\circ\text{C}, T_4 = -1.8^\circ\text{C}, T_5 = -2.0^\circ\text{C}, \\ &T_6 = -2.7^\circ\text{C}, T_7 = 12.3^\circ\text{C}, T_8 = 10.7^\circ\text{C}, T_9 = 9.6^\circ\text{C} \end{aligned}$$

Discussion Steady operating conditions are reached in about 8 min.

5-94 The formation of fog on the glass surfaces of a car is to be prevented by attaching electric resistance heaters to the inner surfaces. The temperature distribution throughout the glass 15 min after the strip heaters are turned on and also when steady conditions are reached are to be determined using the implicit method with a time step of $\Delta t = 1$ min.

Assumptions 1 Heat transfer through the glass is given to be transient and two-dimensional. 2 Thermal conductivity is constant. 3 There is heat generation only at the inner surface, which will be treated as prescribed heat flux.

Properties The conductivity and diffusivity are given to be $k = 0.84 \text{ W/m}\cdot\text{C}$ and $\alpha = 0.39 \times 10^{-6} \text{ m}^2/\text{s}$.

Analysis The nodal spacing is given to be $\Delta x = 0.2 \text{ cm}$ and $\Delta y = 1 \text{ cm}$. The implicit finite difference equations are determined on the basis of the energy balance for the transient case expressed as

$$\sum_{\text{All sides}} \dot{Q}^{i+1} + \dot{E}_{\text{gen, element}}^{i+1} = \rho c_p \nu_{\text{element}} \frac{T_m^{i+1} - T_m^i}{\Delta t}$$

We consider only 9 nodes because of symmetry. Note that we do not have a square mesh in this case, and thus we will have to rely on energy balances to obtain the finite difference equations. Using energy balances, the finite difference equations for each of the 9 nodes are obtained as follows:

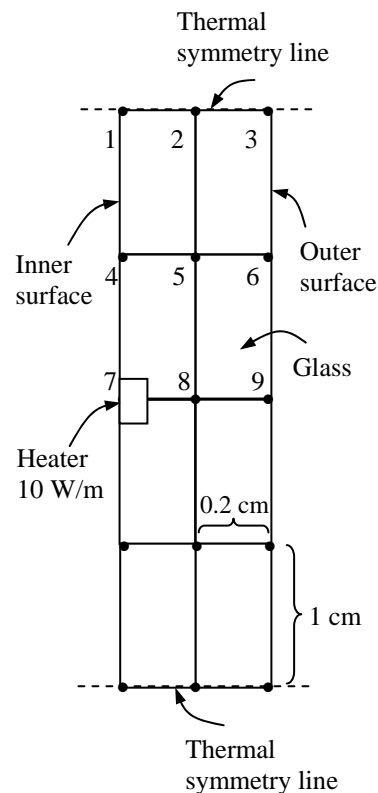

$$\text{Node 1: } h_i \frac{\Delta y}{2} (T_i - T_1^{i+1}) + k \frac{\Delta x}{2} \frac{T_4^{i+1} - T_1^{i+1}}{\Delta y} + k \frac{\Delta y}{2} \frac{T_2^{i+1} - T_1^{i+1}}{\Delta x} = \rho c_p \frac{\Delta x}{2} \frac{\Delta y}{2} \frac{T_1^{i+1} - T_1^i}{\Delta t}$$

$$\text{Node 2: } k \frac{\Delta y}{2} \frac{T_1^{i+1} - T_2^{i+1}}{\Delta x} + k \frac{\Delta y}{2} \frac{T_3^{i+1} - T_2^{i+1}}{\Delta x} + k \Delta x \frac{T_5^{i+1} - T_2^{i+1}}{\Delta y} = \rho c_p \Delta x \frac{\Delta y}{2} \frac{T_2^{i+1} - T_2^i}{\Delta t}$$

$$\text{Node 3: } h_o \frac{\Delta y}{2} (T_o - T_3^{i+1}) + k \frac{\Delta x}{2} \frac{T_6^{i+1} - T_3^{i+1}}{\Delta y} + k \frac{\Delta y}{2} \frac{T_2^{i+1} - T_3^{i+1}}{\Delta x} = \rho c_p \frac{\Delta x}{2} \frac{\Delta y}{2} \frac{T_3^{i+1} - T_3^i}{\Delta t}$$

$$\text{Node 4: } h_i \Delta y (T_i - T_4^{i+1}) + k \frac{\Delta x}{2} \frac{T_1^{i+1} - T_4^{i+1}}{\Delta y} + k \frac{\Delta x}{2} \frac{T_7^{i+1} - T_4^{i+1}}{\Delta y} + k \Delta y \frac{T_5^{i+1} - T_4^{i+1}}{\Delta x} = \rho c_p \Delta y \frac{\Delta x}{2} \frac{T_4^{i+1} - T_4^i}{\Delta t}$$

$$\text{Node 5: } k \Delta y \frac{T_4^{i+1} - T_5^{i+1}}{\Delta x} + k \Delta y \frac{T_6^{i+1} - T_5^{i+1}}{\Delta x} + k \Delta x \frac{T_8^{i+1} - T_5^{i+1}}{\Delta y} + k \Delta x \frac{T_2^{i+1} - T_5^{i+1}}{\Delta y} = \rho c_p \Delta x \Delta y \frac{T_5^{i+1} - T_5^i}{\Delta t}$$

$$\text{Node 6: } h_o \Delta y (T_o - T_6^{i+1}) + k \frac{\Delta x}{2} \frac{T_3^{i+1} - T_6^{i+1}}{\Delta y} + k \frac{\Delta x}{2} \frac{T_9^{i+1} - T_6^{i+1}}{\Delta y} + k \Delta y \frac{T_5^{i+1} - T_6^{i+1}}{\Delta x} = \rho c_p \Delta y \frac{\Delta x}{2} \frac{T_6^{i+1} - T_6^i}{\Delta t}$$

$$\text{Node 7: } 5 \text{ W} + h_i \frac{\Delta y}{2} (T_i - T_7^{i+1}) + k \frac{\Delta x}{2} \frac{T_4^{i+1} - T_7^{i+1}}{\Delta y} + k \frac{\Delta y}{2} \frac{T_8^{i+1} - T_7^{i+1}}{\Delta x} = \rho c_p \frac{\Delta x}{2} \frac{\Delta y}{2} \frac{T_7^{i+1} - T_7^i}{\Delta t}$$

$$\text{Node 8: } k \frac{\Delta y}{2} \frac{T_7^{i+1} - T_8^{i+1}}{\Delta x} + k \frac{\Delta y}{2} \frac{T_9^{i+1} - T_8^{i+1}}{\Delta x} + k \Delta x \frac{T_5^{i+1} - T_8^{i+1}}{\Delta y} = \rho c_p \Delta x \frac{\Delta y}{2} \frac{T_8^{i+1} - T_8^i}{\Delta t}$$

$$\text{Node 9: } h_o \frac{\Delta y}{2} (T_o - T_9^{i+1}) + k \frac{\Delta x}{2} \frac{T_6^{i+1} - T_9^{i+1}}{\Delta y} + k \frac{\Delta y}{2} \frac{T_8^{i+1} - T_9^{i+1}}{\Delta x} = \rho c_p \frac{\Delta x}{2} \frac{\Delta y}{2} \frac{T_9^{i+1} - T_9^i}{\Delta t}$$

where $k = 0.84 \text{ W/m}\cdot\text{°C}$, $\alpha = k / \rho c_p = 0.39 \times 10^{-6} \text{ m}^2/\text{s}$, $T_i = T_o = -3\text{°C}$, $h_i = 6 \text{ W/m}^2\cdot\text{°C}$, $h_o = 20 \text{ W/m}^2\cdot\text{°C}$, $\Delta x = 0.002 \text{ m}$, and $\Delta y = 0.01 \text{ m}$. Taking time step to be $\Delta t = 1 \text{ min}$, the temperature distribution throughout the glass 15 min after the strip heaters are turned on and when steady conditions are reached are determined to be (from the EES solutions in the CD)

15 min: $T_1 = -2.4\text{°C}$, $T_2 = -2.4\text{°C}$, $T_3 = -2.5\text{°C}$, $T_4 = -1.8\text{°C}$, $T_5 = -2.0\text{°C}$,
 $T_6 = -2.7\text{°C}$, $T_7 = 12.3\text{°C}$, $T_8 = 10.7\text{°C}$, $T_9 = 9.6\text{°C}$

Steady-state: $T_1 = -2.4\text{°C}$, $T_2 = -2.4\text{°C}$, $T_3 = -2.5\text{°C}$, $T_4 = -1.8\text{°C}$, $T_5 = -2.0\text{°C}$,
 $T_6 = -2.7\text{°C}$, $T_7 = 12.3\text{°C}$, $T_8 = 10.7\text{°C}$, $T_9 = 9.6\text{°C}$

Discussion Steady operating conditions are reached in about 8 min.

5-95 The roof of a house initially at a uniform temperature is subjected to convection and radiation on both sides. The temperatures of the inner and outer surfaces of the roof at 6 am in the morning as well as the average rate of heat transfer through the roof during that night are to be determined.

Assumptions 1 Heat transfer is one-dimensional. 2 Thermal properties, heat transfer coefficients, and the indoor and outdoor temperatures are constant. 3 Radiation heat transfer is significant.

Properties The conductivity and diffusivity are given to

be $k = 1.4 \text{ W/m}\cdot^\circ\text{C}$ and $\alpha = 0.69 \times 10^{-6} \text{ m}^2/\text{s}$. The emissivity of both surfaces of the concrete roof is 0.9.

Analysis The nodal spacing is given to be $\Delta x = 0.03 \text{ m}$. Then the number of nodes becomes $M = L / \Delta x + 1 = 0.15/0.03 + 1 = 6$. This problem involves 6 unknown nodal temperatures, and thus we need to have 6 equations. Nodes 2, 3, 4, and 5 are interior nodes, and thus for them we can use the general explicit finite difference relation expressed as

$$T_{m-1}^i - 2T_m^i + T_{m+1}^i + \frac{\dot{e}_m^i \Delta x^2}{k} = \frac{T_m^{i+1} - T_m^i}{\tau}$$

$$\rightarrow T_m^{i+1} = \tau(T_{m-1}^i + T_{m+1}^i) + (1 - 2\tau)T_m^i + \tau \frac{\dot{e}_m^i \Delta x^2}{k}$$

The finite difference equations for nodes 1 and 6 subjected to convection and radiation are obtained from an energy balance by taking the direction of all heat transfers to be towards the node under consideration:

$$\text{Node 1 (convection): } h_i(T_i - T_1^i) + k \frac{T_2^i - T_1^i}{\Delta x} + \varepsilon \sigma [T_{\text{wall}}^4 - (T_1^i + 273)^4] = \rho \frac{\Delta x}{2} c_p \frac{T_1^{i+1} - T_1^i}{\Delta t}$$

$$\text{Node 2 (interior): } T_2^{i+1} = \tau(T_1^i + T_3^i) + (1 - 2\tau)T_2^i$$

$$\text{Node 3 (interior): } T_3^{i+1} = \tau(T_2^i + T_4^i) + (1 - 2\tau)T_3^i$$

$$\text{Node 4 (interior): } T_4^{i+1} = \tau(T_3^i + T_5^i) + (1 - 2\tau)T_4^i$$

$$\text{Node 5 (interior): } T_5^{i+1} = \tau(T_4^i + T_6^i) + (1 - 2\tau)T_5^i$$

$$\text{Node 6 (convection): } h_o(T_o - T_6^i) + k \frac{T_5^i - T_6^i}{\Delta x} + \varepsilon \sigma [T_{\text{sky}}^4 - (T_6^i + 273)^4] = \rho \frac{\Delta x}{2} c_p \frac{T_6^{i+1} - T_6^i}{\Delta t}$$

where $k = 1.4 \text{ W/m}\cdot^\circ\text{C}$, $\alpha = k / \rho c_p = 0.69 \times 10^{-6} \text{ m}^2/\text{s}$, $T_i = 20^\circ\text{C}$, $T_{\text{wall}} = 293 \text{ K}$, $T_o = 6^\circ\text{C}$, $T_{\text{sky}} = 260 \text{ K}$, $h_i = 5 \text{ W/m}^2\cdot^\circ\text{C}$, $h_o = 12 \text{ W/m}^2\cdot^\circ\text{C}$, $\Delta x = 0.03 \text{ m}$, and $\Delta t = 5 \text{ min}$. Also, the mesh Fourier number is

$$\tau = \frac{\alpha \Delta t}{\Delta x^2} = \frac{(0.69 \times 10^{-6} \text{ m}^2/\text{s})(300 \text{ s})}{(0.03 \text{ m})^2} = 0.230$$

Substituting this value of τ and other given quantities, the inner and outer surface temperatures of the roof after $12 \times (60/5) = 144$ time steps (12 h) are determined to be $T_1 = 10.3^\circ\text{C}$ and $T_6 = -0.97^\circ\text{C}$.

(b) The average temperature of the inner surface of the roof can be taken to be

$$T_{1,\text{avg}} = \frac{T_{1@6\text{PM}} + T_{1@6\text{AM}}}{2} = \frac{18 + 10.3}{2} = 14.15^\circ\text{C}$$

Then the average rate of heat loss through the roof that night becomes

$$\begin{aligned} \dot{Q}_{\text{avg}} &= h_i A_s (T_i - T_{1,\text{ave}}) + \varepsilon \sigma A_s [T_{\text{wall}}^4 - (T_1^i + 273)^4] \\ &= (5 \text{ W/m}^2 \cdot ^\circ\text{C})(18 \times 32 \text{ m}^2)(20 - 14.15)^\circ\text{C} \\ &\quad + 0.9(18 \times 32 \text{ m}^2)(5.67 \times 10^{-8} \text{ W/m}^2 \cdot \text{K}^4)[(293 \text{ K})^4 - (14.15 + 273 \text{ K})^4] \\ &= \mathbf{33,640 \text{ W}} \end{aligned}$$

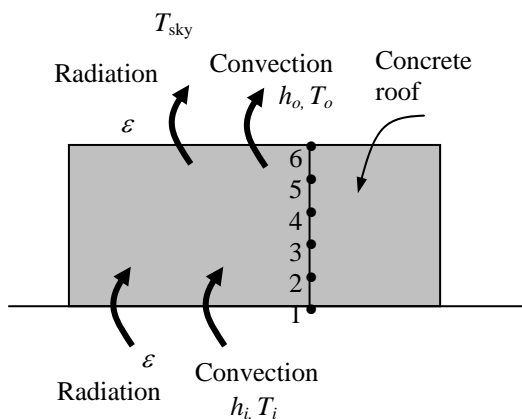

5-96 A refrigerator whose walls are constructed of 3-cm thick urethane insulation malfunctions, and stops running for 6 h. The temperature inside the refrigerator at the end of this 6 h period is to be determined.

Assumptions 1 Heat transfer is one-dimensional since the walls are large relative to their thickness. **2** Thermal properties, heat transfer coefficients, and the outdoor temperature are constant. **3** Radiation heat transfer is negligible. **4** The temperature of the contents of the refrigerator, including the air inside, rises uniformly during this period. **5** The local atmospheric pressure is 1 atm. **6** The space occupied by food and the corner effects are negligible. **7** Heat transfer through the bottom surface of the refrigerator is negligible.

Properties The conductivity and diffusivity are given to be $k = 0.026 \text{ W/m}\cdot^\circ\text{C}$ and $\alpha = 0.36 \times 10^{-6} \text{ m}^2/\text{s}$. The average specific heat of food items is given to be $3.6 \text{ kJ/kg}\cdot^\circ\text{C}$. The specific heat and density of air at 1 atm and 3°C are $c_p = 1.006 \text{ kJ/kg}\cdot^\circ\text{C}$ and $\rho = 1.28 \text{ kg/m}^3$ (Table A-15).

Analysis The nodal spacing is given to be $\Delta x = 0.01 \text{ m}$. Then the number of nodes becomes

$M = L / \Delta x + 1 = 0.03 / 0.01 + 1 = 4$. This problem involves 4 unknown nodal temperatures, and thus we need to have 4 equations. Nodes 2 and 3 are interior nodes, and thus for them we can use the general explicit finite difference relation expressed as

$$T_{m-1}^i - 2T_m^i + T_{m+1}^i + \frac{\dot{e}_m^i \Delta x^2}{k} = \frac{T_m^{i+1} - T_m^i}{\tau} \rightarrow T_m^{i+1} = \tau(T_{m-1}^i + T_{m+1}^i) + (1 - 2\tau)T_m^i + \tau \frac{\dot{e}_m^i \Delta x^2}{k}$$

The finite difference equations for nodes 1 and 4 subjected to convection and radiation are obtained from an energy balance by taking the direction of all heat transfers to be towards the node under consideration:

$$\text{Node 1 (convection): } h_o(T_o - T_1^i) + k \frac{T_2^i - T_1^i}{\Delta x} = \rho \frac{\Delta x}{2} c_p \frac{T_1^{i+1} - T_1^i}{\Delta t}$$

$$\text{Node 2 (interior): } T_2^{i+1} = \tau(T_1^i + T_3^i) + (1 - 2\tau)T_2^i$$

$$\text{Node 3 (interior): } T_3^{i+1} = \tau(T_2^i + T_4^i) + (1 - 2\tau)T_3^i$$

$$\text{Node 4 (convection): } h_i(T_5^i - T_4^i) + k \frac{T_3^i - T_4^i}{\Delta x} = \rho \frac{\Delta x}{2} c_p \frac{T_4^{i+1} - T_4^i}{\Delta t}$$

where $T_5 = T_i = 3^\circ\text{C}$ (initially), $T_o = 25^\circ\text{C}$, $h_i = 6 \text{ W/m}^2\cdot^\circ\text{C}$, $h_o = 9 \text{ W/m}^2\cdot^\circ\text{C}$, $\Delta x = 0.01 \text{ m}$, and $\Delta t = 1 \text{ min}$. Also, the mesh Fourier number is

$$\tau = \frac{\alpha \Delta t}{\Delta x^2} = \frac{(0.36 \times 10^{-6} \text{ m}^2/\text{s})(60 \text{ s})}{(0.01 \text{ m})^2} = 0.216$$

The volume of the refrigerator cavity and the mass of air inside are

$$\mathcal{V} = (1.80 - 0.03)(0.8 - 0.03)(0.7 - 0.03) = 0.913 \text{ m}^3$$

$$m_{air} = \rho \mathcal{V} = (1.28 \text{ kg/m}^3)(0.913 \text{ m}^3) = 1.17 \text{ kg}$$

Energy balance for the air space of the refrigerator can be expressed as

$$\text{Node 5 (refrig. air): } h_i A_i (T_4^i - T_5^i) = (mc_p \Delta T)_{air} + (mc_p \Delta T)_{food}$$

$$\text{or } h_i A_i (T_4^i - T_5^i) = [(mc_p)_{air} + (mc_p)_{food}] \frac{T_5^{i+1} - T_5^i}{\Delta t}$$

where $A_i = 2(1.77 \times 0.77) + 2(1.77 \times 0.67) + (0.77 \times 0.67) = 5.6135 \text{ m}^2$

Substituting, temperatures of the refrigerated space after $6 \times 60 = 360$ time steps (6 h) is determined to be

$$T_{in} = T_5 = \mathbf{19.6^\circ\text{C}}$$

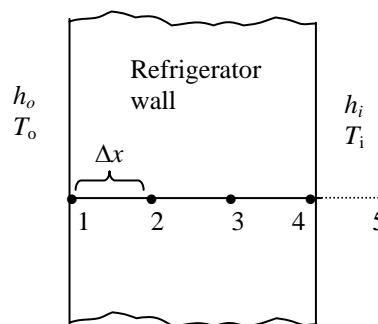

5-97 EES Prob. 5-96 is reconsidered. The temperature inside the refrigerator as a function of heating time is to be plotted.

Analysis The problem is solved using EES, and the solution is given below.

"GIVEN"

t_ins=0.03 [m]
 k=0.026 [W/m-C]
 alpha=0.36E-6 [m^2/s]
 T_i=3 [C]
 h_i=6 [W/m^2-C]
 h_o=9 [W/m^2-C]
 T_infinity=25 [C]
 m_food=15 [kg]
 C_food=3600 [J/kg-C]
 DELTAx=0.01 [m]
 DELTA_t=60 [s]
 time=6*3600 [s]

"PROPERTIES"

rho_air=density(air, T=T_i, P=101.3)
 C_air=CP(air, T=T_i)*Convert(kJ/kg-C, J/kg-C)

"ANALYSIS"

M=t_ins/DELTAx+1 "Number of nodes"
 tau=(alpha*DELTA_t)/DELTAx^2
 RhoC=k/alpha "RhoC=rho*C"

"The technique is to store the temperatures in the parametric table and recover them (as old temperatures)

using the variable ROW. The first row contains the initial values so Solve Table must begin at row 2.

Use the DUPLICATE statement to reduce the number of equations that need to be typed.

Column 1

contains the time, column 2 the value of T[1], column 3, the value of T[2], etc., and column 7 the Row."

Time=TableValue('Table 1',Row-1,#Time)+DELTA_t

Duplicate i=1,5

T_old[i]=TableValue('Table 1',Row-1,#T[i])

end

"Using the explicit finite difference approach, the six equations for the six unknown temperatures are determined to be"

h_o*(T_infinity-T_old[1])+k*(T_old[2]-T_old[1])/DELTAx=RhoC*DELTAx/2*(T[1]-T_old[1])/DELTA_t "Node 1, convection"

T[2]=tau*(T_old[1]+T_old[3])+(1-2*tau)*T_old[2] "Node 2"

T[3]=tau*(T_old[2]+T_old[4])+(1-2*tau)*T_old[3] "Node 3"

h_i*(T_old[5]-T_old[4])+k*(T_old[3]-T_old[4])/DELTAx=RhoC*DELTAx/2*(T[4]-T_old[4])/DELTA_t "Node 4, convection"

h_i*A_i*(T_old[4]-T_old[5])=m_air*C_air*(T[5]-T_old[5])/DELTA_t+m_food*C_food*(T[5]-T_old[5])/DELTA_t "Node 5, refrig. air"

A_i=2*(1.8-0.03)*(0.8-0.03)+2*(1.8-0.03)*(0.7-0.03)+(0.8-0.03)*(0.7-0.03)

m_air=rho_air*V_air

V_air=(1.8-0.03)*(0.8-0.03)*(0.7-0.03)

Time [s]	T ₁ [C]	T ₂ [C]	T ₃ [C]	T ₄ [C]	T ₅ [C]	Row
0	3	3	3	3	3	1
60	35.9	3	3	3	3	2
120	5.389	10.11	3	3	3	3
180	36.75	7.552	4.535	3	3	4
240	6.563	13.21	4.855	3.663	3	5
300	37	9.968	6.402	3.517	3.024	6
360	7.374	15.04	6.549	4.272	3.042	7
420	37.04	11.55	7.891	4.03	3.087	8
480	8.021	16.27	7.847	4.758	3.122	9
540	36.97	12.67	8.998	4.461	3.182	10
...
...
35460	24.85	24.23	23.65	23.09	22.86	592
35520	24.81	24.24	23.65	23.1	22.87	593
35580	24.85	24.23	23.66	23.11	22.88	594
35640	24.81	24.24	23.67	23.12	22.88	595
35700	24.85	24.24	23.67	23.12	22.89	596
35760	24.81	24.25	23.68	23.13	22.9	597
35820	24.85	24.25	23.68	23.14	22.91	598
35880	24.81	24.26	23.69	23.15	22.92	599
35940	24.85	24.25	23.69	23.15	22.93	600
36000	24.82	24.26	23.7	23.16	22.94	601

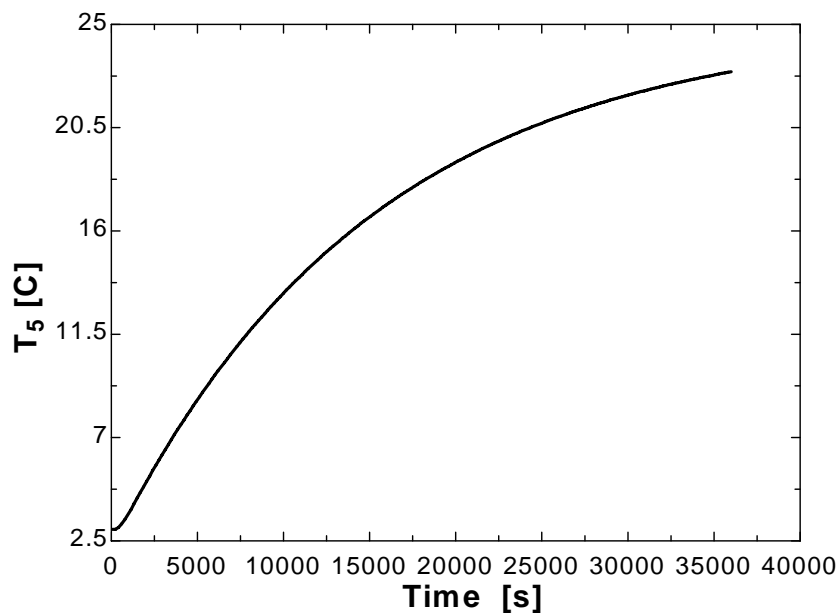

Special Topic: Controlling the Numerical Error

5-98C The results obtained using a numerical method differ from the exact results obtained analytically because the results obtained by a numerical method are approximate. The difference between a numerical solution and the exact solution (the error) is primarily due to two sources: The *discretization error* (also called the *truncation* or *formulation* error) which is caused by the approximations used in the formulation of the numerical method, and the *round-off error* which is caused by the computers' representing a number by using a limited number of significant digits and continuously rounding (or chopping) off the digits it cannot retain.

5-99C The *discretization error* (also called the *truncation* or *formulation* error) is due to replacing the derivatives by differences in each step, or replacing the actual temperature distribution between two adjacent nodes by a straight line segment. The difference between the two solutions at each time step is called the *local discretization error*. The total discretization error at any step is called the *global* or *accumulated discretization error*. The local and global discretization errors are identical for the first time step.

5-100C Yes, the global (accumulated) discretization error be less than the local error during a step. The global discretization error usually increases with increasing number of steps, but the opposite may occur when the solution function changes direction frequently, giving rise to local discretization errors of opposite signs which tend to cancel each other.

5-101C The Taylor series expansion of the temperature at a specified nodal point m about time t_i is

$$T(x_m, t_i + \Delta t) = T(x_m, t_i) + \Delta t \frac{\partial T(x_m, t_i)}{\partial t} + \frac{1}{2} \Delta t^2 \frac{\partial^2 T(x_m, t_i)}{\partial t^2} + \dots$$

The finite difference formulation of the time derivative at the same nodal point is expressed as

$$\frac{\partial T(x_m, t_i)}{\partial t} \cong \frac{T(x_m, t_i + \Delta t) - T(x_m, t_i)}{\Delta t} = \frac{T_m^{i+1} - T_m^i}{\Delta t} \quad \text{or} \quad T(x_m, t_i + \Delta t) \cong T(x_m, t_i) + \Delta t \frac{\partial T(x_m, t_i)}{\partial t}$$

which resembles the Taylor series expansion terminated after the first two terms.

5-102C The Taylor series expansion of the temperature at a specified nodal point m about time t_i is

$$T(x_m, t_i + \Delta t) = T(x_m, t_i) + \Delta t \frac{\partial T(x_m, t_i)}{\partial t} + \frac{1}{2} \Delta t^2 \frac{\partial^2 T(x_m, t_i)}{\partial t^2} + \dots$$

The finite difference formulation of the time derivative at the same nodal point is expressed as

$$\frac{\partial T(x_m, t_i)}{\partial t} \cong \frac{T(x_m, t_i + \Delta t) - T(x_m, t_i)}{\Delta t} = \frac{T_m^{i+1} - T_m^i}{\Delta t} \quad \text{or} \quad T(x_m, t_i + \Delta t) \cong T(x_m, t_i) + \Delta t \frac{\partial T(x_m, t_i)}{\partial t}$$

which resembles the Taylor series expansion terminated after the first two terms. Therefore, the 3rd and following terms in the Taylor series expansion represent the error involved in the finite difference approximation. For a sufficiently small time step, these terms decay rapidly as the order of derivative increases, and their contributions become smaller and smaller. The first term neglected in the Taylor series expansion is proportional to $(\Delta t)^2$, and thus the local discretization error is also proportional to $(\Delta t)^2$.

The global discretization error is proportional to the step size Δt itself since, at the worst case, the accumulated discretization error after I time steps during a time period t_0 is

$$I\Delta t^2 = (t_0 / \Delta t)\Delta t^2 = t_0\Delta t \quad \text{which is proportional to } \Delta t.$$

5-103C The *round-off error* is caused by retaining a limited number of digits during calculations. It depends on the number of calculations, the method of rounding off, the type of the computer, and even the sequence of calculations. Calculations that involve the alternate addition of small and large numbers are most susceptible to round-off error.

5-104C As the step size is decreased, the discretization error decreases but the round-off error increases.

5-105C The round-off error can be reduced by avoiding extremely small mesh sizes (smaller than necessary to keep the discretization error in check) and sequencing the terms in the program such that the addition of small and large numbers is avoided.

5-106C A practical way of checking if the round-off error has been significant in calculations is to repeat the calculations using double precision holding the mesh size and the size of the time step constant. If the changes are not significant, we conclude that the round-off error is not a problem.

5-107C A practical way of checking if the discretization error has been significant in calculations is to start the calculations with a reasonable mesh size Δx (and time step size Δt for transient problems), based on experience, and then to repeat the calculations using a mesh size of $\Delta x/2$. If the results obtained by halving the mesh size do not differ significantly from the results obtained with the full mesh size, we conclude that the discretization error is at an acceptable level.

Review Problems

5-108 Starting with an energy balance on a volume element, the steady three-dimensional finite difference equation for a general interior node in rectangular coordinates for $T(x, y, z)$ for the case of constant thermal conductivity and uniform heat generation is to be obtained.

Analysis We consider a *volume element* of size $\Delta x \times \Delta y \times \Delta z$ centered about a general interior node (m, n, r) in a region in which heat is generated at a constant rate of \dot{e}_0 and the thermal conductivity k is variable. Assuming the direction of heat conduction to be *towards* the node under consideration at all surfaces, the energy balance on the volume element can be expressed as

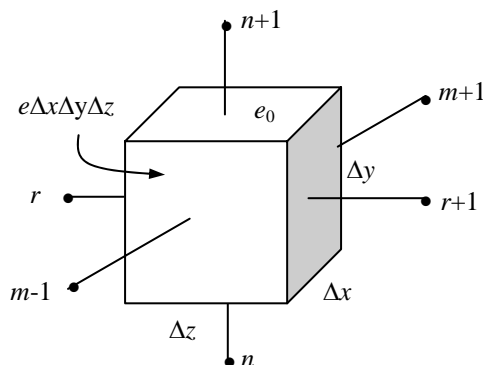

$$\dot{Q}_{\text{cond, left}} + \dot{Q}_{\text{cond, top}} + \dot{Q}_{\text{cond, right}} + \dot{Q}_{\text{cond, bottom}} + \dot{Q}_{\text{cond, front}} + \dot{Q}_{\text{cond, back}} + \dot{E}_{\text{gen, element}} = \frac{\Delta E_{\text{element}}}{\Delta t} = 0$$

for the *steady* case. Again assuming the temperatures between the adjacent nodes to vary linearly, the energy balance relation above becomes

$$\begin{aligned} & k(\Delta y \times \Delta z) \frac{T_{m-1,n,r} - T_{m,n,r}}{\Delta x} + k(\Delta x \times \Delta z) \frac{T_{m,n+1,r} - T_{m,n,r}}{\Delta y} \\ & + k(\Delta y \times \Delta z) \frac{T_{m+1,n,r} - T_{m,n,r}}{\Delta x} + k(\Delta x \times \Delta z) \frac{T_{m,n-1,r} - T_{m,n,r}}{\Delta y} \\ & + k(\Delta x \times \Delta y) \frac{T_{m,n,r-1} - T_{m,n,r}}{\Delta z} + k(\Delta x \times \Delta y) \frac{T_{m,n,r+1} - T_{m,n,r}}{\Delta z} + \dot{e}_0(\Delta x \times \Delta y \times \Delta z) = 0 \end{aligned}$$

Dividing each term by $k \Delta x \times \Delta y \times \Delta z$ and simplifying gives

$$\frac{T_{m-1,n,r} - 2T_{m,n,r} + T_{m+1,n,r}}{\Delta x^2} + \frac{T_{m,n-1,r} - 2T_{m,n,r} + T_{m,n+1,r}}{\Delta y^2} + \frac{T_{m,n,r-1} - 2T_{m,n,r} + T_{m,n,r+1}}{\Delta z^2} + \frac{\dot{e}_0}{k} = 0$$

For a cubic mesh with $\Delta x = \Delta y = \Delta z = l$, and the relation above simplifies to

$$T_{m-1,n,r} + T_{m+1,n,r} + T_{m,n-1,r} + T_{m,n+1,r} + T_{m,n,r-1} + T_{m,n,r+1} - 6T_{m,n,r} + \frac{\dot{e}_0 l^2}{k} = 0$$

It can also be expressed in the following easy-to-remember form:

$$T_{\text{left}} + T_{\text{top}} + T_{\text{right}} + T_{\text{bottom}} + T_{\text{front}} + T_{\text{back}} - 6T_{\text{node}} + \frac{\dot{e}_0 l^2}{k} = 0$$

5-109 Starting with an energy balance on a volume element, the three-dimensional transient *explicit* finite difference equation for a general interior node in rectangular coordinates for $T(x, y, z, t)$ for the case of constant thermal conductivity k and no heat generation is to be obtained.

Analysis We consider a rectangular region in which heat conduction is significant in the x and y directions. There is no heat generation in the medium, and the thermal conductivity k of the medium is constant. Now we divide the x - y - z region into a *mesh* of nodal points which are spaced Δx , Δy , and Δz apart in the x , y , and z directions, respectively, and consider a general interior node (m, n, r) whose coordinates are $x = m\Delta x$, $y = n\Delta y$, are $z = r\Delta z$. Noting that the volume element centered about the general interior node (m, n, r) involves heat conduction from six sides (right, left, front, rear, top, and bottom) and expressing them at previous time step i , the transient explicit finite difference formulation for a general interior node can be expressed as

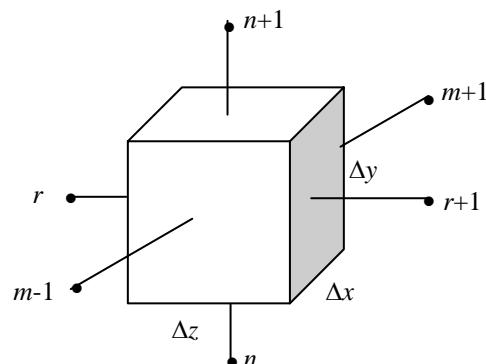

$$\begin{aligned} & k(\Delta y \times \Delta z) \frac{T_{m-1,n,r}^i - T_{m,n,r}^i}{\Delta x} + k(\Delta x \times \Delta z) \frac{T_{m,n+1,r}^i - T_{m,n,r}^i}{\Delta y} + k(\Delta y \times \Delta z) \frac{T_{m+1,n,r}^i - T_{m,n,r}^i}{\Delta x} \\ & + k(\Delta x \times \Delta z) \frac{T_{m,n-1,r}^i - T_{m,n,r}^i}{\Delta y} + k(\Delta x \times \Delta y) \frac{T_{m,n,r-1}^i - T_{m,n,r}^i}{\Delta z} + k(\Delta x \times \Delta y) \frac{T_{m,n,r+1}^i - T_{m,n,r}^i}{\Delta z} \\ & = \rho(\Delta x \times \Delta y \times \Delta z) c \frac{T_{m,n}^{i+1} - T_{m,n}^i}{\Delta t} \end{aligned}$$

Taking a cubic mesh ($\Delta x = \Delta y = \Delta z = l$) and dividing each term by k gives, after simplifying,

$$T_{m-1,n,r}^i + T_{m+1,n,r}^i + T_{m,n+1,r}^i + T_{m,n-1,r}^i + T_{m,n,r-1}^i + T_{m,n,r+1}^i - 6T_{m,n,r}^i = \frac{T_{m,n,r}^{i+1} - T_{m,n,r}^i}{\tau}$$

where $\alpha = k / \rho c$ is the thermal diffusivity of the material and $\tau = \alpha \Delta t / l^2$ is the dimensionless mesh Fourier number. It can also be expressed in terms of the temperatures at the neighboring nodes in the following easy-to-remember form:

$$T_{\text{left}}^i + T_{\text{top}}^i + T_{\text{right}}^i + T_{\text{bottom}}^i + T_{\text{front}}^i + T_{\text{back}}^i - 6T_{\text{node}}^i = \frac{T_{\text{node}}^{i+1} - T_{\text{node}}^i}{\tau}$$

Discussion We note that setting $T_{\text{node}}^{i+1} = T_{\text{node}}^i$ gives the steady finite difference formulation.

5-110 A plane wall with variable heat generation and constant thermal conductivity is subjected to combined convection and radiation at the right (node 3) and specified temperature at the left boundary (node 0). The finite difference formulation of the right boundary node (node 3) and the finite difference formulation for the rate of heat transfer at the left boundary (node 0) are to be determined.

Assumptions 1 Heat transfer through the wall is given to be steady and one-dimensional. **2** The thermal conductivity is given to be constant.

Analysis Using the energy balance approach and taking the direction of all heat transfers to be towards the node under consideration, the finite difference formulations become

Right boundary node (all temperatures are in K):

$$\varepsilon\sigma A(T_{\text{surr}}^4 - T_3^4) + hA(T_\infty - T_3) + kA\frac{T_2 - T_3}{\Delta x} + \dot{e}_3(A\Delta x/2) = 0$$

Heat transfer at left surface: $\dot{Q}_{\text{left surface}} + kA\frac{T_1 - T_0}{\Delta x} + \dot{e}_0(A\Delta x/2) = 0$

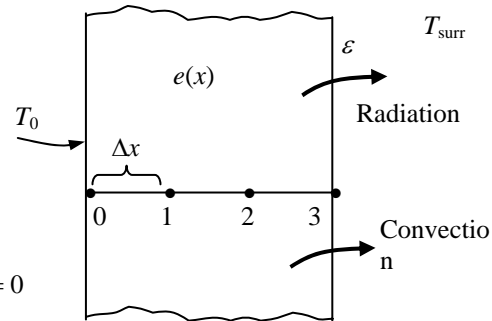

5-111 A plane wall with variable heat generation and variable thermal conductivity is subjected to uniform heat flux \dot{q}_0 and convection at the left (node 0) and radiation at the right boundary (node 2). The explicit transient finite difference formulation of the problem using the energy balance approach method is to be determined.

Assumptions 1 Heat transfer through the wall is given to be transient, and the thermal conductivity and heat generation to be variables. **2** Heat transfer is one-dimensional since the plate is large relative to its thickness. **3** Radiation from the left surface, and convection from the right surface are negligible.

Analysis Using the energy balance approach and taking the direction of all heat transfers to be towards the node under consideration, the *explicit* finite difference formulations become

Left boundary node (node 0): $k_0^i A \frac{T_1^i - T_0^i}{\Delta x} + \dot{q}_0 A + hA(T_\infty - T_0^i) + \dot{e}_0^i(A\Delta x/2) = \rho A \frac{\Delta x}{2} c_p \frac{T_0^{i+1} - T_0^i}{\Delta t}$

Interior node (node 1): $k_1^i A \frac{T_0^i - T_1^i}{\Delta x} + k_1^i A \frac{T_2^i - T_1^i}{\Delta x} + \dot{e}_1^i(A\Delta x) = \rho A \Delta x c_p \frac{T_1^{i+1} - T_1^i}{\Delta t}$

Right boundary node (node 2):

$$k_2^i A \frac{T_1^i - T_2^i}{\Delta x} + \varepsilon\sigma A[(T_{\text{surr}}^i + 273)^4 - (T_2^i + 273)^4] + \dot{e}_2^i(A\Delta x/2) = \rho A \frac{\Delta x}{2} c_p \frac{T_2^{i+1} - T_2^i}{\Delta t}$$

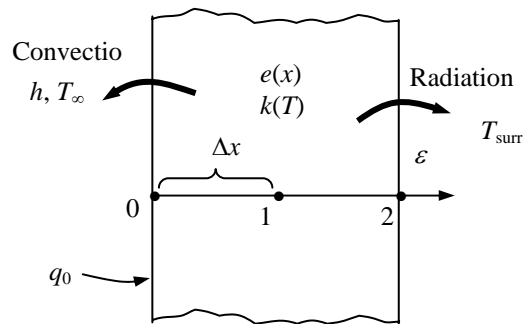

5-112 A plane wall with variable heat generation and variable thermal conductivity is subjected to uniform heat flux \dot{q}_0 and convection at the left (node 0) and radiation at the right boundary (node 2). The implicit transient finite difference formulation of the problem using the energy balance approach method is to be determined.

Assumptions 1 Heat transfer through the wall is given to be transient, and the thermal conductivity and heat generation to be variables. **2** Heat transfer is one-dimensional since the plate is large relative to its thickness. **3** Radiation from the left surface, and convection from the right surface are negligible.

Analysis Using the energy balance approach and taking the direction of all heat transfers to be towards the node under consideration, the *implicit* finite difference formulations become

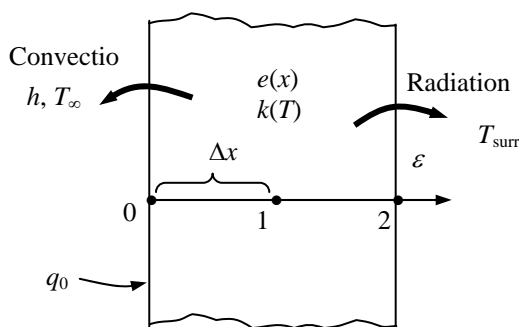

Left boundary node (node 0):

$$k_0^{i+1} A \frac{T_1^{i+1} - T_0^{i+1}}{\Delta x} + \dot{q}_0 A + hA(T_\infty - T_0^{i+1}) + \dot{e}_0^{i+1} (A\Delta x / 2) = \rho A \frac{\Delta x}{2} c_p \frac{T_0^{i+1} - T_0^i}{\Delta t}$$

Interior node (node 1): $k_1^{i+1} A \frac{T_0^{i+1} - T_1^{i+1}}{\Delta x} + k_1^{i+1} A \frac{T_2^{i+1} - T_1^{i+1}}{\Delta x} + \dot{e}_1^{i+1} (A\Delta x) = \rho A \Delta x c_p \frac{T_1^{i+1} - T_1^i}{\Delta t}$

Right boundary node (node 2):

$$k_2^{i+1} A \frac{T_1^{i+1} - T_2^{i+1}}{\Delta x} + \varepsilon \sigma A [(T_{surr}^{i+1} + 273)^4 - (T_2^{i+1} + 273)^4] + \dot{e}_2^{i+1} (A\Delta x / 2) = \rho A \frac{\Delta x}{2} c_p \frac{T_2^{i+1} - T_2^i}{\Delta t}$$

5-113 A pin fin with convection and radiation heat transfer from its tip is considered. The complete finite difference formulation for the determination of nodal temperatures is to be obtained.

Assumptions 1 Heat transfer through the pin fin is given to be steady and one-dimensional, and the thermal conductivity to be constant. **2** Convection heat transfer coefficient and emissivity are constant and uniform.

Assumptions 1 Heat transfer through the wall is given to be steady and one-dimensional, and the thermal conductivity and heat generation to be variable. **2** Convection heat transfer at the right surface is negligible.

Analysis The nodal network consists of 3 nodes, and the base temperature T_0 at node 0 is specified. Therefore, there are two unknowns T_1 and T_2 , and we need two equations to determine them. Using the energy balance approach and taking the direction of all heat transfers to be towards the node under consideration, the finite difference formulations become

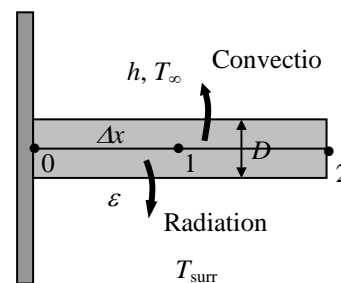

Node 1 (at midpoint):

$$kA \frac{T_0 - T_1}{\Delta x} + kA \frac{T_2 - T_1}{\Delta x} + h(p\Delta x)(T_\infty - T_1) + \varepsilon \sigma (p\Delta x) [T_{surr}^4 - (T_1 + 273)^4] = 0$$

Node 2 (at fin tip):

$$kA \frac{T_1 - T_2}{\Delta x} + h(p\Delta x / 2 + A)(T_\infty - T_2) + \varepsilon \sigma (p\Delta x / 2 + A) [T_{surr}^4 - (T_2 + 273)^4] = 0$$

where $A = \pi D^2 / 4$ is the cross-sectional area and $p = \pi D$ is the perimeter of the fin.

5-114 Starting with an energy balance on a volume element, the two-dimensional transient *explicit* finite difference equation for a general interior node in rectangular coordinates for $T(x, y, t)$ for the case of constant thermal conductivity k and uniform heat generation \dot{e}_0 is to be obtained.

Analysis (See Figure 5-24 in the text). We consider a rectangular region in which heat conduction is significant in the x and y directions, and consider a unit depth of $\Delta z = 1$ in the z direction. There is uniform heat generation in the medium, and the thermal conductivity k of the medium is constant. Now we divide the x - y plane of the region into a *rectangular mesh* of nodal points which are spaced Δx and Δy apart in the x and y directions, respectively, and consider a general interior node (m, n) whose coordinates are $x = m\Delta x$ and $y = n\Delta y$. Noting that the volume element centered about the general interior node (m, n) involves heat conduction from four sides (right, left, top, and bottom) and expressing them at previous time step i , the transient explicit finite difference formulation for a general interior node can be expressed as

$$k(\Delta y \times 1) \frac{T_{m-1,n}^i - T_{m,n}^i}{\Delta x} + k(\Delta x \times 1) \frac{T_{m,n+1}^i - T_{m,n}^i}{\Delta y} + k(\Delta y \times 1) \frac{T_{m+1,n}^i - T_{m,n}^i}{\Delta x} + k(\Delta x \times 1) \frac{T_{m,n-1}^i - T_{m,n}^i}{\Delta y} + \dot{e}_0(\Delta x \times \Delta y \times 1) = \rho(\Delta x \times \Delta y \times 1)c_p \frac{T_{m,n}^{i+1} - T_{m,n}^i}{\Delta t}$$

Taking a square mesh ($\Delta x = \Delta y = l$) and dividing each term by k gives, after simplifying,

$$T_{m-1,n}^i + T_{m+1,n}^i + T_{m,n+1}^i + T_{m,n-1}^i - 4T_{m,n}^i + \frac{\dot{e}_0 l^2}{k} = \frac{T_{m,n}^{i+1} - T_{m,n}^i}{\tau}$$

where $\alpha = k / \rho c_p$ is the thermal diffusivity of the material and $\tau = \alpha \Delta t / l^2$ is the dimensionless mesh Fourier number. It can also be expressed in terms of the temperatures at the neighboring nodes in the following easy-to-remember form:

$$T_{\text{left}}^i + T_{\text{top}}^i + T_{\text{right}}^i + T_{\text{bottom}}^i - 4T_{\text{node}}^i + \frac{\dot{e}_0 l^2}{k} = \frac{T_{\text{node}}^{i+1} - T_{\text{node}}^i}{\tau}$$

Discussion We note that setting $T_{\text{node}}^{i+1} = T_{\text{node}}^i$ gives the steady finite difference formulation.

5-115 Starting with an energy balance on a disk volume element, the one-dimensional transient implicit finite difference equation for a general interior node for $T(z, t)$ in a cylinder whose side surface is subjected to convection with a convection coefficient of h and an ambient temperature of T_∞ for the case of constant thermal conductivity with uniform heat generation is to be obtained.

Analysis We consider transient one-dimensional heat conduction in the axial z direction in a cylindrical rod of constant cross-sectional area A with constant heat generation \dot{e}_0 and constant conductivity k with a mesh size of Δz in the z direction. Noting that the volume element of a general interior node m involves heat conduction from two sides, convection from its lateral surface, and the volume of the element is $\mathcal{V}_{\text{element}} = A\Delta z$, the transient implicit finite difference formulation for an interior node can be expressed as

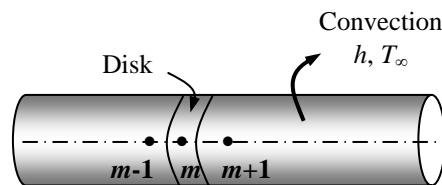

$$hp\Delta z(T_\infty - T_m^{i+1}) + kA \frac{T_{m-1}^{i+1} - T_m^{i+1}}{\Delta z} + kA \frac{T_{m+1}^{i+1} - T_m^{i+1}}{\Delta z} + \dot{e}_0 A \Delta z = \rho A \Delta z c_p \frac{T_m^{i+1} - T_m^i}{\Delta t}$$

where $A = \pi D^2 / 4$ is the cross-sectional area. Multiplying both sides of equation by $\Delta z / (kA)$,

$$\frac{hp\Delta z^2}{kA} (T_\infty - T_m^{i+1}) + (T_{m-1}^{i+1} - T_m^{i+1}) + (T_{m+1}^{i+1} - T_m^{i+1}) + \frac{\dot{e}_0 \Delta z^2}{k} = \frac{\rho \Delta z^2 c_p}{k \Delta t} (T_m^{i+1} - T_m^i)$$

Using the definitions of *thermal diffusivity* $\alpha = k / \rho c_p$ and the dimensionless *mesh Fourier number* $\tau = \frac{\alpha \Delta t}{\Delta z^2}$ the equation reduces to

$$\frac{hp\Delta z^2}{kA} (T_\infty - T_m^{i+1}) + (T_{m-1}^{i+1} + T_{m+1}^{i+1} - 2T_m^{i+1}) + \frac{\dot{e}_0 \Delta z^2}{k} = \frac{(T_m^{i+1} - T_m^i)}{\tau}$$

Discussion We note that setting $T_m^{i+1} = T_m^i$ gives the steady finite difference formulation.

5-116E The roof of a house initially at a uniform temperature is subjected to convection and radiation on both sides. The temperatures of the inner and outer surfaces of the roof at 6 am in the morning as well as the average rate of heat transfer through the roof during that night are to be determined.

Assumptions 1 Heat transfer is one-dimensional since the roof is large relative to its thickness. **2** Thermal properties, heat transfer coefficients, and the indoor temperatures are constant. **3** Radiation heat transfer is significant. **4** The outdoor temperature remains constant in the 4-h blocks. **5** The given time step $\Delta t = 5$ min is less than the critical time step so that the stability criteria is satisfied.

Properties The conductivity and diffusivity are given to k

$= 0.81 \text{ Btu/h}\cdot\text{ft}\cdot^\circ\text{F}$ and $\alpha = 7.4 \times 10^{-6} \text{ ft}^2/\text{s}$. The emissivity of both surfaces of the concrete roof is 0.9.

Analysis The nodal spacing is given to be $\Delta x = 1$ in. Then the number of nodes becomes $M = L / \Delta x + 1 = 5/1 + 1 = 6$. This problem involves 6 unknown nodal temperatures, and thus we need to have 6 equations. Nodes 2, 3, 4, and 5 are interior nodes, and thus for them we can use the general explicit finite difference relation expressed as

$$T_{m-1}^i - 2T_m^i + T_{m+1}^i + \frac{\dot{e}_m^i \Delta x^2}{k} = \frac{T_m^{i+1} - T_m^i}{\tau}$$

$$\rightarrow T_m^{i+1} = \tau(T_{m-1}^i + T_{m+1}^i) + (1 - 2\tau)T_m^i + \tau \frac{\dot{e}_m^i \Delta x^2}{k}$$

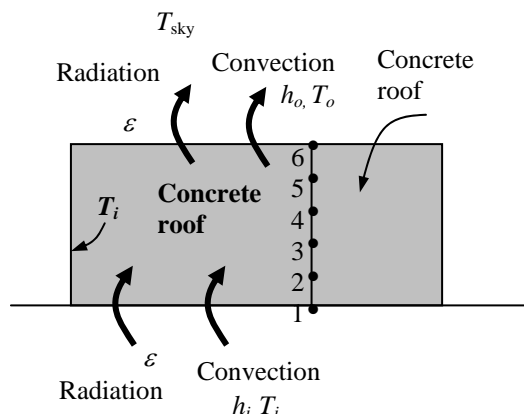

The finite difference equations for nodes 1 and 6 subjected to convection and radiation are obtained from an energy balance by taking the direction of all heat transfers to be towards the node under consideration:

$$\text{Node 1 (convection): } h_i(T_i - T_1^i) + k \frac{T_2^i - T_1^i}{\Delta x} + \varepsilon \sigma [T_{\text{wall}}^4 - (T_1^i + 273)^4] = \rho \frac{\Delta x}{2} c_p \frac{T_1^{i+1} - T_1^i}{\Delta t}$$

$$\text{Node 2 (interior): } T_2^{i+1} = \tau(T_1^i + T_3^i) + (1 - 2\tau)T_2^i$$

$$\text{Node 3 (interior): } T_3^{i+1} = \tau(T_2^i + T_4^i) + (1 - 2\tau)T_3^i$$

$$\text{Node 4 (interior): } T_4^{i+1} = \tau(T_3^i + T_5^i) + (1 - 2\tau)T_4^i$$

$$\text{Node 5 (interior): } T_5^{i+1} = \tau(T_4^i + T_6^i) + (1 - 2\tau)T_5^i$$

$$\text{Node 6 (convection): } h_o(T_o - T_6^i) + k \frac{T_5^i - T_6^i}{\Delta x} + \varepsilon \sigma [T_{\text{sky}}^4 - (T_6^i + 273)^4] = \rho \frac{\Delta x}{2} c_p \frac{T_6^{i+1} - T_6^i}{\Delta t}$$

where $k = 0.81 \text{ Btu/h}\cdot\text{ft}\cdot^\circ\text{F}$, $\alpha = k / \rho c_p = 7.4 \times 10^{-6} \text{ ft}^2/\text{s}$, $T_i = 70^\circ\text{F}$, $T_{\text{wall}} = 530 \text{ R}$, $T_{\text{sky}} = 445 \text{ R}$, $h_i = 0.9$

$\text{Btu/h}\cdot\text{ft}^2\cdot^\circ\text{F}$, $h_o = 2.1 \text{ Btu/h}\cdot\text{ft}^2\cdot^\circ\text{F}$, $\Delta x = 1/12 \text{ ft}$, and $\Delta t = 5 \text{ min}$. Also, $T_o = 50^\circ\text{F}$ from 6 PM to 10 PM, 42°F from 10 PM to 2 AM, and 38°F from 2 AM to 6 AM. The mesh Fourier number is

$$\tau = \frac{\alpha \Delta t}{\Delta x^2} = \frac{(7.4 \times 10^{-6} \text{ ft}^2/\text{s})(300 \text{ s})}{(1/12 \text{ ft})^2} = 0.320$$

Substituting this value of τ and other given quantities, the inner and outer surface temperatures of the roof after $12 \times (60/5) = 144$ time steps (12 h) are determined to be $T_1 = 54.75^\circ\text{C}$ and $T_6 = 40.18^\circ\text{C}$

(b) The average temperature of the inner surface of the roof can be taken to be

$$T_{1,\text{avg}} = \frac{T_{1@6\text{PM}} + T_{1@6\text{AM}}}{2} = \frac{70 + 54.75}{2} = 62.38^\circ\text{F}$$

Then the average rate of heat loss through the roof that night is determined to be

$$\begin{aligned} \dot{Q}_{\text{avg}} &= h_i A (T_i - T_{1,\text{avg}}) + \varepsilon \sigma A [T_{\text{wall}}^4 - (T_1^i + 273)^4] \\ &= (0.9 \text{ Btu/h}\cdot\text{ft}^2\cdot^\circ\text{F})(30 \times 50 \text{ ft}^2)(70 - 62.38)^\circ\text{F} \\ &\quad + 0.9(30 \times 50 \text{ ft}^2)(0.1714 \times 10^{-8} \text{ Btu/h}\cdot\text{ft}^2\cdot\text{R}^4)[(530 \text{ R})^4 - (62.38 + 460 \text{ R})^4] \\ &= \mathbf{20,560 \text{ Btu/h}} \end{aligned}$$

5-117 A two-dimensional bar shown in the figure is considered. The simplest form of the matrix equation is to be written and the grid nodes with energy balance equations are to be identified on the figure.

Assumptions 1 Heat transfer through the body is given to be steady and two-dimensional. 2 Thermal conductivity is constant. 3 There is no heat generation.

Analysis From symmetry, we have only three unknown temperatures at nodes 1, 2, and 3. The finite difference formulations are

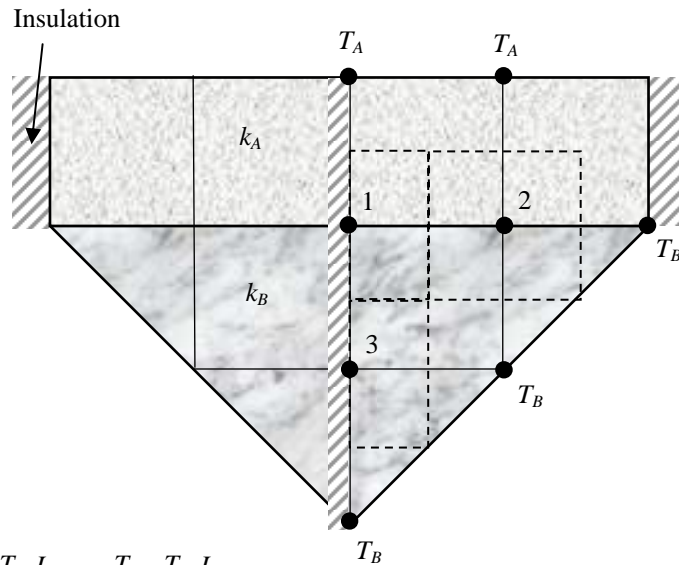

Node 1:

$$k_A \frac{T_A - T_1}{L} \frac{L}{2} + k_A \frac{T_2 - T_1}{L} \frac{L}{2} + k_B \frac{T_2 - T_1}{L} \frac{L}{2} + k_B \frac{T_3 - T_1}{L} \frac{L}{2} = 0$$

$$k_A (T_A - T_1) + k_A (T_2 - T_1) + k_B (T_2 - T_1) + k_B (T_3 - T_1) = 0$$

$$-2(k_A + k_B)T_1 + (k_A + k_B)T_2 + k_B T_3 = -k_A T_A$$

Node 2:

$$k_A \frac{T_A - T_2}{L} L + k_A \frac{T_1 - T_2}{L} \frac{L}{2} + k_B \frac{T_1 - T_2}{L} \frac{L}{2} + k_B \frac{T_B - T_2}{L} L + k_B \frac{T_B - T_2}{L} \frac{L}{2} + k_A \frac{T_B - T_2}{L} \frac{L}{2} = 0$$

$$2k_A (T_A - T_2) + k_A (T_1 - T_2) + k_B (T_1 - T_2) + 2k_B (T_B - T_2) + k_B (T_B - T_2) + k_A (T_B - T_2) = 0$$

$$(k_A + k_B)T_1 - 4(k_A + k_B)T_2 = -2k_A T_A - (k_A + 3k_B)T_B$$

Node 3:

$$k_B \frac{T_1 - T_3}{L} \frac{L}{2} + k_B \frac{T_B - T_3}{L} L + k_B \frac{T_B - T_3}{L} \frac{L}{2} = 0$$

$$T_1 - T_3 + 2(T_B - T_3) + T_B - T_3 = 0$$

$$T_1 + -4T_3 = -3T_B$$

The matrix equation is

$$\begin{bmatrix} -2(k_A + k_B) & k_A + k_B & k_B \\ k_A + k_B & -4(k_A + k_B) & 0 \\ 1 & 0 & -4 \end{bmatrix} \begin{bmatrix} T_1 \\ T_2 \\ T_3 \end{bmatrix} = \begin{bmatrix} k_A T_A \\ -2k_A T_A - (k_A + 3k_B)T_B \\ -3T_B \end{bmatrix}$$

Discussion Note that the results do not depend on L (size of the system). If you don't use the symmetry and get a 4×4 linear system, two of the equations must be equivalent.

5-118 A two-dimensional long steel bar shown in the figure is considered. The finite difference equations for the unknown temperatures in the grid using the explicit method is to be written and dimensionless parameters are to be identified. Also, the range of time steps for stability condition and the temperature field at certain times are to be determined.

Assumptions **1** Heat transfer through the body is transient and two-dimensional. **2** All surfaces of the bar except the bottom surface are maintained at a constant temperature. **3** Thermal conductivity is constant. **4** There is no heat generation.

Analysis (a) the finite difference equations for the unknown temperatures in the grid using the explicit method are

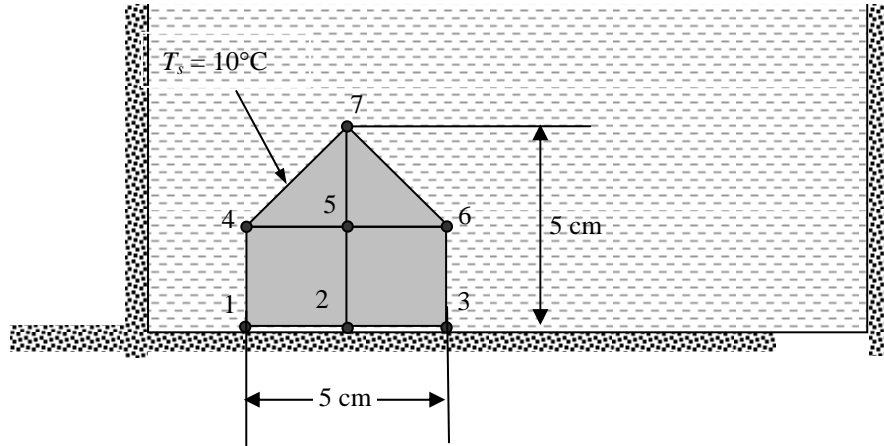

Node	$T(10 \text{ s})$	$T(20 \text{ s})$
1	10	10
2	443.3	234.4
3	10	10
4	10	10
5	315	168.6
6	10	10
7	10	10

Node 5:

$$k \frac{T_7^i - T_5^i}{\Delta x} \Delta x + k \frac{T_6^i - T_5^i}{\Delta x} \Delta x + k \frac{T_2^i - T_5^i}{\Delta x} \Delta x + k \frac{T_4^i - T_5^i}{\Delta x} \Delta x = \rho c_p \Delta x^2 \frac{T_5^{i+1} - T_5^i}{\Delta t}$$

$$T_7^i + T_6^i + T_2^i + T_4^i - 4T_5^i = \frac{\rho c \Delta x^2}{k \Delta t} (T_5^{i+1} - T_5^i) \quad (1)$$

$$T_5^{i+1} = T_5^i (1 - 4\text{Fo}) + \text{Fo} T_2^i + \text{Fo} \times 30$$

where $\text{Fo} = \frac{k \Delta t}{\rho c_p \Delta x^2}$

Node 2:

$$k \frac{T_1^i - T_2^i}{\Delta x} \frac{\Delta x}{2} + k \frac{T_5^i - T_2^i}{\Delta x} \Delta x + k \frac{T_3^i - T_2^i}{\Delta x} \frac{\Delta x}{2} = \rho c_p \frac{\Delta x^2}{2} \frac{T_2^{i+1} - T_2^i}{\Delta t}$$

$$T_1^i + T_5^i + T_3^i - 4T_2^i = \frac{-\rho c_p \Delta x^2}{k \Delta t} (T_2^{i+1} - T_2^i) \quad (2)$$

$$T_2^{i+1} = T_2^i (1 - 4Fo) + 2FoT_5^i + Fo \times 20$$

(b) For both steps, stability condition is

$$1 - 4Fo \geq 0 \longrightarrow Fo \leq \frac{1}{4} \longrightarrow \frac{k \Delta t}{\rho c_p \Delta x^2} \leq \frac{1}{4}$$

$$\Delta t \leq \frac{\rho c_p \Delta x^2}{4k} = \frac{(8000)(430)(0.025)^2}{4(40)} = \mathbf{13.44 \text{ s}}$$

(c) For $\Delta t = 10 \text{ s}$,

$$Fo = \frac{k \Delta t}{\rho c_p \Delta x^2} = \frac{(40)(10)}{(8000)(430)(0.025)^2} = 0.186$$

Then, Eq. (1) and (2) become

$$T_5^{i+1} = 0.256T_5^i + 0.186T_2^i + 5.58$$

$$T_2^{i+1} = 0.256T_2^i + 0.372T_5^i + 3.72$$

Substituting at $\Delta t = 10 \text{ s}$,

$$T_5^1 = 0.256(700) + 0.186(700) + 5.58 = \mathbf{315^\circ\text{C}}$$

$$T_2^1 = 0.256(700) + 0.372(700) + 3.72 = \mathbf{443.3^\circ\text{C}}$$

Substituting at $\Delta t = 20 \text{ s}$,

$$T_5^2 = 0.256(315) + 0.186(443) + 5.58 = \mathbf{168.6^\circ\text{C}}$$

$$T_2^1 = 0.256(443.3) + 0.372(315) + 3.72 = \mathbf{234.4^\circ\text{C}}$$

5-119 A large pond is initially at a uniform temperature. Solar energy is incident on the pond surface at for 4 h The temperature distribution in the pond under the most favorable conditions is to be determined.

Assumptions 1 Heat transfer is one-dimensional since the pond is large relative to its depth. **2** Thermal properties, heat transfer coefficients, and the indoor temperatures are constant. **3** Radiation heat transfer is significant. **4** There are no convection currents in the water. **5** The given time step $\Delta t = 15$ min is less than the critical time step so that the stability criteria is satisfied. **6** All heat losses from the pond are negligible. **7** Heat generation due to absorption of radiation is uniform in each layer.

Properties The conductivity and diffusivity are given to be $k = 0.61$ W/m \cdot °C and $\alpha = 0.15 \times 10^{-6}$ m²/s. The volumetric absorption coefficients of water are as given in the problem.

Analysis The nodal spacing is given to be $\Delta x = 0.25$ m. Then the number of nodes becomes $M = L / \Delta x + 1 = 1/0.25 + 1 = 4$. This problem involves 5 unknown nodal temperatures, and thus we need to have 5 equations. Nodes 2, 3, and 4 are interior nodes, and thus for them we can use the general explicit finite difference relation expressed as

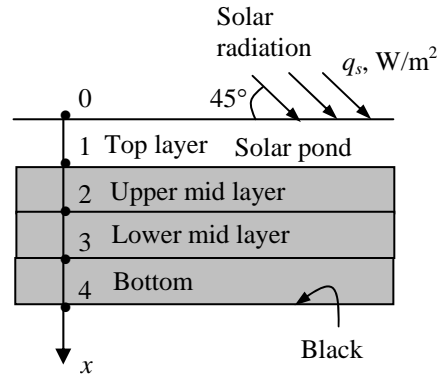

$$T_{m-1}^i - 2T_m^i + T_{m+1}^i + \frac{\dot{e}_m \Delta x^2}{k} = \frac{T_m^{i+1} - T_m^i}{\tau} \rightarrow T_m^{i+1} = \tau(T_{m-1}^i + T_{m+1}^i) + (1 - 2\tau)T_m^i + \tau \frac{\dot{e}_m \Delta x^2}{k}$$

Node 0 can also be treated as an interior node by using the mirror image concept. The finite difference equation for node 4 subjected to heat flux is obtained from an energy balance by taking the direction of all heat transfers to be towards the node:

$$\text{Node 0 (insulation): } T_0^{i+1} = \tau(T_1^i + T_1^i) + (1 - 2\tau)T_0^i + \tau \dot{e}_0 (\Delta x)^2 / k$$

$$\text{Node 1 (insulation): } T_1^{i+1} = \tau(T_0^i + T_2^i) + (1 - 2\tau)T_1^i + \tau \dot{e}_1 (\Delta x)^2 / k$$

$$\text{Node 2 (interior): } T_2^{i+1} = \tau(T_1^i + T_3^i) + (1 - 2\tau)T_2^i + \tau \dot{e}_2 (\Delta x)^2 / k$$

$$\text{Node 3 (interior): } T_3^{i+1} = \tau(T_2^i + T_4^i) + (1 - 2\tau)T_3^i + \tau \dot{e}_3 (\Delta x)^2 / k$$

$$\text{Node 4 (convection): } \dot{q}_b + k \frac{T_3^i - T_4^i}{\Delta x} + \tau \dot{e}_4 (\Delta x)^2 / k = \rho \frac{\Delta x}{2} c_p \frac{T_4^{i+1} - T_4^i}{\Delta t}$$

where $k = 0.61$ W/m \cdot °C, $\alpha = k / \rho c_p = 0.15 \times 10^{-6}$ m²/s, $\Delta x = 0.25$ m, and $\Delta t = 15$ min = 900 s. Also, the mesh Fourier number is

$$\tau = \frac{\alpha \Delta t}{\Delta x^2} = \frac{(0.15 \times 10^{-6} \text{ m}^2/\text{s})(900 \text{ s})}{(0.25 \text{ m})^2} = 0.002160$$

The values of heat generation rates at the nodal points are determined as follows:

$$\dot{e}_0 = \frac{\dot{E}_0}{\text{Volume}} = \frac{0.473 \times 500 \text{ W}}{(1 \text{ m}^2)(0.25 \text{ m})} = 946 \text{ W/m}^3$$

$$\dot{e}_1 = \frac{\dot{E}_1}{\text{Volume}} = \frac{[(0.473 + 0.061) / 2] \times 500 \text{ W}}{(1 \text{ m}^2)(0.25 \text{ m})} = 534 \text{ W/m}^3$$

$$\dot{e}_4 = \frac{\dot{E}_4}{\text{Volume}} = \frac{0.024 \times 500 \text{ W}}{(1 \text{ m}^2)(0.25 \text{ m})} = 48 \text{ W/m}^3$$

Also, the heat flux at the bottom surface is $\dot{q}_b = 0.379 \times 500 \text{ W/m}^2 = 189.5 \text{ W/m}^2$. Substituting these values, the nodal temperatures in the pond after $4 \times (60/15) = 16$ time steps (4 h) are determined to be

$$T_0 = 18.3^\circ\text{C}, \quad T_1 = 16.9^\circ\text{C}, \quad T_2 = 15.4^\circ\text{C}, \quad T_3 = 15.3^\circ\text{C}, \quad \text{and} \quad T_4 = 20.2^\circ\text{C}$$

5-120 A large 1-m deep pond is initially at a uniform temperature of 15°C throughout. Solar energy is incident on the pond surface at 45° at an average rate of 500 W/m² for a period of 4 h. The temperature distribution in the pond under the most favorable conditions is to be determined.

Assumptions 1 Heat transfer is one-dimensional since the pond is large relative to its depth. 2 Thermal properties, heat transfer coefficients, and the indoor temperatures are constant. 3 Radiation heat transfer is significant. 4 There are no convection currents in the water. 5 The given time step $\Delta t = 15$ min is less than the critical time step so that the stability criteria is satisfied. 6 All heat losses from the pond are negligible. 7 Heat generation due to absorption of radiation is uniform in each layer.

Properties The conductivity and diffusivity are given to be $k = 0.61$ W/m·°C and $\alpha = 0.15 \times 10^{-6}$ m²/s. The volumetric absorption coefficients of water are as given in the problem.

Analysis The nodal spacing is given to be $\Delta x = 0.25$ m. Then the number of nodes becomes $M = L / \Delta x + 1 = 1/0.25 + 1 = 4$. This problem involves 5 unknown nodal temperatures, and thus we need to have 5 equations. Nodes 2, 3, and 4 are interior nodes, and thus for them we can use the general explicit finite difference relation expressed as

$$T_{m-1}^i - 2T_m^i + T_{m+1}^i + \frac{\dot{e}_m \Delta x^2}{k} = \frac{T_m^{i+1} - T_m^i}{\tau}$$

$$\rightarrow T_m^{i+1} = \tau(T_{m-1}^i + T_{m+1}^i) + (1 - 2\tau)T_m^i + \tau \frac{\dot{e}_m \Delta x^2}{k}$$

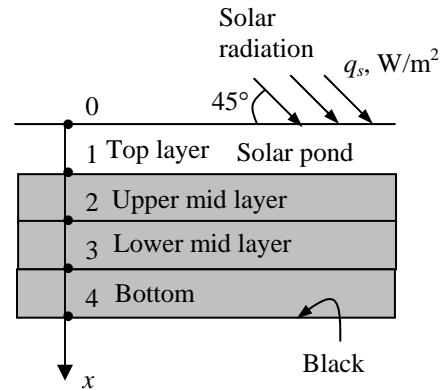

Node 0 can also be treated as an interior node by using the mirror image concept. The finite difference equation for node 4 subjected to heat flux is obtained from an energy balance by taking the direction of all heat transfers to be towards the node:

$$\text{Node 0 (insulation): } T_0^{i+1} = \tau(T_1^i + T_1^i) + (1 - 2\tau)T_0^i + \tau \dot{e}_0 (\Delta x)^2 / k$$

$$\text{Node 1 (insulation): } T_1^{i+1} = \tau(T_0^i + T_2^i) + (1 - 2\tau)T_1^i + \tau \dot{e}_1 (\Delta x)^2 / k$$

$$\text{Node 2 (interior): } T_2^{i+1} = \tau(T_1^i + T_3^i) + (1 - 2\tau)T_2^i + \tau \dot{e}_2 (\Delta x)^2 / k$$

$$\text{Node 3 (interior): } T_3^{i+1} = \tau(T_2^i + T_4^i) + (1 - 2\tau)T_3^i + \tau \dot{e}_3 (\Delta x)^2 / k$$

$$\text{Node 4 (convection): } \dot{q}_b + k \frac{T_3^i - T_4^i}{\Delta x} + \tau \dot{e}_4 (\Delta x)^2 / k = \rho \frac{\Delta x}{2} c_p \frac{T_4^{i+1} - T_4^i}{\Delta t}$$

where $k = 0.61$ W/m·°C, $\alpha = k / \rho c_p = 0.15 \times 10^{-6}$ m²/s, $\Delta x = 0.25$ m, and $\Delta t = 15$ min = 900 s. Also, the mesh Fourier number is

$$\tau = \frac{\alpha \Delta t}{\Delta x^2} = \frac{(0.15 \times 10^{-6} \text{ m}^2/\text{s})(900 \text{ s})}{(0.25 \text{ m})^2} = 0.002160$$

The absorption of solar radiation is given to be $\dot{e}(x) = \dot{q}_s (0.859 - 3.415x + 6.704x^2 - 6.339x^3 + 2.278x^4)$

where \dot{q}_s is the solar flux incident on the surface of the pond in W/m², and x is the distance from the free surface of the pond, in m. Then the values of heat generation rates at the nodal points are determined to be

$$\text{Node 0 } (x=0): \dot{e}_0 = 500(0.859 - 3.415 \times 0 + 6.704 \times 0^2 - 6.339 \times 0^3 + 2.278 \times 0^4) = 429.5 \text{ W/m}^3$$

$$\text{Node 1 } (x=0.25): \dot{e}_1 = 500(0.859 - 3.415 \times 0.25 + 6.704 \times 0.25^2 - 6.339 \times 0.25^3 + 2.278 \times 0.25^4) = 167.1 \text{ W/m}^3$$

$$\text{Node 2 } (x=0.50): \dot{e}_2 = 500(0.859 - 3.415 \times 0.5 + 6.704 \times 0.5^2 - 6.339 \times 0.5^3 + 2.278 \times 0.5^4) = 88.8 \text{ W/m}^3$$

$$\text{Node 3 } (x=0.75): \dot{e}_3 = 500(0.859 - 3.415 \times 0.75 + 6.704 \times 0.75^2 - 6.339 \times 0.75^3 + 2.278 \times 0.75^4) = 57.6 \text{ W/m}^3$$

$$\text{Node 4 } (x=1.00): \dot{e}_4 = 500(0.859 - 3.415 \times 1 + 6.704 \times 1^2 - 6.339 \times 1^3 + 2.278 \times 1^4) = 43.5 \text{ W/m}^3$$

Also, the heat flux at the bottom surface is $\dot{q}_b = 0.379 \times 500 \text{ W/m}^2 = 189.5 \text{ W/m}^2$. Substituting these values, the nodal temperatures in the pond after $4 \times (60/15) = 16$ time steps (4 h) are determined to be

$$T_0 = 16.5^\circ\text{C}, \quad T_1 = 15.6^\circ\text{C}, \quad T_2 = 15.3^\circ\text{C}, \quad T_3 = 15.3^\circ\text{C}, \quad \text{and} \quad T_4 = 20.2^\circ\text{C}$$

5-121 A hot surface is to be cooled by aluminum pin fins. The nodal temperatures after 5 min are to be determined using the explicit finite difference method. Also to be determined is the time it takes for steady conditions to be reached.

Assumptions **1** Heat transfer through the pin fin is given to be one-dimensional. **2** The thermal properties of the fin are constant. **3** Convection heat transfer coefficient is constant and uniform. **4** Radiation heat transfer is negligible. **5** Heat loss from the fin tip is considered.

Analysis The nodal network of this problem consists of 5 nodes, and the base temperature T_0 at node 0 is specified. Therefore, there are 4 unknown nodal temperatures, and we need 4 equations to determine them. Using the energy balance approach and taking the direction of all heat transfers to be towards the node under consideration, the explicit transient finite difference formulations become

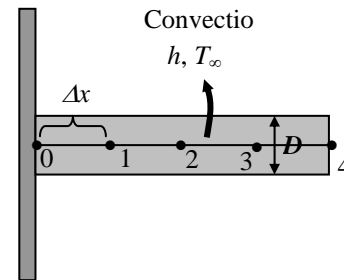

$$\begin{aligned} \text{Node 1 (interior):} \quad & hp\Delta x(T_\infty - T_1^i) + kA \frac{T_2^i - T_1^i}{\Delta x} + kA \frac{T_0 - T_1^i}{\Delta x} = \rho A \Delta x c_p \frac{T_1^{i+1} - T_1^i}{\Delta t} \\ \text{Node 2 (interior):} \quad & hp\Delta x(T_\infty - T_2^i) + kA \frac{T_3^i - T_2^i}{\Delta x} + kA \frac{T_1^i - T_2^i}{\Delta x} = \rho A \Delta x c_p \frac{T_2^{i+1} - T_2^i}{\Delta t} \\ \text{Node 3 (interior):} \quad & hp\Delta x(T_\infty - T_3^i) + kA \frac{T_4^i - T_3^i}{\Delta x} + kA \frac{T_2^i - T_3^i}{\Delta x} = \rho A \Delta x c_p \frac{T_3^{i+1} - T_3^i}{\Delta t} \\ \text{Node 4 (fin tip):} \quad & h(p\Delta x / 2 + A)(T_\infty - T_4^i) + kA \frac{T_3^i - T_4^i}{\Delta x} = \rho A (\Delta x / 2) c_p \frac{T_4^{i+1} - T_4^i}{\Delta t} \end{aligned}$$

where $A = \pi D^2 / 4$ is the cross-sectional area and $p = \pi D$ is the perimeter of the fin. Also, $D = 0.008$ m, $k = 237$ W/m \cdot °C, $\alpha = k / \rho c_p = 97.1 \times 10^{-6}$ m 2 /s, $\Delta x = 0.02$ m, $T_\infty = 15^\circ\text{C}$, $T_0 = T_i = 120^\circ\text{C}$, $h_o = 35$ W/m 2 ·°C, and $\Delta t = 1$ s. Also, the mesh Fourier number is

$$\tau = \frac{\alpha \Delta t}{\Delta x^2} = \frac{(97.1 \times 10^{-6} \text{ m}^2/\text{s})(1 \text{ s})}{(0.02 \text{ m})^2} = 0.24275$$

Substituting these values, the nodal temperatures along the fin after $5 \times 60 = 300$ time steps (4 h) are determined to be

$$T_0 = 120^\circ\text{C}, \quad T_1 = 110.6^\circ\text{C}, \quad T_2 = 103.9^\circ\text{C}, \quad T_3 = 100.0^\circ\text{C}, \quad \text{and} \quad T_4 = 98.5^\circ\text{C}.$$

Printing the temperatures after each time step and examining them, we observe that the nodal temperatures stop changing after about 3.8 min. Thus we conclude that steady conditions are reached after **3.8 min**.

5-122E A plane wall in space is subjected to specified temperature on one side and radiation and heat flux on the other. The finite difference formulation of this problem is to be obtained, and the nodal temperatures under steady conditions are to be determined.

Assumptions **1** Heat transfer through the wall is given to be steady and one-dimensional. **2** Thermal conductivity is constant. **3** There is no heat generation. **4** There is no convection in space.

Properties The properties of the wall are given to be $k=1.2 \text{ W/m}\cdot^\circ\text{C}$, $\varepsilon = 0.80$, and $\alpha_s = 0.6$.

Analysis The nodal spacing is given to be $\Delta x = 0.1 \text{ ft}$. Then the number of nodes becomes $M = L/\Delta x + 1 = 0.3/0.1 + 1 = 4$. The left surface temperature is given to be $T_0 = 520 \text{ R} = 60^\circ\text{F}$. This problem involves 3 unknown nodal temperatures, and thus we need to have 3 equations to determine them uniquely. Nodes 1 and 2 are interior nodes, and thus for them we can use the general finite difference relation expressed as

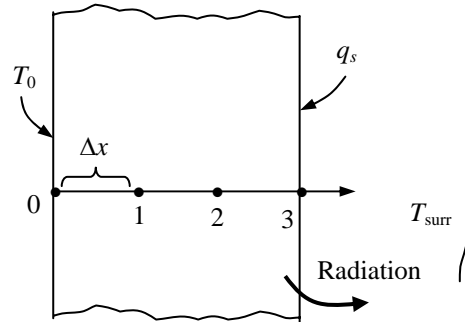

$$\frac{T_{m-1} - 2T_m + T_{m+1}}{\Delta x^2} + \frac{\dot{e}_m}{k} = 0 \rightarrow T_{m-1} - 2T_m + T_{m+1} = 0 \quad (\text{since } \dot{e} = 0), \quad \text{for } m = 1 \text{ and } 2$$

The finite difference equation for node 3 on the right surface subjected to convection and solar heat flux is obtained by applying an energy balance on the half volume element about node 3 and taking the direction of all heat transfers to be towards the node under consideration:

$$\text{Node 1 (interior):} \quad T_0 - 2T_1 + T_2 = 0$$

$$\text{Node 2 (interior):} \quad T_1 - 2T_2 + T_3 = 0$$

$$\text{Node 3 (right surface):} \quad \alpha_s \dot{q}_s + \varepsilon \sigma [T_{\text{space}}^4 - (T_3 + 460)^4] + k \frac{T_2 - T_3}{\Delta x} = 0$$

where $k = 1.2 \text{ Btu/h}\cdot\text{ft}\cdot^\circ\text{F}$, $\varepsilon = 0.80$, $\alpha_s = 0.60$, $\dot{q}_s = 350 \text{ Btu/h}\cdot\text{ft}^2$, $T_{\text{space}} = 0 \text{ R}$, and $\sigma = 0.1714 \times 10^{-8} \text{ Btu/h}\cdot\text{ft}^2\cdot\text{R}^4$. The system of 3 equations with 3 unknown temperatures constitute the finite difference formulation of the problem.

(b) The nodal temperatures under steady conditions are determined by solving the 3 equations above simultaneously with an equation solver to be

$$T_1 = 67.6^\circ\text{F} = 527.6 \text{ R}, \quad T_2 = 75.2^\circ\text{F} = 535.2 \text{ R}, \quad \text{and} \quad T_3 = 82.8^\circ\text{F} = 542.8 \text{ R}$$

5-123 Frozen steaks are to be defrosted by placing them on a black-anodized circular aluminum plate. Using the explicit method, the time it takes to defrost the steaks is to be determined.

Assumptions 1 Heat transfer in both the steaks and the defrosting plate is one-dimensional since heat transfer from the lateral surfaces is negligible. **2** Thermal properties, heat transfer coefficients, and the surrounding air and surface temperatures remain constant during defrosting. **3** Heat transfer through the bottom surface of the plate is negligible. **4** The thermal contact resistance between the steaks and the plate is negligible. **5** Evaporation from the steaks and thus evaporative cooling is negligible. **6** The heat storage capacity of the plate is small relative to the amount of total heat transferred to the steak, and thus the heat transferred to the plate can be assumed to be transferred to the steak.

Properties The thermal properties of the steaks are $\rho = 970 \text{ kg/m}^3$, $c_p = 1.55 \text{ kJ/kg}\cdot^\circ\text{C}$, $k = 1.40 \text{ W/m}\cdot^\circ\text{C}$, $\alpha = 0.93 \times 10^{-6} \text{ m}^2/\text{s}$, $\varepsilon = 0.95$, and $h_{\text{ir}} = 187 \text{ kJ/kg}$. The thermal properties of the defrosting plate are $k = 237 \text{ W/m}\cdot^\circ\text{C}$, $\alpha = 97.1 \times 10^{-6} \text{ m}^2/\text{s}$, and $\varepsilon = 0.90$. The ρc_p (volumetric specific heat) values of the steaks and of the defrosting plate are

$$(\rho c_p)_{\text{plate}} = \frac{k}{\alpha} = \frac{237 \text{ W/m}\cdot^\circ\text{C}}{97.1 \times 10^{-6} \text{ m}^2/\text{s}} = 2441 \text{ kW/m}^3 \cdot ^\circ\text{C}$$

$$(\rho c_p)_{\text{steak}} = (970 \text{ kg/m}^3)(1.55 \text{ kJ/kg}\cdot^\circ\text{C}) = 1504 \text{ kW/m}^3 \cdot ^\circ\text{C}$$

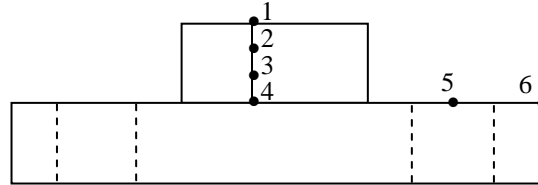

Analysis The nodal spacing is given to be $\Delta x = 0.005 \text{ m}$ in the steaks, and $\Delta r = 0.0375 \text{ m}$ in the plate. This problem involves 6 unknown nodal temperatures, and thus we need to have 6 equations. Nodes 2 and 3 are interior nodes in a plain wall, and thus for them we can use the general explicit finite difference relation expressed as

$$T_{m-1}^i - 2T_m^i + T_{m+1}^i + \frac{\dot{e}_m^i \Delta x^2}{k} = \frac{T_m^{i+1} - T_m^i}{\tau} \rightarrow T_m^{i+1} = \tau(T_{m-1}^i + T_{m+1}^i) + (1 - 2\tau)T_m^i$$

The finite difference equations for other nodes are obtained from an energy balance by taking the direction of all heat transfers to be towards the node under consideration:

$$\text{Node 1: } h(T_\infty - T_1^i) + \varepsilon_{\text{steak}} \sigma[(T_\infty + 273)^4 - (T_1^i + 273)^4] + k_{\text{steak}} \frac{T_2^i - T_1^i}{\Delta x} = (\rho c_p)_{\text{steak}} \frac{\Delta x}{2} \frac{T_1^{i+1} - T_1^i}{\Delta t}$$

$$\text{Node 2 (interior): } T_2^{i+1} = \tau_{\text{steak}} (T_1^i + T_3^i) + (1 - 2\tau_{\text{steak}})T_2^i$$

$$\text{Node 3 (interior): } T_3^{i+1} = \tau_{\text{steak}} (T_2^i + T_4^i) + (1 - 2\tau_{\text{steak}})T_3^i$$

Node 4:

$$\begin{aligned} \pi(r_{45}^2 - r_4^2) \{ h(T_\infty - T_4^i) + \varepsilon_{\text{plate}} \sigma[(T_\infty + 273)^4 - (T_4^i + 273)^4] \} + k_{\text{steak}} (\pi r_4^2) \frac{T_3^i - T_4^i}{\Delta x} \\ + k_{\text{plate}} (2\pi r_{45} \delta) \frac{T_5^i - T_4^i}{\Delta r} = [(\rho c_p)_{\text{steak}} (\pi r_4^2 \Delta x / 2) + (\rho c_p)_{\text{plate}} (\pi r_{45}^2 \delta)] \frac{T_4^{i+1} - T_4^i}{\Delta t} \end{aligned}$$

Node 5:

$$\begin{aligned} 2\pi r_5 \Delta r \{ h(T_\infty - T_5^i) + \varepsilon_{\text{plate}} \sigma[(T_\infty + 273)^4 - (T_5^i + 273)^4] \} \\ + k_{\text{plate}} (2\pi r_{56} \delta) \frac{T_6^i - T_5^i}{\Delta r} = (\rho c_p)_{\text{plate}} (\pi r_5^2 \delta) \frac{T_5^{i+1} - T_5^i}{\Delta t} \end{aligned}$$

Node 6:

$$2\pi[(r_{56} + r_6) / 2](\Delta r / 2)\{h(T_\infty - T_6^i) + \varepsilon_{\text{plate}}\sigma[(T_\infty + 273)^4 - (T_6^i + 273)^4]\} \\ + k_{\text{plate}}(2\pi r_{56}\delta)\frac{T_5^i - T_6^i}{\Delta r} = (\rho c_p)_{\text{plate}}[2\pi(r_{56} + r_6) / 2](\Delta r / 2)\delta\frac{T_6^{i+1} - T_6^i}{\Delta t}$$

where $(\rho c_p)_{\text{plate}} = 2441 \text{ kW/m}^3 \cdot ^\circ\text{C}$, $(\rho c_p)_{\text{steak}} = 1504 \text{ kW/m}^3 \cdot ^\circ\text{C}$, $k_{\text{steak}} = 1.40 \text{ W/m} \cdot ^\circ\text{C}$, $\varepsilon_{\text{steak}} = 0.95$, $\alpha_{\text{steak}} = 0.93 \times 10^{-6} \text{ m}^2/\text{s}$, $h_{\text{if}} = 187 \text{ kJ/kg}$, $k_{\text{plate}} = 237 \text{ W/m} \cdot ^\circ\text{C}$, $\alpha_{\text{plate}} = 97.1 \times 10^{-6} \text{ m}^2/\text{s}$, and $\varepsilon_{\text{plate}} = 0.90$, $T_\infty = 20^\circ\text{C}$, $h = 12 \text{ W/m}^2 \cdot ^\circ\text{C}$, $\delta = 0.01 \text{ m}$, $\Delta x = 0.005 \text{ m}$, $\Delta r = 0.0375 \text{ m}$, and $\Delta t = 5 \text{ s}$. Also, the mesh Fourier number for the steaks is

$$\tau_{\text{steak}} = \frac{\alpha \Delta t}{\Delta x^2} = \frac{(0.93 \times 10^{-6} \text{ m}^2/\text{s})(5 \text{ s})}{(0.005 \text{ m})^2} = 0.186$$

The various radii are $r_4 = 0.075 \text{ m}$, $r_5 = 0.1125 \text{ m}$, $r_6 = 0.15 \text{ m}$, $r_{45} = (0.075 + 0.1125)/2 \text{ m}$, and $r_{56} = (0.1125 + 0.15)/2 \text{ m}$.

The total amount of heat transfer needed to defrost the steaks is

$$m_{\text{steak}} = \rho V = (970 \text{ kg/m}^3)[\pi(0.075 \text{ m})^2(0.015 \text{ m})] = 0.257 \text{ kg}$$

$$Q_{\text{total, steak}} = Q_{\text{sensible}} + Q_{\text{latent}} = (mc_p \Delta T)_{\text{steak}} + (mh_{\text{if}})_{\text{steak}} \\ = (0.257 \text{ kg})(1.55 \text{ kJ/kg} \cdot ^\circ\text{C})[0 - (-18^\circ\text{C})] + (0.257 \text{ kg})(187 \text{ kJ/kg}) = 55.2 \text{ kJ}$$

The amount of heat transfer to the steak during a time step i is the sum of the heat transferred to the steak directly from its top surface, and indirectly through the plate, and is expressed as

$$Q_{\text{steak}}^i = 2\pi r_5 \Delta r \{h(T_\infty - T_5^i) + \varepsilon_{\text{plate}}\sigma[(T_\infty + 273)^4 - (T_5^i + 273)^4]\} \\ + 2\pi[(r_{56} + r_6) / 2](\Delta r / 2)\{h(T_\infty - T_6^i) + \varepsilon_{\text{plate}}\sigma[(T_\infty + 273)^4 - (T_6^i + 273)^4]\} \\ + \pi(r_{45}^2 - r_4^2)\{h(T_\infty - T_4^i) + \varepsilon_{\text{plate}}\sigma[(T_\infty + 273)^4 - (T_4^i + 273)^4]\} \\ + \pi r_1^2 \{h(T_\infty - T_1^i) + \varepsilon_{\text{steak}}\sigma[(T_\infty + 273)^4 - (T_1^i + 273)^4]\}$$

The defrosting time is determined by finding the amount of heat transfer during each time step, and adding them up until we obtain 55.2 kJ. Multiplying the number of time steps N by the time step $\Delta t = 5 \text{ s}$ will give the defrosting time. In this case it is determined to be

$$\Delta t_{\text{defrost}} = N\Delta t = 44(5 \text{ s}) = \mathbf{220 \text{ s}}$$

5-124 Frozen steaks at -18°C are to be defrosted by placing them on a 1-cm thick black-anodized circular copper defrosting plate. Using the explicit finite difference method, the time it takes to defrost the steaks is to be determined.

Assumptions **1** Heat transfer in both the steaks and the defrosting plate is one-dimensional since heat transfer from the lateral surfaces is negligible. **2** Thermal properties, heat transfer coefficients, and the surrounding air and surface temperatures remain constant during defrosting. **3** Heat transfer through the bottom surface of the plate is negligible. **4** The thermal contact resistance between the steaks and the plate is negligible. **5** Evaporation from the steaks and thus evaporative cooling is negligible. **6** The heat storage capacity of the plate is small relative to the amount of total heat transferred to the steak, and thus the heat transferred to the plate can be assumed to be transferred to the steak.

Properties The thermal properties of the steaks are $\rho = 970 \text{ kg/m}^3$, $c_p = 1.55 \text{ kJ/kg}\cdot^{\circ}\text{C}$, $k = 1.40 \text{ W/m}\cdot^{\circ}\text{C}$, $\alpha = 0.93 \times 10^{-6} \text{ m}^2/\text{s}$, $\varepsilon = 0.95$, and $h_{if} = 187 \text{ kJ/kg}$. The thermal properties of the defrosting plate are $k = 401 \text{ W/m}\cdot^{\circ}\text{C}$, $\alpha = 117 \times 10^{-6} \text{ m}^2/\text{s}$, and $\varepsilon = 0.90$ (Table A-3). The ρc_p (volumetric specific heat) values of the steaks and of the defrosting plate are

$$(\rho c_p)_{\text{plate}} = (8933 \text{ kg/m}^3)(0.385 \text{ kJ/kg}\cdot^{\circ}\text{C}) = 3439 \text{ kW/m}^3\cdot^{\circ}\text{C}$$

$$(\rho c_p)_{\text{steak}} = (970 \text{ kg/m}^3)(1.55 \text{ kJ/kg}\cdot^{\circ}\text{C}) = 1504 \text{ kW/m}^3\cdot^{\circ}\text{C}$$

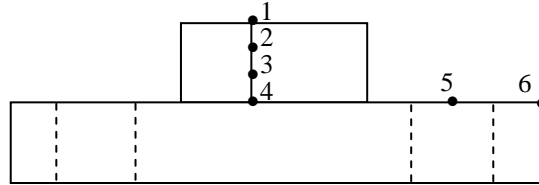

Analysis The nodal spacing is given to be $\Delta x = 0.005 \text{ m}$ in the steaks, and $\Delta r = 0.0375 \text{ m}$ in the plate. This problem involves 6 unknown nodal temperatures, and thus we need to have 6 equations. Nodes 2 and 3 are interior nodes in a plain wall, and thus for them we can use the general explicit finite difference relation expressed as

$$T_{m-1}^i - 2T_m^i + T_{m+1}^i + \frac{\dot{e}_m^i \Delta x^2}{k} = \frac{T_m^{i+1} - T_m^i}{\tau} \rightarrow T_m^{i+1} = \tau(T_{m-1}^i + T_{m+1}^i) + (1 - 2\tau)T_m^i$$

The finite difference equations for other nodes are obtained from an energy balance by taking the direction of all heat transfers to be towards the node under consideration:

$$\text{Node 1: } h(T_{\infty} - T_1^i) + \varepsilon_{\text{steak}} \sigma[(T_{\infty} + 273)^4 - (T_1^i + 273)^4] + k_{\text{steak}} \frac{T_2^i - T_1^i}{\Delta x} = (\rho c_p)_{\text{steak}} \frac{\Delta x}{2} \frac{T_1^{i+1} - T_1^i}{\Delta t}$$

$$\text{Node 2 (interior): } T_2^{i+1} = \tau_{\text{steak}} (T_1^i + T_3^i) + (1 - 2\tau_{\text{steak}})T_2^i$$

$$\text{Node 3 (interior): } T_3^{i+1} = \tau_{\text{steak}} (T_2^i + T_4^i) + (1 - 2\tau_{\text{steak}})T_3^i$$

Node 4:

$$\begin{aligned} \pi(r_{45}^2 - r_4^2) \{ h(T_{\infty} - T_4^i) + \varepsilon_{\text{plate}} \sigma[(T_{\infty} + 273)^4 - (T_4^i + 273)^4] \} + k_{\text{steak}} (\pi r_4^2) \frac{T_3^i - T_4^i}{\Delta x} \\ + k_{\text{plate}} (2\pi r_{45} \delta) \frac{T_5^i - T_4^i}{\Delta r} = [(\rho c_p)_{\text{steak}} (\pi r_4^2 \Delta x / 2) + (\rho c_p)_{\text{plate}} (\pi r_{45}^2 \delta)] \frac{T_4^{i+1} - T_4^i}{\Delta t} \end{aligned}$$

Node 5:

$$\begin{aligned} 2\pi r_5 \Delta r \{ h(T_{\infty} - T_5^i) + \varepsilon_{\text{plate}} \sigma[(T_{\infty} + 273)^4 - (T_5^i + 273)^4] \} \\ + k_{\text{plate}} (2\pi r_{56} \delta) \frac{T_6^i - T_5^i}{\Delta r} = (\rho c_p)_{\text{plate}} (\pi r_5^2 \delta) \frac{T_5^{i+1} - T_5^i}{\Delta t} \end{aligned}$$

Node 6:

$$2\pi[(r_{56} + r_6)/2](\Delta r/2)\{h(T_\infty - T_6^i) + \varepsilon_{\text{plate}}\sigma[(T_\infty + 273)^4 - (T_6^i + 273)^4]\} \\ + k_{\text{plate}}(2\pi r_{56}\delta)\frac{T_5^i - T_6^i}{\Delta r} = (\rho c_p)_{\text{plate}}[2\pi(r_{56} + r_6)/2](\Delta r/2)\delta\frac{T_6^{i+1} - T_6^i}{\Delta t}$$

where $(\rho c_p)_{\text{plate}} = 3439 \text{ kW/m}^3 \cdot ^\circ\text{C}$, $(\rho c_p)_{\text{steak}} = 1504 \text{ kW/m}^3 \cdot ^\circ\text{C}$, $k_{\text{steak}} = 1.40 \text{ W/m} \cdot ^\circ\text{C}$, $\varepsilon_{\text{steak}} = 0.95$, $\alpha_{\text{steak}} = 0.93 \times 10^{-6} \text{ m}^2/\text{s}$, $h_{\text{if}} = 187 \text{ kJ/kg}$, $k_{\text{plate}} = 401 \text{ W/m} \cdot ^\circ\text{C}$, $\alpha_{\text{plate}} = 117 \times 10^{-6} \text{ m}^2/\text{s}$, and $\varepsilon_{\text{plate}} = 0.90$, $T_\infty = 20^\circ\text{C}$, $h = 12 \text{ W/m}^2 \cdot ^\circ\text{C}$, $\delta = 0.01 \text{ m}$, $\Delta x = 0.005 \text{ m}$, $\Delta r = 0.0375 \text{ m}$, and $\Delta t = 5 \text{ s}$. Also, the mesh Fourier number for the steaks is

$$\tau_{\text{steak}} = \frac{\alpha \Delta t}{\Delta x^2} = \frac{(0.93 \times 10^{-6} \text{ m}^2/\text{s})(5 \text{ s})}{(0.005 \text{ m})^2} = 0.186$$

The various radii are $r_4 = 0.075 \text{ m}$, $r_5 = 0.1125 \text{ m}$, $r_6 = 0.15 \text{ m}$, $r_{45} = (0.075 + 0.1125)/2 \text{ m}$, and $r_{56} = (0.1125 + 0.15)/2 \text{ m}$.

The total amount of heat transfer needed to defrost the steaks is

$$m_{\text{steak}} = \rho V = (970 \text{ kg/m}^3)[\pi(0.075 \text{ m})^2(0.015 \text{ m})] = 0.257 \text{ kg} \\ Q_{\text{total, steak}} = Q_{\text{sensible}} + Q_{\text{latent}} = (mc_p \Delta T)_{\text{steak}} + (mh_{\text{if}})_{\text{steak}} \\ = (0.257 \text{ kg})(1.55 \text{ kJ/kg} \cdot ^\circ\text{C})[0 - (-18^\circ\text{C})] + (0.257 \text{ kg})(187 \text{ kJ/kg}) = 55.2 \text{ kJ}$$

The amount of heat transfer to the steak during a time step i is the sum of the heat transferred to the steak directly from its top surface, and indirectly through the plate, and is expressed as

$$Q_{\text{steak}}^i = 2\pi r_5 \Delta r \{h(T_\infty - T_5^i) + \varepsilon_{\text{plate}}\sigma[(T_\infty + 273)^4 - (T_5^i + 273)^4]\} \\ + 2\pi[(r_{56} + r_6)/2](\Delta r/2)\{h(T_\infty - T_6^i) + \varepsilon_{\text{plate}}\sigma[(T_\infty + 273)^4 - (T_6^i + 273)^4]\} \\ + \pi(r_{45}^2 - r_4^2)\{h(T_\infty - T_4^i) + \varepsilon_{\text{plate}}\sigma[(T_\infty + 273)^4 - (T_4^i + 273)^4]\} \\ + \pi r_1^2 \{h(T_\infty - T_1^i) + \varepsilon_{\text{steak}}\sigma[(T_\infty + 273)^4 - (T_1^i + 273)^4]\}$$

The defrosting time is determined by finding the amount of heat transfer during each time step, and adding them up until we obtain 55.2 kJ. Multiplying the number of time steps N by the time step $\Delta t = 5 \text{ s}$ will give the defrosting time. In this case it is determined to be

$$\Delta t_{\text{defrost}} = N\Delta t = 47(5 \text{ s}) = \mathbf{235 \text{ s}}$$

Fundamentals of Engineering (FE) Exam Problems

5-125 What is the correct steady-state finite-difference heat conduction equation of node 6 of the rectangular solid shown in Fig. P5-125?

- (a) $T_6 = (T_1 + T_3 + T_9 + T_{11}) / 2$
 (b) $T_6 = (T_5 + T_7 + T_2 + T_{10}) / 2$
 (c) $T_6 = (T_1 + T_3 + T_9 + T_{11}) / 4$
 (d) $T_6 = (T_2 + T_5 + T_7 + T_{10}) / 4$
 (e) $T_6 = (T_1 + T_2 + T_9 + T_{10}) / 4$

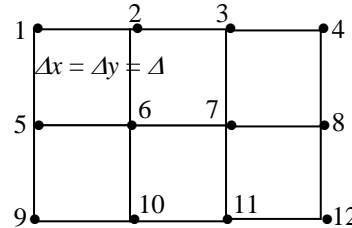

Answer (d)

5-126 Air at T_0 acts on top surface of the rectangular solid shown in Fig. P5-126 with a convection heat transfer coefficient of h . The correct steady-state finite-difference heat conduction equation for node 3 of this solid is

- (a) $T_3 = [(k/2\Delta)(T_2 + T_4 + T_7) + hT_0] / [(k/\Delta) + h]$
 (b) $T_3 = [(k/2\Delta)(T_2 + T_4 + 2T_7) + hT_0] / [(2k/\Delta) + h]$
 (c) $T_3 = [(k/\Delta)(T_2 + T_4) + hT_0] / [(2k/\Delta) + h]$
 (d) $T_3 = [(k/\Delta)(T_2 + T_4 + T_7) + hT_0] / [(k/\Delta) + h]$
 (e) $T_3 = [(k/\Delta)(2T_2 + 2T_4 + T_7) + hT_0] / [(k/\Delta) + h]$

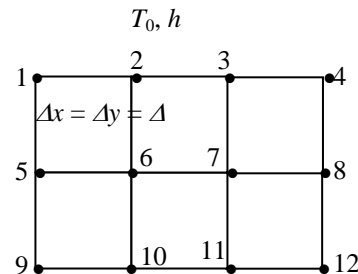

Answer (b)

5-127 What is the correct unsteady forward-difference heat conduction equation of node 6 of the rectangular solid shown in Fig. P5-127 if its temperature at the previous time (Δt) is T_6^* ?

- (a) $T_6^{i+1} = [k\Delta t / (\rho c_p \Delta^2)](T_5^* + T_2^* + T_7^* + T_{10}^*) + [1 - 4k\Delta t / (\rho c_p \Delta^2)]T_6^*$
 (b) $T_6^{i+1} = [k\Delta t / (\rho c_p \Delta^2)](T_5^* + T_2^* + T_7^* + T_{10}^*) + [1 - k\Delta t / (\rho c_p \Delta^2)]T_6^*$
 (c) $T_6^{i+1} = [k\Delta t / (\rho c_p \Delta^2)](T_5^* + T_2^* + T_7^* + T_{10}^*) + [2k\Delta t / (\rho c_p \Delta^2)]T_6^*$
 (d) $T_6^{i+1} = [2k\Delta t / (\rho c_p \Delta^2)](T_5^* + T_2^* + T_7^* + T_{10}^*) + [1 - 2k\Delta t / (\rho c_p \Delta^2)]T_6^*$
 (e) $T_6^{i+1} = [2k\Delta t / (\rho c_p \Delta^2)](T_5^* + T_2^* + T_7^* + T_{10}^*) + [1 - 4k\Delta t / (\rho c_p \Delta^2)]T_6^*$

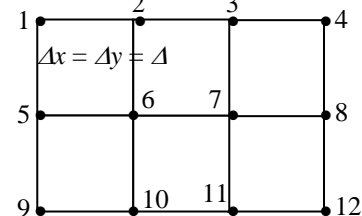

Answer (a)

5-128 The unsteady forward-difference heat conduction for a constant area, A , pin fin with perimeter, p , exposed to air whose temperature is T_0 with a convection heat transfer coefficient of h is

$$T_m^{*+1} = \frac{k}{\rho c_p \Delta x^2} \left[T_{m-1}^* + T_{m+1}^* + \frac{hp\Delta x^2}{A} T_0 \right] - \left[1 - \frac{2k}{\rho c_p \Delta x^2} - \frac{hp}{\rho c_p A} \right] T_m^*$$

In order for this equation to produce a stable solution, the quantity $\frac{2k}{\rho c_p \Delta x^2} + \frac{hp}{\rho c_p A}$ must be

- (a) Negative (b) zero (c) Positive (d) Greater than 1 (e) Less than 1

Answer (d) Greater than 1

5-129 The height of the cells for a finite-difference solution of the temperature in the rectangular solid shown in Fig. P5-129 is one-half the cell width to improve the accuracy of the solution. The correct steady-state finite-difference heat conduction equation for cell 6 is

- (a) $T_6 = 0.1(T_5 + T_7) + 0.4(T_2 + T_{10})$
 (b) $T_6 = 0.25(T_5 + T_7) + 0.25(T_2 + T_{10})$
 (c) $T_6 = 0.5(T_5 + T_7) + 0.5(T_2 + T_{10})$
 (d) $T_6 = 0.4(T_5 + T_7) + 0.1(T_2 + T_{10})$
 (e) $T_6 = 0.5(T_5 + T_7) + 0.1(T_2 + T_{10})$

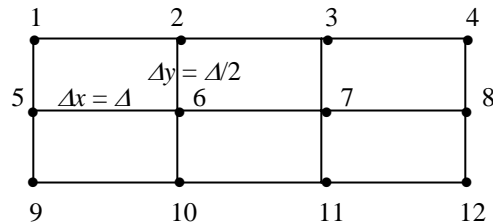

Answer (a)

5-130 The height of the cells for a finite-difference solution of the temperature in the rectangular solid shown in Fig. P5-130 is one-half the cell width to improve the accuracy of the solution. If the left surface is exposed to air at T_0 with a heat transfer coefficient of h , the correct finite-difference heat conduction energy balance for node 5 is

- (d) $2T_1 + 2T_9 + T_6 - T_5 + h\Delta/k (T_0 - T_5) = 0$
 (d) $2T_1 + 2T_9 + T_6 - 2T_5 + h\Delta/k (T_0 - T_5) = 0$
 (d) $2T_1 + 2T_9 + T_6 - 3T_5 + h\Delta/k (T_0 - T_5) = 0$
 (d) $2T_1 + 2T_9 + T_6 - 4T_5 + h\Delta/k (T_0 - T_5) = 0$
 (d) $2T_1 + 2T_9 + T_6 - 5T_5 + h\Delta/k (T_0 - T_5) = 0$

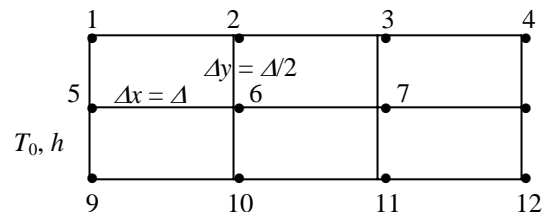

Answer (e)

5-131 5-134 Design and Essay Problems



Chapter 6

FUNDAMENTALS OF CONVECTION

Physical Mechanisms of Forced Convection

6-1C In forced convection, the fluid is forced to flow over a surface or in a tube by external means such as a pump or a fan. In natural convection, any fluid motion is caused by natural means such as the buoyancy effect that manifests itself as the rise of the warmer fluid and the fall of the cooler fluid. The convection caused by winds is natural convection for the earth, but it is forced convection for bodies subjected to the winds since for the body it makes no difference whether the air motion is caused by a fan or by the winds.

6-2C If the fluid is forced to flow over a surface, it is called external forced convection. If it is forced to flow in a tube, it is called internal forced convection. A heat transfer system can involve both internal and external convection simultaneously. Example: A pipe transporting a fluid in a windy area.

6-3C The convection heat transfer coefficient will usually be higher in forced convection since heat transfer coefficient depends on the fluid velocity, and forced convection involves higher fluid velocities.

6-4C The potato will normally cool faster by blowing warm air to it despite the smaller temperature difference in this case since the fluid motion caused by blowing enhances the heat transfer coefficient considerably.

6-5C Nusselt number is the dimensionless convection heat transfer coefficient, and it represents the enhancement of heat transfer through a fluid layer as a result of convection relative to conduction across the same fluid layer. It is defined as $Nu = \frac{hL_c}{k}$ where L_c is the characteristic length of the surface and k is the thermal conductivity of the fluid.

6-6C Heat transfer through a fluid is conduction in the absence of bulk fluid motion, and convection in the presence of it. The rate of heat transfer is higher in convection because of fluid motion. The value of the convection heat transfer coefficient depends on the fluid motion as well as the fluid properties. Thermal conductivity is a fluid property, and its value does not depend on the flow.

6-7C A fluid flow during which the density of the fluid remains nearly constant is called *incompressible flow*. A fluid whose density is practically independent of pressure (such as a liquid) is called an incompressible fluid. The flow of compressible fluid (such as air) is not necessarily compressible since the density of a compressible fluid may still remain constant during flow.

6-8 Heat transfer coefficients at different air velocities are given during air cooling of potatoes. The initial rate of heat transfer from a potato and the temperature gradient at the potato surface are to be determined.

Assumptions 1 Steady operating conditions exist. 2 Potato is spherical in shape. 3 Convection heat transfer coefficient is constant over the entire surface.

Properties The thermal conductivity of the potato is given to be $k = 0.49 \text{ W/m}\cdot\text{°C}$.

Analysis The initial rate of heat transfer from a potato is

$$A_s = \pi D^2 = \pi(0.08 \text{ m})^2 = 0.02011 \text{ m}^2$$

$$\dot{Q} = hA_s(T_s - T_\infty) = (19.1 \text{ W/m}^2\cdot\text{°C})(0.02011 \text{ m}^2)(20 - 5)\text{°C} = \mathbf{5.8 \text{ W}}$$

where the heat transfer coefficient is obtained from the table at 1 m/s velocity. The initial value of the temperature gradient at the potato surface is

$$\dot{q}_{\text{conv}} = \dot{q}_{\text{cond}} = -k \left(\frac{\partial T}{\partial r} \right)_{r=R} = h(T_s - T_\infty)$$

$$\left. \frac{\partial T}{\partial r} \right|_{r=R} = -\frac{h(T_s - T_\infty)}{k} = -\frac{(19.1 \text{ W/m}^2\cdot\text{°C})(20 - 5)\text{°C}}{0.49 \text{ W/m}\cdot\text{°C}} = \mathbf{-585 \text{ °C/m}}$$

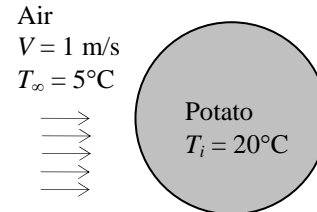

6-9 The rate of heat loss from an average man walking in still air is to be determined at different walking velocities.

Assumptions 1 Steady operating conditions exist. 2 Convection heat transfer coefficient is constant over the entire surface.

Analysis The convection heat transfer coefficients and the rate of heat losses at different walking velocities are

$$(a) \quad h = 8.6V^{0.53} = 8.6(0.5 \text{ m/s})^{0.53} = 5.956 \text{ W/m}^2\cdot\text{°C}$$

$$\dot{Q} = hA_s(T_s - T_\infty) = (5.956 \text{ W/m}^2\cdot\text{°C})(1.8 \text{ m}^2)(30 - 10)\text{°C} = \mathbf{214.4 \text{ W}}$$

$$(b) \quad h = 8.6V^{0.53} = 8.6(1.0 \text{ m/s})^{0.53} = 8.60 \text{ W/m}^2\cdot\text{°C}$$

$$\dot{Q} = hA_s(T_s - T_\infty) = (8.60 \text{ W/m}^2\cdot\text{°C})(1.8 \text{ m}^2)(30 - 10)\text{°C} = \mathbf{309.6 \text{ W}}$$

$$(c) \quad h = 8.6V^{0.53} = 8.6(1.5 \text{ m/s})^{0.53} = 10.66 \text{ W/m}^2\cdot\text{°C}$$

$$\dot{Q} = hA_s(T_s - T_\infty) = (10.66 \text{ W/m}^2\cdot\text{°C})(1.8 \text{ m}^2)(30 - 10)\text{°C} = \mathbf{383.8 \text{ W}}$$

$$(d) \quad h = 8.6V^{0.53} = 8.6(2.0 \text{ m/s})^{0.53} = 12.42 \text{ W/m}^2\cdot\text{°C}$$

$$\dot{Q} = hA_s(T_s - T_\infty) = (12.42 \text{ W/m}^2\cdot\text{°C})(1.8 \text{ m}^2)(30 - 10)\text{°C} = \mathbf{447.0 \text{ W}}$$

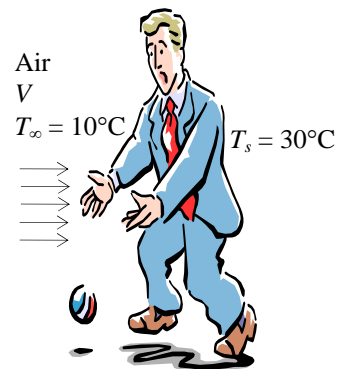

6-10 The rate of heat loss from an average man walking in windy air is to be determined at different wind velocities.

Assumptions 1 Steady operating conditions exist. 2 Convection heat transfer coefficient is constant over the entire surface.

Analysis The convection heat transfer coefficients and the rate of heat losses at different wind velocities are

$$(a) h = 14.8V^{0.69} = 14.8(0.5 \text{ m/s})^{0.69} = 9.174 \text{ W/m}^2 \cdot ^\circ\text{C}$$

$$\dot{Q} = hA_s(T_s - T_\infty) = (9.174 \text{ W/m}^2 \cdot ^\circ\text{C})(1.7 \text{ m}^2)(29 - 10)^\circ\text{C} = \mathbf{296.3 \text{ W}}$$

$$(b) h = 14.8V^{0.69} = 14.8(1.0 \text{ m/s})^{0.69} = 14.8 \text{ W/m}^2 \cdot ^\circ\text{C}$$

$$\dot{Q} = hA_s(T_s - T_\infty) = (14.8 \text{ W/m}^2 \cdot ^\circ\text{C})(1.7 \text{ m}^2)(29 - 10)^\circ\text{C} = \mathbf{478.0 \text{ W}}$$

$$(c) h = 14.8V^{0.69} = 14.8(1.5 \text{ m/s})^{0.69} = 19.58 \text{ W/m}^2 \cdot ^\circ\text{C}$$

$$\dot{Q} = hA_s(T_s - T_\infty) = (19.58 \text{ W/m}^2 \cdot ^\circ\text{C})(1.7 \text{ m}^2)(29 - 10)^\circ\text{C} = \mathbf{632.4 \text{ W}}$$

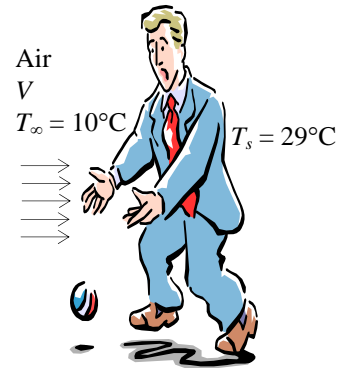

6-11 The expression for the heat transfer coefficient for air cooling of some fruits is given. The initial rate of heat transfer from an orange, the temperature gradient at the orange surface, and the value of the Nusselt number are to be determined.

Assumptions 1 Steady operating conditions exist. 2 Orange is spherical in shape. 3 Convection heat transfer coefficient is constant over the entire surface. 4 Properties of water is used for orange.

Properties The thermal conductivity of the orange is given to be $k = 0.50 \text{ W/m} \cdot ^\circ\text{C}$. The thermal conductivity and the kinematic viscosity of air at the film temperature of $(T_s + T_\infty)/2 = (15 + 5)/2 = 10^\circ\text{C}$ are (Table A-15)

$$k = 0.02439 \text{ W/m} \cdot ^\circ\text{C}, \quad \nu = 1.426 \times 10^{-5} \text{ m}^2/\text{s}$$

Analysis (a) The Reynolds number, the heat transfer coefficient, and the initial rate of heat transfer from an orange are

$$A_s = \pi D^2 = \pi(0.07 \text{ m})^2 = 0.01539 \text{ m}^2$$

$$\text{Re} = \frac{VD}{\nu} = \frac{(0.3 \text{ m/s})(0.07 \text{ m})}{1.426 \times 10^{-5} \text{ m}^2/\text{s}} = 1473$$

$$h = \frac{5.05k_{\text{air}} \text{Re}^{1/3}}{D} = \frac{5.05(0.02439 \text{ W/m} \cdot ^\circ\text{C})(1473)^{1/3}}{0.07 \text{ m}} = 20.02 \text{ W/m}^2 \cdot ^\circ\text{C}$$

$$\dot{Q} = hA_s(T_s - T_\infty) = (20.02 \text{ W/m}^2 \cdot ^\circ\text{C})(0.01539 \text{ m}^2)(15 - 5)^\circ\text{C} = \mathbf{3.08 \text{ W}}$$

(b) The temperature gradient at the orange surface is determined from

$$\dot{q}_{\text{conv}} = \dot{q}_{\text{cond}} = -k \left(\frac{\partial T}{\partial r} \right)_{r=R} = h(T_s - T_\infty)$$

$$\left. \frac{\partial T}{\partial r} \right|_{r=R} = -\frac{h(T_s - T_\infty)}{k} = -\frac{(20.02 \text{ W/m}^2 \cdot ^\circ\text{C})(15 - 5)^\circ\text{C}}{0.50 \text{ W/m} \cdot ^\circ\text{C}} = \mathbf{-400 \text{ }^\circ\text{C/m}}$$

(c) The Nusselt number is

$$\text{Nu} = \frac{hD}{k} = \frac{(20.02 \text{ W/m}^2 \cdot ^\circ\text{C})(0.07 \text{ m})}{0.02439 \text{ W/m} \cdot ^\circ\text{C}} = \mathbf{57.5}$$

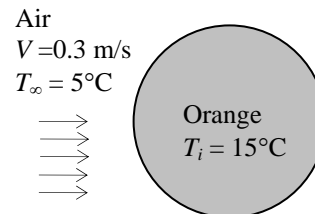

Velocity and Thermal Boundary Layers

6-12C Viscosity is a measure of the “stickiness” or “resistance to deformation” of a fluid. It is due to the internal frictional force that develops between different layers of fluids as they are forced to move relative to each other. Viscosity is caused by the cohesive forces between the molecules in liquids, and by the molecular collisions in gases. Liquids have higher dynamic viscosities than gases.

6-13C The fluids whose shear stress is proportional to the velocity gradient are called *Newtonian fluids*. Most common fluids such as water, air, gasoline, and oil are Newtonian fluids.

6-14C A fluid in direct contact with a solid surface sticks to the surface and there is no slip. This is known as the *no-slip condition*, and it is due to the viscosity of the fluid.

6-15C The ball reaches the bottom of the container first in water due to lower viscosity of water compared to oil.

6-16C (a) The dynamic viscosity of liquids decreases with temperature. (b) The dynamic viscosity of gases increases with temperature.

6-17C The fluid viscosity is responsible for the development of the velocity boundary layer. For the idealized inviscid fluids (fluids with zero viscosity), there will be no velocity boundary layer.

6-18C The Prandtl number $Pr = \nu / \alpha$ is a measure of the relative magnitudes of the diffusivity of momentum (and thus the development of the velocity boundary layer) and the diffusivity of heat (and thus the development of the thermal boundary layer). The Pr is a fluid property, and thus its value is independent of the type of flow and flow geometry. The Pr changes with temperature, but not pressure.

6-19C A thermal boundary layer will not develop in flow over a surface if both the fluid and the surface are at the same temperature since there will be no heat transfer in that case.

Laminar and Turbulent Flows

6-20C A fluid motion is laminar when it involves smooth streamlines and highly ordered motion of molecules, and turbulent when it involves velocity fluctuations and highly disordered motion. The heat transfer coefficient is higher in turbulent flow.

6-21C Reynolds number is the ratio of the inertial forces to viscous forces, and it serves as a criterion for determining the flow regime. For flow over a plate of length L it is defined as $Re = VL/\nu$ where V is flow velocity and ν is the kinematic viscosity of the fluid.

6-22C The friction coefficient represents the resistance to fluid flow over a flat plate. It is proportional to the drag force acting on the plate. The drag coefficient for a flat surface is equivalent to the mean friction coefficient.

6-23C In turbulent flow, it is the *turbulent eddies* due to enhanced mixing that cause the friction factor to be larger.

6-24C Turbulent viscosity μ_t is caused by turbulent eddies, and it accounts for momentum transport by turbulent eddies. It is expressed as $\tau_t = -\rho \overline{u'v'} = \mu_t \frac{\partial \bar{u}}{\partial y}$ where \bar{u} is the mean value of velocity in the flow direction and u' and v' are the fluctuating components of velocity.

6-25C Turbulent thermal conductivity k_t is caused by turbulent eddies, and it accounts for thermal energy transport by turbulent eddies. It is expressed as $\dot{q}_t = \rho c_p \overline{v'T'} = -k_t \frac{\partial \bar{T}}{\partial y}$ where T' is the eddy temperature relative to the mean value, and $\dot{q}_t = \rho c_p v'T'$ the rate of thermal energy transport by turbulent eddies.

Convection Equations and Similarity Solutions

6-26C A curved surface can be treated as a flat surface if there is no flow separation and the curvature effects are negligible.

6-27C The continuity equation for steady two-dimensional flow is expressed as $\frac{\partial u}{\partial x} + \frac{\partial v}{\partial y} = 0$. When multiplied by density, the first and the second terms represent net mass fluxes in the x and y directions, respectively.

6-28C *Steady* simply means no change with time at a specified location (and thus $\partial u / \partial t = 0$), but the value of a quantity may change from one location to another (and thus $\partial u / \partial x$ and $\partial u / \partial y$ may be different from zero). Even in steady flow and thus constant mass flow rate, a fluid may accelerate. In the case of a water nozzle, for example, the velocity of water remains constant at a specified point, but it changes from inlet to the exit (water accelerates along the nozzle).

6-29C In a boundary layer during steady two-dimensional flow, the velocity component in the flow direction is much larger than that in the normal direction, and thus $u \gg v$, and $\partial v / \partial x$ and $\partial v / \partial y$ are negligible. Also, u varies greatly with y in the normal direction from zero at the wall surface to nearly the free-stream value across the relatively thin boundary layer, while the variation of u with x along the flow is typically small. Therefore, $\partial u / \partial y \gg \partial u / \partial x$. Similarly, if the fluid and the wall are at different temperatures and the fluid is heated or cooled during flow, heat conduction will occur primarily in the direction normal to the surface, and thus $\partial T / \partial y \gg \partial T / \partial x$. That is, the velocity and temperature gradients normal to the surface are much greater than those along the surface. These simplifications are known as the **boundary layer approximations**.

6-30C For flows with low velocity and for fluids with low viscosity the viscous dissipation term in the energy equation is likely to be negligible.

6-31C For steady two-dimensional flow over an isothermal flat plate in the x -direction, the boundary conditions for the velocity components u and v , and the temperature T at the plate surface and at the edge of the boundary layer are expressed as follows:

$$\text{At } y = 0: \quad u(x, 0) = 0, \quad v(x, 0) = 0, \quad T(x, 0) = T_s$$

$$\text{As } y \rightarrow \infty: \quad u(x, \infty) = u_\infty, \quad T(x, \infty) = T_\infty$$

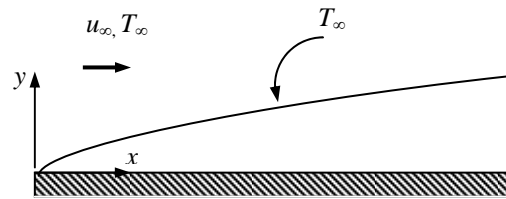

6-32C An independent variable that makes it possible to transforming a set of partial differential equations into a single ordinary differential equation is called a **similarity variable**. A similarity solution is likely to exist for a set of partial differential equations if there is a function that remains unchanged (such as the non-dimensional velocity profile on a flat plate).

6-33C During steady, laminar, two-dimensional flow over an isothermal plate, the thickness of the velocity boundary layer (a) increases with distance from the leading edge, (b) decreases with free-stream velocity, and (c) and increases with kinematic viscosity

6-34C During steady, laminar, two-dimensional flow over an isothermal plate, the wall shear stress decreases with distance from the leading edge

6-35C A major advantage of nondimensionalizing the convection equations is the significant reduction in the number of parameters [the original problem involves 6 parameters ($L, V, T_\infty, T_s, \nu, \alpha$), but the nondimensionalized problem involves just 2 parameters (Re_L and Pr)]. Nondimensionalization also results in similarity parameters (such as Reynolds and Prandtl numbers) that enable us to group the results of a large number of experiments and to report them conveniently in terms of such parameters.

6-36C For steady, laminar, two-dimensional, incompressible flow with constant properties and a Prandtl number of unity and a given geometry, yes, it is correct to say that both the average friction and heat transfer coefficients depend on the Reynolds number only since $C_f = f_4(Re_L)$ and $Nu = g_3(Re_L, Pr)$ from non-dimensionalized momentum and energy equations.

6-37 The hydrodynamic boundary layer and the thermal boundary layer both as a function of x are to be plotted for the flow of air over a plate.

Analysis The problem is solved using Excel, and the solution is given below.

Assumptions

1. The flow is steady and incompressible
2. The critical Reynolds number is 500,000
3. Air is an ideal gas
4. The plate is smooth
5. Edge effects are negligible and the upper surface of the plate is considered

Input Properties

The average film temperature is 40°C (Property data from Table A-15)

$$\begin{aligned}\rho &= 1.127 \text{ kg/m}^3 \\ c_p &= 1007 \text{ J/kg}\cdot^\circ\text{C} \\ \mu &= 0.00001918 \text{ kg/m}\cdot\text{s} \\ \nu &= 1.702 \times 10^{-5} \text{ m}^2/\text{s} \\ k &= 0.02662 \text{ W/m}\cdot^\circ\text{C} \\ \text{Pr} &= 0.7255\end{aligned}$$

Input Parameters

$$\begin{aligned}W &= 0.3 \text{ m} \\ T_{f,\text{avg}} &= 40^\circ\text{C} \\ V &= 3 \text{ m/s} \\ T_{\text{fluid}} &= 15^\circ\text{C} \\ T_s &= 65^\circ\text{C}\end{aligned}$$

Analysis

$$\text{The critical length: } \text{Re} = \frac{Vx_{cr}}{\nu} \longrightarrow x_{cr} = \frac{\text{Re}\nu}{V} = \frac{(500,000)(1.702 \times 10^{-5} \text{ m}^2/\text{s})}{3 \text{ m/s}} = 2.84 \text{ m}$$

$$\text{Hydrodynamic boundary layer thickness: } \delta = \frac{4.91x}{\sqrt{\text{Re}_x}}$$

$$\text{Thermal boundary layer thickness: } \delta_t = \frac{4.91x}{\text{Pr}^{1/3} \sqrt{\text{Re}_x}}$$

x (m)	Re _x	δ	δ _t
0.00	0	0	0
0.10	17628	0.0038	0.0042
0.20	35255	0.0053	0.0059
0.30	52883	0.0065	0.0073
0.40	70511	0.0075	0.0084
0.50	88139	0.0084	0.0094
0.60	105766	0.0092	0.0103
0.70	123394	0.0100	0.0111
0.80	141022	0.0107	0.0119
0.90	158650	0.0113	0.0126
1.00	176277	0.0119	0.0133
1.10	193905	0.0125	0.0139
1.20	211533	0.0130	0.0145
1.30	229161	0.0136	0.0151
1.40	246788	0.0141	0.0157

1.50	264416	0.0146	0.0162
1.60	282044	0.0151	0.0168
1.70	299672	0.0155	0.0173
1.80	317299	0.0160	0.0178
1.90	334927	0.0164	0.0183
2.00	352555	0.0168	0.0187
2.10	370182	0.0173	0.0192
2.20	387810	0.0177	0.0197
2.30	405438	0.0181	0.0201
2.40	423066	0.0184	0.0205
2.50	440693	0.0188	0.0210
2.60	458321	0.0192	0.0214
2.70	475949	0.0196	0.0218
2.80	493577	0.0199	0.0222
2.81	495339	0.0200	0.0222
2.82	497102	0.0200	0.0223
2.83	498865	0.0200	0.0223

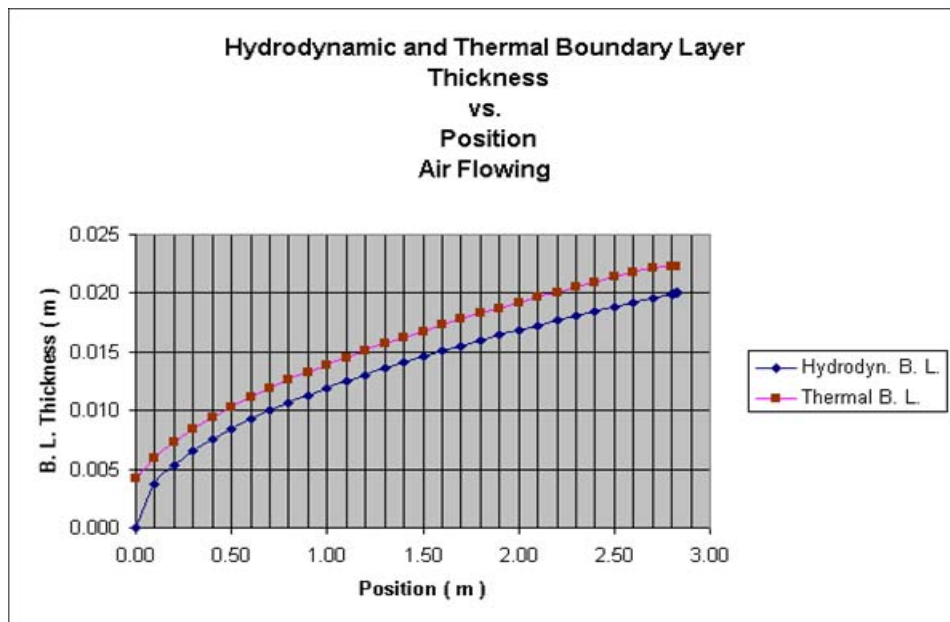

6-38 The hydrodynamic boundary layer and the thermal boundary layer both as a function of x are to be plotted for the flow of liquid water over a plate.

Analysis The problem is solved using Excel, and the solution is given below.

Assumptions

1. The flow is steady and incompressible
2. The critical Reynolds number is 500,000
3. Air is an ideal gas
4. The plate is smooth
5. Edge effects are negligible and the upper surface of the plate is considered

Input Properties

The average film temperature is 40°C (Property data from Table A-9)

$$\rho = 992.1 \text{ kg/m}^3$$

$$c_p = 4179 \text{ J/kg}\cdot^\circ\text{C}$$

$$\mu = 0.000653 \text{ kg/m}\cdot\text{s}$$

$$k = 0.631 \text{ W/m}\cdot^\circ\text{C}$$

$$\text{Pr} = 4.32$$

Input Parameters

$$W = 0.3 \text{ m}$$

$$T_{f,\text{avg}} = 40^\circ\text{C}$$

$$V = 3 \text{ m/s}$$

$$T_{\text{fluid}} = 15^\circ\text{C}$$

$$T_s = 65^\circ\text{C}$$

Analysis

$$\text{The critical length: } \text{Re} = \frac{Vx_{cr}}{\nu} \longrightarrow x_{cr} = \frac{\text{Re} \nu}{V} = \frac{\text{Re} \mu}{V\rho} = \frac{(500,000)(0.000653 \text{ kg/m}\cdot\text{s})}{(3 \text{ m/s})(992.1 \text{ kg/m}^3)} = 0.11 \text{ m}$$

$$\text{Hydrodynamic boundary layer thickness: } \delta = \frac{4.91x}{\sqrt{\text{Re}_x}}$$

$$\text{Thermal boundary layer thickness: } \delta_t = \frac{4.91x}{\text{Pr}^{1/3} \sqrt{\text{Re}_x}}$$

x (m)	Re _x	δ	δ _t
0.000	0.000	0	0
0.005	22789	0.0002	0.0001
0.010	45579	0.0002	0.0001
0.015	68368	0.0003	0.0002
0.020	91158	0.0003	0.0002
0.025	113947	0.0004	0.0002
0.030	136737	0.0004	0.0002
0.035	159526	0.0004	0.0003
0.040	182315	0.0005	0.0003
0.045	205105	0.0005	0.0003
0.050	227894	0.0005	0.0003
0.055	250684	0.0005	0.0003
0.060	273473	0.0006	0.0004
0.065	296263	0.0006	0.0004
0.070	319052	0.0006	0.0004
0.075	341842	0.0006	0.0004

0.080	364631	0.0007	0.0004
0.085	387420	0.0007	0.0004
0.090	410210	0.0007	0.0004
0.095	432999	0.0007	0.0004
0.100	455789	0.0007	0.0005
0.105	478578	0.0008	0.0005
0.110	501368	0.0008	0.0005

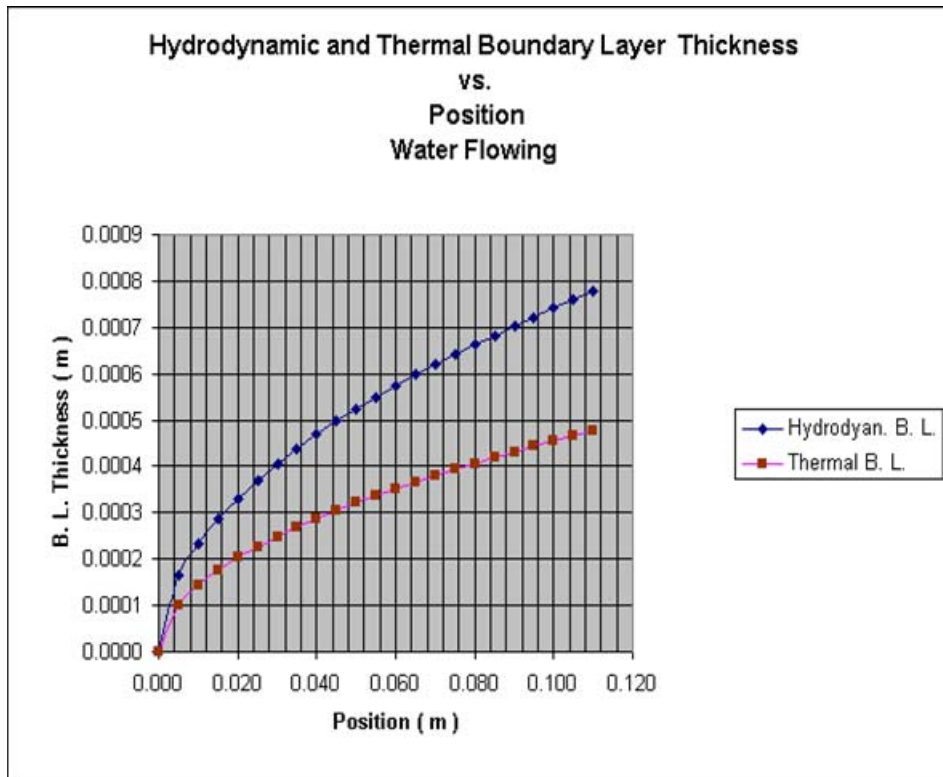

6-39 Parallel flow of oil between two plates is considered. The velocity and temperature distributions, the maximum temperature, and the heat flux are to be determined.

Assumptions **1** Steady operating conditions exist. **2** Oil is an incompressible substance with constant properties. **3** Body forces such as gravity are negligible. **4** The plates are large so that there is no variation in z direction.

Properties The properties of oil at the average temperature of $(40+15)/2 = 27.5^\circ\text{C}$ are (Table A-13):

$$k = 0.145 \text{ W/m}\cdot\text{K} \quad \text{and} \quad \mu = 0.605 \text{ kg/m}\cdot\text{s} = 0.605 \text{ N}\cdot\text{s/m}^2$$

Analysis (a) We take the x -axis to be the flow direction, and y to be the normal direction. This is parallel flow between two plates, and thus $v = 0$. Then the continuity equation reduces to

$$\text{Continuity: } \frac{\partial u}{\partial x} + \frac{\partial v}{\partial y} = 0 \longrightarrow \frac{\partial u}{\partial x} = 0 \longrightarrow u = u(y)$$

Therefore, the x -component of velocity does not change in the flow direction (i.e., the velocity profile remains unchanged). Noting that $u = u(y)$, $v = 0$, and $\partial P / \partial x = 0$ (flow is maintained by the motion of the upper plate rather than the pressure gradient), the x -momentum equation (Eq. 6-28) reduces to

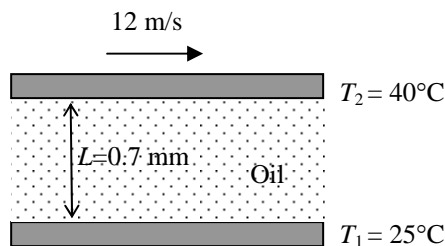

$$x\text{-momentum: } \rho \left(u \frac{\partial u}{\partial x} + v \frac{\partial u}{\partial y} \right) = \mu \frac{\partial^2 u}{\partial y^2} - \frac{\partial P}{\partial x} \longrightarrow \frac{d^2 u}{dy^2} = 0$$

This is a second-order ordinary differential equation, and integrating it twice gives

$$u(y) = C_1 y + C_2$$

The fluid velocities at the plate surfaces must be equal to the velocities of the plates because of the no-slip condition. Therefore, the boundary conditions are $u(0) = 0$ and $u(L) = V$, and applying them gives the velocity distribution to be

$$u(y) = \frac{y}{L} V$$

Frictional heating due to viscous dissipation in this case is significant because of the high viscosity of oil and the large plate velocity. The plates are isothermal and there is no change in the flow direction, and thus the temperature depends on y only, $T = T(y)$. Also, $u = u(y)$ and $v = 0$. Then the energy equation with dissipation (Eqs. 6-36 and 6-37) reduce to

$$\text{Energy: } 0 = k \frac{\partial^2 T}{\partial y^2} + \mu \left(\frac{\partial u}{\partial y} \right)^2 \longrightarrow k \frac{d^2 T}{dy^2} = -\mu \left(\frac{V}{L} \right)^2$$

since $\partial u / \partial y = V / L$. Dividing both sides by k and integrating twice give

$$T(y) = -\frac{\mu}{2k} \left(\frac{y}{L} V \right)^2 + C_3 y + C_4$$

Applying the boundary conditions $T(0) = T_1$ and $T(L) = T_2$ gives the temperature distribution to be

$$T(y) = \frac{T_2 - T_1}{L} y + T_1 + \frac{\mu V^2}{2k} \left(\frac{y}{L} - \frac{y^2}{L^2} \right)$$

(b) The temperature gradient is determined by differentiating $T(y)$ with respect to y ,

$$\frac{dT}{dy} = \frac{T_2 - T_1}{L} + \frac{\mu V^2}{2kL} \left(1 - 2 \frac{y}{L} \right)$$

The location of maximum temperature is determined by setting $dT/dy = 0$ and solving for y ,

$$\frac{dT}{dy} = \frac{T_2 - T_1}{L} + \frac{\mu V^2}{2kL} \left(1 - 2\frac{y}{L}\right) = 0 \quad \longrightarrow \quad y = L \left(k \frac{T_2 - T_1}{\mu V^2} + \frac{1}{2} \right)$$

The maximum temperature is the value of temperature at this y , whose numeric value is

$$y = L \left(k \frac{T_2 - T_1}{\mu V^2} + \frac{1}{2} \right) = (0.0007 \text{ m}) \left[(0.145 \text{ W/m}\cdot\text{C}) \frac{(40 - 15)\text{C}}{(0.605 \text{ N}\cdot\text{s/m}^2)(12 \text{ m/s})^2} + \frac{1}{2} \right]$$

$$= 0.0003791 \text{ m} = \mathbf{0.3791 \text{ mm}}$$

Then

$$T_{\max} = T(0.0003791) = \frac{T_2 - T_1}{L} y + T_1 + \frac{\mu V^2}{2k} \left(\frac{y}{L} - \frac{y^2}{L^2} \right)$$

$$= \frac{(40 - 15)\text{C}}{0.0007 \text{ m}} (0.0003791 \text{ m}) + 15\text{C} + \frac{(0.605 \text{ N}\cdot\text{s/m}^2)(12 \text{ m/s})^2}{2(0.145 \text{ W/m}\cdot\text{C})} \left(\frac{0.0003791 \text{ m}}{0.0007 \text{ m}} - \frac{(0.0003791 \text{ m})^2}{(0.0007 \text{ m})^2} \right)$$

$$= \mathbf{103.1\text{C}}$$

(c) Heat flux at the plates is determined from the definition of heat flux,

$$\dot{q}_0 = -k \left. \frac{dT}{dy} \right|_{y=0} = -k \frac{T_2 - T_1}{L} - k \frac{\mu V^2}{2kL} (1 - 0) = -k \frac{T_2 - T_1}{L} - \frac{\mu V^2}{2L}$$

$$= -(0.145 \text{ W/m}\cdot\text{C}) \frac{(40 - 15)\text{C}}{0.0007 \text{ m}} - \frac{(0.605 \text{ N}\cdot\text{s/m}^2)(12 \text{ m/s})^2}{2(0.0007 \text{ m})} \left(\frac{1 \text{ W}}{1 \text{ N}\cdot\text{m/s}} \right) = \mathbf{-6.74 \times 10^4 \text{ W/m}^2}$$

$$\dot{q}_L = -k \left. \frac{dT}{dy} \right|_{y=L} = -k \frac{T_2 - T_1}{L} - k \frac{\mu V^2}{2kL} (1 - 2) = -k \frac{T_2 - T_1}{L} + \frac{\mu V^2}{2L}$$

$$= -(0.145 \text{ W/m}\cdot\text{C}) \frac{(40 - 15)\text{C}}{0.0007 \text{ m}} + \frac{(0.605 \text{ N}\cdot\text{s/m}^2)(12 \text{ m/s})^2}{2(0.0007 \text{ m})} \left(\frac{1 \text{ W}}{1 \text{ N}\cdot\text{m/s}} \right) = \mathbf{5.71 \times 10^4 \text{ W/m}^2}$$

Discussion A temperature rise of about 76°C confirms our suspicion that viscous dissipation is very significant. Calculations are done using oil properties at 27.5°C , but the oil temperature turned out to be much higher. Therefore, knowing the strong dependence of viscosity on temperature, calculations should be repeated using properties at the average temperature of about 65°C to improve accuracy.

6-40 Parallel flow of oil between two plates is considered. The velocity and temperature distributions, the maximum temperature, and the heat flux are to be determined.

Assumptions **1** Steady operating conditions exist. **2** Oil is an incompressible substance with constant properties. **3** Body forces such as gravity are negligible. **4** The plates are large so that there is no variation in z direction.

Properties The properties of oil at the average temperature of $(40+15)/2 = 27.5^\circ\text{C}$ are (Table A-13):

$$k = 0.145 \text{ W/m}\cdot\text{K} \quad \text{and} \quad \mu = 0.605 \text{ kg/m}\cdot\text{s} = 0.605 \text{ N}\cdot\text{s/m}^2$$

Analysis (a) We take the x -axis to be the flow direction, and y to be the normal direction. This is parallel flow between two plates, and thus $v = 0$. Then the continuity equation (Eq. 6-21) reduces to

$$\text{Continuity: } \frac{\partial u}{\partial x} + \frac{\partial v}{\partial y} = 0 \longrightarrow \frac{\partial u}{\partial x} = 0 \longrightarrow u = u(y)$$

Therefore, the x -component of velocity does not change in the flow direction (i.e., the velocity profile remains unchanged). Noting that $u = u(y)$, $v = 0$, and $\partial P / \partial x = 0$ (flow is maintained by the motion of the upper plate rather than the pressure gradient), the x -momentum equation reduces to

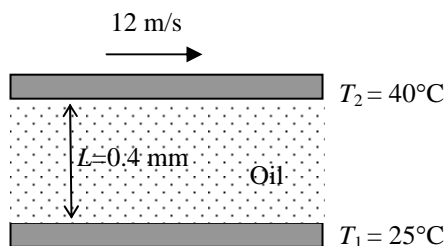

$$x\text{-momentum: } \rho \left(u \frac{\partial u}{\partial x} + v \frac{\partial u}{\partial y} \right) = \mu \frac{\partial^2 u}{\partial y^2} - \frac{\partial P}{\partial x} \longrightarrow \frac{d^2 u}{dy^2} = 0$$

This is a second-order ordinary differential equation, and integrating it twice gives

$$u(y) = C_1 y + C_2$$

The fluid velocities at the plate surfaces must be equal to the velocities of the plates because of the no-slip condition. Therefore, the boundary conditions are $u(0) = 0$ and $u(L) = V$, and applying them gives the velocity distribution to be

$$u(y) = \frac{y}{L} V$$

Frictional heating due to viscous dissipation in this case is significant because of the high viscosity of oil and the large plate velocity. The plates are isothermal and there is no change in the flow direction, and thus the temperature depends on y only, $T = T(y)$. Also, $u = u(y)$ and $v = 0$. Then the energy equation with dissipation reduces to

$$\text{Energy: } 0 = k \frac{\partial^2 T}{\partial y^2} + \mu \left(\frac{\partial u}{\partial y} \right)^2 \longrightarrow k \frac{d^2 T}{dy^2} = -\mu \left(\frac{V}{L} \right)^2$$

since $\partial u / \partial y = V / L$. Dividing both sides by k and integrating twice give

$$T(y) = -\frac{\mu}{2k} \left(\frac{y}{L} V \right)^2 + C_3 y + C_4$$

Applying the boundary conditions $T(0) = T_1$ and $T(L) = T_2$ gives the temperature distribution to be

$$T(y) = \frac{T_2 - T_1}{L} y + T_1 + \frac{\mu V^2}{2k} \left(\frac{y}{L} - \frac{y^2}{L^2} \right)$$

(b) The temperature gradient is determined by differentiating $T(y)$ with respect to y ,

$$\frac{dT}{dy} = \frac{T_2 - T_1}{L} + \frac{\mu V^2}{2kL} \left(1 - 2 \frac{y}{L} \right)$$

The location of maximum temperature is determined by setting $dT/dy = 0$ and solving for y ,

$$\frac{dT}{dy} = \frac{T_2 - T_1}{L} + \frac{\mu V^2}{2kL} \left(1 - 2\frac{y}{L}\right) = 0 \longrightarrow y = L \left(k \frac{T_2 - T_1}{\mu V^2} + \frac{1}{2} \right)$$

The maximum temperature is the value of temperature at this y , whose numeric value is

$$y = L \left(k \frac{T_2 - T_1}{\mu V^2} + \frac{1}{2} \right) = (0.0004 \text{ m}) \left[(0.145 \text{ W/m}\cdot\text{C}) \frac{(40 - 15)\text{C}}{(0.605 \text{ N}\cdot\text{s/m}^2)(12 \text{ m/s})^2} + \frac{1}{2} \right]$$

$$= 0.0002166 \text{ m} = \mathbf{0.2166 \text{ mm}}$$

Then

$$T_{\max} = T(0.0002166) = \frac{T_2 - T_1}{L} y + T_1 + \frac{\mu V^2}{2k} \left(\frac{y}{L} - \frac{y^2}{L^2} \right)$$

$$= \frac{(40 - 15)\text{C}}{0.0004 \text{ m}} (0.0002166 \text{ m}) + 15\text{C} + \frac{(0.605 \text{ N}\cdot\text{s/m}^2)(12 \text{ m/s})^2}{2(0.145 \text{ W/m}\cdot\text{C})} \left(\frac{0.0002166 \text{ m}}{0.0004 \text{ m}} - \frac{(0.0002166 \text{ m})^2}{(0.0004 \text{ m})^2} \right)$$

$$= \mathbf{103.1\text{C}}$$

(c) Heat flux at the plates is determined from the definition of heat flux,

$$\dot{q}_0 = -k \frac{dT}{dy} \Big|_{y=0} = -k \frac{T_2 - T_1}{L} - k \frac{\mu V^2}{2kL} (1 - 0) = -k \frac{T_2 - T_1}{L} - \frac{\mu V^2}{2L}$$

$$= -(0.145 \text{ W/m}\cdot\text{C}) \frac{(40 - 15)\text{C}}{0.0004 \text{ m}} - \frac{(0.605 \text{ N}\cdot\text{s/m}^2)(12 \text{ m/s})^2}{2(0.0004 \text{ m})} \left(\frac{1 \text{ W}}{1 \text{ N}\cdot\text{m/s}} \right) = \mathbf{-1.18 \times 10^5 \text{ W/m}^2}$$

$$\dot{q}_L = -k \frac{dT}{dy} \Big|_{y=L} = -k \frac{T_2 - T_1}{L} - k \frac{\mu V^2}{2kL} (1 - 2) = -k \frac{T_2 - T_1}{L} + \frac{\mu V^2}{2L}$$

$$= -(0.145 \text{ W/m}\cdot\text{C}) \frac{(40 - 15)\text{C}}{0.0004 \text{ m}} + \frac{(0.605 \text{ N}\cdot\text{s/m}^2)(12 \text{ m/s})^2}{2(0.0004 \text{ m})} \left(\frac{1 \text{ W}}{1 \text{ N}\cdot\text{m/s}} \right) = \mathbf{9.98 \times 10^4 \text{ W/m}^2}$$

Discussion A temperature rise of about 76°C confirms our suspicion that viscous dissipation is very significant. Calculations are done using oil properties at 27.5°C, but the oil temperature turned out to be much higher. Therefore, knowing the strong dependence of viscosity on temperature, calculations should be repeated using properties at the average temperature of about 65°C to improve accuracy.

6-41 The oil in a journal bearing is considered. The velocity and temperature distributions, the maximum temperature, the rate of heat transfer, and the mechanical power wasted in oil are to be determined.

Assumptions 1 Steady operating conditions exist. 2 Oil is an incompressible substance with constant properties. 3 Body forces such as gravity are negligible.

Properties The properties of oil at 50°C are given to be

$$k = 0.17 \text{ W/m}\cdot\text{K} \quad \text{and} \quad \mu = 0.05 \text{ N}\cdot\text{s/m}^2$$

Analysis (a) Oil flow in journal bearing can be approximated as parallel flow between two large plates with one plate moving and the other stationary. We take the x -axis to be the flow direction, and y to be the normal direction. This is parallel flow between two plates, and thus $v = 0$. Then the continuity equation reduces to

$$\text{Continuity: } \frac{\partial u}{\partial x} + \frac{\partial v}{\partial y} = 0 \longrightarrow \frac{\partial u}{\partial x} = 0 \longrightarrow u = u(y)$$

Therefore, the x -component of velocity does not change in the flow direction (i.e., the velocity profile remains unchanged). Noting that $u = u(y)$, $v = 0$, and $\partial P / \partial x = 0$ (flow is maintained by the motion of the upper plate rather than the pressure gradient), the x -momentum equation reduces to

$$x\text{-momentum: } \rho \left(u \frac{\partial u}{\partial x} + v \frac{\partial u}{\partial y} \right) = \mu \frac{\partial^2 u}{\partial y^2} - \frac{\partial P}{\partial x} \longrightarrow \frac{d^2 u}{dy^2} = 0$$

This is a second-order ordinary differential equation, and integrating it twice gives

$$u(y) = C_1 y + C_2$$

The fluid velocities at the plate surfaces must be equal to the velocities of the plates because of the no-slip condition. Taking $x = 0$ at the surface of the bearing, the boundary conditions are $u(0) = 0$ and $u(L) = V$, and applying them gives the velocity distribution to be

$$u(y) = \frac{y}{L} V$$

The plates are isothermal and there is no change in the flow direction, and thus the temperature depends on y only, $T = T(y)$. Also, $u = u(y)$ and $v = 0$. Then the energy equation with viscous dissipation reduce to

$$\text{Energy: } 0 = k \frac{\partial^2 T}{\partial y^2} + \mu \left(\frac{\partial u}{\partial y} \right)^2 \longrightarrow k \frac{d^2 T}{dy^2} = -\mu \left(\frac{V}{L} \right)^2$$

since $\partial u / \partial y = V / L$. Dividing both sides by k and integrating twice give

$$T(y) = -\frac{\mu}{2k} \left(\frac{y}{L} V \right)^2 + C_3 y + C_4$$

Applying the boundary conditions $T(0) = T_0$ and $T(L) = T_0$ gives the temperature distribution to be

$$T(y) = T_0 + \frac{\mu V^2}{2k} \left(\frac{y}{L} - \frac{y^2}{L^2} \right)$$

The temperature gradient is determined by differentiating $T(y)$ with respect to y ,

$$\frac{dT}{dy} = \frac{\mu V^2}{2kL} \left(1 - 2 \frac{y}{L} \right)$$

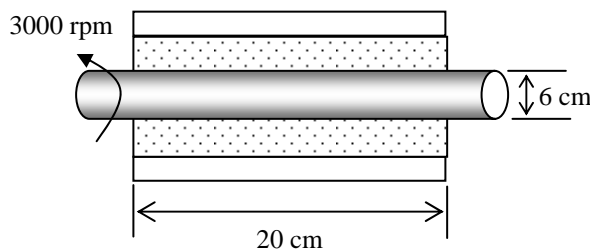

The location of maximum temperature is determined by setting $dT/dy = 0$ and solving for y ,

$$\frac{dT}{dy} = \frac{\mu V^2}{2kL} \left(1 - 2 \frac{y}{L}\right) = 0 \quad \longrightarrow \quad y = \frac{L}{2}$$

Therefore, maximum temperature will occur at mid plane in the oil. The velocity and the surface area are

$$V = \pi D \dot{n} = \pi (0.06 \text{ m})(3000 \text{ rev/min}) \left(\frac{1 \text{ min}}{60 \text{ s}}\right) = 9.425 \text{ m/s}$$

$$A = \pi D L_{\text{bearing}} = \pi (0.06 \text{ m})(0.20 \text{ m}) = 0.0377 \text{ m}^2$$

The maximum temperature is

$$\begin{aligned} T_{\text{max}} &= T(L/2) = T_0 + \frac{\mu V^2}{2k} \left(\frac{L/2}{L} - \frac{(L/2)^2}{L^2} \right) \\ &= T_0 + \frac{\mu V^2}{8k} = 50^\circ\text{C} + \frac{(0.05 \text{ N}\cdot\text{s/m}^2)(9.425 \text{ m/s})^2}{8(0.17 \text{ W/m}\cdot^\circ\text{C})} \left(\frac{1 \text{ W}}{1 \text{ N}\cdot\text{m/s}} \right) = \mathbf{53.3^\circ\text{C}} \end{aligned}$$

(b) The rates of heat transfer are

$$\begin{aligned} \dot{Q}_0 &= -kA \left. \frac{dT}{dy} \right|_{y=0} = -kA \frac{\mu V^2}{2kL} (1-0) = -A \frac{\mu V^2}{2L} \\ &= -(0.0377 \text{ m}^2) \frac{(0.05 \text{ N}\cdot\text{s/m}^2)(9.425 \text{ m/s})^2}{2(0.0002 \text{ m})} \left(\frac{1 \text{ W}}{1 \text{ N}\cdot\text{m/s}} \right) = \mathbf{-419 \text{ W}} \end{aligned}$$

$$\dot{Q}_L = -kA \left. \frac{dT}{dy} \right|_{y=L} = -kA \frac{\mu V^2}{2kL} (1-2) = A \frac{\mu V^2}{2L} = -\dot{Q}_0 = \mathbf{419 \text{ W}}$$

(c) Therefore, rates of heat transfer at the two plates are equal in magnitude but opposite in sign. The mechanical power wasted is equal to the rate of heat transfer.

$$\dot{W}_{\text{mech}} = \dot{Q} = 2 \times 419 = \mathbf{838 \text{ W}}$$

6-42 The oil in a journal bearing is considered. The velocity and temperature distributions, the maximum temperature, the rate of heat transfer, and the mechanical power wasted in oil are to be determined.

Assumptions 1 Steady operating conditions exist. 2 Oil is an incompressible substance with constant properties. 3 Body forces such as gravity are negligible.

Properties The properties of oil at 50°C are given to be

$$k = 0.17 \text{ W/m}\cdot\text{K} \quad \text{and} \quad \mu = 0.05 \text{ N}\cdot\text{s/m}^2$$

Analysis (a) Oil flow in journal bearing can be approximated as parallel flow between two large plates with one plate moving and the other stationary. We take the x -axis to be the flow direction, and y to be the normal direction. This is parallel flow between two plates, and thus $v = 0$. Then the continuity equation reduces to

$$\text{Continuity: } \frac{\partial u}{\partial x} + \frac{\partial v}{\partial y} = 0 \longrightarrow \frac{\partial u}{\partial x} = 0 \longrightarrow u = u(y)$$

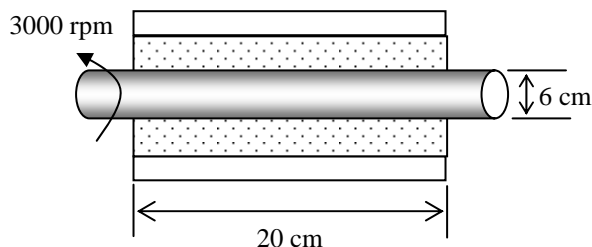

Therefore, the x -component of velocity does not change in the flow direction (i.e., the velocity profile remains unchanged). Noting that $u = u(y)$, $v = 0$, and $\partial P / \partial x = 0$ (flow is maintained by the motion of the upper plate rather than the pressure gradient), the x -momentum equation reduces to

$$x\text{-momentum: } \rho \left(u \frac{\partial u}{\partial x} + v \frac{\partial u}{\partial y} \right) = \mu \frac{\partial^2 u}{\partial y^2} - \frac{\partial P}{\partial x} \longrightarrow \frac{d^2 u}{dy^2} = 0$$

This is a second-order ordinary differential equation, and integrating it twice gives

$$u(y) = C_1 y + C_2$$

The fluid velocities at the plate surfaces must be equal to the velocities of the plates because of the no-slip condition. Taking $x = 0$ at the surface of the bearing, the boundary conditions are $u(0) = 0$ and $u(L) = V$, and applying them gives the velocity distribution to be

$$u(y) = \frac{y}{L} V$$

Frictional heating due to viscous dissipation in this case is significant because of the high viscosity of oil and the large plate velocity. The plates are isothermal and there is no change in the flow direction, and thus the temperature depends on y only, $T = T(y)$. Also, $u = u(y)$ and $v = 0$. Then the energy equation with dissipation reduce to

$$\text{Energy: } 0 = k \frac{\partial^2 T}{\partial y^2} + \mu \left(\frac{\partial u}{\partial y} \right)^2 \longrightarrow k \frac{d^2 T}{dy^2} = -\mu \left(\frac{V}{L} \right)^2$$

since $\partial u / \partial y = V / L$. Dividing both sides by k and integrating twice give

$$\begin{aligned} \frac{dT}{dy} &= -\frac{\mu}{k} \left(\frac{V}{L} \right)^2 y + C_3 \\ T(y) &= -\frac{\mu}{2k} \left(\frac{y}{L} V \right)^2 + C_3 y + C_4 \end{aligned}$$

Applying the two boundary conditions give

$$\text{B.C. 1: } y=0 \quad T(0) = T_1 \longrightarrow C_4 = T_1$$

$$\text{B.C. 2: } y=L \quad -k \left. \frac{dT}{dy} \right|_{y=L} = 0 \longrightarrow C_3 = \frac{\mu V^2}{kL}$$

Substituting the constants give the temperature distribution to be

$$T(y) = T_1 + \frac{\mu V^2}{kL} \left(y - \frac{y^2}{2L} \right)$$

The temperature gradient is determined by differentiating $T(y)$ with respect to y ,

$$\frac{dT}{dy} = \frac{\mu V^2}{kL} \left(1 - \frac{y}{L} \right)$$

The location of maximum temperature is determined by setting $dT/dy = 0$ and solving for y ,

$$\frac{dT}{dy} = \frac{\mu V^2}{kL} \left(1 - \frac{y}{L} \right) = 0 \longrightarrow y = L$$

This result is also known from the second boundary condition. Therefore, maximum temperature will occur at the shaft surface, for $y = L$. The velocity and the surface area are

$$V = \pi D \dot{N} = \pi(0.06 \text{ m})(3000 \text{ rev/min}) \left(\frac{1 \text{ min}}{60 \text{ s}} \right) = 9.425 \text{ m/s}$$

$$A = \pi D L_{\text{bearing}} = \pi(0.06 \text{ m})(0.20 \text{ m}) = 0.0377 \text{ m}^2$$

The maximum temperature is

$$\begin{aligned} T_{\text{max}} = T(L) &= T_1 + \frac{\mu V^2}{kL} \left(L - \frac{L^2}{2L} \right) = T_1 + \frac{\mu V^2}{k} \left(1 - \frac{1}{2} \right) = T_1 + \frac{\mu V^2}{2k} \\ &= 50^\circ\text{C} + \frac{(0.05 \text{ N} \cdot \text{s}/\text{m}^2)(9.425 \text{ m/s})^2}{2(0.17 \text{ W}/\text{m} \cdot ^\circ\text{C})} \left(\frac{1 \text{ W}}{1 \text{ N} \cdot \text{m/s}} \right) = \mathbf{63.1^\circ\text{C}} \end{aligned}$$

(b) The rate of heat transfer to the bearing is

$$\begin{aligned} \dot{Q}_0 &= -kA \left. \frac{dT}{dy} \right|_{y=0} = -kA \frac{\mu V^2}{kL} (1-0) = -A \frac{\mu V^2}{L} \\ &= -(0.0377 \text{ m}^2) \frac{(0.05 \text{ N} \cdot \text{s}/\text{m}^2)(9.425 \text{ m/s})^2}{0.0002 \text{ m}} \left(\frac{1 \text{ W}}{1 \text{ N} \cdot \text{m/s}} \right) = \mathbf{-837 \text{ W}} \end{aligned}$$

(c) The rate of heat transfer to the shaft is zero. The mechanical power wasted is equal to the rate of heat transfer,

$$\dot{W}_{\text{mech}} = \dot{Q} = \mathbf{837 \text{ W}}$$

6-43 EES Prob. 6-41 is reconsidered. The effect of shaft velocity on the mechanical power wasted by viscous dissipation is to be investigated.

Analysis The problem is solved using EES, and the solution is given below.

"GIVEN"

D=0.06 [m]
 N_dot=3000 [1/h]
 L_bearing=0.20 [m]
 L=0.0002 [m]
 T_0=50 [C]

"PROPERTIES"

k=0.17 [W/m-K]
 mu=0.05 [N-s/m²]

"ANALYSIS"

Vel=pi*D*N_dot*Convert(1/min, 1/s)
 A=pi*D*L_bearing
 T_max=T_0+(mu*Vel^2)/(8*k)
 Q_dot=A*(mu*Vel^2)/(2*L)
 W_dot_mech=Q_dot

N [rpm]	W _{mech} [W]
0	0
250	2.907
500	11.63
750	26.16
1000	46.51
1250	72.67
1500	104.7
1750	142.4
2000	186
2250	235.5
2500	290.7
2750	351.7
3000	418.6
3250	491.3
3500	569.8
3750	654.1
4000	744.2
4250	840.1
4500	941.9
4750	1049
5000	1163

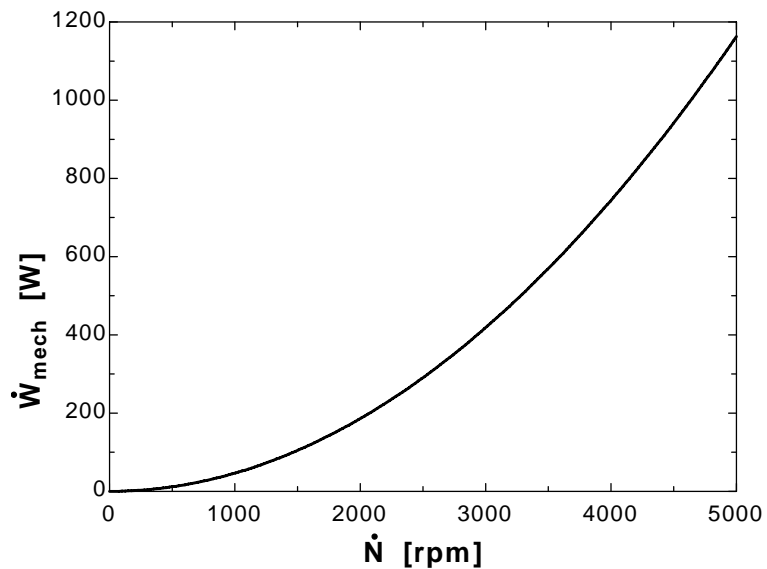

6-44 A shaft rotating in a bearing is considered. The power required to rotate the shaft is to be determined for different fluids in the gap.

Assumptions 1 Steady operating conditions exist. 2 The fluid has constant properties. 3 Body forces such as gravity are negligible.

Properties The properties of air, water, and oil at 40°C are (Tables A-15, A-9, A-13)

Air: $\mu = 1.918 \times 10^{-5} \text{ N}\cdot\text{s}/\text{m}^2$

Water: $\mu = 0.653 \times 10^{-3} \text{ N}\cdot\text{s}/\text{m}^2$

Oil: $\mu = 0.2177 \text{ N}\cdot\text{s}/\text{m}^2$

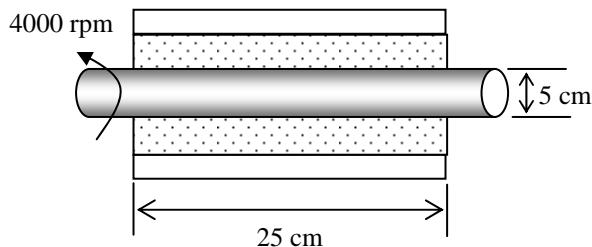

Analysis A shaft rotating in a bearing can be approximated as parallel flow between two large plates with one plate moving and the other stationary. Therefore, we solve this problem considering such a flow with the plates separated by a $L=0.5 \text{ mm}$ thick fluid film similar to the problem given in Example 6-1. By simplifying and solving the continuity, momentum, and energy equations it is found in Example 6-1 that

$$\dot{W}_{\text{mech}} = \dot{Q}_0 = -\dot{Q}_L = -kA \frac{dT}{dy} \Big|_{y=0} = -kA \frac{\mu V^2}{2kL} (1-0) = -A \frac{\mu V^2}{2L} = -A \frac{\mu V^2}{2L}$$

First, the velocity and the surface area are

$$V = \pi D \dot{N} = \pi(0.05 \text{ m})(4000 \text{ rev}/\text{min}) \left(\frac{1 \text{ min}}{60 \text{ s}} \right) = 10.47 \text{ m/s}$$

$$A = \pi D L_{\text{bearing}} = \pi(0.05 \text{ m})(0.25 \text{ m}) = 0.03927 \text{ m}^2$$

(a) Air:

$$\dot{W}_{\text{mech}} = -A \frac{\mu V^2}{2L} = -(0.03927 \text{ m}^2) \frac{(1.918 \times 10^{-5} \text{ N}\cdot\text{s}/\text{m}^2)(10.47 \text{ m/s})^2}{2(0.0005 \text{ m})} \left(\frac{1 \text{ W}}{1 \text{ N}\cdot\text{m/s}} \right) = \mathbf{-0.083 \text{ W}}$$

(b) Water:

$$\dot{W}_{\text{mech}} = \dot{Q}_0 = -A \frac{\mu V^2}{2L} = -(0.03927 \text{ m}^2) \frac{(0.653 \times 10^{-3} \text{ N}\cdot\text{s}/\text{m}^2)(10.47 \text{ m/s})^2}{2(0.0005 \text{ m})} \left(\frac{1 \text{ W}}{1 \text{ N}\cdot\text{m/s}} \right) = \mathbf{-2.81 \text{ W}}$$

(c) Oil:

$$\dot{W}_{\text{mech}} = \dot{Q}_0 = -A \frac{\mu V^2}{2L} = -(0.03927 \text{ m}^2) \frac{(0.2177 \text{ N}\cdot\text{s}/\text{m}^2)(10.47 \text{ m/s})^2}{2(0.0005 \text{ m})} \left(\frac{1 \text{ W}}{1 \text{ N}\cdot\text{m/s}} \right) = \mathbf{-937 \text{ W}}$$

6-45 The flow of fluid between two large parallel plates is considered. The relations for the maximum temperature of fluid, the location where it occurs, and heat flux at the upper plate are to be obtained.

Assumptions 1 Steady operating conditions exist. 2 The fluid has constant properties. 3 Body forces such as gravity are negligible.

Analysis We take the x -axis to be the flow direction, and y to be the normal direction. This is parallel flow between two plates, and thus $v = 0$. Then the continuity equation reduces to

$$\text{Continuity: } \frac{\partial u}{\partial x} + \frac{\partial v}{\partial y} = 0 \longrightarrow \frac{\partial u}{\partial x} = 0 \longrightarrow u = u(y)$$

Therefore, the x -component of velocity does not change in the flow direction (i.e., the velocity profile remains unchanged). Noting that $u = u(y)$, $v = 0$, and $\partial P / \partial x = 0$ (flow is maintained by the motion of the upper plate rather than the pressure gradient), the x -momentum equation reduces to

$$x\text{-momentum: } \rho \left(u \frac{\partial u}{\partial x} + v \frac{\partial u}{\partial y} \right) = \mu \frac{\partial^2 u}{\partial y^2} - \frac{\partial P}{\partial x} \longrightarrow \frac{d^2 u}{dy^2} = 0$$

This is a second-order ordinary differential equation, and integrating it twice gives

$$u(y) = C_1 y + C_2$$

The fluid velocities at the plate surfaces must be equal to the velocities of the plates because of the no-slip condition. Therefore, the boundary conditions are $u(0) = 0$ and $u(L) = V$, and applying them gives the velocity distribution to be

$$u(y) = \frac{y}{L} V$$

Frictional heating due to viscous dissipation in this case is significant because of the high viscosity of oil and the large plate velocity. The plates are isothermal and there is no change in the flow direction, and thus the temperature depends on y only, $T = T(y)$. Also, $u = u(y)$ and $v = 0$. Then the energy equation with dissipation (Eqs. 6-36 and 6-37) reduce to

$$\text{Energy: } 0 = k \frac{\partial^2 T}{\partial y^2} + \mu \left(\frac{\partial u}{\partial y} \right)^2 \longrightarrow k \frac{d^2 T}{dy^2} = -\mu \left(\frac{V}{L} \right)^2$$

since $\partial u / \partial y = V / L$. Dividing both sides by k and integrating twice give

$$\begin{aligned} \frac{dT}{dy} &= -\frac{\mu}{k} \left(\frac{V}{L} \right)^2 y + C_3 \\ T(y) &= -\frac{\mu}{2k} \left(\frac{y}{L} V \right)^2 + C_3 y + C_4 \end{aligned}$$

Applying the two boundary conditions give

$$\text{B.C. 1: } y=0 \quad -k \left. \frac{dT}{dy} \right|_{y=0} = 0 \longrightarrow C_3 = 0$$

$$\text{B.C. 2: } y=L \quad T(L) = T_0 \longrightarrow C_4 = T_0 + \frac{\mu V^2}{2k}$$

Substituting the constants give the temperature distribution to be

$$T(y) = T_0 + \frac{\mu V^2}{2k} \left(1 - \frac{y^2}{L^2} \right)$$

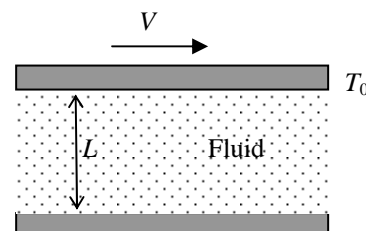

The temperature gradient is determined by differentiating $T(y)$ with respect to y ,

$$\frac{dT}{dy} = \frac{-\mu V^2}{kL^2} y$$

The location of maximum temperature is determined by setting $dT/dy = 0$ and solving for y ,

$$\frac{dT}{dy} = \frac{-\mu V^2}{kL^2} y = 0 \longrightarrow y = 0$$

Therefore, maximum temperature will occur at the lower plate surface, and its value is

$$T_{\max} = T(0) = T_0 + \frac{\mu V^2}{2k}$$

The heat flux at the upper plate is

$$\dot{q}_L = -k \left. \frac{dT}{dy} \right|_{y=L} = k \frac{\mu V^2}{kL^2} L = \frac{\mu V^2}{L}$$

6-46 The flow of fluid between two large parallel plates is considered. Using the results of Problem 6-45, a relation for the volumetric heat generation rate is to be obtained using the conduction problem, and the result is to be verified.

Assumptions **1** Steady operating conditions exist. **2** The fluid has constant properties. **3** Body forces such as gravity are negligible.

Analysis The energy equation in Prob. 6-45 was determined to be

$$k \frac{d^2 T}{dy^2} = -\mu \left(\frac{V}{L} \right)^2 \quad (1)$$

The steady one-dimensional heat conduction equation with constant heat generation is

$$\frac{d^2 T}{dy^2} + \frac{\dot{e}_{\text{gen}}}{k} = 0 \quad (2)$$

Comparing the two equations above, the volumetric heat generation rate is determined to be

$$\dot{e}_{\text{gen}} = \mu \left(\frac{V}{L} \right)^2$$

Integrating Eq. (2) twice gives

$$\begin{aligned} \frac{dT}{dy} &= -\frac{\dot{e}_{\text{gen}}}{k} y + C_3 \\ T(y) &= -\frac{\dot{e}_{\text{gen}}}{2k} y^2 + C_3 y + C_4 \end{aligned}$$

Applying the two boundary conditions give

$$\text{B.C. 1: } y=0 \quad -k \left. \frac{dT}{dy} \right|_{y=0} = 0 \longrightarrow C_3 = 0$$

$$\text{B.C. 2: } y=L \quad T(L) = T_0 \longrightarrow C_4 = T_0 + \frac{\dot{e}_{\text{gen}}}{2k} L^2$$

Substituting, the temperature distribution becomes

$$T(y) = T_0 + \frac{\dot{e}_{\text{gen}} L^2}{2k} \left(1 - \frac{y^2}{L^2} \right)$$

Maximum temperature occurs at $y = 0$, and its value is

$$T_{\text{max}} = T(0) = T_0 + \frac{\dot{e}_{\text{gen}} L^2}{2k}$$

which is equivalent to the result $T_{\text{max}} = T(0) = T_0 + \frac{\mu V^2}{2k}$ obtained in Prob. 6-45.

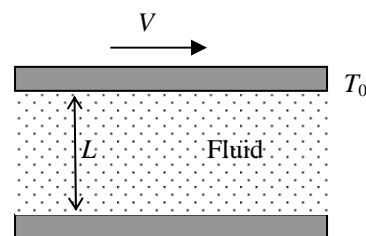

6-47 The oil in a journal bearing is considered. The bearing is cooled externally by a liquid. The surface temperature of the shaft, the rate of heat transfer to the coolant, and the mechanical power wasted are to be determined.

Assumptions 1 Steady operating conditions exist. 2 Oil is an incompressible substance with constant properties. 3 Body forces such as gravity are negligible.

Properties The properties of oil are given to be $k = 0.14 \text{ W/m}\cdot\text{K}$ and $\mu = 0.03 \text{ N}\cdot\text{s/m}^2$. The thermal conductivity of bearing is given to be $k = 70 \text{ W/m}\cdot\text{K}$.

Analysis (a) Oil flow in a journal bearing can be approximated as parallel flow between two large plates with one plate moving and the other stationary. We take the x -axis to be the flow direction, and y to be the normal direction. This is parallel flow between two plates, and thus $v = 0$. Then the continuity equation reduces to

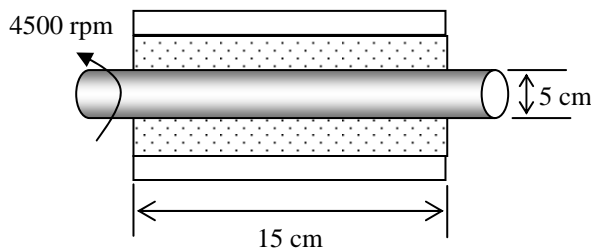

$$\text{Continuity: } \frac{\partial u}{\partial x} + \frac{\partial v}{\partial y} = 0 \longrightarrow \frac{\partial u}{\partial x} = 0 \longrightarrow u = u(y)$$

Therefore, the x -component of velocity does not change in the flow direction (i.e., the velocity profile remains unchanged). Noting that $u = u(y)$, $v = 0$, and $\partial P / \partial x = 0$ (flow is maintained by the motion of the upper plate rather than the pressure gradient), the x -momentum equation reduces to

$$x\text{-momentum: } \rho \left(u \frac{\partial u}{\partial x} + v \frac{\partial u}{\partial y} \right) = \mu \frac{\partial^2 u}{\partial y^2} - \frac{\partial P}{\partial x} \longrightarrow \frac{d^2 u}{dy^2} = 0$$

This is a second-order ordinary differential equation, and integrating it twice gives

$$u(y) = C_1 y + C_2$$

The fluid velocities at the plate surfaces must be equal to the velocities of the plates because of the no-slip condition. Therefore, the boundary conditions are $u(0) = 0$ and $u(L) = V$, and applying them gives the velocity distribution to be

$$u(y) = \frac{y}{L} V$$

where

$$V = \pi D \dot{n} = \pi (0.05 \text{ m}) (4500 \text{ rev/min}) \left(\frac{1 \text{ min}}{60 \text{ s}} \right) = 11.78 \text{ m/s}$$

The plates are isothermal and there is no change in the flow direction, and thus the temperature depends on y only, $T = T(y)$. Also, $u = u(y)$ and $v = 0$. Then the energy equation with viscous dissipation reduces to

$$\text{Energy: } 0 = k \frac{\partial^2 T}{\partial y^2} + \mu \left(\frac{\partial u}{\partial y} \right)^2 \longrightarrow k \frac{d^2 T}{dy^2} = -\mu \left(\frac{V}{L} \right)^2$$

since $\partial u / \partial y = V / L$. Dividing both sides by k and integrating twice give

$$\frac{dT}{dy} = -\frac{\mu}{k} \left(\frac{V}{L} \right)^2 y + C_3$$

$$T(y) = -\frac{\mu}{2k} \left(\frac{y}{L} V \right)^2 + C_3 y + C_4$$

Applying the two boundary conditions give

$$\text{B.C. 1: } y=0 \quad -k \left. \frac{dT}{dy} \right|_{y=0} = 0 \longrightarrow C_3 = 0$$

$$\text{B.C. 2: } y=L \quad T(L) = T_0 \longrightarrow C_4 = T_0 + \frac{\mu V^2}{2k}$$

Substituting the constants give the temperature distribution to be

$$T(y) = T_0 + \frac{\mu V^2}{2k} \left(1 - \frac{y^2}{L^2} \right)$$

The temperature gradient is determined by differentiating $T(y)$ with respect to y ,

$$\frac{dT}{dy} = \frac{-\mu V^2}{kL^2} y$$

The heat flux at the upper surface is

$$\dot{q}_L = -k \left. \frac{dT}{dy} \right|_{y=L} = k \frac{\mu V^2}{kL^2} L = \frac{\mu V^2}{L}$$

Noting that heat transfer along the shaft is negligible, all the heat generated in the oil is transferred to the shaft, and the rate of heat transfer is

$$\dot{Q} = A_s \dot{q}_L = (\pi DW) \frac{\mu V^2}{L} = \pi(0.05 \text{ m})(0.15 \text{ m}) \frac{(0.03 \text{ N} \cdot \text{s}/\text{m}^2)(11.78 \text{ m/s})^2}{0.0006 \text{ m}} = \mathbf{163.5 \text{ W}}$$

(b) This is equivalent to the rate of heat transfer through the cylindrical sleeve by conduction, which is expressed as

$$\dot{Q} = k \frac{2\pi W(T_0 - T_s)}{\ln(D_0/D)} \rightarrow (70 \text{ W}/\text{m} \cdot ^\circ\text{C}) \frac{2\pi(0.15 \text{ m})(T_0 - 40^\circ\text{C})}{\ln(8/5)} = 163.5 \text{ W}$$

which gives the surface temperature of the shaft to be

$$T_o = \mathbf{41.2^\circ\text{C}}$$

(c) The mechanical power wasted by the viscous dissipation in oil is equivalent to the rate of heat generation,

$$\dot{W}_{lost} = \dot{Q} = \mathbf{163.5 \text{ W}}$$

6-48 The oil in a journal bearing is considered. The bearing is cooled externally by a liquid. The surface temperature of the shaft, the rate of heat transfer to the coolant, and the mechanical power wasted are to be determined.

Assumptions **1** Steady operating conditions exist. **2** Oil is an incompressible substance with constant properties. **3** Body forces such as gravity are negligible.

Properties The properties of oil are given to be $k = 0.14 \text{ W/m}\cdot\text{K}$ and $\mu = 0.03 \text{ N}\cdot\text{s/m}^2$. The thermal conductivity of bearing is given to be $k = 70 \text{ W/m}\cdot\text{K}$.

Analysis (a) Oil flow in a journal bearing can be approximated as parallel flow between two large plates with one plate moving and the other stationary. We take the x -axis to be the flow direction, and y to be the normal direction. This is parallel flow between two plates, and thus $v = 0$. Then the continuity equation reduces to

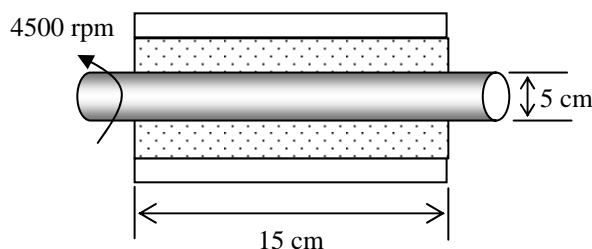

$$\text{Continuity: } \frac{\partial u}{\partial x} + \frac{\partial v}{\partial y} = 0 \longrightarrow \frac{\partial u}{\partial x} = 0 \longrightarrow u = u(y)$$

Therefore, the x -component of velocity does not change in the flow direction (i.e., the velocity profile remains unchanged). Noting that $u = u(y)$, $v = 0$, and $\partial P / \partial x = 0$ (flow is maintained by the motion of the upper plate rather than the pressure gradient), the x -momentum equation reduces to

$$x\text{-momentum: } \rho \left(u \frac{\partial u}{\partial x} + v \frac{\partial u}{\partial y} \right) = \mu \frac{\partial^2 u}{\partial y^2} - \frac{\partial P}{\partial x} \longrightarrow \frac{d^2 u}{dy^2} = 0$$

This is a second-order ordinary differential equation, and integrating it twice gives

$$u(y) = C_1 y + C_2$$

The fluid velocities at the plate surfaces must be equal to the velocities of the plates because of the no-slip condition. Therefore, the boundary conditions are $u(0) = 0$ and $u(L) = V$, and applying them gives the velocity distribution to be

$$u(y) = \frac{y}{L} V$$

where

$$V = \pi D \dot{n} = \pi (0.05 \text{ m}) (4500 \text{ rev/min}) \left(\frac{1 \text{ min}}{60 \text{ s}} \right) = 11.78 \text{ m/s}$$

The plates are isothermal and there is no change in the flow direction, and thus the temperature depends on y only, $T = T(y)$. Also, $u = u(y)$ and $v = 0$. Then the energy equation with viscous dissipation reduces to

$$\text{Energy: } 0 = k \frac{\partial^2 T}{\partial y^2} + \mu \left(\frac{\partial u}{\partial y} \right)^2 \longrightarrow k \frac{d^2 T}{dy^2} = -\mu \left(\frac{V}{L} \right)^2$$

since $\partial u / \partial y = V / L$. Dividing both sides by k and integrating twice give

$$\frac{dT}{dy} = -\frac{\mu}{k} \left(\frac{V}{L} \right)^2 y + C_3$$

$$T(y) = -\frac{\mu}{2k} \left(\frac{y}{L} V \right)^2 + C_3 y + C_4$$

Applying the two boundary conditions give

$$\text{B.C. 1: } y=0 \quad -k \left. \frac{dT}{dy} \right|_{y=0} = 0 \longrightarrow C_3 = 0$$

$$\text{B.C. 2: } y=L \quad T(L) = T_0 \longrightarrow C_4 = T_0 + \frac{\mu V^2}{2k}$$

Substituting the constants give the temperature distribution to be

$$T(y) = T_0 + \frac{\mu V^2}{2k} \left(1 - \frac{y^2}{L^2} \right)$$

The temperature gradient is determined by differentiating $T(y)$ with respect to y ,

$$\frac{dT}{dy} = \frac{-\mu V^2}{kL^2} y$$

The heat flux at the upper surface is

$$\dot{q}_L = -k \left. \frac{dT}{dy} \right|_{y=L} = k \frac{\mu V^2}{kL^2} L = \frac{\mu V^2}{L}$$

Noting that heat transfer along the shaft is negligible, all the heat generated in the oil is transferred to the shaft, and the rate of heat transfer is

$$\dot{Q} = A_s \dot{q}_L = (\pi DW) \frac{\mu V^2}{L} = \pi(0.05 \text{ m})(0.15 \text{ m}) \frac{(0.03 \text{ N} \cdot \text{s}/\text{m}^2)(11.78 \text{ m/s})^2}{0.001 \text{ m}} = \mathbf{98.1 \text{ W}}$$

(b) This is equivalent to the rate of heat transfer through the cylindrical sleeve by conduction, which is expressed as

$$\dot{Q} = k \frac{2\pi W(T_0 - T_s)}{\ln(D_0/D)} \rightarrow (70 \text{ W}/\text{m} \cdot ^\circ\text{C}) \frac{2\pi(0.15 \text{ m})(T_0 - 40^\circ\text{C})}{\ln(8/5)} = 98.1 \text{ W}$$

which gives the surface temperature of the shaft to be

$$T_o = \mathbf{40.7^\circ\text{C}}$$

(c) The mechanical power wasted by the viscous dissipation in oil is equivalent to the rate of heat generation,

$$\dot{W}_{lost} = \dot{Q} = \mathbf{98.1 \text{ W}}$$

Momentum and Heat Transfer Analogies

6-49C Reynolds analogy is expressed as $C_{f,x} \frac{\text{Re}_L}{2} = \text{Nu}_x$. It allows us to calculate the heat transfer coefficient from a knowledge of friction coefficient. It is limited to flow of fluids with a Prandtl number of near unity (such as gases), and negligible pressure gradient in the flow direction (such as flow over a flat plate).

6-50C Modified Reynolds analogy is expressed as $C_{f,x} \frac{\text{Re}_L}{2} = \text{Nu}_x \text{Pr}^{-1/3}$ or $\frac{C_{f,x}}{2} = \frac{h_x}{\rho c_p V} \text{Pr}^{2/3} \equiv j_H$.

It allows us to calculate the heat transfer coefficient from a knowledge of friction coefficient. It is valid for a Prandtl number range of $0.6 < \text{Pr} < 60$. This relation is developed using relations for laminar flow over a flat plate, but it is also applicable approximately for turbulent flow over a surface, even in the presence of pressure gradients.

6-51 A flat plate is subjected to air flow, and the drag force acting on it is measured. The average convection heat transfer coefficient and the rate of heat transfer on the upper surface are to be determined.

Assumptions 1 Steady operating conditions exist. 2 The edge effects are negligible.

Properties The properties of air at 20°C and 1 atm are (Table A-15)

$$\rho = 1.204 \text{ kg/m}^3, \quad c_p = 1.007 \text{ kJ/kg}\cdot\text{K}, \quad \text{Pr} = 0.7309$$

Analysis The flow is along the 4-m side of the plate, and thus the characteristic length is $L = 4 \text{ m}$. The surface area of the upper surface is

$$A_s = WL = (4 \text{ m})(4 \text{ m}) = 16 \text{ m}^2$$

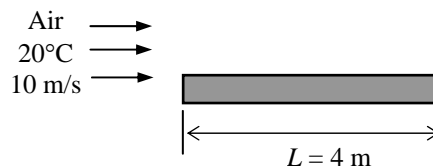

For flat plates, the drag force is equivalent to friction force. The average friction coefficient C_f can be determined from

$$F_f = C_f A_s \frac{\rho V^2}{2} \longrightarrow C_f = \frac{F_f}{\rho A_s V^2 / 2} = \frac{2.4 \text{ N}}{(1.204 \text{ kg/m}^3)(16 \text{ m}^2)(10 \text{ m/s})^2 / 2} \left(\frac{1 \text{ kg} \cdot \text{m/s}^2}{1 \text{ N}} \right) = 0.002492$$

Then the average heat transfer coefficient can be determined from the modified Reynolds analogy to be

$$h = \frac{C_f}{2} \frac{\rho V c_p}{\text{Pr}^{2/3}} = \frac{0.002492}{2} \frac{(1.204 \text{ kg/m}^3)(10 \text{ m/s})(1007 \text{ J/kg}\cdot^\circ\text{C})}{(0.7309)^{2/3}} = \mathbf{18.62 \text{ W/m}^2 \cdot ^\circ\text{C}}$$

Then the rate of heat transfer becomes

$$\dot{Q} = h A_s (T_s - T_\infty) = (18.62 \text{ W/m}^2 \cdot ^\circ\text{C})(16 \text{ m}^2)(80 - 20)^\circ\text{C} = \mathbf{17,900 \text{ W}}$$

6-52 A metallic airfoil is subjected to air flow. The average friction coefficient is to be determined.

Assumptions 1 Steady operating conditions exist. 2 The edge effects are negligible.

Properties The properties of air at 25°C and 1 atm are (Table A-15)

$$\rho = 1.184 \text{ kg/m}^3, \quad c_p = 1.007 \text{ kJ/kg}\cdot\text{K}, \quad \text{Pr} = 0.7296$$

Analysis First, we determine the rate of heat transfer from

$$\dot{Q} = \frac{mc_{p,\text{airfoil}}(T_2 - T_1)}{\Delta t} = \frac{(50 \text{ kg})(500 \text{ J/kg}\cdot^\circ\text{C})(160 - 150)^\circ\text{C}}{(2 \times 60 \text{ s})} = 2083 \text{ W}$$

Then the average heat transfer coefficient is

$$\dot{Q} = hA_s(T_s - T_\infty) \longrightarrow h = \frac{\dot{Q}}{A_s(T_s - T_\infty)} = \frac{2083 \text{ W}}{(12 \text{ m}^2)(155 - 25)^\circ\text{C}} = 1.335 \text{ W/m}^2 \cdot ^\circ\text{C}$$

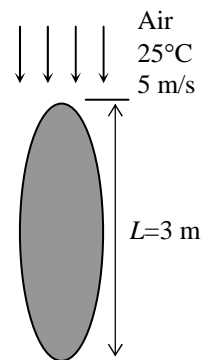

where the surface temperature of airfoil is taken as its average temperature, which is $(150+160)/2=155^\circ\text{C}$. The average friction coefficient of the airfoil is determined from the modified Reynolds analogy to be

$$C_f = \frac{2h\text{Pr}^{2/3}}{\rho V c_p} = \frac{2(1.335 \text{ W/m}^2 \cdot ^\circ\text{C})(0.7296)^{2/3}}{(1.184 \text{ kg/m}^3)(5 \text{ m/s})(1007 \text{ J/kg}\cdot^\circ\text{C})} = \mathbf{0.000363}$$

6-53 A metallic airfoil is subjected to air flow. The average friction coefficient is to be determined.

Assumptions 1 Steady operating conditions exist. 2 The edge effects are negligible.

Properties The properties of air at 25°C and 1 atm are (Table A-15)

$$\rho = 1.184 \text{ kg/m}^3, \quad c_p = 1.007 \text{ kJ/kg}\cdot\text{K}, \quad \text{Pr} = 0.7296$$

Analysis First, we determine the rate of heat transfer from

$$\dot{Q} = \frac{mc_{p,\text{airfoil}}(T_2 - T_1)}{\Delta t} = \frac{(50 \text{ kg})(500 \text{ J/kg}\cdot^\circ\text{C})(160 - 150)^\circ\text{C}}{(2 \times 60 \text{ s})} = 2083 \text{ W}$$

Then the average heat transfer coefficient is

$$\dot{Q} = hA_s(T_s - T_\infty) \longrightarrow h = \frac{\dot{Q}}{A_s(T_s - T_\infty)} = \frac{2083 \text{ W}}{(12 \text{ m}^2)(155 - 25)^\circ\text{C}} = 1.335 \text{ W/m}^2 \cdot ^\circ\text{C}$$

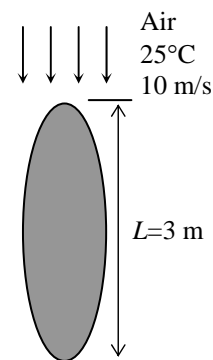

where the surface temperature of airfoil is taken as its average temperature, which is $(150+160)/2=155^\circ\text{C}$. The average friction coefficient of the airfoil is determined from the modified Reynolds analogy to be

$$C_f = \frac{2h\text{Pr}^{2/3}}{\rho V c_p} = \frac{2(1.335 \text{ W/m}^2 \cdot ^\circ\text{C})(0.7296)^{2/3}}{(1.184 \text{ kg/m}^3)(10 \text{ m/s})(1007 \text{ J/kg}\cdot^\circ\text{C})} = \mathbf{0.000181}$$

6-54 The windshield of a car is subjected to parallel winds. The drag force the wind exerts on the windshield is to be determined.

Assumptions 1 Steady operating conditions exist. 2 The edge effects are negligible.

Properties The properties of air at 0°C and 1 atm are (Table A-15)

$$\rho = 1.292 \text{ kg/m}^3, \quad c_p = 1.006 \text{ kJ/kg}\cdot\text{K}, \quad \text{Pr} = 0.7362$$

Analysis The average heat transfer coefficient is

$$\dot{Q} = hA_s(T_s - T_\infty)$$

$$h = \frac{\dot{Q}}{A_s(T_s - T_\infty)}$$

$$= \frac{50 \text{ W}}{(0.6 \times 1.8 \text{ m}^2)(4 - 0)^\circ\text{C}} = 11.57 \text{ W/m}^2 \cdot ^\circ\text{C}$$

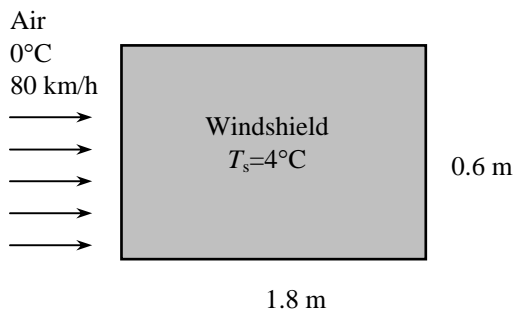

The average friction coefficient is determined from the modified Reynolds analogy to be

$$C_f = \frac{2h\text{Pr}^{2/3}}{\rho V c_p} = \frac{2(11.57 \text{ W/m}^2 \cdot ^\circ\text{C})(0.7362)^{2/3}}{(1.292 \text{ kg/m}^3)(80 / 3.6 \text{ m/s})(1006 \text{ J/kg}\cdot^\circ\text{C})} = 0.0006534$$

The drag force is determined from

$$F_f = C_f A_s \frac{\rho V^2}{2} = (0.0006534)(0.6 \times 1.8 \text{ m}^2) \frac{(1.292 \text{ kg/m}^3)(80 / 3.6 \text{ m/s})^2}{2} \left(\frac{1 \text{ N}}{1 \text{ kg}\cdot\text{m/s}^2} \right) = \mathbf{0.225 \text{ N}}$$

6-55 An airplane cruising is considered. The average heat transfer coefficient is to be determined.

Assumptions 1 Steady operating conditions exist. 2 The edge effects are negligible.

Properties The properties of air at -50°C and 1 atm are (Table A-15)

$$c_p = 0.999 \text{ kJ/kg}\cdot\text{K} \quad \text{Pr} = 0.7440$$

The density of air at -50°C and 26.5 kPa is

$$\rho = \frac{P}{RT} = \frac{26.5 \text{ kPa}}{(0.287 \text{ kJ/kg}\cdot\text{K})(-50 + 273)\text{K}} = 0.4141 \text{ kg/m}^3$$

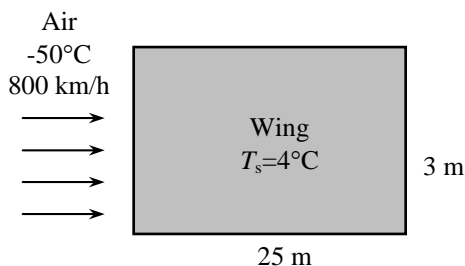

Analysis The average heat transfer coefficient can be determined from the modified Reynolds analogy to be

$$h = \frac{C_f}{2} \frac{\rho V c_p}{\text{Pr}^{2/3}} = \frac{0.0016}{2} \frac{(0.4141 \text{ kg/m}^3)(800 / 3.6 \text{ m/s})(999 \text{ J/kg}\cdot^\circ\text{C})}{(0.7440)^{2/3}} = \mathbf{89.6 \text{ W/m}^2 \cdot ^\circ\text{C}}$$

Special Topic: Microscale Heat Transfer

6-56 It is to be shown that the rate of heat transfer is inversely proportional to the size of an object.

Analysis Consider a cylinder of radius r and length l . The surface area of this cylinder is $A = 2\pi r(l + r)$

and its volume is $V = \pi r^2 l$. Therefore, the area per unit volume is $\frac{A}{V} = \frac{2(l+r)}{rl}$ which, for a long tube $l \ll r$,

becomes $\frac{A}{V} = \frac{2}{r}$. Similarly, it can be shown that the surface area to volume ratio is $\frac{3}{r}$ for a sphere of

radius r , and $\frac{6}{r}$ for a cube of side r .

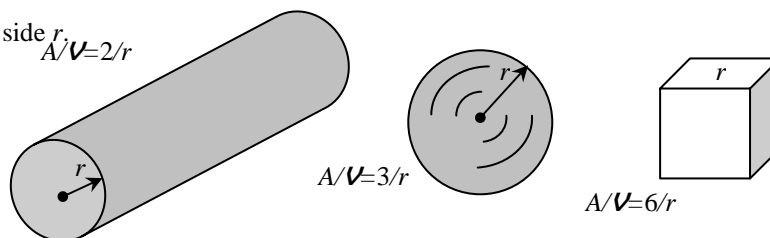

Note that as r becomes smaller, the surface to volume ratio increases. Specifically, this means that while the surface area is about the same order of that of the volume of macroscale (meter, centimeter scale) objects, but the surface becomes million or more times the volume as the size of the object goes to micrometer scale or below. Since, convective heat transfer is proportional to $A(T - T_\infty)$, heat flow increases as A increases.

6-57 For specified wall and fluid temperatures, the heat flux at the wall of a microchannel is to be determined.

Assumptions Steady operating conditions exist.

Properties The properties for both cases are given.

Analysis: (a) The gas and wall temperatures are $T_g = 100^\circ\text{C} = 373\text{ K}$, $T_w = 50^\circ\text{C} = 323\text{ K}$. Then,

$$T_g - T_w = \frac{2 - \sigma_T}{\sigma_T} \left(\frac{2\gamma}{\gamma + 1} \right) \left(\frac{\lambda}{\text{Pr}} \right) \left(\frac{\partial T}{\partial y} \right)_w = \left(\frac{2 - 1}{1} \right) \left(\frac{2 \times 1.667}{2.667} \right) (0.5) \left(\frac{\partial T}{\partial y} \right)_w$$

$$\left(\frac{\partial T}{\partial y} \right)_w = \frac{T_g - T_w}{0.625} = \frac{373 - 323}{0.625} = 80\text{ K/m}$$

Therefore, the wall heat flux is

$$-k \left(\frac{\partial T}{\partial y} \right)_w = (0.15\text{ W/m} \cdot \text{K})(80\text{ K/m}) = \mathbf{12\text{ W/m}^2}$$

(b) Repeating the same calculations for a different set of properties,

$$T_g - T_w = \frac{2 - \sigma_T}{\sigma_T} \left(\frac{2\gamma}{\gamma + 1} \right) \left(\frac{\lambda}{\text{Pr}} \right) \left(\frac{\partial T}{\partial y} \right)_w = \left(\frac{2 - 0.8}{0.8} \right) \left(\frac{2 \times 2}{2 + 1} \right) (5) \left(\frac{\partial T}{\partial y} \right)_w$$

$$\left(\frac{\partial T}{\partial y} \right)_w = \frac{T_g - T_w}{10} = \frac{373 - 323}{10} = 5\text{ K/m}$$

$$-k \left(\frac{\partial T}{\partial y} \right)_w = (0.1\text{ W/m} \cdot \text{K})(5\text{ K/m}) = \mathbf{0.5\text{ W/m}^2}$$

6-58 For a specified temperature gradient, the Nusselt numbers associated with ambient air and nitrogen gas are to be determined.

Assumptions Steady operating conditions exist.

Analysis: At the outer surface of the microchannel (assuming it to be infinitesimally thin), the heat transferred through the channel fluid (gas-wall interface) outward should balance the heat convected outside, and

$$h(T_a - T_w) = -k \left(\frac{\partial T}{\partial y} \right)_w$$

Therefore, the Nusselt number for cooling is

$$\text{Nu} = \frac{h}{k} L = \frac{-(\partial T / dy)_w}{(T_a - T_w)} L$$

The channel is $1.2 \mu\text{m}$ thick, i.e., $L = 1.2 \times 10^{-6} \text{ m}$.

(a) For an ambient air temperature of 30°C ,

$$\frac{h}{k} = \frac{-(\partial T / dy)_w}{(T_a - T_w)} = \frac{80 \text{ K/m}}{(50 - 30)\text{K}} = 4 \text{ m}^{-1}$$

Thus,

$$\text{Nu} = hL/k = (4 \text{ m}^{-1})(1.2 \times 10^{-6} \text{ m}) = \mathbf{4.8 \times 10^{-6}}$$

(b) For a nitrogen gas temperature of -100°C ,

$$\frac{h}{k} = \frac{-(\partial T / dy)_w}{(T_a - T_w)} = \frac{80 \text{ K/m}}{[50 - (-100)]\text{K}} = 0.533 \text{ m}^{-1}$$

Thus,

$$\text{Nu} = hL/k = (0.533 \text{ m}^{-1})(1.2 \times 10^{-6} \text{ m}) = \mathbf{6.4 \times 10^{-7}}$$

Review problems

6-59 The Couette flow of a fluid between two parallel plates is considered. The temperature distribution is to be sketched and determined, and the maximum temperature of the fluid, as well as the temperature of the fluid at the contact surfaces with the lower and upper plates are to be determined.

Assumptions Steady operating conditions exist.

Properties The viscosity and thermal conductivity of the fluid are given to be $\mu = 0.8 \text{ N}\cdot\text{s}/\text{m}^2$ and $k_f = 0.145 \text{ W}/\text{m}\cdot\text{K}$. The thermal conductivity of lower plate is given to be $k_p = 1.5 \text{ W}/\text{m}\cdot\text{K}$.

Analysis: (a)

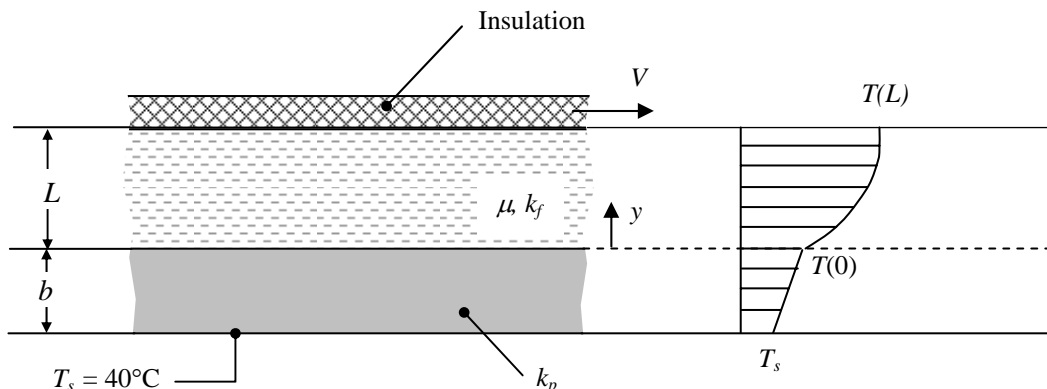

The sketch of temperature distribution is given in the figure. We observe from this figure that there are different slopes at the interface ($y = 0$) because of different conductivities ($k_p > k_f$). The slope is zero at the upper plate ($y = L$) because of adiabatic condition.

(b) The general solution of the relevant differential equation is obtained as follows:

$$u = \frac{y}{L}V \longrightarrow \frac{du}{dy} = \frac{V}{L}$$

$$\frac{d^2T}{dy^2} = \frac{-\mu V^2}{k_f L^2} \longrightarrow \frac{dT}{dy} = \frac{-\mu V^2}{k_f L^2} y + C_1$$

$$T = \frac{-\mu V^2}{2k_f L^2} y^2 + C_1 y + C_2$$

Applying the boundary conditions:

$$y = 0 \quad \dot{q}_f = \dot{q}_p \longrightarrow -k_f \left. \frac{dT}{dy} \right|_0 = \frac{T(0) - T_s}{b/k_p}$$

$$k_f C_1 = \frac{k_p}{b} (C_2 - T_s) \quad (1)$$

$$y = L, \text{ adiabatic} \quad \left. \frac{dT}{dy} \right|_L = 0 \longrightarrow C_1 = \frac{\mu V^2}{k_f L}$$

$$\text{From Eq. (1),} \quad C_2 = b \frac{k_f}{k_p} C_1 + T_s = b \frac{\mu V^2}{k_p L} + T_s$$

Substituting the coefficients, the temperature distribution becomes

$$T(y) = \frac{-\mu}{2k_f} \frac{V^2}{L^2} y^2 + \frac{\mu}{k_f} \frac{V^2}{L} y + \frac{\mu}{k_p} \frac{V^2}{L} b + T_s$$

(c) Then the temperatures at the contact surfaces are determined to be

$$T(0) = 0 + 0 + \frac{0.8}{1.5} \frac{5^2}{0.005} 0.003 + 40 = \mathbf{48^\circ\text{C}}$$

$$T(y) = \frac{-0.8}{2(0.145)} \frac{5^2}{0.005^2} 0.005^2 + \frac{0.8}{0.145} \frac{5^2}{0.005} 0.005 + \frac{0.8}{1.5} \frac{5^2}{0.005} 0.003 + 40 = \mathbf{117^\circ\text{C}}$$

The maximum temperature is $T_{\max} = T(L) = 117^\circ\text{C}$ because of the adiabatic condition at $y = L$.

6-60 The hydrodynamic boundary layer and the thermal boundary layer both as a function of x are to be plotted for the flow of engine oil over a plate.

Analysis The problem is solved using Excel, and the solution is given below.

Assumptions

1. The flow is steady and incompressible
2. The critical Reynolds number is 500,000
3. Air is an ideal gas
4. The plate is smooth
5. Edge effects are negligible and the upper surface of the plate is considered

Input Properties

The average film temperature is 40°C (Property data from Table A-13)

$$\begin{aligned}\rho &= 876 \text{ kg/m}^3 \\ c_p &= 1964 \text{ J/kg}\cdot^\circ\text{C} \\ \mu &= 0.2177 \text{ kg/m}\cdot\text{s} \\ k &= 0.1444 \text{ W/m}\cdot^\circ\text{C} \\ \text{Pr} &= 2962\end{aligned}$$

Input Parameters

$$\begin{aligned}W &= 0.3 \text{ m} \\ T_{f,\text{avg}} &= 40^\circ\text{C} \\ V &= 3 \text{ m/s} \\ T_{\text{fluid}} &= 15^\circ\text{C} \\ T_s &= 65^\circ\text{C}\end{aligned}$$

Analysis

$$\text{The critical length: } \text{Re} = \frac{Vx_{cr}}{\nu} \longrightarrow x_{cr} = \frac{\text{Re} \nu}{V} = \frac{\text{Re} \mu}{V\rho} = \frac{(500,000)(0.2177 \text{ kg/m}\cdot\text{s})}{(3 \text{ m/s})(876 \text{ kg/m}^3)} = 41.42 \text{ m}$$

$$\text{Hydrodynamic boundary layer thickness: } \delta = \frac{4.91x}{\sqrt{\text{Re}_x}}$$

$$\text{Thermal boundary layer thickness: } \delta_t = \frac{4.91x}{\text{Pr}^{1/3} \sqrt{\text{Re}_x}}$$

x (m)	Re _x	δ	δ _t
0.000	0.000	0	0
1.000	12072	0.0455	0.0032
2.000	24143	0.0644	0.0045
3.000	36215	0.0788	0.0055
4.000	48287	0.0910	0.0063
5.000	60358	0.1018	0.0071
6.000	72430	0.1115	0.0078
7.000	84502	0.1204	0.0084
8.000	96573	0.1287	0.0090
9.000	108645	0.1365	0.0095
10.000	120717	0.1439	0.0100
11.000	132788	0.1509	0.0105
12.000	144860	0.1576	0.0110
13.000	156932	0.1641	0.0114
14.000	169003	0.1703	0.0119
15.000	181075	0.1763	0.0123
16.000	193147	0.1820	0.0127
17.000	205218	0.1876	0.0131

18.000	217290	0.1931	0.0134
19.000	229362	0.1984	0.0138
20.000	241433	0.2035	0.0142
21.000	253505	0.2085	0.0145
22.000	265576	0.2135	0.0149
23.000	277648	0.2182	0.0152
24.000	289720	0.2229	0.0155
25.000	301791	0.2275	0.0158
26.000	313863	0.2320	0.0162
27.000	325935	0.2365	0.0165
28.000	338006	0.2408	0.0168
29.000	350078	0.2451	0.0171
30.000	362150	0.2493	0.0174
31.000	374221	0.2534	0.0176
32.000	386293	0.2574	0.0179
33.000	398365	0.2614	0.0182
34.000	410436	0.2654	0.0185
35.000	422508	0.2692	0.0187
36.000	434580	0.2730	0.0190
37.000	446651	0.2768	0.0193
38.000	458723	0.2805	0.0195
39.000	470795	0.2842	0.0198
40.000	482866	0.2878	0.0200
41.000	494938	0.2914	0.0203
41.210	497473	0.2921	0.0203
41.420	500008	0.2929	0.0204

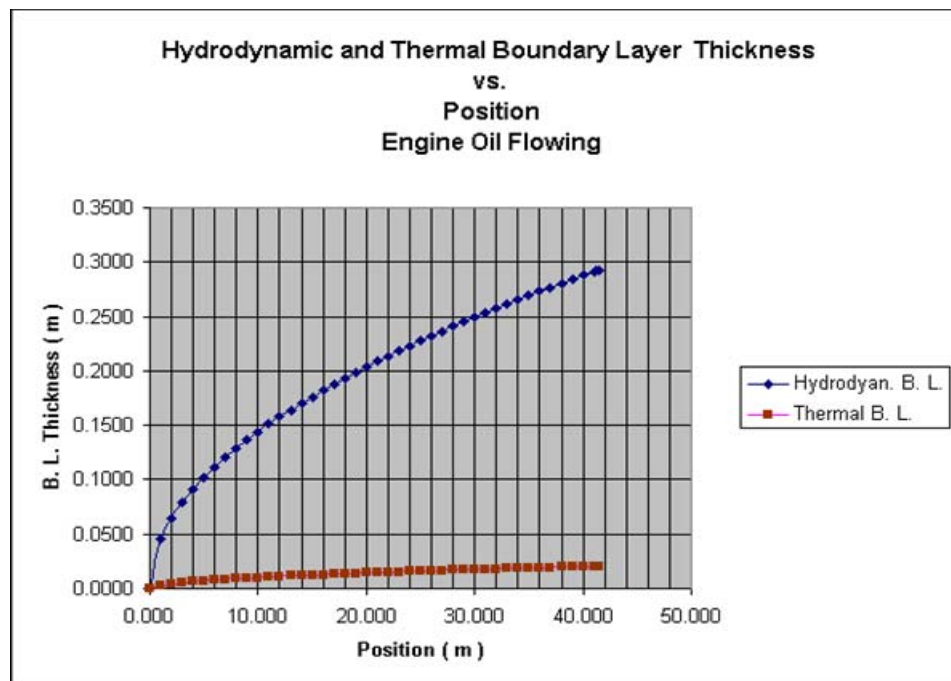

Fundamentals of Engineering (FE) Exam Problems

6-61 The _____ number is a significant dimensionless parameter for forced convection and the _____ number is a significant dimensionless parameter for natural convection.

- (a) Reynolds, Grashof (b) Reynolds, Mach (c) Reynolds, Eckert
 (d) Reynolds, Schmidt (e) Grashof, Sherwood

Answer (a)

6-62 For the same initial conditions, one can expect the laminar thermal and momentum boundary layers on a flat plate to have the same thickness when the Prandtl number of the flowing fluid is

- (a) Close to zero (b) Small (c) Approximately one
 (d) Large (e) Very large

Answer (c)

6-63 One can expect the heat transfer coefficient for turbulent flow to be _____ for laminar flow

- (a) less than (b) same as (c) greater than

Answer (c)

6-64 Most correlations for the convection heat transfer coefficient use the dimensionless Nusselt number, which is defined as

- (a) h/k (b) k/h (c) hL_c/k (d) kL_c/h (e) $k/\rho c_p$

Answer (c)

6-65 In any forced or natural convection situation, the velocity of the flowing fluid is zero where the fluid wets any stationary surface. The magnitude of heat flux where the fluid wets a stationary surface is given by

- (a) $k(T_{\text{fluid}} - T_{\text{wall}})$ (b) $k \left. \frac{dT}{dy} \right|_{\text{wall}}$ (c) $k \left. \frac{d^2T}{dy^2} \right|_{\text{wall}}$ (d) $h \left. \frac{dT}{dy} \right|_{\text{wall}}$ (e) None of them

Answer (b)

6-66 In turbulent flow, one can estimate the Nusselt number using the analogy between heat and momentum transfer (Colburn analogy). This analogy relates the Nusselt number to the coefficient of friction, C_f , as

- (a) $\text{Nu} = 0.5 C_f \text{Re} \text{Pr}^{1/3}$ (b) $\text{Nu} = 0.5 C_f \text{Re} \text{Pr}^{2/3}$ (c) $\text{Nu} = C_f \text{Re} \text{Pr}^{1/3}$
 (d) $\text{Nu} = C_f \text{Re} \text{Pr}^{2/3}$ (e) $\text{Nu} = C_f \text{Re}^{1/2} \text{Pr}^{1/3}$

Answer (a)

6-67 An electrical water ($k = 0.61 \text{ W/m}\cdot\text{K}$) heater uses natural convection to transfer heat from a 1-cm diameter by 0.65-m long, 110 V electrical resistance heater to the water. During operation, the surface temperature of this heater is 120°C while the temperature of the water is 35°C , and the Nusselt number (based on the diameter) is 5. Considering only the side surface of the heater (and thus $A = \pi DL$), the current passing through the electrical heating element is

- (a) 2.2 A (b) 2.7 A (c) 3.6 A (d) 4.8 A (e) 5.6 A

Answer (d) 4.8 A

Solution Solved by EES Software. Solutions can be verified by copying-and-pasting the following lines on a blank EES screen.

```
k=0.61 [W/m-K]
d=0.01 [m]
L=0.65 [m]
Nus=5
DT=85 [K]
DV=110 [Volt]
h=Nus*k/d
Q=h*pi*d*L*DT
I=Q/DV
```

6-68 The coefficient of friction C_f for a fluid flowing across a surface in terms of the surface shear stress, τ_s , is given by

- (a) $2\rho V^2 / \tau_s$ (b) $2\tau_s / \rho V^2$ (c) $2\tau_s / \rho V^2 \Delta T$ (d) $4\tau_s / \rho V^2$ (e) None of them

Answer (b)

6-69 The transition from laminar flow to turbulent flow in a forced convection situation is determined by which one of the following dimensionless numbers?

- (a) Grasshof (b) Nusselt (c) Reynolds (d) Stanton (e) Mach

Answer (c)

6-70, 6-71 Design and Essay Problems



Chapter 7

EXTERNAL FORCED CONVECTION

Drag Force and Heat Transfer in External Flow

7-1C The velocity of the fluid relative to the immersed solid body sufficiently far away from a body is called the *free-stream velocity*, V_∞ . The *upstream* (or *approach*) *velocity* V is the velocity of the approaching fluid far ahead of the body. These two velocities are equal if the flow is uniform and the body is small relative to the scale of the free-stream flow.

7-2C A body is said to be *streamlined* if a conscious effort is made to align its shape with the anticipated streamlines in the flow. Otherwise, a body tends to block the flow, and is said to be *blunt*. A tennis ball is a blunt body (unless the velocity is very low and we have “creeping flow”).

7-3C The force a flowing fluid exerts on a body in the flow direction is called *drag*. Drag is caused by friction between the fluid and the solid surface, and the pressure difference between the front and back of the body. We try to minimize drag in order to reduce fuel consumption in vehicles, improve safety and durability of structures subjected to high winds, and to reduce noise and vibration.

7-4C The force a flowing fluid exerts on a body in the normal direction to flow that tend to move the body in that direction is called *lift*. It is caused by the components of the pressure and wall shear forces in the normal direction to flow. The wall shear also contributes to lift (unless the body is very slim), but its contribution is usually small.

7-5C When the drag force F_D , the upstream velocity V , and the fluid density ρ are measured during flow over a body, the drag coefficient can be determined from

$$C_D = \frac{F_D}{\frac{1}{2} \rho V^2 A}$$

where A is ordinarily the *frontal area* (the area projected on a plane normal to the direction of flow) of the body.

7-6C The *frontal area* of a body is the area seen by a person when looking from upstream. The frontal area is appropriate to use in drag and lift calculations for blunt bodies such as cars, cylinders, and spheres.

7-7C The part of drag that is due directly to wall shear stress τ_w is called the *skin friction drag* $F_{D, \text{friction}}$ since it is caused by frictional effects, and the part that is due directly to pressure P and depends strongly on the shape of the body is called the *pressure drag* $F_{D, \text{pressure}}$. For slender bodies such as airfoils, the friction drag is usually more significant.

7-8C The friction drag coefficient is independent of surface roughness in *laminar flow*, but is a strong function of surface roughness in *turbulent flow* due to surface roughness elements protruding further into the highly viscous laminar sublayer.

7-9C As a result of streamlining, (a) friction drag increases, (b) pressure drag decreases, and (c) total drag decreases at high Reynolds numbers (the general case), but increases at very low Reynolds numbers since the friction drag dominates at low Reynolds numbers.

7-10C At sufficiently high velocities, the fluid stream detaches itself from the surface of the body. This is called *separation*. It is caused by a fluid flowing over a curved surface at a high velocity (or technically, by adverse pressure gradient). Separation increases the drag coefficient drastically.

Flow over Flat Plates

7-11C The friction coefficient represents the resistance to fluid flow over a flat plate. It is proportional to the drag force acting on the plate. The drag coefficient for a flat surface is equivalent to the mean friction coefficient.

7-12C The friction and the heat transfer coefficients change with position in laminar flow over a flat plate.

7-13C The average friction and heat transfer coefficients in flow over a flat plate are determined by integrating the local friction and heat transfer coefficients over the entire plate, and then dividing them by the length of the plate.

7-14 Hot engine oil flows over a flat plate. The total drag force and the rate of heat transfer per unit width of the plate are to be determined.

Assumptions 1 Steady operating conditions exist. 2 The critical Reynolds number is $Re_{cr} = 5 \times 10^5$. 3 Radiation effects are negligible.

Properties The properties of engine oil at the film temperature of $(T_s + T_\infty)/2 = (80 + 30)/2 = 55^\circ\text{C}$ are (Table A-13)

$$\rho = 867 \text{ kg/m}^3 \quad \nu = 7.045 \times 10^{-5} \text{ m}^2/\text{s}$$

$$k = 0.1414 \text{ W/m}\cdot^\circ\text{C} \quad Pr = 1551$$

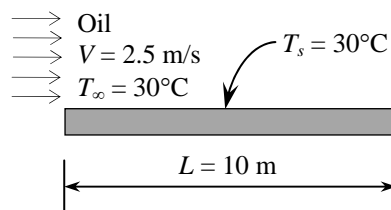

Analysis Noting that $L = 10 \text{ m}$, the Reynolds number at the end of the plate is

$$Re_L = \frac{VL}{\nu} = \frac{(2.5 \text{ m/s})(10 \text{ m})}{7.045 \times 10^{-5} \text{ m}^2/\text{s}} = 3.549 \times 10^5$$

which is less than the critical Reynolds number. Thus we have laminar flow over the entire plate. The average friction coefficient and the drag force per unit width are determined from

$$C_f = 1.33 Re_L^{-0.5} = 1.33(3.549 \times 10^5)^{-0.5} = 0.002233$$

$$F_D = C_f A_s \frac{\rho V^2}{2} = (0.002233)(10 \times 1 \text{ m}^2) \frac{(867 \text{ kg/m}^3)(2.5 \text{ m/s})^2}{2} = \mathbf{60.5 \text{ N}}$$

Similarly, the average Nusselt number and the heat transfer coefficient are determined using the laminar flow relations for a flat plate,

$$Nu = \frac{hL}{k} = 0.664 Re_L^{0.5} Pr^{1/3} = 0.664(3.549 \times 10^5)^{0.5} (1551)^{1/3} = 4579$$

$$h = \frac{k}{L} Nu = \frac{0.1414 \text{ W/m}\cdot^\circ\text{C}}{10 \text{ m}} (4579) = 64.75 \text{ W/m}^2\cdot^\circ\text{C}$$

The rate of heat transfer is then determined from Newton's law of cooling to be

$$\dot{Q} = hA_s(T_\infty - T_s) = (64.75 \text{ W/m}^2\cdot^\circ\text{C})(10 \times 1 \text{ m}^2)(80 - 30)^\circ\text{C} = 3.24 \times 10^4 \text{ W} = \mathbf{32.4 \text{ kW}}$$

7-15 The top surface of a hot block is to be cooled by forced air. The rate of heat transfer is to be determined for two cases.

Assumptions 1 Steady operating conditions exist. 2 The critical Reynolds number is $Re_{cr} = 5 \times 10^5$. 3 Radiation effects are negligible. 4 Air is an ideal gas with constant properties.

Properties The atmospheric pressure in atm is

$$P = (83.4 \text{ kPa}) \frac{1 \text{ atm}}{101.325 \text{ kPa}} = 0.823 \text{ atm}$$

For an ideal gas, the thermal conductivity and the Prandtl number are independent of pressure, but the kinematic viscosity is inversely proportional to the pressure. With these considerations, the properties of air at 0.823 atm and at the film temperature of $(120+30)/2=75^\circ\text{C}$ are (Table A-15)

$$k = 0.02917 \text{ W/m}\cdot^\circ\text{C}$$

$$\nu = \nu_{@1\text{atm}} / P_{\text{atm}} = (2.046 \times 10^{-5} \text{ m}^2/\text{s}) / 0.823 = 2.486 \times 10^{-5} \text{ m}^2/\text{s}$$

$$Pr = 0.7166$$

Analysis (a) If the air flows parallel to the 8 m side, the Reynolds number in this case becomes

$$Re_L = \frac{VL}{\nu} = \frac{(6 \text{ m/s})(8 \text{ m})}{2.486 \times 10^{-5} \text{ m}^2/\text{s}} = 1.931 \times 10^6$$

which is greater than the critical Reynolds number. Thus we have combined laminar and turbulent flow. Using the proper relation for Nusselt number, the average heat transfer coefficient and the heat transfer rate are determined to be

$$Nu = \frac{hL}{k} = (0.037 Re_L^{0.8} - 871) Pr^{1/3} = [0.037(1.931 \times 10^6)^{0.8} - 871](0.7166)^{1/3} = 2757$$

$$h = \frac{k}{L} Nu = \frac{0.02917 \text{ W/m}\cdot^\circ\text{C}}{8 \text{ m}} (2757) = 10.05 \text{ W/m}^2\cdot^\circ\text{C}$$

$$A_s = wL = (2.5 \text{ m})(8 \text{ m}) = 20 \text{ m}^2$$

$$\dot{Q} = hA_s(T_\infty - T_s) = (10.05 \text{ W/m}^2\cdot^\circ\text{C})(20 \text{ m}^2)(120 - 30)^\circ\text{C} = 18,100 \text{ W} = \mathbf{18.10 \text{ kW}}$$

(b) If the air flows parallel to the 2.5 m side, the Reynolds number is

$$Re_L = \frac{VL}{\nu} = \frac{(6 \text{ m/s})(2.5 \text{ m})}{2.486 \times 10^{-5} \text{ m}^2/\text{s}} = 6.034 \times 10^5$$

which is greater than the critical Reynolds number. Thus we have combined laminar and turbulent flow. Using the proper relation for Nusselt number, the average heat transfer coefficient and the heat transfer rate are determined to be

$$Nu = \frac{hL}{k} = (0.037 Re_L^{0.8} - 871) Pr^{1/3} = [0.037(6.034 \times 10^5)^{0.8} - 871](0.7166)^{1/3} = 615.1$$

$$h = \frac{k}{L} Nu = \frac{0.02917 \text{ W/m}\cdot^\circ\text{C}}{2.5 \text{ m}} (615.1) = 7.177 \text{ W/m}^2\cdot^\circ\text{C}$$

$$\dot{Q} = hA_s(T_\infty - T_s) = (7.177 \text{ W/m}^2\cdot^\circ\text{C})(20 \text{ m}^2)(120 - 30)^\circ\text{C} = 12,920 \text{ W} = \mathbf{12.92 \text{ kW}}$$

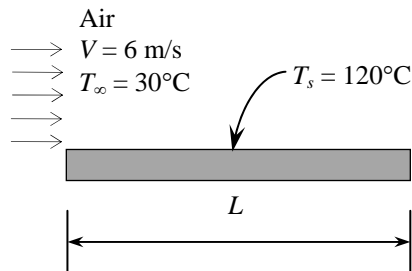

7-16 Wind is blowing parallel to the wall of a house. The rate of heat loss from that wall is to be determined for two cases.

Assumptions 1 Steady operating conditions exist. 2 The critical Reynolds number is $Re_{cr} = 5 \times 10^5$. 3 Radiation effects are negligible. 4 Air is an ideal gas with constant properties.

Properties The properties of air at 1 atm and the film temperature of $(T_s + T_\infty)/2 = (12+5)/2 = 8.5^\circ\text{C}$ are (Table A-15)

$$k = 0.02428 \text{ W/m} \cdot ^\circ\text{C}$$

$$\nu = 1.413 \times 10^{-5} \text{ m}^2/\text{s}$$

$$Pr = 0.7340$$

Air
 $V = 55 \text{ km/h}$
 $T_\infty = 5^\circ\text{C}$

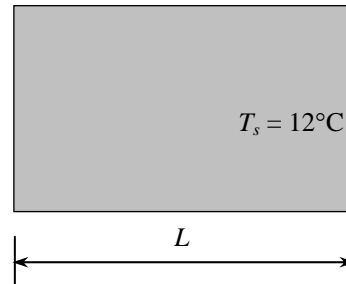

Analysis Air flows parallel to the 10 m side:

The Reynolds number in this case is

$$Re_L = \frac{VL}{\nu} = \frac{[(55 \times 1000 / 3600) \text{ m/s}](10 \text{ m})}{1.413 \times 10^{-5} \text{ m}^2/\text{s}} = 1.081 \times 10^7$$

which is greater than the critical Reynolds number. Thus we have combined laminar and turbulent flow. Using the proper relation for Nusselt number, heat transfer coefficient and then heat transfer rate are determined to be

$$Nu = \frac{hL}{k} = (0.037 Re_L^{0.8} - 871) Pr^{1/3} = [0.037(1.081 \times 10^7)^{0.8} - 871](0.7340)^{1/3} = 1.336 \times 10^4$$

$$h = \frac{k}{L} Nu = \frac{0.02428 \text{ W/m} \cdot ^\circ\text{C}}{10 \text{ m}} (1.336 \times 10^4) = 32.43 \text{ W/m}^2 \cdot ^\circ\text{C}$$

$$A_s = wL = (4 \text{ m})(10 \text{ m}) = 40 \text{ m}^2$$

$$\dot{Q} = hA_s(T_\infty - T_s) = (32.43 \text{ W/m}^2 \cdot ^\circ\text{C})(40 \text{ m}^2)(12 - 5)^\circ\text{C} = 9080 \text{ W} = \mathbf{9.08 \text{ kW}}$$

If the wind velocity is doubled:

$$Re_L = \frac{VL}{\nu} = \frac{[(110 \times 1000 / 3600) \text{ m/s}](10 \text{ m})}{1.413 \times 10^{-5} \text{ m}^2/\text{s}} = 2.162 \times 10^7$$

which is greater than the critical Reynolds number. Thus we have combined laminar and turbulent flow. Using the proper relation for Nusselt number, the average heat transfer coefficient and the heat transfer rate are determined to be

$$Nu = \frac{hL}{k} = (0.037 Re_L^{0.8} - 871) Pr^{1/3} = [0.037(2.162 \times 10^7)^{0.8} - 871](0.7340)^{1/3} = 2.384 \times 10^4$$

$$h = \frac{k}{L} Nu = \frac{0.02428 \text{ W/m} \cdot ^\circ\text{C}}{10 \text{ m}} (2.384 \times 10^4) = 57.88 \text{ W/m}^2 \cdot ^\circ\text{C}$$

$$\dot{Q} = hA_s(T_\infty - T_s) = (57.88 \text{ W/m}^2 \cdot ^\circ\text{C})(40 \text{ m}^2)(12 - 5)^\circ\text{C} = 16,210 \text{ W} = \mathbf{16.21 \text{ kW}}$$

7-17 EES Prob. 7-16 is reconsidered. The effects of wind velocity and outside air temperature on the rate of heat loss from the wall by convection are to be investigated.

Analysis The problem is solved using EES, and the solution is given below.

"GIVEN"

Vel=55 [km/h]
 height=4 [m]
 L=10 [m]
 T_infinity=5 [C]
 T_s=12 [C]

"PROPERTIES"

Fluid\$='air'
 k=Conductivity(Fluid\$, T=T_film)
 Pr=Prandtl(Fluid\$, T=T_film)
 rho=Density(Fluid\$, T=T_film, P=101.3)
 mu=Viscosity(Fluid\$, T=T_film)
 nu=mu/rho
 T_film=1/2*(T_s+T_infinity)

"ANALYSIS"

Re=(Vel*Convert(km/h, m/s)*L)/nu
 "We use combined laminar and turbulent flow relation for Nusselt number"
 Nusselt=(0.037*Re^0.8-871)*Pr^(1/3)
 h=k/L*Nusselt
 A=height*L
 Q_dot_conv=h*A*(T_s-T_infinity)

Vel [km/h]	Q _{conv} [W]
10	1924
15	2866
20	3746
25	4583
30	5386
35	6163
40	6918
45	7655
50	8375
55	9081
60	9774
65	10455
70	11126
75	11788
80	12441

T _∞ [C]	Q _{conv} [W]
0	15658
0.5	14997
1	14336
1.5	13677
2	13018

2.5	12360
3	11702
3.5	11046
4	10390
4.5	9735
5	9081
5.5	8427
6	7774
6.5	7122
7	6471
7.5	5821
8	5171
8.5	4522
9	3874
9.5	3226
10	2579

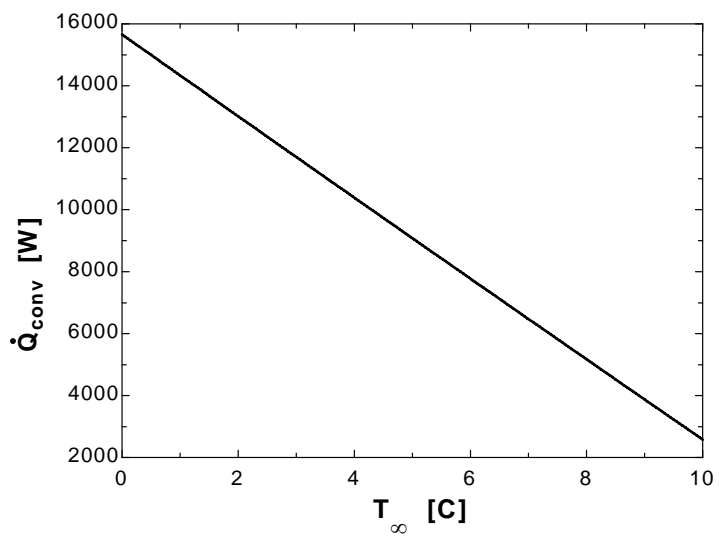
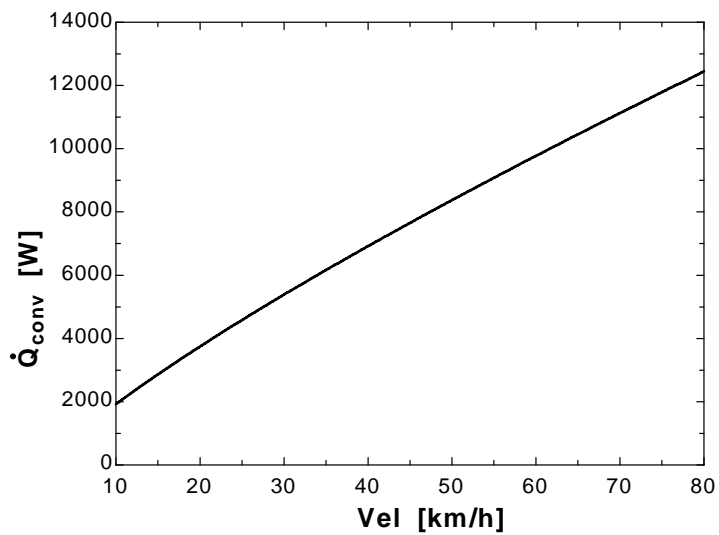

7-18E Air flows over a flat plate. The local friction and heat transfer coefficients at intervals of 1 ft are to be determined and plotted against the distance from the leading edge.

Assumptions 1 Steady operating conditions exist. 2 The critical Reynolds number is $Re_{cr} = 5 \times 10^5$. 3 Radiation effects are negligible. 4 Air is an ideal gas with constant properties.

Properties The properties of air at 1 atm and 60°F are (Table A-15E)

$$k = 0.01433 \text{ Btu/h.ft.}^\circ\text{F}$$

$$\nu = 0.1588 \times 10^{-3} \text{ ft}^2/\text{s}$$

$$Pr = 0.7321$$

Analysis For the first 1 ft interval, the Reynolds number is

$$Re_L = \frac{VL}{\nu} = \frac{(7 \text{ ft/s})(1 \text{ ft})}{0.1588 \times 10^{-3} \text{ ft}^2/\text{s}} = 4.408 \times 10^4$$

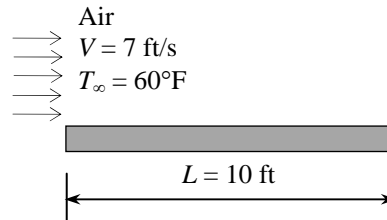

which is less than the critical value of 5×10^5 . Therefore, the flow is laminar. The local Nusselt number is

$$Nu_x = \frac{hx}{k} = 0.332 Re_x^{0.5} Pr^{1/3} = 0.332(4.408 \times 10^4)^{0.5} (0.7321)^{1/3} = 62.82$$

The local heat transfer and friction coefficients are

$$h_x = \frac{k}{x} Nu_x = \frac{0.01433 \text{ Btu/h.ft.}^\circ\text{F}}{1 \text{ ft}} (62.82) = 0.9002 \text{ Btu/h.ft}^2 \cdot ^\circ\text{F}$$

$$C_{f,x} = \frac{0.664}{Re^{0.5}} = \frac{0.664}{(4.408 \times 10^4)^{0.5}} = 0.00316$$

We repeat calculations for all 1-ft intervals. The results are

x [ft]	h_x [Btu/h.ft ² ·F]	$C_{f,x}$
1	0.9005	0.003162
2	0.6367	0.002236
3	0.5199	0.001826
4	0.4502	0.001581
5	0.4027	0.001414
6	0.3676	0.001291
7	0.3404	0.001195
8	0.3184	0.001118
9	0.3002	0.001054
10	0.2848	0.001

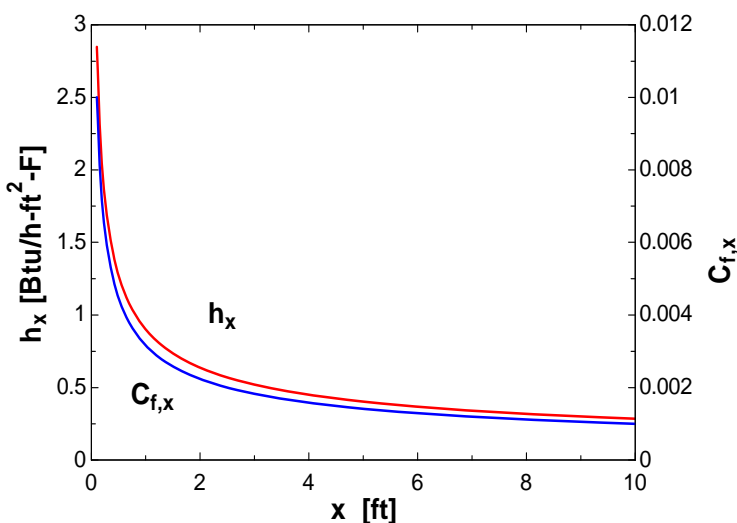

7-19E EES Prob. 7-18E is reconsidered. The local friction and heat transfer coefficients along the plate are to be plotted against the distance from the leading edge.

Analysis The problem is solved using EES, and the solution is given below.

"GIVEN"

T_{air}=60 [F]
x=10 [ft]
Vel=7 [ft/s]

"PROPERTIES"

Fluid\$='air'
k=Conductivity(Fluid\$, T=T_{air})
Pr=Prandtl(Fluid\$, T=T_{air})
rho=Density(Fluid\$, T=T_{air}, P=14.7)
mu=Viscosity(Fluid\$, T=T_{air})*Convert(lbm/ft-h, lbm/ft-s)
nu=mu/rho

"ANALYSIS"

Re_x=(Vel*x)/nu

"Reynolds number is calculated to be smaller than the critical Re number. The flow is laminar."

Nusselt_x=0.332*Re_x^{0.5}*Pr^(1/3)

h_x=k/x*Nusselt_x

C_{f,x}=0.664/Re_x^{0.5}

x [ft]	h _x [Btu/h.ft ² .F]	C _{f,x}
0.1	2.848	0.01
0.2	2.014	0.007071
0.3	1.644	0.005774
0.4	1.424	0.005
0.5	1.273	0.004472
0.6	1.163	0.004083
0.7	1.076	0.00378
0.8	1.007	0.003536
0.9	0.9492	0.003333
1	0.9005	0.003162
...
...
9.1	0.2985	0.001048
9.2	0.2969	0.001043
9.3	0.2953	0.001037
9.4	0.2937	0.001031
9.5	0.2922	0.001026
9.6	0.2906	0.001021
9.7	0.2891	0.001015
9.8	0.2877	0.00101
9.9	0.2862	0.001005
10	0.2848	0.001

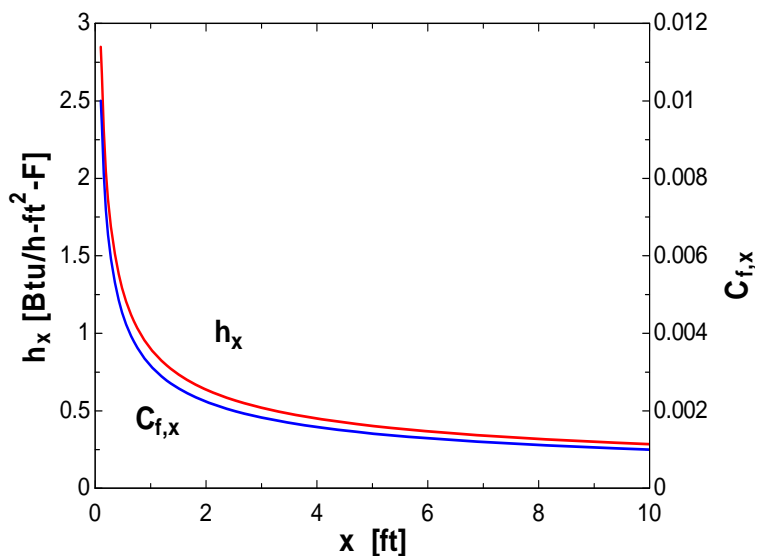

7-20 Air flows over the top and bottom surfaces of a thin, square plate. The flow regime and the total heat transfer rate are to be determined and the average gradients of the velocity and temperature at the surface are to be estimated.

Assumptions 1 Steady operating conditions exist. 2 The critical Reynolds number is $Re_{cr} = 5 \times 10^5$. 3 Radiation effects are negligible.

Properties The properties of air at the film temperature of $(T_s + T_\infty)/2 = (54 + 10)/2 = 32^\circ\text{C}$ are (Table A-15)

$$\begin{aligned}\rho &= 1.156 \text{ kg/m}^3 & \nu &= 1.627 \times 10^{-5} \text{ m}^2/\text{s} \\ c_p &= 1007 \text{ J/kg}\cdot^\circ\text{C} & \text{Pr} &= 0.7276 \\ k &= 0.02603 \text{ W/m}\cdot^\circ\text{C}\end{aligned}$$

Analysis (a) The Reynolds number is

$$Re_L = \frac{VL}{\nu} = \frac{(60 \text{ m/s})(0.5 \text{ m})}{1.627 \times 10^{-5} \text{ m}^2/\text{s}} = 1.844 \times 10^6$$

which is greater than the critical Reynolds number. Thus we have turbulent flow at the end of the plate.

(b) We use modified Reynolds analogy to determine the heat transfer coefficient and the rate of heat transfer

$$\tau_s = \frac{F}{A} = \frac{1.5 \text{ N}}{2(0.5 \text{ m})^2} = 3 \text{ N/m}^2$$

$$C_f = \frac{\tau_s}{0.5\rho V^2} = \frac{3 \text{ N/m}^2}{0.5(1.156 \text{ kg/m}^3)(60 \text{ m/s})^2} = 1.442 \times 10^{-3}$$

$$\frac{C_f}{2} = \text{St Pr}^{2/3} = \frac{\text{Nu}_L}{\text{Re}_L \text{Pr}} \text{Pr}^{2/3} = \frac{\text{Nu}_L}{\text{Re}_L \text{Pr}^{1/3}}$$

$$\text{Nu} = \text{Re}_L \text{Pr}^{1/3} \frac{C_f}{2} = (1.844 \times 10^6)(0.7276)^{1/3} \frac{(1.442 \times 10^{-3})}{2} = 1196$$

$$h = \frac{k}{L} \text{Nu} = \frac{0.02603 \text{ W/m}\cdot^\circ\text{C}}{0.5 \text{ m}} (1196) = 62.26 \text{ W/m}^2\cdot^\circ\text{C}$$

$$\dot{Q} = hA_s(T_s - T_\infty) = (62.26 \text{ W/m}^2\cdot^\circ\text{C})[2 \times (0.5 \text{ m})^2](54 - 10)^\circ\text{C} = \mathbf{1370 \text{ W}}$$

(c) Assuming a uniform distribution of heat transfer and drag parameters over the plate, the average gradients of the velocity and temperature at the surface are determined to be

$$\tau_s = \mu \left. \frac{\partial u}{\partial y} \right|_0 \longrightarrow \left. \frac{\partial u}{\partial y} \right|_0 = \frac{\tau_s}{\rho\nu} = \frac{3 \text{ N/m}^2}{(1.156 \text{ kg/m}^3)(1.627 \times 10^{-5} \text{ m}^2/\text{s})} = \mathbf{1.60 \times 10^5 \text{ s}^{-1}}$$

$$h = \frac{-k \left. \frac{\partial T}{\partial y} \right|_0}{T_s - T_\infty} \longrightarrow \left. \frac{\partial T}{\partial y} \right|_0 = \frac{-h(T_s - T_\infty)}{k} = \frac{(62.26 \text{ W/m}^2\cdot^\circ\text{C})(54 - 10)^\circ\text{C}}{0.02603 \text{ W/m}\cdot^\circ\text{C}} = \mathbf{1.05 \times 10^5 \text{ }^\circ\text{C/m}}$$

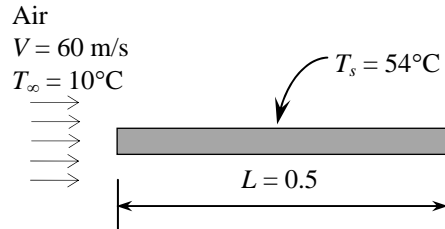

7-21 Water flows over a large plate. The rate of heat transfer per unit width of the plate is to be determined.

Assumptions **1** Steady operating conditions exist. **2** The critical Reynolds number is $Re_{cr} = 5 \times 10^5$. **3** Radiation effects are negligible.

Properties The properties of water at the film temperature of $(T_s + T_\infty)/2 = (10 + 43.3)/2 = 27^\circ\text{C}$ are (Table A-9)

$$\rho = 996.6 \text{ kg/m}^3$$

$$k = 0.610 \text{ W/m}\cdot^\circ\text{C}$$

$$\mu = 0.854 \times 10^{-3} \text{ kg/m}\cdot\text{s}$$

$$Pr = 5.85$$

Water \longrightarrow

$V = 30 \text{ cm/s}$ \longrightarrow

$T_\infty = 43.3^\circ\text{C}$ \longrightarrow

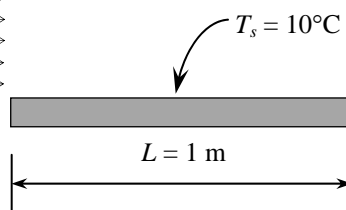

Analysis (a) The Reynolds number is

$$Re_L = \frac{VL\rho}{\mu} = \frac{(0.3 \text{ m/s})(1.0 \text{ m})(996.6 \text{ kg/m}^3)}{0.854 \times 10^{-3} \text{ m}^2/\text{s}} = 3.501 \times 10^5$$

which is smaller than the critical Reynolds number. Thus we have laminar flow for the entire plate. The Nusselt number and the heat transfer coefficient are

$$Nu = 0.664 Re_L^{1/2} Pr^{1/3} = 0.664(3.501 \times 10^5)^{1/2} (5.85)^{1/3} = 707.9$$

$$h = \frac{k}{L} Nu = \frac{0.610 \text{ W/m}\cdot^\circ\text{C}}{1.0 \text{ m}} (707.9) = 431.8 \text{ W/m}^2\cdot^\circ\text{C}$$

Then the rate of heat transfer per unit width of the plate is determined to be

$$\dot{Q} = hA_s(T_s - T_\infty) = (431.8 \text{ W/m}^2\cdot^\circ\text{C})(1 \text{ m})(1 \text{ m})(43.3 - 10)^\circ\text{C} = \mathbf{14,400 \text{ W}}$$

7-22 Mercury flows over a flat plate that is maintained at a specified temperature. The rate of heat transfer from the entire plate is to be determined.

Assumptions **1** Steady operating conditions exist. **2** The critical Reynolds number is $Re_{cr} = 5 \times 10^5$. **3** Radiation effects are negligible. **4** Atmospheric pressure is taken 1 atm.

Properties The properties of mercury at the film temperature of $(75+25)/2=50^\circ\text{C}$ are (Table A-14)

$$k = 8.83632 \text{ W/m}\cdot^\circ\text{C}$$

$$\nu = 1.056 \times 10^{-7} \text{ m}^2/\text{s}$$

$$Pr = 0.0223$$

Analysis The local Nusselt number relation for liquid metals is given by Eq. 7-25 to be

$$Nu_x = \frac{h_x x}{k} = 0.565(Re_x Pr)^{1/2}$$

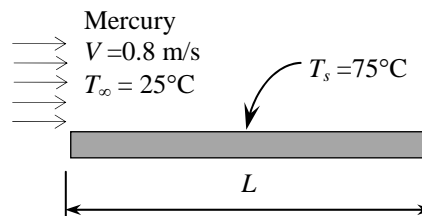

The average heat transfer coefficient for the entire surface can be determined from

$$h = \frac{1}{L} \int_0^L h_x dx$$

Substituting the local Nusselt number relation into the above equation and performing the integration we obtain

$$Nu = 1.13(Re_L Pr)^{1/2}$$

The Reynolds number is

$$Re_L = \frac{VL}{\nu} = \frac{(0.8 \text{ m/s})(3 \text{ m})}{1.056 \times 10^{-7} \text{ m}^2/\text{s}} = 2.273 \times 10^7$$

Using the relation for Nusselt number, the average heat transfer coefficient and the heat transfer rate are determined to be

$$Nu = \frac{hL}{k} = 1.13(Re_L Pr)^{1/2} = 1.13[(2.273 \times 10^7)(0.0223)]^{1/2} = 804.5$$

$$h = \frac{k}{L} Nu = \frac{8.83632 \text{ W/m}\cdot^\circ\text{C}}{3 \text{ m}} (804.5) = 2369 \text{ W/m}^2\cdot^\circ\text{C}$$

$$A = wL = (2 \text{ m})(3 \text{ m}) = 6 \text{ m}^2$$

$$\dot{Q} = hA(T_s - T_\infty) = (2369 \text{ W/m}^2\cdot^\circ\text{C})(6 \text{ m}^2)(75 - 25)^\circ\text{C} = 710,800 \text{ W} = \mathbf{710.8 \text{ kW}}$$

7-23 Ambient air flows over parallel plates of a solar collector that is maintained at a specified temperature. The rates of convection heat transfer from the first and third plate are to be determined.

Assumptions 1 Steady operating conditions exist. 2 The critical Reynolds number is $Re_{cr} = 5 \times 10^5$. 3 Radiation effects are negligible. 4 Atmospheric pressure is taken 1 atm.

Properties The properties of air at the film temperature of $(15+10)/2=12.5^\circ\text{C}$ are (Table A-15)

$$k = 0.02458 \text{ W/m}\cdot^\circ\text{C}$$

$$\nu = 1.448 \times 10^{-5} \text{ m}^2/\text{s}$$

$$Pr = 0.7330$$

Analysis (a) The critical length of the plate is first determined to be

$$x_{cr} = \frac{Re_{cr} \nu}{V} = \frac{(5 \times 10^5)(1.448 \times 10^{-5} \text{ m}^2/\text{s})}{2 \text{ m/s}} = 3.62 \text{ m}$$

Therefore, both plates are under laminar flow. The Reynolds number for the first plate is

$$Re_1 = \frac{VL_1}{\nu} = \frac{(2 \text{ m/s})(1 \text{ m})}{1.448 \times 10^{-5} \text{ m}^2/\text{s}} = 1.381 \times 10^5$$

Using the relation for Nusselt number, the average heat transfer coefficient and the heat transfer rate are determined to be

$$Nu_1 = 0.664 Re_1^{1/2} Pr^{1/3} = 0.664(1.381 \times 10^5)^{1/2} (0.7330)^{1/3} = 222.5$$

$$h_1 = \frac{k}{L_1} Nu = \frac{0.02458 \text{ W/m}\cdot^\circ\text{C}}{1 \text{ m}} (222.5) = 5.47 \text{ W/m}^2\cdot^\circ\text{C}$$

$$A = wL = (4 \text{ m})(1 \text{ m}) = 4 \text{ m}^2$$

$$\dot{Q} = hA(T_s - T_\infty) = (5.47 \text{ W/m}^2\cdot^\circ\text{C})(4 \text{ m}^2)(15 - 10)^\circ\text{C} = \mathbf{109 \text{ W}}$$

(b) Repeating the calculations for the second and third plates,

$$Re_2 = \frac{VL_2}{\nu} = \frac{(2 \text{ m/s})(2 \text{ m})}{1.448 \times 10^{-5} \text{ m}^2/\text{s}} = 2.762 \times 10^5$$

$$Nu_2 = 0.664 Re_2^{1/2} Pr^{1/3} = 0.664(2.762 \times 10^5)^{1/2} (0.7330)^{1/3} = 314.7$$

$$h_2 = \frac{k}{L_2} Nu = \frac{0.02458 \text{ W/m}\cdot^\circ\text{C}}{2 \text{ m}} (314.7) = 3.87 \text{ W/m}^2\cdot^\circ\text{C}$$

$$Re_3 = \frac{VL_3}{\nu} = \frac{(2 \text{ m/s})(3 \text{ m})}{1.448 \times 10^{-5} \text{ m}^2/\text{s}} = 4.144 \times 10^5$$

$$Nu_3 = 0.664 Re_3^{1/2} Pr^{1/3} = 0.664(4.144 \times 10^5)^{1/2} (0.7330)^{1/3} = 385.4$$

$$h_3 = \frac{k}{L_3} Nu = \frac{0.02458 \text{ W/m}\cdot^\circ\text{C}}{3 \text{ m}} (385.4) = 3.16 \text{ W/m}^2\cdot^\circ\text{C}$$

Then

$$h_{2-3} = \frac{h_3 L_3 - h_2 L_2}{L_3 - L_2} = \frac{3.16 \times 3 - 3.87 \times 2}{3 - 2} = 1.74 \text{ W/m}^2\cdot^\circ\text{C}$$

The rate of heat loss from the third plate is

$$\dot{Q} = hA(T_s - T_\infty) = (1.74 \text{ W/m}^2\cdot^\circ\text{C})(4 \text{ m}^2)(15 - 10)^\circ\text{C} = \mathbf{34.8 \text{ W}}$$

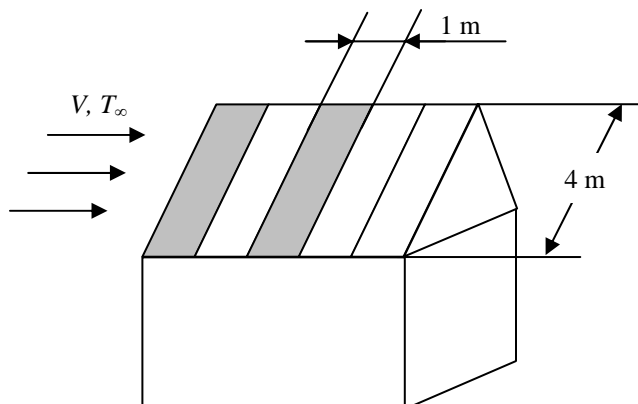

7-24 A car travels at a velocity of 80 km/h. The rate of heat transfer from the bottom surface of the hot automotive engine block is to be determined.

Assumptions 1 Steady operating conditions exist. 2 The critical Reynolds number is $Re_{cr} = 5 \times 10^5$. 3 Air is an ideal gas with constant properties. 4 The flow is turbulent over the entire surface because of the constant agitation of the engine block.

Properties The properties of air at 1 atm and the film temperature of $(T_s + T_\infty)/2 = (100+20)/2 = 60^\circ\text{C}$ are (Table A-15)

$$k = 0.02808 \text{ W/m}\cdot^\circ\text{C}$$

$$\nu = 1.896 \times 10^{-5} \text{ m}^2/\text{s}$$

$$Pr = 0.7202$$

Analysis Air flows parallel to the 0.4 m side. The Reynolds number in this case is

$$Re_L = \frac{V_\infty L}{\nu} = \frac{[(80 \times 1000 / 3600) \text{ m/s}](0.8 \text{ m})}{1.896 \times 10^{-5} \text{ m}^2/\text{s}} = 9.376 \times 10^5$$

which is greater than the critical Reynolds number and thus the flow is laminar + turbulent. But the flow is assumed to be turbulent over the entire surface because of the constant agitation of the engine block. Using the proper relations, the Nusselt number, the heat transfer coefficient, and the heat transfer rate are determined to be

$$Nu = \frac{hL}{k} = 0.037 Re_L^{0.8} Pr^{1/3} = 0.037(9.376 \times 10^5)^{0.8} (0.7202)^{1/3} = 1988$$

$$h = \frac{k}{L} Nu = \frac{0.02808 \text{ W/m}\cdot^\circ\text{C}}{0.8 \text{ m}} (1988) = 69.78 \text{ W/m}^2\cdot^\circ\text{C}$$

$$A_s = wL = (0.8 \text{ m})(0.4 \text{ m}) = 0.32 \text{ m}^2$$

$$\dot{Q}_{conv} = hA_s(T_\infty - T_s) = (69.78 \text{ W/m}^2\cdot^\circ\text{C})(0.32 \text{ m}^2)(100 - 20)^\circ\text{C} = \mathbf{1786 \text{ W}}$$

The radiation heat transfer from the same surface is

$$\begin{aligned} \dot{Q}_{rad} &= \varepsilon A_s \sigma (T_s^4 - T_{surr}^4) \\ &= (0.95)(0.32 \text{ m}^2)(5.67 \times 10^{-8} \text{ W/m}^2\cdot\text{K}^4)[(100 + 273 \text{ K})^4 - (25 + 273 \text{ K})^4] = \mathbf{198 \text{ W}} \end{aligned}$$

Then the total rate of heat transfer from that surface becomes

$$\dot{Q}_{total} = \dot{Q}_{conv} + \dot{Q}_{rad} = (1786 + 198) \text{ W} = \mathbf{1984 \text{ W}}$$

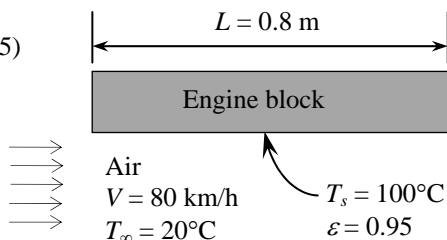

7-25 Air flows on both sides of a continuous sheet of plastic. The rate of heat transfer from the plastic sheet is to be determined.

Assumptions 1 Steady operating conditions exist. 2 The critical Reynolds number is $Re_{cr} = 5 \times 10^5$. 3 Radiation effects are negligible. 4 Air is an ideal gas with constant properties.

Properties The properties of air at 1 atm and the film temperature of $(T_s + T_\infty)/2 = (90+30)/2 = 60^\circ\text{C}$ are (Table A-15)

$$\begin{aligned}\rho &= 1.059 \text{ kg/m}^3 \\ k &= 0.02808 \text{ W/m}\cdot^\circ\text{C} \\ \nu &= 1.896 \times 10^{-5} \text{ m}^2/\text{s} \\ Pr &= 0.7202\end{aligned}$$

Analysis The width of the cooling section is first determined from

$$W = V\Delta t = [(15 / 60) \text{ m/s}](2 \text{ s}) = 0.5 \text{ m}$$

The Reynolds number is

$$Re_L = \frac{VL}{\nu} = \frac{(3 \text{ m/s})(1.2 \text{ m})}{1.896 \times 10^{-5} \text{ m}^2/\text{s}} = 1.899 \times 10^5$$

which is less than the critical Reynolds number. Thus the flow is laminar. Using the proper relation in laminar flow for Nusselt number, the average heat transfer coefficient and the heat transfer rate are determined to be

$$Nu = \frac{hL}{k} = 0.664 Re_L^{0.5} Pr^{1/3} = 0.664(1.899 \times 10^5)^{0.5} (0.7202)^{1/3} = 259.3$$

$$h = \frac{k}{L} Nu = \frac{0.02808 \text{ W/m}\cdot^\circ\text{C}}{1.2 \text{ m}} (259.3) = 6.07 \text{ W/m}^2\cdot^\circ\text{C}$$

$$A_s = 2LW = 2(1.2 \text{ m})(0.5 \text{ m}) = 1.2 \text{ m}^2$$

$$\dot{Q}_{conv} = hA_s(T_\infty - T_s) = (6.07 \text{ W/m}^2\cdot^\circ\text{C})(1.2 \text{ m}^2)(90 - 30)^\circ\text{C} = \mathbf{437 \text{ W}}$$

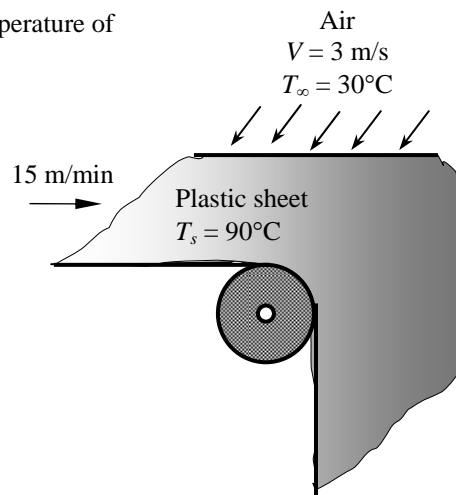

7-26 The top surface of the passenger car of a train in motion is absorbing solar radiation. The equilibrium temperature of the top surface is to be determined.

Assumptions 1 Steady operating conditions exist. 2 The critical Reynolds number is $Re_{cr} = 5 \times 10^5$. 3 Radiation heat exchange with the surroundings is negligible. 4 Air is an ideal gas with constant properties.

Properties The properties of air at 30°C are (Table A-15)

$$k = 0.02588 \text{ W/m}\cdot^\circ\text{C}$$

$$\nu = 1.608 \times 10^{-5} \text{ m}^2/\text{s}$$

$$Pr = 0.7282$$

Analysis The rate of convection heat transfer from the top surface of the car to the air must be equal to the solar radiation absorbed by the same surface in order to reach steady operation conditions. The Reynolds number is

$$Re_L = \frac{VL}{\nu} = \frac{[70 \times 1000/3600] \text{ m/s}(8 \text{ m})}{1.608 \times 10^{-5} \text{ m}^2/\text{s}} = 9.674 \times 10^6$$

which is greater than the critical Reynolds number. Thus we have combined laminar and turbulent flow. Using the proper relation for Nusselt number, the average heat transfer coefficient and the heat transfer rate are determined to be

$$Nu = \frac{hL}{k} = (0.037 Re_L^{0.8} - 871) Pr^{1/3} = [0.037(9.674 \times 10^6)^{0.8} - 871](0.7282)^{1/3} = 1.212 \times 10^4$$

$$h = \frac{k}{L} Nu = \frac{0.02588 \text{ W/m}\cdot^\circ\text{C}}{8 \text{ m}} (1.212 \times 10^4) = 39.21 \text{ W/m}^2\cdot^\circ\text{C}$$

The equilibrium temperature of the top surface is then determined by taking convection and radiation heat fluxes to be equal to each other

$$\dot{q}_{rad} = \dot{q}_{conv} = h(T_s - T_\infty) \longrightarrow T_s = T_\infty + \frac{\dot{q}_{conv}}{h} = 30^\circ\text{C} + \frac{200 \text{ W/m}^2}{39.21 \text{ W/m}^2\cdot^\circ\text{C}} = \mathbf{35.1^\circ\text{C}}$$

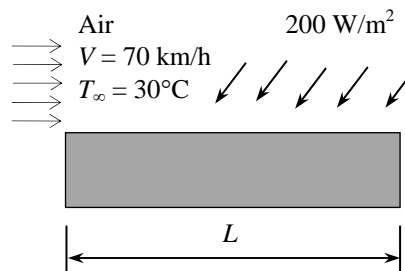

7-27 EES Prob. 7-26 is reconsidered. The effects of the train velocity and the rate of absorption of solar radiation on the equilibrium temperature of the top surface of the car are to be investigated.

Analysis The problem is solved using EES, and the solution is given below.

"GIVEN"

Vel=70 [km/h]
 w=2.8 [m]
 L=8 [m]
 q_dot_rad=200 [W/m^2]
 T_infinity=30 [C]

"PROPERTIES"

Fluid\$='air'
 k=Conductivity(Fluid\$, T=T_film)
 Pr=Prandtl(Fluid\$, T=T_film)
 rho=Density(Fluid\$, T=T_film, P=101.3)
 mu=Viscosity(Fluid\$, T=T_film)
 nu=mu/rho
 T_film=1/2*(T_s+T_infinity)

"ANALYSIS"

Re=(Vel*Convert(km/h, m/s)*L)/nu
 "Reynolds number is greater than the critical Reynolds number. We use combined laminar and turbulent flow relation for Nusselt number"
 Nusselt=(0.037*Re^0.8-871)*Pr^(1/3)
 h=k/L*Nusselt
 q_dot_conv=h*(T_s-T_infinity)
 q_dot_conv=q_dot_rad

Vel [km/h]	T _s [C]
10	64.01
15	51.44
20	45.99
25	42.89
30	40.86
35	39.43
40	38.36
45	37.53
50	36.86
55	36.32
60	35.86
65	35.47
70	35.13
75	34.83
80	34.58
85	34.35
90	34.14
95	33.96
100	33.79
105	33.64
110	33.5
115	33.37
120	33.25

\dot{Q}_{rad} [W/m ²]	T_s [C]
100	32.56
125	33.2
150	33.84
175	34.48
200	35.13
225	35.77
250	36.42
275	37.07
300	37.71
325	38.36
350	39.01
375	39.66
400	40.31
425	40.97
450	41.62
475	42.27
500	42.93

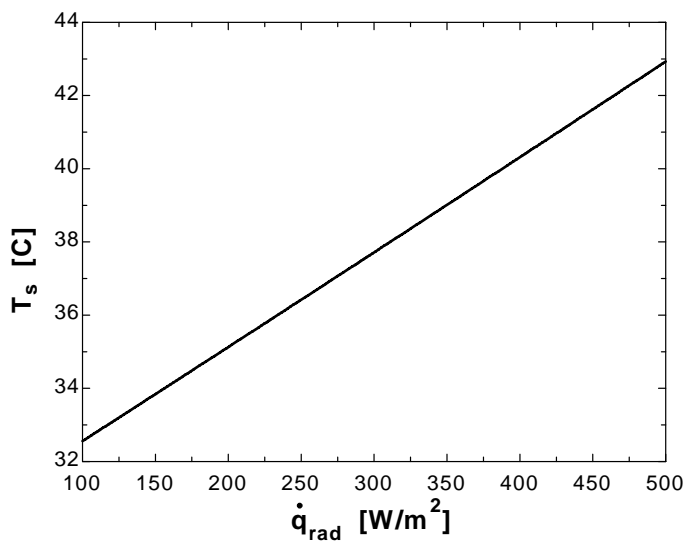
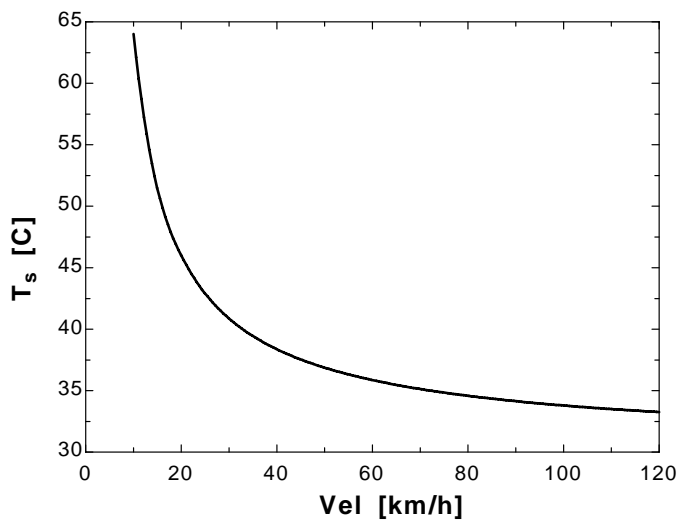

7-28 A circuit board is cooled by air. The surface temperatures of the electronic components at the leading edge and the end of the board are to be determined.

Assumptions 1 Steady operating conditions exist. 2 The critical Reynolds number is $Re_{cr} = 5 \times 10^5$. 3 Radiation effects are negligible. 4 Any heat transfer from the back surface of the board is disregarded. 5 Air is an ideal gas with constant properties.

Properties Assuming the film temperature to be approximately 35°C , the properties of air are evaluated at this temperature to be (Table A-15)

$$k = 0.0265 \text{ W/m}\cdot^\circ\text{C}$$

$$\nu = 1.655 \times 10^{-5} \text{ m}^2/\text{s}$$

$$Pr = 0.7268$$

Analysis (a) The convection heat transfer coefficient at the leading edge approaches infinity, and thus the surface temperature there must approach the air temperature, which is 20°C .

(b) The Reynolds number is

$$Re_x = \frac{Vx}{\nu} = \frac{(6 \text{ m/s})(0.15 \text{ m})}{1.655 \times 10^{-5} \text{ m}^2/\text{s}} = 5.438 \times 10^4$$

which is less than the critical Reynolds number but we assume the flow to be turbulent since the electronic components are expected to act as turbulators. Using the Nusselt number uniform heat flux, the local heat transfer coefficient at the end of the board is determined to be

$$Nu_x = \frac{h_x x}{k} = 0.0308 Re_x^{0.8} Pr^{1/3} = 0.0308(5.438 \times 10^4)^{0.8} (0.7268)^{1/3} = 170.1$$

$$h_x = \frac{k_x}{x} Nu_x = \frac{0.02625 \text{ W/m}\cdot^\circ\text{C}}{0.15 \text{ m}} (170.1) = 29.77 \text{ W/m}^2\cdot^\circ\text{C}$$

Then the surface temperature at the end of the board becomes

$$\dot{q} = h_x(T_s - T_\infty) \longrightarrow T_s = T_\infty + \frac{\dot{q}}{h_x} = 20^\circ\text{C} + \frac{(20 \text{ W})/(0.15 \text{ m})^2}{29.77 \text{ W/m}^2\cdot^\circ\text{C}} = \mathbf{49.9^\circ\text{C}}$$

Discussion The heat flux can also be determined approximately using the relation for isothermal surfaces,

$$Nu_x = \frac{h_x x}{k} = 0.0296 Re_x^{0.8} Pr^{1/3} = 0.0296(5.438 \times 10^4)^{0.8} (0.7268)^{1/3} = 163.5$$

$$h_x = \frac{k_x}{x} Nu_x = \frac{0.02625 \text{ W/m}\cdot^\circ\text{C}}{0.15 \text{ m}} (163.5) = 28.61 \text{ W/m}^2\cdot^\circ\text{C}$$

Then the surface temperature at the end of the board becomes

$$\dot{q} = h_x(T_s - T_\infty) \longrightarrow T_s = T_\infty + \frac{\dot{q}}{h_x} = 20^\circ\text{C} + \frac{(20 \text{ W})/(0.15 \text{ m})^2}{28.61 \text{ W/m}^2\cdot^\circ\text{C}} = \mathbf{51.1^\circ\text{C}}$$

Note that the two results are close to each other.

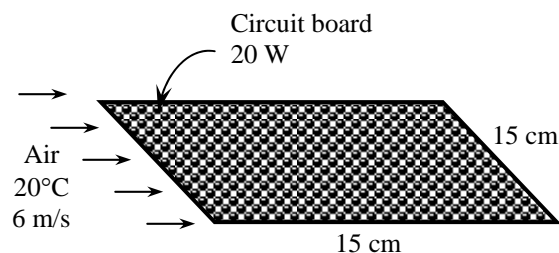

7-29 Laminar flow of a fluid over a flat plate is considered. The change in the drag force and the rate of heat transfer are to be determined when the free-stream velocity of the fluid is doubled.

Analysis For the laminar flow of a fluid over a flat plate maintained at a constant temperature the drag force is given by

$$F_{D1} = C_f A_s \frac{\rho V^2}{2} \quad \text{where} \quad C_f = \frac{1.33}{\text{Re}^{0.5}}$$

Therefore

$$F_{D1} = \frac{1.33}{\text{Re}^{0.5}} A_s \frac{\rho V^2}{2}$$

Substituting Reynolds number relation, we get

$$F_{D1} = \frac{1.33}{\left(\frac{VL}{\nu}\right)^{0.5}} A_s \frac{\rho V^2}{2} = 0.664 V^{3/2} A_s \frac{\nu^{0.5}}{L^{0.5}}$$

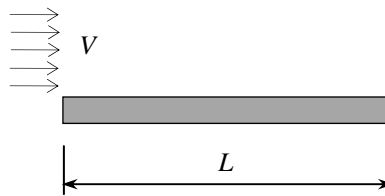

When the free-stream velocity of the fluid is doubled, the new value of the drag force on the plate becomes

$$F_{D2} = \frac{1.33}{\left(\frac{(2V)L}{\nu}\right)^{0.5}} A_s \frac{\rho(2V)^2}{2} = 0.664(2V)^{3/2} A_s \frac{\nu^{0.5}}{L^{0.5}}$$

The ratio of drag forces corresponding to V and $2V$ is

$$\frac{F_{D2}}{F_{D1}} = \frac{(2V)^{3/2}}{V^{3/2}} = 2^{3/2}$$

We repeat similar calculations for heat transfer rate ratio corresponding to V and $2V$

$$\begin{aligned} \dot{Q}_1 &= h A_s (T_s - T_\infty) = \left(\frac{k}{L} Nu\right) A_s (T_s - T_\infty) = \left(\frac{k}{L}\right) (0.664 \text{Re}^{0.5} \text{Pr}^{1/3}) A_s (T_s - T_\infty) \\ &= \frac{k}{L} 0.664 \left(\frac{VL}{\nu}\right)^{0.5} \text{Pr}^{1/3} A_s (T_s - T_\infty) \\ &= 0.664 V^{0.5} \frac{k}{L^{0.5} \nu^{0.5}} \text{Pr}^{1/3} A_s (T_s - T_\infty) \end{aligned}$$

When the free-stream velocity of the fluid is doubled, the new value of the heat transfer rate between the fluid and the plate becomes

$$\dot{Q}_2 = 0.664(2V)^{0.5} \frac{k}{L^{0.5} \nu^{0.5}} \text{Pr}^{1/3} A_s (T_s - T_\infty)$$

Then the ratio is

$$\frac{\dot{Q}_2}{\dot{Q}_1} = \frac{(2V)^{0.5}}{V^{0.5}} = 2^{0.5} = \sqrt{2}$$

7-30E A refrigeration truck is traveling at 55 mph. The average temperature of the outer surface of the refrigeration compartment of the truck is to be determined.

Assumptions 1 Steady operating conditions exist. 2 The critical Reynolds number is $Re_{cr} = 5 \times 10^5$. 3 Radiation effects are negligible. 4 Air is an ideal gas with constant properties. 5 The local atmospheric pressure is 1 atm.

Properties Assuming the film temperature to be approximately 80°F, the properties of air at this temperature and 1 atm are (Table A-15E)

$$k = 0.01481 \text{ Btu/h.ft.}^\circ\text{F}$$

$$\nu = 1.697 \times 10^{-4} \text{ ft}^2/\text{s}$$

$$Pr = 0.7290$$

Analysis The Reynolds number is

$$Re_L = \frac{VL}{\nu} = \frac{[55 \times 5280/3600] \text{ ft/s}(20 \text{ ft})}{1.697 \times 10^{-4} \text{ ft}^2/\text{s}} = 9.507 \times 10^6$$

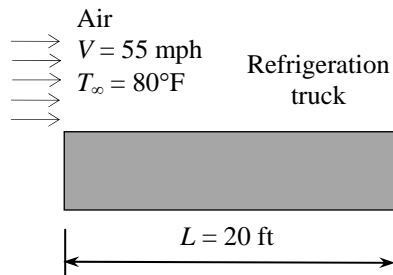

We assume the air flow over the entire outer surface to be turbulent. Therefore using the proper relation in turbulent flow for Nusselt number, the average heat transfer coefficient is determined to be

$$Nu = \frac{hL}{k} = 0.037 Re_L^{0.8} Pr^{1/3} = 0.037(9.507 \times 10^6)^{0.8} (0.7290)^{1/3} = 1.273 \times 10^4$$

$$h = \frac{k}{L} Nu = \frac{0.01481 \text{ Btu/h.ft.}^\circ\text{F}}{20 \text{ ft}} (1.273 \times 10^4) = 9.428 \text{ Btu/h.ft}^2 \cdot ^\circ\text{F}$$

Since the refrigeration system is operated at half the capacity, we will take half of the heat removal rate

$$\dot{Q} = \frac{(600 \times 60) \text{ Btu/h}}{2} = 18,000 \text{ Btu/h}$$

The total heat transfer surface area and the average surface temperature of the refrigeration compartment of the truck are determined from

$$A = 2[(20 \text{ ft})(9 \text{ ft}) + (20 \text{ ft})(8 \text{ ft}) + (9 \text{ ft})(8 \text{ ft})] = 824 \text{ ft}^2$$

$$\dot{Q} = hA_s(T_\infty - T_s) \longrightarrow T_s = T_\infty - \frac{\dot{Q}}{hA_s} = 80^\circ\text{F} - \frac{18,000 \text{ Btu/h}}{(9.428 \text{ Btu/h.ft}^2 \cdot ^\circ\text{F})(824 \text{ ft}^2)} = 77.7^\circ\text{F}$$

7-31 Solar radiation is incident on the glass cover of a solar collector. The total rate of heat loss from the collector, the collector efficiency, and the temperature rise of water as it flows through the collector are to be determined.

Assumptions 1 Steady operating conditions exist. 2 The critical Reynolds number is $Re_{cr} = 5 \times 10^5$. 3 Heat exchange on the back surface of the absorber plate is negligible. 4 Air is an ideal gas with constant properties. 5 The local atmospheric pressure is 1 atm.

Properties The properties of air at the film temperature of $(35 + 25) / 2 = 30^\circ\text{C}$ are (Table A-15)

$$k = 0.02588 \text{ W/m}\cdot^\circ\text{C}$$

$$\nu = 1.608 \times 10^{-5} \text{ m}^2/\text{s}$$

$$Pr = 0.7282$$

Analysis (a) Assuming wind flows across 2 m surface, the Reynolds number is determined from

$$Re_L = \frac{VL}{\nu} = \frac{(30 \times 1000 / 3600 \text{ m/s})(2 \text{ m})}{1.608 \times 10^{-5} \text{ m}^2/\text{s}} = 1.036 \times 10^6$$

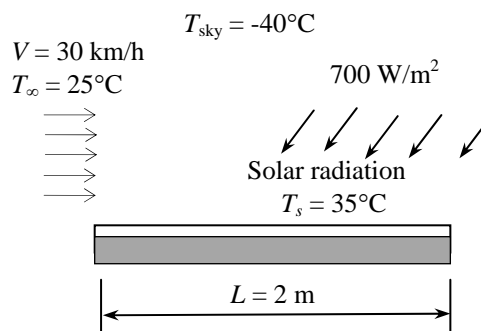

which is greater than the critical Reynolds number. Using the Nusselt number relation for combined laminar and turbulent flow, the average heat transfer coefficient is determined to be

$$Nu = \frac{hL}{k} = (0.037 Re^{0.8} - 871) Pr^{1/3} = [0.037(1.036 \times 10^6)^{0.8} - 871](0.7282)^{1/3} = 1378$$

$$h = \frac{k}{L} Nu = \frac{0.02588 \text{ W/m}\cdot^\circ\text{C}}{2 \text{ m}} (1378) = 17.83 \text{ W/m}^2\cdot^\circ\text{C}$$

Then the rate of heat loss from the collector by convection is

$$\dot{Q}_{conv} = hA_s(T_\infty - T_s) = (17.83 \text{ W/m}^2\cdot^\circ\text{C})(2 \times 1.2 \text{ m}^2)(35 - 25)^\circ\text{C} = 427.9 \text{ W}$$

The rate of heat loss from the collector by radiation is

$$\begin{aligned} \dot{Q}_{rad} &= \varepsilon A_s \sigma (T_s^4 - T_{surr}^4) \\ &= (0.90)(2 \times 1.2 \text{ m}^2)(5.67 \times 10^{-8} \text{ W/m}^2\cdot^\circ\text{C}) \left[(35 + 273 \text{ K})^4 - (-40 + 273 \text{ K})^4 \right] \\ &= 741.2 \text{ W} \end{aligned}$$

and

$$\dot{Q}_{total} = \dot{Q}_{conv} + \dot{Q}_{rad} = 427.9 + 741.2 = \mathbf{1169 \text{ W}}$$

(b) The net rate of heat transferred to the water is

$$\begin{aligned} \dot{Q}_{net} &= \dot{Q}_{in} - \dot{Q}_{out} = \alpha AI - \dot{Q}_{out} \\ &= (0.88)(2 \times 1.2 \text{ m}^2)(700 \text{ W/m}^2) - 1169 \text{ W} \\ &= 1478 - 1169 = 309 \text{ W} \\ \eta_{collector} &= \frac{\dot{Q}_{net}}{\dot{Q}_{in}} = \frac{309 \text{ W}}{1478 \text{ W}} = \mathbf{0.209} \end{aligned}$$

(c) The temperature rise of water as it flows through the collector is

$$\dot{Q}_{net} = \dot{m} c_p \Delta T \longrightarrow \Delta T = \frac{\dot{Q}_{net}}{\dot{m} c_p} = \frac{309.4 \text{ W}}{(1/60 \text{ kg/s})(4180 \text{ J/kg}\cdot^\circ\text{C})} = \mathbf{4.44^\circ\text{C}}$$

7-32 A fan blows air parallel to the passages between the fins of a heat sink attached to a transformer. The minimum free-stream velocity that the fan should provide to avoid overheating is to be determined.

Assumptions **1** Steady operating conditions exist. **2** The critical Reynolds number is $Re_{cr} = 5 \times 10^5$. **3** Radiation effects are negligible. **4** The fins and the base plate are nearly isothermal (fin efficiency is equal to 1) **5** Air is an ideal gas with constant properties. **6** The local atmospheric pressure is 1 atm.

Properties The properties of air at 1 atm and the film temperature of $(T_s + T_\infty)/2 = (60+25)/2 = 42.5^\circ\text{C}$ are (Table A-15)

$$k = 0.02681 \text{ W/m}\cdot^\circ\text{C}$$

$$\nu = 1.726 \times 10^{-5} \text{ m}^2/\text{s}$$

$$Pr = 0.7248$$

Analysis The total heat transfer surface area for this finned surface is

$$A_{s,\text{finned}} = (2 \times 7)(0.1 \text{ m})(0.005 \text{ m}) = 0.007 \text{ m}^2$$

$$A_{s,\text{unfinned}} = (0.1 \text{ m})(0.062 \text{ m}) - 7 \times (0.002 \text{ m})(0.1 \text{ m}) = 0.0048 \text{ m}^2$$

$$A_{s,\text{total}} = A_{s,\text{finned}} + A_{s,\text{unfinned}} = 0.007 \text{ m}^2 + 0.0048 \text{ m}^2 = 0.0118 \text{ m}^2$$

The convection heat transfer coefficient can be determined from Newton's law of cooling relation for a finned surface.

$$\dot{Q} = \eta h A_s (T_\infty - T_s) \longrightarrow h = \frac{\dot{Q}}{\eta A_s (T_\infty - T_s)} = \frac{12 \text{ W}}{(1)(0.0118 \text{ m}^2)(60 - 25)^\circ\text{C}} = 29.06 \text{ W/m}^2 \cdot ^\circ\text{C}$$

Starting from heat transfer coefficient, Nusselt number, Reynolds number and finally free-stream velocity will be determined. We assume the flow is laminar over the entire finned surface of the transformer.

$$Nu = \frac{hL}{k} = \frac{(29.06 \text{ W/m}^2 \cdot ^\circ\text{C})(0.1 \text{ m})}{0.02681 \text{ W/m}\cdot^\circ\text{C}} = 108.4$$

$$Nu = 0.664 Re_L^{0.5} Pr^{1/3} \longrightarrow Re_L = \frac{Nu^2}{0.664^2 Pr^{2/3}} = \frac{(108.4)^2}{(0.664)^2 (0.7248)^{2/3}} = 3.302 \times 10^4$$

$$Re_L = \frac{VL}{\nu} \longrightarrow V = \frac{Re_L \nu}{L} = \frac{(3.302 \times 10^4)(1.726 \times 10^{-5} \text{ m}^2/\text{s})}{0.1 \text{ m}} = \mathbf{5.70 \text{ m/s}}$$

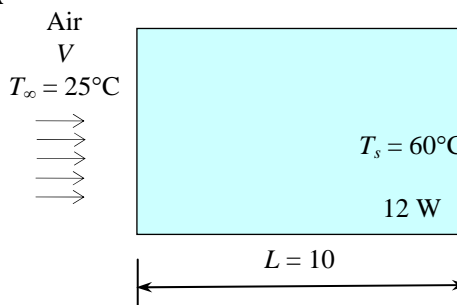

7-33 A fan blows air parallel to the passages between the fins of a heat sink attached to a transformer. The minimum free-stream velocity that the fan should provide to avoid overheating is to be determined.

Assumptions 1 Steady operating conditions exist. 2 The critical Reynolds number is $Re_{cr} = 5 \times 10^5$. 3 The fins and the base plate are nearly isothermal (fin efficiency is equal to 1) 4 Air is an ideal gas with constant properties. 5 The local atmospheric pressure is 1 atm.

Properties The properties of air at the film temperature of $(T_s + T_\infty)/2 = (60+25)/2 = 42.5^\circ\text{C}$ are (Table A-15)

$$\begin{aligned} k &= 0.02681 \text{ W/m}\cdot^\circ\text{C} \\ \nu &= 1.726 \times 10^{-5} \text{ m}^2/\text{s} \\ Pr &= 0.7248 \end{aligned}$$

Analysis We first need to determine radiation heat transfer rate. Note that we will use the base area and we assume the temperature of the surrounding surfaces are at the same temperature with the air ($T_{surr} = 25^\circ\text{C}$)

$$\begin{aligned} \dot{Q}_{rad} &= \epsilon A_s \sigma (T_s^4 - T_{surr}^4) \\ &= (0.90)[(0.1 \text{ m})(0.062 \text{ m})][5.67 \times 10^{-8} \text{ W/m}^2 \cdot ^\circ\text{C}][(60 + 273 \text{ K})^4 - (25 + 273 \text{ K})^4] \\ &= 1.4 \text{ W} \end{aligned}$$

The heat transfer rate by convection will be 1.4 W less than total rate of heat transfer from the transformer. Therefore

$$\dot{Q}_{conv} = \dot{Q}_{total} - \dot{Q}_{rad} = 12 - 1.4 = 10.6 \text{ W}$$

The total heat transfer surface area for this finned surface is

$$\begin{aligned} A_{s,finned} &= (2 \times 7)(0.1 \text{ m})(0.005 \text{ m}) = 0.007 \text{ m}^2 \\ A_{s,unfinned} &= (0.1 \text{ m})(0.062 \text{ m}) - 7 \times (0.002 \text{ m})(0.1 \text{ m}) = 0.0048 \text{ m}^2 \\ A_{s,total} &= A_{s,finned} + A_{s,unfinned} = 0.007 \text{ m}^2 + 0.0048 \text{ m}^2 = 0.0118 \text{ m}^2 \end{aligned}$$

The convection heat transfer coefficient can be determined from Newton's law of cooling relation for a finned surface.

$$\dot{Q}_{conv} = \eta h A_s (T_\infty - T_s) \longrightarrow h = \frac{\dot{Q}_{conv}}{\eta A_s (T_\infty - T_s)} = \frac{10.6 \text{ W}}{(1)(0.0118 \text{ m}^2)(60 - 25)^\circ\text{C}} = 25.67 \text{ W/m}^2 \cdot ^\circ\text{C}$$

Starting from heat transfer coefficient, Nusselt number, Reynolds number and finally free-stream velocity will be determined. We assume the flow is laminar over the entire finned surface of the transformer.

$$\begin{aligned} Nu &= \frac{hL}{k} = \frac{(25.67 \text{ W/m}^2 \cdot ^\circ\text{C})(0.1 \text{ m})}{0.02681 \text{ W/m}\cdot^\circ\text{C}} = 95.73 \\ Nu &= 0.664 Re_L^{0.5} Pr^{1/3} \longrightarrow Re_L = \frac{Nu^2}{0.664^2 Pr^{2/3}} = \frac{(95.73)^2}{(0.664)^2 (0.7248)^{2/3}} = 2.576 \times 10^4 \\ Re_L &= \frac{VL}{\nu} \longrightarrow V = \frac{Re_L \nu}{L} = \frac{(2.576 \times 10^4)(1.726 \times 10^{-5} \text{ m}^2/\text{s})}{0.1 \text{ m}} = \mathbf{4.45 \text{ m/s}} \end{aligned}$$

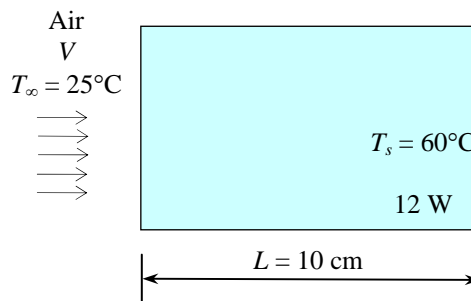

7-34 Air is blown over an aluminum plate mounted on an array of power transistors. The number of transistors that can be placed on this plate is to be determined.

Assumptions **1** Steady operating conditions exist. **2** The critical Reynolds number is $Re_{cr} = 5 \times 10^5$. **3** Radiation effects are negligible **4** Heat transfer from the back side of the plate is negligible. **5** Air is an ideal gas with constant properties. **6** The local atmospheric pressure is 1 atm.

Properties The properties of air at the film temperature of $(T_s + T_\infty)/2 = (65 + 35)/2 = 50^\circ\text{C}$ are (Table A-15)

$$k = 0.02735 \text{ W/m}\cdot^\circ\text{C}$$

$$\nu = 1.798 \times 10^{-5} \text{ m}^2/\text{s}$$

$$Pr = 0.7228$$

Analysis The Reynolds number is

$$Re_L = \frac{VL}{\nu} = \frac{(4 \text{ m/s})(0.25 \text{ m})}{1.798 \times 10^{-5} \text{ m}^2/\text{s}} = 55,617$$

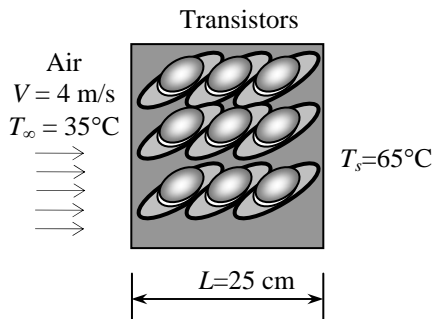

which is less than the critical Reynolds number. Thus the flow is laminar. Using the proper relation in laminar flow for Nusselt number, heat transfer coefficient and the heat transfer rate are determined to be

$$Nu = \frac{hL}{k} = 0.664 Re_L^{0.5} Pr^{1/3} = 0.664(55,617)^{0.5} (0.7228)^{1/3} = 140.5$$

$$h = \frac{k}{L} Nu = \frac{0.02735 \text{ W/m}\cdot^\circ\text{C}}{0.25 \text{ m}} (140.5) = 15.37 \text{ W/m}^2\cdot^\circ\text{C}$$

$$A_s = wL = (0.25 \text{ m})(0.25 \text{ m}) = 0.0625 \text{ m}^2$$

$$\dot{Q}_{conv} = hA_s(T_\infty - T_s) = (15.37 \text{ W/m}^2\cdot^\circ\text{C})(0.0625 \text{ m}^2)(65 - 35)^\circ\text{C} = 28.83 \text{ W}$$

Considering that each transistor dissipates 6 W of power, the number of transistors that can be placed on this plate becomes

$$n = \frac{28.8 \text{ W}}{6 \text{ W}} = 4.8 \longrightarrow \mathbf{4}$$

This result is conservative since the transistors will cause the flow to be turbulent, and the rate of heat transfer to be higher.

7-35 Air is blown over an aluminum plate mounted on an array of power transistors. The number of transistors that can be placed on this plate is to be determined.

Assumptions **1** Steady operating conditions exist. **2** The critical Reynolds number is $Re_{cr} = 5 \times 10^5$. **3** Radiation effects are negligible **4** Heat transfer from the backside of the plate is negligible. **5** Air is an ideal gas with constant properties. **6** The local atmospheric pressure is 1 atm.

Properties The properties of air at 1 atm and the film temperature of $(T_s + T_\infty)/2 = (65 + 35)/2 = 50^\circ\text{C}$ are (Table A-15)

$$k = 0.02735 \text{ W/m}\cdot^\circ\text{C}$$

$$\nu = 1.798 \times 10^{-5} \text{ m}^2/\text{s}$$

$$Pr = 0.7228$$

Note that the atmospheric pressure will only affect the kinematic viscosity. The atmospheric pressure in atm is

$$P = (83.4 \text{ kPa}) \frac{1 \text{ atm}}{101.325 \text{ kPa}} = 0.823 \text{ atm}$$

The kinematic viscosity at this atmospheric pressure will be

$$\nu = (1.798 \times 10^{-5} \text{ m}^2/\text{s}) / 0.823 = 2.184 \times 10^{-5} \text{ m}^2/\text{s}$$

Analysis The Reynolds number is

$$Re_L = \frac{VL}{\nu} = \frac{(4 \text{ m/s})(0.25 \text{ m})}{2.184 \times 10^{-5} \text{ m}^2/\text{s}} = 4.579 \times 10^4$$

which is less than the critical Reynolds number. Thus the flow is laminar. Using the proper relation in laminar flow for Nusselt number, the average heat transfer coefficient and the heat transfer rate are determined to be

$$Nu = \frac{hL}{k} = 0.664 Re_L^{0.5} Pr^{1/3} = 0.664(4.579 \times 10^4)^{0.5} (0.7228)^{1/3} = 127.5$$

$$h = \frac{k}{L} Nu = \frac{0.02735 \text{ W/m}\cdot^\circ\text{C}}{0.25 \text{ m}} (127.5) = 13.95 \text{ W/m}^2\cdot^\circ\text{C}$$

$$A_s = wL = (0.25 \text{ m})(0.25 \text{ m}) = 0.0625 \text{ m}^2$$

$$\dot{Q}_{\text{conv}} = hA_s(T_\infty - T_s) = (13.95 \text{ W/m}^2\cdot^\circ\text{C})(0.0625 \text{ m}^2)(65 - 35)^\circ\text{C} = 26.2 \text{ W}$$

Considering that each transistor dissipates 6 W of power, the number of transistors that can be placed on this plate becomes

$$n = \frac{26.2 \text{ W}}{6 \text{ W}} = 4.4 \longrightarrow \mathbf{4}$$

This result is conservative since the transistors will cause the flow to be turbulent, and the rate of heat transfer to be higher.

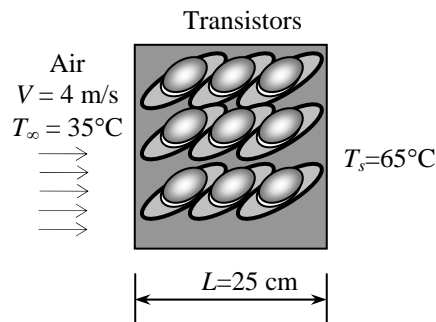

7-36 Air is flowing over a long flat plate with a specified velocity. The distance from the leading edge of the plate where the flow becomes turbulent, and the thickness of the boundary layer at that location are to be determined.

Assumptions 1 The flow is steady and incompressible. 2 The critical Reynolds number is $Re_{cr} = 5 \times 10^5$. 3 Air is an ideal gas. 4 The surface of the plate is smooth.

Properties The density and kinematic viscosity of air at 1 atm and 25°C are $\rho = 1.184 \text{ kg/m}^3$ and $\nu = 1.562 \times 10^{-5} \text{ m}^2/\text{s}$ (Table A-15).

Analysis The distance from the leading edge of the plate where the flow becomes turbulent is the distance x_{cr} where the Reynolds number becomes equal to the critical Reynolds number,

$$Re_{cr} = \frac{Vx_{cr}}{\nu} \rightarrow$$

$$x_{cr} = \frac{\nu Re_{cr}}{V} = \frac{(1.562 \times 10^{-5} \text{ m}^2/\text{s})(5 \times 10^5)}{8 \text{ m/s}} = \mathbf{0.976 \text{ m}}$$

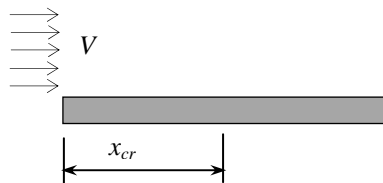

The thickness of the boundary layer at that location is obtained by substituting this value of x into the laminar boundary layer thickness relation,

$$\delta_x = \frac{5x}{Re_x^{1/2}} \rightarrow \delta_{cr} = \frac{5x_{cr}}{Re_{cr}^{1/2}} = \frac{5(0.976 \text{ m})}{(5 \times 10^5)^{1/2}} = 0.006903 \text{ m} = \mathbf{0.69 \text{ cm}}$$

Discussion When the flow becomes turbulent, the boundary layer thickness starts to increase, and the value of its thickness can be determined from the boundary layer thickness relation for turbulent flow.

7-37 Water is flowing over a long flat plate with a specified velocity. The distance from the leading edge of the plate where the flow becomes turbulent, and the thickness of the boundary layer at that location are to be determined.

Assumptions 1 The flow is steady and incompressible. 2 The critical Reynolds number is $Re_{cr} = 5 \times 10^5$. 3 The surface of the plate is smooth.

Properties The density and dynamic viscosity of water at 1 atm and 25°C are $\rho = 997 \text{ kg/m}^3$ and $\mu = 0.891 \times 10^{-3} \text{ kg/m}\cdot\text{s}$ (Table A-9).

Analysis The distance from the leading edge of the plate where the flow becomes turbulent is the distance x_{cr} where the Reynolds number becomes equal to the critical Reynolds number,

$$Re_{cr} = \frac{\rho V x_{cr}}{\mu} \rightarrow$$

$$x_{cr} = \frac{\mu Re_{cr}}{\rho V} = \frac{(0.891 \times 10^{-3} \text{ kg/m}\cdot\text{s})(5 \times 10^5)}{(997 \text{ kg/m}^3)(8 \text{ m/s})} = 0.056 \text{ m} = \mathbf{5.6 \text{ cm}}$$

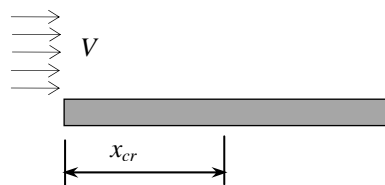

The thickness of the boundary layer at that location is obtained by substituting this value of x into the laminar boundary layer thickness relation,

$$\delta_x = \frac{5x}{Re_x^{1/2}} \rightarrow \delta_{cr} = \frac{5x_{cr}}{Re_{cr}^{1/2}} = \frac{5(0.056 \text{ m})}{(5 \times 10^5)^{1/2}} = 0.00040 \text{ m} = \mathbf{0.4 \text{ mm}}$$

Therefore, the flow becomes turbulent after about 5 cm from the leading edge of the plate, and the thickness of the boundary layer at that location is 0.4 mm.

Discussion When the flow becomes turbulent, the boundary layer thickness starts to increase, and the value of its thickness can be determined from the boundary layer thickness relation for turbulent flow.

7-38 The weight of a thin flat plate exposed to air flow on both sides is balanced by a counterweight. The mass of the counterweight that needs to be added in order to balance the plate is to be determined.

Assumptions 1 The flow is steady and incompressible. **2** The critical Reynolds number is $Re_{cr} = 5 \times 10^5$. **3** Air is an ideal gas. **4** The surfaces of the plate are smooth.

Properties The density and kinematic viscosity of air at 1 atm and 25°C are $\rho = 1.184 \text{ kg/m}^3$ and $\nu = 1.562 \times 10^{-5} \text{ m}^2/\text{s}$ (Table A-15).

Analysis The Reynolds number is

$$Re_L = \frac{VL}{\nu} = \frac{(10 \text{ m/s})(0.4 \text{ m})}{1.562 \times 10^{-5} \text{ m}^2/\text{s}} = 2.561 \times 10^5$$

which is less than the critical Reynolds number of 5×10^5 . Therefore the flow is laminar. The average friction coefficient, drag force and the corresponding mass are

$$C_f = \frac{1.33}{Re_L^{0.5}} = \frac{1.33}{(2.561 \times 10^5)^{0.5}} = 0.002628$$

$$F_D = C_f A_s \frac{\rho V^2}{2} \\ = (0.002628)[(2 \times 0.4 \times 0.4) \text{ m}^2] \frac{(1.184 \text{ kg/m}^3)(10 \text{ m/s})^2}{2} = 0.0498 \text{ kg} \cdot \text{m/s}^2 = 0.0498 \text{ N}$$

The mass whose weight is 0.0497 N is

$$m = \frac{F_D}{g} = \frac{0.0498 \text{ kg} \cdot \text{m/s}^2}{9.81 \text{ m/s}^2} = 0.00508 \text{ kg} = \mathbf{5.08 \text{ g}}$$

Therefore, the mass of the counterweight must be 5 g to counteract the drag force acting on the plate.

Discussion Note that the apparatus described in this problem provides a convenient mechanism to measure drag force and thus drag coefficient.

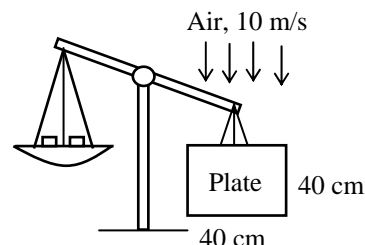

Flow across Cylinders and Spheres

7-39C For the laminar flow, the heat transfer coefficient will be the highest at the stagnation point which corresponds to $\theta \approx 0^\circ$. In turbulent flow, on the other hand, it will be highest when θ is between 90° and 120° .

7-40C Turbulence moves the fluid separation point further back on the rear of the body, reducing the size of the wake, and thus the magnitude of the pressure drag (which is the dominant mode of drag). As a result, the drag coefficient suddenly drops. In general, turbulence increases the drag coefficient for flat surfaces, but the drag coefficient usually remains constant at high Reynolds numbers when the flow is turbulent.

7-41C Friction drag is due to the shear stress at the surface whereas the pressure drag is due to the pressure differential between the front and back sides of the body when a wake is formed in the rear.

7-42C Flow separation in flow over a cylinder is delayed in turbulent flow because of the extra mixing due to random fluctuations and the transverse motion.

7-43 A steam pipe is exposed to windy air. The rate of heat loss from the steam is to be determined. ✓

Assumptions **1** Steady operating conditions exist. **2** Radiation effects are negligible. **3** Air is an ideal gas with constant properties.

Properties The properties of air at 1 atm and the film temperature of $(T_s + T_\infty)/2 = (90+7)/2 = 48.5^\circ\text{C}$ are (Table A-15)

$$k = 0.02724 \text{ W/m}\cdot^\circ\text{C}$$

$$\nu = 1.784 \times 10^{-5} \text{ m}^2/\text{s}$$

$$\text{Pr} = 0.7232$$

Analysis The Reynolds number is

$$\text{Re} = \frac{VD}{\nu} = \frac{[(50 \text{ km/h})(1000 \text{ m/km})/(3600 \text{ s/h})](0.08 \text{ m})}{1.784 \times 10^{-5} \text{ m}^2/\text{s}} = 6.228 \times 10^4$$

The Nusselt number corresponding to this Reynolds number is

$$\begin{aligned} Nu &= \frac{hD}{k} = 0.3 + \frac{0.62 \text{Re}^{0.5} \text{Pr}^{1/3}}{\left[1 + (0.4/\text{Pr})^{2/3}\right]^{1/4}} \left[1 + \left(\frac{\text{Re}}{282,000}\right)^{5/8}\right]^{4/5} \\ &= 0.3 + \frac{0.62(6.228 \times 10^4)^{0.5} (0.7232)^{1/3}}{\left[1 + (0.4/0.7232)^{2/3}\right]^{1/4}} \left[1 + \left(\frac{6.228 \times 10^4}{282,000}\right)^{5/8}\right]^{4/5} = 159.1 \end{aligned}$$

The heat transfer coefficient and the heat transfer rate become

$$h = \frac{k}{D} Nu = \frac{0.02724 \text{ W/m}\cdot^\circ\text{C}}{0.08 \text{ m}} (159.1) = 54.17 \text{ W/m}^2\cdot^\circ\text{C}$$

$$A_s = \pi DL = \pi(0.08 \text{ m})(1 \text{ m}) = 0.2513 \text{ m}^2$$

$$\dot{Q}_{conv} = hA_s(T_s - T_\infty) = (54.17 \text{ W/m}^2\cdot^\circ\text{C})(0.2513 \text{ m}^2)(90 - 7)^\circ\text{C} = \mathbf{1130 \text{ W}} \text{ (per m length)}$$

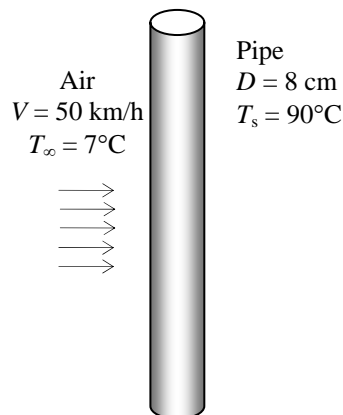

7-44 The wind is blowing across a geothermal water pipe. The average wind velocity is to be determined.

Assumptions **1** Steady operating conditions exist. **2** Radiation effects are negligible. **3** Air is an ideal gas with constant properties. **4** The local atmospheric pressure is 1 atm.

Properties The specific heat of water at the average temperature of 75°C is 4193 J/kg·°C. The properties of air at the film temperature of $(75+15)/2=45^\circ\text{C}$ are (Table A-15)

$$k = 0.02699 \text{ W/m}\cdot^\circ\text{C}$$

$$\nu = 1.75 \times 10^{-5} \text{ m}^2/\text{s}$$

$$\text{Pr} = 0.7241$$

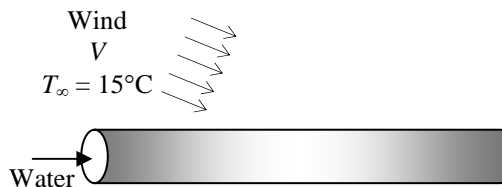

Analysis The rate of heat transfer from the pipe is the energy change of the water from inlet to exit of the pipe, and it can be determined from

$$\dot{Q} = \dot{m}c_p\Delta T = (8.5 \text{ kg/s})(4193 \text{ J/kg}\cdot^\circ\text{C})(80 - 70)^\circ\text{C} = 356,400 \text{ W}$$

The surface area and the heat transfer coefficient are

$$A = \pi DL = \pi(0.15 \text{ m})(400 \text{ m}) = 188.5 \text{ m}^2$$

$$\dot{Q} = hA(T_s - T_\infty) \longrightarrow h = \frac{\dot{Q}}{A(T_s - T_\infty)} = \frac{356,400 \text{ W}}{(188.5 \text{ m}^2)(75 - 15)^\circ\text{C}} = 31.51 \text{ W/m}^2\cdot^\circ\text{C}$$

The Nusselt number is

$$\text{Nu} = \frac{hD}{k} = \frac{(31.51 \text{ W/m}^2\cdot^\circ\text{C})(0.15 \text{ m})}{0.02699 \text{ W/m}\cdot^\circ\text{C}} = 175.1$$

The Reynolds number may be obtained from the Nusselt number relation by trial-error or using an equation solver such as EES:

$$\text{Nu} = 0.3 + \frac{0.62 \text{ Re}^{0.5} \text{ Pr}^{1/3}}{\left[1 + (0.4 / \text{Pr})^{2/3}\right]^{1/4}} \left[1 + \left(\frac{\text{Re}}{282,000}\right)^{5/8}\right]^{4/5}$$

$$175.1 = 0.3 + \frac{0.62 \text{ Re}^{0.5} (0.7241)^{1/3}}{\left[1 + (0.4 / 0.7241)^{2/3}\right]^{1/4}} \left[1 + \left(\frac{\text{Re}}{282,000}\right)^{5/8}\right]^{4/5} \longrightarrow \text{Re} = 71,900$$

The average wind velocity can be determined from Reynolds number relation

$$\text{Re} = \frac{VD}{\nu} \longrightarrow 71,900 = \frac{V(0.15 \text{ m})}{1.75 \times 10^{-5} \text{ m}^2/\text{s}} \longrightarrow V = 8.39 \text{ m/s} = \mathbf{30.2 \text{ km/h}}$$

7-45 A hot stainless steel ball is cooled by forced air. The average convection heat transfer coefficient and the cooling time are to be determined.

Assumptions 1 Steady operating conditions exist. 2 Radiation effects are negligible. 3 Air is an ideal gas with constant properties. 4 The outer surface temperature of the ball is uniform at all times.

Properties The average surface temperature is $(350+250)/2 = 300^\circ\text{C}$, and the properties of air at 1 atm pressure and the free stream temperature of 30°C are (Table A-15)

$$\begin{aligned}k &= 0.02588 \text{ W/m}\cdot^\circ\text{C} \\ \nu &= 1.608 \times 10^{-5} \text{ m}^2/\text{s} \\ \mu_\infty &= 1.872 \times 10^{-5} \text{ kg/m}\cdot\text{s} \\ \mu_{s, @ 300^\circ\text{C}} &= 2.934 \times 10^{-5} \text{ kg/m}\cdot\text{s} \\ \text{Pr} &= 0.7282\end{aligned}$$

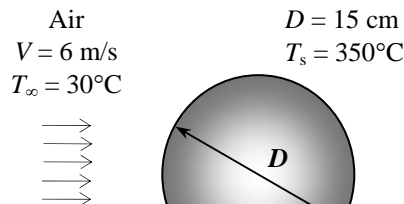

Analysis The Reynolds number is

$$\text{Re} = \frac{VD}{\nu} = \frac{(6 \text{ m/s})(0.15 \text{ m})}{1.608 \times 10^{-5} \text{ m}^2/\text{s}} = 5.597 \times 10^4$$

The Nusselt number corresponding to this Reynolds number is determined to be

$$\begin{aligned}Nu &= \frac{hD}{k} = 2 + \left[0.4 \text{Re}^{0.5} + 0.06 \text{Re}^{2/3} \right] \text{Pr}^{0.4} \left(\frac{\mu_\infty}{\mu_s} \right)^{1/4} \\ &= 2 + \left[0.4(5.597 \times 10^4)^{0.5} + 0.06(5.597 \times 10^4)^{2/3} \right] (0.7282)^{0.4} \left(\frac{1.872 \times 10^{-5}}{2.934 \times 10^{-5}} \right)^{1/4} = 145.6\end{aligned}$$

Heat transfer coefficient is

$$h = \frac{k}{D} Nu = \frac{0.02588 \text{ W/m}\cdot^\circ\text{C}}{0.15 \text{ m}} (145.6) = \mathbf{25.12 \text{ W/m}^2 \cdot ^\circ\text{C}}$$

The average rate of heat transfer can be determined from Newton's law of cooling by using average surface temperature of the ball

$$\begin{aligned}A_s &= \pi D^2 = \pi(0.15 \text{ m})^2 = 0.07069 \text{ m}^2 \\ \dot{Q}_{avg} &= hA_s(T_s - T_\infty) = (25.12 \text{ W/m}^2 \cdot ^\circ\text{C})(0.07069 \text{ m}^2)(300 - 30)^\circ\text{C} = 479.5 \text{ W}\end{aligned}$$

Assuming the ball temperature to be nearly uniform, the total heat transferred from the ball during the cooling from 350°C to 250°C can be determined from

$$Q_{total} = mc_p(T_1 - T_2)$$

$$\text{where } m = \rho V = \rho \frac{\pi D^3}{6} = (8055 \text{ kg/m}^3) \frac{\pi(0.15 \text{ m})^3}{6} = 14.23 \text{ kg}$$

$$\text{Therefore, } Q_{total} = mc_p(T_1 - T_2) = (14.23 \text{ kg})(480 \text{ J/kg}\cdot^\circ\text{C})(350 - 250)^\circ\text{C} = 683,250 \text{ J}$$

Then the time of cooling becomes

$$\Delta t = \frac{Q}{\dot{Q}_{avg}} = \frac{683,250 \text{ J}}{479.5 \text{ J/s}} = 1425 \text{ s} = \mathbf{23.7 \text{ min}}$$

7-46 EES Prob. 7-45 is reconsidered. The effect of air velocity on the average convection heat transfer coefficient and the cooling time is to be investigated.

Analysis The problem is solved using EES, and the solution is given below.

"GIVEN"

$$D=0.15 \text{ [m]}$$

$$T_1=350 \text{ [C]}$$

$$T_2=250 \text{ [C]}$$

$$T_{\infty}=30 \text{ [C]}$$

$$P=101.3 \text{ [kPa]}$$

$$\text{Vel}=6 \text{ [m/s]}$$

$$\rho_{\text{ball}}=8055 \text{ [kg/m}^3\text{]}$$

$$C_{p,\text{ball}}=480 \text{ [J/kg-C]}$$

"PROPERTIES"

$$\text{Fluid}=\text{'air'}$$

$$k=\text{Conductivity}(\text{Fluid}, T=T_{\infty})$$

$$\text{Pr}=\text{Prandtl}(\text{Fluid}, T=T_{\infty})$$

$$\rho=\text{Density}(\text{Fluid}, T=T_{\infty}, P=P)$$

$$\mu_{\infty}=\text{Viscosity}(\text{Fluid}, T=T_{\infty})$$

$$\text{nu}=\mu_{\infty}/\rho$$

$$\mu_s=\text{Viscosity}(\text{Fluid}, T=T_{s,\text{ave}})$$

$$T_{s,\text{ave}}=1/2*(T_1+T_2)$$

"ANALYSIS"

$$\text{Re}=(\text{Vel}*D)/\text{nu}$$

$$\text{Nusselt}=2+(0.4*\text{Re}^{0.5}+0.06*\text{Re}^{2/3})*\text{Pr}^{0.4}*(\mu_{\infty}/\mu_s)^{0.25}$$

$$h=k/D*\text{Nusselt}$$

$$A=\pi*D^2$$

$$Q_{\text{dot,ave}}=h*A*(T_{s,\text{ave}}-T_{\infty})$$

$$Q_{\text{total}}=m_{\text{ball}}*C_{p,\text{ball}}*(T_1-T_2)$$

$$m_{\text{ball}}=\rho_{\text{ball}}*V_{\text{ball}}$$

$$V_{\text{ball}}=(\pi*D^3)/6$$

$$\text{time}=Q_{\text{total}}/Q_{\text{dot,ave}}*\text{Convert}(\text{s}, \text{min})$$

Vel [m/s]	h [W/m ² .C]	time [min]
1	9.204	64.83
1.5	11.5	51.86
2	13.5	44.2
2.5	15.29	39.01
3	16.95	35.21
3.5	18.49	32.27
4	19.94	29.92
4.5	21.32	27.99
5	22.64	26.36
5.5	23.9	24.96
6	25.12	23.75
6.5	26.3	22.69
7	27.44	21.74
7.5	28.55	20.9
8	29.63	20.14
8.5	30.69	19.44
9	31.71	18.81
9.5	32.72	18.24
10	33.7	17.7

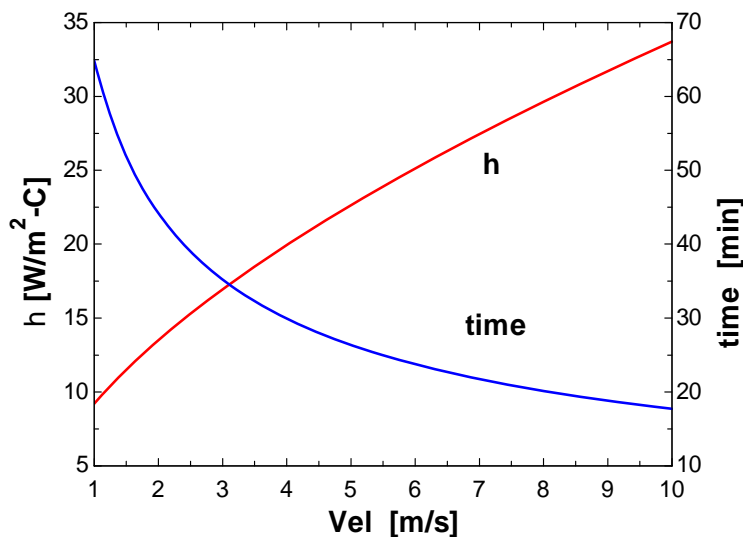

7-47E A person extends his uncovered arms into the windy air outside. The rate of heat loss from the arm is to be determined.

Assumptions 1 Steady operating conditions exist. 2 Radiation effects are negligible. 3 Air is an ideal gas with constant properties. 4 The arm is treated as a 2-ft-long and 3-in-diameter cylinder with insulated ends. 5 The local atmospheric pressure is 1 atm.

Properties The properties of air at 1 atm and the film temperature of $(T_s + T_\infty)/2 = (86+54)/2 = 70^\circ\text{F}$ are (Table A-15E)

$$k = 0.01457 \text{ Btu/h}\cdot\text{ft}\cdot^\circ\text{F}$$

$$\nu = 0.1643 \times 10^{-3} \text{ ft}^2/\text{s}$$

$$\text{Pr} = 0.7306$$

Analysis The Reynolds number is

$$\text{Re} = \frac{VD}{\nu} = \frac{[(20 \times 5280/3600) \text{ ft/s}](3/12) \text{ ft}}{0.1643 \times 10^{-3} \text{ ft}^2/\text{s}} = 4.463 \times 10^4$$

The Nusselt number corresponding to this Reynolds number is determined to be

$$\begin{aligned} Nu &= \frac{hD}{k} = 0.3 + \frac{0.62 \text{Re}^{0.5} \text{Pr}^{1/3}}{\left[1 + \left(\frac{0.4}{\text{Pr}}\right)^{2/3}\right]^{1/4}} \left[1 + \left(\frac{\text{Re}}{282,000}\right)^{5/8}\right]^{4/5} \\ &= 0.3 + \frac{0.62(4.463 \times 10^4)^{0.5} (0.7306)^{1/3}}{\left[1 + \left(\frac{0.4}{0.7306}\right)^{2/3}\right]^{1/4}} \left[1 + \left(\frac{4.463 \times 10^4}{282,000}\right)^{5/8}\right]^{4/5} = 129.6 \end{aligned}$$

Then the heat transfer coefficient and the heat transfer rate from the arm becomes

$$h = \frac{k}{D} Nu = \frac{0.01457 \text{ Btu/h}\cdot\text{ft}\cdot^\circ\text{F}}{(3/12) \text{ ft}} (129.6) = 7.557 \text{ Btu/h}\cdot\text{ft}^2\cdot^\circ\text{F}$$

$$A_s = \pi DL = \pi(3/12 \text{ ft})(2 \text{ ft}) = 1.571 \text{ ft}^2$$

$$\dot{Q}_{conv} = hA_s(T_s - T_\infty) = (7.557 \text{ Btu/h}\cdot\text{ft}^2\cdot^\circ\text{F})(1.571 \text{ ft}^2)(86 - 54)^\circ\text{F} = \mathbf{380 \text{ Btu/h}}$$

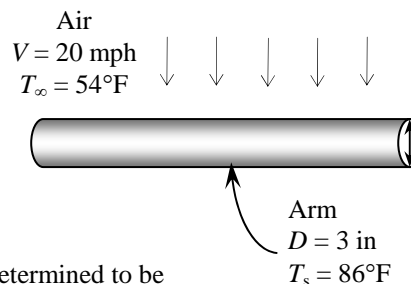

7-48E EES Prob. 7-47E is reconsidered. The effects of air temperature and wind velocity on the rate of heat loss from the arm are to be investigated.

Analysis The problem is solved using EES, and the solution is given below.

"GIVEN"

T_infinity=54 [F]

Vel=20 [mph]

T_s=86 [F]

L=2 [ft]

D=3/12 [ft]

"PROPERTIES"

Fluid\$='air'

k=Conductivity(Fluid\$, T=T_film)

Pr=Prandtl(Fluid\$, T=T_film)

rho=Density(Fluid\$, T=T_film, P=14.7)

mu=Viscosity(Fluid\$, T=T_film)*Convert(lbm/ft-h, lbm/ft-s)

nu=mu/rho

T_film=1/2*(T_s+T_infinity)

"ANALYSIS"

Re=(Vel*Convert(mph, ft/s)*D)/nu

Nusselt=0.3+(0.62*Re^{0.5}*Pr^(1/3))/(1+(0.4/Pr)^(2/3))^{0.25}*(1+(Re/282000)^(5/8))^(4/5)

h=k/D*Nusselt

A=pi*D*L

Q_dot_conv=h*A*(T_s-T_infinity)

T _∞ [F]	Q _{conv} [Btu/h]
20	790.2
25	729.4
30	668.7
35	608.2
40	547.9
45	487.7
50	427.7
55	367.9
60	308.2
65	248.6
70	189.2
75	129.9
80	70.77

Vel [mph]	Q _{conv} [Btu/h]
10	250.6
12	278.9
14	305.7
16	331.3
18	356
20	379.8
22	403
24	425.6
26	447.7

28	469.3
30	490.5
32	511.4
34	532
36	552.2
38	572.2
40	591.9

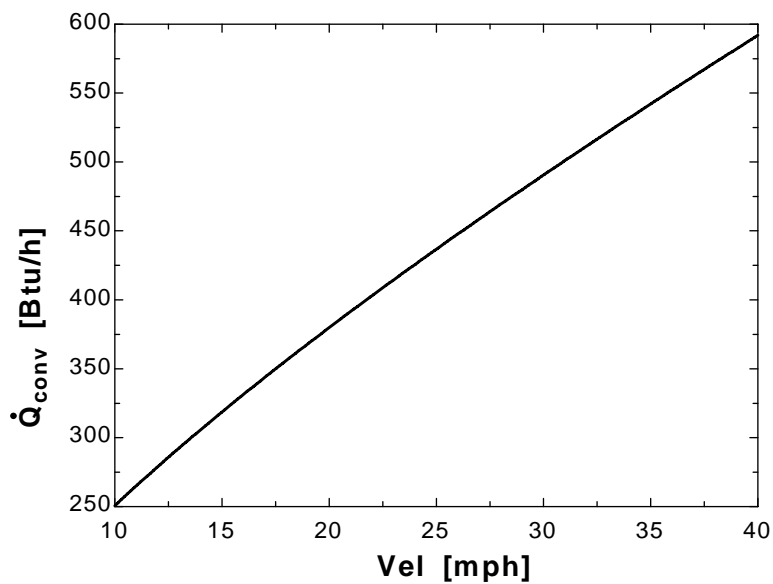
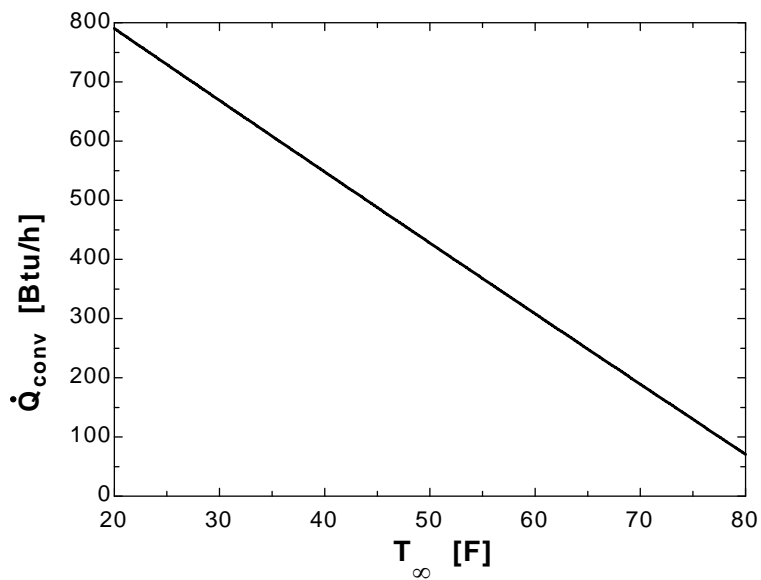

7-49 The average surface temperature of the head of a person when it is not covered and is subjected to winds is to be determined.

Assumptions **1** Steady operating conditions exist. **2** Radiation effects are negligible. **3** Air is an ideal gas with constant properties. **4** One-quarter of the heat the person generates is lost from the head. **5** The head can be approximated as a 30-cm-diameter sphere. **6** The local atmospheric pressure is 1 atm.

Properties We assume the surface temperature to be 15°C for viscosity. The properties of air at 1 atm pressure and the free stream temperature of 10°C are (Table A-15)

$$\begin{aligned}k &= 0.02439 \text{ W/m}\cdot\text{°C} \\ \nu &= 1.426 \times 10^{-5} \text{ m}^2/\text{s} \\ \mu_{\infty} &= 1.778 \times 10^{-5} \text{ kg/m}\cdot\text{s} \\ \mu_{s, @ 15^{\circ}\text{C}} &= 1.802 \times 10^{-5} \text{ kg/m}\cdot\text{s} \\ \text{Pr} &= 0.7336\end{aligned}$$

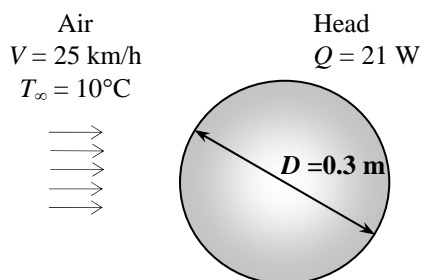

Analysis The Reynolds number is

$$\text{Re} = \frac{VD}{\nu} = \frac{[(25 \times 1000/3600) \text{ m/s}](0.3 \text{ m})}{1.426 \times 10^{-5} \text{ m}^2/\text{s}} = 1.461 \times 10^5$$

The proper relation for Nusselt number corresponding to this Reynolds number is

$$\begin{aligned}Nu &= \frac{hD}{k} = 2 + \left[0.4 \text{Re}^{0.5} + 0.06 \text{Re}^{2/3} \right] \text{Pr}^{0.4} \left(\frac{\mu_{\infty}}{\mu_s} \right)^{1/4} \\ &= 2 + \left[0.4(1.461 \times 10^5)^{0.5} + 0.06(1.461 \times 10^5)^{2/3} \right] (0.7336)^{0.4} \left(\frac{1.778 \times 10^{-5}}{1.802 \times 10^{-5}} \right)^{1/4} = 283.2\end{aligned}$$

The heat transfer coefficient is

$$h = \frac{k}{D} Nu = \frac{0.02439 \text{ W/m}\cdot\text{°C}}{0.3 \text{ m}} (283.2) = 23.02 \text{ W/m}^2\cdot\text{°C}$$

Then the surface temperature of the head is determined to be

$$\begin{aligned}A_s &= \pi D^2 = \pi (0.3 \text{ m})^2 = 0.2827 \text{ m}^2 \\ \dot{Q} &= hA_s(T_s - T_{\infty}) \longrightarrow T_s = T_{\infty} + \frac{\dot{Q}}{hA_s} = 10^{\circ}\text{C} + \frac{(84/4) \text{ W}}{(23.02 \text{ W/m}^2\cdot\text{°C})(0.2827 \text{ m}^2)} = 13.2^{\circ}\text{C}\end{aligned}$$

7-50 The flow of a fluid across an isothermal cylinder is considered. The change in the drag force and the rate of heat transfer when the free-stream velocity of the fluid is doubled is to be determined.

Analysis The drag force on a cylinder is given by

$$F_{D1} = C_D A_N \frac{\rho V^2}{2}$$

When the free-stream velocity of the fluid is doubled, the drag force becomes

$$F_{D2} = C_D A_N \frac{\rho(2V)^2}{2}$$

Taking the ratio of them yields

$$\frac{F_{D2}}{F_{D1}} = \frac{(2V)^2}{V^2} = \mathbf{4}$$

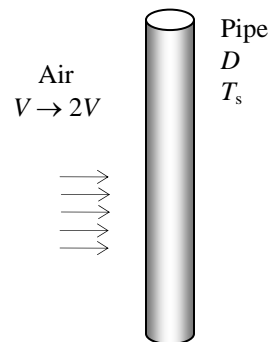

The rate of heat transfer between the fluid and the cylinder is given by Newton's law of cooling. We assume the Nusselt number is proportional to the n th power of the Reynolds number with $0.33 < n < 0.805$. Then,

$$\begin{aligned} \dot{Q}_1 &= h A_s (T_s - T_\infty) = \left(\frac{k}{D} Nu \right) A_s (T_s - T_\infty) = \frac{k}{D} (\text{Re})^n A_s (T_s - T_\infty) \\ &= \frac{k}{D} \left(\frac{VD}{\nu} \right)^n A_s (T_s - T_\infty) \\ &= V^n \frac{k}{D} \left(\frac{D}{\nu} \right)^n A_s (T_s - T_\infty) \end{aligned}$$

When the free-stream velocity of the fluid is doubled, the heat transfer rate becomes

$$\dot{Q}_2 = (2V)^n \frac{k}{D} \left(\frac{D}{\nu} \right)^n A_s (T_s - T_\infty)$$

Taking the ratio of them yields

$$\frac{\dot{Q}_2}{\dot{Q}_1} = \frac{(2V)^n}{V^n} = \mathbf{2^n}$$

7-51 The wind is blowing across the wire of a transmission line. The surface temperature of the wire is to be determined.

Assumptions **1** Steady operating conditions exist. **2** Radiation effects are negligible. **3** Air is an ideal gas with constant properties. **4** The local atmospheric pressure is 1 atm.

Properties We assume the film temperature to be 10°C. The properties of air at this temperature are (Table A-15)

$$\begin{aligned}\rho &= 1.246 \text{ kg/m}^3 \\ k &= 0.02439 \text{ W/m}\cdot\text{°C} \\ \nu &= 1.426 \times 10^{-5} \text{ m}^2/\text{s} \\ \text{Pr} &= 0.7336\end{aligned}$$

Analysis The Reynolds number is

$$\text{Re} = \frac{VD}{\nu} = \frac{[(40 \times 1000/3600) \text{ m/s}](0.006 \text{ m})}{1.426 \times 10^{-5} \text{ m}^2/\text{s}} = 4675$$

The Nusselt number corresponding to this Reynolds number is determined to be

$$\begin{aligned}Nu &= \frac{hD}{k} = 0.3 + \frac{0.62 \text{ Re}^{0.5} \text{ Pr}^{1/3}}{\left[1 + (0.4/\text{Pr})^{2/3}\right]^{1/4}} \left[1 + \left(\frac{\text{Re}}{282,000}\right)^{5/8}\right]^{4/5} \\ &= 0.3 + \frac{0.62(4675)^{0.5} (0.7336)^{1/3}}{\left[1 + (0.4/0.7336)^{2/3}\right]^{1/4}} \left[1 + \left(\frac{4675}{282,000}\right)^{5/8}\right]^{4/5} = 36.0\end{aligned}$$

The heat transfer coefficient is

$$h = \frac{k}{D} Nu = \frac{0.02439 \text{ W/m}\cdot\text{°C}}{0.006 \text{ m}} (36.0) = 146.3 \text{ W/m}^2\cdot\text{°C}$$

The rate of heat generated in the electrical transmission lines per meter length is

$$\dot{W} = \dot{Q} = I^2 R = (50 \text{ A})^2 (0.002 \text{ Ohm}) = 5.0 \text{ W}$$

The entire heat generated in electrical transmission line has to be transferred to the ambient air. The surface temperature of the wire then becomes

$$\begin{aligned}A_s &= \pi DL = \pi(0.006 \text{ m})(1 \text{ m}) = 0.01885 \text{ m}^2 \\ \dot{Q} &= hA_s(T_s - T_\infty) \longrightarrow T_s = T_\infty + \frac{\dot{Q}}{hA_s} = 10^\circ\text{C} + \frac{5 \text{ W}}{(146.3 \text{ W/m}^2\cdot\text{°C})(0.01885 \text{ m}^2)} = \mathbf{11.8^\circ\text{C}}\end{aligned}$$

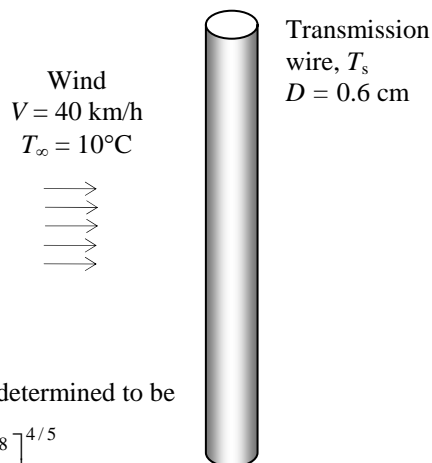

7-52 EES Prob. 7-51 is reconsidered. The effect of the wind velocity on the surface temperature of the wire is to be investigated.

Analysis The problem is solved using EES, and the solution is given below.

"GIVEN"

D=0.006 [m]
 L=1 [m] "unit length is considered"
 I=50 [Ampere]
 R=0.002 [Ohm]
 T_infinity=10 [C]
 Vel=40 [km/h]

"PROPERTIES"

Fluid\$='air'
 k=Conductivity(Fluid\$, T=T_film)
 Pr=Prandtl(Fluid\$, T=T_film)
 rho=Density(Fluid\$, T=T_film, P=101.3)
 mu=Viscosity(Fluid\$, T=T_film)
 nu=mu/rho
 T_film=1/2*(T_s+T_infinity)

"ANALYSIS"

Re=(Vel*Convert(km/h, m/s)*D)/nu
 Nusselt=0.3+(0.62*Re^{0.5}*Pr^(1/3))/(1+(0.4/Pr)^(2/3))^{0.25}*(1+(Re/282000)^(5/8))^(4/5)
 h=k/D*Nusselt
 W_dot=I²*R
 Q_dot=W_dot
 A=pi*D*L
 Q_dot=h*A*(T_s-T_infinity)

Vel [km/h]	T _s [C]
10	13.72
15	13.02
20	12.61
25	12.32
30	12.11
35	11.95
40	11.81
45	11.7
50	11.61
55	11.53
60	11.46
65	11.4
70	11.34
75	11.29
80	11.25

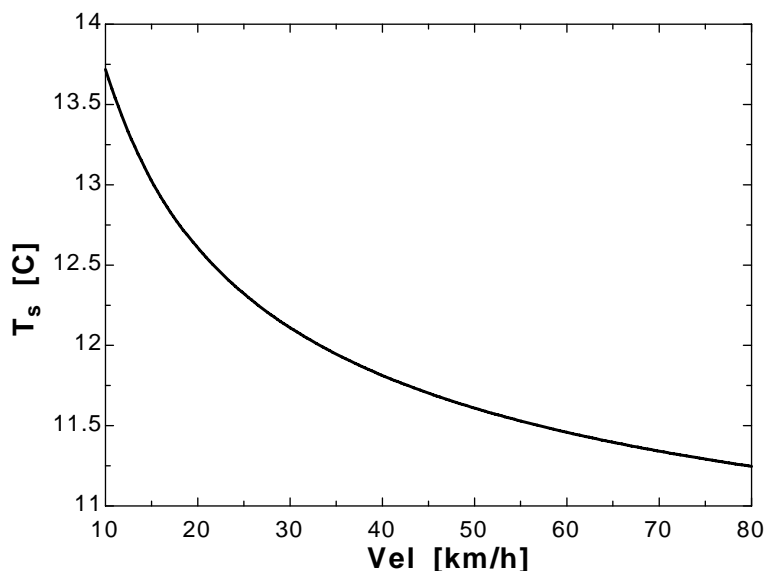

7-53 An aircraft is cruising at 900 km/h. A heating system keeps the wings above freezing temperatures. The average convection heat transfer coefficient on the wing surface and the average rate of heat transfer per unit surface area are to be determined.

Assumptions **1** Steady operating conditions exist. **2** Radiation effects are negligible. **3** Air is an ideal gas with constant properties. **4** The wing is approximated as a cylinder of elliptical cross section whose minor axis is 50 cm.

Properties The properties of air at 1 atm and the film temperature of $(T_s + T_\infty)/2 = (0 - 55.4)/2 = -27.7^\circ\text{C}$ are (Table A-15)

$$k = 0.02152 \text{ W/m}\cdot^\circ\text{C}$$

$$\nu = 1.106 \times 10^{-5} \text{ m}^2/\text{s}$$

$$\text{Pr} = 0.7421$$

Note that the atmospheric pressure will only affect the kinematic viscosity. The atmospheric pressure in atm unit is

$$P = (18.8 \text{ kPa}) \frac{1 \text{ atm}}{101.325 \text{ kPa}} = 0.1855 \text{ atm}$$

The kinematic viscosity at this atmospheric pressure is

$$\nu = (1.106 \times 10^{-5} \text{ m}^2/\text{s})/0.1855 = 5.961 \times 10^{-5} \text{ m}^2/\text{s}$$

Analysis The Reynolds number is

$$\text{Re} = \frac{VD}{\nu} = \frac{[(900 \times 1000/3600) \text{ m/s}](0.5 \text{ m})}{5.961 \times 10^{-5} \text{ m}^2/\text{s}} = 2.097 \times 10^6$$

The Nusselt number relation for a cylinder of elliptical cross-section is limited to $\text{Re} < 15,000$, and the relation below is not really applicable in this case. However, this relation is all we have for elliptical shapes, and we will use it with the understanding that the results may not be accurate.

$$\text{Nu} = \frac{hD}{k} = 0.248 \text{Re}^{0.612} \text{Pr}^{1/3} = 0.248(2.097 \times 10^6)^{0.612} (0.7241)^{1/3} = 1660$$

The average heat transfer coefficient on the wing surface is

$$h = \frac{k}{D} \text{Nu} = \frac{0.02152 \text{ W/m}\cdot^\circ\text{C}}{0.5 \text{ m}} (1660) = \mathbf{71.45 \text{ W/m}^2 \cdot ^\circ\text{C}}$$

Then the average rate of heat transfer per unit surface area becomes

$$\dot{q} = h(T_s - T_\infty) = (71.45 \text{ W/m}^2 \cdot ^\circ\text{C})[0 - (-55.4)]^\circ\text{C} = \mathbf{3958 \text{ W/m}^2}$$

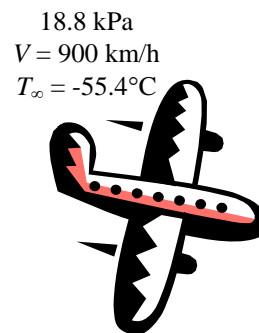

7-54 A long aluminum wire is cooled by cross air flowing over it. The rate of heat transfer from the wire per meter length when it is first exposed to the air is to be determined.

Assumptions **1** Steady operating conditions exist. **2** Radiation effects are negligible. **3** Air is an ideal gas with constant properties. **4** The local atmospheric pressure is 1 atm.

Properties The properties of air at 1 atm and the film temperature of $(T_s + T_\infty)/2 = (370+30)/2 = 200^\circ\text{C}$ are (Table A-15)

$$k = 0.03779 \text{ W/m}\cdot^\circ\text{C}$$

$$\nu = 3.455 \times 10^{-5} \text{ m}^2/\text{s}$$

$$\text{Pr} = 0.6974$$

Analysis The Reynolds number is

$$\text{Re} = \frac{VD}{\nu} = \frac{(6 \text{ m/s})(0.003 \text{ m})}{3.455 \times 10^{-5} \text{ m}^2/\text{s}} = 521.0$$

The Nusselt number corresponding to this Reynolds number is determined to be

$$\begin{aligned} Nu &= \frac{hD}{k} = 0.3 + \frac{0.62 \text{Re}^{0.5} \text{Pr}^{1/3}}{\left[1 + (0.4/\text{Pr})^{2/3}\right]^{1/4}} \left[1 + \left(\frac{\text{Re}}{282,000}\right)^{5/8}\right]^{4/5} \\ &= 0.3 + \frac{0.62(521.0)^{0.5} (0.6974)^{1/3}}{\left[1 + (0.4/0.6974)^{2/3}\right]^{1/4}} \left[1 + \left(\frac{521.0}{282,000}\right)^{5/8}\right]^{4/5} = 11.48 \end{aligned}$$

Then the heat transfer coefficient and the heat transfer rate from the wire per meter length become

$$h = \frac{k}{D} Nu = \frac{0.03779 \text{ W/m}\cdot^\circ\text{C}}{0.003 \text{ m}} (11.48) = 144.6 \text{ W/m}^2\cdot^\circ\text{C}$$

$$A_s = \pi DL = \pi(0.003 \text{ m})(1 \text{ m}) = 0.009425 \text{ m}^2$$

$$\dot{Q}_{conv} = hA_s(T_s - T_\infty) = (144.6 \text{ W/m}^2\cdot^\circ\text{C})(0.009425 \text{ m}^2)(370 - 30)^\circ\text{C} = \mathbf{463 \text{ W}}$$

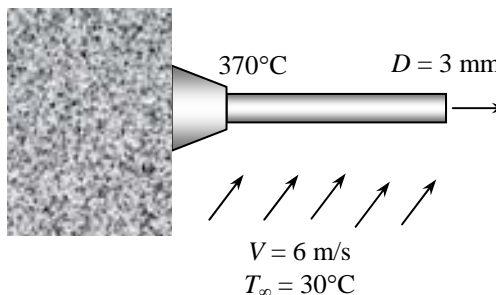

7-55E A fan is blowing air over the entire body of a person. The average temperature of the outer surface of the person is to be determined for two cases.

Assumptions 1 Steady operating conditions exist. 2 Radiation effects are negligible. 3 Air is an ideal gas with constant properties. 4 The average human body can be treated as a 1-ft-diameter cylinder with an exposed surface area of 18 ft². 5 The local atmospheric pressure is 1 atm.

Properties We assume the film temperature to be 100°F.

The properties of air at this temperature are (Table A-15E)

$$k = 0.01529 \text{ Btu/h}\cdot\text{ft}\cdot^\circ\text{F}$$

$$\nu = 1.809 \times 10^{-4} \text{ ft}^2/\text{s}$$

$$\text{Pr} = 0.7260$$

$$V = 6 \text{ ft/s}$$

$$T_\infty = 85^\circ\text{F}$$

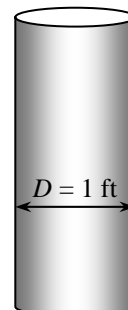

Person, T_s
300 Btu/h

Analysis The Reynolds number is

$$\text{Re} = \frac{VD}{\nu} = \frac{(6 \text{ ft/s})(1 \text{ ft})}{1.809 \times 10^{-4} \text{ ft}^2/\text{s}} = 3.317 \times 10^4$$

The proper relation for Nusselt number corresponding to this Reynolds number is

$$\begin{aligned} \text{Nu} = \frac{hD}{k} &= 0.3 + \frac{0.62 \text{Re}^{0.5} \text{Pr}^{1/3}}{\left[1 + (0.4/\text{Pr})^{2/3}\right]^{1/4}} \left[1 + \left(\frac{\text{Re}}{282,000}\right)^{5/8}\right]^{4/5} \\ &= 0.3 + \frac{0.62(3.317 \times 10^4)^{0.5} (0.7260)^{1/3}}{\left[1 + (0.4/0.7260)^{2/3}\right]^{1/4}} \left[1 + \left(\frac{3.317 \times 10^4}{282,000}\right)^{5/8}\right]^{4/5} = 107.8 \end{aligned}$$

The heat transfer coefficient is

$$h = \frac{k}{D} \text{Nu} = \frac{0.01529 \text{ Btu/h}\cdot\text{ft}\cdot^\circ\text{F}}{1 \text{ ft}} (107.8) = 1.649 \text{ Btu/h}\cdot\text{ft}^2\cdot^\circ\text{F}$$

Then the average temperature of the outer surface of the person becomes

$$\dot{Q} = hA_s(T_s - T_\infty) \rightarrow T_s = T_\infty + \frac{\dot{Q}}{hA_s} = 85^\circ\text{F} + \frac{300 \text{ Btu/h}}{(1.649 \text{ Btu/h}\cdot\text{ft}^2\cdot^\circ\text{F})(18 \text{ ft}^2)} = \mathbf{95.1^\circ\text{F}}$$

If the air velocity were doubled, the Reynolds number would be

$$\text{Re} = \frac{VD}{\nu} = \frac{(12 \text{ ft/s})(1 \text{ ft})}{1.809 \times 10^{-4} \text{ ft}^2/\text{s}} = 6.633 \times 10^4$$

The proper relation for Nusselt number corresponding to this Reynolds number is

$$\begin{aligned} \text{Nu} = \frac{hD}{k} &= 0.3 + \frac{0.62 \text{Re}^{0.5} \text{Pr}^{1/3}}{\left[1 + (0.4/\text{Pr})^{2/3}\right]^{1/4}} \left[1 + \left(\frac{\text{Re}}{282,000}\right)^{5/8}\right]^{4/5} \\ &= 0.3 + \frac{0.62(6.633 \times 10^4)^{0.5} (0.7260)^{1/3}}{\left[1 + (0.4/0.7260)^{2/3}\right]^{1/4}} \left[1 + \left(\frac{6.633 \times 10^4}{282,000}\right)^{5/8}\right]^{4/5} = 165.9 \end{aligned}$$

Heat transfer coefficient is

$$h = \frac{k}{D} \text{Nu} = \frac{0.01529 \text{ Btu/h}\cdot\text{ft}\cdot^\circ\text{F}}{1 \text{ ft}} (165.9) = 2.537 \text{ Btu/h}\cdot\text{ft}^2\cdot^\circ\text{F}$$

Then the average temperature of the outer surface of the person becomes

$$\dot{Q} = hA_s(T_s - T_\infty) \rightarrow T_s = T_\infty + \frac{\dot{Q}}{hA_s} = 85^\circ\text{F} + \frac{300 \text{ Btu/h}}{(2.537 \text{ Btu/h}\cdot\text{ft}^2\cdot^\circ\text{F})(18 \text{ ft}^2)} = \mathbf{91.6^\circ\text{F}}$$

7-56 A light bulb is cooled by a fan. The equilibrium temperature of the glass bulb is to be determined.

Assumptions **1** Steady operating conditions exist. **2** Air is an ideal gas with constant properties. **3** The light bulb is in spherical shape. **4** The local atmospheric pressure is 1 atm.

Properties We assume the surface temperature to be 100°C for viscosity. The properties of air at 1 atm pressure and the free stream temperature of 30°C are (Table A-15)

$$\begin{aligned}k &= 0.02588 \text{ W/m}\cdot\text{°C} \\ \nu &= 1.608 \times 10^{-5} \text{ m}^2/\text{s} \\ \mu_\infty &= 1.872 \times 10^{-5} \text{ kg/m}\cdot\text{s} \\ \mu_{s, @ 100^\circ\text{C}} &= 2.181 \times 10^{-5} \text{ kg/m}\cdot\text{s} \\ \text{Pr} &= 0.7282\end{aligned}$$

Analysis The Reynolds number is

$$\text{Re} = \frac{VD}{\nu} = \frac{(2 \text{ m/s})(0.1 \text{ m})}{1.608 \times 10^{-5} \text{ m}^2/\text{s}} = 1.244 \times 10^4$$

The proper relation for Nusselt number corresponding to this Reynolds number is

$$\begin{aligned}Nu &= \frac{hD}{k} = 2 + \left[0.4 \text{Re}^{0.5} + 0.06 \text{Re}^{2/3} \right] \text{Pr}^{0.4} \left(\frac{\mu_\infty}{\mu_s} \right)^{1/4} \\ &= 2 + \left[0.4(1.244 \times 10^4)^{0.5} + 0.06(1.244 \times 10^4)^{2/3} \right] (0.7282)^{0.4} \left(\frac{1.872 \times 10^{-5}}{2.181 \times 10^{-5}} \right)^{1/4} = 67.14\end{aligned}$$

The heat transfer coefficient is

$$h = \frac{k}{D} Nu = \frac{0.02588 \text{ W/m}\cdot\text{°C}}{0.1 \text{ m}} (67.14) = 17.37 \text{ W/m}^2\cdot\text{°C}$$

Noting that 90 % of electrical energy is converted to heat,

$$\dot{Q} = (0.90)(100 \text{ W}) = 90 \text{ W}$$

The bulb loses heat by both convection and radiation. The equilibrium temperature of the glass bulb can be determined by iteration or by an equation solver:

$$\begin{aligned}A_s &= \pi D^2 = \pi(0.1 \text{ m})^2 = 0.0314 \text{ m}^2 \\ \dot{Q}_{\text{total}} &= \dot{Q}_{\text{conv}} + \dot{Q}_{\text{rad}} = hA_s(T_s - T_\infty) + \varepsilon A_s \sigma (T_s^4 - T_{\text{surr}}^4) \\ 90 \text{ W} &= (17.37 \text{ W/m}^2\cdot\text{°C})(0.0314 \text{ m}^2) [T_s - (30 + 273)\text{K}] \\ &\quad + (0.9)(0.0314 \text{ m}^2)(5.67 \times 10^{-8} \text{ W/m}^2\cdot\text{K}^4) [T_s^4 - (30 + 273 \text{ K})^4] \\ T_s &= 409.9 \text{ K} = \mathbf{136.9^\circ\text{C}}\end{aligned}$$

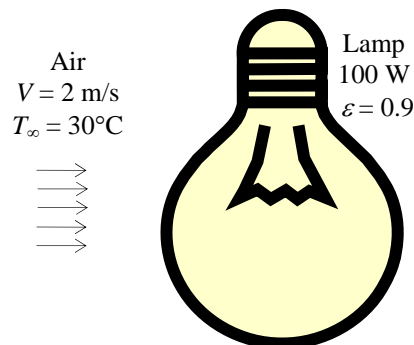

7-57 A steam pipe is exposed to a light winds in the atmosphere. The amount of heat loss from the steam during a certain period and the money the facility will save a year as a result of insulating the steam pipe are to be determined.

Assumptions 1 Steady operating conditions exist. 2 Air is an ideal gas with constant properties. 3 The plant operates every day of the year for 10 h a day. 4 The local atmospheric pressure is 1 atm.

Properties The properties of air at 1 atm and the film temperature of

$(T_s + T_\infty)/2 = (75+5)/2 = 40^\circ\text{C}$ are (Table A-15)

$$k = 0.02662 \text{ W/m}\cdot^\circ\text{C}$$

$$\nu = 1.702 \times 10^{-5} \text{ m}^2/\text{s}$$

$$\text{Pr} = 0.7255$$

Analysis The Reynolds number is

$$\text{Re} = \frac{VD}{\nu} = \frac{[(10 \times 1000/3600) \text{ m/s}](0.1 \text{ m})}{1.702 \times 10^{-5} \text{ m}^2/\text{s}} = 1.632 \times 10^4$$

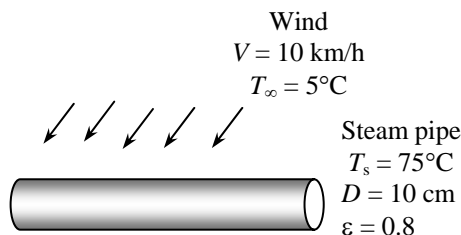

The Nusselt number corresponding to this Reynolds number is determined to be

$$\begin{aligned} \text{Nu} &= \frac{hD}{k} = 0.3 + \frac{0.62 \text{Re}^{0.5} \text{Pr}^{1/3}}{\left[1 + (0.4/\text{Pr})^{2/3}\right]^{1/4}} \left[1 + \left(\frac{\text{Re}}{282,000}\right)^{5/8}\right]^{4/5} \\ &= 0.3 + \frac{0.62(1.632 \times 10^4)^{0.5} (0.7255)^{1/3}}{\left[1 + (0.4/0.7255)^{2/3}\right]^{1/4}} \left[1 + \left(\frac{1.632 \times 10^4}{282,000}\right)^{5/8}\right]^{4/5} = 71.19 \end{aligned}$$

The heat transfer coefficient is

$$h = \frac{k}{D} \text{Nu} = \frac{0.02662 \text{ W/m}\cdot^\circ\text{C}}{0.1 \text{ m}} (71.19) = 18.95 \text{ W/m}^2\cdot^\circ\text{C}$$

The rate of heat loss by convection is

$$A_s = \pi DL = \pi(0.1 \text{ m})(12 \text{ m}) = 3.77 \text{ m}^2$$

$$\dot{Q}_{conv} = hA_s(T_s - T_\infty) = (18.95 \text{ W/m}^2\cdot^\circ\text{C})(3.77 \text{ m}^2)(75 - 5)^\circ\text{C} = 5001 \text{ W}$$

The rate of heat loss by radiation is

$$\begin{aligned} \dot{Q}_{rad} &= \varepsilon A_s \sigma (T_s^4 - T_{surr}^4) \\ &= (0.8)(3.77 \text{ m}^2)(5.67 \times 10^{-8} \text{ W/m}^2\cdot\text{K}^4) \left[(75 + 273 \text{ K})^4 - (0 + 273 \text{ K})^4 \right] = 1558 \text{ W} \end{aligned}$$

The total rate of heat loss then becomes

$$\dot{Q}_{total} = \dot{Q}_{conv} + \dot{Q}_{rad} = 5001 + 1558 = 6559 \text{ W}$$

The amount of heat loss from the steam during a 10-hour work day is

$$Q = \dot{Q}_{total} \Delta t = (6.559 \text{ kJ/s})(10 \text{ h/day} \times 3600 \text{ s/h}) = \mathbf{2.361 \times 10^5 \text{ kJ/day}}$$

The total amount of heat loss from the steam per year is

$$Q_{total} = \dot{Q}_{day} (\text{no. of days}) = (2.361 \times 10^5 \text{ kJ/day})(365 \text{ days/yr}) = 8.619 \times 10^7 \text{ kJ/yr}$$

Noting that the steam generator has an efficiency of 80%, the amount of gas used is

$$Q_{gas} = \frac{Q_{total}}{0.80} = \frac{8.619 \times 10^7 \text{ kJ/yr}}{0.80} \left(\frac{1 \text{ therm}}{105,500 \text{ kJ}} \right) = 1021 \text{ therms/yr}$$

Insulation reduces this amount by 90%. The amount of energy and money saved becomes

$$\text{Energy saved} = (0.90)Q_{gas} = (0.90)(1021 \text{ therms/yr}) = 919 \text{ therms/yr}$$

$$\text{Money saved} = (\text{Energy saved})(\text{Unit cost of energy}) = (919 \text{ therms/yr})(\$1.05/\text{therm}) = \mathbf{\$965}$$

7-58 A steam pipe is exposed to light winds in the atmosphere. The amount of heat loss from the steam during a certain period and the money the facility will save a year as a result of insulating the steam pipes are to be determined.

Assumptions 1 Steady operating conditions exist. 2 Air is an ideal gas with constant properties. 3 The plant operates every day of the year for 10 h. 4 The local atmospheric pressure is 1 atm.

Properties The properties of air at 1 atm and the film temperature of

$(T_s + T_\infty)/2 = (75+5)/2 = 40^\circ\text{C}$ are (Table A-15)

$$k = 0.02662 \text{ W/m}\cdot^\circ\text{C}$$

$$\nu = 1.702 \times 10^{-5} \text{ m}^2/\text{s}$$

$$\text{Pr} = 0.7255$$

Analysis The Reynolds number is

$$\text{Re} = \frac{VD}{\nu} = \frac{[(10 \times 1000/3600) \text{ m/s}](0.1 \text{ m})}{1.702 \times 10^{-5} \text{ m}^2/\text{s}} = 1.632 \times 10^4$$

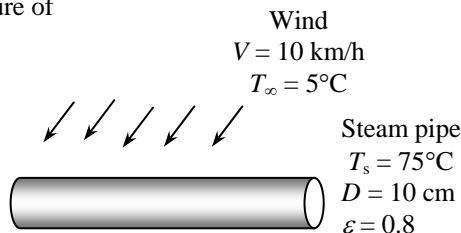

The Nusselt number corresponding to this Reynolds number is determined to be

$$\begin{aligned} \text{Nu} = \frac{hD}{k} &= 0.3 + \frac{0.62 \text{Re}^{0.5} \text{Pr}^{1/3}}{\left[1 + (0.4/\text{Pr})^{2/3}\right]^{1/4}} \left[1 + \left(\frac{\text{Re}}{282,000}\right)^{5/8}\right]^{4/5} \\ &= 0.3 + \frac{0.62(1.632 \times 10^4)^{0.5} (0.7255)^{1/3}}{\left[1 + (0.4/0.7255)^{2/3}\right]^{1/4}} \left[1 + \left(\frac{1.632 \times 10^4}{282,000}\right)^{5/8}\right]^{4/5} = 71.19 \end{aligned}$$

The heat transfer coefficient is

$$h = \frac{k}{D} \text{Nu} = \frac{0.02662 \text{ W/m}\cdot^\circ\text{C}}{0.1 \text{ m}} (71.19) = 18.95 \text{ W/m}^2\cdot^\circ\text{C}$$

The rate of heat loss by convection is

$$A_s = \pi DL = \pi(0.1 \text{ m})(12 \text{ m}) = 3.77 \text{ m}^2$$

$$\dot{Q} = hA_s(T_s - T_\infty) = (18.95 \text{ W/m}^2\cdot^\circ\text{C})(3.77 \text{ m}^2)(75 - 5)^\circ\text{C} = 5001 \text{ W}$$

For an average surrounding temperature of 0°C , the rate of heat loss by radiation and the total rate of heat loss are

$$\begin{aligned} \dot{Q}_{rad} &= \varepsilon A_s \sigma (T_s^4 - T_{surr}^4) \\ &= (0.8)(3.77 \text{ m}^2)(5.67 \times 10^{-8} \text{ W/m}^2\cdot\text{K}^4) \left[(75 + 273 \text{ K})^4 - (0 + 273 \text{ K})^4 \right] = 1558 \text{ W} \end{aligned}$$

$$\dot{Q}_{total} = \dot{Q}_{conv} + \dot{Q}_{rad} = 5001 + 1558 = 6559 \text{ W}$$

If the average surrounding temperature is -20°C , the rate of heat loss by radiation and the total rate of heat loss become

$$\begin{aligned} \dot{Q}_{rad} &= \varepsilon A_s \sigma (T_s^4 - T_{surr}^4) \\ &= (0.8)(3.77 \text{ m}^2)(5.67 \times 10^{-8} \text{ W/m}^2\cdot\text{K}^4) \left[(75 + 273 \text{ K})^4 - (-20 + 273 \text{ K})^4 \right] \\ &= 1807 \text{ W} \end{aligned}$$

$$\dot{Q}_{total} = \dot{Q}_{conv} + \dot{Q}_{rad} = 5001 + 1807 = 6808 \text{ W}$$

which is $6808 - 6559 = 249 \text{ W}$ more than the value for a surrounding temperature of 0°C . This corresponds to

$$\% \text{ change} = \frac{\dot{Q}_{\text{difference}}}{\dot{Q}_{\text{total}, 0^\circ\text{C}}} \times 100 = \frac{249 \text{ W}}{6559 \text{ W}} \times 100 = \mathbf{3.8\%} \quad (\text{increase})$$

If the average surrounding temperature is 25°C , the rate of heat loss by radiation and the total rate of heat loss become

$$\begin{aligned}\dot{Q}_{rad} &= \varepsilon A_s \sigma (T_s^4 - T_{surr}^4) \\ &= (0.8)(3.77 \text{ m}^2)(5.67 \times 10^{-8} \text{ W/m}^2 \cdot \text{K}^4) \left[(75 + 273 \text{ K})^4 - (25 + 273 \text{ K})^4 \right] \\ &= 1159 \text{ W} \\ \dot{Q}_{total} &= \dot{Q}_{conv} + \dot{Q}_{rad} = 5001 + 1159 = 6160 \text{ W}\end{aligned}$$

which is $6559 - 6160 = 399 \text{ W}$ less than the value for a surrounding temperature of 0°C . This corresponds to

$$\% \text{ change} = \frac{\dot{Q}_{\text{difference}}}{\dot{Q}_{\text{total}, 0^\circ\text{C}}} \times 100 = \frac{399 \text{ W}}{6559 \text{ W}} \times 100 = \mathbf{6.1\%} \quad (\text{decrease})$$

Therefore, the effect of the temperature variations of the surrounding surfaces on the total heat transfer is less than 6%.

7-59E An electrical resistance wire is cooled by a fan. The surface temperature of the wire is to be determined.

Assumptions 1 Steady operating conditions exist. 2 Radiation effects are negligible. 3 Air is an ideal gas with constant properties. 4 The local atmospheric pressure is 1 atm.

Properties We assume the film temperature to be 200°F . The properties of air at this temperature are (Table A-15E)

$$k = 0.01761 \text{ Btu/h}\cdot\text{ft}\cdot^\circ\text{F}$$

$$\nu = 2.406 \times 10^{-4} \text{ ft}^2/\text{s}$$

$$\text{Pr} = 0.7124$$

Analysis The Reynolds number is

$$\text{Re} = \frac{VD}{\nu} = \frac{(20 \text{ ft/s})(0.1/12 \text{ ft})}{2.406 \times 10^{-4} \text{ ft}^2/\text{s}} = 692.7$$

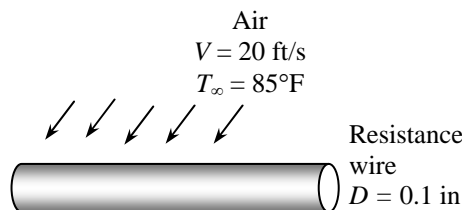

The proper relation for Nusselt number corresponding to this Reynolds number is

$$\begin{aligned}Nu &= \frac{hD}{k} = 0.3 + \frac{0.62 \text{Re}^{0.5} \text{Pr}^{1/3}}{\left[1 + (0.4/\text{Pr})^{2/3}\right]^{1/4}} \left[1 + \left(\frac{\text{Re}}{282,000}\right)^{5/8}\right]^{4/5} \\ &= 0.3 + \frac{0.62(692.7)^{0.5} (0.7124)^{1/3}}{\left[1 + (0.4/0.7124)^{2/3}\right]^{1/4}} \left[1 + \left(\frac{692.7}{282,000}\right)^{5/8}\right]^{4/5} = 13.34\end{aligned}$$

The heat transfer coefficient is

$$h = \frac{k}{D} Nu = \frac{0.01761 \text{ Btu/h}\cdot\text{ft}\cdot^\circ\text{F}}{(0.1/12 \text{ ft})} (13.34) = 28.19 \text{ Btu/h}\cdot\text{ft}^2\cdot^\circ\text{F}$$

Then the average temperature of the outer surface of the wire becomes

$$A_s = \pi DL = \pi(0.1/12 \text{ ft})(12 \text{ ft}) = 0.3142 \text{ ft}^2$$

$$\dot{Q} = hA_s(T_s - T_\infty) \longrightarrow T_s = T_\infty + \frac{\dot{Q}}{hA} = 85^\circ\text{F} + \frac{(1500 \times 3.41214) \text{ Btu/h}}{(28.19 \text{ Btu/h}\cdot\text{ft}^2\cdot^\circ\text{F})(0.3142 \text{ ft}^2)} = \mathbf{662.9^\circ\text{F}}$$

Discussion Repeating the calculations at the new film temperature of $(85 + 662.9)/2 = 374^\circ\text{F}$ gives $T_s = 668.3^\circ\text{F}$.

7-60 The components of an electronic system located in a horizontal duct is cooled by air flowing over the duct. The total power rating of the electronic device is to be determined.

Assumptions 1 Steady operating conditions exist. 2 Radiation effects are negligible. 3 Air is an ideal gas with constant properties. 4 The local atmospheric pressure is 1 atm.

Properties The properties of air at 1 atm and the film temperature of $(T_s + T_\infty)/2 = (65+30)/2 = 47.5^\circ\text{C}$ are (Table A-15)

$$k = 0.02717 \text{ W/m}\cdot^\circ\text{C}$$

$$\nu = 1.774 \times 10^{-5} \text{ m}^2/\text{s}$$

$$\text{Pr} = 0.7235$$

Analysis The Reynolds number is

$$\text{Re} = \frac{VD}{\nu} = \frac{[(200/60) \text{ m/s}](0.2 \text{ m})}{1.774 \times 10^{-5} \text{ m}^2/\text{s}} = 3.758 \times 10^4$$

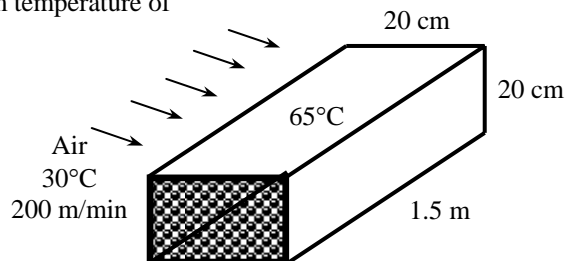

Using the relation for a square duct from Table 7-1, the Nusselt number is determined to be

$$\text{Nu} = \frac{hD}{k} = 0.102 \text{Re}^{0.675} \text{Pr}^{1/3} = 0.102(3.758 \times 10^4)^{0.675} (0.7235)^{1/3} = 112.2$$

The heat transfer coefficient is

$$h = \frac{k}{D} \text{Nu} = \frac{0.02717 \text{ W/m}\cdot^\circ\text{C}}{0.2 \text{ m}} (112.2) = 15.24 \text{ W/m}^2\cdot^\circ\text{C}$$

Then the rate of heat transfer from the duct becomes

$$A_s = (4 \times 0.2 \text{ m})(1.5 \text{ m}) = 1.2 \text{ m}^2$$

$$\dot{Q} = hA_s(T_s - T_\infty) = (15.24 \text{ W/m}^2\cdot^\circ\text{C})(1.2 \text{ m}^2)(65 - 30)^\circ\text{C} = \mathbf{640 \text{ W}}$$

7-61 The components of an electronic system located in a horizontal duct is cooled by air flowing over the duct. The total power rating of the electronic device is to be determined. \checkmark

Assumptions 1 Steady operating conditions exist. 2 Radiation effects are negligible. 3 Air is an ideal gas with constant properties.

Properties The properties of air at 1 atm and the film temperature of $(T_s + T_\infty)/2 = (65+30)/2 = 47.5^\circ\text{C}$ are (Table A-15)

$$k = 0.02717 \text{ W/m}\cdot^\circ\text{C}$$

$$\nu = 1.774 \times 10^{-5} \text{ m}^2/\text{s}$$

$$\text{Pr} = 0.7235$$

For a location at 4000 m altitude where the atmospheric pressure is 61.66 kPa, only kinematic viscosity of air will be affected. Thus,

$$\nu_{@ 61.66 \text{ kPa}} = \left(\frac{101.325}{61.66} \right) (1.774 \times 10^{-5}) = 2.915 \times 10^{-5} \text{ m}^2/\text{s}$$

Analysis The Reynolds number is

$$\text{Re} = \frac{VD}{\nu} = \frac{[(200/60) \text{ m/s}](0.2 \text{ m})}{2.915 \times 10^{-5} \text{ m}^2/\text{s}} = 2.287 \times 10^4$$

Using the relation for a square duct from Table 7-1, the Nusselt number is determined to be

$$\text{Nu} = \frac{hD}{k} = 0.102 \text{Re}^{0.675} \text{Pr}^{1/3} = 0.102(2.287)^{0.675} (0.7235)^{1/3} = 80.21$$

The heat transfer coefficient is

$$h = \frac{k}{D} \text{Nu} = \frac{0.02717 \text{ W/m}\cdot^\circ\text{C}}{0.2 \text{ m}} (80.21) = 10.90 \text{ W/m}^2\cdot^\circ\text{C}$$

Then the rate of heat transfer from the duct becomes

$$A_s = (4 \times 0.2 \text{ m})(1.5 \text{ m}) = 1.2 \text{ m}^2$$

$$\dot{Q} = hA_s(T_s - T_\infty) = (10.90 \text{ W/m}^2\cdot^\circ\text{C})(1.2 \text{ m}^2)(65 - 30)^\circ\text{C} = \mathbf{458 \text{ W}}$$

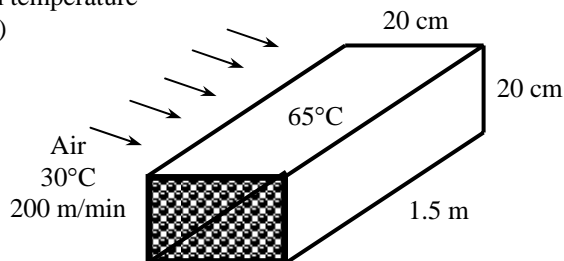

7-62 A cylindrical electronic component mounted on a circuit board is cooled by air flowing across it. The surface temperature of the component is to be determined.

Assumptions 1 Steady operating conditions exist. 2 Radiation effects are negligible. 3 Air is an ideal gas with constant properties. 4 The local atmospheric pressure is 1 atm.

Properties We assume the film temperature to be 50°C. The properties of air at 1 atm and at this temperature are (Table A-15)

$$k = 0.02735 \text{ W/m}\cdot\text{°C}$$

$$\nu = 1.798 \times 10^{-5} \text{ m}^2/\text{s}$$

$$\text{Pr} = 0.7228$$

Analysis The Reynolds number is

$$\text{Re} = \frac{VD}{\nu} = \frac{(240/60 \text{ m/s})(0.003 \text{ m})}{1.798 \times 10^{-5} \text{ m}^2/\text{s}} = 667.4$$

The proper relation for Nusselt number corresponding to this Reynolds number is

$$\begin{aligned} \text{Nu} = \frac{hD}{k} &= 0.3 + \frac{0.62 \text{Re}^{0.5} \text{Pr}^{1/3}}{\left[1 + (0.4/\text{Pr})^{2/3}\right]^{1/4}} \left[1 + \left(\frac{\text{Re}}{282,000}\right)^{5/8}\right]^{4/5} \\ &= 0.3 + \frac{0.62(667.4)^{0.5} (0.7228)^{1/3}}{\left[1 + (0.4/0.7228)^{2/3}\right]^{1/4}} \left[1 + \left(\frac{667.4}{282,000}\right)^{5/8}\right]^{4/5} = 13.17 \end{aligned}$$

The heat transfer coefficient is

$$h = \frac{k}{D} \text{Nu} = \frac{0.02735 \text{ W/m}\cdot\text{°C}}{0.003 \text{ m}} (13.17) = 120.0 \text{ W/m}^2\cdot\text{°C}$$

Then the surface temperature of the component becomes

$$A_s = \pi DL = \pi(0.003 \text{ m})(0.018 \text{ m}) = 0.0001696 \text{ m}^2$$

$$\dot{Q} = hA_s(T_s - T_\infty) \longrightarrow T_s = T_\infty + \frac{\dot{Q}}{hA} = 35^\circ\text{C} + \frac{0.4 \text{ W}}{(120.0 \text{ W/m}^2\cdot\text{°C})(0.0001696 \text{ m}^2)} = \mathbf{54.6^\circ\text{C}}$$

The film temperature is $(54.6+35)/2=44.8^\circ\text{C}$, which is sufficiently close to the assumed value of 50°C . Therefore, there is no need to repeat calculations.

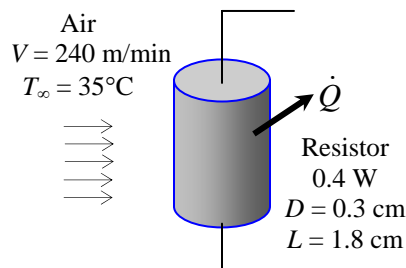

7-63 A cylindrical hot water tank is exposed to windy air. The temperature of the tank after a 45-min cooling period is to be estimated.

Assumptions 1 Steady operating conditions exist. 2 Radiation effects are negligible. 3 Air is an ideal gas with constant properties. 4 The surface of the tank is at the same temperature as the water temperature. 5 The heat transfer coefficient on the top and bottom surfaces is the same as that on the side surfaces.

Properties The properties of water at 80°C are (Table A-9)

$$\rho = 971.8 \text{ kg/m}^3$$

$$c_p = 4197 \text{ J/kg}\cdot^\circ\text{C}$$

The properties of air at 1 atm and at the anticipated film temperature of 50°C are (Table A-15)

$$k = 0.02735 \text{ W/m}\cdot^\circ\text{C}$$

$$\nu = 1.798 \times 10^{-5} \text{ m}^2/\text{s}$$

$$\text{Pr} = 0.7228$$

Analysis The Reynolds number is

$$\text{Re} = \frac{VD}{\nu} = \frac{\left(\frac{40 \times 1000}{3600} \text{ m/s}\right)(0.50 \text{ m})}{1.798 \times 10^{-5} \text{ m}^2/\text{s}} = 3.090 \times 10^5$$

The proper relation for Nusselt number corresponding to this Reynolds number is

$$\begin{aligned} \text{Nu} &= 0.3 + \frac{0.62 \text{Re}^{0.5} \text{Pr}^{1/3}}{\left[1 + (0.4/\text{Pr})^{2/3}\right]^{1/4}} \left[1 + \left(\frac{\text{Re}}{282,000}\right)^{5/8}\right]^{4/5} \\ &= 0.3 + \frac{0.62(3.090 \times 10^5)^{0.5} (0.7228)^{1/3}}{\left[1 + (0.4/0.7228)^{2/3}\right]^{1/4}} \left[1 + \left(\frac{3.090 \times 10^5}{282,000}\right)^{5/8}\right]^{4/5} = 484.8 \end{aligned}$$

The heat transfer coefficient is

$$h = \frac{k}{D} \text{Nu} = \frac{0.02735 \text{ W/m}\cdot^\circ\text{C}}{0.50 \text{ m}} (484.8) = 26.52 \text{ W/m}^2\cdot^\circ\text{C}$$

The surface area of the tank is

$$A_s = \pi DL + 2\pi \frac{D^2}{4} = \pi(0.5)(0.95) + 2\pi(0.5)^2/4 = 1.885 \text{ m}^2$$

The rate of heat transfer is determined from

$$\dot{Q} = hA_s(T_s - T_\infty) = (26.52 \text{ W/m}^2\cdot^\circ\text{C})(1.885 \text{ m}^2) \left(\frac{80 + T_2}{2} - 18\right)^\circ\text{C} \quad (\text{Eq. 1})$$

where T_2 is the final temperature of water so that $(80 + T_2)/2$ gives the average temperature of water during the cooling process. The mass of water in the tank is

$$m = \rho V = \rho \pi \frac{D^2}{4} L = (971.8 \text{ kg/m}^3) \pi (0.50 \text{ m})^2 (0.95 \text{ m}) / 4 = 181.3 \text{ kg}$$

The amount of heat transfer from the water is determined from

$$Q = mc_p(T_2 - T_1) = (181.3 \text{ kg})(4197 \text{ J/kg}\cdot^\circ\text{C})(80 - T_2)^\circ\text{C}$$

Then average rate of heat transfer is

$$\dot{Q} = \frac{Q}{\Delta t} = \frac{(181.3 \text{ kg})(4197 \text{ J/kg}\cdot^\circ\text{C})(80 - T_2)^\circ\text{C}}{45 \times 60 \text{ s}} \quad (\text{Eq. 2})$$

Setting Eq. 1 to be equal to Eq. 2 we obtain the final temperature of water

$$\dot{Q} = (26.52 \text{ W/m}^2\cdot^\circ\text{C})(1.885 \text{ m}^2) \left(\frac{80 + T_2}{2} - 18\right)^\circ\text{C} = \frac{(181.3 \text{ kg})(4197 \text{ J/kg}\cdot^\circ\text{C})(80 - T_2)^\circ\text{C}}{45 \times 60 \text{ s}}$$

$$T_2 = \mathbf{69.9^\circ\text{C}}$$

Water tank
 $D = 50 \text{ cm}$
 $L = 95 \text{ cm}$



Air
 $V = 40 \text{ km/h}$
 $T_\infty = 18^\circ\text{C}$

7-64 EES Prob. 7-63 is reconsidered. The temperature of the tank as a function of the cooling time is to be plotted.

Analysis The problem is solved using EES, and the solution is given below.

"GIVEN"

D=0.50 [m]
L=0.95 [m]
T_w1=80 [C]
T_infinity=18 [C]
Vel=40 [km/h]
time=45 [min]

"PROPERTIES"

Fluid\$='air'
k=Conductivity(Fluid\$, T=T_film)
Pr=Prandtl(Fluid\$, T=T_film)
rho=Density(Fluid\$, T=T_film, P=101.3)
mu=Viscosity(Fluid\$, T=T_film)
nu=mu/rho
T_film=1/2*(T_w_ave+T_infinity)
rho_w=Density(water, T=T_w_ave, P=101.3)
C_p_w=CP(Water, T=T_w_ave, P=101.3)*Convert(kJ/kg-C, J/kg-C)
T_w_ave=1/2*(T_w1+T_w2)

"ANALYSIS"

Re=(Vel*Convert(km/h, m/s)*D)/nu
Nusselt=0.3+(0.62*Re^0.5*Pr^(1/3))/(1+(0.4/Pr)^(2/3))^0.25*(1+(Re/282000)^(5/8))^(4/5)
h=k/D*Nusselt
A=pi*D*L+2*pi*D^2/4
Q_dot=h*A*(T_w_ave-T_infinity)
m_w=rho_w*V_w
V_w=pi*D^2/4*L
Q=m_w*C_p_w*(T_w1-T_w2)
Q_dot=Q/(time*Convert(min, s))

time [min]	T _{w2} [C]
30	73.06
45	69.86
60	66.83
75	63.96
90	61.23
105	58.63
120	56.16
135	53.8
150	51.54
165	49.39
180	47.33
195	45.36
210	43.47
225	41.65
240	39.91
255	38.24
270	36.63
285	35.09
300	33.6

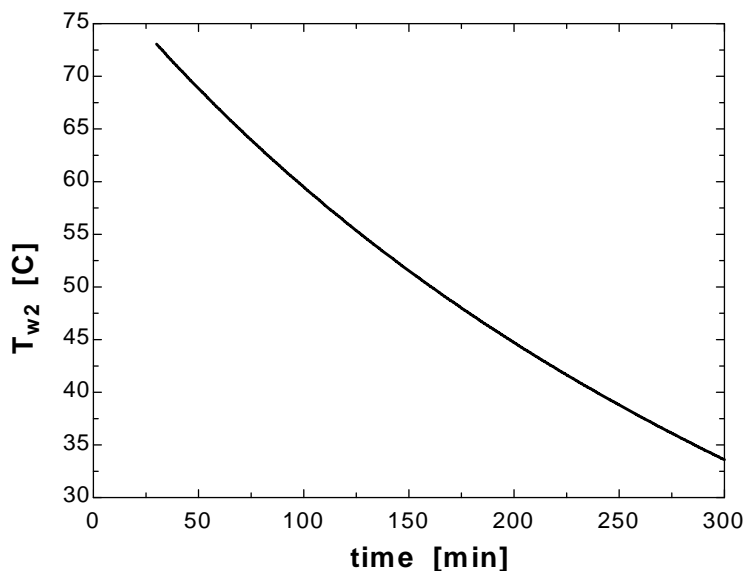

7-65 Air flows over a spherical tank containing iced water. The rate of heat transfer to the tank and the rate at which ice melts are to be determined.

Assumptions 1 Steady operating conditions exist. 2 Radiation effects are negligible. 3 Air is an ideal gas with constant properties. 4 The local atmospheric pressure is 1 atm.

Properties The properties of air at 1 atm pressure and the free stream temperature of 25°C are (Table A-15)

$$k = 0.02551 \text{ W/m}\cdot\text{°C}$$

$$\nu = 1.562 \times 10^{-5} \text{ m}^2/\text{s}$$

$$\mu_\infty = 1.849 \times 10^{-5} \text{ kg/m}\cdot\text{s}$$

$$\mu_{s, @ 0^\circ\text{C}} = 1.729 \times 10^{-5} \text{ kg/m}\cdot\text{s}$$

$$\text{Pr} = 0.7296$$

Air
 $V = 7 \text{ m/s}$
 $T_\infty = 25^\circ\text{C}$

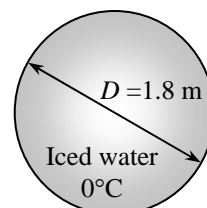

Analysis The Reynolds number is

$$\text{Re} = \frac{VD}{\nu} = \frac{(7 \text{ m/s})(1.8 \text{ m})}{1.562 \times 10^{-5} \text{ m}^2/\text{s}} = 8.067 \times 10^5$$

The proper relation for Nusselt number corresponding to this Reynolds number is

$$\begin{aligned} Nu &= \frac{hD}{k} = 2 + \left[0.4 \text{Re}^{0.5} + 0.06 \text{Re}^{2/3} \right] \text{Pr}^{0.4} \left(\frac{\mu_\infty}{\mu_s} \right)^{1/4} \\ &= 2 + \left[0.4(8.067 \times 10^5)^{0.5} + 0.06(8.067 \times 10^5)^{2/3} \right] (0.7296)^{0.4} \left(\frac{1.849 \times 10^{-5}}{1.729 \times 10^{-5}} \right)^{1/4} = 790.1 \end{aligned}$$

The heat transfer coefficient is

$$h = \frac{k}{D} Nu = \frac{0.02551 \text{ W/m}\cdot\text{°C}}{1.8 \text{ m}} (790.1) = 11.20 \text{ W/m}^2\cdot\text{°C}$$

Then the rate of heat transfer is determined to be

$$A_s = \pi D^2 = \pi (1.8 \text{ m})^2 = 10.18 \text{ m}^2$$

$$\dot{Q} = hA_s(T_s - T_\infty) = (11.20 \text{ W/m}^2\cdot\text{°C})(10.18 \text{ m}^2)(25 - 0)^\circ\text{C} = \mathbf{2850 \text{ W}}$$

The rate at which ice melts is

$$\dot{Q} = \dot{m}h_{fg} \longrightarrow \dot{m} = \frac{\dot{Q}}{h_{fg}} = \frac{2.85 \text{ kW}}{333.7 \text{ kJ/kg}} = 0.00854 \text{ kg/s} = \mathbf{0.512 \text{ kg/min}}$$

7-66 A cylindrical bottle containing cold water is exposed to windy air. The average wind velocity is to be estimated.

Assumptions 1 Steady operating conditions exist. 2 Radiation effects are negligible. 3 Air is an ideal gas with constant properties. 4 Heat transfer at the top and bottom surfaces is negligible.

Properties The properties of water at the average temperature of $(T_1 + T_2)/2 = (3 + 11)/2 = 7^\circ\text{C}$ are (Table A-9)

$$\rho = 999.8 \text{ kg/m}^3$$

$$c_p = 4200 \text{ J/kg}\cdot^\circ\text{C}$$

The properties of air at 1 atm and the film temperature of $(T_s + T_\infty)/2 = (7 + 27)/2 = 17^\circ\text{C}$ are (Table A-15)

$$k = 0.02491 \text{ W/m}\cdot^\circ\text{C}$$

$$\nu = 1.488 \times 10^{-5} \text{ m}^2/\text{s}$$

$$\text{Pr} = 0.7317$$

Analysis The mass of water in the bottle is

$$m = \rho V = \rho \pi \frac{D^2}{4} L = (999.8 \text{ kg/m}^3) \pi (0.10 \text{ m})^2 (0.30 \text{ m}) / 4 = 2.356 \text{ kg}$$

Then the amount of heat transfer to the water is

$$Q = mc_p (T_2 - T_1) = (2.356 \text{ kg})(4200 \text{ J/kg}\cdot^\circ\text{C})(11 - 3)^\circ\text{C} = 79,162 \text{ J}$$

The average rate of heat transfer is

$$\dot{Q} = \frac{Q}{\Delta t} = \frac{79,162 \text{ J}}{45 \times 60 \text{ s}} = 29.32 \text{ W}$$

The heat transfer coefficient is

$$A_s = \pi DL = \pi (0.10 \text{ m})(0.30 \text{ m}) = 0.09425 \text{ m}^2$$

$$\dot{Q}_{\text{conv}} = hA_s (T_\infty - T_s) \longrightarrow 29.32 \text{ W} = h(0.09425 \text{ m}^2)(27 - 7)^\circ\text{C} \longrightarrow h = 15.55 \text{ W/m}^2\cdot^\circ\text{C}$$

The Nusselt number is

$$\text{Nu} = \frac{hD}{k} = \frac{(15.55 \text{ W/m}^2\cdot^\circ\text{C})(0.10 \text{ m})}{0.02491 \text{ W/m}\cdot^\circ\text{C}} = 62.42$$

Reynolds number can be obtained from the Nusselt number relation for a flow over the cylinder

$$\text{Nu} = 0.3 + \frac{0.62 \text{ Re}^{0.5} \text{ Pr}^{1/3}}{\left[1 + (0.4/\text{Pr})^{2/3}\right]^{1/4}} \left[1 + \left(\frac{\text{Re}}{282,000}\right)^{5/8}\right]^{4/5}$$

$$62.42 = 0.3 + \frac{0.62 \text{ Re}^{0.5} (0.7317)^{1/3}}{\left[1 + (0.4/0.7317)^{2/3}\right]^{1/4}} \left[1 + \left(\frac{\text{Re}}{282,000}\right)^{5/8}\right]^{4/5} \longrightarrow \text{Re} = 12,856$$

Then using the Reynolds number relation we determine the wind velocity

$$\text{Re} = \frac{VD}{\nu} \longrightarrow 12,856 = \frac{V(0.10 \text{ m})}{1.488 \times 10^{-5} \text{ m}^2/\text{s}} \longrightarrow V = \mathbf{1.91 \text{ m/s}}$$

Air
V
 $T_\infty = 27^\circ\text{C}$



Bottle
 $D = 10 \text{ cm}$
 $L = 30 \text{ cm}$

Flow across Tube Banks

7-67C In tube banks, the flow characteristics are dominated by the *maximum velocity* V_{max} that occurs within the tube bank rather than the approach velocity V . Therefore, the Reynolds number is defined on the basis of maximum velocity.

7-68C The level of turbulence, and thus the heat transfer coefficient, increases with row number because of the combined effects of upstream rows in turbulence caused and the wakes formed. But there is no significant change in turbulence level after the first few rows, and thus the heat transfer coefficient remains constant. There is no change in transverse direction.

7-69 Combustion air is preheated by hot water in a tube bank. The rate of heat transfer to air and the pressure drop of air are to be determined.

Assumptions 1 Steady operating conditions exist. **2** The surface temperature of the tubes is equal to the temperature of hot water.

Properties The exit temperature of air, and thus the mean temperature, is not known. We evaluate the air properties at the assumed mean temperature of 20°C (will be checked later) and 1 atm (Table A-15):

$$\begin{aligned} k &= 0.02514 \text{ W/m}\cdot\text{K} & \rho &= 1.204 \text{ kg/m}^3 \\ c_p &= 1.007 \text{ kJ/kg}\cdot\text{K} & \text{Pr} &= 0.7309 \\ \mu &= 1.825 \times 10^{-5} \text{ kg/m}\cdot\text{s} & \text{Pr}_s &= \text{Pr}_{@ T_s = 90^\circ\text{C}} = 0.7132 \end{aligned}$$

Also, the density of air at the inlet temperature of 15°C (for use in the mass flow rate calculation at the inlet) is $\rho_i = 1.225 \text{ kg/m}^3$.

Analysis It is given that $D = 0.021 \text{ m}$, $S_L = S_T = 0.05 \text{ m}$, and $V = 3.8 \text{ m/s}$. Then the maximum velocity and the Reynolds number based on the maximum velocity become

$$V_{\max} = \frac{S_T}{S_T - D} V = \frac{0.05}{0.05 - 0.021} (3.8 \text{ m/s}) = 6.552 \text{ m/s}$$

$$\text{Re}_D = \frac{\rho V_{\max} D}{\mu} = \frac{(1.204 \text{ kg/m}^3)(6.552 \text{ m/s})(0.021 \text{ m})}{1.825 \times 10^{-5} \text{ kg/m}\cdot\text{s}} = 9077$$

The average Nusselt number is determined using the proper relation from Table 7-2 to be

$$\begin{aligned} \text{Nu}_D &= 0.27 \text{Re}_D^{0.63} \text{Pr}^{0.36} (\text{Pr}/\text{Pr}_s)^{0.25} \\ &= 0.27(9077)^{0.63} (0.7309)^{0.36} (0.7309/0.7132)^{0.25} = 75.60 \end{aligned}$$

This Nusselt number is applicable to tube banks with $N_L > 16$. In our case the number of rows is $N_L = 8$, and the corresponding correction factor from Table 7-3 is $F = 0.967$. Then the average Nusselt number and heat transfer coefficient for all the tubes in the tube bank become

$$\text{Nu}_{D,N_L} = F \text{Nu}_D = (0.967)(75.60) = 73.1$$

$$h = \frac{\text{Nu}_{D,N_L} k}{D} = \frac{73.1(0.02514 \text{ W/m}\cdot^\circ\text{C})}{0.021 \text{ m}} = 87.5 \text{ W/m}^2 \cdot ^\circ\text{C}$$

The total number of tubes is $N = N_L \times N_T = 8 \times 8 = 64$. For a unit tube length ($L = 1 \text{ m}$), the heat transfer surface area and the mass flow rate of air (evaluated at the inlet) are

$$A_s = N\pi DL = 64\pi(0.021 \text{ m})(1 \text{ m}) = 4.222 \text{ m}^2$$

$$\dot{m} = \dot{m}_i = \rho_i V (N_T S_T L) = (1.225 \text{ kg/m}^3)(3.8 \text{ m/s})(8)(0.05 \text{ m})(1 \text{ m}) = 1.862 \text{ kg/s}$$

Then the fluid exit temperature, the log mean temperature difference, and the rate of heat transfer become

$$T_e = T_s - (T_s - T_i) \exp\left(-\frac{A_s h}{\dot{m} c_p}\right) = 90 - (90 - 15) \exp\left(-\frac{(4.222 \text{ m}^2)(87.5 \text{ W/m}^2 \cdot ^\circ\text{C})}{(1.862 \text{ kg/s})(1007 \text{ J/kg}\cdot^\circ\text{C})}\right) = 28.41^\circ\text{C}$$

$$\Delta T_{\ln} = \frac{(T_s - T_i) - (T_s - T_e)}{\ln[(T_s - T_i)/(T_s - T_e)]} = \frac{(90 - 15) - (90 - 28.41)}{\ln[(90 - 15)/(90 - 28.41)]} = 68.08^\circ\text{C}$$

$$\dot{Q} = h A_s \Delta T_{\ln} = (87.5 \text{ W/m}^2 \cdot ^\circ\text{C})(4.222 \text{ m}^2)(68.08^\circ\text{C}) = \mathbf{25,150 \text{ W}}$$

For this square in-line tube bank, the friction coefficient corresponding to $\text{Re}_D = 9077$ and $S_L/D = 5/2.1 = 2.38$ is, from Fig. 7-27a, $f = 0.22$. Also, $\chi = 1$ for the square arrangements. Then the pressure drop across the tube bank becomes

$$\Delta P = N_L f \chi \frac{\rho V_{\max}^2}{2} = 8(0.22)(1) \frac{(1.204 \text{ kg/m}^3)(6.552 \text{ m/s})^2}{2} \left(\frac{1 \text{ N}}{1 \text{ kg}\cdot\text{m/s}^2}\right) = \mathbf{45.5 \text{ Pa}}$$

Discussion The arithmetic mean fluid temperature is $(T_i + T_e)/2 = (15 + 28.4)/2 = 21.7^\circ\text{C}$, which is fairly close to the assumed value of 20°C. Therefore, there is no need to repeat calculations.

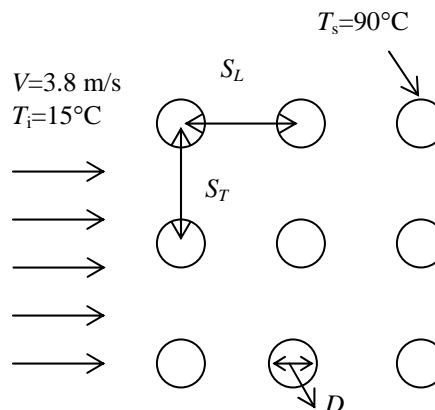

7-70 Combustion air is preheated by hot water in a tube bank. The rate of heat transfer to air and the pressure drop of air are to be determined.

Assumptions 1 Steady operating conditions exist. **2** The surface temperature of the tubes is equal to the temperature of hot water.

Properties The exit temperature of air, and thus the mean temperature, is not known. We evaluate the air properties at the assumed mean temperature of 20°C (will be checked later) and 1 atm (Table A-15):

$$\begin{aligned} k &= 0.02514 \text{ W/m}\cdot\text{K} & \rho &= 1.204 \text{ kg/m}^3 \\ c_p &= 1.007 \text{ kJ/kg}\cdot\text{K} & \text{Pr} &= 0.7309 \\ \mu &= 1.825 \times 10^{-5} \text{ kg/m}\cdot\text{s} & \text{Pr}_s &= \text{Pr}_{@ T_s = 90^\circ\text{C}} = 0.7132 \end{aligned}$$

Also, the density of air at the inlet temperature of 15°C (for use in the mass flow rate calculation at the inlet) is $\rho_i = 1.225 \text{ kg/m}^3$.

Analysis It is given that $D = 0.021 \text{ m}$, $S_L = S_T = 0.06 \text{ m}$, and $V = 3.8 \text{ m/s}$. Then the maximum velocity and the Reynolds number based on the maximum velocity become

$$V_{\max} = \frac{S_T}{S_T - D} V = \frac{0.06}{0.06 - 0.021} (3.8 \text{ m/s}) = 5.846 \text{ m/s}$$

since $S_D > (S_T + D) / 2$

$$\text{Re}_D = \frac{\rho V_{\max} D}{\mu} = \frac{(1.204 \text{ kg/m}^3)(5.846 \text{ m/s})(0.021 \text{ m})}{1.825 \times 10^{-5} \text{ kg/m}\cdot\text{s}} = 8099$$

The average Nusselt number is determined using the proper relation from Table 7-2 to be

$$\begin{aligned} \text{Nu}_D &= 0.35(S_T / S_L)^{0.2} \text{Re}_D^{0.6} \text{Pr}^{0.36} (\text{Pr} / \text{Pr}_s)^{0.25} \\ &= 0.35(0.06 / 0.06)^{0.2} (8099)^{0.6} (0.7309)^{0.36} (0.7309 / 0.7132)^{0.25} = 69.63 \end{aligned}$$

This Nusselt number is applicable to tube banks with $N_L > 16$. In our case the number of rows is $N_L = 8$, and the corresponding correction factor from Table 7-3 is $F = 0.967$. Then the average Nusselt number and heat transfer coefficient for all the tubes in the tube bank become

$$\begin{aligned} \text{Nu}_{D, N_L} &= F \text{Nu}_D = (0.967)(69.63) = 67.33 \\ h &= \frac{\text{Nu}_{D, N_L} k}{D} = \frac{67.33(0.02514 \text{ W/m}\cdot^\circ\text{C})}{0.021 \text{ m}} = 80.60 \text{ W/m}^2 \cdot ^\circ\text{C} \end{aligned}$$

The total number of tubes is $N = N_L \times N_T = 8 \times 8 = 64$. For a unit tube length ($L = 1 \text{ m}$), the heat transfer surface area and the mass flow rate of air (evaluated at the inlet) are

$$\begin{aligned} A_s &= N\pi DL = 64\pi(0.021 \text{ m})(1 \text{ m}) = 4.222 \text{ m}^2 \\ \dot{m} = \dot{m}_i &= \rho_i V (N_T S_T L) = (1.225 \text{ kg/m}^3)(3.8 \text{ m/s})(8)(0.06 \text{ m})(1 \text{ m}) = 2.234 \text{ kg/s} \end{aligned}$$

Then the fluid exit temperature, the log mean temperature difference, and the rate of heat transfer become

$$\begin{aligned} T_e &= T_s - (T_s - T_i) \exp\left(-\frac{A_s h}{\dot{m} c_p}\right) = 90 - (90 - 15) \exp\left(-\frac{(4.222 \text{ m}^2)(80.60 \text{ W/m}^2 \cdot ^\circ\text{C})}{(2.234 \text{ kg/s})(1007 \text{ J/kg}\cdot^\circ\text{C})}\right) = 25.53^\circ\text{C} \\ \Delta T_{\ln} &= \frac{(T_s - T_i) - (T_s - T_e)}{\ln[(T_s - T_i)/(T_s - T_e)]} = \frac{(90 - 15) - (90 - 25.53)}{\ln[(90 - 15)/(90 - 25.53)]} = 69.60^\circ\text{C} \\ \dot{Q} &= h A_s \Delta T_{\ln} = (80.60 \text{ W/m}^2 \cdot ^\circ\text{C})(4.222 \text{ m}^2)(69.60^\circ\text{C}) = \mathbf{23,690 \text{ W}} \end{aligned}$$

For this staggered tube bank, the friction coefficient corresponding to $\text{Re}_D = 8099$ and $S_T/D = 6/2.1 = 2.86$ is, from Fig. 7-27b, $f = 0.30$. Also, $\chi = 1$ for the square arrangements. Then the pressure drop across the tube bank becomes

$$\Delta P = N_L f \chi \frac{\rho V_{\max}^2}{2} = 8(0.30)(1) \frac{(1.204 \text{ kg/m}^3)(5.846 \text{ m/s})^2}{2} \left(\frac{1 \text{ N}}{1 \text{ kg}\cdot\text{m/s}^2}\right) = \mathbf{49.4 \text{ Pa}}$$

Discussion The arithmetic mean fluid temperature is $(T_i + T_e)/2 = (15 + 25.5)/2 = 20.3^\circ\text{C}$, which is fairly close to the assumed value of 20°C. Therefore, there is no need to repeat calculations.

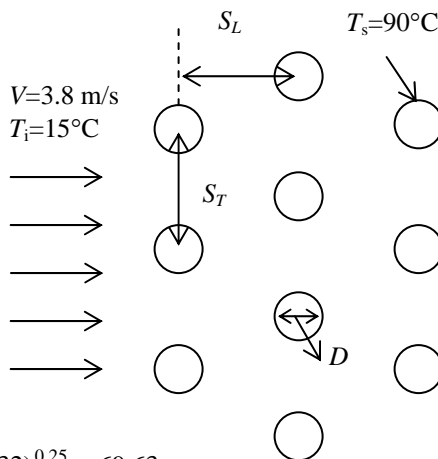

7-71 Combustion air is heated by condensing steam in a tube bank. The rate of heat transfer to air, the pressure drop of air, and the rate of condensation of steam are to be determined.

Assumptions 1 Steady operating conditions exist. **2** The surface temperature of the tubes is equal to the temperature of steam.

Properties The exit temperature of air, and thus the mean temperature, is not known. We evaluate the air properties at the assumed mean temperature of 35°C (will be checked later) and 1 atm (Table A-15):

$$\begin{aligned} k &= 0.02625 \text{ W/m}\cdot\text{K} & \rho &= 1.145 \text{ kg/m}^3 \\ c_p &= 1.007 \text{ kJ/kg}\cdot\text{K} & \text{Pr} &= 0.7268 \\ \mu &= 1.895 \times 10^{-5} \text{ kg/m}\cdot\text{s} & \text{Pr}_s &= \text{Pr}_{@ T_s = 100^\circ\text{C}} = 0.7111 \end{aligned}$$

Also, the density of air at the inlet temperature of 20°C (for use in the mass flow rate calculation at the inlet) is $\rho_i = 1.204 \text{ kg/m}^3$. The enthalpy of vaporization of water at 100°C is $h_{fg} = 2257 \text{ kJ/kg}\cdot\text{K}$ (Table A-9).

Analysis (a) It is given that $D = 0.016 \text{ m}$, $S_L = S_T = 0.04 \text{ m}$, and $V = 5.2 \text{ m/s}$. Then the maximum velocity and the Reynolds number based on the maximum velocity become

$$V_{\max} = \frac{S_T}{S_T - D} V = \frac{0.04}{0.04 - 0.016} (5.2 \text{ m/s}) = 8.667 \text{ m/s}$$

since $S_D > (S_T + D) / 2$

$$\text{Re}_D = \frac{\rho V_{\max} D}{\mu} = \frac{(1.145 \text{ kg/m}^3)(8.667 \text{ m/s})(0.016 \text{ m})}{1.895 \times 10^{-5} \text{ kg/m}\cdot\text{s}} = 8379$$

The average Nusselt number is determined using the proper relation from Table 7-2 to be

$$\begin{aligned} \text{Nu}_D &= 0.35(S_T / S_L)^{0.2} \text{Re}_D^{0.6} \text{Pr}^{0.36} (\text{Pr} / \text{Pr}_s)^{0.25} \\ &= 0.35(0.04 / 0.04)^{0.2} (8379)^{0.6} (0.7268)^{0.36} (0.7268 / 0.7111)^{0.25} = 70.87 \end{aligned}$$

Since $N_L = 20$, which is greater than 16, the average Nusselt number and heat transfer coefficient for all the tubes in the tube bank become

$$\text{Nu}_{D,N_L} = \text{Nu}_D = 70.87$$

$$h = \frac{\text{Nu}_{D,N_L} k}{D} = \frac{70.87(0.02625 \text{ W/m}\cdot^\circ\text{C})}{0.016 \text{ m}} = 116.3 \text{ W/m}^2 \cdot ^\circ\text{C}$$

The total number of tubes is $N = N_L \times N_T = 20 \times 10 = 200$. For a unit tube length ($L = 1 \text{ m}$), the heat transfer surface area and the mass flow rate of air (evaluated at the inlet) are

$$A_s = N\pi DL = 200\pi(0.016 \text{ m})(1 \text{ m}) = 10.05 \text{ m}^2$$

$$\dot{m} = \dot{m}_i = \rho_i V (N_T S_T L) = (1.204 \text{ kg/m}^3)(5.2 \text{ m/s})(10)(0.04 \text{ m})(1 \text{ m}) = 2.504 \text{ kg/s}$$

Then the fluid exit temperature, the log mean temperature difference, and the rate of heat transfer become

$$T_e = T_s - (T_s - T_i) \exp\left(-\frac{A_s h}{\dot{m} c_p}\right) = 100 - (100 - 20) \exp\left(-\frac{(10.05 \text{ m}^2)(116.3 \text{ W/m}^2 \cdot ^\circ\text{C})}{(2.504 \text{ kg/s})(1007 \text{ J/kg}\cdot^\circ\text{C})}\right) = 49.68^\circ\text{C}$$

$$\Delta T_{\ln} = \frac{(T_s - T_i) - (T_s - T_e)}{\ln[(T_s - T_i)/(T_s - T_e)]} = \frac{(100 - 20) - (100 - 49.68)}{\ln[(100 - 20)/(100 - 49.68)]} = 64.01^\circ\text{C}$$

$$\dot{Q} = h A_s \Delta T_{\ln} = (116.3 \text{ W/m}^2 \cdot ^\circ\text{C})(10.05 \text{ m}^2)(64.02^\circ\text{C}) = \mathbf{74,830 \text{ W}}$$

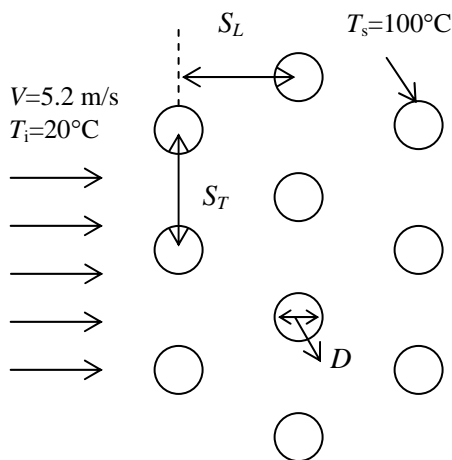

(b) For this staggered tube bank, the friction coefficient corresponding to $Re_D = 8379$ and $S_T/D = 4/1.6 = 2.5$ is, from Fig. 7-27b, $f = 0.33$. Also, $\chi = 1$ for the square arrangements. Then the pressure drop across the tube bank becomes

$$\Delta P = N_L f \chi \frac{\rho V_{\max}^2}{2} = 20(0.33)(1) \frac{(1.145 \text{ kg/m}^3)(8.667 \text{ m/s})^2}{2} \left(\frac{1 \text{ N}}{1 \text{ kg} \cdot \text{m/s}^2} \right) = \mathbf{284 \text{ Pa}}$$

(c) The rate of condensation of steam is

$$\dot{Q} = \dot{m}_{\text{cond}} h_{fg @ 100^\circ\text{C}} \longrightarrow \dot{m}_{\text{cond}} = \frac{\dot{Q}}{h_{fg @ 100^\circ\text{C}}} = \frac{74.83 \text{ kW}}{2257 \text{ kJ/kg} \cdot ^\circ\text{C}} = 0.0332 \text{ kg/s} = \mathbf{1.99 \text{ kg/min}}$$

Discussion The arithmetic mean fluid temperature is $(T_i + T_e)/2 = (20 + 49.7)/2 = 34.9^\circ\text{C}$, which is very close to the assumed value of 35°C . Therefore, there is no need to repeat calculations.

7-72 Combustion air is heated by condensing steam in a tube bank. The rate of heat transfer to air, the pressure drop of air, and the rate of condensation of steam are to be determined.

Assumptions 1 Steady operating conditions exist. **2** The surface temperature of the tubes is equal to the temperature of steam.

Properties The exit temperature of air, and thus the mean temperature, is not known. We evaluate the air properties at the assumed mean temperature of 35°C (will be checked later) and 1 atm (Table A-15):

$$\begin{aligned} k &= 0.02625 \text{ W/m}\cdot\text{K} & \rho &= 1.145 \text{ kg/m}^3 \\ c_p &= 1.007 \text{ kJ/kg}\cdot\text{K} & \text{Pr} &= 0.7268 \\ \mu &= 1.895 \times 10^{-5} \text{ kg/m}\cdot\text{s} & \text{Pr}_s &= \text{Pr}_{@ T_s = 100^\circ\text{C}} = 0.7111 \end{aligned}$$

Also, the density of air at the inlet temperature of 20°C (for use in the mass flow rate calculation at the inlet) is $\rho_i = 1.204 \text{ kg/m}^3$. The enthalpy of vaporization of water at 100°C is $h_{fg} = 2257 \text{ kJ/kg}\cdot\text{K}$ (Table A-9).

Analysis (a) It is given that $D = 0.016 \text{ m}$, $S_L = S_T = 0.06 \text{ m}$, and $V = 5.2 \text{ m/s}$. Then the maximum velocity and the Reynolds number based on the maximum velocity become

$$\begin{aligned} V_{\max} &= \frac{S_T}{S_T - D} V = \frac{0.06}{0.06 - 0.016} (5.2 \text{ m/s}) = 7.091 \text{ m/s} \\ \text{Re}_D &= \frac{\rho V_{\max} D}{\mu} = \frac{(1.145 \text{ kg/m}^3)(7.091 \text{ m/s})(0.016 \text{ m})}{1.895 \times 10^{-5} \text{ kg/m}\cdot\text{s}} = 6855 \end{aligned}$$

The average Nusselt number is determined using the proper relation from Table 7-2 to be

$$\begin{aligned} \text{Nu}_D &= 0.27 \text{Re}_D^{0.63} \text{Pr}^{0.36} (\text{Pr}/\text{Pr}_s)^{0.25} \\ &= 0.27(6855)^{0.63} (0.7268)^{0.36} (0.7268/0.7111)^{0.25} = 63.17 \end{aligned}$$

Since $N_L = 20$, which is greater than 16, the average Nusselt number and heat transfer coefficient for all the tubes in the tube bank become

$$\begin{aligned} \text{Nu}_{D,N_L} &= \text{Nu}_D = 63.17 \\ h &= \frac{\text{Nu}_{D,N_L} k}{D} = \frac{63.17(0.02625 \text{ W/m}\cdot^\circ\text{C})}{0.016 \text{ m}} = 103.6 \text{ W/m}^2 \cdot ^\circ\text{C} \end{aligned}$$

The total number of tubes is $N = N_L \times N_T = 20 \times 10 = 200$. For a unit tube length ($L = 1 \text{ m}$), the heat transfer surface area and the mass flow rate of air (evaluated at the inlet) are

$$\begin{aligned} A_s &= N\pi DL = 200\pi(0.016 \text{ m})(1 \text{ m}) = 10.05 \text{ m}^2 \\ \dot{m} &= \dot{m}_i = \rho_i V (N_T S_T L) = (1.204 \text{ kg/m}^3)(5.2 \text{ m/s})(10)(0.06 \text{ m})(1 \text{ m}) = 3.756 \text{ kg/s} \end{aligned}$$

Then the fluid exit temperature, the log mean temperature difference, and the rate of heat transfer become

$$\begin{aligned} T_e &= T_s - (T_s - T_i) \exp\left(-\frac{A_s h}{\dot{m} c_p}\right) = 100 - (100 - 20) \exp\left(-\frac{(10.05 \text{ m}^2)(103.6 \text{ W/m}^2 \cdot ^\circ\text{C})}{(3.756 \text{ kg/s})(1007 \text{ J/kg}\cdot^\circ\text{C})}\right) = 39.25^\circ\text{C} \\ \Delta T_{\ln} &= \frac{(T_s - T_i) - (T_s - T_e)}{\ln[(T_s - T_i)/(T_s - T_e)]} = \frac{(100 - 20) - (100 - 39.25)}{\ln[(100 - 20)/(100 - 39.25)]} = 69.93^\circ\text{C} \\ \dot{Q} &= h A_s \Delta T_{\ln} = (103.6 \text{ W/m}^2 \cdot ^\circ\text{C})(10.05 \text{ m}^2)(69.93^\circ\text{C}) = 72,810 \text{ W} = \mathbf{72.81 \text{ kW}} \end{aligned}$$

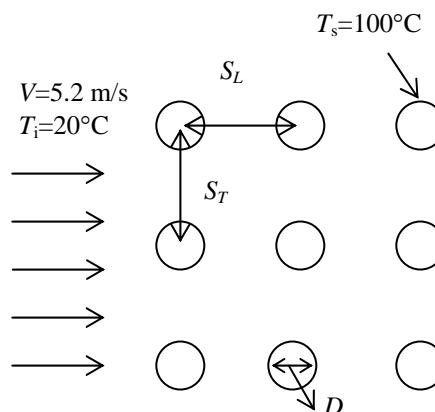

(b) For this in-line arrangement tube bank, the friction coefficient corresponding to $Re_D = 6855$ and $S_L/D = 6/1.6 = 3.75$ is, from Fig. 7-27a, $f = 0.12$. Note that an accurate reading of friction factor does not seem to be possible in this case. Also, $\chi = 1$ for the square arrangements. Then the pressure drop across the tube bank becomes

$$\Delta P = N_L f \chi \frac{\rho V_{\max}^2}{2} = 20(0.12)(1) \frac{(1.145 \text{ kg/m}^3)(7.091 \text{ m/s})^2}{2} \left(\frac{1 \text{ N}}{1 \text{ kg} \cdot \text{m/s}^2} \right) = \mathbf{69.1 \text{ Pa}}$$

(c) The rate of condensation of steam is

$$\dot{Q} = \dot{m}_{\text{cond}} h_{fg @ 100^\circ\text{C}} \longrightarrow \dot{m}_{\text{cond}} = \frac{\dot{Q}}{h_{fg @ 100^\circ\text{C}}} = \frac{72.81 \text{ kW}}{2257 \text{ kJ/kg} \cdot ^\circ\text{C}} = 0.0323 \text{ kg/s} = \mathbf{1.94 \text{ kg/min}}$$

Discussion The arithmetic mean fluid temperature is $(T_i + T_e)/2 = (20 + 43.4)/2 = 31.7^\circ\text{C}$, which is fairly close to the assumed value of 35°C . Therefore, there is no need to repeat calculations.

7-73 Water is preheated by exhaust gases in a tube bank. The rate of heat transfer, the pressure drop of exhaust gases, and the temperature rise of water are to be determined.

Assumptions 1 Steady operating conditions exist. **2** For exhaust gases, air properties are used.

Properties The exit temperature of air, and thus the mean temperature, is not known. We evaluate the air properties at the assumed mean temperature of 250°C (will be checked later) and 1 atm (Table A-15):

$$\begin{aligned} k &= 0.04104 \text{ W/m}\cdot\text{K} & \rho &= 0.6746 \text{ kg/m}^3 \\ c_p &= 1.033 \text{ kJ/kg}\cdot\text{K} & \text{Pr} &= 0.6946 \\ \mu &= 2.76 \times 10^{-5} \text{ kg/m}\cdot\text{s} & \text{Pr}_s &= \text{Pr}_{@ T_s = 80^\circ\text{C}} = 0.7154 \end{aligned}$$

The density of air at the inlet temperature of 300°C (for use in the mass flow rate calculation at the inlet) is $\rho_i = 0.6158 \text{ kg/m}^3$. The specific heat of water at 80°C is 4.197 kJ/kg·°C (Table A-9).

Analysis (a) It is given that $D = 0.021 \text{ m}$, $S_L = S_T = 0.08 \text{ m}$, and $V = 4.5 \text{ m/s}$. Then the maximum velocity and the Reynolds number based on the maximum velocity become

$$V_{\max} = \frac{S_T}{S_T - D} V = \frac{0.08}{0.08 - 0.021} (4.5 \text{ m/s}) = 6.102 \text{ m/s}$$

$$\text{Re}_D = \frac{\rho V_{\max} D}{\mu} = \frac{(0.6746 \text{ kg/m}^3)(6.102 \text{ m/s})(0.021 \text{ m})}{2.76 \times 10^{-5} \text{ kg/m}\cdot\text{s}} = 3132$$

The average Nusselt number is determined using the proper relation from Table 7-2 to be

$$\begin{aligned} \text{Nu}_D &= 0.27 \text{Re}_D^{0.63} \text{Pr}^{0.36} (\text{Pr}/\text{Pr}_s)^{0.25} \\ &= 0.27(3132)^{0.63} (0.6946)^{0.36} (0.6946/0.7154)^{0.25} = 37.46 \end{aligned}$$

Since $N_L = 16$, the average Nusselt number and heat transfer coefficient for all the tubes in the tube bank become

$$\text{Nu}_{D,N_L} = \text{Nu}_D = 37.46$$

$$h = \frac{\text{Nu}_{D,N_L} k}{D} = \frac{37.46(0.04104 \text{ W/m}\cdot^\circ\text{C})}{0.021 \text{ m}} = 73.2 \text{ W/m}^2 \cdot ^\circ\text{C}$$

The total number of tubes is $N = N_L \times N_T = 16 \times 8 = 128$. For a unit tube length ($L = 1 \text{ m}$), the heat transfer surface area and the mass flow rate of air (evaluated at the inlet) are

$$A_s = N\pi DL = 128\pi(0.021 \text{ m})(1 \text{ m}) = 8.445 \text{ m}^2$$

$$\dot{m} = \dot{m}_i = \rho_i V (N_T S_T L) = (0.6158 \text{ kg/m}^3)(4.5 \text{ m/s})(8)(0.08 \text{ m})(1 \text{ m}) = 1.774 \text{ kg/s}$$

Then the fluid exit temperature, the log mean temperature difference, and the rate of heat transfer become

$$T_e = T_s - (T_s - T_i) \exp\left(-\frac{A_s h}{\dot{m} c_p}\right) = 80 - (80 - 300) \exp\left(-\frac{(8.445 \text{ m}^2)(73.2 \text{ W/m}^2 \cdot ^\circ\text{C})}{(1.774 \text{ kg/s})(1033 \text{ J/kg}\cdot^\circ\text{C})}\right) = 237.0^\circ\text{C}$$

$$\Delta T_{\ln} = \frac{(T_s - T_i) - (T_s - T_e)}{\ln[(T_s - T_i)/(T_s - T_e)]} = \frac{(80 - 300) - (80 - 237)}{\ln[(80 - 300)/(80 - 237)]} = 186.7^\circ\text{C}$$

$$\dot{Q} = h A_s \Delta T_{\ln} = (73.2 \text{ W/m}^2 \cdot ^\circ\text{C})(8.445 \text{ m}^2)(186.7^\circ\text{C}) = \mathbf{115,430 \text{ W}}$$

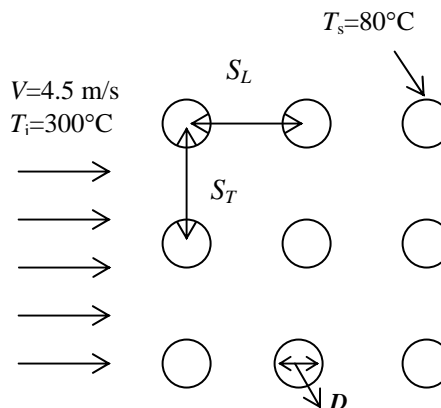

(b) For this in-line arrangement tube bank, the friction coefficient corresponding to $Re_D = 3132$ and $S_L/D = 8/2.1 = 3.81$ is, from Fig. 7-27a, $f = 0.18$. Also, $\chi = 1$ for the square arrangements. Then the pressure drop across the tube bank becomes

$$\Delta P = N_L f \chi \frac{\rho V_{\max}^2}{2} = 16(0.18)(1) \frac{(0.6746 \text{ kg/m}^3)(6.102 \text{ m/s})^2}{2} \left(\frac{1 \text{ N}}{1 \text{ kg} \cdot \text{m/s}^2} \right) = \mathbf{36.2 \text{ Pa}}$$

(c) The temperature rise of water is

$$\dot{Q} = \dot{m}_{\text{water}} c_{p,\text{water}} \Delta T_{\text{water}} \longrightarrow \Delta T_{\text{water}} = \frac{\dot{Q}}{\dot{m}_{\text{water}} c_{p,\text{water}}} = \frac{115.43 \text{ kW}}{(6 \text{ kg/s})(4.197 \text{ kJ/kg} \cdot \text{°C})} = \mathbf{4.6\text{°C}}$$

Discussion The arithmetic mean fluid temperature is $(T_i + T_e)/2 = (300 + 237)/2 = 269\text{°C}$, which is sufficiently close to the assumed value of 250°C . Therefore, there is no need to repeat calculations.

7-74 Water is heated by a bundle of resistance heater rods. The number of tube rows is to be determined.

Assumptions 1 Steady operating conditions exist. 2 The surface temperature of the rods is constant.

Properties The properties of water at the mean temperature of $(15^\circ\text{C} + 65^\circ\text{C})/2 = 40^\circ\text{C}$ are (Table A-9):

$$\begin{aligned} k &= 0.631 \text{ W/m}\cdot\text{K} & \rho &= 992.1 \text{ kg/m}^3 \\ c_p &= 4.179 \text{ kJ/kg}\cdot\text{K} & \text{Pr} &= 4.32 \\ \mu &= 0.653 \times 10^{-3} \text{ kg/m}\cdot\text{s} & \text{Pr}_s &= \text{Pr}_{@ T_s = 90^\circ\text{C}} = 1.96 \end{aligned}$$

Also, the density of water at the inlet temperature of 15°C (for use in the mass flow rate calculation at the inlet) is $\rho_i = 999.1 \text{ kg/m}^3$.

Analysis It is given that $D = 0.01 \text{ m}$, $S_L = 0.04 \text{ m}$ and $S_T = 0.03 \text{ m}$, and $V = 0.8 \text{ m/s}$. Then the maximum velocity and the Reynolds number based on the maximum velocity become

$$V_{\max} = \frac{S_T}{S_T - D} V = \frac{0.03}{0.03 - 0.01} (0.8 \text{ m/s}) = 1.20 \text{ m/s}$$

$$\text{Re}_D = \frac{\rho V_{\max} D}{\mu} = \frac{(992.1 \text{ kg/m}^3)(1.20 \text{ m/s})(0.01 \text{ m})}{0.653 \times 10^{-3} \text{ kg/m}\cdot\text{s}} = 18,232$$

The average Nusselt number is determined using the proper relation from Table 7-2 to be

$$\begin{aligned} \text{Nu}_D &= 0.27 \text{Re}_D^{0.63} \text{Pr}^{0.36} (\text{Pr}/\text{Pr}_s)^{0.25} \\ &= 0.27(18,232)^{0.63} (4.32)^{0.36} (4.32/1.96)^{0.25} = 269.3 \end{aligned}$$

Assuming that $N_L > 16$, the average Nusselt number and heat transfer coefficient for all the tubes in the tube bank become

$$\text{Nu}_{D,N_L} = \text{Nu}_D = 269.3$$

$$h = \frac{\text{Nu}_{D,N_L} k}{D} = \frac{269.3(0.631 \text{ W/m}\cdot^\circ\text{C})}{0.01 \text{ m}} = 16,994 \text{ W/m}^2 \cdot ^\circ\text{C}$$

Consider one-row of tubes in the transverse direction (normal to flow), and thus take $N_T = 1$. Then the heat transfer surface area becomes

$$A_s = N_{\text{tube}} \pi D L = (1 \times N_L) \pi (0.01 \text{ m})(4 \text{ m}) = 0.1257 N_L$$

Then the log mean temperature difference, and the expression for the rate of heat transfer become

$$\Delta T_{\ln} = \frac{(T_s - T_i) - (T_s - T_e)}{\ln[(T_s - T_i)/(T_s - T_e)]} = \frac{(90 - 15) - (90 - 65)}{\ln[(90 - 15)/(90 - 65)]} = 45.51^\circ\text{C}$$

$$\dot{Q} = h A_s \Delta T_{\ln} = (16,994 \text{ W/m}^2 \cdot ^\circ\text{C})(0.1257 N_L)(45.51^\circ\text{C}) = 97,220 N_L$$

The mass flow rate of water through a cross-section corresponding to $N_T = 1$ and the rate of heat transfer are

$$\dot{m} = \rho A_c V = (999.1 \text{ kg/m}^3)(4 \times 0.03 \text{ m}^2)(0.8 \text{ m/s}) = 95.91 \text{ kg/s}$$

$$\dot{Q} = \dot{m} c_p (T_e - T_i) = (95.91 \text{ kg/s})(4179 \text{ J/kg}\cdot^\circ\text{C})(65 - 15)^\circ\text{C} = 2.004 \times 10^7 \text{ W}$$

Substituting this result into the heat transfer expression above we find the number of tube rows

$$\dot{Q} = h A_s \Delta T_{\ln} \rightarrow 2.004 \times 10^7 \text{ W} = 97,220 N_L \rightarrow N_L = \mathbf{206}$$

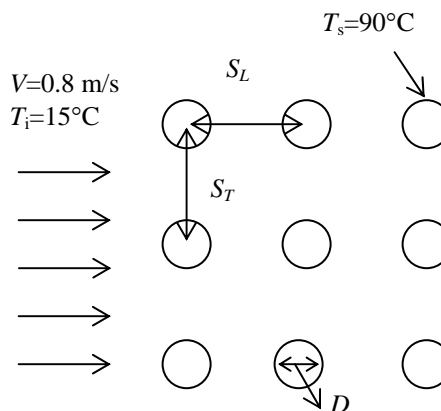

7-75 Air is cooled by an evaporating refrigerator. The refrigeration capacity and the pressure drop across the tube bank are to be determined.

Assumptions 1 Steady operating conditions exist. **2** The surface temperature of the tubes is equal to the temperature of refrigerant.

Properties The exit temperature of air, and thus the mean temperature, is not known. We evaluate the air properties at the assumed mean temperature of -5°C (will be checked later) and 1 atm (Table A-15):

$$\begin{aligned} k &= 0.02326 \text{ W/m}\cdot\text{K} & \rho &= 1.317 \text{ kg/m}^3 \\ c_p &= 1.006 \text{ kJ/kg}\cdot\text{K} & \text{Pr} &= 0.7375 \\ \mu &= 1.705 \times 10^{-5} \text{ kg/m}\cdot\text{s} & \text{Pr}_s &= \text{Pr}_{@ T_s = -20^\circ\text{C}} = 0.7408 \end{aligned}$$

Also, the density of air at the inlet temperature of 0°C (for use in the mass flow rate calculation at the inlet) is $\rho_i = 1.292 \text{ kg/m}^3$.

Analysis It is given that $D = 0.008 \text{ m}$, $S_L = S_T = 0.015 \text{ m}$, and $V = 4 \text{ m/s}$. Then the maximum velocity and the Reynolds number based on the maximum velocity become

$$V_{\max} = \frac{S_T}{S_T - D} V = \frac{0.015}{0.015 - 0.008} (4 \text{ m/s}) = 8.571 \text{ m/s}$$

$$\text{Re}_D = \frac{\rho V_{\max} D}{\mu} = \frac{(1.317 \text{ kg/m}^3)(8.571 \text{ m/s})(0.008 \text{ m})}{1.705 \times 10^{-5} \text{ kg/m}\cdot\text{s}} = 5296$$

The average Nusselt number is determined using the proper relation from Table 7-2 to be

$$\begin{aligned} \text{Nu}_D &= 0.27 \text{Re}_D^{0.63} \text{Pr}^{0.36} (\text{Pr}/\text{Pr}_s)^{0.25} \\ &= 0.27(5296)^{0.63} (0.7375)^{0.36} (0.7375/0.7408)^{0.25} = 53.62 \end{aligned}$$

Since $N_L > 16$, the average Nusselt number and heat transfer coefficient for all the tubes in the tube bank become

$$\text{Nu}_{D,N_L} = F\text{Nu}_D = 53.62$$

$$h = \frac{\text{Nu}_{D,N_L} k}{D} = \frac{53.62(0.02326 \text{ W/m}\cdot^\circ\text{C})}{0.008 \text{ m}} = 155.9 \text{ W/m}^2 \cdot ^\circ\text{C}$$

The total number of tubes is $N = N_L \times N_T = 30 \times 15 = 450$. The heat transfer surface area and the mass flow rate of air (evaluated at the inlet) are

$$A_s = N\pi DL = 450\pi(0.008 \text{ m})(0.4 \text{ m}) = 4.524 \text{ m}^2$$

$$\dot{m} = \dot{m}_i = \rho_i V (N_T S_T L) = (1.292 \text{ kg/m}^3)(4 \text{ m/s})(15)(0.015 \text{ m})(0.4 \text{ m}) = 0.4651 \text{ kg/s}$$

Then the fluid exit temperature, the log mean temperature difference, and the rate of heat transfer (refrigeration capacity) become

$$T_e = T_s - (T_s - T_i) \exp\left(-\frac{A_s h}{\dot{m} c_p}\right) = -20 - (-20 - 0) \exp\left(-\frac{(4.524 \text{ m}^2)(155.9 \text{ W/m}^2 \cdot ^\circ\text{C})}{(0.4651 \text{ kg/s})(1006 \text{ J/kg}\cdot^\circ\text{C})}\right) = -15.57^\circ\text{C}$$

$$\Delta T_{\ln} = \frac{(T_s - T_i) - (T_s - T_e)}{\ln[(T_s - T_i)/(T_s - T_e)]} = \frac{(-20 - 0) - [-20 - (-15.57)]}{\ln[(-20 - 0)/(-20 + 15.57)]} = 10.33^\circ\text{C}$$

$$\dot{Q} = h A_s \Delta T_{\ln} = (155.9 \text{ W/m}^2 \cdot ^\circ\text{C})(4.524 \text{ m}^2)(10.33^\circ\text{C}) = \mathbf{7286 \text{ W}}$$

For this square in-line tube bank, the friction coefficient corresponding to $\text{Re}_D = 5296$ and $S_L/D = 1.5/0.8 = 1.875$ is, from Fig. 7-27a, $f = 0.27$. Also, $\chi = 1$ for the square arrangements. Then the pressure drop across the tube bank becomes

$$\Delta P = N_L f \chi \frac{\rho V_{\max}^2}{2} = 30(0.27)(1) \frac{(1.317 \text{ kg/m}^3)(8.571 \text{ m/s})^2}{2} \left(\frac{1 \text{ N}}{1 \text{ kg}\cdot\text{m/s}^2}\right) = \mathbf{392 \text{ Pa}}$$

Discussion The arithmetic mean fluid temperature is $(T_i + T_e)/2 = (0 - 15.6)/2 = -7.8^\circ\text{C}$, which is fairly close to the assumed value of -5°C . Therefore, there is no need to repeat calculations.

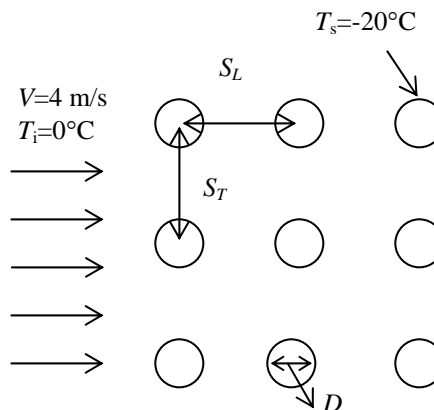

7-76 Air is cooled by an evaporating refrigerator. The refrigeration capacity and the pressure drop across the tube bank are to be determined.

Assumptions 1 Steady operating conditions exist. **2** The surface temperature of the tubes is equal to the temperature of refrigerant.

Properties The exit temperature of air, and thus the mean temperature, is not known. We evaluate the air properties at the assumed mean temperature of -5°C (will be checked later) and 1 atm (Table A-15):

$$\begin{aligned} k &= 0.02326 \text{ W/m}\cdot\text{K} & \rho &= 1.316 \text{ kg/m}^3 \\ c_p &= 1.006 \text{ kJ/kg}\cdot\text{K} & \text{Pr} &= 0.7375 \\ \mu &= 1.705 \times 10^{-5} \text{ kg/m}\cdot\text{s} & \text{Pr}_s &= \text{Pr}_{@T_s = -20^\circ\text{C}} = 0.7408 \end{aligned}$$

Also, the density of air at the inlet temperature of 0°C (for use in the mass flow rate calculation at the inlet) is

$$\rho_i = 1.292 \text{ kg/m}^3.$$

Analysis It is given that $D = 0.008 \text{ m}$, $S_L = S_T = 0.015 \text{ m}$, and $V = 4 \text{ m/s}$. Then the maximum velocity and the Reynolds number based on the maximum velocity become

$$V_{\max} = \frac{S_T}{S_T - D} V = \frac{0.015}{0.015 - 0.008} (4 \text{ m/s}) = 8.571 \text{ m/s}$$

$$\text{Re}_D = \frac{\rho V_{\max} D}{\mu} = \frac{(1.317 \text{ kg/m}^3)(8.571 \text{ m/s})(0.008 \text{ m})}{1.705 \times 10^{-5} \text{ kg/m}\cdot\text{s}} = 5296$$

The average Nusselt number is determined using the proper relation from Table 7-2 to be

$$\begin{aligned} \text{Nu}_D &= 0.35(S_T / S_L)^{0.2} \text{Re}_D^{0.6} \text{Pr}^{0.36} (\text{Pr} / \text{Pr}_s)^{0.25} \\ &= 0.35(0.015 / 0.015)^{0.2} (5296)^{0.6} (0.7375)^{0.36} (0.7375 / 0.7408)^{0.25} = 53.75 \end{aligned}$$

Since $N_L > 16$, the average Nusselt number and heat transfer coefficient for all the tubes in the tube bank become

$$\text{Nu}_{D,N_L} = F\text{Nu}_D = 53.75$$

$$h = \frac{\text{Nu}_{D,N_L} k}{D} = \frac{53.75(0.02326 \text{ W/m}\cdot^\circ\text{C})}{0.008 \text{ m}} = 156.3 \text{ W/m}^2 \cdot ^\circ\text{C}$$

The total number of tubes is $N = N_L \times N_T = 30 \times 15 = 450$. The heat transfer surface area and the mass flow rate of air (evaluated at the inlet) are

$$A_s = N\pi DL = 450\pi(0.008 \text{ m})(0.4 \text{ m}) = 4.524 \text{ m}^2$$

$$\dot{m} = \dot{m}_i = \rho_i V (N_T S_T L) = (1.292 \text{ kg/m}^3)(4 \text{ m/s})(15)(0.015 \text{ m})(0.4 \text{ m}) = 0.4651 \text{ kg/s}$$

Then the fluid exit temperature, the log mean temperature difference, and the rate of heat transfer (refrigeration capacity) become

$$T_e = T_s - (T_s - T_i) \exp\left(-\frac{A_s h}{\dot{m} c_p}\right) = -20 - (-20 - 0) \exp\left(-\frac{(4.524 \text{ m}^2)(156.3 \text{ W/m}^2 \cdot ^\circ\text{C})}{(0.4651 \text{ kg/s})(1006 \text{ J/kg}\cdot^\circ\text{C})}\right) = -15.59^\circ\text{C}$$

$$\Delta T_{\ln} = \frac{(T_s - T_i) - (T_s - T_e)}{\ln[(T_s - T_i)/(T_s - T_e)]} = \frac{(-20 - 0) - [-20 - (-15.59)]}{\ln[(-20 - 0)/(-20 + 15.59)]} = 10.32^\circ\text{C}$$

$$\dot{Q} = hA_s \Delta T_{\ln} = (156.3 \text{ W/m}^2 \cdot ^\circ\text{C})(4.524 \text{ m}^2)(10.31^\circ\text{C}) = \mathbf{7290 \text{ W}}$$

For this staggered arrangement tube bank, the friction coefficient corresponding to $\text{Re}_D = 5296$ and $S_L/D = 1.5/0.8 = 1.875$ is, from Fig. 7-27b, $f = 0.44$. Also, $\chi = 1$ for the square arrangements. Then the pressure drop across the tube bank becomes

$$\Delta P = N_L f \chi \frac{\rho V_{\max}^2}{2} = 30(0.44)(1) \frac{(1.317 \text{ kg/m}^3)(8.571 \text{ m/s})^2}{2} \left(\frac{1 \text{ N}}{1 \text{ kg}\cdot\text{m/s}^2}\right) = \mathbf{639 \text{ Pa}}$$

Discussion The arithmetic mean fluid temperature is $(T_i + T_e)/2 = (0 - 15.6)/2 = -7.8^\circ\text{C}$, which is fairly close to the assumed value of -5°C . Therefore, there is no need to repeat calculations.

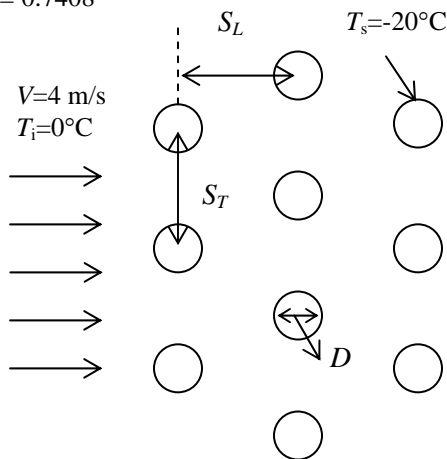

7-77 Air is heated by hot tubes in a tube bank. The average heat transfer coefficient is to be determined.

Assumptions 1 Steady operating conditions exist. 2 The surface temperature of the tubes is constant.

Properties The exit temperature of air, and thus the mean temperature, is not known. We evaluate the air properties at the assumed mean temperature of 70°C and 1 atm (Table A-15):

$$k = 0.02881 \text{ W/m}\cdot\text{K}$$

$$\rho = 1.028 \text{ kg/m}^3$$

$$c_p = 1.007 \text{ kJ/kg}\cdot\text{K}$$

$$\text{Pr} = 0.7177$$

$$\mu = 2.052 \times 10^{-5} \text{ kg/m}\cdot\text{s}$$

$$\text{Pr}_s = \text{Pr}_{@ T_s = 140^\circ\text{C}} = 0.7041$$

Analysis It is given that $D = 0.02 \text{ m}$, $S_L = S_T = 0.06 \text{ m}$, and $V = 6 \text{ m/s}$. Then the maximum velocity and the Reynolds number based on the maximum velocity become

$$V_{\max} = \frac{S_T}{S_T - D} V = \frac{0.06}{0.06 - 0.02} (6 \text{ m/s}) = 9 \text{ m/s}$$

$$\text{Re}_D = \frac{\rho V_{\max} D}{\mu} = \frac{(1.028 \text{ kg/m}^3)(9 \text{ m/s})(0.02 \text{ m})}{2.052 \times 10^{-5} \text{ kg/m}\cdot\text{s}} = 9018$$

The average Nusselt number is determined using the proper relation from Table 7-2 to be

$$\begin{aligned} \text{Nu}_D &= 0.27 \text{Re}_D^{0.63} \text{Pr}^{0.36} (\text{Pr}/\text{Pr}_s)^{0.25} \\ &= 0.27(9018)^{0.63} (0.7177)^{0.36} (0.7177/0.7041)^{0.25} = 74.70 \end{aligned}$$

Since $N_L > 16$, the average Nusselt number and heat transfer coefficient for all the tubes in the tube bank become

$$\text{Nu}_{D,N_L} = \text{Nu}_D = 74.70$$

$$h = \frac{\text{Nu}_{D,N_L} k}{D} = \frac{74.70(0.02881 \text{ W/m}\cdot^\circ\text{C})}{0.02 \text{ m}} = \mathbf{107.6 \text{ W/m}^2 \cdot ^\circ\text{C}}$$

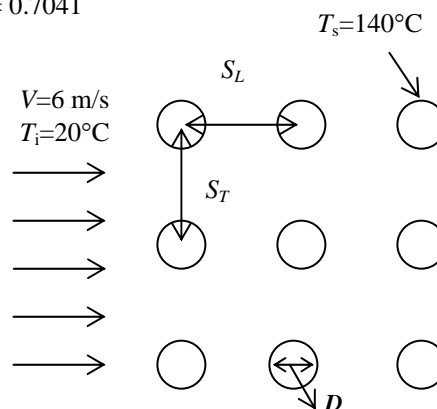

Special Topic: Thermal Insulation

7-78C Thermal insulation is a material that is used primarily to provide resistance to heat flow. It differs from other kinds of insulators in that the purpose of an electrical insulator is to halt the flow of electric current, and the purpose of a sound insulator is to slow down the propagation of sound waves.

7-79C In *cold surfaces* such as chilled water lines, refrigerated trucks, and air conditioning ducts, insulation saves energy since the source of “coldness” is *refrigeration* that requires energy input. In this case heat is transferred from the surroundings to the cold surfaces, and the refrigeration unit must now work harder and longer to make up for this heat gain and thus it must consume more electrical energy.

7-80C The R -value of insulation is the *thermal resistance* of the insulating material *per unit surface area*. For *flat insulation* the R -value is obtained by simply dividing the thickness of the insulation by its thermal conductivity. That is, $R\text{-value} = L/k$. Doubling the thickness L doubles the R -value of flat insulation.

7-81C The R -value of an insulation represents the thermal resistance of insulation *per unit surface area* (or per unit length in the case of pipe insulation).

7-82C Superinsulations are obtained by using layers of highly reflective sheets separated by glass fibers in an evacuated space. Radiation between two surfaces is inversely proportional to the number of sheets used and thus heat loss by radiation will be very low by using this highly reflective sheets. Evacuating the space between the layers forms a vacuum which minimize conduction or convection through the air space.

7-83C Yes, hair or any other cover reduces heat loss from the head, and thus serves as insulation for the head. The insulating ability of hair or feathers is most visible in birds and hairy animals.

7-84C The primary reasons for insulating are energy conservation, personnel protection and comfort, maintaining process temperature, reducing temperature variation and fluctuations, condensation and corrosion prevention, fire protection, freezing protection, and reducing noise and vibration.

7-85C The *optimum* thickness of insulation is the thickness that corresponds to a minimum combined cost of insulation and heat lost. The cost of insulation increases roughly linearly with thickness while the cost of heat lost decreases exponentially. The total cost, which is the sum of the two, decreases first, reaches a minimum, and then increases. The thickness that corresponds to the minimum total cost is the optimum thickness of insulation, and this is the recommended thickness of insulation to be installed.

7-86 The thickness of flat R -8 insulation in SI units is to be determined when the thermal conductivity of the material is known.

Assumptions Thermal properties are constant.

Properties The thermal conductivity of the insulating material is given to be $k = 0.04 \text{ W/m}\cdot^\circ\text{C}$.

Analysis The thickness of flat R -8 insulation (in $\text{m}^2\cdot^\circ\text{C}/\text{W}$) is determined from the definition of R -value to be

$$R_{\text{value}} = \frac{L}{k} \rightarrow L = R_{\text{value}}k = (8 \text{ m}^2\cdot^\circ\text{C}/\text{W})(0.04 \text{ W/m}\cdot^\circ\text{C}) = \mathbf{0.32 \text{ m}}$$



7-87E The thickness of flat R -20 insulation in English units is to be determined when the thermal conductivity of the material is known.

Assumptions Thermal properties are constant.

Properties The thermal conductivity of the insulating material is given to be $k = 0.04 \text{ Btu/h}\cdot\text{ft}\cdot^\circ\text{F}$.

Analysis The thickness of flat R -20 insulation (in $\text{h}\cdot\text{ft}^2\cdot^\circ\text{F}/\text{Btu}$) is determined from the definition of R -value to be

$$R_{\text{value}} = \frac{L}{k} \rightarrow L = R_{\text{value}}k = (20 \text{ h}\cdot\text{ft}^2\cdot^\circ\text{F}/\text{Btu})(0.04 \text{ Btu/h}\cdot\text{ft}\cdot^\circ\text{F}) = \mathbf{0.8 \text{ ft}}$$



7-88 A steam pipe is to be covered with enough insulation to reduce the exposed surface temperature to 30°C . The thickness of insulation that needs to be installed is to be determined.

Assumptions **1** Heat transfer is steady since there is no indication of any change with time. **2** Heat transfer is one-dimensional since there is thermal symmetry about the centerline and no variation in the axial direction. **3** Thermal properties are constant. **4** The thermal contact resistance at the interface is negligible.

Properties The thermal conductivities are given to be $k = 52 \text{ W/m}\cdot^\circ\text{C}$ for cast iron pipe and $k = 0.038 \text{ W/m}\cdot^\circ\text{C}$ for fiberglass insulation.

Analysis The thermal resistance network for this problem involves 4 resistances in series. The inner radius of the pipe is $r_1 = 2.0 \text{ cm}$ and the outer radius of the pipe and thus the inner radius of insulation is $r_2 = 2.3 \text{ cm}$. Letting r_3 represent the outer radius of insulation, the areas of the surfaces exposed to convection for a $L = 1 \text{ m}$ long section of the pipe become

$$A_1 = 2\pi r_1 L = 2\pi(0.02 \text{ m})(1 \text{ m}) = 0.1257 \text{ m}^2$$

$$A_3 = 2\pi r_3 L = 2\pi r_3 (1 \text{ m}) = 2\pi r_3 \text{ m}^2 \quad (r_3 \text{ in m})$$

Then the individual thermal resistances are determined to be

$$R_i = R_{\text{conv},1} = \frac{1}{h_i A_1} = \frac{1}{(80 \text{ W/m}^2 \cdot ^\circ\text{C})(0.1257 \text{ m}^2)} = 0.09944 \text{ }^\circ\text{C/W}$$

$$R_1 = R_{\text{pipe}} = \frac{\ln(r_2 / r_1)}{2\pi k_1 L} = \frac{\ln(0.023 / 0.02)}{2\pi(52 \text{ W/m}\cdot^\circ\text{C})(1 \text{ m})} = 0.00043 \text{ }^\circ\text{C/W}$$

$$R_2 = R_{\text{insulation}} = \frac{\ln(r_3 / r_2)}{2\pi k_2 L} = \frac{\ln(r_3 / 0.023)}{2\pi(0.038 \text{ W/m}\cdot^\circ\text{C})(1 \text{ m})} = 4.188 \ln(r_3 / 0.023) \text{ }^\circ\text{C/W}$$

$$R_o = R_{\text{conv},2} = \frac{1}{h_o A_3} = \frac{1}{(22 \text{ W/m}^2 \cdot ^\circ\text{C})(2\pi r_3 \text{ m}^2)} = \frac{1}{138.2 r_3} \text{ }^\circ\text{C/W}$$

Noting that all resistances are in series, the total resistance is

$$R_{\text{total}} = R_i + R_1 + R_2 + R_o = 0.09944 + 0.00043 + 4.188 \ln(r_3 / 0.023) + 1/(138.2 r_3) \text{ }^\circ\text{C/W}$$

Then the steady rate of heat loss from the steam becomes

$$\dot{Q} = \frac{T_i - T_o}{R_{\text{total}}} = \frac{(110 - 22)^\circ\text{C}}{[0.09944 + 0.00043 + 4.188 \ln(r_3 / 0.023) + 1/(138.2 r_3)]^\circ\text{C/W}}$$

Noting that the outer surface temperature of insulation is specified to be 30°C , the rate of heat loss can also be expressed as

$$\dot{Q} = \frac{T_3 - T_o}{R_o} = \frac{(30 - 22)^\circ\text{C}}{1/(138.2 r_3)^\circ\text{C/W}} = 1106 r_3$$

Setting the two relations above equal to each other and solving for r_3 gives $r_3 = 0.0362 \text{ m}$. Then the minimum thickness of fiberglass insulation required is

$$t = r_3 - r_2 = 0.0362 - 0.0230 = 0.0132 \text{ m} = \mathbf{1.32 \text{ cm}}$$

Therefore, insulating the pipe with at least 1.32 cm thick fiberglass insulation will ensure that the outer surface temperature of the pipe will be at 30°C or below.

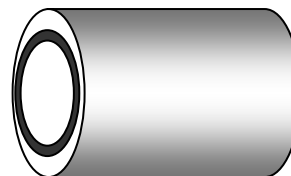
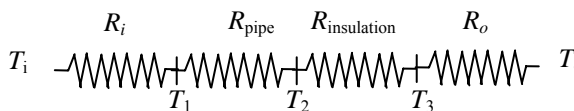

7-89 EES Prob. 7-88 is reconsidered. The thickness of the insulation as a function of the maximum temperature of the outer surface of insulation is to be plotted.

Analysis The problem is solved using EES, and the solution is given below.

"GIVEN"

T_i=110 [C]
 T_o=22 [C]
 k_pipe=52 [W/m-C]
 r_1=0.02 [m]
 t_pipe=0.003 [m]
 T_s_max=30 [C]
 h_i=80 [W/m^2-C]
 h_o=22 [W/m^2-C]
 k_ins=0.038 [W/m-C]

"ANALYSIS"

L=1 [m] "1 m long section of the pipe is considered"
 A_i=2*pi*r_1*L
 A_o=2*pi*r_3*L
 r_3=r_2+t_ins*Convert(cm, m) "t_ins is in cm"
 r_2=r_1+t_pipe
 R_conv_i=1/(h_i*A_i)
 R_pipe=ln(r_2/r_1)/(2*pi*k_pipe*L)
 R_ins=ln(r_3/r_2)/(2*pi*k_ins*L)
 R_conv_o=1/(h_o*A_o)
 R_total=R_conv_i+R_pipe+R_ins+R_conv_o
 Q_dot=(T_i-T_o)/R_total
 Q_dot=(T_s_max-T_o)/R_conv_o

T _{s,max} [C]	t _{ins} [cm]
24	4.45
26	2.489
28	1.733
30	1.319
32	1.055
34	0.871
36	0.7342
38	0.6285
40	0.5441
42	0.4751
44	0.4176
46	0.3688
48	0.327

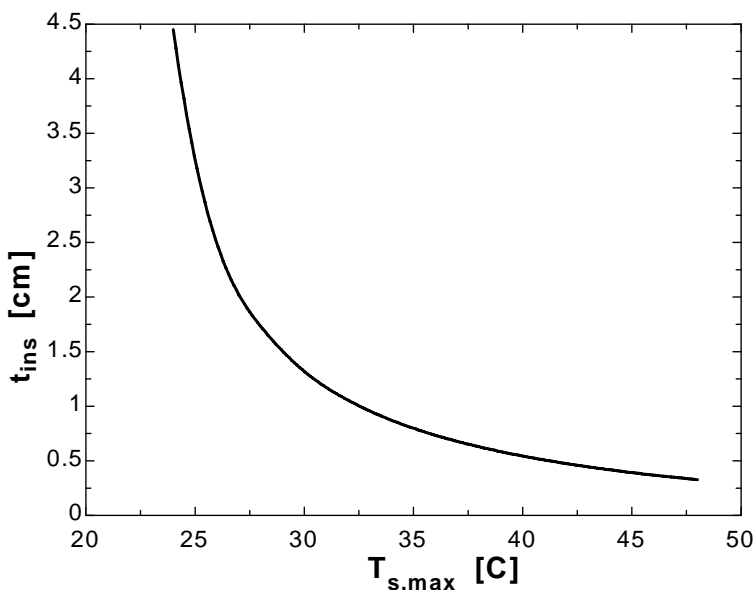

7-90 A cylindrical oven is to be insulated to reduce heat losses. The optimum thickness of insulation and the amount of money saved per year are to be determined.

Assumptions 1 Steady operating conditions exist. 2 Heat transfer through the insulation is one-dimensional. 3 Thermal conductivities are constant. 4 The thermal contact resistance at the interface is negligible. 5 The surface temperature of the furnace and the heat transfer coefficient remain constant. 6 The surfaces of the cylindrical oven can be treated as plain surfaces since its diameter is greater than 1 m.

Properties The thermal conductivity of insulation is given to be $k = 0.038 \text{ W/m}\cdot^\circ\text{C}$.

Analysis We treat the surfaces of this cylindrical furnace as plain surfaces since its diameter is greater than 1 m, and disregard the curvature effects. The exposed surface area of the furnace is

$$A_o = 2A_{\text{base}} + A_{\text{side}} = 2\pi r^2 + 2\pi rL = 2\pi(1.5 \text{ m})^2 + 2\pi(1.5 \text{ m})(6 \text{ m}) = 70.69 \text{ m}^2$$

The rate of heat loss from the furnace before the insulation is installed is

$$\dot{Q} = h_o A_o (T_s - T_\infty) = (30 \text{ W/m}^2 \cdot ^\circ\text{C})(70.69 \text{ m}^2)(90 - 27)^\circ\text{C} = 133,600 \text{ W}$$

Noting that the plant operates $52 \times 80 = 4160 \text{ h/yr}$, the annual heat lost from the furnace is

$$Q = \dot{Q}\Delta t = (133.6 \text{ kJ/s})(4160 \times 3600 \text{ s/yr}) = 2.001 \times 10^9 \text{ kJ/yr}$$

The efficiency of the furnace is given to be 78 percent. Therefore, to generate this much heat, the furnace must consume energy (in the form of natural gas) at a rate of

$$Q_{\text{in}} = Q / \eta_{\text{oven}} = (2.001 \times 10^9 \text{ kJ/yr}) / 0.78 = 2.565 \times 10^9 \text{ kJ/yr} = 24,314 \text{ therms/yr}$$

since 1 therm = 105,500 kJ. Then the annual fuel cost of this furnace before insulation becomes

$$\text{Annual Cost} = Q_{\text{in}} \times \text{Unit cost} = (24,314 \text{ therm/yr})(\$0.50/\text{therm}) = \$12,157/\text{yr}$$

We expect the surface temperature of the furnace to increase, and the heat transfer coefficient to decrease somewhat when insulation is installed. We assume these two effects to counteract each other. Then the rate of heat loss for 1-cm thick insulation becomes

$$\dot{Q}_{\text{ins}} = \frac{T_s - T_\infty}{R_{\text{total}}} = \frac{T_s - T_\infty}{R_{\text{ins}} + R_{\text{conv}}} = \frac{A_o (T_s - T_\infty)}{\frac{t_{\text{ins}}}{k_{\text{ins}}} + \frac{1}{h_o}} = \frac{(70.69 \text{ m}^2)(90 - 27)^\circ\text{C}}{\frac{0.01 \text{ m}}{0.038 \text{ W/m}\cdot^\circ\text{C}} + \frac{1}{30 \text{ W/m}^2 \cdot ^\circ\text{C}}} = 15,021 \text{ W}$$

Also, the total amount of heat loss from the furnace per year and the amount and cost of energy consumption of the furnace become

$$Q_{\text{ins}} = \dot{Q}_{\text{ins}} \Delta t = (15,021 \text{ kJ/s})(4160 \times 3600 \text{ s/yr}) = 2.249 \times 10^8 \text{ kJ/yr}$$

$$Q_{\text{in,ins}} = Q_{\text{ins}} / \eta_{\text{oven}} = (2.249 \times 10^8 \text{ kJ/yr}) / 0.78 = 2.884 \times 10^8 \text{ kJ/yr} = 2734 \text{ therms}$$

$$\text{Annual Cost} = Q_{\text{in,ins}} \times \text{Unit cost} = (2734 \text{ therm/yr})(\$0.50/\text{therm}) = \$1367/\text{yr}$$

$$\text{Cost savings} = \text{Energy cost w/o insulation} - \text{Energy cost w/insulation} = 12,157 - 1367 = \$10,790/\text{yr}$$

The unit cost of insulation is given to be $\$10/\text{m}^2$ per cm thickness, plus $\$30/\text{m}^2$ for labor. Then the total cost of insulation becomes

$$\text{Insulation Cost} = (\text{Unit cost})(\text{Surface area}) = [(\$10/\text{cm})(1 \text{ cm}) + \$30/\text{m}^2](70.69 \text{ m}^2) = \$2828$$

To determine the thickness of insulation whose cost is equal to annual energy savings, we repeat the calculations above for 2, 3, 15 cm thick insulations, and list the results in the table below.

Insulation thickness	Rate of heat loss W	Cost of heat lost \$/yr	Cost savings \$/yr	Insulation cost \$
0 cm	133,600	12,157	0	0
1 cm	15,021	1367	10,790	2828
5 cm	3301	300	11,850	3535
10 cm	1671	152	12,005	9189
11 cm	1521	138	12,019	9897
12 cm	1396	127	12,030	10,604
13 cm	1289	117	12,040	11,310
14 cm	1198	109	12,048	12,017
15 cm	1119	102	12,055	12,724

Therefore, the thickest insulation that will pay for itself in one year is the one whose thickness is **14 cm**.

7-91 A cylindrical oven is to be insulated to reduce heat losses. The optimum thickness of insulation and the amount of money saved per year are to be determined.

Assumptions 1 Steady operating conditions exist. 2 Heat transfer through the insulation is one-dimensional. 3 Thermal conductivities are constant. 4 The thermal contact resistance at the interface is negligible. 5 The surface temperature of the furnace and the heat transfer coefficient remain constant. 6 The surfaces of the cylindrical oven can be treated as plain surfaces since its diameter is greater than 1 m.

Properties The thermal conductivity of insulation is given to be $k = 0.038 \text{ W/m}\cdot\text{C}$.

Analysis We treat the surfaces of this cylindrical furnace as plain surfaces since its diameter is greater than 1 m, and disregard the curvature effects. The exposed surface area of the furnace is

$$A_o = 2A_{\text{base}} + A_{\text{side}} = 2\pi r^2 + 2\pi rL = 2\pi(1.5 \text{ m})^2 + 2\pi(1.5 \text{ m})(6 \text{ m}) = 70.69 \text{ m}^2$$

The rate of heat loss from the furnace before the insulation is installed is

$$\dot{Q} = h_o A_o (T_s - T_\infty) = (30 \text{ W/m}^2 \cdot \text{C})(70.69 \text{ m}^2)(75 - 27)^\circ\text{C} = 101,794 \text{ W}$$

Noting that the plant operates $52 \times 80 = 4160 \text{ h/yr}$, the annual heat lost from the furnace is

$$Q = \dot{Q}\Delta t = (101.794 \text{ kJ/s})(4160 \times 3600 \text{ s/yr}) = 1.524 \times 10^9 \text{ kJ/yr}$$

The efficiency of the furnace is given to be 78 percent.

Therefore, to generate this much heat, the furnace must consume energy (in the form of natural gas) at a rate of

$$Q_{\text{in}} = Q / \eta_{\text{oven}} = (1.524 \times 10^9 \text{ kJ/yr}) / 0.78 = 1.954 \times 10^9 \text{ kJ/yr} = 18,526 \text{ therms/yr}$$

since 1 therm = 105,500 kJ. Then the annual fuel cost of this furnace before insulation becomes

$$\text{Annual Cost} = Q_{\text{in}} \times \text{Unit cost} = (18,526 \text{ therm/yr})(\$0.50/\text{therm}) = \$9,263/\text{yr}$$

We expect the surface temperature of the furnace to increase, and the heat transfer coefficient to decrease somewhat when insulation is installed. We assume these two effects to counteract each other. Then the rate of heat loss for 1-cm thick insulation becomes

$$\dot{Q}_{\text{ins}} = \frac{T_s - T_\infty}{R_{\text{total}}} = \frac{T_s - T_\infty}{R_{\text{ins}} + R_{\text{conv}}} = \frac{A_o (T_s - T_\infty)}{\frac{t_{\text{ins}}}{k_{\text{ins}}} + \frac{1}{h_o}} = \frac{(70.69 \text{ m}^2)(75 - 27)^\circ\text{C}}{\frac{0.01 \text{ m}}{0.038 \text{ W/m}\cdot\text{C}} + \frac{1}{30 \text{ W/m}^2 \cdot \text{C}}} = 11,445 \text{ W}$$

Also, the total amount of heat loss from the furnace per year and the amount and cost of energy consumption of the furnace become

$$Q_{\text{ins}} = \dot{Q}_{\text{ins}} \Delta t = (11.445 \text{ kJ/s})(4160 \times 3600 \text{ s/yr}) = 1.714 \times 10^8 \text{ kJ/yr}$$

$$Q_{\text{in,ins}} = Q_{\text{ins}} / \eta_{\text{oven}} = (1.714 \times 10^8 \text{ kJ/yr}) / 0.78 = 2.197 \times 10^8 \text{ kJ/yr} = 2082 \text{ therms}$$

$$\text{Annual Cost} = Q_{\text{in,ins}} \times \text{Unit cost} = (2082 \text{ therm/yr})(\$0.50/\text{therm}) = \$1041/\text{yr}$$

$$\text{Cost savings} = \text{Energy cost w/o insulation} - \text{Energy cost w/insulation} = 9263 - 1041 = \$8222/\text{yr}$$

The unit cost of insulation is given to be $\$10/\text{m}^2$ per cm thickness, plus $\$30/\text{m}^2$ for labor. Then the total cost of insulation becomes

$$\text{Insulation Cost} = (\text{Unit cost})(\text{Surface area}) = [(\$10/\text{cm})(1 \text{ cm}) + \$30/\text{m}^2](70.69 \text{ m}^2) = \$2828$$

To determine the thickness of insulation whose cost is equal to annual energy savings, we repeat the calculations above for 2, 3, . . . 15 cm thick insulations, and list the results in the table below.

Insulation Thickness	Rate of heat loss W	Cost of heat lost \$/yr	Cost savings \$/yr	Insulation cost \$
0 cm	101,794	9263	0	0
1 cm	11,445	1041	8222	2828
5 cm	2515	228	9035	3535
9 cm	1413	129	9134	8483
10 cm	1273	116	9147	9189
11 cm	1159	105	9158	9897
12 cm	1064	97	9166	10,604

Therefore, the thickest insulation that will pay for itself in one year is the one whose thickness is **9 cm**. The 10-cm thick insulation will come very close to paying for itself in one year.

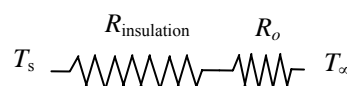
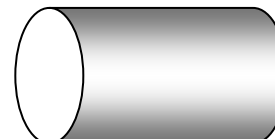

7-92E Steam is flowing through an insulated steel pipe, and it is proposed to add another 1-in thick layer of fiberglass insulation on top of the existing one to reduce the heat losses further and to save energy and money. It is to be determined if the new insulation will pay for itself within 2 years.

Assumptions 1 Heat transfer is steady since there is no indication of any change with time. 2 Heat transfer is one-dimensional since there is thermal symmetry about the centerline and no variation in the axial direction. 3 Thermal properties are constant. 4 The heat transfer coefficients remain constant. 5 The thermal contact resistance at the interface is negligible.

Properties The thermal conductivities are given to be $k = 8.7 \text{ Btu/h}\cdot\text{ft}\cdot^\circ\text{F}$ for steel pipe and $k = 0.020 \text{ Btu/h}\cdot\text{ft}\cdot^\circ\text{F}$ for fiberglass insulation.

Analysis The inner radius of the pipe is $r_1 = 1.75 \text{ in}$, the outer radius of the pipe is $r_2 = 2 \text{ in}$, and the outer radii of the existing and proposed insulation layers are $r_3 = 3 \text{ in}$ and 4 in , respectively. Considering a unit pipe length of $L = 1 \text{ ft}$, the individual thermal resistances are determined to be

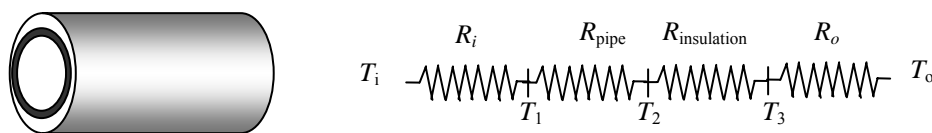

$$R_i = R_{\text{conv},1} = \frac{1}{h_i A_1} = \frac{1}{h_i (2\pi r_1 L)} = \frac{1}{(30 \text{ Btu/h}\cdot\text{ft}^2\cdot^\circ\text{F})[2\pi(1.75/12 \text{ ft})(1 \text{ ft})]} = 0.0364 \text{ h}\cdot^\circ\text{F/Btu}$$

$$R_1 = R_{\text{pipe}} = \frac{\ln(r_2 / r_1)}{2\pi k_1 L} = \frac{\ln(2 / 1.75)}{2\pi(8.7 \text{ Btu/h}\cdot\text{ft}\cdot^\circ\text{F})(1 \text{ ft})} = 0.00244 \text{ h}\cdot^\circ\text{F/Btu}$$

Current Case:

$$R_{\text{insulation}} = \frac{\ln(r_3 / r_2)}{2\pi k_{\text{ins}} L} = \frac{\ln(3 / 2)}{2\pi(0.020 \text{ Btu/h}\cdot\text{ft}\cdot^\circ\text{F})(1 \text{ ft})} = 3.227 \text{ h}\cdot^\circ\text{F/Btu}$$

$$R_o = R_{\text{conv},2} = \frac{1}{h_o A_3} = \frac{1}{h_o (2\pi r_3)} = \frac{1}{(5 \text{ Btu/h}\cdot\text{ft}^2\cdot^\circ\text{F})[2\pi(3 / 12 \text{ ft})(1 \text{ ft})]} = 0.1273 \text{ h}\cdot^\circ\text{F/Btu}$$

Then the steady rate of heat loss from the steam becomes

$$\dot{Q}_{\text{current}} = \frac{\Delta T}{R_{\text{total}}} = \frac{T_i - T_o}{R_i + R_{\text{pipe}} + R_{\text{ins}} + R_o} = \frac{(300 - 85)^\circ\text{F}}{(0.0364 + 0.00244 + 3.227 + 0.1273) \text{ h}\cdot^\circ\text{F/Btu}} = 63.36 \text{ Btu/h}$$

Proposed Case:

$$R_{\text{insulation}} = \frac{\ln(r_3 / r_2)}{2\pi k_{\text{ins}} L} = \frac{\ln(4 / 2)}{2\pi(0.020 \text{ Btu/h}\cdot\text{ft}\cdot^\circ\text{F})(1 \text{ ft})} = 5.516 \text{ h}\cdot^\circ\text{F/Btu}$$

$$R_o = R_{\text{conv},2} = \frac{1}{h_o A_3} = \frac{1}{h_o (2\pi r_3)} = \frac{1}{(5 \text{ Btu/h}\cdot\text{ft}^2\cdot^\circ\text{F})[2\pi(4 / 12 \text{ ft})(1 \text{ ft})]} = 0.0955 \text{ h}\cdot^\circ\text{F/Btu}$$

Then the steady rate of heat loss from the steam becomes

$$\dot{Q}_{\text{prop}} = \frac{\Delta T}{R_{\text{total}}} = \frac{T_i - T_o}{R_i + R_{\text{pipe}} + R_{\text{ins}} + R_o} = \frac{(300 - 85)^\circ\text{F}}{(0.0364 + 0.00244 + 5.516 + 0.0955) \text{ h}\cdot^\circ\text{F/Btu}} = 38.05 \text{ Btu/h}$$

Therefore, the amount of energy and money saved by the additional insulation per year are

$$\dot{Q}_{\text{saved}} = \dot{Q}_{\text{prop}} - \dot{Q}_{\text{current}} = 63.36 - 38.05 = 25.31 \text{ Btu/h}$$

$$Q_{\text{saved}} = \dot{Q}_{\text{saved}} \Delta t = (25.31 \text{ Btu/h})(8760 \text{ h/yr}) = 221,700 \text{ Btu/yr}$$

$$\text{Money saved} = Q_{\text{saved}} \times (\text{Unit cost}) = (221,700 \text{ Btu/yr})(\$0.01 / 1000 \text{ Btu}) = \$2.22 / \text{yr}$$

or \$4.44 per 2 years, which is less than the \$7.0 minimum required. Therefore, the criterion is not satisfied, and the proposed additional insulation is **not justified**.

7-93 The plumbing system of a plant involves some section of a plastic pipe exposed to the ambient air. The pipe is to be insulated with adequate fiber glass insulation to prevent freezing of water in the pipe. The thickness of insulation that will protect the water from freezing under worst conditions is to be determined.

Assumptions 1 Heat transfer is transient, but can be treated as steady at average conditions. **2** Heat transfer is one-dimensional since there is thermal symmetry about the centerline and no variation in the axial direction. **3** Thermal properties are constant. **4** The water in the pipe is stationary, and its initial temperature is 15°C. **5** The thermal contact resistance at the interface is negligible. **6** The convection resistance inside the pipe is negligible.

Properties The thermal conductivities are given to be $k = 0.16 \text{ W/m}\cdot\text{°C}$ for plastic pipe and $k = 0.035 \text{ W/m}\cdot\text{°C}$ for fiberglass insulation. The density and specific heat of water are $\rho = 1000 \text{ kg/m}^3$ and $c_p = 4.18 \text{ kJ/kg}\cdot\text{°C}$ (Table A-15).

Analysis The inner radius of the pipe is $r_1 = 3.0 \text{ cm}$ and the outer radius of the pipe and thus the inner radius of insulation is $r_2 = 3.3 \text{ cm}$. We let r_3 represent the outer radius of insulation. Considering a 1-m section of the pipe, the amount of heat that must be transferred from the water as it cools from 15 to 0°C is determined to be

$$m = \rho V = \rho(\pi r_1^2 L) = (1000 \text{ kg/m}^3)[\pi(0.03 \text{ m})^2 (1 \text{ m})] = 2.827 \text{ kg}$$

$$Q_{\text{total}} = mc_p \Delta T = (2.827 \text{ kg})(4.18 \text{ kJ/kg}\cdot\text{°C})(15 - 0)\text{°C} = 177.3 \text{ kJ}$$

Then the average rate of heat transfer during 60 h becomes

$$\dot{Q}_{\text{ave}} = \frac{Q_{\text{total}}}{\Delta t} = \frac{177,300 \text{ J}}{(60 \times 3600 \text{ s})} = 0.821 \text{ W}$$

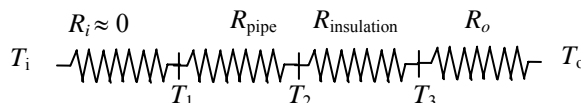

The individual thermal resistances are

$$R_1 = R_{\text{pipe}} = \frac{\ln(r_2 / r_1)}{2\pi k_{\text{pipe}} L} = \frac{\ln(0.033 / 0.03)}{2\pi(0.16 \text{ W/m}\cdot\text{°C})(1 \text{ m})} = 0.0948 \text{ °C/W}$$

$$R_{\text{insulation}} = \frac{\ln(r_3 / r_2)}{2\pi k_2 L} = \frac{\ln(r_3 / 0.033)}{2\pi(0.035 \text{ W/m}\cdot\text{°C})(1 \text{ m})} = 4.55 \ln(r_3 / 0.033) \text{ °C/W}$$

$$R_o = R_{\text{conv}} = \frac{1}{h_o A_3} = \frac{1}{(30 \text{ W/m}^2\cdot\text{°C})(2\pi r_3 \text{ m}^2)} = \frac{1}{188.5 r_3} \text{ °C/W}$$

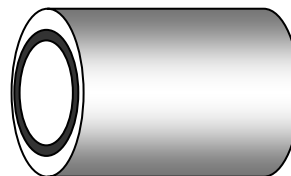

Then the rate of average heat transfer from the water can be expressed as

$$\dot{Q} = \frac{T_{i,\text{ave}} - T_o}{R_{\text{total}}} \rightarrow 0.821 \text{ W} = \frac{[7.5 - (-10)]\text{°C}}{[0.0948 + 4.55 \ln(r_3 / 0.033) + 1/(188.5 r_3)]\text{°C/W}} \rightarrow r_3 = 3.50 \text{ m}$$

Therefore, the minimum thickness of fiberglass needed to protect the pipe from freezing is

$$t = r_3 - r_2 = 3.50 - 0.033 = \mathbf{3.467 \text{ m}}$$

which is too large. Installing such a thick insulation is not practical, however, and thus other freeze protection methods should be considered.

7-94 The plumbing system of a plant involves some section of a plastic pipe exposed to the ambient air. The pipe is to be insulated with adequate fiber glass insulation to prevent freezing of water in the pipe. The thickness of insulation that will protect the water from freezing more than 20% under worst conditions is to be determined.

Assumptions **1** Heat transfer is transient, but can be treated as steady at average conditions. **2** Heat transfer is one-dimensional since there is thermal symmetry about the centerline and no variation in the axial direction. **3** Thermal properties are constant. **4** The water in the pipe is stationary, and its initial temperature is 15°C. **5** The thermal contact resistance at the interface is negligible. **6** The convection resistance inside the pipe is negligible.

Properties The thermal conductivities are given to be $k = 0.16 \text{ W/m}\cdot\text{°C}$ for plastic pipe and $k = 0.035 \text{ W/m}\cdot\text{°C}$ for fiberglass insulation. The density and specific heat of water are $\rho = 1000 \text{ kg/m}^3$ and $C_p = 4.18 \text{ kJ/kg}\cdot\text{°C}$ (Table A-15). The latent heat of freezing of water is 333.7 kJ/kg .

Analysis The inner radius of the pipe is $r_1 = 3.0 \text{ cm}$ and the outer radius of the pipe and thus the inner radius of insulation is $r_2 = 3.3 \text{ cm}$. We let r_3 represent the outer radius of insulation. Considering a 1-m section of the pipe, the amount of heat that must be transferred from the water as it cools from 15 to 0°C is determined to be

$$m = \rho V = \rho(\pi r_1^2 L) = (1000 \text{ kg/m}^3)[\pi(0.03 \text{ m})^2 (1 \text{ m})] = 2.827 \text{ kg}$$

$$Q_{\text{total}} = mc_p \Delta T = (2.827 \text{ kg})(4.18 \text{ kJ/kg}\cdot\text{°C})(15 - 0)\text{°C} = 177.3 \text{ kJ}$$

$$Q_{\text{freezing}} = 0.2 \times mh_{if} = 0.2 \times (2.827 \text{ kg})(333.7 \text{ kJ/kg}) = 188.7 \text{ kJ}$$

$$Q_{\text{total}} = Q_{\text{cooling}} + Q_{\text{freezing}} = 177.3 + 188.7 = 366.0 \text{ kJ}$$

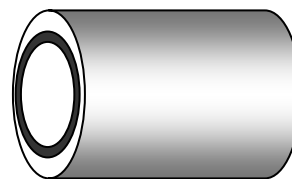

Then the average rate of heat transfer during 60 h becomes

$$\dot{Q}_{\text{avg}} = \frac{Q_{\text{total}}}{\Delta t} = \frac{366,000 \text{ J}}{(60 \times 3600 \text{ s})} = 1.694 \text{ W}$$

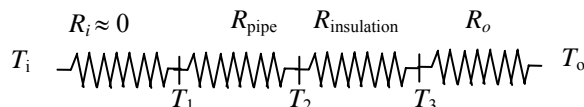

The individual thermal resistances are

$$R_1 = R_{\text{pipe}} = \frac{\ln(r_2 / r_1)}{2\pi k_{\text{pipe}} L} = \frac{\ln(0.033 / 0.03)}{2\pi(0.16 \text{ W/m}\cdot\text{°C})(1 \text{ m})} = 0.0948 \text{ °C/W}$$

$$R_{\text{insulation}} = \frac{\ln(r_3 / r_2)}{2\pi k_2 L} = \frac{\ln(r_3 / 0.033)}{2\pi(0.035 \text{ W/m}\cdot\text{°C})(1 \text{ m})} = 4.55 \ln(r_3 / 0.033) \text{ °C/W}$$

$$R_o = R_{\text{conv}} = \frac{1}{h_o A_3} = \frac{1}{(30 \text{ W/m}^2\cdot\text{°C})(2\pi r_3 \text{ m}^2)} = \frac{1}{188.5 r_3} \text{ °C/W}$$

Then the rate of average heat transfer from the water can be expressed as

$$\dot{Q} = \frac{T_{i,\text{avg}} - T_o}{R_{\text{total}}} \rightarrow 1.694 \text{ W} = \frac{[7.5 - (-10)]\text{°C}}{[0.0948 + 4.55 \ln(r_3 / 0.033) + 1/(188.5 r_3)]\text{°C/W}} \rightarrow r_3 = 0.312 \text{ m}$$

Therefore, the minimum thickness of fiberglass needed to protect the pipe from freezing is

$$t = r_3 - r_2 = 0.312 - 0.033 = \mathbf{0.279 \text{ m}}$$

which is too large. Installing such a thick insulation is not practical, however, and thus other freeze protection methods should be considered.

Review Problems

7-95 Wind is blowing parallel to the walls of a house. The rate of heat loss from the wall is to be determined.

Assumptions 1 Steady operating conditions exist. 2 The critical Reynolds number is $Re_{cr} = 5 \times 10^5$. 3 Radiation effects are negligible. 4 Air is an ideal gas with constant properties. 5 The pressure of air is 1 atm.

Properties Assuming a film temperature of $T_f = 10^\circ\text{C}$ for the outdoors, the properties of air are evaluated to be (Table A-15)

$$k = 0.02439 \text{ W/m}\cdot^\circ\text{C}$$

$$\nu = 1.426 \times 10^{-5} \text{ m}^2/\text{s}$$

$$Pr = 0.7336$$

Analysis Air flows along 8-m side. The Reynolds number in this case is

$$Re_L = \frac{VL}{\nu} = \frac{[(50 \times 1000 / 3600) \text{ m/s}](8 \text{ m})}{1.426 \times 10^{-5} \text{ m}^2/\text{s}} = 7.792 \times 10^6$$

which is greater than the critical Reynolds number. Thus we have combined laminar and turbulent flow. Using the proper relation for Nusselt number, heat transfer coefficient is determined to be

$$Nu = \frac{h_o L}{k} = (0.037 Re_L^{0.8} - 871) Pr^{1/3} = [0.037(7.792 \times 10^6)^{0.8} - 871](0.7336)^{1/3} = 10,096$$

$$h_o = \frac{k}{L} Nu = \frac{0.02439 \text{ W/m}\cdot^\circ\text{C}}{8 \text{ m}} (10,096) = 30.78 \text{ W/m}^2\cdot^\circ\text{C}$$

The thermal resistances are

$$A_s = wL = (4 \text{ m})(8 \text{ m}) = 32 \text{ m}^2$$

$$R_i = \frac{1}{h_i A_s} = \frac{1}{(8 \text{ W/m}^2\cdot^\circ\text{C})(32 \text{ m}^2)} = 0.0039 \text{ }^\circ\text{C/W}$$

$$R_{insulation} = \frac{(R - 3.38)_{value}}{A_s} = \frac{3.38 \text{ m}^2\cdot^\circ\text{C/W}}{32 \text{ m}^2} = 0.1056 \text{ }^\circ\text{C/W}$$

$$R_o = \frac{1}{h_o A_s} = \frac{1}{(30.78 \text{ W/m}^2\cdot^\circ\text{C})(32 \text{ m}^2)} = 0.0010 \text{ }^\circ\text{C/W}$$

Then the total thermal resistance and the heat transfer rate through the wall are determined from

$$R_{total} = R_i + R_{insulation} + R_o = 0.0039 + 0.1056 + 0.0010 = 0.1105 \text{ }^\circ\text{C/W}$$

$$\dot{Q} = \frac{T_{\infty 1} - T_{\infty 2}}{R_{total}} = \frac{(22 - 6)^\circ\text{C}}{0.1105 \text{ }^\circ\text{C/W}} = \mathbf{145 \text{ W}}$$

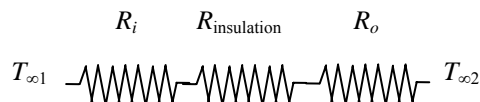
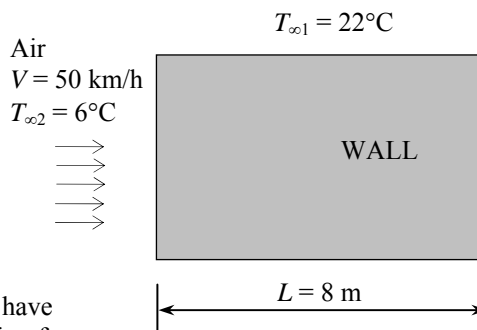

7-96 A car travels at a velocity of 60 km/h. The rate of heat transfer from the bottom surface of the hot automotive engine block is to be determined for two cases.

Assumptions **1** Steady operating conditions exist. **2** The critical Reynolds number is $Re_{cr} = 5 \times 10^5$. **3** Air is an ideal gas with constant properties. **4** The pressure of air is 1 atm. **5** The flow is turbulent over the entire surface because of the constant agitation of the engine block. **6** The bottom surface of the engine is a flat surface.

Properties The properties of air at 1 atm and the film temperature of $(T_s + T_\infty)/2 = (75+5)/2 = 40^\circ\text{C}$ are (Table A-15)

$$k = 0.02662 \text{ W/m}\cdot^\circ\text{C}$$

$$\nu = 1.702 \times 10^{-5} \text{ m}^2/\text{s}$$

$$Pr = 0.7255$$

Analysis The Reynolds number is

$$Re_L = \frac{VL}{\nu} = \frac{[(60 \times 1000 / 3600) \text{ m/s}](0.7 \text{ m})}{1.702 \times 10^{-5} \text{ m}^2/\text{s}} = 6.855 \times 10^5$$

which is less than the critical Reynolds number. But we will assume turbulent flow because of the constant agitation of the engine block.

$$Nu = \frac{hL}{k} = 0.037 Re_L^{0.8} Pr^{1/3} = 0.037(6.855 \times 10^5)^{0.8} (0.7255)^{1/3} = 1551$$

$$h = \frac{k}{L} Nu = \frac{0.02662 \text{ W/m}\cdot^\circ\text{C}}{0.7 \text{ m}} (1551) = 58.97 \text{ W/m}^2 \cdot ^\circ\text{C}$$

$$\dot{Q}_{conv} = hA_s(T_\infty - T_s) = (58.97 \text{ W/m}^2 \cdot ^\circ\text{C})[(0.6 \text{ m})(0.7 \text{ m})](75 - 5)^\circ\text{C} = 1734 \text{ W}$$

The heat loss by radiation is then determined from Stefan-Boltzman law to be

$$\begin{aligned} \dot{Q}_{rad} &= \varepsilon A_s \sigma (T_s^4 - T_{surr}^4) \\ &= (0.92)(0.6 \text{ m})(0.7 \text{ m})(5.67 \times 10^{-8} \text{ W/m}^2 \cdot \text{K}^4) [(75 + 273 \text{ K})^4 - (10 + 273 \text{ K})^4] = 181 \text{ W} \end{aligned}$$

Then the total rate of heat loss from the bottom surface of the engine block becomes

$$\dot{Q}_{total} = \dot{Q}_{conv} + \dot{Q}_{rad} = 1734 + 181 = \mathbf{1915 \text{ W}}$$

The gunk will introduce an additional resistance to heat dissipation from the engine. The total heat transfer rate in this case can be calculated from

$$\dot{Q} = \frac{T_\infty - T_s}{\frac{1}{hA_s} + \frac{L}{kA_s}} = \frac{(75 - 5)^\circ\text{C}}{\frac{1}{(58.97 \text{ W/m}^2 \cdot ^\circ\text{C})[(0.6 \text{ m})(0.7 \text{ m})]} + \frac{(0.002 \text{ m})}{(3 \text{ W/m}\cdot^\circ\text{C})(0.6 \text{ m} \times 0.7 \text{ m})}} = 1668 \text{ W}$$

The decrease in the heat transfer rate is

$$1734 - 1668 = \mathbf{66 \text{ W (3.8\%)}}$$

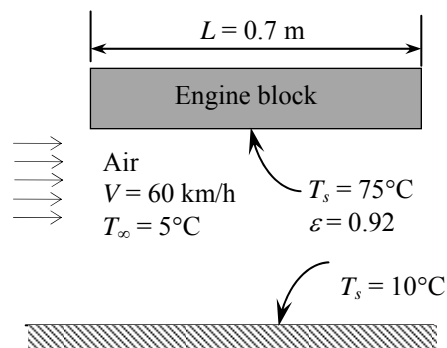

7-97E A minivan is traveling at 60 mph. The rate of heat transfer to the van is to be determined.

Assumptions 1 Steady operating conditions exist. 2 The critical Reynolds number is $Re_{cr} = 5 \times 10^5$. 3 Radiation effects are negligible. 4 Air flow is turbulent because of the intense vibrations involved. 5 Air is an ideal gas with constant properties. 5 The pressure of air is 1 atm.

Properties Assuming a film temperature of $T_f = 80^\circ\text{F}$, the properties of air are evaluated to be (Table A-15E)

$$k = 0.01481 \text{ Btu/h}\cdot\text{ft}\cdot^\circ\text{F}$$

$$\nu = 1.697 \times 10^{-4} \text{ ft}^2/\text{s}$$

$$Pr = 0.7290$$

Analysis Air flows along 11 ft long side. The Reynolds number in this case is

$$Re_L = \frac{VL}{\nu} = \frac{[(60 \times 5280 / 3600) \text{ ft/s}](11 \text{ ft})}{1.697 \times 10^{-4} \text{ ft}^2/\text{s}} = 5.704 \times 10^6$$

which is greater than the critical Reynolds number. The air flow is assumed to be entirely turbulent because of the intense vibrations involved. Then the Nusselt number and the heat transfer coefficient are determined to be

$$Nu = \frac{h_o L}{k} = 0.037 Re_L^{0.8} Pr^{1/3} = 0.037(5.704 \times 10^6)^{0.8} (0.7290)^{1/3} = 8461$$

$$h_o = \frac{k}{L} Nu = \frac{0.01481 \text{ Btu/h}\cdot\text{ft}\cdot^\circ\text{F}}{11 \text{ ft}} (8461) = 11.39 \text{ Btu/h}\cdot\text{ft}^2\cdot^\circ\text{F}$$

The thermal resistances are

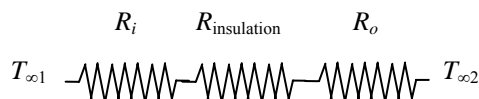

$$A_s = 2[(3.2 \text{ ft})(6 \text{ ft}) + (3.2 \text{ ft})(11 \text{ ft}) + (6 \text{ ft})(11 \text{ ft})] = 240.8 \text{ ft}^2$$

$$R_i = \frac{1}{h_i A_s} = \frac{1}{(1.2 \text{ Btu/h}\cdot\text{ft}^2\cdot^\circ\text{F})(240.8 \text{ ft}^2)} = 0.0035 \text{ h}\cdot^\circ\text{F}/\text{Btu}$$

$$R_{insulation} = \frac{(R-3)_{value}}{A_s} = \frac{3 \text{ h}\cdot\text{ft}^2\cdot^\circ\text{F}/\text{Btu}}{(240.8 \text{ ft}^2)} = 0.0125 \text{ h}\cdot^\circ\text{F}/\text{Btu}$$

$$R_o = \frac{1}{h_o A_s} = \frac{1}{(11.39 \text{ Btu/h}\cdot\text{ft}^2\cdot^\circ\text{F})(240.8 \text{ ft}^2)} = 0.0004 \text{ h}\cdot^\circ\text{F}/\text{Btu}$$

Then the total thermal resistance and the heat transfer rate into the minivan are determined to be

$$R_{total} = R_i + R_{insulation} + R_o = 0.0035 + 0.0125 + 0.0004 = 0.0164 \text{ h}\cdot^\circ\text{F}/\text{Btu}$$

$$\dot{Q} = \frac{T_{\infty 2} - T_{\infty 1}}{R_{total}} = \frac{(90 - 70)^\circ\text{F}}{0.0164 \text{ h}\cdot^\circ\text{F}/\text{Btu}} = \mathbf{1220 \text{ Btu/h}}$$

7-98 Wind is blowing parallel to the walls of a house with windows. The rate of heat loss through the window is to be determined.

Assumptions 1 Steady operating conditions exist. 2 The critical Reynolds number is $Re_{cr} = 5 \times 10^5$. 3 Radiation effects are negligible. 4 Air is an ideal gas with constant properties. 5 The pressure of air is 1 atm.

Properties Assuming a film temperature of 5°C , the properties of air at 1 atm and this temperature are evaluated to be (Table A-15)

$$k = 0.02401 \text{ W/m}\cdot^\circ\text{C}$$

$$\nu = 1.382 \times 10^{-5} \text{ m}^2/\text{s}$$

$$Pr = 0.7350$$

Analysis Air flows along 1.8 m side. The Reynolds number in this case is

$$Re_L = \frac{VL}{\nu} = \frac{[(35 \times 1000 / 3600) \text{ m/s}](1.8 \text{ m})}{1.382 \times 10^{-5} \text{ m}^2/\text{s}} = 1.266 \times 10^6$$

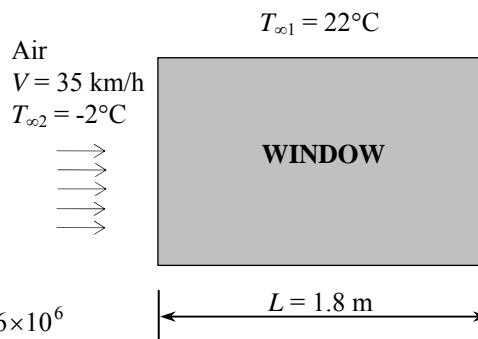

which is greater than the critical Reynolds number. Thus we have combined laminar and turbulent flow. Using the proper relation for Nusselt number, heat transfer coefficient is determined to be

$$Nu = \frac{hL}{k} = (0.037 Re_L^{0.8} - 871) Pr^{1/3} = [0.037(1.266 \times 10^6)^{0.8} - 871](0.7350)^{1/3} = 1759$$

$$h = \frac{k}{L} Nu = \frac{0.02401 \text{ W/m}\cdot^\circ\text{C}}{1.8 \text{ m}} (1759) = 23.46 \text{ W/m}^2\cdot^\circ\text{C}$$

The thermal resistances are

$$A_s = 3(1.8 \text{ m})(1.5 \text{ m}) = 8.1 \text{ m}^2$$

$$R_{conv,i} = \frac{1}{h_i A_s} = \frac{1}{(8 \text{ W/m}^2\cdot^\circ\text{C})(8.1 \text{ m}^2)} = 0.0154 \text{ }^\circ\text{C/W}$$

$$R_{cond} = \frac{L}{k A_s} = \frac{0.005 \text{ m}}{(0.78 \text{ W/m}\cdot^\circ\text{C})(8.1 \text{ m}^2)} = 0.0008 \text{ }^\circ\text{C/W}$$

$$R_{conv,o} = \frac{1}{h_o A_s} = \frac{1}{(23.46 \text{ W/m}^2\cdot^\circ\text{C})(8.1 \text{ m}^2)} = 0.0053 \text{ }^\circ\text{C/W}$$

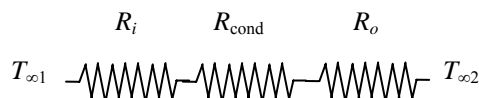

Then the total thermal resistance and the heat transfer rate through the 3 windows become

$$R_{total} = R_{conv,i} + R_{cond} + R_{conv,o} = 0.0154 + 0.0008 + 0.0053 = 0.0215 \text{ }^\circ\text{C/W}$$

$$\dot{Q} = \frac{T_{\infty 1} - T_{\infty 2}}{R_{total}} = \frac{[22 - (-2)]^\circ\text{C}}{0.0215 \text{ }^\circ\text{C/W}} = \mathbf{1116 \text{ W}}$$

7-99 A fan is blowing air over the entire body of a person. The average temperature of the outer surface of the person is to be determined.

Assumptions **1** Steady operating conditions exist. **2** Air is an ideal gas with constant properties. **3** The pressure of air is 1 atm. **4** The average human body can be treated as a 30-cm-diameter cylinder with an exposed surface area of 1.7 m².

Properties We assume the film temperature to be 35°C. The properties of air at 1 atm and this temperature are (Table A-15)

$$k = 0.02625 \text{ W/m}\cdot\text{°C}$$

$$\nu = 1.655 \times 10^{-5} \text{ m}^2/\text{s}$$

$$\text{Pr} = 0.7268$$

Analysis The Reynolds number is

$$\text{Re} = \frac{VD}{\nu} = \frac{(5 \text{ m/s})(0.3 \text{ m})}{1.655 \times 10^{-5} \text{ m}^2/\text{s}} = 9.063 \times 10^4$$

$$V = 5 \text{ m/s}$$

$$T_\infty = 32^\circ\text{C}$$

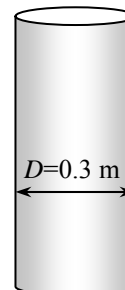

$$\text{Person, } T_s$$

$$90 \text{ W}$$

$$\varepsilon = 0.9$$

The proper relation for Nusselt number corresponding to this Reynolds number is

$$Nu = \frac{hD}{k} = 0.3 + \frac{0.62 \text{ Re}^{0.5} \text{Pr}^{1/3}}{\left[1 + (0.4/\text{Pr})^{2/3}\right]^{1/4}} \left[1 + \left(\frac{\text{Re}}{282,000}\right)^{5/8}\right]^{4/5}$$

$$= 0.3 + \frac{0.62(9.063 \times 10^4)^{0.5} (0.7268)^{1/3}}{\left[1 + (0.4/0.7268)^{2/3}\right]^{1/4}} \left[1 + \left(\frac{9.063 \times 10^4}{282,000}\right)^{5/8}\right]^{4/5} = 203.6$$

Then

$$h = \frac{k}{D} Nu = \frac{0.02655 \text{ W/m}\cdot\text{°C}}{0.3 \text{ m}} (203.6) = 18.02 \text{ W/m}^2\cdot\text{°C}$$

Considering that there is heat generation in that person's body at a rate of 90 W and body gains heat by radiation from the surrounding surfaces, an energy balance can be written as

$$\dot{Q}_{\text{generated}} + \dot{Q}_{\text{radiation}} = \dot{Q}_{\text{convection}}$$

Substituting values with proper units and then application of trial & error method or the use of an equation solver yields the average temperature of the outer surface of the person.

$$90 \text{ W} + \varepsilon A_s \sigma (T_{\text{surr}}^4 - T_s^4) = h A_s (T_s - T_\infty)$$

$$90 + (0.9)(1.7)(5.67 \times 10^{-8})[(40 + 273)^4 - T_s^4] = (18.02)(1.7)[T_s - (32 + 273)]$$

$$\longrightarrow T_s = 309.2 \text{ K} = 36.2^\circ\text{C}$$

7-100 The heat generated by four transistors mounted on a thin vertical plate is dissipated by air blown over the plate on both surfaces. The temperature of the aluminum plate is to be determined.

Assumptions **1** Steady operating conditions exist. **2** The critical Reynolds number is $Re_{cr} = 5 \times 10^5$. **3** Radiation effects are negligible. **4** The entire plate is nearly isothermal. **5** The exposed surface area of the transistor is taken to be equal to its base area. **6** Air is an ideal gas with constant properties. **7** The pressure of air is 1 atm.

Properties Assuming a film temperature of 40°C , the properties of air are evaluated to be (Table A-15)

$$k = 0.02662 \text{ W/m}\cdot^\circ\text{C}$$

$$\nu = 1.702 \times 10^{-5} \text{ m}^2/\text{s}$$

$$Pr = 0.7255$$

$$V = 250 \text{ m/min}$$

$$T_\infty = 20^\circ\text{C}$$

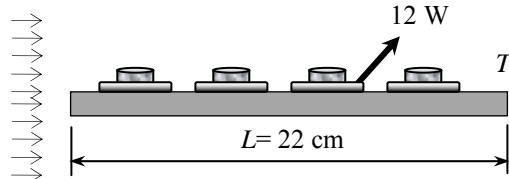

Analysis The Reynolds number in this case is

$$Re_L = \frac{VL}{\nu} = \frac{[(250/60) \text{ m/s}](0.22 \text{ m})}{1.702 \times 10^{-5} \text{ m}^2/\text{s}} = 5.386 \times 10^4$$

which is smaller than the critical Reynolds number. Thus we have laminar flow. Using the proper relation for Nusselt number, heat transfer coefficient is determined to be

$$Nu = \frac{hL}{k} = 0.664 Re_L^{0.5} Pr^{1/3} = 0.664(5.386 \times 10^4)^{0.5} (0.7255)^{1/3} = 138.5$$

$$h = \frac{k}{L} Nu = \frac{0.02662 \text{ W/m}\cdot^\circ\text{C}}{0.22 \text{ m}} (138.5) = 16.75 \text{ W/m}^2\cdot^\circ\text{C}$$

The temperature of aluminum plate then becomes

$$\dot{Q} = hA_s(T_s - T_\infty) \longrightarrow T_s = T_\infty + \frac{\dot{Q}}{hA_s} = 20^\circ\text{C} + \frac{(4 \times 12) \text{ W}}{(16.75 \text{ W/m}^2\cdot^\circ\text{C})[2(0.22 \text{ m})^2]} = \mathbf{50.0^\circ\text{C}}$$

Discussion In reality, the heat transfer coefficient will be higher since the transistors will cause turbulence in the air.

7-101 A spherical tank used to store iced water is subjected to winds. The rate of heat transfer to the iced water and the amount of ice that melts during a 24-h period are to be determined.

Assumptions **1** Steady operating conditions exist. **2** Thermal resistance of the tank is negligible. **3** Radiation effects are negligible. **4** Air is an ideal gas with constant properties. **5** The pressure of air is 1 atm.

Properties The properties of air at 1 atm pressure and the free stream temperature of 30°C are (Table A-15)

$$k = 0.02588 \text{ W/m}\cdot\text{°C}$$

$$\nu = 1.608 \times 10^{-5} \text{ m}^2/\text{s}$$

$$\mu_{\infty} = 1.872 \times 10^{-5} \text{ kg/m}\cdot\text{s}$$

$$\mu_{s, @ 0^{\circ}\text{C}} = 1.729 \times 10^{-5} \text{ kg/m}\cdot\text{s}$$

$$\text{Pr} = 0.7282$$

Analysis (a) The Reynolds number is

$$\text{Re} = \frac{VD}{\nu} = \frac{[(25 \times 1000/3600) \text{ m/s}](3.02 \text{ m})}{1.608 \times 10^{-5} \text{ m}^2/\text{s}} = 1.304 \times 10^6$$

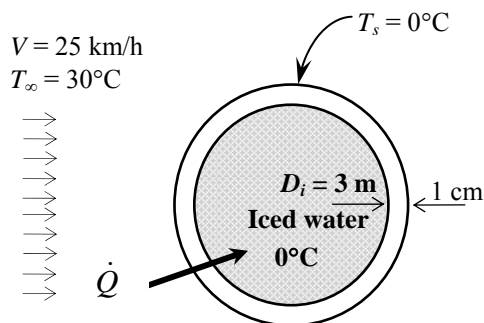

The Nusselt number corresponding to this Reynolds number is determined from

$$\begin{aligned} Nu &= \frac{hD}{k} = 2 + \left[0.4 \text{Re}^{0.5} + 0.06 \text{Re}^{2/3} \right] \text{Pr}^{0.4} \left(\frac{\mu_{\infty}}{\mu_s} \right)^{1/4} \\ &= 2 + \left[0.4(1.304 \times 10^6)^{0.5} + 0.06(1.304 \times 10^6)^{2/3} \right] (0.7282)^{0.4} \left(\frac{1.872 \times 10^{-5}}{1.729 \times 10^{-5}} \right)^{1/4} = 1056 \end{aligned}$$

$$\text{and } h = \frac{k}{D} Nu = \frac{0.02588 \text{ W/m}\cdot\text{°C}}{3.02 \text{ m}} (1056) = 9.05 \text{ W/m}^2\cdot\text{°C}$$

The rate of heat transfer to the iced water is

$$\dot{Q} = hA_s(T_s - T_{\infty}) = h(\pi D^2)(T_s - T_{\infty}) = (9.05 \text{ W/m}^2\cdot\text{°C})[\pi(3.02 \text{ m})^2](30 - 0)^{\circ}\text{C} = \mathbf{7779 \text{ W}}$$

(b) The amount of heat transfer during a 24-hour period is

$$Q = \dot{Q}\Delta t = (7.779 \text{ kJ/s})(24 \times 3600 \text{ s}) = 672,000 \text{ kJ}$$

Then the amount of ice that melts during this period becomes

$$Q = mh_{if} \longrightarrow m = \frac{Q}{h_{if}} = \frac{672,000 \text{ kJ}}{333.7 \text{ kJ/kg}} = \mathbf{2014 \text{ kg}}$$

7-102 A spherical tank used to store iced water is subjected to winds. The rate of heat transfer to the iced water and the amount of ice that melts during a 24-h period are to be determined.

Assumptions 1 Steady operating conditions exist. 2 Air is an ideal gas with constant properties. 7 The pressure of air is 1 atm.

Properties The properties of air at 1 atm pressure and the free stream temperature of 30°C are (Table A-15)

$$k = 0.02588 \text{ W/m}\cdot\text{°C}$$

$$\nu = 1.608 \times 10^{-5} \text{ m}^2/\text{s}$$

$$\mu_\infty = 1.872 \times 10^{-5} \text{ kg/m}\cdot\text{s}$$

$$\mu_{s,@0^\circ\text{C}} = 1.729 \times 10^{-5} \text{ kg/m}\cdot\text{s}$$

$$\text{Pr} = 0.7282$$

Analysis (a) The Reynolds number is

$$\text{Re} = \frac{VD}{\nu} = \frac{[(25 \times 1000/3600) \text{ m/s}](3.02 \text{ m})}{1.608 \times 10^{-5} \text{ m}^2/\text{s}} = 1.304 \times 10^6$$

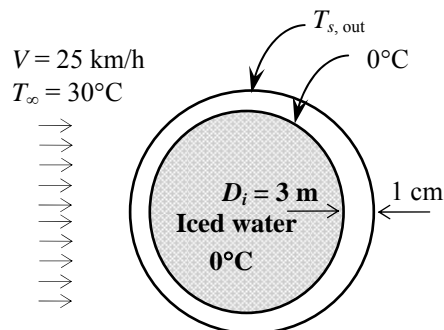

The Nusselt number corresponding to this Reynolds number is determined from

$$\begin{aligned} Nu &= \frac{hD}{k} = 2 + \left[0.4 \text{Re}^{0.5} + 0.06 \text{Re}^{2/3} \right] \text{Pr}^{0.4} \left(\frac{\mu_\infty}{\mu_s} \right)^{1/4} \\ &= 2 + \left[0.4(1.304 \times 10^6)^{0.5} + 0.06(1.304 \times 10^6)^{2/3} \right] (0.7282)^{0.4} \left(\frac{1.872 \times 10^{-5}}{1.729 \times 10^{-5}} \right)^{1/4} = 1056 \end{aligned}$$

and
$$h = \frac{k}{D} Nu = \frac{0.02588 \text{ W/m}\cdot\text{°C}}{3.02 \text{ m}} (1056) = 9.05 \text{ W/m}^2\cdot\text{°C}$$

In steady operation, heat transfer through the tank by conduction is equal to the heat transfer from the outer surface of the tank by convection and radiation. Therefore,

$$\dot{Q} = \dot{Q}_{\text{through tank}} = \dot{Q}_{\text{from tank, conv+rad}}$$

$$\dot{Q} = \frac{T_{s,\text{out}} - T_{s,\text{in}}}{R_{\text{sphere}}} = h_o A_o (T_{\text{surr}} - T_{s,\text{out}}) + \varepsilon A_o \sigma (T_{\text{surr}}^4 - T_{s,\text{out}}^4)$$

where
$$R_{\text{sphere}} = \frac{r_2 - r_1}{4\pi k r_1 r_2} = \frac{(1.51 - 1.50) \text{ m}}{4\pi(15 \text{ W/m}\cdot\text{°C})(1.51 \text{ m})(1.50 \text{ m})} = 2.342 \times 10^{-5} \text{ °C/W}$$

$$A_o = \pi D^2 = \pi(3.02 \text{ m})^2 = 28.65 \text{ m}^2$$

Substituting,

$$\begin{aligned} \dot{Q} &= \frac{T_{s,\text{out}} - 0^\circ\text{C}}{2.34 \times 10^{-5} \text{ °C/W}} = (9.05 \text{ W/m}^2\cdot\text{°C})(28.65 \text{ m}^2)(30 - T_{s,\text{out}})^\circ\text{C} \\ &\quad + (0.75)(28.65 \text{ m}^2)(5.67 \times 10^{-8} \text{ W/m}^2\cdot\text{K}^4)[(25 + 273 \text{ K})^4 - (T_{s,\text{out}} + 273 \text{ K})^4] \end{aligned}$$

whose solution is

$$T_s = 0.25^\circ\text{C} \text{ and } \dot{Q} = 10,530 \text{ W} = \mathbf{10.53 \text{ kW}}$$

(b) The amount of heat transfer during a 24-hour period is

$$Q = \dot{Q} \Delta t = (10.531 \text{ kW})(24 \times 3600 \text{ s}) = 909,880 \text{ kJ}$$

Then the amount of ice that melts during this period becomes

$$Q = m h_{if} \longrightarrow m = \frac{Q}{h_{if}} = \frac{909,880 \text{ kJ}}{333.7 \text{ kJ/kg}} = \mathbf{2727 \text{ kg}}$$

7-103E A cylindrical transistor mounted on a circuit board is cooled by air flowing over it. The maximum power rating of the transistor is to be determined.

Assumptions 1 Steady operating conditions exist. 2 Radiation effects are negligible. 3 Air is an ideal gas with constant properties. 4 The pressure of air is 1 atm.

Properties The properties of air at 1 atm and the film temperature of $T_f = (180 + 120) / 2 = 150^\circ\text{F}$ are (Table A-15)

$$k = 0.01646 \text{ Btu/h}\cdot\text{ft}\cdot^\circ\text{F}$$

$$\nu = 2.099 \times 10^{-4} \text{ ft}^2/\text{s}$$

$$\text{Pr} = 0.7188$$

Analysis The Reynolds number is

$$\text{Re} = \frac{VD}{\nu} = \frac{(500/60 \text{ ft/s})(0.22/12 \text{ ft})}{2.099 \times 10^{-4} \text{ ft}^2/\text{s}} = 727.9$$

The Nusselt number corresponding to this Reynolds number is

$$\begin{aligned} \text{Nu} = \frac{hD}{k} &= 0.3 + \frac{0.62 \text{Re}^{0.5} \text{Pr}^{1/3}}{\left[1 + (0.4/\text{Pr})^{2/3}\right]^{1/4}} \left[1 + \left(\frac{\text{Re}}{282,000}\right)^{5/8}\right]^{4/5} \\ &= 0.3 + \frac{0.62(727.9)^{0.5} (0.7188)^{1/3}}{\left[1 + (0.4/0.7188)^{2/3}\right]^{1/4}} \left[1 + \left(\frac{727.9}{282,000}\right)^{5/8}\right]^{4/5} = 13.72 \end{aligned}$$

$$\text{and } h = \frac{k}{D} \text{Nu} = \frac{0.01646 \text{ Btu/h}\cdot\text{ft}\cdot^\circ\text{F}}{(0.22/12 \text{ ft})} (13.72) = 12.32 \text{ Btu/h}\cdot\text{ft}^2\cdot^\circ\text{F}$$

Then the amount of power this transistor can dissipate safely becomes

$$\begin{aligned} \dot{Q} &= hA_s(T_s - T_\infty) = h(\pi DL)(T_s - T_\infty) \\ &= (12.32 \text{ Btu/h}\cdot\text{ft}^2\cdot^\circ\text{F})[\pi(0.22/12 \text{ ft})(0.25/12 \text{ ft})](180 - 120)^\circ\text{C} \\ &= \mathbf{0.887 \text{ Btu/h} = 0.26 \text{ W}} \quad (1 \text{ W} = 3.412 \text{ Btu/h}) \end{aligned}$$

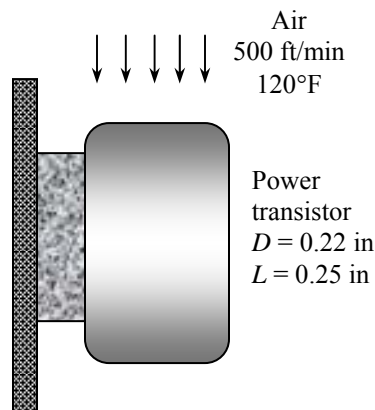

7-104 Wind is blowing over the roof of a house. The rate of heat transfer through the roof and the cost of this heat loss for 14-h period are to be determined.

Assumptions 1 Steady operating conditions exist. 2 The critical Reynolds number is $Re_{cr} = 5 \times 10^5$. 3 Air is an ideal gas with constant properties. 4 The pressure of air is 1 atm.

Properties Assuming a film temperature of 10°C , the properties of air are (Table A-15)

$$k = 0.02439 \text{ W/m}\cdot^\circ\text{C}$$

$$\nu = 1.426 \times 10^{-5} \text{ m}^2/\text{s}$$

$$Pr = 0.7336$$

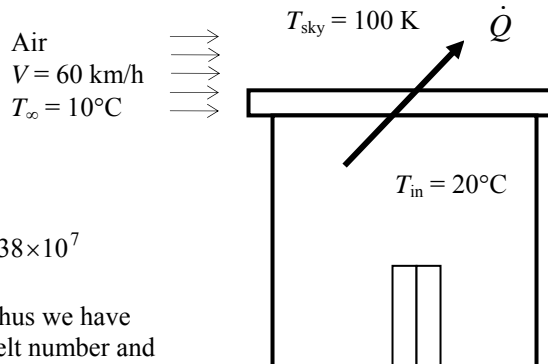

Analysis The Reynolds number is

$$Re_L = \frac{VL}{\nu} = \frac{[(60 \times 1000 / 3600) \text{ m/s}](20 \text{ m})}{1.426 \times 10^{-5} \text{ m}^2/\text{s}} = 2.338 \times 10^7$$

which is greater than the critical Reynolds number. Thus we have combined laminar and turbulent flow. Then the Nusselt number and the heat transfer coefficient are determined to be

$$Nu = \frac{hL}{k} = (0.037 Re_L^{0.8} - 871) Pr^{1/3} = [0.037(2.338 \times 10^7)^{0.8} - 871](0.7336)^{1/3} = 2.542 \times 10^4$$

$$h = \frac{k}{L} Nu = \frac{0.02439 \text{ W/m}\cdot^\circ\text{C}}{20 \text{ m}} (2.542 \times 10^4) = 31.0 \text{ W/m}^2\cdot^\circ\text{C}$$

In steady operation, heat transfer from the room to the roof (by convection and radiation) must be equal to the heat transfer from the roof to the surroundings (by convection and radiation), which must be equal to the heat transfer through the roof by conduction. That is,

$$\dot{Q} = \dot{Q}_{\text{room to roof, conv+rad}} = \dot{Q}_{\text{roof, cond}} = \dot{Q}_{\text{roof to surroundings, conv+rad}}$$

Taking the inner and outer surface temperatures of the roof to be $T_{s,in}$ and $T_{s,out}$, respectively, the quantities above can be expressed as

$$\begin{aligned} \dot{Q}_{\text{room to roof, conv+rad}} &= h_i A_s (T_{\text{room}} - T_{s,in}) + \varepsilon A_s \sigma (T_{\text{room}}^4 - T_{s,in}^4) = (5 \text{ W/m}^2\cdot^\circ\text{C})(300 \text{ m}^2)(20 - T_{s,in})^\circ\text{C} \\ &\quad + (0.9)(300 \text{ m}^2)(5.67 \times 10^{-8} \text{ W/m}^2\cdot\text{K}^4) [(20 + 273 \text{ K})^4 - (T_{s,in} + 273 \text{ K})^4] \end{aligned}$$

$$\dot{Q}_{\text{roof, cond}} = k A_s \frac{T_{s,in} - T_{s,out}}{L} = (2 \text{ W/m}\cdot^\circ\text{C})(300 \text{ m}^2) \frac{T_{s,in} - T_{s,out}}{0.15 \text{ m}}$$

$$\begin{aligned} \dot{Q}_{\text{roof to surr, conv+rad}} &= h_o A_s (T_{s,out} - T_{\text{surr}}) + \varepsilon A_s \sigma (T_{s,out}^4 - T_{\text{surr}}^4) = (31.0 \text{ W/m}^2\cdot^\circ\text{C})(300 \text{ m}^2)(T_{s,out} - 10)^\circ\text{C} \\ &\quad + (0.9)(300 \text{ m}^2)(5.67 \times 10^{-8} \text{ W/m}^2\cdot\text{K}^4) [(T_{s,out} + 273 \text{ K})^4 - (100 \text{ K})^4] \end{aligned}$$

Solving the equations above simultaneously gives

$$\dot{Q} = 28,025 \text{ W} = \mathbf{28.03 \text{ kW}}, \quad T_{s,in} = 10.6^\circ\text{C}, \text{ and } T_{s,out} = 3.5^\circ\text{C}$$

The total amount of natural gas consumption during a 14-hour period is

$$Q_{\text{gas}} = \frac{Q_{\text{total}}}{0.85} = \frac{\dot{Q} \Delta t}{0.85} = \frac{(28.03 \text{ kJ/s})(14 \times 3600 \text{ s})}{0.85} \left(\frac{1 \text{ therm}}{105,500 \text{ kJ}} \right) = 15.75 \text{ therms}$$

Finally, the money lost through the roof during that period is

$$\text{Money lost} = (15.75 \text{ therms})(\$1.20 / \text{therm}) = \mathbf{\$18.9}$$

7-105 Steam is flowing in a stainless steel pipe while air is flowing across the pipe. The rate of heat loss from the steam per unit length of the pipe is to be determined.

Assumptions 1 Steady operating conditions exist. 2 Air is an ideal gas with constant properties. 3 The pressure of air is 1 atm.

Properties Assuming a film temperature of 10°C, the properties of air are (Table A-15)

$$k = 0.02439 \text{ W/m}\cdot\text{°C}$$

$$\nu = 1.426 \times 10^{-5} \text{ m}^2/\text{s}$$

$$Pr = 0.7336$$

Analysis The outer diameter of insulated pipe is $D_o = 4.6 + 2 \times 3.5 = 11.6 \text{ cm} = 0.116 \text{ m}$. The Reynolds number is

$$Re = \frac{VD_o}{\nu} = \frac{(4 \text{ m/s})(0.116 \text{ m})}{1.426 \times 10^{-5} \text{ m}^2/\text{s}} = 3.254 \times 10^4$$

The Nusselt number for flow across a cylinder is determined from

$$\begin{aligned} Nu &= \frac{hD_o}{k} = 0.3 + \frac{0.62 Re^{0.5} Pr^{1/3}}{\left[1 + (0.4/Pr)^{2/3}\right]^{1/4}} \left[1 + \left(\frac{Re}{282,000}\right)^{5/8}\right]^{4/5} \\ &= 0.3 + \frac{0.62(3.254 \times 10^4)^{0.5} (0.7336)^{1/3}}{\left[1 + (0.4/0.7336)^{2/3}\right]^{1/4}} \left[1 + \left(\frac{3.254 \times 10^4}{282,000}\right)^{5/8}\right]^{4/5} = 107.0 \end{aligned}$$

$$\text{and } h_o = \frac{k}{D_o} Nu = \frac{0.02439 \text{ W/m}\cdot\text{°C}}{0.116 \text{ m}} (107.0) = 22.50 \text{ W/m}^2 \cdot \text{°C}$$

Area of the outer surface of the pipe per m length of the pipe is

$$A_o = \pi D_o L = \pi (0.116 \text{ m})(1 \text{ m}) = 0.3644 \text{ m}^2$$

In steady operation, heat transfer from the steam through the pipe and the insulation to the outer surface (by first convection and then conduction) must be equal to the heat transfer from the outer surface to the surroundings (by simultaneous convection and radiation). That is,

$$\dot{Q} = \dot{Q}_{\text{pipe and insulation}} = \dot{Q}_{\text{surface to surroundings}}$$

Using the thermal resistance network, heat transfer from the steam to the outer surface is expressed as

$$R_{conv,i} = \frac{1}{h_i A_i} = \frac{1}{(80 \text{ W/m}^2 \cdot \text{°C})[\pi(0.04 \text{ m})(1 \text{ m})]} = 0.0995 \text{ °C/W}$$

$$R_{pipe} = \frac{\ln(r_2/r_1)}{2\pi kL} = \frac{\ln(2.3/2)}{2\pi(15 \text{ W/m}\cdot\text{°C})(1 \text{ m})} = 0.0015 \text{ °C/W}$$

$$R_{insulation} = \frac{\ln(r_3/r_2)}{2\pi kL} = \frac{\ln(5.8/2.3)}{2\pi(0.038 \text{ W/m}\cdot\text{°C})(1 \text{ m})} = 3.874 \text{ °C/W}$$

$$\text{and } \dot{Q}_{\text{pipe and ins}} = \frac{T_{\infty 1} - T_s}{R_{conv,i} + R_{pipe} + R_{insulation}} = \frac{(250 - T_s) \text{ °C}}{(0.0995 + 0.0015 + 3.874) \text{ °C/W}}$$

Heat transfer from the outer surface can be expressed as

$$\begin{aligned} \dot{Q}_{\text{surface to surr, conv+rad}} &= h_o A_o (T_s - T_{surr}) + \varepsilon A_o \sigma (T_s^4 - T_{surr}^4) = (22.50 \text{ W/m}^2 \cdot \text{°C})(0.3644 \text{ m}^2)(T_s - 3) \text{ °C} \\ &\quad + (0.3)(0.3644 \text{ m}^2)(5.67 \times 10^{-8} \text{ W/m}^2 \cdot \text{K}^4) \left[(T_s + 273 \text{ K})^4 - (3 + 273 \text{ K})^4 \right] \end{aligned}$$

Solving the two equations above simultaneously, the surface temperature and the heat transfer rate per m length of the pipe are determined to be

$$T_s = 9.9 \text{ °C} \text{ and } \dot{Q} = \mathbf{60.4 \text{ W}} \text{ (per m length)}$$

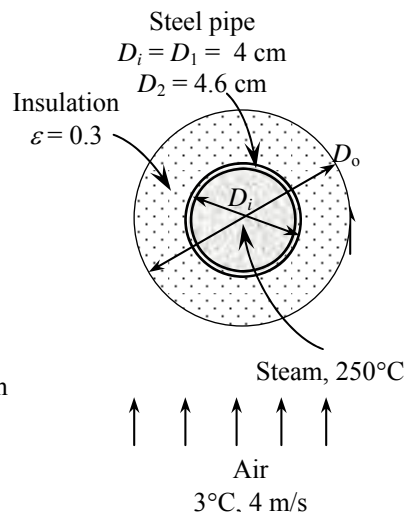

7-106 A spherical tank filled with liquid nitrogen is exposed to winds. The rate of evaporation of the liquid nitrogen due to heat transfer from the air is to be determined for three cases.

Assumptions 1 Steady operating conditions exist. 2 Radiation effects are negligible. 3 Air is an ideal gas with constant properties. 4 The pressure of air is 1 atm.

Properties The properties of air at 1 atm pressure and the free stream temperature of 20°C are (Table A-15)

$$k = 0.02514 \text{ W/m}\cdot\text{°C}$$

$$\nu = 1.516 \times 10^{-5} \text{ m}^2/\text{s}$$

$$\mu_\infty = 1.825 \times 10^{-5} \text{ kg/m}\cdot\text{s}$$

$$\mu_{s, @ -196^\circ\text{C}} = 5.023 \times 10^{-6} \text{ kg/m}\cdot\text{s} \text{ (from EES)}$$

$$\text{Pr} = 0.7309$$

Analysis (a) When there is no insulation, $D = D_i = 4 \text{ m}$, and the Reynolds number is

$$\text{Re} = \frac{VD}{\nu} = \frac{[(40 \times 1000/3600) \text{ m/s}](4 \text{ m})}{1.516 \times 10^{-5} \text{ m}^2/\text{s}} = 2.932 \times 10^6$$

The Nusselt number is determined from

$$\begin{aligned} \text{Nu} &= \frac{hD}{k} = 2 + \left[0.4 \text{Re}^{0.5} + 0.06 \text{Re}^{2/3} \right] \text{Pr}^{0.4} \left(\frac{\mu_\infty}{\mu_s} \right)^{1/4} \\ &= 2 + \left[0.4(2.932 \times 10^6)^{0.5} + 0.06(2.932 \times 10^6)^{2/3} \right] (0.7309)^{0.4} \left(\frac{1.825 \times 10^{-5}}{5.023 \times 10^{-6}} \right)^{1/4} = 2333 \end{aligned}$$

$$\text{and } h = \frac{k}{D} \text{Nu} = \frac{0.02514 \text{ W/m}\cdot\text{°C}}{4 \text{ m}} (2333) = 14.66 \text{ W/m}^2\cdot\text{°C}$$

The rate of heat transfer to the liquid nitrogen is

$$\dot{Q} = hA_s(T_s - T_\infty) = h(\pi D^2)(T_s - T_\infty) = (14.66 \text{ W/m}^2\cdot\text{°C})[\pi(4 \text{ m})^2][(20 - (-196))^\circ\text{C}] = 159,200 \text{ W}$$

The rate of evaporation of liquid nitrogen then becomes

$$\dot{Q} = \dot{m}h_{if} \longrightarrow \dot{m} = \frac{\dot{Q}}{h_{if}} = \frac{159.2 \text{ kJ/s}}{198 \text{ kJ/kg}} = \mathbf{0.804 \text{ kg/s}}$$

(b) Note that after insulation the outer surface temperature and diameter will change. Therefore we need to evaluate dynamic viscosity at a new surface temperature which we will assume to be -100°C . At -100°C , $\mu = 1.189 \times 10^{-5} \text{ kg/m}\cdot\text{s}$. Noting that $D = D_0 = 4.1 \text{ m}$, the Nusselt number becomes

$$\begin{aligned} \text{Re} &= \frac{VD}{\nu} = \frac{[(40 \times 1000/3600) \text{ m/s}](4.1 \text{ m})}{1.516 \times 10^{-5} \text{ m}^2/\text{s}} = 3.005 \times 10^6 \\ \text{Nu} &= \frac{hD}{k} = 2 + \left[0.4 \text{Re}^{0.5} + 0.06 \text{Re}^{2/3} \right] \text{Pr}^{0.4} \left(\frac{\mu_\infty}{\mu_s} \right)^{1/4} \\ &= 2 + \left[0.4(3.005 \times 10^6)^{0.5} + 0.06(3.005 \times 10^6)^{2/3} \right] (0.7309)^{0.4} \left(\frac{1.825 \times 10^{-5}}{1.189 \times 10^{-5}} \right)^{1/4} = 1910 \end{aligned}$$

$$\text{and } h = \frac{k}{D} \text{Nu} = \frac{0.02514 \text{ W/m}\cdot\text{°C}}{4.1 \text{ m}} (1910) = 11.71 \text{ W/m}^2\cdot\text{°C}$$

The rate of heat transfer to the liquid nitrogen is

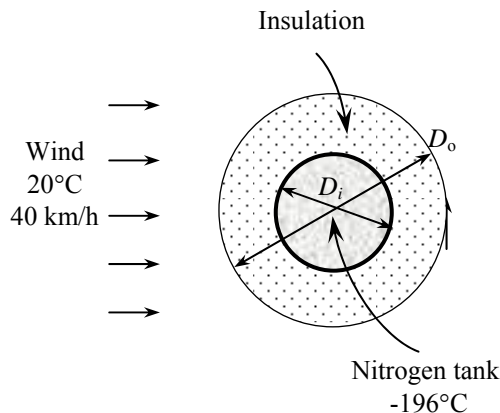

$$\begin{aligned}
 A_s &= \pi D^2 = \pi(4.1 \text{ m})^2 = 52.81 \text{ m}^2 \\
 \dot{Q} &= \frac{T_\infty - T_{s,\text{tan } k}}{R_{\text{insulation}} + R_{\text{conv}}} = \frac{T_\infty - T_{s,\text{tan } k}}{\frac{r_2 - r_1}{4\pi k r_1 r_2} + \frac{1}{hA_s}} \\
 &= \frac{[20 - (-196)]^\circ\text{C}}{\frac{(2.05 - 2) \text{ m}}{4\pi(0.035 \text{ W/m}\cdot^\circ\text{C})(2.05 \text{ m})(2 \text{ m})} + \frac{1}{(11.71 \text{ W/m}^2\cdot^\circ\text{C})(52.81 \text{ m}^2)}} = 7361 \text{ W}
 \end{aligned}$$

The rate of evaporation of liquid nitrogen then becomes

$$\dot{Q} = \dot{m}h_{if} \longrightarrow \dot{m} = \frac{\dot{Q}}{h_{if}} = \frac{7.361 \text{ kJ/s}}{198 \text{ kJ/kg}} = \mathbf{0.0372 \text{ kg/s}}$$

(c) We use the dynamic viscosity value at the new estimated surface temperature of 0°C to be $\mu = 1.729 \times 10^{-5} \text{ kg/m}\cdot\text{s}$. Noting that $D = D_0 = 4.04 \text{ m}$ in this case, the Nusselt number becomes

$$\begin{aligned}
 \text{Re} &= \frac{VD}{\nu} = \frac{[(40 \times 1000/3600) \text{ m/s}](4.04 \text{ m})}{1.516 \times 10^{-5} \text{ m}^2/\text{s}} = 2.961 \times 10^6 \\
 \text{Nu} &= \frac{hD}{k} = 2 + \left[0.4 \text{Re}^{0.5} + 0.06 \text{Re}^{2/3}\right] \text{Pr}^{0.4} \left(\frac{\mu_\infty}{\mu_s}\right)^{1/4} \\
 &= 2 + \left[0.4(2.961 \times 10^6)^{0.5} + 0.06(2.961 \times 10^6)^{2/3}\right] (0.7309)^{0.4} \left(\frac{1.825 \times 10^{-5}}{1.729 \times 10^{-5}}\right)^{1/4} = 1724
 \end{aligned}$$

$$\text{and } h = \frac{k}{D} \text{Nu} = \frac{0.02514 \text{ W/m}\cdot^\circ\text{C}}{4.04 \text{ m}} (1724) = 10.73 \text{ W/m}^2\cdot^\circ\text{C}$$

The rate of heat transfer to the liquid nitrogen is

$$\begin{aligned}
 A_s &= \pi D^2 = \pi(4.04 \text{ m})^2 = 51.28 \text{ m}^2 \\
 \dot{Q} &= \frac{T_\infty - T_{s,\text{tan } k}}{R_{\text{insulation}} + R_{\text{conv}}} = \frac{T_\infty - T_{s,\text{tan } k}}{\frac{r_2 - r_1}{4\pi k r_1 r_2} + \frac{1}{hA_s}} \\
 &= \frac{[20 - (-196)]^\circ\text{C}}{\frac{(2.02 - 2) \text{ m}}{4\pi(0.00005 \text{ W/m}\cdot^\circ\text{C})(2.02 \text{ m})(2 \text{ m})} + \frac{1}{(10.73 \text{ W/m}^2\cdot^\circ\text{C})(51.28 \text{ m}^2)}} = 27.4 \text{ W}
 \end{aligned}$$

The rate of evaporation of liquid nitrogen then becomes

$$\dot{Q} = \dot{m}h_{if} \longrightarrow \dot{m} = \frac{\dot{Q}}{h_{if}} = \frac{0.0274 \text{ kJ/s}}{198 \text{ kJ/kg}} = \mathbf{1.38 \times 10^{-4} \text{ kg/s}}$$

7-107 A spherical tank filled with liquid oxygen is exposed to ambient winds. The rate of evaporation of the liquid oxygen due to heat transfer from the air is to be determined for three cases.

Assumptions 1 Steady operating conditions exist. 2 Radiation effects are negligible. 3 Air is an ideal gas with constant properties. 7 The pressure of air is 1 atm.

Properties The properties of air at 1 atm pressure and the free stream temperature of 20°C are (Table A-15)

$$k = 0.02514 \text{ W/m}\cdot\text{°C}$$

$$\nu = 1.516 \times 10^{-5} \text{ m}^2/\text{s}$$

$$\mu_\infty = 1.825 \times 10^{-5} \text{ kg/m}\cdot\text{s}$$

$$\mu_{s, @ -183^\circ\text{C}} = 6.127 \times 10^{-6} \text{ kg/m}\cdot\text{s} \text{ (from EES)}$$

$$\text{Pr} = 0.7309$$

Analysis (a) When there is no insulation, $D = D_i = 4 \text{ m}$, and the Reynolds number is

$$\text{Re} = \frac{VD}{\nu} = \frac{[(40 \times 1000/3600) \text{ m/s}](4 \text{ m})}{1.516 \times 10^{-5} \text{ m}^2/\text{s}} = 2.932 \times 10^6$$

The Nusselt number is determined from

$$\begin{aligned} Nu &= \frac{hD}{k} = 2 + \left[0.4 \text{Re}^{0.5} + 0.06 \text{Re}^{2/3} \right] \text{Pr}^{0.4} \left(\frac{\mu_\infty}{\mu_s} \right)^{1/4} \\ &= 2 + \left[0.4(2.932 \times 10^6)^{0.5} + 0.06(2.932 \times 10^6)^{2/3} \right] (0.7309)^{0.4} \left(\frac{1.825 \times 10^{-5}}{6.127 \times 10^{-6}} \right)^{1/4} = 2220 \end{aligned}$$

$$\text{and } h = \frac{k}{D} Nu = \frac{0.02514 \text{ W/m}\cdot\text{°C}}{4 \text{ m}} (2220) = 13.95 \text{ W/m}^2\cdot\text{°C}$$

The rate of heat transfer to the liquid oxygen is

$$\dot{Q} = hA_s(T_s - T_\infty) = h(\pi D^2)(T_s - T_\infty) = (13.95 \text{ W/m}^2\cdot\text{°C})[\pi(4 \text{ m})^2][(20 - (-183))^\circ\text{C}] = 142,372 \text{ W}$$

The rate of evaporation of liquid oxygen then becomes

$$\dot{Q} = \dot{m}h_{if} \longrightarrow \dot{m} = \frac{\dot{Q}}{h_{if}} = \frac{142.4 \text{ kJ/s}}{213 \text{ kJ/kg}} = \mathbf{0.668 \text{ kg/s}}$$

(b) Note that after insulation the outer surface temperature and diameter will change. Therefore we need to evaluate dynamic viscosity at a new surface temperature which we will assume to be -100°C. At -100°C, $\mu = 1.189 \times 10^{-5} \text{ kg/m}\cdot\text{s}$. Noting that $D = D_0 = 4.1 \text{ m}$, the Nusselt number becomes

$$\begin{aligned} \text{Re} &= \frac{V_\infty D}{\nu} = \frac{[(40 \times 1000/3600) \text{ m/s}](4.1 \text{ m})}{1.516 \times 10^{-5} \text{ m}^2/\text{s}} = 3.005 \times 10^6 \\ Nu &= \frac{hD}{k} = 2 + \left[0.4 \text{Re}^{0.5} + 0.06 \text{Re}^{2/3} \right] \text{Pr}^{0.4} \left(\frac{\mu_\infty}{\mu_s} \right)^{1/4} \\ &= 2 + \left[0.4(3.005 \times 10^6)^{0.5} + 0.06(3.005 \times 10^6)^{2/3} \right] (0.7309)^{0.4} \left(\frac{1.825 \times 10^{-5}}{1.189 \times 10^{-5}} \right)^{1/4} = 1910 \end{aligned}$$

$$\text{and } h = \frac{k}{D} Nu = \frac{0.02514 \text{ W/m}\cdot\text{°C}}{4.1 \text{ m}} (1910) = 11.71 \text{ W/m}^2\cdot\text{°C}$$

The rate of heat transfer to the liquid nitrogen is

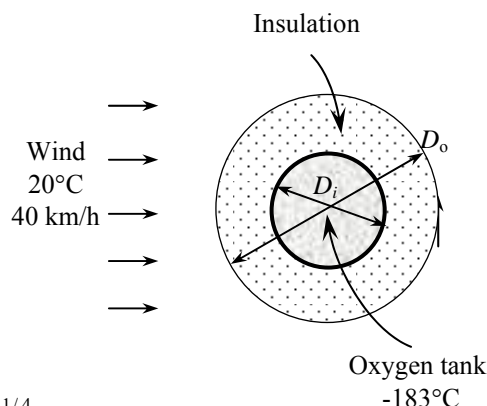

$$\begin{aligned}
 A_s &= \pi D^2 = \pi(4.1 \text{ m})^2 = 52.81 \text{ m}^2 \\
 \dot{Q} &= \frac{T_\infty - T_{s,\text{tan } k}}{R_{\text{insulation}} + R_{\text{conv}}} = \frac{T_\infty - T_{s,\text{tan } k}}{\frac{r_2 - r_1}{4\pi k r_1 r_2} + \frac{1}{hA_s}} \\
 &= \frac{[20 - (-183)]^\circ\text{C}}{\frac{(2.05 - 2) \text{ m}}{4\pi(0.035 \text{ W/m}\cdot^\circ\text{C})(2.05 \text{ m})(2 \text{ m})} + \frac{1}{(11.71 \text{ W/m}^2\cdot^\circ\text{C})(52.81 \text{ m}^2)}} = 6918 \text{ W}
 \end{aligned}$$

The rate of evaporation of liquid nitrogen then becomes

$$\dot{Q} = \dot{m}h_{if} \longrightarrow \dot{m} = \frac{\dot{Q}}{h_{if}} = \frac{6.918 \text{ kJ/s}}{213 \text{ kJ/kg}} = \mathbf{0.0325 \text{ kg/s}}$$

(c) Again we use the dynamic viscosity value at the estimated surface temperature of 0°C to be $\mu = 1.729 \times 10^{-5} \text{ kg/m}\cdot\text{s}$. Noting that $D = D_0 = 4.04 \text{ m}$ in this case, the Nusselt number becomes

$$\begin{aligned}
 \text{Re} &= \frac{VD}{\nu} = \frac{[(40 \times 1000/3600) \text{ m/s}](4.04 \text{ m})}{1.516 \times 10^{-5} \text{ m}^2/\text{s}} = 2.961 \times 10^6 \\
 \text{Nu} &= \frac{hD}{k} = 2 + \left[0.4 \text{Re}^{0.5} + 0.06 \text{Re}^{2/3} \right] \text{Pr}^{0.4} \left(\frac{\mu_\infty}{\mu_s} \right)^{1/4} \\
 &= 2 + \left[0.4(2.961 \times 10^6)^{0.5} + 0.06(2.961 \times 10^6)^{2/3} \right] (0.713)^{0.4} \left(\frac{1.825 \times 10^{-5}}{1.729 \times 10^{-5}} \right)^{1/4} = 1724
 \end{aligned}$$

$$\text{and } h = \frac{k}{D} \text{Nu} = \frac{0.02514 \text{ W/m}\cdot^\circ\text{C}}{4.04 \text{ m}} (1724) = 10.73 \text{ W/m}^2\cdot^\circ\text{C}$$

The rate of heat transfer to the liquid nitrogen is

$$\begin{aligned}
 A_s &= \pi D^2 = \pi(4.04 \text{ m})^2 = 51.28 \text{ m}^2 \\
 \dot{Q} &= \frac{T_\infty - T_{s,\text{tan } k}}{R_{\text{insulation}} + R_{\text{conv}}} = \frac{T_\infty - T_{s,\text{tan } k}}{\frac{r_2 - r_1}{4\pi k r_1 r_2} + \frac{1}{hA_s}} \\
 &= \frac{[20 - (-183)]^\circ\text{C}}{\frac{(2.02 - 2) \text{ m}}{4\pi(0.00005 \text{ W/m}\cdot^\circ\text{C})(2.02 \text{ m})(2 \text{ m})} + \frac{1}{(10.73 \text{ W/m}^2\cdot^\circ\text{C})(51.28 \text{ m}^2)}} = 25.8 \text{ W}
 \end{aligned}$$

The rate of evaporation of liquid oxygen then becomes

$$\dot{Q} = \dot{m}h_{if} \longrightarrow \dot{m} = \frac{\dot{Q}}{h_{if}} = \frac{0.0258 \text{ kJ/s}}{213 \text{ kJ/kg}} = \mathbf{1.21 \times 10^{-4} \text{ kg/s}}$$

7-108 A circuit board houses 80 closely spaced logic chips on one side. All the heat generated is conducted across the circuit board and is dissipated from the back side of the board to the ambient air, which is forced to flow over the surface by a fan. The temperatures on the two sides of the circuit board are to be determined.

Assumptions 1 Steady operating conditions exist. 2 The critical Reynolds number is $Re_{cr} = 5 \times 10^5$. 3 Radiation effects are negligible. 4 Air is an ideal gas with constant properties. 7 The pressure of air is 1 atm.

Properties Assuming a film temperature of 40°C , the properties of air are (Table A-15)

$$k = 0.02662 \text{ W/m}\cdot^\circ\text{C}$$

$$\nu = 1.702 \times 10^{-5} \text{ m}^2/\text{s}$$

$$Pr = 0.7255$$

Analysis The Reynolds number is

$$Re_L = \frac{VL}{\nu} = \frac{[(300/60) \text{ m/s}](0.18 \text{ m})}{1.702 \times 10^{-5} \text{ m}^2/\text{s}} = 5.288 \times 10^4$$

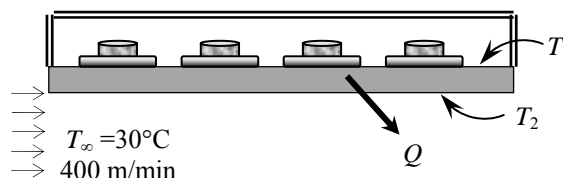

which is less than the critical Reynolds number. Therefore, the flow is laminar. Using the proper relation for Nusselt number, heat transfer coefficient is determined to be

$$Nu = \frac{hL}{k} = 0.664 Re_L^{0.5} Pr^{1/3} = 0.664(5.288 \times 10^4)^{0.5} (0.7255)^{1/3} = 137.2$$

$$h = \frac{k}{L} Nu = \frac{0.02662 \text{ W/m}\cdot^\circ\text{C}}{0.18 \text{ m}} (137.2) = 20.29 \text{ W/m}^2\cdot^\circ\text{C}$$

The temperatures on the two sides of the circuit board are

$$\begin{aligned} \dot{Q} &= hA_s(T_2 - T_\infty) \rightarrow T_2 = T_\infty + \frac{\dot{Q}}{hA_s} \\ &= 30^\circ\text{C} + \frac{(80 \times 0.06) \text{ W}}{(20.29 \text{ W/m}^2\cdot^\circ\text{C})(0.12 \text{ m})(0.18 \text{ m})} = \mathbf{40.95^\circ\text{C}} \end{aligned}$$

$$\begin{aligned} \dot{Q} &= \frac{kA_s}{L}(T_1 - T_2) \rightarrow T_1 = T_2 + \frac{\dot{Q}L}{kA_s} \\ &= 40.95^\circ\text{C} + \frac{(80 \times 0.06 \text{ W})(0.005 \text{ m})}{(16 \text{ W/m}\cdot^\circ\text{C})(0.12 \text{ m})(0.18 \text{ m})} = \mathbf{41.02^\circ\text{C}} \end{aligned}$$

7-109E The equivalent wind chill temperature of an environment at 10°F at various winds speeds are

$$\begin{aligned} V = 10 \text{ mph: } T_{equiv} &= 91.4 - (91.4 - T_{ambient})(0.475 - 0.0203V + 0.304\sqrt{V}) \\ &= 91.4 - [91.4 - (10^\circ\text{F})][0.475 - 0.0203(10 \text{ mph}) + 0.304\sqrt{10 \text{ mph}}] = \mathbf{-9^\circ\text{F}} \end{aligned}$$

$$V = 20 \text{ mph: } T_{equiv} = 91.4 - [91.4 - (10^\circ\text{F})][0.475 - 0.0203(20 \text{ mph}) + 0.304\sqrt{20 \text{ mph}}] = \mathbf{-24.9^\circ\text{F}}$$

$$V = 30 \text{ mph: } T_{equiv} = 91.4 - [91.4 - (10^\circ\text{F})][0.475 - 0.0203(30 \text{ mph}) + 0.304\sqrt{30 \text{ mph}}] = \mathbf{-33.2^\circ\text{F}}$$

$$V = 40 \text{ mph: } T_{equiv} = 91.4 - [91.4 - (10^\circ\text{F})][0.475 - 0.0203(40 \text{ mph}) + 0.304\sqrt{40 \text{ mph}}] = \mathbf{-37.7^\circ\text{F}}$$

In the last three cases, the person needs to be concerned about the possibility of freezing.

7-110E EES Prob. 7-109E is reconsidered. The equivalent wind chill temperatures in °F as a function of wind velocity is to be plotted.

Analysis The problem is solved using EES, and the solution is given below.

"ANALYSIS"

$$T_{\text{equiv}} = 91.4 - (91.4 - T_{\text{ambient}}) * (0.475 - 0.0203 * \text{Vel} + 0.304 * \sqrt{\text{Vel}})$$

Vel [mph]	T _{ambient} [F]	T _{equiv} [F]
4	20	19.87
8	20	7.688
12	20	-0.3124
16	20	-6.147
20	20	-10.6
24	20	-14.06
28	20	-16.79
32	20	-18.92
36	20	-20.57
40	20	-21.82
4	40	39.91
8	40	31.14
12	40	25.38
16	40	21.18
20	40	17.97
24	40	15.48
28	40	13.52
32	40	11.98
36	40	10.79
40	40	9.897
4	60	59.94
8	60	54.59
12	60	51.07
16	60	48.5
20	60	46.54
24	60	45.02
28	60	43.82
32	60	42.88
36	60	42.16
40	60	41.61

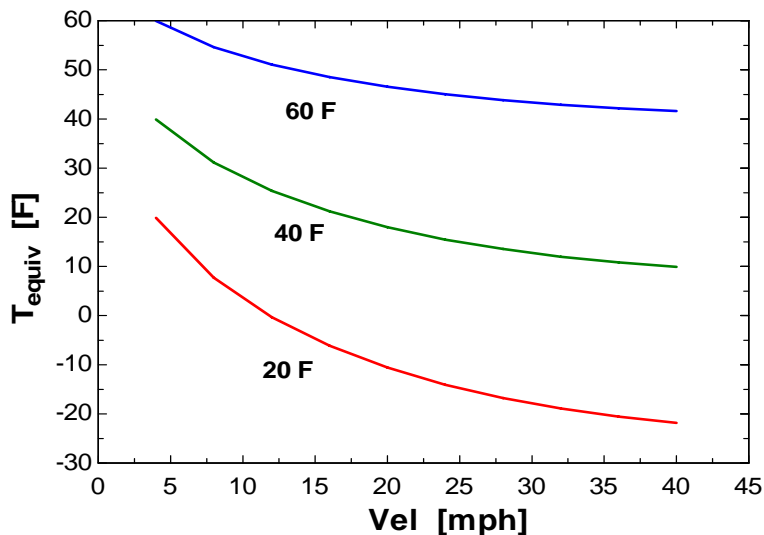

7-111 Air flows over a plate. Various quantities are to be determined at $x = 0.3$ m and $x = x_{cr}$.

Assumptions 1 The flow is steady and incompressible. 2 The critical Reynolds number is $Re_{cr} = 5 \times 10^5$. 3 Air is an ideal gas. 4 The plate is smooth. 5 Edge effects are negligible and the upper surface of the plate is considered.

Properties The properties of air at the film temperature of $(T_s + T_\infty)/2 = (65 + 15)/2 = 40^\circ\text{C}$ are (Table A-15)

$$\rho = 1.127 \text{ kg/m}^3$$

$$c_p = 1007 \text{ J/kg}\cdot^\circ\text{C}$$

$$k = 0.02662 \text{ W/m}\cdot^\circ\text{C}$$

$$\mu = 1.918 \times 10^{-5} \text{ kg/m}\cdot\text{s}$$

$$Pr = 0.7255$$



Analysis The critical length of the plate is first determined to be

$$x_{cr} = \frac{Re_{cr} \mu}{V \rho} = \frac{(5 \times 10^5)(1.918 \times 10^{-5} \text{ kg/m}\cdot\text{s})}{(3 \text{ m/s})(1.127 \text{ kg/m}^3)} = 2.84 \text{ m}$$

The calculations at $x = 0.3$ m are

$$Re_x = \frac{Vx\rho}{\mu} = \frac{(3 \text{ m/s})(0.3 \text{ m})(1.127 \text{ kg/m}^3)}{1.918 \times 10^{-5} \text{ kg/m}\cdot\text{s}} = 52,883$$

(a) Hydrodynamic boundary layer thickness, Eq. 6-51:

$$\delta = \frac{5x}{\sqrt{Re_x}} = \frac{5(0.3 \text{ m})}{\sqrt{52,883}} = \mathbf{0.0065 \text{ m}}$$

(b) Local friction coefficient, Eq. 6-54:

$$C_{f,x} = 0.664 Re_x^{-1/2} = 0.664(52,883)^{-1/2} = \mathbf{0.0029}$$

(c) Average friction coefficient, Eq. 7-14:

$$C_f = \frac{1.33}{Re_x^{1/2}} = \frac{1.33}{52,883^{1/2}} = \mathbf{0.0058}$$

(d) Local shear stress due to friction, Eq. 6-10:

$$\tau_s = C_f \frac{\rho V^2}{2} = (0.0058) \frac{(1.127 \text{ kg/m}^3)(3 \text{ m/s})^2}{2} = \mathbf{0.0293 \text{ N/m}^2}$$

(e) Total drag force, Eq. 6-11:

$$F_f = C_f A_s \frac{\rho V^2}{2} = (0.0058)(0.3 \times 0.3 \text{ m}^2) \frac{(1.127 \text{ kg/m}^3)(3 \text{ m/s})^2}{2} = \mathbf{0.0026 \text{ N}}$$

(f) Thermal boundary layer thickness, Eq. 6-63:

$$\delta_t = \frac{5x}{Pr^{1/3} \sqrt{Re_x}} = \frac{5(0.3 \text{ m})}{(0.7255)^{1/3} \sqrt{52,883}} = \mathbf{0.0073 \text{ m}}$$

(g) Local convection heat transfer coefficient, Eq. 7-19:

$$Nu_x = 0.332 Re_x^{1/2} Pr^{1/3} = 0.332(52,883)^{1/2} (0.7255)^{1/3} = 68.6$$

$$h_x = \frac{k}{x} Nu_x = \frac{0.02662 \text{ W/m}\cdot^\circ\text{C}}{0.3 \text{ m}} (68.6) = \mathbf{6.09 \text{ W/m}^2\cdot^\circ\text{C}}$$

(h) Average convection heat transfer coefficient, Eq. 7-21:

$$\text{Nu} = 0.664 \text{Re}^{1/2} \text{Pr}^{1/3} = 0.664(52,883)^{1/2} (0.7255)^{1/3} = 137.2$$

$$h = \frac{k}{x} \text{Nu}_x = \frac{0.02662 \text{ W/m}\cdot\text{°C}}{0.3 \text{ m}} (137.2) = \mathbf{12.2 \text{ W/m}^2\cdot\text{°C}}$$

(i) Rate of convective heat transfer, Eq. 6-2:

$$\dot{Q} = hA_s(T_s - T_\infty) = (12.2 \text{ W/m}^2\cdot\text{°C})(0.3 \times 0.3 \text{ m}^2)(65 - 15)\text{°C} = \mathbf{54.9 \text{ W}}$$

Repeating the calculations at $x_{\text{cr}} = 2.84 \text{ m}$, we obtain

$\text{Re}_x = 500,626$	$\delta = \mathbf{0.020 \text{ m}}$	$C_{f,x} = \mathbf{0.00094}$
$C_f = \mathbf{0.0019}$	$\tau_s = \mathbf{0.0095 \text{ N/m}^2}$	$F_f = \mathbf{0.0082 \text{ N}}$
$\delta_t = \mathbf{0.022 \text{ m}}$	$\text{Nu}_x = 211$	$h_x = \mathbf{1.98 \text{ W/m}^2\cdot\text{°C}}$
$\text{Nu} = 422$	$h = \mathbf{3.96 \text{ W/m}^2\cdot\text{°C}}$	$\dot{Q} = \mathbf{169 \text{ W}}$

7-112 Oil flows over a flat plate that is maintained at a specified temperature. The rate of heat transfer is to be determined.

Assumptions 1 Steady operating conditions exist. 2 The critical Reynolds number is $\text{Re}_{\text{cr}} = 5 \times 10^5$. 3 Radiation effects are negligible.

Properties The properties of oil are given to be $\rho = 880 \text{ kg/m}^3$, $\mu = 0.005 \text{ kg/m}\cdot\text{s}$, $k = 0.15 \text{ W/m}\cdot\text{K}$, and $c_p = 2.0 \text{ kJ/kg}\cdot\text{K}$.

Analysis The Prandtl and Reynolds numbers are

$$\text{Pr} = \frac{\mu c_p}{k} = \frac{(0.005 \text{ kg/m}\cdot\text{s})(2000 \text{ J/kg}\cdot\text{°C})}{0.15 \text{ W/m}\cdot\text{°C}} = 66.7$$

$$\text{Re}_L = \frac{VL\rho}{\mu} = \frac{(0.2 \text{ m/s})(5 \text{ m})(880 \text{ kg/m}^3)}{5 \times 10^{-3} \text{ kg/m}\cdot\text{s}} = 176,000$$

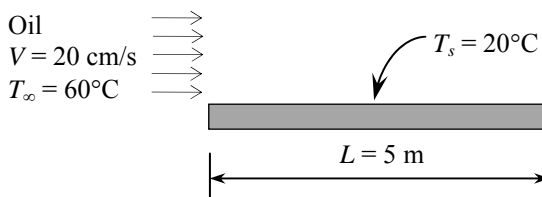

which is smaller than the critical Reynolds number. Thus we have laminar flow for the entire plate. The Nusselt number and the heat transfer coefficient are

$$\text{Nu} = 0.664 \text{Re}_L^{1/2} \text{Pr}^{1/3} = 0.664(176,000)^{1/2} (66.7)^{1/3} = 1130$$

$$h = \frac{k}{L} \text{Nu} = \frac{0.15 \text{ W/m}\cdot\text{°C}}{5 \text{ m}} (1130) = 33.9 \text{ W/m}^2\cdot\text{°C}$$

Then the rate of heat transfer is determined to be

$$\dot{Q} = hA_s(T_s - T_\infty) = (33.9 \text{ W/m}^2\cdot\text{°C})(5 \times 1 \text{ m}^2)(60 - 20)\text{°C} = \mathbf{6780 \text{ W}}$$

7-113 A small sphere made of lead is cooled in an air column. The terminal velocity of the sphere, the heat transfer coefficient for the sphere at its mean temperature, and the column height for the indicated cooling of the lead sphere are to be determined.

Assumptions 1 Steady operating conditions exist. 2 Radiation effects are negligible. 3 Air is an ideal gas with constant properties.

Properties The properties of lead are given to be $\rho = 11,300 \text{ kg/m}^3$, $k = 33 \text{ W/m}\cdot\text{K}$, and $c_p = 0.13 \text{ kJ/kg}\cdot\text{K}$. The properties of air at 1 atm pressure and the free stream temperature of 27°C are (Table A-15)

$$k = 0.02566 \text{ W/m}\cdot^\circ\text{C}$$

$$\nu = 1.580 \times 10^{-5} \text{ m}^2/\text{s}$$

$$\mu_\infty = 1.858 \times 10^{-5} \text{ kg/m}\cdot\text{s}$$

$$\mu_{s, @0.5(200+54)=127^\circ\text{C}} = 2.292 \times 10^{-5} \text{ kg/m}\cdot\text{s}$$

$$\text{Pr} = 0.7290$$

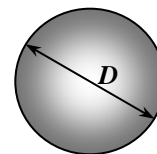

↓ Air
 $T_\infty = 27^\circ\text{C}$

Analysis (a) The terminal velocity is determined from the relation given to be

$$V_t = \left[\frac{2(\rho - \rho_{\text{air}})Vg}{C_D \rho_{\text{air}} A_p} \right]^{0.5} = \left[\frac{2(11,300 - 1.18)(9.81) \left(\frac{2}{3} \times 0.002 \right)}{(0.40)(1.18)} \right]^{0.5} = \mathbf{25.0 \text{ m/s}}$$

since $\frac{V}{A_p} = \frac{\pi D^3 / 6}{\pi D^2 / 4} = \frac{2}{3} D$

(b) The Reynolds number is

$$\text{Re} = \frac{VD}{\nu} = \frac{(25.0 \text{ m/s})(0.002 \text{ m})}{1.580 \times 10^{-5} \text{ m}^2/\text{s}} = 3167$$

The Nusselt number corresponding this Reynolds number is determined to be

$$\begin{aligned} Nu &= \frac{hD}{k} = 2 + \left[0.4 \text{Re}^{0.5} + 0.06 \text{Re}^{2/3} \right] \text{Pr}^{0.4} \left(\frac{\mu_\infty}{\mu_s} \right)^{1/4} \\ &= 2 + \left[0.4(3167)^{0.5} + 0.06(3167)^{2/3} \right] (0.7290)^{0.4} \left(\frac{1.858 \times 10^{-5}}{2.292 \times 10^{-5}} \right)^{1/4} = 31.64 \end{aligned}$$

Heat transfer coefficient is

$$h = \frac{k}{D} Nu = \frac{0.02566 \text{ W/m}\cdot^\circ\text{C}}{0.002 \text{ m}} (31.64) = \mathbf{406 \text{ W/m}^2 \cdot ^\circ\text{C}}$$

(c) For sphere, the characteristic length and the Biot number are

$$\begin{aligned} L_c &= \frac{V}{A_{\text{surface}}} = \frac{\pi D^3 / 6}{\pi D^2} = \frac{D}{6} = \frac{0.002 \text{ m}}{6} = 0.0003333 \text{ m} \\ Bi &= \frac{hL_c}{k} = \frac{(406 \text{ W/m}^2 \cdot ^\circ\text{C})(0.0003333 \text{ m})}{33 \text{ W/m}\cdot^\circ\text{C}} = 0.0041 < 0.1 \end{aligned}$$

Since $Bi < 0.1$, the lumped system analysis is applicable. Then the cooling time is determined from

$$\begin{aligned} b &= \frac{hA}{\rho c_p V} = \frac{h}{\rho c_p L_c} = \frac{406 \text{ W/m}^2 \cdot ^\circ\text{C}}{(11,300 \text{ kg/m}^3)(130 \text{ J/kg}\cdot^\circ\text{C})(0.0003333 \text{ m})} = 0.829 \text{ s}^{-1} \\ \frac{T(t) - T_\infty}{T_i - T_\infty} &= e^{-bt} \longrightarrow \frac{54 - 27}{200 - 27} = e^{-(0.829 \text{ s}^{-1})t} \longrightarrow t = 2.24 \text{ s} \end{aligned}$$

Then the height of the column is determined to be

$$\text{Height} = V\Delta t = (25 \text{ m/s})(2.24 \text{ s}) = \mathbf{56 \text{ m}}$$

7-114 A small sphere made of lead is cooled in an air column. The terminal velocity of the sphere, the heat transfer coefficient for the sphere at its mean temperature, and the column height for the indicated cooling of the lead sphere are to be determined.

Assumptions 1 Steady operating conditions exist. 2 Radiation effects are negligible. 3 Air is an ideal gas with constant properties.

Properties The properties of lead are given to be $\rho = 11,300 \text{ kg/m}^3$, $k = 33 \text{ W/m}\cdot\text{K}$, and $c_p = 0.13 \text{ kJ/kg}\cdot\text{K}$. The properties of air at 1 atm pressure and the free stream temperature of 27°C are (Table A-15)

$$k = 0.02566 \text{ W/m}\cdot^\circ\text{C}$$

$$\nu = 1.580 \times 10^{-5} \text{ m}^2/\text{s}$$

$$\mu_\infty = 1.858 \times 10^{-5} \text{ kg/m}\cdot\text{s}$$

$$\mu_{s, @ 0.5(200+54)=127^\circ\text{C}} = 2.292 \times 10^{-5} \text{ kg/m}\cdot\text{s}$$

$$\text{Pr} = 0.7290$$

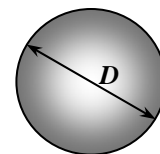

↓ $T_\infty = 27^\circ\text{C}$

Analysis (a) The terminal velocity is determined from the relation given to be

$$V_t = \left[\frac{2(\rho - \rho_{\text{air}})Vg}{C_D \rho_{\text{air}} A_p} \right]^{0.5} = \left[\frac{2(11,300 - 1.18)(9.81) \left(\frac{2}{3} \times 0.005 \right)}{(0.40)(1.18)} \right]^{0.5} = \mathbf{28.0 \text{ m/s}}$$

since $\frac{V}{A_p} = \frac{\pi D^3 / 6}{\pi D^2 / 4} = \frac{2}{3} D$

(b) The Reynolds number is

$$\text{Re} = \frac{VD}{\nu} = \frac{(28.0 \text{ m/s})(0.005 \text{ m})}{1.580 \times 10^{-5} \text{ m}^2/\text{s}} = 8861$$

The Nusselt number corresponding to this Reynolds number is determined to be

$$\begin{aligned} Nu &= \frac{hD}{k} = 2 + \left[0.4 \text{Re}^{0.5} + 0.06 \text{Re}^{2/3} \right] \text{Pr}^{0.4} \left(\frac{\mu_\infty}{\mu_s} \right)^{1/4} \\ &= 2 + \left[0.4(8861)^{0.5} + 0.06(8861)^{2/3} \right] (0.7290)^{0.4} \left(\frac{1.858 \times 10^{-5}}{2.292 \times 10^{-5}} \right)^{1/4} = 54.97 \end{aligned}$$

Heat transfer coefficient is

$$h = \frac{k}{D} Nu = \frac{0.02566 \text{ W/m}\cdot^\circ\text{C}}{0.005 \text{ m}} (54.97) = \mathbf{282.1 \text{ W/m}^2\cdot^\circ\text{C}}$$

(c) For sphere, the characteristic length and the Biot number are

$$L_c = \frac{V}{A_{\text{surface}}} = \frac{\pi D^3 / 6}{\pi D^2} = \frac{D}{6} = \frac{0.005 \text{ m}}{6} = 0.0008333 \text{ m}$$

$$\text{Bi} = \frac{hL_c}{k} = \frac{(282.1 \text{ W/m}^2\cdot^\circ\text{C})(0.0008333 \text{ m})}{33 \text{ W/m}\cdot^\circ\text{C}} = 0.0071 < 0.1$$

Since $\text{Bi} < 0.1$, the lumped system analysis is applicable. Then the cooling time is determined from

$$b = \frac{hA}{\rho c_p V} = \frac{h}{\rho c_p L_c} = \frac{282.1 \text{ W/m}^2\cdot^\circ\text{C}}{(11,300 \text{ kg/m}^3)(130 \text{ J/kg}\cdot^\circ\text{C})(0.0008333 \text{ m})} = 0.2305 \text{ s}^{-1}$$

$$\frac{T(t) - T_\infty}{T_i - T_\infty} = e^{-bt} \longrightarrow \frac{54 - 27}{200 - 27} = e^{-(0.2305 \text{ s}^{-1})t} \longrightarrow t = 8.06 \text{ s}$$

Then the height of the column is determined to be

$$\text{Height} = V\Delta t = (28 \text{ m/s})(8.06 \text{ s}) = \mathbf{226 \text{ m}}$$

7-115 Square silicon chips are cooled by air flowing parallel to the row of chips. The chip with the highest temperature is to be identified, and the maximum power that can be dissipated per chip and the temperature of the 5th chip are to be determined. Also, two cooling schemes are to be compared.

Assumptions 1 Steady operating conditions exist. **2** The critical Reynolds number is $Re_{cr} = 5 \times 10^5$. **3** The temperature is uniform within each chip and no heat transfer occurs between adjacent chips, and T_∞ is the same throughout the array.

Properties The properties of air at the film temperature of $(T_s + T_\infty)/2 = (100 + 24)/2 = 62^\circ\text{C}$ are (Table A-15)

$$k = 0.02823 \text{ W/m}\cdot^\circ\text{C}$$

$$\nu = 1.916 \times 10^{-5} \text{ m}^2/\text{s}$$

$$Pr = 0.7197$$

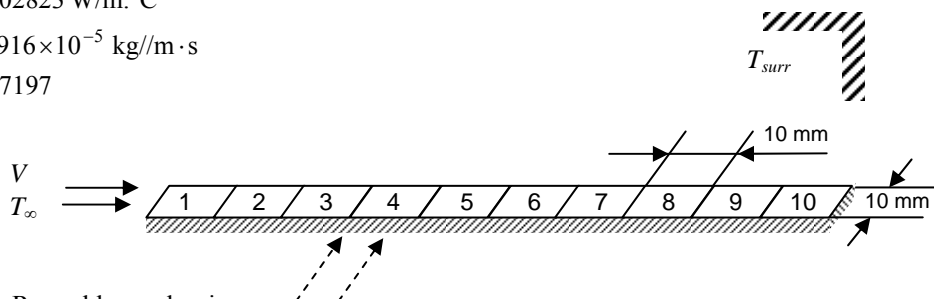

Analysis (a) The Reynolds number is

$$Re_L = \frac{VL}{\nu} = \frac{(30 \text{ m/s})(0.1 \text{ m})}{1.916 \times 10^{-5} \text{ m}^2/\text{s}} = 1.566 \times 10^5$$

which is smaller than the critical Reynolds number. Thus we have laminar flow for the entire plate. The convection heat transfer coefficient decreases continually in the flow direction in the laminar flow region (see Fig. 7-9 in the text) and therefore, the last chip with the lowest convection coefficient will have the highest temperature.

(b) The local heat transfer coefficient for the last chip (chip number 10) is

$$Re_{0.095 \text{ m}} = \frac{VL}{\nu} = \frac{(30 \text{ m/s})(0.095 \text{ m})}{1.916 \times 10^{-5} \text{ m}^2/\text{s}} = 1.487 \times 10^5$$

where the distance is taken to the middle of the chip (for average h for the chip). Then the local Nusselt number is

$$Nu_{10} = 0.332 Re_{0.095}^{1/2} Pr^{1/3} = 0.332(1.487 \times 10^5)^{1/2} (0.7197)^{1/3} = 114.7$$

$$h_{10} = \frac{k}{L} Nu_{10} = \frac{0.02823 \text{ W/m}\cdot^\circ\text{C}}{0.095 \text{ m}} (114.7) = 34.1 \text{ W/m}^2\cdot^\circ\text{C}$$

From an energy balance

$$\begin{aligned} \dot{Q}_{10} &= hA(T_{10} - T_\infty) + \varepsilon A \sigma (T_{10}^4 - T_{surr}^4) \\ &= (34.1)(0.01^2)(100 - 24) + (0.85)(0.01^2)(5.67 \times 10^{-8})(373^4 - 263^4) = \mathbf{0.329 \text{ W}} \end{aligned}$$

(c) The temperature of the 5th chip is determined as follows:

$$Re_{0.045 \text{ m}} = \frac{VL}{\nu} = \frac{(30 \text{ m/s})(0.045 \text{ m})}{1.916 \times 10^{-5} \text{ m}^2/\text{s}} = 7.046 \times 10^4$$

$$Nu_5 = 0.332 Re_{0.045}^{1/2} Pr^{1/3} = 0.332(7.046 \times 10^4)^{1/2} (0.7197)^{1/3} = 78.98$$

$$h_5 = \frac{k}{L} Nu_5 = \frac{0.02823 \text{ W/m}\cdot^\circ\text{C}}{0.045 \text{ m}} (78.98) = 49.54 \text{ W/m}^2\cdot^\circ\text{C}$$

$$\begin{aligned} \dot{Q}_5 &= hA(T_5 - T_\infty) + \varepsilon A \sigma (T_5^4 - T_{surr}^4) \\ 0.329 &= (49.54)(0.01^2)(T_5 - 297) + (0.85)(0.01^2)(5.67 \times 10^{-8})(T_5^4 - 263^4) \end{aligned}$$

Solving by trial-error or using EES, we obtain

$$T_5 = 353 \text{ K} = \mathbf{80^\circ\text{C}}$$

(d) The cooling will be improved with the second scheme because all chips will be “front row” chips characterized by maximum convection heat transfer coefficient. However, for this scheme the cooling system will need to provide 10 times more cooling air. This means bigger fan and bigger power consumption.

7-116 Air is heated by an array of electrical heating elements. The rate of heat transfer to air and the exit temperature of air are to be determined.

Assumptions 1 Steady operating conditions exist.

Properties The exit temperature of air, and thus the mean temperature, is not known. We evaluate the air properties at the assumed mean temperature of 35°C (will be checked later) and 1 atm (Table A-15):

$$\begin{aligned} k &= 0.02625 \text{ W/m}\cdot\text{K} & \rho &= 1.145 \text{ kg/m}^3 \\ c_p &= 1.007 \text{ kJ/kg}\cdot\text{K} & \text{Pr} &= 0.7268 \\ \mu &= 1.895 \times 10^{-5} \text{ kg/m}\cdot\text{s} & \text{Pr}_s = \text{Pr}_{@T_s} &= 0.6937 \end{aligned}$$

Also, the density of air at the inlet temperature of 25°C (for use in the mass flow rate calculation at the inlet) is $\rho_i = 1.184 \text{ kg/m}^3$.

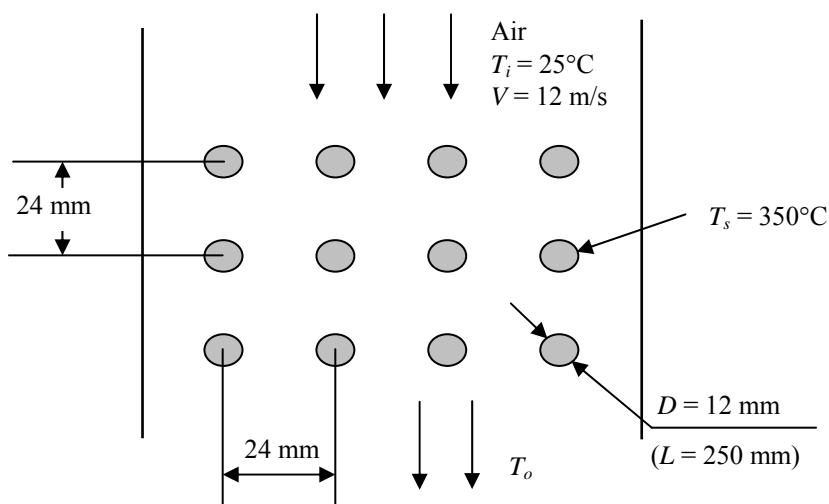

Analysis It is given that $D = 0.012 \text{ m}$, $S_L = S_T = 0.024 \text{ m}$, and $V = 12 \text{ m/s}$. Then the maximum velocity and the Reynolds number based on the maximum velocity become

$$\begin{aligned} V_{\max} &= \frac{S_T}{S_T - D} V = \frac{24}{24 - 12} (12 \text{ m/s}) = 24 \text{ m/s} \\ \text{Re}_D &= \frac{\rho V_{\max} D}{\mu} = \frac{(1.145 \text{ kg/m}^3)(24 \text{ m/s})(0.012 \text{ m})}{1.895 \times 10^{-5} \text{ kg/m}\cdot\text{s}} = 17,400 \end{aligned}$$

The average Nusselt number is determined using the proper relation from Table 7-2 to be

$$\begin{aligned} \text{Nu}_D &= 0.27 \text{Re}_D^{0.63} \text{Pr}^{0.36} (\text{Pr}/\text{Pr}_s)^{0.25} \\ &= 0.27(17,400)^{0.63} (0.7268)^{0.36} (0.7268/0.6937)^{0.25} = 114.3 \end{aligned}$$

This Nusselt number is applicable to tube banks with $N_L > 16$. In our case the number of rows is $N_L = 3$, and the corresponding correction factor from Table 7-3 is $F = 0.86$. Then the average Nusselt number and heat transfer coefficient for all the tubes in the tube bank become

$$\begin{aligned} \text{Nu}_{D,N_L} &= F \text{Nu}_D = (0.86)(114.3) = 98.3 \\ h &= \frac{\text{Nu}_{D,N_L} k}{D} = \frac{98.3(0.02625 \text{ W/m}\cdot\text{K})}{0.012 \text{ m}} = 215.0 \text{ W/m}^2 \cdot \text{K} \end{aligned}$$

The total number of tubes is $N = N_L \times N_T = 3 \times 4 = 12$. The heat transfer surface area and the mass flow rate of air (evaluated at the inlet) are

$$A_s = N\pi DL = 12\pi(0.012 \text{ m})(0.25 \text{ m}) = 0.1131 \text{ m}^2$$

$$\dot{m} = \dot{m}_i = \rho_i V(N_T S_T L) = (1.184 \text{ kg/m}^3)(12 \text{ m/s})(4)(0.024 \text{ m})(0.25 \text{ m}) = 0.3410 \text{ kg/s}$$

Then the fluid exit temperature, the log mean temperature difference, and the rate of heat transfer become

$$T_e = T_s - (T_s - T_i) \exp\left(-\frac{A_s h}{\dot{m} c_p}\right) = 350 - (350 - 25) \exp\left(-\frac{(0.1131 \text{ m}^2)(215.0 \text{ W/m}^2 \cdot ^\circ\text{C})}{(0.3410 \text{ kg/s})(1007 \text{ J/kg} \cdot ^\circ\text{C})}\right) = 47.22^\circ\text{C}$$

$$\Delta T_{\ln} = \frac{(T_s - T_i) - (T_s - T_e)}{\ln[(T_s - T_i)/(T_s - T_e)]} = \frac{(350 - 25) - (350 - 47.22)}{\ln[(350 - 25)/(350 - 47.22)]} = 313.8^\circ\text{C}$$

$$\dot{Q} = h A_s \Delta T_{\ln} = (215.0 \text{ W/m}^2 \cdot ^\circ\text{C})(0.1131 \text{ m}^2)(313.8^\circ\text{C}) = \mathbf{7630 \text{ W}}$$

Fundamentals of Engineering (FE) Exam Problems

7-117 For laminar flow of a fluid along a flat plate, one would expect the largest local convection heat transfer coefficient for the same Reynolds and Prandtl numbers when

- (a) The same temperature is maintained on the surface
- (b) The same heat flux is maintained on the surface
- (c) The plate has an unheated section
- (d) The plate surface is polished
- (e) None of the above

Answer (b)

7-118 Air at 20°C flows over a 4-m long and 3-m wide surface of a plate whose temperature is 80°C with a velocity of 5 m/s. The length of the surface for which the flow remains laminar is

- (a) 1.5 m
- (b) 1.8 m
- (c) 2.0 m
- (d) 2.8 m
- (e) 4.0 m

(For air, use $k = 0.02735 \text{ W/m}\cdot\text{°C}$, $Pr = 0.7228$, $\nu = 1.798 \times 10^{-5} \text{ m}^2/\text{s}$.)

Answer (b) 1.8 m

Solution Solved by EES Software. Solutions can be verified by copying-and-pasting the following lines on a blank EES screen.

```
T_infinity=20 [C]
T_s=80 [C]
L=4 [m]
W=3 [m]
V=5 [m/s]
```

"Properties of air at the film temperature of $(80+20)/2=50\text{C}$ are (Table A-15)"

```
k=0.02735 [W/m-C]
nu=1.798E-5 [m^2/s]
Pr=0.7228
```

```
Re_cr=5E5
x_cr=(Re_cr*nu)/V
```

7-119 Air at 20°C flows over a 4-m long and 3-m wide surface of a plate whose temperature is 80°C with a velocity of 5 m/s. The rate of heat transfer from the laminar flow region of the surface is

- (a) 950 W (b) 1037 W (c) 2074 W (d) 2640 W (e) 3075 W

(For air, use $k=0.02735$ W/m·°C, $Pr = 0.7228$, $\nu = 1.798 \times 10^{-5}$ m²/s.)

Answer (c) 2074 W

Solution Solved by EES Software. Solutions can be verified by copying-and-pasting the following lines on a blank EES screen.

```
T_infinity=20 [C]
T_s=80 [C]
L=4 [m]
W=3 [m]
V=5 [m/s]
```

"Properties of air at the film temperature of $(80+20)/2=50$ C are (Table A-15)"

```
k=0.02735 [W/m-C]
nu=1.798E-5 [m^2/s]
Pr=0.7228
```

```
Re_cr=5E5
x_cr=(Re_cr*nu)/V
Nus=0.664*Re_cr^0.5*Pr^(1/3)
h=k/x_cr*Nus
A_laminar=x_cr*W
Q_dot=h*A_laminar*(T_s-T_infinity)
```

"Some Wrong Solutions with Common Mistakes"

```
W_Nus=0.332*Re_cr^0.5*Pr^(1/3) "Using local Nusselt number relation"
W_h=k/x_cr*W_Nus
W_Q_dot=W_h*A_laminar*(T_s-T_infinity)
```

7-120 Air at 20°C flows over a 4-m long and 3-m wide surface of a plate whose temperature is 80°C with a velocity of 5 m/s. The rate of heat transfer from the surface is

- (a) 7383 W (b) 8985 W (c) 11,231 W (d) 14,672 W (e) 20,402 W

(For air, use $k=0.02735$ W/m·°C, $Pr = 0.7228$, $\nu = 1.798 \times 10^{-5}$ m²/s.)

Answer (a) 7383 W

Solution Solved by EES Software. Solutions can be verified by copying-and-pasting the following lines on a blank EES screen.

```
T_infinity=20 [C]
T_s=80 [C]
L=4 [m]
W=3 [m]
V=5 [m/s]
```

"Properties of air at the film temperature of $(80+20)/2=50$ C are (Table A-15)"

```
k=0.02735 [W/m-C]
nu=1.798E-5 [m^2/s]
Pr=0.7228
```

$Re=(V*L)/nu$ "The calculated Re number is greater than critical number, and therefore we have combined laminar-turbulent flow"

```
Nus=(0.037*Re^0.8-871)*Pr^(1/3)
h=k/L*Nus
A_s=L*W
Q_dot=h*A_s*(T_s-T_infinity)
```

"Some Wrong Solutions with Common Mistakes"

```
W1_Nus=0.037*Re^0.8*Pr^(1/3) "Using turbulent flow relation"
W1_h=k/L*W1_Nus
W1_Q_dot=W1_h*A_s*(T_s-T_infinity)
```

7-121 Air at 15°C flows over a flat plate subjected to a uniform heat flux of 300 W/m² with a velocity of 3.5 m/s. The surface temperature of the plate 6 m from the leading edge is

- (a) 164°C (b) 68.3°C (c) 48.1 °C (d) 46.8°C (e) 37.5°C

(For air, use $k=0.02551$ W/m·°C, $Pr = 0.7296$, $\nu = 1.562 \times 10^{-5}$ m²/s.)

Answer (d) 46.8°C

Solution Solved by EES Software. Solutions can be verified by copying-and-pasting the following lines on a blank EES screen.

```
T_infinity=15 [C]
q_dot=300 [W/m^2]
V=3.5 [m/s]
x=6 [m]
```

"Properties of air at 25 C are (Table A-15)"

```
k=0.02551 [W/m-C]
nu=1.562E-5 [m^2/s]
Pr=0.7296
```

$Re_x=(V*x)/\nu$ "The calculated Re number is greater than critical number, and therefore we have turbulent flow at the specified location"

```
Nus=0.0308*Re_x^0.8*Pr^(1/3)
```

```
h=k/x*Nus
```

```
q_dot=h*(T_s-T_infinity)
```

"Some Wrong Solutions with Common Mistakes"

$W1_Nus=0.453*Re_x^{0.5}*Pr^{(1/3)}$ "Using laminar flow Nusselt number relation for $q_dot = \text{constant}$ "

```
W1_h=k/x*W1_Nus
```

```
q_dot=W1_h*(W1_T_s-T_infinity)
```

$W2_Nus=0.0296*Re_x^{0.8}*Pr^{(1/3)}$ "Using turbulent flow Nusselt number relation for $T_s = \text{constant}$ "

```
W2_h=k/x*W2_Nus
```

```
q_dot=W2_h*(W2_T_s-T_infinity)
```

7-122 Water at 75°C flows over a 2-m-long, 2-m-wide surface of a plate whose temperature is 5°C with a velocity of 1.5 m/s. The total drag force acting on the plate is

- (a) 2.8 N (b) 12.3 N (c) 13.7 N (d) 15.4 N (e) 20.0 N

(For air, use $\nu = 0.658 \times 10^{-6} \text{ m}^2/\text{s}$, $\rho = 992 \text{ kg/m}^3$.)

Answer (c) 13.7 N

Solution Solved by EES Software. Solutions can be verified by copying-and-pasting the following lines on a blank EES screen.

```
T_infinity=75 [C]
T_s=5 [C]
L=2 [m]
W=2 [m]
V=1.5 [m/s]
```

"Properties of water at the film temperature of $(75+5)/2=40\text{C}$ are (Table A-9)"

```
nu=0.658E-6 [m^2/s]
rho=992 [kg/m^3]
```

$Re=(V*L)/nu$ "The calculated Re number is greater than critical number, and therefore we have combined laminar-turbulent flow"

```
C_f=0.074/Re^(1/5)-1742/Re
A_s=L*W
F_D=C_f*A_s*(rho*V^2)/2
```

"Some Wrong Solutions with Common Mistakes"

```
W1_C_f=0.074/Re^(1/5) "Using turbulent flow relation"
W1_F_D=W1_C_f*A_s*(rho*V^2)/2
W2_C_f=1.328/Re^(1/2) "Using laminar flow relation"
W2_F_D=W2_C_f*A_s*(rho*V^2)/2
W3_C_f=0.0592/Re^(1/5) "Using local turbulent flow relation"
W3_F_D=W3_C_f*A_s*(rho*V^2)/2
```

7-123 Engine oil at 105°C flows over the surface of a flat plate whose temperature is 15°C with a velocity of 1.5 m/s. The local drag force per unit surface area 0.8 m from the leading edge of the plate is

- (a) 21.8 N/m² (b) 14.3 N/m² (c) 10.9 N/m² (d) 8.5 N/m² (e) 5.5 N/m²

(For oil, use $\nu = 8.565 \times 10^{-5} \text{ m}^2/\text{s}$, $\rho = 864 \text{ kg/m}^3$.)

Answer (e) 5.5 N/m²

Solution Solved by EES Software. Solutions can be verified by copying-and-pasting the following lines on a blank EES screen.

T_infinity=105 [C]

T_s=15 [C]

V=1.5 [m/s]

x=0.8 [m]

"Properties of oil at the film temperature of $(105+15)/2=60\text{C}$ are (Table A-13)"

rho=864 [kg/m^3]

nu=8.565E-5 [m^2/s]

Re_x=(V*x)/nu "The calculated Re number is smaller than the critical number, and therefore we have laminar flow"

C_f_x=0.664/Re_x^(1/2)

F_D=C_f_x*(rho*V^2)/2

"Some Wrong Solutions with Common Mistakes"

W1_C_f_x=0.0592/Re_x^(1/5) "Using local turbulent flow relation"

W1_F_D=W1_C_f_x*(rho*V^2)/2

W2_C_f_x=1.328/Re_x^(1/2) "Using average laminar flow relation"

W2_F_D=W2_C_f_x*(rho*V^2)/2

7-124 Air at 25°C flows over a 5-cm-diameter, 1.7-m-long pipe with a velocity of 4 m/s. A refrigerant at -15°C flows inside the pipe and the surface temperature of the pipe is essentially the same as the refrigerant temperature inside. Air properties at the average temperature are $k=0.0240$ W/m·°C, $Pr = 0.735$, $\nu = 1.382 \times 10^{-5}$ m²/s. The rate of heat transfer to the pipe is

- (a) 343 W (b) 419 W (c) 485 W (d) 547 W (e) 610 W

Answer (a) 343 W

Solution Solved by EES Software. Solutions can be verified by copying-and-pasting the following lines on a blank EES screen.

```
T_infinity=25 [C]
T_s=-15 [C]
D=0.05 [m]
L=1.7 [m]
V=4 [m/s]
"Properties of air at the film temperature of (25-15)/2=5 C are (Table A-15)"
k=0.0240 [W/m-C]
nu=1.382E-5 [m^2/s]
Pr=0.735
Re=(V*D)/nu
Nus=0.3+(0.62*Re^(1/2)*Pr^(1/3))/(1+(0.4/Pr)^(2/3))^(1/4)*(1+(Re/282000)^(5/8))^(4/5)
h=k/D*Nus
A_s=pi*D*L
Q_dot=h*A_s*(T_infinity-T_s)
```

7-125 Air at 25°C flows over a 5-cm-diameter, 1.7-m-long smooth pipe with a velocity of 4 m/s. A refrigerant at -15°C flows inside the pipe and the surface temperature of the pipe is essentially the same as the refrigerant temperature inside. The drag force exerted on the pipe by the air is

- (a) 0.4 N (b) 1.1 N (c) 8.5 N (d) 13 N (e) 18 N

(For air, use $\nu = 1.382 \times 10^{-5}$ m²/s, $\rho = 1.269$ kg/m³.)

Answer (b) 1.1 N

Solution Solved by EES Software. Solutions can be verified by copying-and-pasting the following lines on a blank EES screen.

```
T_infinity=25 [C]
T_s=-15 [C]
D=0.05 [m]
L=1.7 [m]
V=4 [m/s]
"Properties of air at the film temperature of (25-15)/2=5 C are (Table A-15)"
rho=1.269 [kg/m^3]
nu=1.382E-5 [m^2/s]
Re=(V*D)/nu "The drag coefficient corresponding to the calculated Re = 14,472 is (Fig. 7-17)"
C_D=1.3
A=L*D
F_D=C_D*A*rho*V^2/2
```

7-126 Kitchen water at 10°C flows over a 10-cm-diameter pipe with a velocity of 1.1 m/s. Geothermal water enters the pipe at 90°C at a rate of 1.25 kg/s. For calculation purposes, the surface temperature of the pipe may be assumed to be 70°C. If the geothermal water is to leave the pipe at 50°C, the required length of the pipe is

- (a) 1.1 m (b) 1.8 m (c) 2.5 m (d) 4.3 m (e) 7.6 m

(For both water streams, use $k = 0.631 \text{ W/m}\cdot\text{C}$, $Pr = 4.32$, $\nu = 0.658 \times 10^{-6} \text{ m}^2/\text{s}$, $c_p = 4179 \text{ J/kg}\cdot\text{C}$.)

Answer (d) 4.3 m

Solution Solved by EES Software. Solutions can be verified by copying-and-pasting the following lines on a blank EES screen.

```
T_infinity=10 [C]
D=0.10 [m]
V=1.1 [m/s]
T_s=70 [C]
T_geo_in=90 [C]
T_geo_out=50 [C]
m_dot_geo=1.25 [kg/s]
```

"Properties of water at the film temperature of $(10+70)/2=40 \text{ C}$ are (Table A-9)"

```
k=0.631 [W/m-C]
Pr=4.32
c_p=4179 [J/kg-C]
nu=0.658E-6 [m^2/s]
```

```
Re=(V*D)/nu
Nus=0.3+(0.62*Re^(1/2)*Pr^(1/3))/(1+(0.4/Pr)^(2/3))^(1/4)*(1+(Re/282000)^(5/8))^(4/5)
h=k/D*Nus
q=h*(T_s-T_infinity)
Q_dot=m_dot_geo*c_p*(T_s-T_infinity)
A_s=Q_dot/q
L=A_s/(pi*D)
```

7-127 Ambient air at 20°C flows over a 30-cm-diameter hot spherical object with a velocity of 2.5 m/s. If the average surface temperature of the object is 200°C, the average convection heat transfer coefficient during this process is

- (a) 5.0 W/m²·°C (b) 6.1 W/m²·°C (c) 7.5 W/m²·°C (d) 9.3 W/m²·°C (e) 11.7 W/m²·°C

(For air, use $k=0.02514$ W/m·°C, $Pr = 0.7309$, $\nu=1.516\times 10^{-5}$ m²/s, $\mu_{\infty}=1.825\times 10^{-5}$ kg/m·s, $\mu_s = 2.577\times 10^{-5}$ kg/m·s.)

Answer (e) 11.7 W/m²·°C

Solution Solved by EES Software. Solutions can be verified by copying-and-pasting the following lines on a blank EES screen.

```
D=0.3 [m]
T_infinity=20 [C]
T_s=200 [C]
V=2.5 [m/s]
```

"Properties of air at the free-stream temperature of 20 C are (Table A-15)"

```
k=0.02514 [W/m-C]
nu=1.516E-5 [m^2/s]
Pr=0.7309
mu_infinity=1.825E-5 [kg/m-s]
mu_s=2.577E-5 [kg/m-s] "at the surface temperature of 200 C"
```

```
Re=(V*D)/nu
Nus=2+(0.4*Re^(1/2)+0.06*Re^(2/3))*Pr^0.4*(mu_infinity/mu_s)^(1/4)
h=k/D*Nus
```

7-128 Wind at 30°C flows over a 0.5-m-diameter spherical tank containing iced water at 0°C with a velocity of 25 km/h. If the tank is thin-shelled with a high thermal conductivity material, the rate at which ice melts is

- (a) 4.78 kg/h (b) 6.15 kg/h (c) 7.45 kg/h (d) 11.8 kg/h (e) 16.0 kg/h

(Take $h_{if} = 333.7$ kJ/kg and use the following for air: $k = 0.02588$ W/m·°C, $Pr = 0.7282$, $\nu = 1.608 \times 10^{-5}$ m²/s, $\mu_{\infty} = 1.872 \times 10^{-5}$ kg/m·s, $\mu_s = 1.729 \times 10^{-5}$ kg/m·s)

Answer (a) 4.78 kg/h

Solution Solved by EES Software. Solutions can be verified by copying-and-pasting the following lines on a blank EES screen.

```
D=0.5 [m]
T_infinity=30 [C]
T_s=0 [C]
V=25 [km/h]*Convert(km/h, m/s)

"Properties of air at the free-stream temperature of 30 C are (Table A-15)"
k=0.02588 [W/m-C]
nu=1.608E-5 [m^2/s]
Pr=0.7282
mu_infinity=1.872E-5 [kg/m-s]
mu_s=1.729E-5 [kg/m-s] "at the surface temperature of 0 C"

Re=(V*D)/nu
Nus=2+(0.4*Re^(1/2)+0.06*Re^(2/3))*Pr^0.4*(mu_infinity/mu_s)^(1/4)
h=k/D*Nus
A_s=pi*D^2
Q_dot=h*A_s*(T_infinity-T_s)*Convert(W, kW)
h_if=333.7 [kJ/kg] "Heat of fusion of water at 0 C"
m_dot_cond=Q_dot/h_if*Convert(kg/s, kg/h)
```

7-129 Air ($k = 0.028$ W/m·K, $Pr = 0.7$) at 50°C flows along a 1 m long flat plate whose temperature is maintained at 20°C with a velocity such that the Reynolds number at the end of the plate is 10,000. The heat transfer per unit width between the plate and air is

- (a) 20 W/m (b) 30 W/m (c) 40 W/m (d) 50 W/m (e) 60 W/m

Answer (d) 50 W/m

Solution Solved by EES Software. Solutions can be verified by copying-and-pasting the following lines on a blank EES screen.

```
Re= 10000
Pr=0.7
l=1 [m]
k=0.028 [W/m-K]
Ta=50 [C]
Tp=20 [C]
h=0.664*k*Re^0.5*Pr^0.333/l
Q=h*l*(Ta-Tp)
```

7-130 Air ($Pr = 0.7$, $k = 0.026$ W/m·K) at 200°C flows across 2 cm-diameter tubes whose surface temperature is 50°C with a Reynolds number of 8000. The Churchill and Bernstein convective heat transfer correlation for the average Nusselt number in this situation is $Nu = 0.3 + \frac{0.62Re^{0.5} Pr^{0.33}}{[1 + (0.4/Pr)^{0.67}]^{0.25}}$. The average

heat flux in this case is

- (a) 8.5 kW/m² (b) 9.7 kW/m² (c) 10.5 kW/m² (d) 12.2 kW/m² (e) 13.9 kW/m²

Answer (a) 8.5 kW/m²

Solution Solved by EES Software. Solutions can be verified by copying-and-pasting the following lines on a blank EES screen.

```
Pr=0.7
k=0.026 [W/m-K]
Re=8000
dT=150 [K]
D=0.02 [m]
Nusselt=0.3+0.62*Re^0.5*Pr^0.33/(1+(0.4/Pr)^0.67)^0.25
Q=k*Nusselt*dT/D
```

7-131 Jakob suggests the following correlation be used for square tubes in a liquid cross-flow situation:

$Nu = 0.102Re^{0.675} Pr^{1/3}$. Water ($k = 0.61$ W/m·K, $Pr = 6$) flows across a 1 cm square tube with a Reynolds number of 10,000. The convection heat transfer coefficient is

- (a) 5.7 kW/m²·K (b) 8.3 kW/m²·K (c) 11.2 kW/m²·K (d) 15.6 kW/m²·K (e) 18.1 kW/m²·K

Answer (a) 5.7 kW/m²·K

Solution Solved by EES Software. Solutions can be verified by copying-and-pasting the following lines on a blank EES screen.

```
k=0.61 [W/m-K]
Pr = 6
L=0.01 [m]
Re=10000
Nus=0.102*Re^0.675*Pr^0.333
h=Nus*k/L
```

7-132 Jakob suggests the following correlation be used for square tubes in a liquid cross-flow situation:

$Nu = 0.102Re^{0.675} Pr^{1/3}$. Water ($k = 0.61$ W/m·K, $Pr = 6$) at 50°C flows across a 1 cm square tube with a Reynolds number of 10,000 and surface temperature of 75°C . If the tube is 2 m long, the rate of heat transfer between the tube and water is

- (a) 6.0 kW (b) 8.2 kW (c) 11.3 kW (d) 15.7 kW (e) 18.1 kW

Answer (c) 11.3 kW

Solution Solved by EES Software. Solutions can be verified by copying-and-pasting the following lines on a blank EES screen.

```
k=0.61 [W/m-K]
Pr = 6
L=0.01 [m]
Lg=2 [m]
DT=25 [K]
Re=10000
Nus=0.102*Re^0.675*Pr^0.333
h=Nus*k/L
Q=4*L*Lg*h*DT
```

7-133 7-137 Design and Essay Problems



Chapter 8

INTERNAL FORCED CONVECTION

General Flow Analysis

8-1C Liquids are usually transported in circular pipes because pipes with a circular cross-section can withstand large pressure differences between the inside and the outside without undergoing any distortion.

8-2C Reynolds number for flow in a circular tube of diameter D is expressed as

$$\text{Re} = \frac{V_{\text{avg}} D}{\nu} \quad \text{where} \quad V_{\infty} = \frac{\dot{m}}{\rho A_c} = \frac{\dot{m}}{\rho(\pi D^2 / 4)} = \frac{4\dot{m}}{\rho \pi D^2} \quad \text{and} \quad \nu = \frac{\mu}{\rho}$$

Substituting,

$$\text{Re} = \frac{V_{\text{avg}} D}{\nu} = \frac{4\dot{m}D}{\rho \pi D^2 (\mu / \rho)} = \frac{4\dot{m}}{\pi D \mu}$$

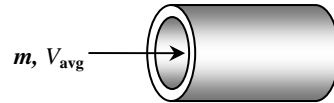

8-3C Engine oil requires a larger pump because of its much larger density.

8-4C The generally accepted value of the Reynolds number above which the flow in a smooth pipe is turbulent is 4000.

8-5C For flow through non-circular tubes, the Reynolds number as well as the Nusselt number and the friction factor are based on the hydraulic diameter D_h defined as $D_h = \frac{4A_c}{p}$ where A_c is the cross-sectional area of the tube and p is its perimeter. The hydraulic diameter is defined such that it reduces to ordinary diameter D for circular tubes since $D_h = \frac{4A_c}{p} = \frac{4\pi D^2 / 4}{\pi D} = D$.

8-6C The region from the tube inlet to the point at which the boundary layer merges at the centerline is called the *hydrodynamic entry region*, and the length of this region is called *hydrodynamic entry length*. The entry length is much longer in laminar flow than it is in turbulent flow. But at very low Reynolds numbers, L_h is very small ($L_h = 1.2D$ at $\text{Re} = 20$).

8-7C The friction factor is highest at the tube inlet where the thickness of the boundary layer is zero, and decreases gradually to the fully developed value. The same is true for turbulent flow.

8-8C In turbulent flow, the tubes with rough surfaces have much higher friction factors than the tubes with smooth surfaces. In the case of laminar flow, the effect of surface roughness on the friction factor is negligible.

8-9C The friction factor f remains constant along the flow direction in the fully developed region in both laminar and turbulent flow.

8-10C The fluid viscosity is responsible for the development of the velocity boundary layer. For the idealized inviscid fluids (fluids with zero viscosity), there will be no velocity boundary layer.

8-11C The number of transfer units NTU is a measure of the heat transfer area and effectiveness of a heat transfer system. A small value of NTU ($NTU < 5$) indicates more opportunities for heat transfer whereas a large NTU value ($NTU > 5$) indicates that heat transfer will not increase no matter how much we extend the length of the tube.

8-12C The logarithmic mean temperature difference ΔT_{\ln} is an exact representation of the average temperature difference between the fluid and the surface for the entire tube. It truly reflects the exponential decay of the local temperature difference. The error in using the arithmetic mean temperature increases to undesirable levels when ΔT_e differs from ΔT_i by great amounts. Therefore we should always use the logarithmic mean temperature.

8-13C The region of flow over which the thermal boundary layer develops and reaches the tube center is called the thermal entry region, and the length of this region is called the thermal entry length. The region in which the flow is both hydrodynamically (the velocity profile is fully developed and remains unchanged) and thermally (the dimensionless temperature profile remains unchanged) developed is called the fully developed region.

8-14C The heat flux will be higher near the inlet because the heat transfer coefficient is highest at the tube inlet where the thickness of thermal boundary layer is zero, and decreases gradually to the fully developed value.

8-15C The heat flux will be higher near the inlet because the heat transfer coefficient is highest at the tube inlet where the thickness of thermal boundary layer is zero, and decreases gradually to the fully developed value.

8-16C In the fully developed region of flow in a circular tube, the velocity profile will not change in the flow direction but the temperature profile may.

8-17C The hydrodynamic and thermal entry lengths are given as $L_h = 0.05 \text{ Re } D$ and $L_t = 0.05 \text{ Re Pr } D$ for laminar flow, and $L_h \approx L_t \approx 10D$ in turbulent flow. Noting that $\text{Pr} \gg 1$ for oils, the thermal entry length is larger than the hydrodynamic entry length in laminar flow. In turbulent, the hydrodynamic and thermal entry lengths are independent of Re or Pr numbers, and are comparable in magnitude.

8-18C The hydrodynamic and thermal entry lengths are given as $L_h = 0.05 \text{ Re } D$ and $L_t = 0.05 \text{ Re Pr } D$ for laminar flow, and $L_h \approx L_t \approx 10D$ in turbulent flow. Noting that $\text{Pr} \ll 1$ for liquid metals, the thermal entry length is smaller than the hydrodynamic entry length in laminar flow. In turbulent, the hydrodynamic and thermal entry lengths are independent of Re or Pr numbers, and are comparable in magnitude.

8-19C In fluid flow, it is convenient to work with an average or mean velocity V_{avg} and an average or mean temperature T_m which remain constant in incompressible flow when the cross-sectional area of the tube is constant. The V_{avg} and T_m represent the velocity and temperature, respectively, at a cross section if all the particles were at the same velocity and temperature.

8-20C When the surface temperature of tube is constant, the appropriate temperature difference for use in the Newton's law of cooling is logarithmic mean temperature difference that can be expressed as

$$\Delta T_{\ln} = \frac{\Delta T_e - \Delta T_i}{\ln(\Delta T_e / \Delta T_i)}$$

8-21 Air flows inside a duct and it is cooled by water outside. The exit temperature of air and the rate of heat transfer are to be determined.

Assumptions 1 Steady operating conditions exist. 2 The surface temperature of the duct is constant. 3 The thermal resistance of the duct is negligible.

Properties The properties of air at the anticipated average temperature of 30°C are (Table A-15)

$$\rho = 1.164 \text{ kg/m}^3$$

$$c_p = 1007 \text{ J/kg}\cdot^\circ\text{C}$$

Analysis The mass flow rate of water is

$$\dot{m} = \rho A_c V_{\text{avg}} = \rho \left(\frac{\pi D^2}{4} \right) V_{\text{avg}} = (1.164 \text{ kg/m}^3) \frac{\pi (0.25 \text{ m})^2}{4} (7 \text{ m/s}) = 0.400 \text{ kg/s}$$

$$A_s = \pi DL = \pi (0.25 \text{ m})(12 \text{ m}) = 9.425 \text{ m}^2$$

The exit temperature of air is determined from

$$T_e = T_s - (T_s - T_i) e^{-hA_s / (\dot{m}c_p)} = 10 - (10 - 50) e^{-\frac{(85)(9.425)}{(0.400)(1007)}} = \mathbf{15.47^\circ\text{C}}$$

The logarithmic mean temperature difference and the rate of heat transfer are

$$\Delta T_{\text{ln}} = \frac{T_e - T_i}{\ln\left(\frac{T_s - T_e}{T_s - T_i}\right)} = \frac{15.47 - 50}{\ln\left(\frac{10 - 15.47}{10 - 50}\right)} = 17.36^\circ\text{C}$$

$$\dot{Q} = hA_s \Delta T_{\text{ln}} = (85 \text{ W/m}^2 \cdot ^\circ\text{C})(9.425 \text{ m}^2)(17.36^\circ\text{C}) = 13,900 \text{ W} = \mathbf{13.9 \text{ kW}}$$

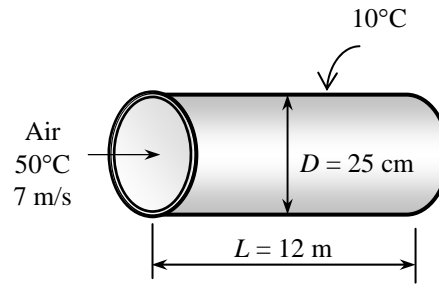

8-22 Steam is condensed by cooling water flowing inside copper tubes. The average heat transfer coefficient and the number of tubes needed are to be determined.

Assumptions 1 Steady operating conditions exist. 2 The surface temperature of the pipe is constant. 3 The thermal resistance of the pipe is negligible.

Properties The properties of water at the average temperature of $(10+24)/2=17^\circ\text{C}$ are (Table A-9)

$$\rho = 998.7 \text{ kg/m}^3$$

$$c_p = 4183.8 \text{ J/kg}\cdot^\circ\text{C}$$

Also, the heat of vaporization of water at 30°C is $h_{fg} = 2431 \text{ kJ/kg}$.

Analysis The mass flow rate of water and the surface area are

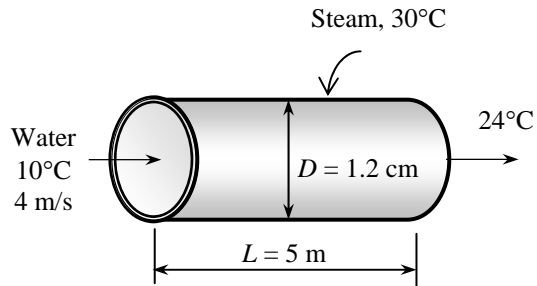

$$\dot{m} = \rho A_c V_{\text{avg}} = \rho \left(\frac{\pi D^2}{4} \right) V_{\text{avg}} = (998.7 \text{ kg/m}^3) \frac{\pi (0.012 \text{ m})^2}{4} (4 \text{ m/s}) = 0.4518 \text{ kg/s}$$

The rate of heat transfer for one tube is

$$\dot{Q} = \dot{m} c_p (T_e - T_i) = (0.4518 \text{ kg/s})(4183.8 \text{ J/kg}\cdot^\circ\text{C})(24 - 10^\circ\text{C}) = 26,460 \text{ W}$$

The logarithmic mean temperature difference and the surface area are

$$\Delta T_{\ln} = \frac{T_e - T_i}{\ln \left(\frac{T_s - T_e}{T_s - T_i} \right)} = \frac{24 - 10}{\ln \left(\frac{30 - 24}{30 - 10} \right)} = 11.63^\circ\text{C}$$

$$A_s = \pi D L = \pi (0.012 \text{ m})(5 \text{ m}) = 0.1885 \text{ m}^2$$

The average heat transfer coefficient is determined from

$$\dot{Q} = h A_s \Delta T_{\ln} \longrightarrow h = \frac{\dot{Q}}{A_s \Delta T_{\ln}} = \frac{26,460 \text{ W}}{(0.1885 \text{ m}^2)(11.63^\circ\text{C})} \left(\frac{1 \text{ kW}}{1000 \text{ W}} \right) = 12.1 \text{ kW/m}^2\cdot^\circ\text{C}$$

The total rate of heat transfer is determined from

$$\dot{Q}_{\text{total}} = \dot{m}_{\text{cond}} h_{fg} = (0.15 \text{ kg/s})(2431 \text{ kJ/kg}) = 364.65 \text{ kW}$$

Then the number of tubes becomes

$$N_{\text{tube}} = \frac{\dot{Q}_{\text{total}}}{\dot{Q}} = \frac{364,650 \text{ W}}{26,460 \text{ W}} = 13.8$$

8-23 Steam is condensed by cooling water flowing inside copper tubes. The average heat transfer coefficient and the number of tubes needed are to be determined.

Assumptions 1 Steady operating conditions exist. 2 The surface temperature of the pipe is constant. 3 The thermal resistance of the pipe is negligible.

Properties The properties of water at the average temperature of $(10+24)/2=17^\circ\text{C}$ are (Table A-9)

$$\rho = 998.7 \text{ kg/m}^3$$

$$c_p = 4183.8 \text{ J/kg}\cdot^\circ\text{C}$$

Also, the heat of vaporization of water at 30°C is $h_{fg} = 2431 \text{ kJ/kg}$.

Analysis The mass flow rate of water is

$$\dot{m} = \rho A_c V_{\text{avg}} = \rho \left(\frac{\pi D^2}{4} \right) V_{\text{avg}} = (998.7 \text{ kg/m}^3) \frac{\pi (0.012 \text{ m})^2}{4} (4 \text{ m/s}) = 0.4518 \text{ kg/s}$$

The rate of heat transfer for one tube is

$$\dot{Q} = \dot{m} c_p (T_e - T_i) = (0.4518 \text{ kg/s})(4183.8 \text{ J/kg}\cdot^\circ\text{C})(24 - 10^\circ\text{C}) = 26,460 \text{ W}$$

The logarithmic mean temperature difference and the surface area are

$$\Delta T_{\text{ln}} = \frac{T_e - T_i}{\ln \left(\frac{T_s - T_e}{T_s - T_i} \right)} = \frac{24 - 10}{\ln \left(\frac{30 - 24}{30 - 10} \right)} = 11.63^\circ\text{C}$$

$$A_s = \pi D L = \pi (0.012 \text{ m})(5 \text{ m}) = 0.1885 \text{ m}^2$$

The average heat transfer coefficient is determined from

$$\dot{Q} = h A_s \Delta T_{\text{ln}} \longrightarrow h = \frac{\dot{Q}}{A_s \Delta T_{\text{ln}}} = \frac{26,460 \text{ W}}{(0.1885 \text{ m}^2)(11.63^\circ\text{C})} \left(\frac{1 \text{ kW}}{1000 \text{ W}} \right) = \mathbf{12.1 \text{ kW/m}^2 \cdot ^\circ\text{C}}$$

The total rate of heat transfer is determined from

$$\dot{Q}_{\text{total}} = \dot{m}_{\text{cond}} h_{fg} = (0.60 \text{ kg/s})(2431 \text{ kJ/kg}) = 1458.6 \text{ kW}$$

Then the number of tubes becomes

$$N_{\text{tube}} = \frac{\dot{Q}_{\text{total}}}{\dot{Q}} = \frac{1,458,600 \text{ W}}{26,460 \text{ W}} = \mathbf{55.1}$$

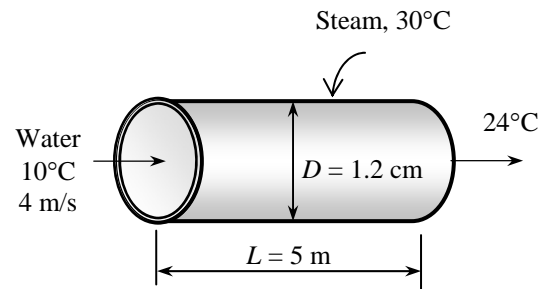

8-24 Combustion gases passing through a tube are used to vaporize waste water. The tube length and the rate of evaporation of water are to be determined.

Assumptions 1 Steady operating conditions exist. 2 The surface temperature of the pipe is constant. 3 The thermal resistance of the pipe is negligible. 4 Air properties are to be used for exhaust gases.

Properties The properties of air at the average temperature of $(250+150)/2=200^\circ\text{C}$ are (Table A-15)

$$c_p = 1023 \text{ J/kg}\cdot^\circ\text{C}$$

$$R = 0.287 \text{ kJ/kg}\cdot\text{K}$$

Also, the heat of vaporization of water at 1 atm or 100°C is $h_{fg} = 2257 \text{ kJ/kg}$ (Table A-9).

Analysis The density of air at the inlet and the mass flow rate of exhaust gases are

$$\rho = \frac{P}{RT} = \frac{115 \text{ kPa}}{(0.287 \text{ kJ/kg}\cdot\text{K})(250 + 273 \text{ K})} = 0.7662 \text{ kg/m}^3$$

$$\dot{m} = \rho A_c V_{\text{avg}} = \rho \left(\frac{\pi D^2}{4} \right) V_{\text{avg}} = (0.7662 \text{ kg/m}^3) \frac{\pi(0.03 \text{ m})^2}{4} (5 \text{ m/s}) = 0.002708 \text{ kg/s}$$

The rate of heat transfer is

$$\dot{Q} = \dot{m} c_p (T_i - T_e) = (0.002708 \text{ kg/s})(1023 \text{ J/kg}\cdot^\circ\text{C})(250 - 150^\circ\text{C}) = 277.0 \text{ W}$$

The logarithmic mean temperature difference and the surface area are

$$\Delta T_{\text{ln}} = \frac{T_e - T_i}{\ln\left(\frac{T_s - T_e}{T_s - T_i}\right)} = \frac{150 - 250}{\ln\left(\frac{110 - 150}{110 - 250}\right)} = 79.82^\circ\text{C}$$

$$\dot{Q} = h A_s \Delta T_{\text{ln}} \longrightarrow A_s = \frac{\dot{Q}}{h \Delta T_{\text{ln}}} = \frac{277.0 \text{ W}}{(120 \text{ W/m}^2\cdot^\circ\text{C})(79.82^\circ\text{C})} = 0.02891 \text{ m}^2$$

Then the tube length becomes

$$A_s = \pi D L \longrightarrow L = \frac{A_s}{\pi D} = \frac{0.02891 \text{ m}^2}{\pi(0.03 \text{ m})} = 0.3067 \text{ m} = \mathbf{30.7 \text{ cm}}$$

The rate of evaporation of water is determined from

$$\dot{Q} = \dot{m}_{\text{evap}} h_{fg} \longrightarrow \dot{m}_{\text{evap}} = \frac{\dot{Q}}{h_{fg}} = \frac{(0.2770 \text{ kW})}{(2257 \text{ kJ/kg})} = 0.0001227 \text{ kg/s} = \mathbf{0.442 \text{ kg/h}}$$

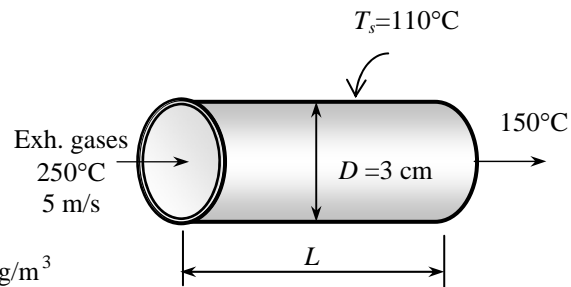

8-25 Combustion gases passing through a tube are used to vaporize waste water. The tube length and the rate of evaporation of water are to be determined.

Assumptions 1 Steady operating conditions exist. 2 The surface temperature of the pipe is constant. 3 The thermal resistance of the pipe is negligible. 4 Air properties are to be used for exhaust gases.

Properties The properties of air at the average temperature of $(250+150)/2=200^\circ\text{C}$ are (Table A-15)

$$c_p = 1023 \text{ J/kg}\cdot^\circ\text{C}$$

$$R = 0.287 \text{ kJ/kg}\cdot\text{K}$$

Also, the heat of vaporization of water at 1 atm or 100°C is $h_{fg} = 2257 \text{ kJ/kg}$ (Table A-9).

Analysis The density of air at the inlet and the mass flow rate of exhaust gases are

$$\rho = \frac{P}{RT} = \frac{115 \text{ kPa}}{(0.287 \text{ kJ/kg}\cdot\text{K})(250 + 273 \text{ K})} = 0.7662 \text{ kg/m}^3$$

$$\dot{m} = \rho A_c V_{\text{avg}} = \rho \left(\frac{\pi D^2}{4} \right) V_{\text{avg}} = (0.7662 \text{ kg/m}^3) \frac{\pi (0.03 \text{ m})^2}{4} (5 \text{ m/s}) = 0.002708 \text{ kg/s}$$

The rate of heat transfer is

$$\dot{Q} = \dot{m} c_p (T_i - T_e) = (0.002708 \text{ kg/s})(1023 \text{ J/kg}\cdot^\circ\text{C})(250 - 150^\circ\text{C}) = 277.0 \text{ W}$$

The logarithmic mean temperature difference and the surface area are

$$\Delta T_{\text{ln}} = \frac{T_e - T_i}{\ln\left(\frac{T_s - T_e}{T_s - T_i}\right)} = \frac{150 - 250}{\ln\left(\frac{110 - 150}{110 - 250}\right)} = 79.82^\circ\text{C}$$

$$\dot{Q} = h A_s \Delta T_{\text{ln}} \longrightarrow A_s = \frac{\dot{Q}}{h \Delta T_{\text{ln}}} = \frac{277.0 \text{ W}}{(40 \text{ W/m}^2\cdot^\circ\text{C})(79.82^\circ\text{C})} = 0.08673 \text{ m}^2$$

Then the tube length becomes

$$A_s = \pi D L \longrightarrow L = \frac{A_s}{\pi D} = \frac{0.08673 \text{ m}^2}{\pi (0.03 \text{ m})} = 0.920 \text{ m} = \mathbf{92.0 \text{ cm}}$$

The rate of evaporation of water is determined from

$$\dot{Q} = \dot{m}_{\text{evap}} h_{fg} \longrightarrow \dot{m}_{\text{evap}} = \frac{\dot{Q}}{h_{fg}} = \frac{(0.2770 \text{ kW})}{(2257 \text{ kJ/kg})} = 0.0001227 \text{ kg/s} = \mathbf{0.442 \text{ kg/h}}$$

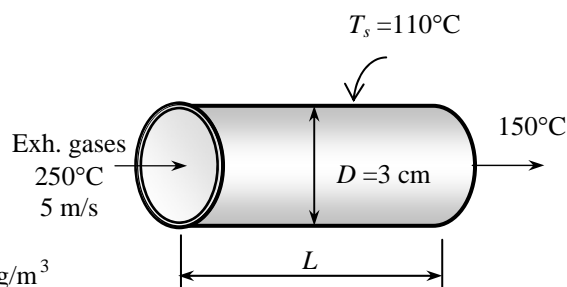

Laminar and Turbulent Flow in Tubes

8-26C The friction factor for flow in a tube is proportional to the pressure drop. Since the pressure drop along the flow is directly related to the power requirements of the pump to maintain flow, the friction factor is also proportional to the power requirements. The applicable relations are

$$\Delta P = f \frac{L}{D} \frac{\rho V^2}{2} \quad \text{and} \quad \dot{W}_{\text{pump}} = \frac{\dot{m} \Delta P}{\rho}$$

8-27C The shear stress at the center of a circular tube during fully developed laminar flow is zero since the shear stress is proportional to the velocity gradient, which is zero at the tube center.

8-28C Yes, the shear stress at the surface of a tube during fully developed turbulent flow is maximum since the shear stress is proportional to the velocity gradient, which is maximum at the tube surface.

8-29C In fully developed flow in a circular pipe with negligible entrance effects, if the length of the pipe is doubled, the pressure drop will also *double* (the pressure drop is proportional to length).

8-30C Yes, the volume flow rate in a circular pipe with laminar flow can be determined by measuring the velocity at the centerline in the fully developed region, multiplying it by the cross-sectional area, and dividing the result by 2 since $\dot{V} = V_{\text{avg}} A_c = (V_{\text{max}} / 2) A_c$.

8-31C No, the average velocity in a circular pipe in fully developed laminar flow **cannot** be determined by simply measuring the velocity at $R/2$ (midway between the wall surface and the centerline). The mean velocity is $V_{\text{max}}/2$, but the velocity at $R/2$ is

$$V(R/2) = V_{\text{max}} \left(1 - \frac{r^2}{R^2} \right)_{r=R/2} = \frac{3V_{\text{max}}}{4}$$

8-32C In fully developed laminar flow in a circular pipe, the pressure drop is given by

$$\Delta P = \frac{8\mu L V_{\text{avg}}}{R^2} = \frac{32\mu L V_{\text{avg}}}{D^2}$$

The mean velocity can be expressed in terms of the flow rate as $V_{\text{avg}} = \frac{\dot{V}}{A_c} = \frac{\dot{V}}{\pi D^2 / 4}$. Substituting,

$$\Delta P = \frac{8\mu L V_{\text{avg}}}{R^2} = \frac{32\mu L V_{\text{avg}}}{D^2} = \frac{32\mu L}{D^2} \frac{\dot{V}}{\pi D^2 / 4} = \frac{128\mu L \dot{V}}{\pi D^4}$$

Therefore, at constant flow rate and pipe length, the pressure drop is inversely proportional to the 4th power of diameter, and thus reducing the pipe diameter by half will increase the pressure drop **by a factor of 16**.

8-33C In fully developed laminar flow in a circular pipe, the pressure drop is given by

$$\Delta P = \frac{8\mu L V_{\text{avg}}}{R^2} = \frac{32\mu L V_{\text{avg}}}{D^2}$$

When the flow rate and thus mean velocity are held constant, the pressure drop becomes proportional to viscosity. Therefore, pressure drop will be **reduced by half** when the viscosity is reduced by half.

8-34C The tubes with rough surfaces have much higher heat transfer coefficients than the tubes with smooth surfaces. In the case of laminar flow, the effect of surface roughness on the heat transfer coefficient is negligible.

8-35 The flow rate through a specified water pipe is given. The pressure drop and the pumping power requirements are to be determined.

Assumptions 1 The flow is steady and incompressible. 2 The entrance effects are negligible, and thus the flow is fully developed. 3 The pipe involves no components such as bends, valves, and connectors. 4 The piping section involves no work devices such as pumps and turbines.

Properties The density and dynamic viscosity of water are given to be $\rho = 999.1 \text{ kg/m}^3$ and $\mu = 1.138 \times 10^{-3} \text{ kg/m}\cdot\text{s}$, respectively. The roughness of stainless steel is 0.002 mm (Table 8-3).

Analysis First, we calculate the mean velocity and the Reynolds number to determine the flow regime:

$$V_{\text{avg}} = \frac{\dot{V}}{A_c} = \frac{\dot{V}}{\pi D^2 / 4} = \frac{0.005 \text{ m}^3 / \text{s}}{\pi (0.04 \text{ m})^2 / 4} = 3.98 \text{ m/s}$$

$$\text{Re} = \frac{\rho V_{\text{avg}} D}{\mu} = \frac{(999.1 \text{ kg/m}^3)(3.98 \text{ m/s})(0.04 \text{ m})}{1.138 \times 10^{-3} \text{ kg/m}\cdot\text{s}} = 1.40 \times 10^5$$

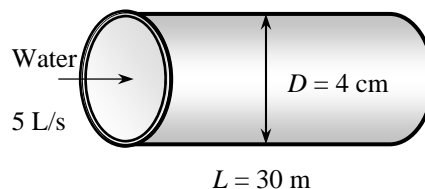

which is greater than 10,000. Therefore, the flow is turbulent. The relative roughness of the pipe is

$$\varepsilon / D = \frac{2 \times 10^{-6} \text{ m}}{0.04 \text{ m}} = 5 \times 10^{-5}$$

The friction factor can be determined from the Moody chart, but to avoid the reading error, we determine it from the Colebrook equation using an equation solver (or an iterative scheme),

$$\frac{1}{\sqrt{f}} = -2.0 \log \left(\frac{\varepsilon / D}{3.7} + \frac{2.51}{\text{Re} \sqrt{f}} \right) \rightarrow \frac{1}{\sqrt{f}} = -2.0 \log \left(\frac{5 \times 10^{-5}}{3.7} + \frac{2.51}{1.40 \times 10^5 \sqrt{f}} \right)$$

It gives $f = 0.0171$. Then the pressure drop and the required power input become

$$\Delta P = f \frac{L}{D} \frac{\rho V_{\text{avg}}^2}{2} = 0.0171 \frac{30 \text{ m}}{0.04 \text{ m}} \frac{(999.1 \text{ kg/m}^3)(3.98 \text{ m/s})^2}{2} \left(\frac{1 \text{ kN}}{1000 \text{ kg}\cdot\text{m/s}^2} \right) \left(\frac{1 \text{ kPa}}{1 \text{ kN/m}^2} \right) = 101.5 \text{ kPa}$$

$$\dot{W}_{\text{pump,u}} = \dot{V} \Delta P = (0.005 \text{ m}^3 / \text{s})(101.5 \text{ kPa}) \left(\frac{1 \text{ kW}}{1 \text{ kPa}\cdot\text{m}^3/\text{s}} \right) = \mathbf{0.508 \text{ kW}}$$

Therefore, useful power input in the amount of 0.508 kW is needed to overcome the frictional losses in the pipe.

Discussion The friction factor could also be determined easily from the explicit Haaland relation. It would give $f = 0.0169$, which is sufficiently close to 0.0171. Also, the friction factor corresponding to $\varepsilon = 0$ in this case is 0.0168, which indicates that stainless steel pipes can be assumed to be smooth with an error of about 2%. Also, the power input determined is the mechanical power that needs to be imparted to the fluid. The shaft power will be more than this due to pump inefficiency; the electrical power input will be even more due to motor inefficiency.

8-36 In fully developed laminar flow in a circular pipe, the velocity at $r = R/2$ is measured. The velocity at the center of the pipe ($r = 0$) is to be determined.

Assumptions The flow is steady, laminar, and fully developed.

Analysis The velocity profile in fully developed laminar flow in a circular pipe is given by

$$V(r) = V_{\max} \left(1 - \frac{r^2}{R^2} \right)$$

where V_{\max} is the maximum velocity which occurs at pipe center, $r = 0$. At $r = R/2$,

$$V(R/2) = V_{\max} \left(1 - \frac{(R/2)^2}{R^2} \right) = V_{\max} \left(1 - \frac{1}{4} \right) = \frac{3V_{\max}}{4}$$

Solving for V_{\max} and substituting,

$$V_{\max} = \frac{4V(R/2)}{3} = \frac{4(6 \text{ m/s})}{3} = \mathbf{8 \text{ m/s}}$$

which is the velocity at the pipe center.

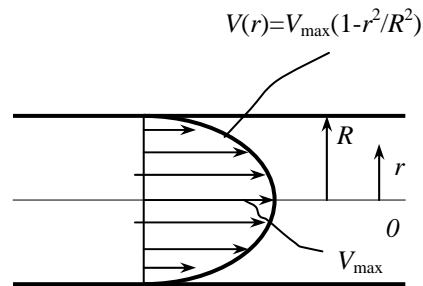

8-37 The velocity profile in fully developed laminar flow in a circular pipe is given. The mean and maximum velocities are to be determined.

Assumptions The flow is steady, laminar, and fully developed.

Analysis The velocity profile in fully developed laminar flow in a circular pipe is given by

$$V(r) = V_{\max} \left(1 - \frac{r^2}{R^2} \right)$$

The velocity profile in this case is given by

$$V(r) = 4(1 - r^2 / R^2)$$

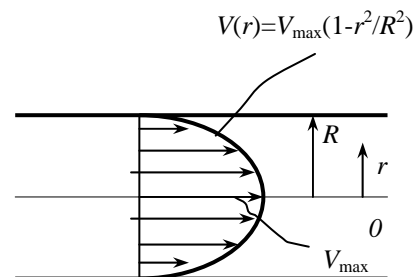

Comparing the two relations above gives the maximum velocity to be $V_{\max} = 4 \text{ m/s}$. Then the mean velocity and volume flow rate become

$$V_{\text{avg}} = \frac{V_{\max}}{2} = \frac{4 \text{ m/s}}{2} = \mathbf{2 \text{ m/s}}$$

$$\dot{V} = V_{\text{avg}} A_c = V_{\text{avg}} (\pi R^2) = (2 \text{ m/s}) [\pi (0.10 \text{ m})^2] = \mathbf{0.0628 \text{ m}^3/\text{s}}$$

8-38 The velocity profile in fully developed laminar flow in a circular pipe is given. The mean and maximum velocities are to be determined.

Assumptions The flow is steady, laminar, and fully developed.

Analysis The velocity profile in fully developed laminar flow in a circular pipe is given by

$$V(r) = V_{\max} \left(1 - \frac{r^2}{R^2} \right)$$

The velocity profile in this case is given by

$$V(r) = 4(1 - r^2 / R^2)$$

Comparing the two relations above gives the maximum velocity to be $V_{\max} = 4 \text{ m/s}$. Then the mean velocity and volume flow rate become

$$V_{\text{avg}} = \frac{V_{\max}}{2} = \frac{4 \text{ m/s}}{2} = \mathbf{2 \text{ m/s}}$$

$$\dot{V} = V_{\text{avg}} A_c = V_{\text{avg}} (\pi R^2) = (2 \text{ m/s}) [\pi (0.05 \text{ m})^2] = \mathbf{0.0157 \text{ m}^3/\text{s}}$$

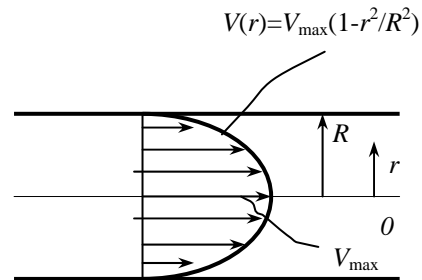

8-39 The convection heat transfer coefficients for the flow of air and water are to be determined under similar conditions.

Assumptions 1 Steady flow conditions exist. 2 The surface heat flux is uniform. 3 The inner surfaces of the tube are smooth.

Properties The properties of air at 25°C are (Table A-15)

$$k = 0.02551 \text{ W/m}\cdot\text{°C}$$

$$\nu = 1.562 \times 10^{-5} \text{ m}^2/\text{s}$$

$$\text{Pr} = 0.7296$$

The properties of water at 25°C are (Table A-9)

$$\rho = 997 \text{ kg/m}^3$$

$$k = 0.607 \text{ W/m}\cdot\text{°C}$$

$$\nu = \mu / \rho = 0.891 \times 10^{-3} / 997 = 8.937 \times 10^{-7} \text{ m}^2/\text{s}$$

$$\text{Pr} = 6.14$$

Analysis The Reynolds number is

$$\text{Re} = \frac{VD}{\nu} = \frac{(2 \text{ m/s})(0.08 \text{ m})}{1.562 \times 10^{-5} \text{ m}^2/\text{s}} = 10,243$$

which is greater than 10,000. Therefore, the flow is turbulent and the entry lengths in this case are roughly

$$L_h \approx L_t \approx 10D = 10(0.08 \text{ m}) = 0.8 \text{ m}$$

which is much shorter than the total length of the tube. Therefore, we can assume fully developed turbulent flow in the entire duct, and determine the Nusselt number from

$$\text{Nu} = \frac{hD}{k} = 0.023 \text{Re}^{0.8} \text{Pr}^{0.4} = 0.023(10,243)^{0.8} (0.7296)^{0.4} = 32.76$$

Heat transfer coefficient is

$$h = \frac{k}{D} \text{Nu} = \frac{0.02551 \text{ W/m}\cdot\text{°C}}{0.08 \text{ m}} (32.76) = \mathbf{10.45 \text{ W/m}^2\cdot\text{°C}}$$

Repeating calculations for water:

$$\text{Re} = \frac{VD}{\nu} = \frac{(2 \text{ m/s})(0.08 \text{ m})}{8.937 \times 10^{-7} \text{ m}^2/\text{s}} = 179,035$$

$$\text{Nu} = \frac{hD}{k} = 0.023 \text{Re}^{0.8} \text{Pr}^{0.4} = 0.023(179,035)^{0.8} (6.14)^{0.4} = 757.4$$

$$h = \frac{k}{D} \text{Nu} = \frac{0.607 \text{ W/m}\cdot\text{°C}}{0.08 \text{ m}} (757.4) = \mathbf{5747 \text{ W/m}^2\cdot\text{°C}}$$

Discussion The heat transfer coefficient for water is 550 times that of air.

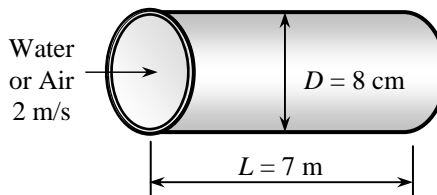

8-40 Air flows in a pipe whose inner surface is not smooth. The rate of heat transfer is to be determined using two different Nusselt number relations.

Assumptions 1 Steady operating conditions exist. 2 Air is an ideal gas with constant properties. 3 The pressure of air is 1 atm.

Properties Assuming a bulk mean fluid temperature of 20°C, the properties of air are (Table A-15)

$$\begin{aligned}\rho &= 1.204 \text{ kg/m}^3 \\ k &= 0.02514 \text{ W/m}\cdot\text{°C} \\ \nu &= 1.516 \times 10^{-5} \text{ m}^2/\text{s} \\ c_p &= 1007 \text{ J/kg}\cdot\text{°C} \\ \text{Pr} &= 0.7309\end{aligned}$$

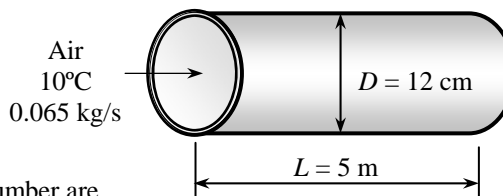

Analysis The mean velocity of air and the Reynolds number are

$$\begin{aligned}V_{\text{avg}} &= \frac{\dot{m}}{\rho A_c} = \frac{0.065 \text{ kg/s}}{(1.204 \text{ kg/m}^3)\pi(0.12 \text{ m})^2/4} = 4.773 \text{ m/s} \\ \text{Re} &= \frac{V_{\text{avg}} D}{\nu} = \frac{(4.773 \text{ m/s})(0.12 \text{ m})}{1.516 \times 10^{-5} \text{ m}^2/\text{s}} = 37,785\end{aligned}$$

which is greater than 10,000. Therefore, the flow is turbulent and the entry lengths in this case are roughly

$$L_h \approx L_t \approx 10D = 10(0.12 \text{ m}) = 1.2 \text{ m}$$

which is much shorter than the total length of the pipe. Therefore, we can assume fully developed turbulent flow in the entire duct. The friction factor may be determined from Colebrook equation using EES to be

$$\frac{1}{\sqrt{f}} = -2 \log \left(\frac{\varepsilon/D}{3.7} + \frac{2.51}{\text{Re} \sqrt{f}} \right) \longrightarrow \frac{1}{\sqrt{f}} = -2 \log \left(\frac{0.00022/0.12}{3.7} + \frac{2.51}{37,785 \sqrt{f}} \right) \longrightarrow f = 0.02695$$

The Nusselt number from Eq. 8-66 is

$$\text{Nu} = 0.125 f \text{Re} \text{Pr}^{1/3} = 0.125(0.02695)(37,785)(0.7309)^{1/3} = 114.7$$

Heat transfer coefficient is

$$h = \frac{k}{D} \text{Nu} = \frac{0.02514 \text{ W/m}\cdot\text{°C}}{0.12 \text{ m}} (114.7) = 24.02 \text{ W/m}^2\cdot\text{°C}$$

Next we determine the exit temperature of air

$$A = \pi DL = \pi(0.12 \text{ m})(5 \text{ m}) = 1.885 \text{ m}^2$$

$$T_e = T_s - (T_s - T_i) e^{-hA/(\dot{m}c_p)} = 50 - (50 - 10) e^{-\frac{(24.02)(1.885)}{(0.065)(1007)}} = 30.0\text{°C}$$

This result verifies our assumption of bulk mean fluid temperature that we used for property evaluation. Then the rate of heat transfer becomes

$$\dot{Q} = \dot{m}c_p(T_e - T_i) = (0.065 \text{ kg/s})(1007 \text{ J/kg}\cdot\text{°C})(30.0 - 10)\text{°C} = \mathbf{1307 \text{ W}}$$

Repeating the calculations using the Nusselt number from Eq. 8-70:

$$\text{Nu} = \frac{(f/8)(\text{Re} - 1000) \text{Pr}}{1 + 12.7(f/8)^{0.5}(\text{Pr}^{2/3} - 1)} = \frac{(0.02695/8)(37,785 - 1000)(0.7309)}{1 + 12.7(0.02695/8)^{0.5}(0.7309^{2/3} - 1)} = 105.2$$

$$h = \frac{k}{D} \text{Nu} = \frac{0.02514 \text{ W/m}\cdot\text{°C}}{0.12 \text{ m}} (105.2) = 22.04 \text{ W/m}^2\cdot\text{°C}$$

$$T_e = T_s - (T_s - T_i) e^{-hA/(\dot{m}c_p)} = 50 - (50 - 10) e^{-\frac{(22.04)(1.885)}{(0.065)(1007)}} = 28.8\text{°C}$$

$$\dot{Q} = \dot{m}c_p(T_e - T_i) = (0.065 \text{ kg/s})(1007 \text{ J/kg}\cdot\text{°C})(28.8 - 10)\text{°C} = \mathbf{1230 \text{ W}}$$

The result by Eq. 8-66 is about 6 percent greater than that by Eq. 8-70.

8-41 Air flows in a square cross section pipe. The rate of heat loss and the pressure difference between the inlet and outlet sections of the duct are to be determined.

Assumptions 1 Steady operating conditions exist. 2 Air is an ideal gas with constant properties. 3 The pressure of air is 1 atm.

Properties Taking a bulk mean fluid temperature of 80°C assuming that the air does not lose much heat to the attic, the properties of air are (Table A-15)

$$\begin{aligned}\rho &= 0.9994 \text{ kg/m}^3 \\ k &= 0.02953 \text{ W/m}\cdot\text{°C} \\ \nu &= 2.097 \times 10^{-5} \text{ m}^2/\text{s} \\ c_p &= 1008 \text{ J/kg}\cdot\text{°C} \\ \text{Pr} &= 0.7154\end{aligned}$$

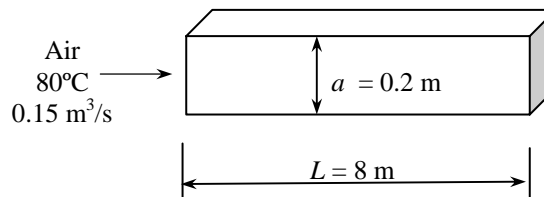

Analysis The mean velocity of air, the hydraulic diameter, and the Reynolds number are

$$\begin{aligned}V &= \frac{\dot{V}}{A} = \frac{0.15 \text{ m}^3/\text{s}}{(0.2 \text{ m})^2} = 3.75 \text{ m/s} \\ D_h &= \frac{4A}{P} = \frac{4a^2}{4a} = a = 0.2 \text{ m} \\ \text{Re} &= \frac{VD_h}{\nu} = \frac{(3.75 \text{ m/s})(0.2 \text{ m})}{2.097 \times 10^{-5}} = 35,765\end{aligned}$$

which is greater than 10,000. Therefore, the flow is turbulent and the entry lengths in this case are roughly

$$L_h \approx L_t \approx 10D_h = 10(0.2 \text{ m}) = 2 \text{ m}$$

which is much shorter than the total length of the pipe. Therefore, we can assume fully developed turbulent flow in the entire duct, and determine the Nusselt number from

$$\text{Nu} = \frac{hD_h}{k} = 0.023 \text{Re}^{0.8} \text{Pr}^{0.3} = 0.023(35,765)^{0.8} (0.7154)^{0.3} = 91.4$$

Heat transfer coefficient is

$$h = \frac{k}{D} \text{Nu} = \frac{0.02953 \text{ W/m}\cdot\text{°C}}{0.2 \text{ m}} (91.4) = 13.5 \text{ W/m}^2\cdot\text{°C}$$

Next we determine the exit temperature of air

$$A = 4aL = 4(0.2 \text{ m})(8 \text{ m}) = 6.4 \text{ m}^2$$

$$T_e = T_s - (T_s - T_i)e^{-\frac{hA}{\dot{m}c_p}} = 60 - (60 - 80)e^{-\frac{(13.5)(6.4)}{(0.9994)(0.15)(1008)}} = 71.3^\circ\text{C}$$

Then the rate of heat transfer becomes

$$\dot{Q} = \dot{m}c_p(T_e - T_i) = (0.9994 \text{ kg/m}^3)(0.15 \text{ m}^3/\text{s})(1008 \text{ J/kg}\cdot\text{°C})(80 - 71.3)^\circ\text{C} = \mathbf{1315 \text{ W}}$$

From Moody chart:

$$\text{Re} = 35,765 \text{ and } \varepsilon/D = 0.001 \rightarrow f = 0.026$$

Then the pressure drop is determined to be

$$\Delta P = f \frac{\rho V^2}{2D} L = (0.026) \frac{(0.9994 \text{ kg/m}^3)(3.75 \text{ m/s})^2}{2(0.2 \text{ m})} (8 \text{ m}) = \mathbf{7.3 \text{ Pa}}$$

8-42 A liquid is heated as it flows in a pipe that is wrapped by electric resistance heaters. The required surface heat flux, the surface temperature at the exit, and the pressure loss through the pipe and the minimum power required to overcome the resistance to flow are to be determined.

Assumptions **1** Steady flow conditions exist. **2** The surface heat flux is uniform. **3** The inner surfaces of the tube are smooth. **4** Heat transfer to the surroundings is negligible.

Properties The properties of the fluid are given to be $\rho = 1000 \text{ kg/m}^3$, $c_p = 4000 \text{ J/kg}\cdot\text{K}$, $\mu = 2 \times 10^{-3} \text{ kg/s}\cdot\text{m}$, $k = 0.48 \text{ W/m}\cdot\text{K}$, and $\text{Pr} = 10$

Analysis (a) The mass flow rate of the liquid is

$$\dot{m} = \rho AV = (1000 \text{ kg/m}^3) \left(\pi (0.01 \text{ m})^2 / 4 \right) (0.8 \text{ m/s}) = 0.0628 \text{ kg/s}$$

The rate of heat transfer and the heat flux are

$$\dot{Q} = \dot{m} c_p (T_e - T_i) = (0.0628 \text{ kg/s})(4000 \text{ J/kg}\cdot^\circ\text{C})(75 - 25)^\circ\text{C} = 12,560 \text{ W}$$

$$\dot{q} = \frac{\dot{Q}}{A_s} = \frac{12,560 \text{ W}}{\pi (0.01 \text{ m})(10 \text{ m})} = \mathbf{40,000 \text{ W/m}^2}$$

(b) The Reynolds number is

$$\text{Re} = \frac{\rho V D}{\mu} = \frac{(1000 \text{ kg/m}^3)(0.8 \text{ m/s})(0.01 \text{ m})}{0.002 \text{ kg/m}\cdot\text{s}} = 4000$$

which is greater than 2300 and smaller than 10,000. Therefore, we have transitional flow. However, we use turbulent flow relation. The entry lengths in this case are roughly

$$L_h \approx L_t \approx 10D = 10(0.01 \text{ m}) = 0.1 \text{ m}$$

which is much shorter than the total length of the tube. Therefore, we can assume fully developed turbulent flow in the entire duct, and determine the Nusselt number from

$$\text{Nu} = \frac{hD}{k} = 0.023 \text{Re}^{0.8} \text{Pr}^{0.4} = 0.023(4000)^{0.8} (10)^{0.4} = 44$$

Heat transfer coefficient is

$$h = \frac{k}{D} \text{Nu} = \frac{0.48 \text{ W/m}\cdot^\circ\text{C}}{0.01 \text{ m}} (44) = 2112 \text{ W/m}^2 \cdot ^\circ\text{C}$$

The surface temperature at the exit is

$$\dot{q} = h(T_s - T_e) \longrightarrow 40,000 \text{ W} = (2112 \text{ W/m}^2 \cdot ^\circ\text{C})(T_s - 75)^\circ\text{C} \longrightarrow T_s = \mathbf{93.9^\circ\text{C}}$$

(c) From Moody chart:

$$\text{Re} = 4000, \varepsilon = 0.046 \text{ mm}, \varepsilon/D = 0.045/10 = 0.0045 \rightarrow f = 0.044$$

Then the pressure drop and the minimum power required to overcome this pressure drop are determined to be

$$\Delta P = f \frac{\rho V^2}{2D} L = (0.044) \frac{(1000 \text{ kg/m}^3)(0.8 \text{ m/s})^2}{2(0.01 \text{ m})} (10 \text{ m}) = \mathbf{14,080 \text{ Pa}}$$

$$\dot{W} = \dot{V} \Delta P = \left(\pi (0.01 \text{ m})^2 / 4 \right) (0.8 \text{ m/s})(14,080 \text{ Pa}) = \mathbf{0.88 \text{ W}}$$

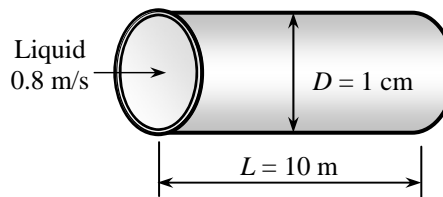

8-43 The average flow velocity in a pipe is given. The pressure drop and the pumping power are to be determined.

Assumptions **1** The flow is steady and incompressible. **2** The entrance effects are negligible, and thus the flow is fully developed. **3** The pipe involves no components such as bends, valves, and connectors. **4** The piping section involves no work devices such as pumps and turbines.

Properties The density and dynamic viscosity of water are given to be $\rho = 999.7 \text{ kg/m}^3$ and $\mu = 1.307 \times 10^{-3} \text{ kg/m}\cdot\text{s}$, respectively.

Analysis (a) First we need to determine the flow regime. The Reynolds number of the flow is

$$\text{Re} = \frac{\rho V_{\text{avg}} D}{\mu} = \frac{(999.7 \text{ kg/m}^3)(1.2 \text{ m/s})(2 \times 10^{-3} \text{ m})}{1.307 \times 10^{-3} \text{ kg/m}\cdot\text{s}} = 1836$$

which is less than 2300. Therefore, the flow is laminar. Then the friction factor and the pressure drop become

$$f = \frac{64}{\text{Re}} = \frac{64}{1836} = 0.0349$$

$$\Delta P = f \frac{L}{D} \frac{\rho V_{\text{avg}}^2}{2} = 0.0349 \frac{15 \text{ m}}{0.002 \text{ m}} \frac{(999.7 \text{ kg/m}^3)(1.2 \text{ m/s})^2}{2} \left(\frac{1 \text{ kN}}{1000 \text{ kg}\cdot\text{m/s}^2} \right) \left(\frac{1 \text{ kPa}}{1 \text{ kN/m}^2} \right) = \mathbf{188 \text{ kPa}}$$

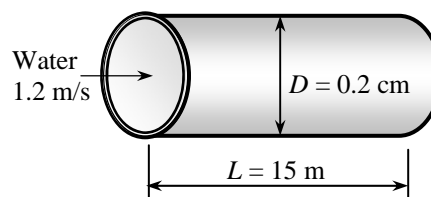

(b) The volume flow rate and the pumping power requirements are

$$\dot{V} = V_{\text{avg}} A_c = V_{\text{avg}} (\pi D^2 / 4) = (1.2 \text{ m/s}) [\pi (0.002 \text{ m})^2 / 4] = 3.77 \times 10^{-6} \text{ m}^3 / \text{s}$$

$$\dot{W}_{\text{pump}} = \dot{V} \Delta P = (3.77 \times 10^{-6} \text{ m}^3 / \text{s})(188 \text{ kPa}) \left(\frac{1000 \text{ W}}{1 \text{ kPa}\cdot\text{m}^3/\text{s}} \right) = \mathbf{0.71 \text{ W}}$$

Therefore, power input in the amount of 0.71 W is needed to overcome the frictional losses in the flow due to viscosity.

8-44 Water is to be heated in a tube equipped with an electric resistance heater on its surface. The power rating of the heater and the inner surface temperature are to be determined.

Assumptions 1 Steady flow conditions exist. 2 The surface heat flux is uniform. 3 The inner surfaces of the tube are smooth.

Properties The properties of water at the average temperature of $(80+10)/2 = 45^\circ\text{C}$ are (Table A-9)

$$\begin{aligned}\rho &= 990.1 \text{ kg/m}^3 \\ k &= 0.637 \text{ W/m}\cdot^\circ\text{C} \\ \nu &= \mu / \rho = 0.602 \times 10^{-6} \text{ m}^2/\text{s} \\ c_p &= 4180 \text{ J/kg}\cdot^\circ\text{C} \\ \text{Pr} &= 3.91\end{aligned}$$

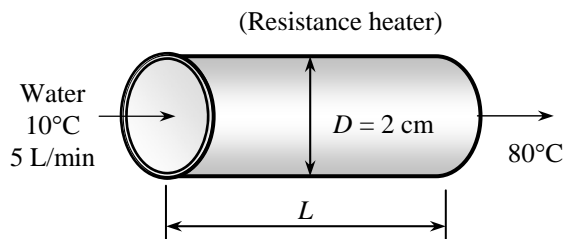

Analysis The power rating of the resistance heater is

$$\begin{aligned}\dot{m} &= \rho \dot{V} = (990.1 \text{ kg/m}^3)(0.005 \text{ m}^3/\text{min}) = 4.951 \text{ kg/min} = 0.0825 \text{ kg/s} \\ \dot{Q} &= \dot{m} c_p (T_e - T_i) = (0.0825 \text{ kg/s})(4180 \text{ J/kg}\cdot^\circ\text{C})(80 - 10)^\circ\text{C} = \mathbf{24,140 \text{ W}}\end{aligned}$$

The velocity of water and the Reynolds number are

$$\begin{aligned}V_{\text{avg}} &= \frac{\dot{V}}{A_c} = \frac{(5 \times 10^{-3} / 60) \text{ m}^3/\text{s}}{\pi(0.02 \text{ m})^2 / 4} = 0.2653 \text{ m/s} \\ \text{Re} &= \frac{V_{\text{avg}} D_h}{\nu} = \frac{(0.2653 \text{ m/s})(0.02 \text{ m})}{0.602 \times 10^{-6} \text{ m}^2/\text{s}} = 8813\end{aligned}$$

which is less than 10,000 but much greater than 2300. We assume the flow to be turbulent. The entry lengths in this case are roughly

$$L_h \approx L_t \approx 10D = 10(0.02 \text{ m}) = 0.20 \text{ m}$$

which is much shorter than the total length of the duct. Therefore, we can assume fully developed turbulent flow in the entire duct, and determine the Nusselt number from

$$Nu = \frac{hD_h}{k} = 0.023 \text{Re}^{0.8} \text{Pr}^{0.4} = 0.023(8813)^{0.8} (3.91)^{0.4} = 56.85$$

Heat transfer coefficient is

$$h = \frac{k}{D_h} Nu = \frac{0.637 \text{ W/m}\cdot^\circ\text{C}}{0.02 \text{ m}} (56.85) = 1811 \text{ W/m}^2\cdot^\circ\text{C}$$

Then the inner surface temperature of the pipe at the exit becomes

$$\begin{aligned}\dot{Q} &= hA_s (T_{s,e} - T_e) \\ 24,140 \text{ W} &= (1811 \text{ W/m}^2\cdot^\circ\text{C})[\pi(0.02 \text{ m})(13 \text{ m})](T_s - 80)^\circ\text{C} \\ T_{s,e} &= \mathbf{96.3^\circ\text{C}}\end{aligned}$$

8-45 Flow of hot air through uninsulated square ducts of a heating system in the attic is considered. The exit temperature and the rate of heat loss are to be determined.

Assumptions 1 Steady operating conditions exist. 2 The inner surfaces of the duct are smooth. 3 Air is an ideal gas with constant properties. 4 The pressure of air is 1 atm.

Properties We assume the bulk mean temperature for air to be 80°C since the mean temperature of air at the inlet will drop somewhat as a result of heat loss through the duct whose surface is at a lower temperature. The properties of air at 1 atm and this temperature are (Table A-15)

$$\begin{aligned}\rho &= 0.9994 \text{ kg/m}^3 \\ k &= 0.02953 \text{ W/m}\cdot^\circ\text{C} \\ \nu &= 2.097 \times 10^{-5} \text{ m}^2/\text{s} \\ c_p &= 1008 \text{ J/kg}\cdot^\circ\text{C} \\ \text{Pr} &= 0.7154\end{aligned}$$

Analysis The characteristic length that is the hydraulic diameter, the mean velocity of air, and the Reynolds number are

$$\begin{aligned}D_h &= \frac{4A_c}{P} = \frac{4a^2}{4a} = a = 0.15 \text{ m} \\ V_{\text{avg}} &= \frac{\dot{V}}{A_c} = \frac{0.10 \text{ m}^3/\text{s}}{(0.15 \text{ m})^2} = 4.444 \text{ m/s} \\ \text{Re} &= \frac{V_{\text{avg}} D_h}{\nu} = \frac{(4.444 \text{ m/s})(0.15 \text{ m})}{2.097 \times 10^{-5} \text{ m}^2/\text{s}} = 31,791\end{aligned}$$

which is greater than 10,000. Therefore, the flow is turbulent and the entry lengths in this case are roughly

$$L_h \approx L_t \approx 10D_h = 10(0.15 \text{ m}) = 1.5 \text{ m}$$

which is much shorter than the total length of the duct. Therefore, we can assume fully developed turbulent flow in the entire duct, and determine the Nusselt number from

$$Nu = \frac{hD_h}{k} = 0.023 \text{Re}^{0.8} \text{Pr}^{0.3} = 0.023(31,791)^{0.8} (0.7154)^{0.3} = 83.16$$

Heat transfer coefficient is

$$h = \frac{k}{D_h} Nu = \frac{0.02953 \text{ W/m}\cdot^\circ\text{C}}{0.15 \text{ m}} (83.16) = 16.37 \text{ W/m}^2\cdot^\circ\text{C}$$

Next we determine the exit temperature of air,

$$\begin{aligned}A_s &= 4aL = 4(0.15 \text{ m})(10 \text{ m}) = 6 \text{ m}^2 \\ \dot{m} &= \rho \dot{V} = (0.9994 \text{ kg/m}^3)(0.10 \text{ m}^3/\text{s}) = 0.09994 \text{ kg/s} \\ T_e &= T_s - (T_s - T_i) e^{-hA_s/(\dot{m}c_p)} = 70 - (70 - 85) e^{-\frac{(16.37)(6)}{(0.9994)(1008)}} = \mathbf{75.7^\circ\text{C}}\end{aligned}$$

Then the logarithmic mean temperature difference and the rate of heat loss from the air becomes

$$\begin{aligned}\Delta T_{\text{ln}} &= \frac{T_e - T_i}{\ln\left(\frac{T_s - T_e}{T_s - T_i}\right)} = \frac{75.7 - 85}{\ln\left(\frac{70 - 75.7}{70 - 85}\right)} = 9.58^\circ\text{C} \\ \dot{Q} &= hA_s \Delta T_{\text{ln}} = (16.37 \text{ W/m}^2\cdot^\circ\text{C})(6 \text{ m}^2)(9.58^\circ\text{C}) = \mathbf{941 \text{ W}}\end{aligned}$$

Note that the temperature of air drops by almost 10°C as it flows in the duct as a result of heat loss.

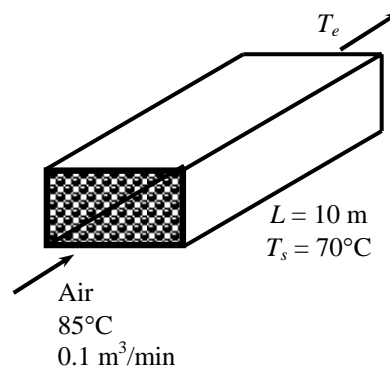

8-46 EES Prob. 8-45 is reconsidered. The effect of the volume flow rate of air on the exit temperature of air and the rate of heat loss is to be investigated.

Analysis The problem is solved using EES, and the solution is given below.

"GIVEN"

T_i=85 [C]
L=10 [m]
side=0.15 [m]
V_dot=0.10 [m^3/s]
T_s=70 [C]

"PROPERTIES"

Fluid\$='air'
C_p=CP(Fluid\$, T=T_ave)*Convert(kJ/kg-C, J/kg-C)
k=Conductivity(Fluid\$, T=T_ave)
Pr=Prandtl(Fluid\$, T=T_ave)
rho=Density(Fluid\$, T=T_ave, P=101.3)
mu=Viscosity(Fluid\$, T=T_ave)
nu=mu/rho
T_ave=1/2*(T_i+T_e)

"ANALYSIS"

D_h=(4*A_c)/p
A_c=side^2
p=4*side
Vel=V_dot/A_c
Re=(Vel*D_h)/nu "The flow is turbulent"
L_t=10*D_h "The entry length is much shorter than the total length of the duct."
Nusselt=0.023*Re^0.8*Pr^0.3
h=k/D_h*Nusselt
A=4*side*L
m_dot=rho*V_dot
T_e=T_s-(T_s-T_i)*exp((-h*A)/(m_dot*C_p))
DELTA_T_In=(T_e-T_i)/ln((T_s-T_e)/(T_s-T_i))
Q_dot=h*A*DELTA_T_In

V [m ³ /s]	T _e [C]	Q [W]
0.05	74.89	509
0.055	75	554.1
0.06	75.09	598.6
0.065	75.18	642.7
0.07	75.26	686.3
0.075	75.34	729.5
0.08	75.41	772.4
0.085	75.48	814.8
0.09	75.54	857
0.095	75.6	898.9
0.1	75.66	940.4
0.105	75.71	981.7
0.11	75.76	1023
0.115	75.81	1063
0.12	75.86	1104

0.125	75.9	1144
0.13	75.94	1184
0.135	75.98	1224
0.14	76.02	1264
0.145	76.06	1303
0.15	76.1	1343

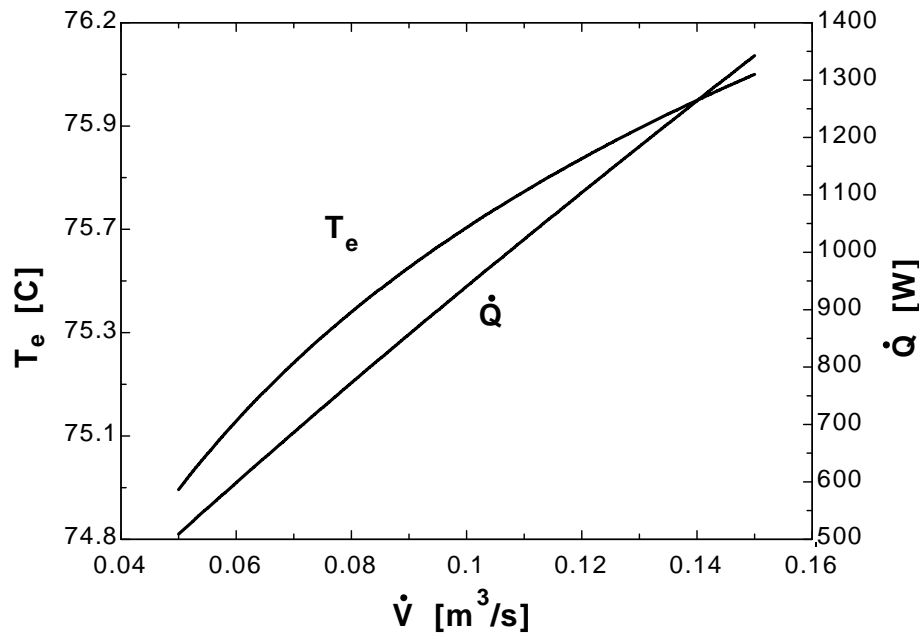

8-47 Air enters the constant spacing between the glass cover and the plate of a solar collector. The net rate of heat transfer and the temperature rise of air are to be determined.

Assumptions 1 Steady operating conditions exist. **2** The inner surfaces of the spacing are smooth. **3** Air is an ideal gas with constant properties. **4** The local atmospheric pressure is 1 atm.

Properties The properties of air at 1 atm and estimated average temperature of 35°C are (Table A-15)

$$\rho = 1.145 \text{ kg/m}^3, \quad k = 0.02625 \text{ W/m} \cdot ^\circ\text{C}$$

$$\nu = 1.655 \times 10^{-5} \text{ m}^2/\text{s}, \quad c_p = 1007 \text{ J/kg} \cdot ^\circ\text{C}, \quad \text{Pr} = 0.7268$$

Analysis Mass flow rate, cross sectional area, hydraulic diameter, mean velocity of air and the Reynolds number are

$$\dot{m} = \rho \dot{V} = (1.145 \text{ kg/m}^3)(0.15 \text{ m}^3/\text{s}) = 0.1718 \text{ kg/s}$$

$$A_c = (1 \text{ m})(0.03 \text{ m}) = 0.03 \text{ m}^2$$

$$D_h = \frac{4A_c}{P} = \frac{4(0.03 \text{ m}^2)}{2(1 \text{ m} + 0.03 \text{ m})} = 0.05825 \text{ m}$$

$$V_{\text{avg}} = \frac{\dot{V}}{A_c} = \frac{0.15 \text{ m}^3/\text{s}}{0.03 \text{ m}^2} = 5 \text{ m/s}$$

$$\text{Re} = \frac{V_{\text{avg}} D_h}{\nu} = \frac{(5 \text{ m/s})(0.05825 \text{ m})}{1.655 \times 10^{-5} \text{ m}^2/\text{s}} = 17,600$$

which is greater than 10,000. Therefore, the flow is turbulent and the entry lengths in this case are roughly

$$L_h \approx L_t \approx 10D_h = 10(0.05825 \text{ m}) = 0.5825 \text{ m}$$

which are much shorter than the total length of the collector. Therefore, we can assume fully developed turbulent flow in the entire collector, and determine the Nusselt number from

$$\text{Nu} = \frac{hD_h}{k} = 0.023 \text{Re}^{0.8} \text{Pr}^{0.4} = 0.023(17,600)^{0.8} (0.7268)^{0.4} = 50.43$$

and
$$h = \frac{k}{D_h} \text{Nu} = \frac{0.02625 \text{ W/m} \cdot ^\circ\text{C}}{0.05825 \text{ m}} (50.43) = 22.73 \text{ W/m}^2 \cdot ^\circ\text{C}$$

The exit temperature of air can be calculated using the “average” surface temperature as

$$A_s = 2(5 \text{ m})(1 \text{ m}) = 10 \text{ m}^2, \quad T_{s,\text{avg}} = \frac{60 + 20}{2} = 40^\circ\text{C}$$

$$T_e = T_{s,\text{avg}} - (T_{s,\text{avg}} - T_i) \exp\left(-\frac{hA_s}{\dot{m}c_p}\right) = 40 - (40 - 30) \exp\left(-\frac{22.73 \times 10}{0.1718 \times 1007}\right) = 37.31^\circ\text{C}$$

The temperature rise of air is

$$\Delta T = 37.3^\circ\text{C} - 30^\circ\text{C} = \mathbf{7.3^\circ\text{C}}$$

The logarithmic mean temperature difference and the heat loss from the glass are

$$\Delta T_{\ln, \text{glass}} = \frac{T_e - T_i}{\ln \frac{T_s - T_e}{T_s - T_i}} = \frac{37.31 - 30}{\ln \frac{20 - 37.31}{20 - 30}} = 13.32^\circ\text{C}$$

$$\dot{Q}_{\text{glass}} = hA_s \Delta T_{\ln} = (22.73 \text{ W/m}^2 \cdot ^\circ\text{C})(5 \text{ m}^2)(13.32^\circ\text{C}) = 1514 \text{ W}$$

The logarithmic mean temperature difference and the heat gain of the absorber are

$$\Delta T_{\ln, \text{absorber}} = \frac{T_e - T_i}{\ln \frac{T_s - T_e}{T_s - T_i}} = \frac{37.31 - 30}{\ln \frac{60 - 37.31}{60 - 30}} = 26.17^\circ\text{C}$$

$$\dot{Q}_{\text{absorber}} = hA \Delta T_{\ln} = (22.73 \text{ W/m}^2 \cdot ^\circ\text{C})(5 \text{ m}^2)(26.17^\circ\text{C}) = 2975 \text{ W}$$

Then the net rate of heat transfer becomes

$$\dot{Q}_{\text{net}} = 2975 - 1514 = \mathbf{1461 \text{ W}}$$

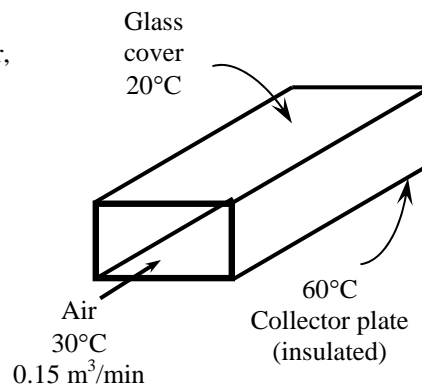

8-48 Oil flows through a pipeline that passes through icy waters of a lake. The exit temperature of the oil and the rate of heat loss are to be determined.

Assumptions 1 Steady operating conditions exist. 2 The surface temperature of the pipe is very nearly 0°C. 3 The thermal resistance of the pipe is negligible. 4 The inner surfaces of the pipeline are smooth. 5 The flow is hydrodynamically developed when the pipeline reaches the lake.

Properties The properties of oil at 10°C are (Table A-13)

$$\begin{aligned}\rho &= 893.6 \text{ kg/m}^3, & k &= 0.1460 \text{ W/m}\cdot\text{°C} \\ \mu &= 2.326 \text{ kg/m}\cdot\text{s}, & \nu &= 2.592 \times 10^{-3} \text{ m}^2/\text{s} \\ c_p &= 1839 \text{ J/kg}\cdot\text{°C}, & \text{Pr} &= 28,750\end{aligned}$$

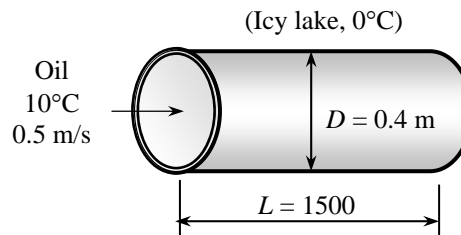

Analysis (a) The Reynolds number in this case is

$$\text{Re} = \frac{V_{\text{avg}} D_h}{\nu} = \frac{(0.5 \text{ m/s})(0.4 \text{ m})}{2.592 \times 10^{-3} \text{ m}^2/\text{s}} = 77.16$$

which is less than 2300. Therefore, the flow is laminar, and the thermal entry length is roughly

$$L_t = 0.05 \text{ Re Pr } D = 0.05(77.16)(28,750)(0.4 \text{ m}) = 44,367 \text{ m}$$

which is much longer than the total length of the pipe. Therefore, we assume thermally developing flow, and determine the Nusselt number from

$$\text{Nu} = \frac{hD}{k} = 3.66 + \frac{0.065(D/L) \text{ Re Pr}}{1 + 0.04[(D/L) \text{ Re Pr}]^{2/3}} = 3.66 + \frac{0.065\left(\frac{0.4 \text{ m}}{1500 \text{ m}}\right)(77.16)(28,750)}{1 + 0.04\left[\left(\frac{0.4 \text{ m}}{1500 \text{ m}}\right)(77.16)(28,750)\right]^{2/3}} = 13.73$$

$$\text{and } h = \frac{k}{D} \text{Nu} = \frac{0.1460 \text{ W/m}\cdot\text{°C}}{0.4 \text{ m}}(13.73) = 5.011 \text{ W/m}^2\cdot\text{°C}$$

Next we determine the exit temperature of oil

$$A_s = \pi DL = \pi(0.4 \text{ m})(1500 \text{ m}) = 1885 \text{ m}^2$$

$$\dot{m} = \rho \dot{V} = \rho A_c V_{\text{avg}} = \rho \left(\frac{\pi D^2}{4}\right) V_{\text{avg}} = (893.6 \text{ kg/m}^3) \frac{\pi(0.4 \text{ m})^2}{4} (0.5 \text{ m/s}) = 56.15 \text{ kg/s}$$

$$T_e = T_s - (T_s - T_i) e^{-hA_s/(\dot{m}c_p)} = 0 - (0 - 10) e^{-\frac{(5.011)(1885)}{(56.15)(1839)}} = \mathbf{9.13 \text{ °C}}$$

(b) The logarithmic mean temperature difference and the rate of heat loss from the oil are

$$\Delta T_{\text{ln}} = \frac{T_e - T_i}{\ln\left(\frac{T_s - T_e}{T_s - T_i}\right)} = \frac{9.13 - 10}{\ln\left(\frac{0 - 9.13}{0 - 10}\right)} = 9.56 \text{ °C}$$

$$\dot{Q} = hA_s \Delta T_{\text{ln}} = (5.011 \text{ W/m}^2\cdot\text{°C})(1885 \text{ m}^2)(9.56 \text{ °C}) = 90,300 \text{ W} = \mathbf{90.3 \text{ kW}}$$

The friction factor is

$$f = \frac{64}{\text{Re}} = \frac{64}{77.16} = 0.8294$$

Then the pressure drop in the pipe and the required pumping power become

$$\Delta P = f \frac{L}{D} \frac{\rho V_{\text{avg}}^2}{2} = 0.8294 \frac{1500 \text{ m}}{0.4 \text{ m}} \frac{(893.6 \text{ kg/m}^3)(0.5 \text{ m/s})^2}{2} \left(\frac{1 \text{ kN}}{1000 \text{ kg}\cdot\text{m/s}^2}\right) \left(\frac{1 \text{ kPa}}{1 \text{ kN/m}^2}\right) = 347.4 \text{ kPa}$$

$$\dot{W}_{\text{pump,u}} = \dot{V} \Delta P = A_c V_{\text{avg}} \Delta P = \frac{\pi(0.4 \text{ m})^2}{4} (0.5 \text{ m/s})(347.4 \text{ kPa}) \left(\frac{1 \text{ kW}}{1 \text{ kPa}\cdot\text{m}^3/\text{s}}\right) = \mathbf{21.8 \text{ kW}}$$

Discussion The power input determined is the mechanical power that needs to be imparted to the fluid. The shaft power will be much more than this due to pump inefficiency; the electrical power input will be even more due to motor inefficiency.

8-49 Laminar flow of a fluid through an isothermal square channel is considered. The change in the pressure drop and the rate of heat transfer are to be determined when the mean velocity is doubled.

Assumptions 1 The flow is fully developed. **2** The effect of the change in ΔT_{in} on the rate of heat transfer is not considered.

Analysis The pressure drop of the fluid for laminar flow is expressed as

$$\Delta P_1 = f \frac{L}{D} \frac{\rho V_{\text{avg}}^2}{2} = \frac{64}{\text{Re}} \frac{L}{D} \frac{\rho V_{\text{avg}}^2}{2} = \frac{64\nu}{V_{\text{avg}} D} \frac{L}{D} \frac{\rho V_{\text{avg}}^2}{2} = 32 V_{\text{avg}} \frac{\nu L \rho}{D^2}$$

When the free-stream velocity of the fluid is doubled, the pressure drop becomes

$$\Delta P_2 = f \frac{L}{D} \frac{\rho (2V_{\text{avg}})^2}{2} = \frac{64}{\text{Re}} \frac{L}{D} \frac{\rho 4V_{\text{avg}}^2}{2} = \frac{64\nu}{2V_{\text{avg}} D} \frac{L}{D} \frac{\rho 4V_{\text{avg}}^2}{2} = 64 V_{\text{avg}} \frac{\nu L \rho}{D^2}$$

Their ratio is

$$\frac{\Delta P_2}{\Delta P_1} = \frac{64}{32} = \mathbf{2}$$

The rate of heat transfer between the fluid and the walls of the channel is expressed as

$$\dot{Q}_1 = h A_s \Delta T_{\text{in}} = \frac{k}{D} \text{Nu} A_s \Delta T_{\text{in}} = \frac{k}{D} 2.98 A_s \Delta T_{\text{in}}$$

When the effect of the change in ΔT_{in} on the rate of heat transfer is disregarded, the rate of heat transfer remains the same. Therefore,

$$\frac{\dot{Q}_2}{\dot{Q}_1} = \mathbf{1}$$

Therefore, doubling the velocity will double the pressure drop but it will not affect the heat transfer rate.

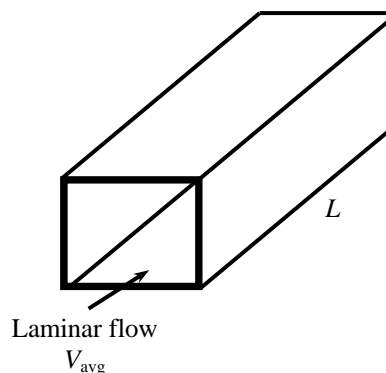

8-50 Turbulent flow of a fluid through an isothermal square channel is considered. The change in the pressure drop and the rate of heat transfer are to be determined when the free-stream velocity is doubled.

Assumptions 1 The flow is fully developed. **2** The effect of the change in ΔT_{in} on the rate of heat transfer is not considered.

Analysis The pressure drop of the fluid for turbulent flow is expressed as

$$\Delta P_1 = f \frac{L}{D} \frac{\rho V_{\text{avg}}^2}{2} = 0.184 \text{Re}^{-0.2} \frac{L}{D} \frac{\rho V_{\text{avg}}^2}{2} = 0.184 \frac{V_{\text{avg}}^{-0.2} D^{-0.2}}{\nu^{-0.2}} \frac{L}{D} \frac{\rho V_{\text{avg}}^2}{2} = 0.092 V_{\text{avg}}^{1.8} \left(\frac{D}{\nu}\right)^{-0.2} \frac{L\rho}{D}$$

When the free-stream velocity of the fluid is doubled, the pressure drop becomes

$$\begin{aligned} \Delta P_2 &= f \frac{L}{D} \frac{\rho (2V_{\text{avg}})^2}{2} = 0.184 \text{Re}^{-0.2} \frac{L}{D} \frac{\rho 4V_{\text{avg}}^2}{2} = 0.184 \frac{(2V_{\text{avg}})^{-0.2} D^{-0.2}}{\nu^{-0.2}} \frac{L}{D} \frac{\rho 4V_{\text{avg}}^2}{2} \\ &= 0.368(2)^{-0.2} V_{\text{avg}}^{1.8} \left(\frac{D}{\nu}\right)^{-0.2} \frac{L\rho}{D} \end{aligned}$$

Their ratio is

$$\frac{\Delta P_2}{\Delta P_1} = \frac{0.368(2)^{-0.2} V_{\text{avg}}^{1.8}}{0.092 V_{\text{avg}}^{1.8}} = 4(2)^{-0.2} = \mathbf{3.48}$$

The rate of heat transfer between the fluid and the walls of the channel is expressed as

$$\begin{aligned} \dot{Q}_1 &= hA\Delta T_{\text{in}} = \frac{k}{D} NuA\Delta T_{\text{in}} = \frac{k}{D} 0.023 \text{Re}^{0.8} \text{Pr}^{1/3} A\Delta T_{\text{in}} \\ &= 0.023 V_{\text{avg}}^{0.8} \left(\frac{D}{\nu}\right)^{0.8} \frac{k}{D} \text{Pr}^{1/3} A\Delta T_{\text{in}} \end{aligned}$$

When the free-stream velocity of the fluid is doubled, the heat transfer rate becomes

$$\dot{Q}_2 = 0.023(2V_{\text{avg}})^{0.8} \left(\frac{D}{\nu}\right)^{0.8} \frac{k}{D} \text{Pr}^{1/3} A\Delta T_{\text{in}}$$

Their ratio is

$$\frac{\dot{Q}_2}{\dot{Q}_1} = \frac{(2V_{\text{avg}})^{0.8}}{V_{\text{avg}}^{0.8}} = 2^{0.8} = \mathbf{1.74}$$

Therefore, doubling the velocity will increase the pressure drop 3.8 times but it will increase the heat transfer rate by only 74%.

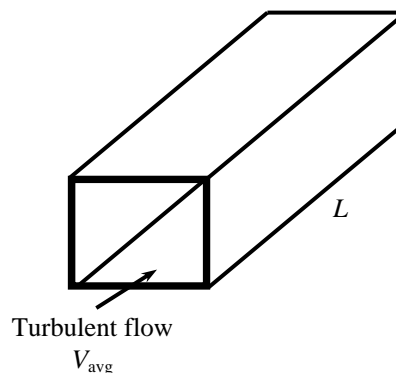

8-51E Water is heated in a parabolic solar collector. The required length of parabolic collector and the surface temperature of the collector tube are to be determined.

Assumptions 1 Steady operating conditions exist. 2 The thermal resistance of the tube is negligible. 3 The inner surfaces of the tube are smooth.

Properties The properties of water at the average temperature of $(55+200)/2 = 127.5^\circ\text{F}$ are (Table A-9E)

$$\begin{aligned}\rho &= 61.59 \text{ lbm/ft}^3 \\ k &= 0.374 \text{ Btu/ft}\cdot^\circ\text{F} \\ \nu &= \mu / \rho = 0.5681 \times 10^{-5} \text{ ft}^2/\text{s} \\ c_p &= 0.999 \text{ Btu/lbm}\cdot^\circ\text{F} \\ \text{Pr} &= 3.368\end{aligned}$$

Analysis The total rate of heat transfer is

$$\dot{Q} = \dot{m}c_p(T_e - T_i) = (4 \text{ lbm/s})(0.999 \text{ Btu/lbm}\cdot^\circ\text{F})(200 - 55)^\circ\text{F} = 579.4 \text{ Btu/s} = 2.086 \times 10^6 \text{ Btu/h}$$

The length of the tube required is

$$L = \frac{\dot{Q}_{total}}{\dot{Q}} = \frac{2.086 \times 10^6 \text{ Btu/h}}{350 \text{ Btu/h}\cdot\text{ft}} = \mathbf{5960 \text{ ft}}$$

The velocity of water and the Reynolds number are

$$V_{avg} = \frac{\dot{m}}{\rho A_c} = \frac{4 \text{ lbm/s}}{(61.59 \text{ lbm/m}^3)\pi \frac{(1.25/12 \text{ ft})^2}{4}} = 7.621 \text{ ft/s}$$

$$\text{Re} = \frac{V_{avg} D_h}{\nu} = \frac{(7.621 \text{ m/s})(1.25/12 \text{ ft})}{0.5681 \times 10^{-5} \text{ ft}^2/\text{s}} = 1.397 \times 10^5$$

which is greater than 10,000. Therefore, we can assume fully developed turbulent flow in the entire tube, and determine the Nusselt number from

$$Nu = \frac{hD_h}{k} = 0.023 \text{ Re}^{0.8} \text{ Pr}^{0.4} = 0.023(1.397 \times 10^5)^{0.8} (3.368)^{0.4} = 488.5$$

The heat transfer coefficient is

$$h = \frac{k}{D_h} Nu = \frac{0.374 \text{ Btu/h}\cdot\text{ft}\cdot^\circ\text{F}}{1.25/12 \text{ ft}} (488.5) = 1754 \text{ Btu/h}\cdot\text{ft}^2\cdot^\circ\text{F}$$

The heat flux on the tube is

$$\dot{q} = \frac{\dot{Q}}{A_s} = \frac{2.086 \times 10^6 \text{ Btu/h}}{\pi(1.25/12 \text{ ft})(5960 \text{ ft})} = 1070 \text{ Btu/h}\cdot\text{ft}^2$$

Then the surface temperature of the tube at the exit becomes

$$\dot{q} = h(T_s - T_e) \longrightarrow T_s = T_e + \frac{\dot{q}}{h} = 200^\circ\text{F} + \frac{1070 \text{ Btu/h}\cdot\text{ft}^2}{1754 \text{ Btu/h}\cdot\text{ft}^2\cdot^\circ\text{F}} = \mathbf{200.6^\circ\text{F}}$$

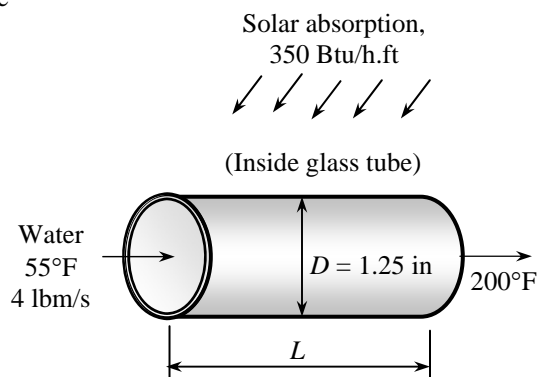

8-52 A circuit board is cooled by passing cool air through a channel drilled into the board. The maximum total power of the electronic components is to be determined.

Assumptions **1** Steady operating conditions exist. **2** The heat flux at the top surface of the channel is uniform, and heat transfer through other surfaces is negligible. **3** The inner surfaces of the channel are smooth. **4** Air is an ideal gas with constant properties. **5** The pressure of air in the channel is 1 atm.

Properties The properties of air at 1 atm and estimated average temperature of 25°C are (Table A-15)

$$\begin{aligned}\rho &= 1.184 \text{ kg/m}^3 \\ k &= 0.02551 \text{ W/m}\cdot\text{°C} \\ \nu &= 1.562 \times 10^{-5} \text{ m}^2/\text{s} \\ c_p &= 1007 \text{ J/kg}\cdot\text{°C} \\ \text{Pr} &= 0.7296\end{aligned}$$

Analysis The cross-sectional and heat transfer surface areas are

$$A_c = (0.002 \text{ m})(0.14 \text{ m}) = 0.00028 \text{ m}^2$$

$$A_s = (0.14 \text{ m})(0.2 \text{ m}) = 0.028 \text{ m}^2$$

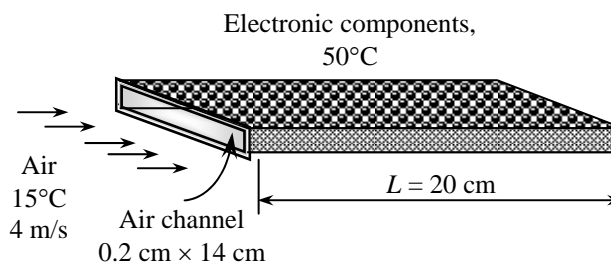

To determine heat transfer coefficient, we first need to find the Reynolds number,

$$D_h = \frac{4A_c}{P} = \frac{4(0.00028 \text{ m}^2)}{2(0.002 \text{ m} + 0.14 \text{ m})} = 0.003944 \text{ m}$$

$$\text{Re} = \frac{V_{\text{avg}} D_h}{\nu} = \frac{(4 \text{ m/s})(0.003944 \text{ m})}{1.562 \times 10^{-5} \text{ m}^2/\text{s}} = 1010$$

which is less than 2300. Therefore, the flow is laminar and the thermal entry length is

$$L_t = 0.05 \text{ Re Pr } D_h = 0.05(1010)(0.7296)(0.003944 \text{ m}) = 0.1453 \text{ m} < 0.20 \text{ m}$$

Therefore, we have developing flow through most of the channel. However, we take the conservative approach and assume fully developed flow, and from Table 8-1 we read $\text{Nu} = 8.24$. Then the heat transfer coefficient becomes

$$h = \frac{k}{D_h} \text{Nu} = \frac{0.02551 \text{ W/m}\cdot\text{°C}}{0.003944 \text{ m}} (8.24) = 53.30 \text{ W/m}^2\cdot\text{°C}$$

Also,

$$\dot{m} = \rho V A_c = (1.184 \text{ kg/m}^3)(4 \text{ m/s})(0.00028 \text{ m}^2) = 0.001326 \text{ kg/s}$$

Heat flux at the exit can be written as $\dot{q} = h(T_s - T_e)$ where $T_s = 50^\circ\text{C}$ at the exit. Then the heat transfer rate can be expressed as $\dot{Q} = \dot{q} A_s = h A_s (T_s - T_e)$, and the exit temperature of the air can be determined from

$$\begin{aligned}h A_s (T_s - T_e) &= \dot{m} c_p (T_e - T_i) \\ (53.30 \text{ W/m}^2\cdot\text{°C})(0.028 \text{ m}^2)(50^\circ\text{C} - T_e) &= (0.001326 \text{ kg/s})(1007 \text{ J/kg}\cdot\text{°C})(T_e - 15^\circ\text{C}) \\ T_e &= 33.5^\circ\text{C}\end{aligned}$$

Then the maximum total power of the electronic components that can safely be mounted on this circuit board becomes

$$\dot{Q}_{\text{max}} = \dot{m} c_p (T_e - T_i) = (0.001326 \text{ kg/s})(1007 \text{ J/kg}\cdot\text{°C})(33.5 - 15^\circ\text{C}) = \mathbf{24.7 \text{ W}}$$

8-53 A circuit board is cooled by passing cool helium gas through a channel drilled into the board. The maximum total power of the electronic components is to be determined.

Assumptions **1** Steady operating conditions exist. **2** The heat flux at the top surface of the channel is uniform, and heat transfer through other surfaces is negligible. **3** The inner surfaces of the channel are smooth. **4** Helium is an ideal gas. **5** The pressure of helium in the channel is 1 atm.

Properties The properties of helium at the estimated average temperature of 25°C are (from EES)

$$\begin{aligned}\rho &= 0.1635 \text{ kg/m}^3 \\ k &= 0.1553 \text{ W/m}\cdot\text{°C} \\ \nu &= 1.214 \times 10^{-4} \text{ m}^2/\text{s} \\ c_p &= 5193 \text{ J/kg}\cdot\text{°C} \\ \text{Pr} &= 0.6636\end{aligned}$$

Analysis The cross-sectional and heat transfer surface areas are

$$A_c = (0.002 \text{ m})(0.14 \text{ m}) = 0.00028 \text{ m}^2$$

$$A_s = (0.14 \text{ m})(0.2 \text{ m}) = 0.028 \text{ m}^2$$

To determine heat transfer coefficient, we need to first find the Reynolds number

$$D_h = \frac{4A_c}{p} = \frac{4(0.00028 \text{ m}^2)}{2(0.002 \text{ m} + 0.14 \text{ m})} = 0.003944 \text{ m}$$

$$\text{Re} = \frac{V_{\text{avg}} D_h}{\nu} = \frac{(4 \text{ m/s})(0.003944 \text{ m})}{1.214 \times 10^{-4} \text{ m}^2/\text{s}} = 130.0$$

which is less than 2300. Therefore, the flow is laminar and the thermal entry length is

$$L_t = 0.05 \text{ Re Pr } D_h = 0.05(130.0)(0.6636)(0.003944 \text{ m}) = 0.0170 \text{ m} \ll 0.20 \text{ m}$$

Therefore, the flow is fully developed flow, and from Table 8-3 we read $\text{Nu} = 8.24$. Then the heat transfer coefficient becomes

$$h = \frac{k}{D_h} \text{Nu} = \frac{0.1553 \text{ W/m}\cdot\text{°C}}{0.003944 \text{ m}} (8.24) = 324.5 \text{ W/m}^2\cdot\text{°C}$$

Also,

$$\dot{m} = \rho V A_c = (0.1635 \text{ kg/m}^3)(4 \text{ m/s})(0.00028 \text{ m}^2) = 0.0001831 \text{ kg/s}$$

Heat flux at the exit can be written as $\dot{q} = h(T_s - T_e)$ where $T_s = 50^\circ\text{C}$ at the exit. Then the heat transfer rate can be expressed as $\dot{Q} = \dot{q} A_s = h A_s (T_s - T_e)$, and the exit temperature of the air can be determined from

$$\dot{m} c_p (T_e - T_i) = h A_s (T_s - T_e)$$

$$(0.0001831 \text{ kg/s})(5193 \text{ J/kg}\cdot\text{°C})(T_e - 15^\circ\text{C}) = (324.5 \text{ W/m}^2\cdot\text{°C})(0.028 \text{ m}^2)(50^\circ\text{C} - T_e)$$

$$T_e = 46.68^\circ\text{C}$$

Then the maximum total power of the electronic components that can safely be mounted on this circuit board becomes

$$\dot{Q}_{\text{max}} = \dot{m} c_p (T_e - T_i) = (0.0001831 \text{ kg/s})(5193 \text{ J/kg}\cdot\text{°C})(46.68 - 15^\circ\text{C}) = \mathbf{30.1 \text{ W}}$$

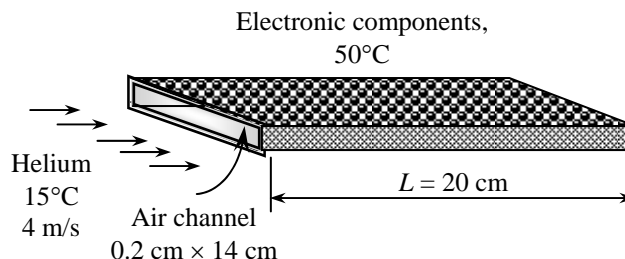

8-54 EES Prob. 8-52 is reconsidered. The effects of air velocity at the inlet of the channel and the maximum surface temperature on the maximum total power dissipation of electronic components are to be investigated.

Analysis The problem is solved using EES, and the solution is given below.

"GIVEN"

L=0.20 [m]
width=0.14 [m]
height=0.002 [m]
T_i=15 [C]
Vel=4 [m/s]
T_s=50 [C]

"PROPERTIES"

Fluid\$='air'
C_p=CP(Fluid\$, T=T_{ave})*Convert(kJ/kg-C, J/kg-C)
k=Conductivity(Fluid\$, T=T_{ave})
Pr=Prandtl(Fluid\$, T=T_{ave})
rho=Density(Fluid\$, T=T_{ave}, P=101.3)
mu=Viscosity(Fluid\$, T=T_{ave})
nu=mu/rho
T_{ave}=1/2*(T_i+T_e)

"ANALYSIS"

A_c=width*height
A=width*L
p=2*(width+height)
D_h=(4*A_c)/p
Re=(Vel*D_h)/nu "The flow is laminar"
L_t=0.05*Re*Pr*D_h
"Taking conservative approach and assuming fully developed laminar flow, from Table 8-1 we read"
Nusselt=8.24
h=k/D_h*Nusselt
m_{dot}=rho*Vel*A_c
Q_{dot}=h*A*(T_s-T_e)
Q_{dot}=m_{dot}*C_p*(T_e-T_i)

Vel [m/s]	Q [W]
1	9.453
2	16.09
3	20.96
4	24.67
5	27.57
6	29.91
7	31.82
8	33.41
9	34.76
10	35.92

T_s [C]	Q [W]
30	10.59
35	14.12
40	17.64
45	21.15
50	24.67
55	28.18
60	31.68
65	35.18
70	38.68
75	42.17
80	45.65
85	49.13
90	52.6

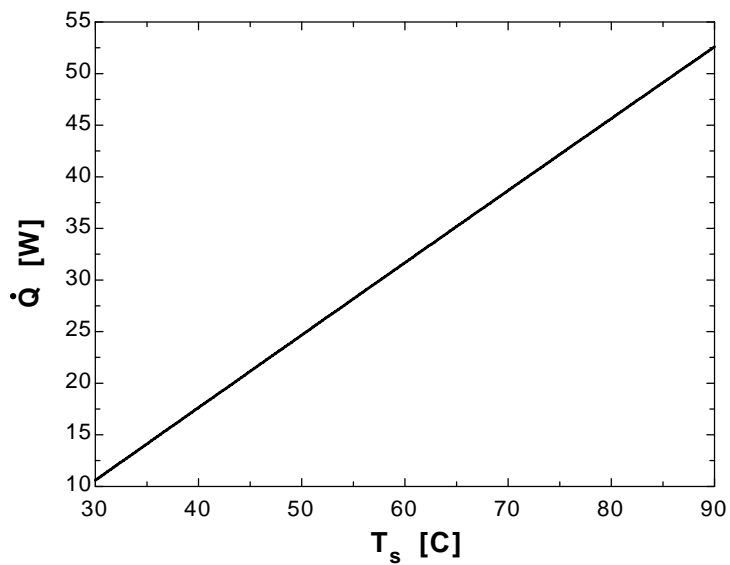
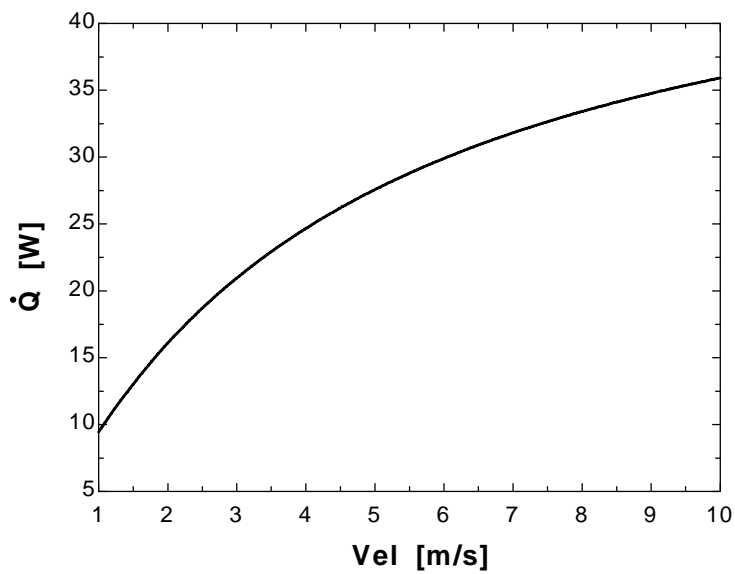

8-55 Air enters a rectangular duct. The exit temperature of the air, the rate of heat transfer, and the fan power are to be determined.

Assumptions 1 Steady operating conditions exist. 2 The inner surfaces of the duct are smooth. 3 Air is an ideal gas with constant properties. 4 The pressure of air in the duct is 1 atm.

Properties We assume the bulk mean temperature for air to be 40°C since the mean temperature of air at the inlet will drop somewhat as a result of heat loss through the duct whose surface is at a lower temperature. The properties of air at this temperature and 1 atm are (Table A-15)

$$\begin{aligned}\rho &= 1.127 \text{ kg/m}^3 & c_p &= 1007 \text{ J/kg}\cdot^\circ\text{C} \\ k &= 0.02662 \text{ W/m}\cdot^\circ\text{C} & \text{Pr} &= 0.7255 \\ \nu &= 1.702 \times 10^{-5} \text{ m}^2/\text{s}\end{aligned}$$

Analysis (a) The hydraulic diameter, the mean velocity of air, and the Reynolds number are

$$D_h = \frac{4A_c}{p} = \frac{4(0.15 \text{ m})(0.20 \text{ m})}{2[(0.15 \text{ m}) + (0.20 \text{ m})]} = 0.1714 \text{ m}$$

$$\text{Re} = \frac{V_{\text{avg}} D_h}{\nu} = \frac{(7 \text{ m/s})(0.1714 \text{ m})}{1.702 \times 10^{-5} \text{ m}^2/\text{s}} = 70,500$$

which is greater than 10,000. Therefore, the flow is turbulent and the entry lengths in this case are roughly

$$L_h \approx L_t \approx 10D_h = 10(0.1714 \text{ m}) = 1.714 \text{ m}$$

which is much shorter than the total length of the duct. Therefore, we can assume fully developed turbulent flow in the entire duct, and determine the Nusselt number from

$$\text{Nu} = \frac{hD_h}{k} = 0.023 \text{ Re}^{0.8} \text{ Pr}^{0.3} = 0.023(70,500)^{0.8} (0.7255)^{0.3} = 157.9$$

Heat transfer coefficient is

$$h = \frac{k}{D_h} \text{Nu} = \frac{0.02662 \text{ W/m}\cdot^\circ\text{C}}{0.1714 \text{ m}} (157.9) = 24.52 \text{ W/m}^2\cdot^\circ\text{C}$$

Next we determine the exit temperature of air

$$A_s = 2 \times 7[(0.15 \text{ m}) + (0.20 \text{ m})] = 4.9 \text{ m}^2$$

$$A_c = (0.15 \text{ m})(0.20 \text{ m}) = 0.03 \text{ m}^2$$

$$\dot{m} = \rho V A_c = (1.127 \text{ kg/m}^3)(7 \text{ m/s})(0.03 \text{ m}^2) = 0.2367 \text{ kg/s}$$

$$T_e = T_s - (T_s - T_i) e^{-hA_s / (\dot{m}c_p)} = 10 - (10 - 50) e^{-\frac{(24.52)(4.9)}{(0.2367)(1007)}} = \mathbf{34.16^\circ\text{C}}$$

(b) The logarithmic mean temperature difference and the rate of heat loss from the air are

$$\Delta T_{\text{ln}} = \frac{T_e - T_i}{\ln\left(\frac{T_s - T_e}{T_s - T_i}\right)} = \frac{34.16 - 50}{\ln\left(\frac{10 - 34.16}{10 - 50}\right)} = 31.42^\circ\text{C}$$

$$\dot{Q} = hA_s \Delta T_{\text{ln}} = (24.52 \text{ W/m}^2\cdot^\circ\text{C})(4.9 \text{ m}^2)(31.42^\circ\text{C}) = \mathbf{3775 \text{ W}}$$

(c) The friction factor, the pressure drop, and then the fan power can be determined for the case of fully developed turbulent flow to be

$$f = 0.184 \text{ Re}^{-0.2} = 0.184(70,500)^{-0.2} = 0.01973$$

$$\Delta P = f \frac{L}{D} \frac{\rho V_{\text{avg}}^2}{2} = 0.01973 \frac{(7 \text{ m})}{(0.1714 \text{ m})} \frac{(1.127 \text{ kg/m}^3)(7 \text{ m/s})^2}{2} = 22.25 \text{ N/m}^2$$

$$\dot{W}_{\text{pump}} = \frac{\dot{m} \Delta P}{\rho} = \frac{(0.2367 \text{ kg/s})(22.25 \text{ N/m}^2)}{1.127 \text{ kg/m}^3} = \mathbf{4.67 \text{ W}}$$

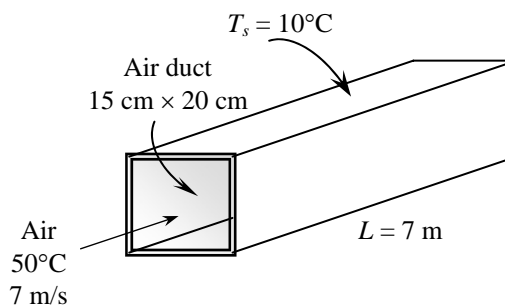

8-56 EES Prob. 8-55 is reconsidered. The effect of air velocity on the exit temperature of air, the rate of heat transfer, and the fan power is to be investigated.

Analysis The problem is solved using EES, and the solution is given below.

"GIVEN"

L=7 [m]
height=0.15 [m]
width=0.20 [m]
T_i=50 [C]
Vel=7 [m/s]
T_s=10 [C]

"PROPERTIES"

Fluid\$='air'
C_p=CP(Fluid\$, T=T_{ave})*Convert(kJ/kg-C, J/kg-C)
k=Conductivity(Fluid\$, T=T_{ave})
Pr=Prandtl(Fluid\$, T=T_{ave})
rho=Density(Fluid\$, T=T_{ave}, P=101.3)
mu=Viscosity(Fluid\$, T=T_{ave})
nu=mu/rho
T_{ave}=1/2*(T_i+T_e)

"ANALYSIS"

"(a)"

A_c=width*height
p=2*(width+height)
D_h=(4*A_c)/p
Re=(Vel*D_h)/nu **"The flow is turbulent"**
L_t=10*D_h **"The entry length is much shorter than the total length of the duct."**
Nusselt=0.023*Re^{0.8}*Pr^{0.3}
h=k/D_h*Nusselt
A=2*L*(width+height)
m_{dot}=rho*Vel*A_c
T_e=T_s-(T_s-T_i)*exp((-h*A)/(m_{dot}*C_p))

"(b)"

DELTA_T_{ln}=(T_e-T_i)/ln((T_s-T_e)/(T_s-T_i))
Q_{dot}=h*A*DELTA_T_{ln}

"(c)"

f=0.184*Re^(-0.2)
DELTA_P=f*L/D_h*(rho*Vel²)/2
W_{dot}_{pump}=(m_{dot}*DELTA_P)/rho

Vel [m/s]	T _e [C]	Q [W]	W _{pump} [W]
1	29.01	715.6	0.02012
1.5	30.14	1014	0.06255
2	30.92	1297	0.1399
2.5	31.51	1570	0.2611
3	31.99	1833	0.4348
3.5	32.39	2090	0.6692
4	32.73	2341	0.9722
4.5	33.03	2587	1.352
5	33.29	2829	1.815
5.5	33.53	3066	2.369

6	33.75	3300	3.022
6.5	33.94	3531	3.781
7	34.12	3759	4.652
7.5	34.29	3984	5.642
8	34.44	4207	6.759
8.5	34.59	4427	8.008
9	34.72	4646	9.397
9.5	34.85	4862	10.93
10	34.97	5076	12.62

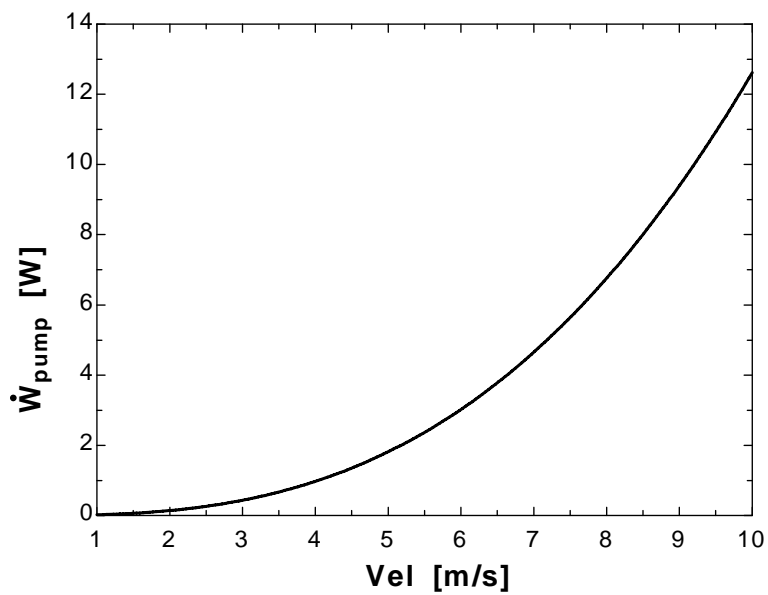
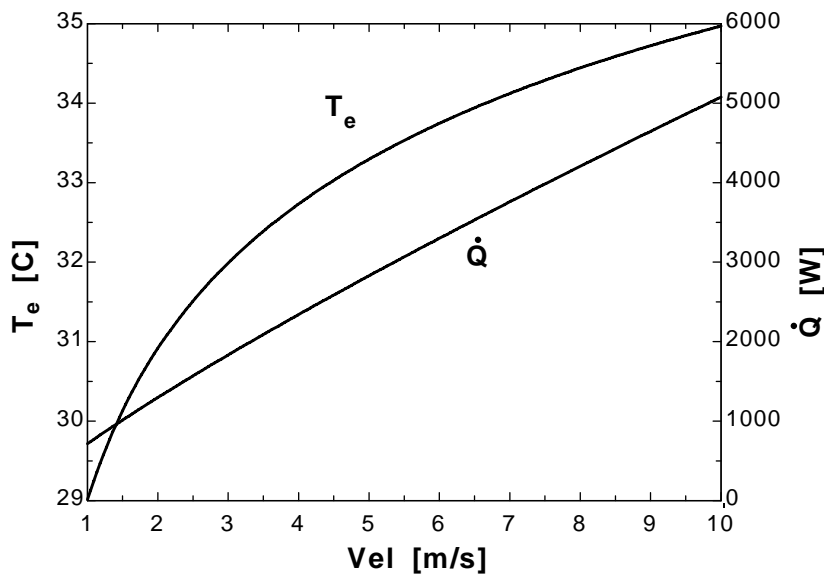

8-57 Hot air enters a sheet metal duct located in a basement. The exit temperature of hot air and the rate of heat loss are to be determined.

Assumptions 1 Steady flow conditions exist. 2 The inner surfaces of the duct are smooth. 3 The thermal resistance of the duct is negligible. 4 Air is an ideal gas with constant properties. 5 The pressure of air is 1 atm.

Properties We expect the air temperature to drop somewhat, and evaluate the air properties at 1 atm and the estimated bulk mean temperature of 50°C (Table A-15),

$$\rho = 1.092 \text{ kg/m}^3; \quad k = 0.02735 \text{ W/m}\cdot\text{°C}$$

$$\nu = 1.798 \times 10^{-5} \text{ m}^2/\text{s}; \quad c_p = 1007 \text{ J/kg}\cdot\text{°C}$$

$$\text{Pr} = 0.7228$$

Analysis The surface area and the Reynolds number are

$$A_s = 4aL = 4 \times (0.2 \text{ m})(12 \text{ m}) = 9.6 \text{ m}^2$$

$$D_h = \frac{4A_c}{p} = \frac{4a^2}{4a} = a = 0.2 \text{ m}$$

$$\text{Re} = \frac{V_{\text{avg}} D_h}{\nu} = \frac{(4 \text{ m/s})(0.20 \text{ m})}{1.798 \times 10^{-5} \text{ m}^2/\text{s}} = 44,494$$

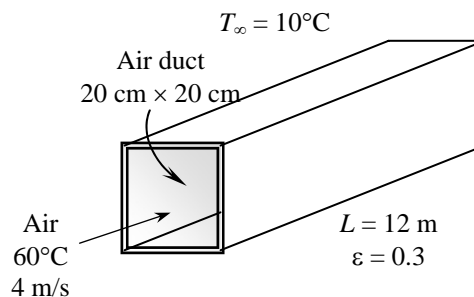

which is greater than 10,000. Therefore, the flow is turbulent and the entry lengths in this case are roughly

$$L_h \approx L_t \approx 10D_h = 10(0.2 \text{ m}) = 2.0 \text{ m}$$

which is much shorter than the total length of the duct. Therefore, we can assume fully developed turbulent flow for the entire duct, and determine the Nusselt number from

$$\text{Nu} = \frac{hD_h}{k} = 0.023 \text{Re}^{0.8} \text{Pr}^{0.3} = 0.023(44,494)^{0.8} (0.7228)^{0.3} = 109.2$$

and

$$h = \frac{k}{D_h} \text{Nu} = \frac{0.02735 \text{ W/m}\cdot\text{°C}}{0.2 \text{ m}} (109.2) = 14.93 \text{ W/m}^2\cdot\text{°C}$$

The mass flow rate of air is

$$\dot{m} = \rho A_c V = (1.092 \text{ kg/m}^3)(0.2 \times 0.2 \text{ m}^2)(4 \text{ m/s}) = 0.1747 \text{ kg/s}$$

In steady operation, heat transfer from hot air to the duct must be equal to the heat transfer from the duct to the surrounding (by convection and radiation), which must be equal to the energy loss of the hot air in the duct. That is,

$$\dot{Q} = \dot{Q}_{\text{conv,in}} = \dot{Q}_{\text{conv+rad,out}} = \Delta \dot{E}_{\text{hot air}}$$

Assuming the duct to be at an average temperature of T_s , the quantities above can be expressed as

$$\dot{Q}_{\text{conv,in}}: \quad \dot{Q} = h_i A_s \Delta T_{\text{ln}} = h_i A_s \frac{T_e - T_i}{\ln\left(\frac{T_s - T_e}{T_s - T_i}\right)} \rightarrow \dot{Q} = (14.93 \text{ W/m}^2\cdot\text{°C})(9.6 \text{ m}^2) \frac{T_e - 60}{\ln\left(\frac{T_s - T_e}{T_s - 60}\right)}$$

$$\dot{Q}_{\text{conv+rad,out}}: \quad \dot{Q} = h_o A_s (T_s - T_o) + \varepsilon A_s \sigma (T_s^4 - T_o^4) \rightarrow \dot{Q} = (10 \text{ W/m}^2\cdot\text{°C})(9.6 \text{ m}^2)(T_s - 10)\text{°C} + 0.3(9.6 \text{ m}^2)(5.67 \times 10^{-8} \text{ W/m}^2\cdot\text{K}^4)[(T_s + 273)^4 - (10 + 273)^4] \text{K}^4$$

$$\Delta \dot{E}_{\text{hot air}}: \quad \dot{Q} = \dot{m} c_p (T_e - T_i) \rightarrow \dot{Q} = (0.1747 \text{ kg/s})(1007 \text{ J/kg}\cdot\text{°C})(60 - T_e)\text{°C}$$

This is a system of three equations with three unknowns whose solution is

$$\dot{Q} = 2622 \text{ W}, T_e = 45.1\text{°C}, \text{ and } T_s = 33.3\text{°C}$$

Therefore, the hot air will lose heat at a rate of 2622 W and exit the duct at 45.1°C.

8-58 EES Prob. 8-57 is reconsidered. The effects of air velocity and the surface emissivity on the exit temperature of air and the rate of heat loss are to be investigated.

Analysis The problem is solved using EES, and the solution is given below.

"GIVEN"

T_i=60 [C]
 L=12 [m]
 side=0.20 [m]
 Vel=4 [m/s]
 epsilon=0.3
 T_o=10 [C]
 h_o=10 [W/m²-C]
 T_{surr}=10 [C]

"PROPERTIES"

Fluid\$='air'
 C_p=CP(Fluid\$, T=T_{ave})*Convert(kJ/kg-C, J/kg-C)
 k=Conductivity(Fluid\$, T=T_{ave})
 Pr=Prandtl(Fluid\$, T=T_{ave})
 rho=Density(Fluid\$, T=T_{ave}, P=101.3)
 mu=Viscosity(Fluid\$, T=T_{ave})
 nu=mu/rho
 T_{ave}=T_i-10 "assumed average bulk mean temperature"

"ANALYSIS"

A=4*side*L
 A_c=side^2
 p=4*side
 D_h=(4*A_c)/p
 Re=(Vel*D_h)/nu "The flow is turbulent"
 L_t=10*D_h "The entry length is much shorter than the total length of the duct."
 Nusselt=0.023*Re^{0.8}*Pr^{0.3}
 h_i=k/D_h*Nusselt
 m_{dot}=rho*Vel*A_c
 Q_{dot}=Q_{dot_conv_in}
 Q_{dot_conv_in}=Q_{dot_conv_out}+Q_{dot_rad_out}
 Q_{dot_conv_in}=h_i*A*DELTA T_{ln}
 DELTA T_{ln}=(T_e-T_i)/ln((T_s-T_e)/(T_s-T_i))
 Q_{dot_conv_out}=h_o*A*(T_s-T_o)
 Q_{dot_rad_out}=epsilon*A*sigma*((T_s+273)⁴-(T_{surr}+273)⁴)
 sigma=5.67E-8 "[W/m²-K⁴], Stefan-Boltzmann constant"
 Q_{dot}=m_{dot}*C_p*(T_i-T_e)

Vel [m/s]	T _e [C]	Q [W]
1	33.85	1150
2	39.43	1810
3	42.78	2273
4	45.1	2622
5	46.83	2898
6	48.17	3122
7	49.25	3310
8	50.14	3469
9	50.89	3606
10	51.53	3726

ε	T_e [C]	Q [W]
0.1	45.82	2495
0.2	45.45	2560
0.3	45.1	2622
0.4	44.77	2680
0.5	44.46	2735
0.6	44.16	2787
0.7	43.88	2836
0.8	43.61	2883
0.9	43.36	2928
1	43.12	2970

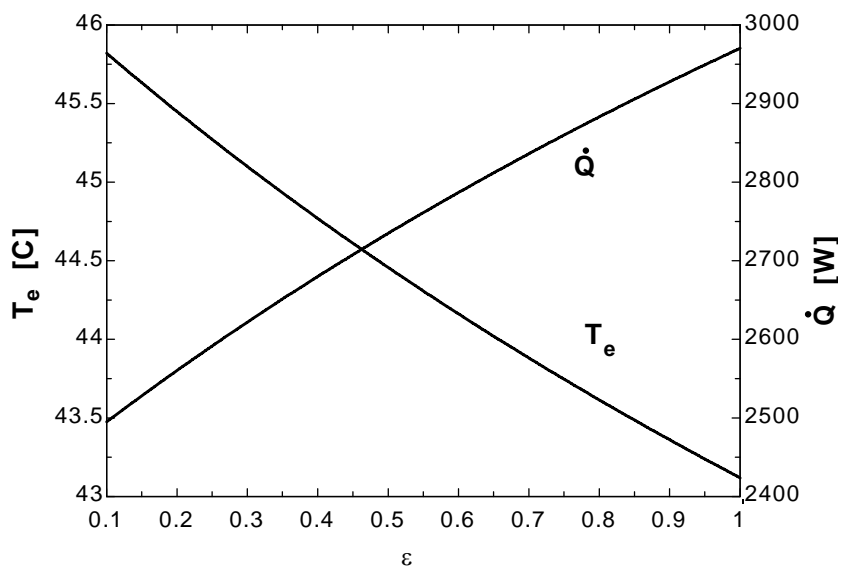
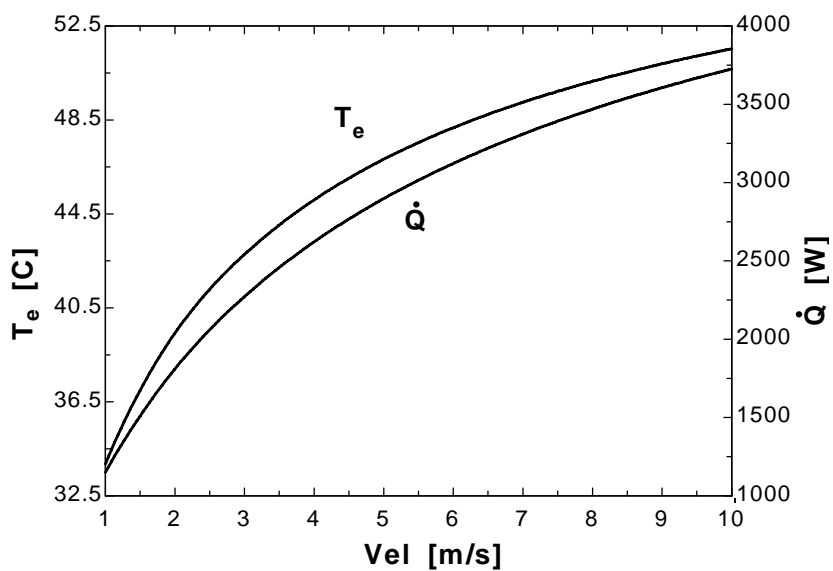

8-59 The components of an electronic system located in a rectangular horizontal duct are cooled by forced air. The exit temperature of the air and the highest component surface temperature are to be determined.

Assumptions 1 Steady flow conditions exist. 2 The inner surfaces of the duct are smooth. 3 The thermal resistance of the duct is negligible. 4 Air is an ideal gas with constant properties. 5 The pressure of air is 1 atm.

Properties We assume the bulk mean temperature for air to be 35°C since the mean temperature of air at the inlet will rise somewhat as a result of heat gain through the duct whose surface is exposed to a constant heat flux. The properties of air at 1 atm and this temperature are (Table A-15)

$$\begin{aligned}\rho &= 1.145 \text{ kg/m}^3 \\ k &= 0.02625 \text{ W/m}\cdot^\circ\text{C} \\ \nu &= 1.655 \times 10^{-5} \text{ m}^2/\text{s} \\ c_p &= 1007 \text{ J/kg}\cdot^\circ\text{C} \\ \text{Pr} &= 0.7268\end{aligned}$$

Analysis (a) The mass flow rate of air and the exit temperature are determined from

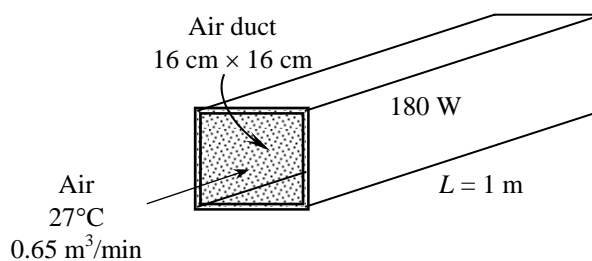

$$\dot{m} = \rho \dot{V} = (1.145 \text{ kg/m}^3)(0.65 \text{ m}^3/\text{min}) = 0.7443 \text{ kg/min} = 0.0124 \text{ kg/s}$$

$$\dot{Q} = \dot{m} c_p (T_e - T_i) \rightarrow T_e = T_i + \frac{\dot{Q}}{\dot{m} c_p} = 27^\circ\text{C} + \frac{(0.85)(180 \text{ W})}{(0.0124 \text{ kg/s})(1007 \text{ J/kg}\cdot^\circ\text{C})} = \mathbf{39.3^\circ\text{C}}$$

(b) The mean fluid velocity and hydraulic diameter are

$$V_m = \frac{\dot{V}}{A_c} = \frac{0.65 \text{ m}^3/\text{min}}{(0.16 \text{ m})(0.16 \text{ m})} = 25.4 \text{ m/min} = 0.4232 \text{ m/s}$$

$$D_h = \frac{4A_c}{p} = \frac{4(0.16 \text{ m})(0.16 \text{ m})}{4(0.16 \text{ m})} = 0.16 \text{ m}$$

Then

$$\text{Re} = \frac{V_{\text{avg}} D_h}{\nu} = \frac{(0.4232 \text{ m/s})(0.16 \text{ m})}{1.655 \times 10^{-5} \text{ m}^2/\text{s}} = 4091$$

which is not greater than 10,000 but the components will cause turbulence and thus we can assume fully developed turbulent flow in the entire duct, and determine the Nusselt number from

$$\text{Nu} = \frac{h D_h}{k} = 0.023 \text{Re}^{0.8} \text{Pr}^{0.4} = 0.023(4091)^{0.8} (0.7268)^{0.4} = 15.69$$

and

$$h = \frac{k}{D_h} \text{Nu} = \frac{0.02625 \text{ W/m}\cdot^\circ\text{C}}{0.16 \text{ m}} (15.69) = 2.574 \text{ W/m}^2\cdot^\circ\text{C}$$

The highest component surface temperature will occur at the exit of the duct. Assuming uniform surface heat flux, its value is determined from

$$\begin{aligned}\dot{Q} / A_s &= h(T_{s,\text{highest}} - T_e) \\ T_{s,\text{highest}} &= T_e + \frac{\dot{Q} / A_s}{h} = 39.2^\circ\text{C} + \frac{(0.85)(180 \text{ W}) / [4(0.16 \text{ m})(1 \text{ m})]}{2.574 \text{ W/m}^2\cdot^\circ\text{C}} = \mathbf{132^\circ\text{C}}\end{aligned}$$

8-60 The components of an electronic system located in a circular horizontal duct are cooled by forced air. The exit temperature of the air and the highest component surface temperature are to be determined.

Assumptions 1 Steady flow conditions exist. 2 The inner surfaces of the duct are smooth. 3 The thermal resistance of the duct is negligible. 4 Air is an ideal gas with constant properties. 5 The pressure of air is 1 atm.

Properties We assume the bulk mean temperature for air to be 35°C since the mean temperature of air at the inlet will rise somewhat as a result of heat gain through the duct whose surface is exposed to a constant heat flux. The properties of air at 1 atm and this temperature are (Table A-15)

$$\begin{aligned}\rho &= 1.145 \text{ kg/m}^3 \\ k &= 0.02625 \text{ W/m}\cdot^\circ\text{C} \\ \nu &= 1.655 \times 10^{-5} \text{ m}^2/\text{s} \\ c_p &= 1007 \text{ J/kg}\cdot^\circ\text{C} \\ \text{Pr} &= 0.7268\end{aligned}$$

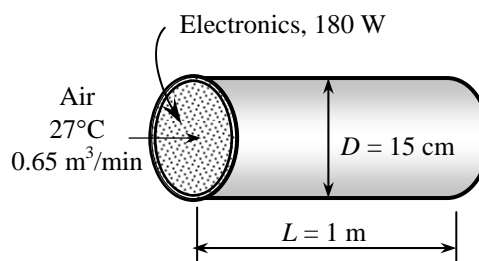

Analysis (a) The mass flow rate of air and the exit temperature are determined from

$$\dot{m} = \rho \dot{V} = (1.145 \text{ kg/m}^3)(0.65 \text{ m}^3/\text{min}) = 0.7443 \text{ kg/min} = 0.0124 \text{ kg/s}$$

$$\dot{Q} = \dot{m}c_p(T_e - T_i) \rightarrow T_e = T_i + \frac{\dot{Q}}{\dot{m}c_p} = 27^\circ\text{C} + \frac{(0.85)(180 \text{ W})}{(0.0124 \text{ kg/s})(1007 \text{ J/kg}\cdot^\circ\text{C})} = \mathbf{39.3^\circ\text{C}}$$

(b) The mean fluid velocity is

$$V_{\text{avg}} = \frac{\dot{V}}{A_c} = \frac{0.65 \text{ m}^3/\text{min}}{\pi(0.15 \text{ m})^2/4} = 36.8 \text{ m/min} = 0.613 \text{ m/s}$$

Then,

$$\text{Re} = \frac{V_{\text{avg}}D_h}{\nu} = \frac{(0.613 \text{ m/s})(0.15 \text{ m})}{1.655 \times 10^{-5} \text{ m}^2/\text{s}} = 5556$$

which is not greater than 10,000 but the components will cause turbulence and thus we can assume fully developed turbulent flow in the entire duct, and determine the Nusselt number from

$$\text{Nu} = \frac{hD_h}{k} = 0.023 \text{Re}^{0.8} \text{Pr}^{0.4} = 0.023(5556)^{0.8} (0.7268)^{0.4} = 20.05$$

and

$$h = \frac{k}{D_h} \text{Nu} = \frac{0.02625 \text{ W/m}\cdot^\circ\text{C}}{0.15 \text{ m}} (20.05) = 3.51 \text{ W/m}^2\cdot^\circ\text{C}$$

The highest component surface temperature will occur at the exit of the duct. Assuming uniform heat flux, its value is determined from

$$\dot{q} = h(T_{s,\text{highest}} - T_e) \rightarrow T_{s,\text{highest}} = T_e + \frac{\dot{q}}{h} = 39.2^\circ\text{C} + \frac{(0.85)(180 \text{ W})/[\pi(0.15 \text{ m})(1 \text{ m})]}{3.51 \text{ W/m}^2\cdot^\circ\text{C}} = \mathbf{131.7^\circ\text{C}}$$

8-61 Air enters a hollow-core printed circuit board. The exit temperature of the air and the highest temperature on the inner surface are to be determined.

Assumptions 1 Steady flow conditions exist. 2 Heat generated is uniformly distributed over the two surfaces of the PCB. 3 Air is an ideal gas with constant properties. 4 The pressure of air is 1 atm.

Properties We assume the bulk mean temperature for air to be 40°C since the mean temperature of air at the inlet will rise somewhat as a result of heat gain through the hollow core whose surface is exposed to a constant heat flux. The properties of air at 1 atm and this temperature are (Table A-15)

$$\begin{aligned}\rho &= 1.127 \text{ kg/m}^3 \\ k &= 0.02662 \text{ W/m}\cdot^\circ\text{C} \\ \nu &= 1.702 \times 10^{-5} \text{ m}^2/\text{s} \\ c_p &= 1007 \text{ J/kg}\cdot^\circ\text{C} \\ \text{Pr} &= 0.7255 \\ \mu_b &= 1.918 \times 10^{-5} \text{ kg/m}\cdot\text{s} \\ \mu_{s, @ 60^\circ\text{C}} &= 2.008 \times 10^{-5} \text{ kg/m}\cdot\text{s}\end{aligned}$$

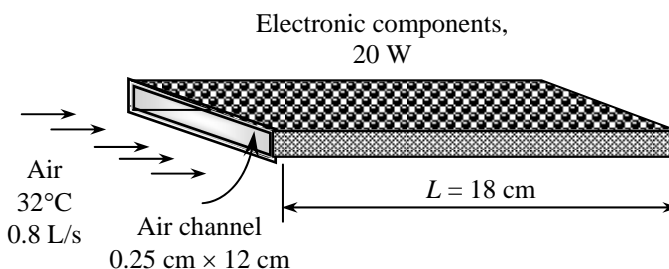

Analysis (a) The mass flow rate of air and the exit temperature are determined from

$$\begin{aligned}\dot{m} &= \rho \dot{V} = (1.127 \text{ kg/m}^3)(0.8 \times 10^{-3} \text{ m}^3/\text{s}) = 9.02 \times 10^{-4} \text{ kg/s} \\ \dot{Q} &= \dot{m} c_p (T_e - T_i) \rightarrow T_e = T_i + \frac{\dot{Q}}{\dot{m} c_p} = 32^\circ\text{C} + \frac{20 \text{ W}}{(9.02 \times 10^{-4} \text{ kg/s})(1007 \text{ J/kg}\cdot^\circ\text{C})} = 54.0^\circ\text{C}\end{aligned}$$

(b) The mean fluid velocity and hydraulic diameter are

$$\begin{aligned}V_{\text{avg}} &= \frac{\dot{V}}{A_c} = \frac{0.8 \times 10^{-3} \text{ m}^3/\text{s}}{(0.12 \text{ m})(0.0025 \text{ m})} = 2.67 \text{ m/s} \\ D_h &= \frac{4A_c}{P} = \frac{4(0.12 \text{ m})(0.0025 \text{ m})}{2[(0.12 \text{ m}) + (0.0025 \text{ m})]} = 0.0049 \text{ m}\end{aligned}$$

Then,

$$\text{Re} = \frac{V_{\text{avg}} D_h}{\nu} = \frac{(2.67 \text{ m/s})(0.0049 \text{ m})}{1.702 \times 10^{-5} \text{ m}^2/\text{s}} = 769$$

which is less than 2300. Therefore, the flow is laminar and the thermal entry length in this case is

$$L_t = 0.05 \text{ Re Pr } D_h = 0.05(769)(0.7255)(0.0049 \text{ m}) = 0.14 \text{ m}$$

which is shorter than the total length of the duct. Therefore, we assume thermally developing flow, and determine the Nusselt number from

$$\text{Nu} = \frac{h D_h}{k} = 1.86 \left(\frac{\text{Re Pr } D}{L} \right)^{1/3} \left(\frac{\mu_b}{\mu_s} \right)^{0.14} = 1.86 \left[\frac{(769)(0.7255)(0.0049)}{0.18} \right]^{1/3} \left(\frac{1.918 \times 10^{-5}}{2.008 \times 10^{-5}} \right)^{0.14} = 4.58$$

and,

$$h = \frac{k}{D_h} \text{Nu} = \frac{0.02662 \text{ W/m}\cdot^\circ\text{C}}{0.0049 \text{ m}} (4.58) = 24.9 \text{ W/m}^2\cdot^\circ\text{C}$$

The highest component surface temperature will occur at the exit of the duct. Its value is determined from

$$\begin{aligned}\dot{Q} &= h A_s (T_{s, \text{highest}} - T_e) \rightarrow T_{s, \text{highest}} = T_e + \frac{\dot{Q}}{h A_s} \\ &= 54.0^\circ\text{C} + \frac{20 \text{ W}}{(24.9 \text{ W/m}^2\cdot^\circ\text{C}) [2(0.12 \times 0.18 + 0.0025 \times 0.18) \text{ m}^2]} = 72.2^\circ\text{C}\end{aligned}$$

8-62 Air enters a hollow-core printed circuit board. The exit temperature of the air and the highest temperature on the inner surface are to be determined.

Assumptions 1 Steady flow conditions exist. 2 Heat generated is uniformly distributed over the two surfaces of the PCB. 3 Air is an ideal gas with constant properties. 4 The pressure of air is 1 atm.

Properties We assume the bulk mean temperature for air to be 40°C since the mean temperature of air at the inlet will rise somewhat as a result of heat gain through the hollow core whose surface is exposed to a constant heat flux. The properties of air at 1 atm and this temperature are (Table A-15)

$$\begin{aligned}\rho &= 1.127 \text{ kg/m}^3 \\ k &= 0.02662 \text{ W/m}\cdot^\circ\text{C} \\ \nu &= 1.702 \times 10^{-5} \text{ m}^2/\text{s} \\ c_p &= 1007 \text{ J/kg}\cdot^\circ\text{C} \\ \text{Pr} &= 0.7255 \\ \mu_b &= 1.918 \times 10^{-5} \text{ kg/m}\cdot\text{s} \\ \mu_s @ 80^\circ\text{C} &= 2.096 \times 10^{-5} \text{ kg/m}\cdot\text{s}\end{aligned}$$

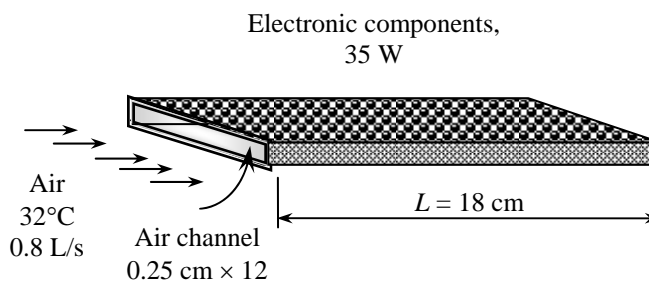

Analysis (a) The mass flow rate of air and the exit temperature are determined from

$$\dot{m} = \rho \dot{V} = (1.127 \text{ kg/m}^3)(0.8 \times 10^{-3} \text{ m}^3/\text{s}) = 9.02 \times 10^{-4} \text{ kg/s}$$

$$\dot{Q} = \dot{m} c_p (T_e - T_i) \rightarrow T_e = T_i + \frac{\dot{Q}}{\dot{m} c_p} = 32^\circ\text{C} + \frac{35 \text{ W}}{(9.02 \times 10^{-4} \text{ kg/s})(1007 \text{ J/kg}\cdot^\circ\text{C})} = \mathbf{70.5^\circ\text{C}}$$

(b) The mean fluid velocity and hydraulic diameter are

$$\begin{aligned}V_{\text{avg}} &= \frac{\dot{V}}{A_c} = \frac{0.8 \times 10^{-3} \text{ m}^3/\text{s}}{(0.12 \text{ m})(0.0025 \text{ m})} = 2.67 \text{ m/s} \\ D_h &= \frac{4A_c}{P} = \frac{4(0.12 \text{ m})(0.0025 \text{ m})}{2[(0.12 \text{ m}) + (0.0025 \text{ m})]} = 0.0049 \text{ m}\end{aligned}$$

Then,

$$\text{Re} = \frac{V_{\text{avg}} D_h}{\nu} = \frac{(2.67 \text{ m/s})(0.0049 \text{ m})}{1.702 \times 10^{-5} \text{ m}^2/\text{s}} = 769$$

which is less than 2300. Therefore, the flow is laminar and the thermal entry length in this case is

$$L_t = 0.05 \text{ Re Pr } D_h = 0.05(769)(0.71)(0.0049 \text{ m}) = 0.14 \text{ m}$$

which is shorter than the total length of the duct. Therefore, we assume thermally developing flow, and determine the Nusselt number from

$$\text{Nu} = \frac{h D_h}{k} = 1.86 \left(\frac{\text{Re Pr } D}{L} \right)^{1/3} \left(\frac{\mu_b}{\mu_s} \right)^{0.14} = 1.86 \left[\frac{(769)(0.7255)(0.0049)}{0.18} \right]^{1/3} \left(\frac{1.918 \times 10^{-5}}{2.096 \times 10^{-5}} \right)^{0.14} = 4.55$$

and,

$$h = \frac{k}{D_h} \text{Nu} = \frac{0.02662 \text{ W/m}\cdot^\circ\text{C}}{0.0049 \text{ m}} (4.55) = 24.7 \text{ W/m}^2\cdot^\circ\text{C}$$

The highest component surface temperature will occur at the exit of the duct. Its value is determined from

$$\begin{aligned}\dot{Q} &= h A_s (T_{s,\text{highest}} - T_e) \rightarrow T_{s,\text{highest}} = T_e + \frac{\dot{Q}}{h A_s} \\ &= 70.5^\circ\text{C} + \frac{35 \text{ W}}{(24.7 \text{ W/m}^2\cdot^\circ\text{C})[2(0.12 \times 0.18 + 0.0025 \times 0.18) \text{ m}^2]} = \mathbf{102.6^\circ\text{C}}\end{aligned}$$

8-63E Water is heated by passing it through thin-walled copper tubes. The length of the copper tube that needs to be used is to be determined.

Assumptions 1 Steady flow conditions exist. 2 The inner surfaces of the tube are smooth. 3 The thermal resistance of the tube is negligible. 4 The temperature at the tube surface is constant.

Properties The properties of water at the bulk mean fluid temperature of $T_{b,avg} = (60 + 140) / 2 = 100^\circ\text{F}$ are (Table A-9E)

$$\begin{aligned}\rho &= 62.0 \text{ lbm/ft}^3 \\ k &= 0.363 \text{ Btu/h}\cdot\text{ft}\cdot^\circ\text{F} \\ \nu &= \mu / \rho = 0.738 \times 10^{-5} \text{ ft}^2/\text{s} \\ c_p &= 0.999 \text{ Btu/lbm}\cdot^\circ\text{F} \\ \text{Pr} &= 4.54\end{aligned}$$

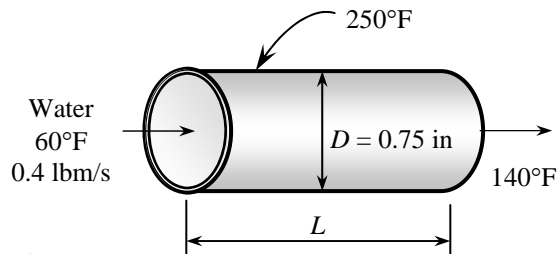

Analysis (a) The mass flow rate and the Reynolds number are

$$\dot{m} = \rho A_c V_{\text{avg}} \rightarrow V_{\text{avg}} = \frac{\dot{m}}{\rho A_c} = \frac{0.4 \text{ lbm/s}}{(62 \text{ lbm/ft}^3)[\pi(0.75/12 \text{ ft})^2/4]} = 2.10 \text{ ft/s}$$

$$\text{Re} = \frac{V_{\text{avg}} D_h}{\nu} = \frac{(2.10 \text{ ft/s})(0.75/12 \text{ ft})}{0.738 \times 10^{-5} \text{ ft}^2/\text{s}} = 17,810$$

which is greater than 10,000. Therefore, the flow is turbulent and the entry lengths in this case are roughly

$$L_h \approx L_t \approx 10D = 10(0.75 \text{ in}) = 7.5 \text{ in}$$

which is probably shorter than the total length of the pipe we will determine. Therefore, we can assume fully developed turbulent flow in the entire duct, and determine the Nusselt number from

$$\text{Nu} = \frac{hD_h}{k} = 0.023 \text{Re}^{0.8} \text{Pr}^{0.4} = 0.023(17,810)^{0.8}(4.54)^{0.4} = 105.9$$

and

$$h = \frac{k}{D_h} \text{Nu} = \frac{0.363 \text{ Btu/h}\cdot\text{ft}\cdot^\circ\text{F}}{(0.75/12) \text{ ft}} (105.9) = 615 \text{ Btu/h}\cdot\text{ft}^2\cdot^\circ\text{F}$$

The logarithmic mean temperature difference and then the rate of heat transfer per ft length of the tube are

$$\Delta T_{\text{ln}} = \frac{T_e - T_i}{\ln\left(\frac{T_s - T_e}{T_s - T_i}\right)} = \frac{140 - 60}{\ln\left(\frac{250 - 140}{250 - 60}\right)} = 146.4^\circ\text{F}$$

$$\dot{Q} = hA_s \Delta T_{\text{ln}} = (615 \text{ Btu/h}\cdot\text{ft}^2\cdot^\circ\text{F})[\pi(0.75/12 \text{ ft})(1 \text{ ft})](146.4^\circ\text{F}) = 17,675 \text{ Btu/h}$$

The rate of heat transfer needed to raise the temperature of water from 60°F to 140°F is

$$\dot{Q} = \dot{m}c_p(T_e - T_i) = (0.4 \times 3600 \text{ lbm/h})(0.999 \text{ Btu/lbm}\cdot^\circ\text{F})(140 - 60)^\circ\text{F} = 115,085 \text{ Btu/h}$$

Then the length of the copper tube that needs to be used becomes

$$\text{Length} = \frac{115,085 \text{ Btu/h}}{17,675 \text{ Btu/h}} = \mathbf{6.51 \text{ ft}}$$

(b) The friction factor, the pressure drop, and then the pumping power required to overcome this pressure drop can be determined for the case of fully developed turbulent flow to be

$$f = 0.184 \text{Re}^{-0.2} = 0.184(17,810)^{-0.2} = 0.02598$$

$$\Delta P = f \frac{L}{D} \frac{\rho V_{\text{avg}}^2}{2} = 0.02598 \frac{(7.69 \text{ ft})}{(0.75/12 \text{ ft})} \frac{(62 \text{ lbm/ft}^3)(2.10 \text{ ft/s})^2}{2} \left(\frac{1 \text{ lbf}}{32.174 \text{ lbm}\cdot\text{ft/s}^2} \right) = 13.58 \text{ lbf/ft}^2$$

$$\dot{W}_{\text{pump}} = \frac{\dot{m}\Delta P}{\rho} = \frac{(0.4 \text{ lbm/s})(13.58 \text{ lbf/ft}^2)}{62 \text{ lbm/ft}^3} \left(\frac{1 \text{ hp}}{550 \text{ lbf}\cdot\text{ft/s}} \right) = \mathbf{0.00016 \text{ hp}}$$

8-64 A computer is cooled by a fan blowing air through its case. The flow rate of the air, the fraction of the temperature rise of air that is due to heat generated by the fan, and the highest allowable inlet air temperature are to be determined.

Assumptions 1 Steady flow conditions exist. 2 Heat flux is uniformly distributed. 3 Air is an ideal gas with constant properties. 4 The pressure of air is 1 atm.

Properties We assume the bulk mean temperature for air to be 25°C. The properties of air at 1 atm and this temperature are (Table A-15)

$$\begin{aligned}\rho &= 1.184 \text{ kg/m}^3 \\ k &= 0.02551 \text{ W/m}\cdot\text{°C} \\ \nu &= 1.562 \times 10^{-5} \text{ m}^2/\text{s} \\ c_p &= 1007 \text{ J/kg}\cdot\text{°C} \\ \text{Pr} &= 0.7296\end{aligned}$$

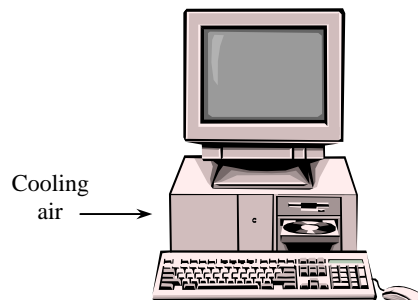

Analysis (a) Noting that the electric energy consumed by the fan is converted to thermal energy, the mass flow rate of air is

$$\dot{Q} = \dot{m}c_p(T_e - T_i) \rightarrow \dot{m} = \frac{\dot{Q} + \dot{W}_{\text{elect, fan}}}{c_p(T_e - T_i)} = \frac{(8 \times 10 + 25) \text{ W}}{(1007 \text{ J/kg}\cdot\text{°C})(10^\circ\text{C})} = \mathbf{0.01043 \text{ kg/s}}$$

(b) The fraction of temperature rise of air that is due to the heat generated by the fan and its motor is

$$\dot{Q} = \dot{m}c_p\Delta T \rightarrow \Delta T = \frac{\dot{Q}}{\dot{m}c_p} = \frac{25 \text{ W}}{(0.01043 \text{ kg/s})(1007 \text{ J/kg}\cdot\text{°C})} = \mathbf{2.38^\circ\text{C}}$$

$$f = \frac{2.38^\circ\text{C}}{10^\circ\text{C}} = 0.238 = \mathbf{23.8\%}$$

(c) The mean velocity of air is

$$\dot{m} = \rho A_c V_{\text{avg}} \rightarrow V_{\text{avg}} = \frac{\dot{m}}{\rho A_c} = \frac{(0.01043 / 8) \text{ kg/s}}{(1.184 \text{ kg/m}^3)[(0.003 \text{ m})(0.12 \text{ m})]} = 3.06 \text{ m/s}$$

and
$$D_h = \frac{4A_c}{P} = \frac{4(0.003 \text{ m})(0.12 \text{ m})}{2(0.003 \text{ m} + 0.12 \text{ m})} = 0.00585 \text{ m}$$

Therefore,

$$\text{Re} = \frac{V_{\text{avg}} D_h}{\nu} = \frac{(3.06 \text{ m/s})(0.00585 \text{ m})}{1.562 \times 10^{-5} \text{ m}^2/\text{s}} = 1146$$

which is less than 2300. Therefore, the flow is laminar. Assuming fully developed flow, the Nusselt number is determined from Table 8-4 corresponding to $a/b = 12/0.3 = 40$ to be $\text{Nu} = 8.24$. Then,

$$h = \frac{k}{D_h} \text{Nu} = \frac{0.02551 \text{ W/m}\cdot\text{°C}}{0.00585 \text{ m}} (8.24) = 35.9 \text{ W/m}^2\cdot\text{°C}$$

The highest component surface temperature will occur at the exit of the duct. Assuming uniform heat flux, the air temperature at the exit is determined from

$$\dot{q} = h(T_{s,\text{max}} - T_e) \rightarrow T_e = T_{s,\text{max}} - \frac{\dot{q}}{h} = 70^\circ\text{C} - \frac{[(80 + 25) \text{ W}]/[8 \times 2(0.12 \times 0.18 + 0.003 \times 0.18) \text{ m}^2]}{35.9 \text{ W/m}^2\cdot\text{°C}} = 61.7^\circ\text{C}$$

The highest allowable inlet temperature then becomes

$$T_e - T_i = 10^\circ\text{C} \rightarrow T_i = T_e - 10^\circ\text{C} = 61.7^\circ\text{C} - 10^\circ\text{C} = \mathbf{51.7^\circ\text{C}}$$

Discussion Although the Reynolds number is less than 2300, the flow in this case will most likely be turbulent because of the electronic components that protrude into flow. Therefore, the heat transfer coefficient determined above is probably conservative.

Special Topic: Transitional Flow

8-65E A liquid mixture flowing in a tube with a bell-mouth inlet is subjected to uniform wall heat flux. The friction coefficient is to be determined.

Assumptions Steady operating conditions exist.

Properties The properties of the ethylene glycol-distilled water mixture are given to be $Pr = 13.8$, $\nu = 18.4 \times 10^{-6} \text{ ft}^2/\text{s}$ and $\mu_b/\mu_s = 1.12$.

Analysis: For the calculation of the non-isothermal fully developed friction coefficient, it is necessary to determine the flow regime before making any decision regarding which friction coefficient relation to use. The Reynolds number at the specified location is

$$Re = \frac{(\dot{V} / A_c) D}{\nu} = \frac{[(2.16 \text{ gal/min}) / (2.11 \times 10^{-3} \text{ ft}^2)] (0.622 / 12 \text{ ft}) \left(\frac{1 \text{ ft}^3/\text{s}}{448.8 \text{ gal/min}} \right)}{18.4 \times 10^{-6} \text{ ft}^2/\text{s}} = 6425$$

since $A_c = \pi D^2 / 4 = \pi (0.622 / 12 \text{ ft})^2 / 4 = 2.110 \times 10^{-3} \text{ ft}^2$

From Table 8-6, the transition Reynolds number range for this case is $3860 < Re < 5200$, which means that the flow in this case is turbulent and Eq. 8-80 is the appropriate equation to use. It gives

$$C_{f,\text{turb}} = \left(\frac{0.0791}{Re^{0.25}} \right) \left(\frac{\mu_b}{\mu_s} \right)^m = \left(\frac{0.0791}{6425^{0.25}} \right) (1.12)^{-0.25} = \mathbf{0.00859}$$

Repeating the calculations when the volume flow rate is increased by 50%, we obtain

$$Re = \frac{(\dot{V} / A_c) D}{\nu} = \frac{[1.5(2.16 \text{ gal/min}) / (2.11 \times 10^{-3} \text{ ft}^2)] (0.622 / 12 \text{ ft}) \left(\frac{1 \text{ ft}^3/\text{s}}{448.8 \text{ gal/min}} \right)}{18.4 \times 10^{-6} \text{ ft}^2/\text{s}} = 9639$$

$$C_{f,\text{turb}} = \left(\frac{0.0791}{Re^{0.25}} \right) \left(\frac{\mu_b}{\mu_s} \right)^m = \left(\frac{0.0791}{9639^{0.25}} \right) (1.12)^{-0.25} = \mathbf{0.00776}$$

8-66 A liquid mixture flowing in a tube with a bell-mouth inlet is subjected to uniform wall heat flux. The friction coefficient is to be determined.

Assumptions Steady operating conditions exist.

Properties The properties of the ethylene glycol-distilled water mixture are given to be $Pr = 14.85$, $\nu = 1.93 \times 10^{-6} \text{ m}^2/\text{s}$ and $\mu_b/\mu_s = 1.07$.

Analysis: For the calculation of the non-isothermal fully developed friction coefficient, it is necessary to determine the flow regime before making any decision regarding which friction coefficient relation to use. The Reynolds number at the specified location is

$$Re = \frac{(\dot{V} / A_c) D}{\nu} = \frac{[(1.43 \times 10^{-4} \text{ m}^3/\text{s}) / (1.961 \times 10^{-4} \text{ m}^2)](0.0158 \text{ m})}{1.93 \times 10^{-6} \text{ m}^2/\text{s}} = 5973$$

$$\text{since } A_c = \pi D^2 / 4 = \pi(0.0158 \text{ m})^2 / 4 = 1.961 \times 10^{-4} \text{ m}^2$$

From Table 8-6, we see that for a bell-mouth inlet and a heat flux of 3 kW/m^2 the flow is in the transition region. Therefore, Eq. 8-81 applies. Reading the constants A , B , C and m_1 , m_2 , m_3 , and m_4 from Table 8-5, the friction coefficient is determined to be

$$\begin{aligned} C_{f, \text{trans}} &= \left[1 + \left(\frac{Re}{A} \right)^B \right]^C \left(\frac{\mu_b}{\mu_s} \right)^m \\ &= \left[1 + \left(\frac{5973}{5340} \right)^{-0.099} \right]^{-6.32} (1.07)^{-2.58 - 0.42 \times 16600^{-0.41} \times 14.85^{2.46}} = \mathbf{0.0073} \end{aligned}$$

8-67 A liquid mixture flowing in a tube with a bell-mouth inlet is subjected to uniform wall heat flux. The friction coefficient is to be determined.

Assumptions Steady operating conditions exist.

Properties The properties of the ethylene glycol-distilled water mixture are given to be $Pr = 14.85$, $\nu = 1.93 \times 10^{-6} \text{ m}^2/\text{s}$ and $\mu_b/\mu_s = 1.07$.

Analysis: For the calculation of the non-isothermal fully developed friction coefficient, it is necessary to determine the flow regime before making any decision regarding which friction coefficient relation to use. If the volume flow rate is increased by 50%, the Reynolds number becomes

$$Re = \frac{(\dot{V} / A_c) D}{\nu} = \frac{[(1.5 \times 1.43 \times 10^{-4} \text{ m}^3/\text{s}) / (1.961 \times 10^{-4} \text{ m}^2)](0.0158 \text{ m})}{1.93 \times 10^{-6} \text{ m}^2/\text{s}} = 8960$$

$$\text{since } A_c = \pi D^2 / 4 = \pi(0.0158 \text{ m})^2 / 4 = 1.961 \times 10^{-4} \text{ m}^2$$

From Table 8-6 for a bell-mouth inlet and a heat flux of 3 kW/m^2 , the flow is in the turbulent region. To calculate the fully developed friction coefficient for this case, Eq. 8-80 for turbulent flow with $m = -0.25$ is used.

$$C_{f, \text{turb}} = \left(\frac{0.0791}{Re^{0.25}} \right) \left(\frac{\mu_b}{\mu_s} \right)^m = \left(\frac{0.0791}{8960^{0.25}} \right) (1.07)^{-0.25} = \mathbf{0.0080}$$

8-68 A liquid mixture flowing in a tube is subjected to uniform wall heat flux. The Nusselt number at a specified location is to be determined for two different tube inlet configurations.

Assumptions Steady operating conditions exist.

Properties The properties of the ethylene glycol-distilled water mixture are given to be $Pr = 33.46$, $\nu = 3.45 \times 10^{-6} \text{ m}^2/\text{s}$ and $\mu_b/\mu_s = 2.0$.

Analysis For a tube with a known diameter and volume flow rate, the type of flow regime is determined before making any decision regarding which Nusselt number correlation to use. The Reynolds number at the specified location is

$$Re = \frac{(\dot{V} / A_c) D}{\nu} = \frac{[(2.05 \times 10^{-4} \text{ m}^3/\text{s}) / (1.961 \times 10^{-4} \text{ m}^2)](0.0158 \text{ m})}{3.45 \times 10^{-6} \text{ m}^2/\text{s}} = 4790$$

$$\text{since } A_c = \pi D^2 / 4 = \pi(0.0158 \text{ m})^2 / 4 = 1.961 \times 10^{-4} \text{ m}^2.$$

Therefore, the flow regime is in the transition region for all three inlet configurations (thus use the information given in Table 8-8 with $x/D = 10$) and therefore Eq. 8-83 should be used with the constants a , b , c found in Table 8-7. However, Nu_{lam} and Nu_{turb} are the inputs to Eq. 8-83 and they need to be evaluated first from Eqs. 8-84 and 8-85, respectively. It should be mentioned that the correlations for Nu_{lam} and Nu_{turb} have no inlet dependency.

From Eq. 8-84:

$$\begin{aligned} Nu_{\text{lam}} &= 1.24 \left[\left(\frac{Re Pr D}{x} \right) + 0.025 (Gr Pr)^{0.75} \right]^{1/3} \left(\frac{\mu_b}{\mu_s} \right)^{0.14} \\ &= 1.24 \left[\left(\frac{(4790)(33.46)}{10} \right) + 0.025 [(60,000)(33.46)]^{0.75} \right]^{1/3} (2.0)^{0.14} = 35.4 \end{aligned}$$

From Eq. 8-85:

$$\begin{aligned} Nu_{\text{turb}} &= 0.023 Re^{0.8} Pr^{0.385} \left(\frac{x}{D} \right)^{-0.0054} \left(\frac{\mu_b}{\mu_s} \right)^{0.14} \\ &= 0.023 (4790)^{0.8} (33.46)^{0.385} (10)^{-0.0054} (2.0)^{0.14} = 85.1 \end{aligned}$$

Then the transition Nusselt number can be determined from Eq. 8-83,

$$Nu_{\text{trans}} = Nu_{\text{lam}} + \left\{ \exp[(a - Re)/b] + Nu_{\text{turb}}^c \right\}^c$$

Case 1: For bell-mouth inlet:

$$Nu_{\text{trans}} = 35.4 + \left\{ \exp[(6628 - 4790)/237] + 85.1^{-0.980} \right\}^{-0.980} = \mathbf{35.4}$$

Case 2: For re-entrant inlet:

$$Nu_{\text{trans}} = 35.4 + \left\{ \exp[(1766 - 4790)/276] + 85.1^{-0.955} \right\}^{-0.955} = \mathbf{92.9}$$

Discussion Comparing the two results, it can be seen that under the same conditions, the Nusselt number for the re-entrant inlet is much higher than that for the bell-mouth inlet. To verify this trend, refer to Fig. 8-35.

8-69 A liquid mixture flowing in a tube is subjected to uniform wall heat flux. The Nusselt number at a specified location is to be determined for two different tube inlet configurations.

Assumptions Steady operating conditions exist.

Properties The properties of the ethylene glycol-distilled water mixture are given to be $Pr = 33.46$, $\nu = 3.45 \times 10^{-6} \text{ m}^2/\text{s}$ and $\mu_b/\mu_s = 2.0$.

Analysis For a tube with a known diameter and volume flow rate, the type of flow regime is determined before making any decision regarding which Nusselt number correlation to use. The Reynolds number at the specified location is

$$Re = \frac{(\dot{V} / A_c) D}{\nu} = \frac{[(2.05 \times 10^{-4} \text{ m}^3/\text{s}) / (1.961 \times 10^{-4} \text{ m}^2)](0.0158 \text{ m})}{3.45 \times 10^{-6} \text{ m}^2/\text{s}} = 4790$$

$$\text{since } A_c = \pi D^2 / 4 = \pi(0.0158 \text{ m})^2 / 4 = 1.961 \times 10^{-4} \text{ m}^2.$$

Therefore, the flow regime is in the transition region for all three inlet configurations (thus use the information given in Table 8-8 with $x/D = 90$) and therefore Eq. 8-83 should be used with the constants a , b , c found in Table 8-7. However, Nu_{lam} and Nu_{turb} are the inputs to Eq. 8-83 and they need to be evaluated first from Eqs. 8-84 and 8-85, respectively. It should be mentioned that the correlations for Nu_{lam} and Nu_{turb} have no inlet dependency.

From Eq. 8-84:

$$\begin{aligned} Nu_{\text{lam}} &= 1.24 \left[\left(\frac{Re Pr D}{x} \right) + 0.025 (Gr Pr)^{0.75} \right]^{1/3} \left(\frac{\mu_b}{\mu_s} \right)^{0.14} \\ &= 1.24 \left[\left(\frac{(4790)(33.46)}{90} \right) + 0.025 [(60,000)(33.46)]^{0.75} \right]^{1/3} (2.0)^{0.14} = 20.0 \end{aligned}$$

From Eq. 8-85:

$$\begin{aligned} Nu_{\text{turb}} &= 0.023 Re^{0.8} Pr^{0.385} \left(\frac{x}{D} \right)^{-0.0054} \left(\frac{\mu_b}{\mu_s} \right)^{0.14} \\ &= 0.023 (4790)^{0.8} (33.46)^{0.385} (90)^{-0.0054} (2.0)^{0.14} = 84.1 \end{aligned}$$

Then the transition Nusselt number can be determined from Eq. 8-83,

$$Nu_{\text{trans}} = Nu_{\text{lam}} + \left\{ \exp[(a - Re)/b] + Nu_{\text{turb}}^c \right\}^c$$

Case 1: For bell-mouth inlet:

$$Nu_{\text{trans}} = 20.0 + \left\{ \exp[(6628 - 4790)/237] + 84.1^{-0.980} \right\}^{-0.980} = \mathbf{20.0}$$

Case 2: For re-entrant inlet:

$$Nu_{\text{trans}} = 20.0 + \left\{ \exp[(1766 - 4790)/276] + 84.1^{-0.955} \right\}^{-0.955} = \mathbf{76.9}$$

Discussion Comparing the two results, it can be seen that under the same conditions, the Nusselt number for the re-entrant inlet is much higher than that for the bell-mouth inlet. To verify this trend, refer to Fig. 8-35.

Review Problems

8-70 A silicon chip is cooled by passing water through microchannels etched in the back of the chip. The outlet temperature of water and the chip power dissipation are to be determined.

Assumptions 1 Steady operating conditions exist. 2 The flow of water is fully developed. 3 All the heat generated by the circuits on the top surface of the chip is transferred to the water.

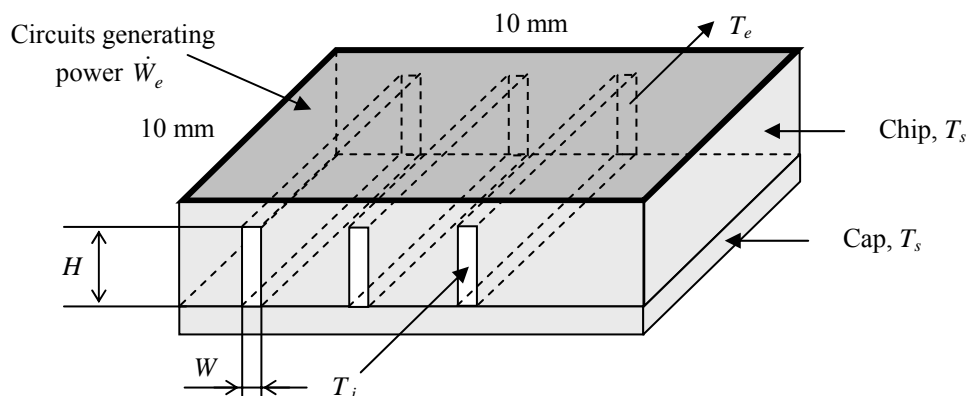

Properties Assuming a bulk mean fluid temperature of 25°C, the properties of water are (Table A-9)

$$\begin{aligned}\rho &= 997 \text{ kg/m}^3 & c_p &= 4180 \text{ J/kg}\cdot^\circ\text{C} \\ k &= 0.607 \text{ W/m}\cdot^\circ\text{C} & \text{Pr} &= 6.14 \\ \mu &= 0.891 \times 10^{-3} \text{ m}^2/\text{s}\end{aligned}$$

Analysis (a) The mass flow rate for one channel, the hydraulic diameter, and the Reynolds number are

$$\dot{m} = \frac{\dot{m}_{\text{total}}}{n_{\text{channel}}} = \frac{0.005 \text{ kg/s}}{50} = 0.0001 \text{ kg/s}$$

$$D_h = \frac{4A}{p} = \frac{4(H \times W)}{2(H + W)} = \frac{4(50 \times 200)}{2(50 + 200)} = 80 \mu\text{m} = 8 \times 10^{-5} \text{ m}$$

$$\text{Re} = \frac{\rho V D_h}{\mu} = \frac{\rho \dot{m} V D_h}{\rho A_c \mu} = \frac{\dot{m} D_h}{A_c \mu} = \frac{(0.0001 \text{ kg/s})(8 \times 10^{-5} \text{ m})}{(50 \times 200 \times 10^{-12} \text{ m}^2)(0.891 \times 10^{-3} \text{ kg/m}\cdot\text{s})} = 898$$

which is smaller than 2300. Therefore, the flow is laminar. We take fully developed laminar flow in the entire duct. The Nusselt number in this case is

$$Nu = 3.66$$

Heat transfer coefficient is

$$h = \frac{k}{D} Nu = \frac{0.607 \text{ W/m}\cdot^\circ\text{C}}{8 \times 10^{-5} \text{ m}} (3.66) = 27,770 \text{ W/m}^2\cdot^\circ\text{C}$$

Next we determine the exit temperature of water

$$A = 2WL + 2HL = 2(0.05 \times 0.01) + 2(0.05 \times 0.2) = 0.021 \text{ mm}^2 = 2.1 \times 10^{-6} \text{ m}^2$$

$$T_e = T_s - (T_s - T_i) e^{-hA/(\dot{m}c_p)} = 350 - (350 - 290) \exp\left[-\frac{(27,770)(2.1 \times 10^{-6})}{(0.0001)(4180)}\right] = \mathbf{297.8 \text{ K}}$$

Then the rate of heat transfer becomes

$$\dot{Q} = \dot{m}c_p(T_e - T_i) = (0.0001 \text{ kg/s})(4180 \text{ J/kg}\cdot^\circ\text{C})(350 - 297.8)^\circ\text{C} = 21.82 \text{ W}$$

(b) Noting that there are 50 such channels, the chip power dissipation becomes

$$\dot{W}_e = n_{\text{channel}} \dot{Q}_{\text{one channel}} = 50(21.82 \text{ W}) = \mathbf{1091 \text{ W}}$$

8-71 Water is heated by passing it through five identical tubes that are maintained at a specified temperature. The rate of heat transfer and the length of the tubes necessary are to be determined.

Assumptions 1 Steady flow conditions exist. 2 The surface temperature is constant and uniform. 3 The inner surfaces of the tubes are smooth. 4 Heat transfer to the surroundings is negligible.

Properties The properties of water at the bulk mean fluid temperature of $(15+35)/2=25^\circ\text{C}$ are (Table A-9)

$$\begin{aligned}\rho &= 997 \text{ kg/m}^3 \\ k &= 0.607 \text{ W/m}\cdot^\circ\text{C} \\ \mu &= 0.891 \times 10^{-3} \text{ m}^2/\text{s} \\ c_p &= 4180 \text{ J/kg}\cdot^\circ\text{C} \\ \text{Pr} &= 6.14\end{aligned}$$

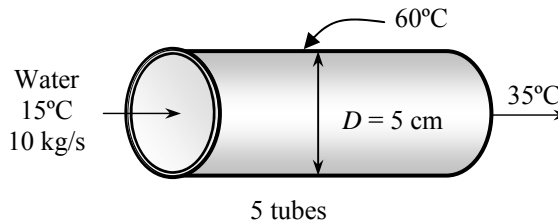

Analysis (a) The rate of heat transfer is

$$\dot{Q} = \dot{m}c_p(T_e - T_i) = (10 \text{ kg/s})(4180 \text{ J/kg}\cdot^\circ\text{C})(35 - 15)^\circ\text{C} = \mathbf{836,000 \text{ W}}$$

(b) The water velocity is

$$V = \frac{\dot{m}}{\rho A_c} = \frac{(10/5) \text{ kg/s}}{(997 \text{ kg/m}^3)\pi(0.05 \text{ m})^2/4} = 1.02 \text{ m/s}$$

The Reynolds number is

$$\text{Re} = \frac{\rho VD}{\mu} = \frac{(997 \text{ kg/m}^3)(1.02 \text{ m/s})(0.05 \text{ m})}{0.891 \times 10^{-3} \text{ kg/m}\cdot\text{s}} = 57,067$$

which is greater than 10,000. Therefore, we have turbulent flow. Assuming fully developed flow in the entire tube, the Nusselt number is determined from

$$\text{Nu} = \frac{hD_h}{k} = 0.023 \text{Re}^{0.8} \text{Pr}^{0.4} = 0.023(57,067)^{0.8} (6.14)^{0.4} = 303.5$$

Heat transfer coefficient is

$$h = \frac{k}{D} \text{Nu} = \frac{0.607 \text{ W/m}\cdot^\circ\text{C}}{0.05 \text{ m}} (303.5) = 3684 \text{ W/m}^2\cdot^\circ\text{C}$$

Using the average fluid temperature and considering that there are 5 tubes, the length of the tubes is determined as follows:

$$\dot{Q} = hA(T_s - T_{b,\text{avg}}) \longrightarrow 836,000 \text{ W} = (3684 \text{ W/m}^2\cdot^\circ\text{C})A(60 - 25)^\circ\text{C} \longrightarrow A_s = 6.484 \text{ m}^2$$

$$A = 5\pi DL \longrightarrow L = \frac{A}{5\pi D} = \frac{6.484 \text{ m}^2}{5\pi(0.05 \text{ m})} = \mathbf{8.26 \text{ m}}$$

8-72 Water is heated by passing it through five identical tubes that are maintained at a specified temperature. The rate of heat transfer and the length of the tubes necessary are to be determined.

Assumptions 1 Steady flow conditions exist. 2 The surface temperature is constant and uniform. 3 The inner surfaces of the tubes are smooth. 4 Heat transfer to the surroundings is negligible.

Properties The properties of water at the bulk mean fluid temperature of $(15+35)/2=25^\circ\text{C}$ are (Table A-9)

$$\begin{aligned}\rho &= 997 \text{ kg/m}^3 \\ k &= 0.607 \text{ W/m}\cdot^\circ\text{C} \\ \mu &= 0.891 \times 10^{-3} \text{ m}^2/\text{s} \\ c_p &= 4180 \text{ J/kg}\cdot^\circ\text{C} \\ \text{Pr} &= 6.14\end{aligned}$$

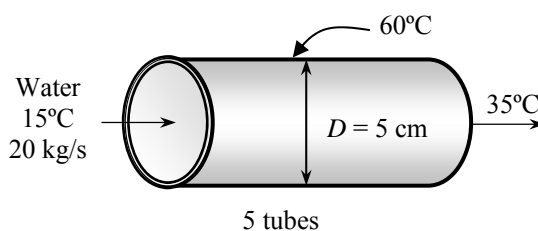

Analysis (a) The rate of heat transfer is

$$\dot{Q} = \dot{m}c_p(T_e - T_i) = (20 \text{ kg/s})(4180 \text{ J/kg}\cdot^\circ\text{C})(35 - 15)^\circ\text{C} = \mathbf{1,672,000 \text{ W}}$$

(b) The water velocity is

$$V = \frac{\dot{m}}{\rho A_c} = \frac{(20/5) \text{ kg/s}}{(997 \text{ kg/m}^3)[\pi(0.05 \text{ m})^2/4]} = 2.04 \text{ m/s}$$

The Reynolds number is

$$\text{Re} = \frac{\rho V D}{\mu} = \frac{(997 \text{ kg/m}^3)(2.04 \text{ m/s})(0.05 \text{ m})}{0.891 \times 10^{-3} \text{ kg/m}\cdot\text{s}} = 114,320$$

which is greater than 10,000. Therefore, we have turbulent flow. Assuming fully developed flow in the entire tube, the Nusselt number is determined from

$$\text{Nu} = \frac{hD_h}{k} = 0.023 \text{ Re}^{0.8} \text{ Pr}^{0.4} = 0.023(114,320)^{0.8} (6.14)^{0.4} = 529.0$$

Heat transfer coefficient is

$$h = \frac{k}{D} \text{Nu} = \frac{0.607 \text{ W/m}\cdot^\circ\text{C}}{0.05 \text{ m}} (529.0) = 6423 \text{ W/m}^2\cdot^\circ\text{C}$$

Using the average fluid temperature and considering that there are 5 tubes, the length of the tubes is determined as follows:

$$\begin{aligned}\dot{Q} &= hA(T_s - T_{b,\text{avg}}) \longrightarrow 1,672,000 \text{ W} = (6423 \text{ W/m}^2\cdot^\circ\text{C})A(60 - 25)^\circ\text{C} \longrightarrow A_s = 7.438 \text{ m}^2 \\ A &= 5\pi DL \longrightarrow L = \frac{A}{5\pi D} = \frac{7.438 \text{ m}^2}{5\pi(0.05 \text{ m})} = \mathbf{9.47 \text{ m}}\end{aligned}$$

8-73 Water is heated as it flows in a smooth tube that is maintained at a specified temperature. The necessary tube length and the water outlet temperature if the tube length is doubled are to be determined.

Assumptions **1** Steady flow conditions exist. **2** The surface temperature is constant and uniform. **3** The inner surfaces of the tube are smooth. **4** Heat transfer to the surroundings is negligible.

Properties The properties of water at the bulk mean fluid temperature of $(10+40)/2=25^\circ\text{C}$ are (Table A-9)

$$\begin{aligned}\rho &= 997 \text{ kg/m}^3 \\ k &= 0.607 \text{ W/m}\cdot^\circ\text{C} \\ \mu &= 0.891 \times 10^{-3} \text{ m}^2/\text{s} \\ c_p &= 4180 \text{ J/kg}\cdot^\circ\text{C} \\ \text{Pr} &= 6.14\end{aligned}$$

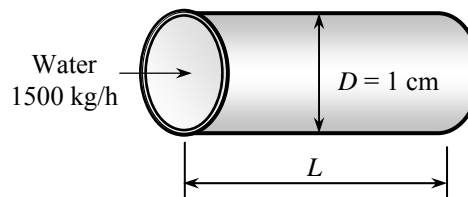

Analysis (a) The rate of heat transfer is

$$\dot{Q} = \dot{m}c_p(T_e - T_i) = (1500 / 3600 \text{ kg/s})(4180 \text{ J/kg}\cdot^\circ\text{C})(40 - 10)^\circ\text{C} = 52,250 \text{ W}$$

The water velocity is

$$V = \frac{\dot{m}}{\rho A_c} = \frac{(1500 / 3600) \text{ kg/s}}{(997 \text{ kg/m}^3) [\pi(0.01 \text{ m})^2 / 4]} = 5.32 \text{ m/s}$$

The Reynolds number is

$$\text{Re} = \frac{\rho V D}{\mu} = \frac{(997 \text{ kg/m}^3)(5.32 \text{ m/s})(0.01 \text{ m})}{0.891 \times 10^{-3} \text{ kg/m}\cdot\text{s}} = 59,542$$

which is greater than 10,000. Therefore, we have turbulent flow. Assuming fully developed flow in the entire tube, the Nusselt number is determined from

$$\text{Nu} = \frac{hD_h}{k} = 0.023 \text{ Re}^{0.8} \text{ Pr}^{0.4} = 0.023(59,542)^{0.8} (6.14)^{0.4} = 313.9$$

Heat transfer coefficient is

$$h = \frac{k}{D} \text{Nu} = \frac{0.607 \text{ W/m}\cdot^\circ\text{C}}{0.01 \text{ m}} (313.9) = 19,056 \text{ W/m}^2\cdot^\circ\text{C}$$

Using the average fluid temperature, the length of the tubes is determined as follows:

$$\begin{aligned}\dot{Q} &= hA(T_s - T_{b,\text{avg}}) \longrightarrow 52,250 \text{ W} = (19,056 \text{ W/m}^2\cdot^\circ\text{C})A(49 - 25)^\circ\text{C} \longrightarrow A_s = 0.1142 \text{ m}^2 \\ A &= \pi DL \longrightarrow 0.1142 \text{ m}^2 = \pi(0.01 \text{ m})L \longrightarrow L = \mathbf{3.6 \text{ m}}\end{aligned}$$

(b) If the tube length is doubled, the surface area doubles, and the outlet water temperature may be obtained from an energy balance to be

$$\begin{aligned}\dot{m}c_p(T_e - T_i) &= hA_s(T_s - T_{b,\text{avg}}) \\ (1500 / 3600)(4180)(T_e - 10) &= (19,056)(2 \times 0.1142) \left(49 - \frac{10 + T_e}{2} \right) \\ T_e &= 53.3^\circ\text{C}\end{aligned}$$

which is greater than the surface temperature of the wall. This is impossible. It shows that the water reaches the surface temperature before the entire length of tube is covered and in reality the water will leave the tube at the surface temperature of 49°C . This example demonstrates that the use of unnecessarily long tubes should be avoided.

8-74 Geothermal water is supplied to a city through stainless steel pipes at a specified rate. The electric power consumption and its daily cost are to be determined, and it is to be assessed if the frictional heating during flow can make up for the temperature drop caused by heat loss.

Assumptions **1** The flow is steady and incompressible. **2** The entrance effects are negligible, and thus the flow is fully developed. **3** The minor losses are negligible because of the large length-to-diameter ratio and the relatively small number of components that cause minor losses. **4** The geothermal well and the city are at about the same elevation. **5** The properties of geothermal water are the same as fresh water. **6** The fluid pressures at the wellhead and the arrival point in the city are the same.

Properties The properties of water at 110°C are $\rho = 950.6 \text{ kg/m}^3$, $\mu = 0.255 \times 10^{-3} \text{ kg/m}\cdot\text{s}$, and $c_p = 4.229 \text{ kJ/kg}\cdot^\circ\text{C}$ (Table A-9). The roughness of stainless steel pipes is $2 \times 10^{-6} \text{ m}$ (Table 8-3).

Analysis (a) We take point 1 at the well-head of geothermal resource and point 2 at the final point of delivery at the city, and the entire piping system as the control volume. Both points are at the same elevation ($z_2 = z_1$) and the same velocity ($V_1 = V_2$) since the pipe diameter is constant, and the same pressure ($P_1 = P_2$). Then the energy equation for this control volume simplifies to

$$\frac{P_1}{\rho g} + \frac{V_1^2}{2g} + z_1 + h_{\text{pump,u}} = \frac{P_2}{\rho g} + \frac{V_2^2}{2g} + z_2 + h_{\text{turbine}} + h_L \quad \rightarrow \quad h_{\text{pump,u}} = h_L$$

That is, the pumping power is to be used to overcome the head losses due to friction in flow. The mean velocity and the Reynolds number are

$$V_{\text{avg}} = \frac{\dot{V}}{A_c} = \frac{\dot{V}}{\pi D^2 / 4} = \frac{1.5 \text{ m}^3/\text{s}}{\pi (0.60 \text{ m})^2 / 4} = 5.305 \text{ m/s}$$

$$\text{Re} = \frac{\rho V_{\text{avg}} D}{\mu} = \frac{(950.6 \text{ kg/m}^3)(5.305 \text{ m/s})(0.60 \text{ m})}{0.255 \times 10^{-3} \text{ kg/m}\cdot\text{s}} = 1.186 \times 10^7$$

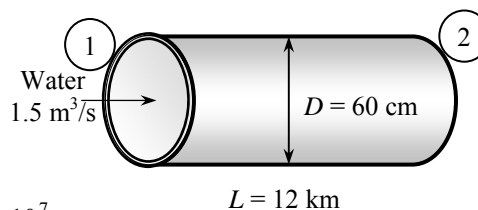

which is greater than 10,000. Therefore, the flow is turbulent. The relative roughness of the pipe is

$$\varepsilon / D = \frac{2 \times 10^{-6} \text{ m}}{0.60 \text{ m}} = 3.33 \times 10^{-6}$$

The friction factor can be determined from the Moody chart, but to avoid the reading error, we determine it from the Colebrook equation using an equation solver (or an iterative scheme),

$$\frac{1}{\sqrt{f}} = -2.0 \log \left(\frac{\varepsilon / D}{3.7} + \frac{2.51}{\text{Re} \sqrt{f}} \right) \quad \rightarrow \quad \frac{1}{\sqrt{f}} = -2.0 \log \left(\frac{3.33 \times 10^{-6}}{3.7} + \frac{2.51}{1.187 \times 10^7 \sqrt{f}} \right)$$

It gives $f = 0.00829$. Then the pressure drop, the head loss, and the required power input become

$$\Delta P = f \frac{L}{D} \frac{\rho V_{\text{avg}}^2}{2} = 0.00829 \frac{12,000 \text{ m}}{0.60 \text{ m}} \frac{(950.6 \text{ kg/m}^3)(5.305 \text{ m/s})^2}{2} \left(\frac{1 \text{ kN}}{1000 \text{ kg}\cdot\text{m/s}^2} \right) \left(\frac{1 \text{ kPa}}{1 \text{ kN/m}^2} \right) = 2218 \text{ kPa}$$

$$\dot{W}_{\text{elect}} = \frac{\dot{W}_{\text{pump,u}}}{\eta_{\text{pump-motor}}} = \frac{\dot{V} \Delta P}{\eta_{\text{pump-motor}}} = \frac{(1.5 \text{ m}^3/\text{s})(2218 \text{ kPa})}{0.65} \left(\frac{1 \text{ kW}}{1 \text{ kPa}\cdot\text{m}^3/\text{s}} \right) = \mathbf{5118 \text{ kW}}$$

Therefore, the pumps will consume 5118 kW of electric power to overcome friction and maintain flow.

(b) The daily cost of electric power consumption is determined by multiplying the amount of power used per day by the unit cost of electricity,

$$\text{Amount} = \dot{W}_{\text{elect,in}} \Delta t = (5118 \text{ kW})(24 \text{ h/day}) = 122,832 \text{ kWh/day}$$

$$\text{Cost} = \text{Amount} \times \text{Unit cost} = (122,832 \text{ kWh/day})(\$0.06/\text{kWh}) = \mathbf{\$7370/\text{day}}$$

(c) The energy consumed by the pump (except the heat dissipated by the motor to the air) is eventually dissipated as heat due to the frictional effects. Therefore, this problem is equivalent to heating the water by a 5118 kW of resistance heater (again except the heat dissipated by the motor). To be conservative, we consider only the useful mechanical energy supplied to the water by the pump. The temperature rise of water due to this addition of energy is

$$\dot{W}_{\text{elect}} = \rho \dot{V}_p \Delta T \rightarrow \Delta T = \frac{\eta_{\text{pump-motor}} \dot{W}_{\text{elect,in}}}{\rho \dot{V}_p} = \frac{0.65 \times (5118 \text{ kJ/s})}{(950.6 \text{ kg/m}^3)(1.5 \text{ m}^3/\text{s})(4.229 \text{ kJ/kg} \cdot ^\circ\text{C})} = \mathbf{0.55^\circ\text{C}}$$

Therefore, the temperature of water will rise at least 0.55°C , which is more than the 0.5°C drop in temperature (in reality, the temperature rise will be more since the energy dissipation due to pump inefficiency will also appear as temperature rise of water). Thus we conclude that the frictional heating during flow can more than make up for the temperature drop caused by heat loss.

Discussion The pumping power requirement and the associated cost can be reduced by using a larger diameter pipe. But the cost savings should be compared to the increased cost of larger diameter pipe.

8-75 Geothermal water is supplied to a city through cast iron pipes at a specified rate. The electric power consumption and its daily cost are to be determined, and it is to be assessed if the frictional heating during flow can make up for the temperature drop caused by heat loss.

Assumptions **1** The flow is steady and incompressible. **2** The entrance effects are negligible, and thus the flow is fully developed. **3** The minor losses are negligible because of the large length-to-diameter ratio and the relatively small number of components that cause minor losses. **4** The geothermal well and the city are at about the same elevation. **5** The properties of geothermal water are the same as fresh water. **6** The fluid pressures at the wellhead and the arrival point in the city are the same.

Properties The properties of water at 110°C are $\rho = 950.6 \text{ kg/m}^3$, $\mu = 0.255 \times 10^{-3} \text{ kg/m}\cdot\text{s}$, and $c_p = 4.229 \text{ kJ/kg}\cdot^\circ\text{C}$ (Table A-9). The roughness of cast iron pipes is 0.00026 m (Table 8-3).

Analysis (a) We take point 1 at the well-head of geothermal resource and point 2 at the final point of delivery at the city, and the entire piping system as the control volume. Both points are at the same elevation ($z_2 = z_1$) and the same velocity ($V_1 = V_2$) since the pipe diameter is constant, and the same pressure ($P_1 = P_2$). Then the energy equation for this control volume simplifies to

$$\frac{P_1}{\rho g} + \frac{V_1^2}{2g} + z_1 + h_{\text{pump,u}} = \frac{P_2}{\rho g} + \frac{V_2^2}{2g} + z_2 + h_{\text{turbine}} + h_L \quad \rightarrow \quad h_{\text{pump,u}} = h_L$$

That is, the pumping power is to be used to overcome the head losses due to friction in flow. The mean velocity and the Reynolds number are

$$V_{\text{avg}} = \frac{\dot{V}}{A_c} = \frac{\dot{V}}{\pi D^2 / 4} = \frac{1.5 \text{ m}^3/\text{s}}{\pi(0.60 \text{ m})^2 / 4} = 5.305 \text{ m/s}$$

$$\text{Re} = \frac{\rho V_{\text{avg}} D}{\mu} = \frac{(950.6 \text{ kg/m}^3)(5.305 \text{ m/s})(0.60 \text{ m})}{0.255 \times 10^{-3} \text{ kg/m}\cdot\text{s}} = 1.187 \times 10^7$$

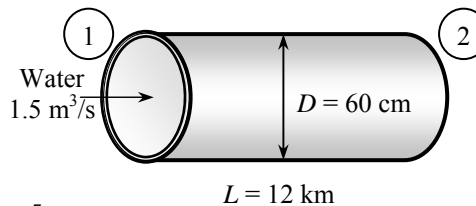

which is greater than 10,000. Therefore, the flow is turbulent. The relative roughness of the pipe is

$$\varepsilon / D = \frac{0.00026 \text{ m}}{0.60 \text{ m}} = 4.33 \times 10^{-4}$$

The friction factor can be determined from the Moody chart, but to avoid the reading error, we determine it from the Colebrook equation using an equation solver (or an iterative scheme),

$$\frac{1}{\sqrt{f}} = -2.0 \log \left(\frac{\varepsilon / D}{3.7} + \frac{2.51}{\text{Re} \sqrt{f}} \right) \quad \rightarrow \quad \frac{1}{\sqrt{f}} = -2.0 \log \left(\frac{4.33 \times 10^{-4}}{3.7} + \frac{2.51}{1.187 \times 10^7 \sqrt{f}} \right)$$

It gives $f = 0.01623$. Then the pressure drop, the head loss, and the required power input become

$$\Delta P = f \frac{L}{D} \frac{\rho V_{\text{avg}}^2}{2} = 0.01623 \frac{12,000 \text{ m}}{0.60 \text{ m}} \frac{(950.6 \text{ kg/m}^3)(5.305 \text{ m/s})^2}{2} \left(\frac{1 \text{ kN}}{1000 \text{ kg}\cdot\text{m/s}^2} \right) \left(\frac{1 \text{ kPa}}{1 \text{ kN/m}^2} \right) = 4342 \text{ kPa}$$

$$\dot{W}_{\text{elect}} = \frac{\dot{W}_{\text{pump,u}}}{\eta_{\text{pump-motor}}} = \frac{\dot{V} \Delta P}{\eta_{\text{pump-motor}}} = \frac{(1.5 \text{ m}^3/\text{s})(4342 \text{ kPa})}{0.65} \left(\frac{1 \text{ kW}}{1 \text{ kPa}\cdot\text{m}^3/\text{s}} \right) = \mathbf{10,020 \text{ kW}}$$

Therefore, the pumps will consume 10,017 W of electric power to overcome friction and maintain flow.

(b) The daily cost of electric power consumption is determined by multiplying the amount of power used per day by the unit cost of electricity,

$$\text{Amount} = \dot{W}_{\text{elect,in}} \Delta t = (10,020 \text{ kW})(24 \text{ h/day}) = 240,480 \text{ kWh/day}$$

$$\text{Cost} = \text{Amount} \times \text{Unit cost} = (240,480 \text{ kWh/day})(\$0.06/\text{kWh}) = \mathbf{\$14,430/\text{day}}$$

(c) The energy consumed by the pump (except the heat dissipated by the motor to the air) is eventually dissipated as heat due to the frictional effects. Therefore, this problem is equivalent to heating the water by a 10,020 kW of resistance heater (again except the heat dissipated by the motor). To be conservative, we consider only the useful mechanical energy supplied to the water by the pump. The temperature rise of water due to this addition of energy is

$$\dot{W}_{\text{elect}} = \rho \dot{V}_p \Delta T \rightarrow \Delta T = \frac{\eta_{\text{pump-motor}} \dot{W}_{\text{elect,in}}}{\rho \dot{V}_p} = \frac{0.65 \times (10,020 \text{ kJ/s})}{(950.6 \text{ kg/m}^3)(1.5 \text{ m}^3/\text{s})(4.229 \text{ kJ/kg} \cdot ^\circ\text{C})} = \mathbf{1.08^\circ\text{C}}$$

Therefore, the temperature of water will rise at least 1.08°C, which is more than the 0.5°C drop in temperature (in reality, the temperature rise will be more since the energy dissipation due to pump inefficiency will also appear as temperature rise of water). Thus we conclude that the frictional heating during flow can more than make up for the temperature drop caused by heat loss.

Discussion The pumping power requirement and the associated cost can be reduced by using a larger diameter pipe. But the cost savings should be compared to the increased cost of larger diameter pipe.

8-76 The velocity profile in fully developed laminar flow in a circular pipe is given. The radius of the pipe, the mean velocity, and the maximum velocity are to be determined.

Assumptions The flow is steady, laminar, and fully developed.

Analysis The velocity profile in fully developed laminar flow in a circular pipe is

$$u(r) = V_{\text{max}} \left(1 - \frac{r^2}{R^2} \right)$$

The velocity profile in this case is given by

$$u(r) = 6(1 - 100r^2)$$

Comparing the two relations above gives the pipe radius, the maximum velocity, and the mean velocity to be

$$R^2 = \frac{1}{100} \quad \rightarrow \quad R = \mathbf{0.10 \text{ m}}$$

$$V_{\text{max}} = \mathbf{6 \text{ m/s}}$$

$$V_{\text{avg}} = \frac{V_{\text{max}}}{2} = \frac{6 \text{ m/s}}{2} = \mathbf{3 \text{ m/s}}$$

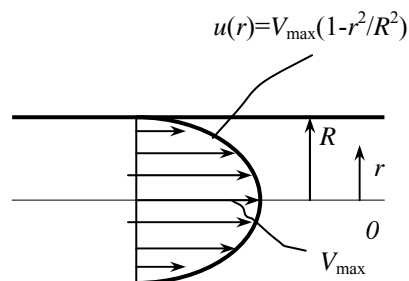

8-77E The velocity profile in fully developed laminar flow in a circular pipe is given. The volume flow rate, the pressure drop, and the useful pumping power required to overcome this pressure drop are to be determined.

Assumptions **1** The flow is steady, laminar, and fully developed. **2** The pipe is horizontal.

Properties The density and dynamic viscosity of water at 40°F are $\rho = 62.42 \text{ lbm/ft}^3$ and $\mu = 1.308 \times 10^{-3} \text{ lbm/ft}\cdot\text{s}$, respectively (Table A-9E).

Analysis The velocity profile in fully developed laminar flow in a circular pipe is

$$u(r) = V_{\max} \left(1 - \frac{r^2}{R^2} \right)$$

The velocity profile in this case is given by

$$u(r) = 0.8(1 - 625r^2)$$

Comparing the two relations above gives the pipe radius, the maximum velocity, and the mean velocity to be

$$R^2 = \frac{1}{625} \quad \rightarrow \quad R = 0.04 \text{ ft}$$

$$V_{\max} = 0.8 \text{ ft/s}$$

$$V_{\text{avg}} = \frac{V_{\max}}{2} = \frac{0.8 \text{ ft/s}}{2} = 0.4 \text{ ft/s}$$

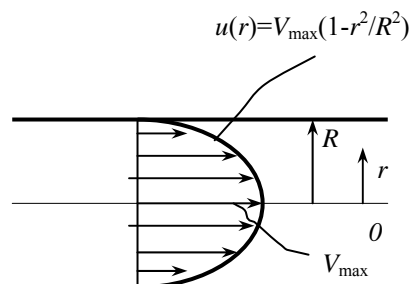

Then the volume flow rate and the pressure drop become

$$\dot{V} = V_{\text{avg}} A_c = V_{\text{avg}} (\pi R^2) = (0.4 \text{ ft/s}) [\pi (0.04 \text{ ft})^2] = \mathbf{0.00201 \text{ ft}^3/\text{s}}$$

$$\dot{V}_{\text{horiz}} = \frac{\Delta P \pi D^4}{128 \mu L} \quad \rightarrow \quad 0.00201 \text{ ft}^3/\text{s} = \frac{(\Delta P) \pi (0.08 \text{ ft})^4}{128 (1.308 \times 10^{-3} \text{ lbm/ft}\cdot\text{s}) (140 \text{ ft})} \left(\frac{32.2 \text{ lbm}\cdot\text{ft/s}^2}{1 \text{ lbf}} \right)$$

It gives

$$\Delta P = 11.37 \text{ lbf/ft}^2 = \mathbf{0.0790 \text{ psi}}$$

Then the useful pumping power requirement becomes

$$\dot{W}_{\text{pump,u}} = \dot{V} \Delta P = (0.00201 \text{ ft}^3/\text{s}) (11.37 \text{ lbf/ft}^2) \left(\frac{1 \text{ W}}{0.737 \text{ lbf}\cdot\text{ft/s}} \right) = \mathbf{0.031 \text{ W}}$$

Checking The flow was assumed to be laminar. To verify this assumption, we determine the Reynolds number:

$$\text{Re} = \frac{\rho V_{\text{avg}} D}{\mu} = \frac{(62.42 \text{ lbm/ft}^3) (0.4 \text{ ft/s}) (0.08 \text{ ft})}{1.308 \times 10^{-3} \text{ lbm/ft}\cdot\text{s}} = 1527$$

which is less than 2300. Therefore, the flow is laminar.

Discussion Note that the pressure drop across the water pipe and the required power input to maintain flow is negligible. This is due to the very low flow velocity. Such water flows are the exception in practice rather than the rule.

8-78 A compressor is connected to the outside through a circular duct. The power used by compressor to overcome the pressure drop, the rate of heat transfer, and the temperature rise of air are to be determined.

Assumptions 1 Steady flow conditions exist. 2 The inner surfaces of the duct are smooth. 3 The thermal resistance of the duct is negligible. 4 Air is an ideal gas with constant properties.

Properties We take the bulk mean temperature for air to be 15°C since the mean temperature of air at the inlet will rise somewhat as a result of heat gain through the duct whose surface is exposed to a higher temperature. The properties of air at this temperature and 1 atm pressure are (Table A-15)

$$\rho = 1.225 \text{ kg/m}^3, \quad k = 0.02476 \text{ W/m}\cdot\text{°C}$$

$$\nu = 1.470 \times 10^{-5} \text{ m}^2/\text{s}, \quad c_p = 1007 \text{ J/kg}\cdot\text{°C}, \quad \text{Pr} = 0.7323$$

The density and kinematic viscosity at 95 kPa are

$$P = \frac{95 \text{ kPa}}{101.325 \text{ kPa}} = 0.938 \text{ atm}$$

$$\rho = (1.225 \text{ kg/m}^3)(0.938) = 1.149 \text{ kg/m}^3$$

$$\nu = (1.470 \times 10^{-5} \text{ m}^2/\text{s})/(0.938) = 1.378 \times 10^{-5} \text{ m}^2/\text{s}$$

Analysis The mean velocity of air is

$$V_{\text{avg}} = \frac{\dot{V}}{A_c} = \frac{0.27 \text{ m}^3/\text{s}}{\pi(0.2 \text{ m})^2/4} = 8.594 \text{ m/s}$$

$$\text{Then } \text{Re} = \frac{V_{\text{avg}} D_h}{\nu} = \frac{(8.594 \text{ m/s})(0.2 \text{ m})}{1.378 \times 10^{-5} \text{ m}^2/\text{s}} = 1.247 \times 10^5$$

which is greater than 10,000. Therefore, the flow is turbulent and the entry lengths in this case are roughly

$$L_h \approx L_t \approx 10D = 10(0.2 \text{ m}) = 2 \text{ m}$$

which is shorter than the total length of the duct. Therefore, we assume fully developed flow in a smooth pipe, and determine friction factor from

$$f = (0.790 \ln \text{Re} - 1.64)^{-2} = [0.790 \ln(1.247 \times 10^5) - 1.64]^{-2} = 0.01718$$

The pressure drop and the compressor power required to overcome this pressure drop are

$$\dot{m} = \rho \dot{V} = (1.149 \text{ kg/m}^3)(0.27 \text{ m}^3/\text{s}) = 0.3102 \text{ kg/s}$$

$$\Delta P = f \frac{L}{D} \frac{\rho V_{\text{avg}}^2}{2} = (0.01718) \frac{(11 \text{ m})}{(0.2 \text{ m})} \frac{(1.149 \text{ kg/m}^3)(8.594 \text{ m/s})^2}{2} = 40.09 \text{ N/m}^2$$

$$\dot{W}_{\text{pump}} = \frac{\dot{m} \Delta P}{\rho} = \frac{(0.3102 \text{ kg/s})(40.09 \text{ N/m}^2)}{1.149 \text{ kg/m}^3} = \mathbf{10.8 \text{ W}}$$

(b) For the fully developed turbulent flow, the Nusselt number is

$$\text{Nu} = \frac{hD}{k} = 0.023 \text{Re}^{0.8} \text{Pr}^{0.4} = 0.023(1.247 \times 10^5)^{0.8} (0.7323)^{0.4} = 242.3$$

$$\text{and } h = \frac{k}{D_h} \text{Nu} = \frac{0.02476 \text{ W/m}\cdot\text{°C}}{0.2 \text{ m}} (242.3) = 30.00 \text{ W/m}^2\cdot\text{°C}$$

Disregarding the thermal resistance of the duct, the rate of heat transfer to the air in the duct becomes

$$A_s = \pi DL = \pi(0.2 \text{ m})(11 \text{ m}) = 6.912 \text{ m}^2$$

$$\dot{Q} = \frac{T_{\infty 1} - T_{\infty 2}}{\frac{1}{h_1 A_s} + \frac{1}{h_2 A_s}} = \frac{20 - 10}{\frac{1}{(30.00)(6.912)} + \frac{1}{(10)(6.912)}} = \mathbf{518.4 \text{ W}}$$

(c) The temperature rise of air in the duct is

$$\dot{Q} = \dot{m} c_p \Delta T \rightarrow 518.4 \text{ W} = (0.3102 \text{ kg/s})(1007 \text{ J/kg}\cdot\text{°C})\Delta T \rightarrow \Delta T = \mathbf{1.7\text{°C}}$$

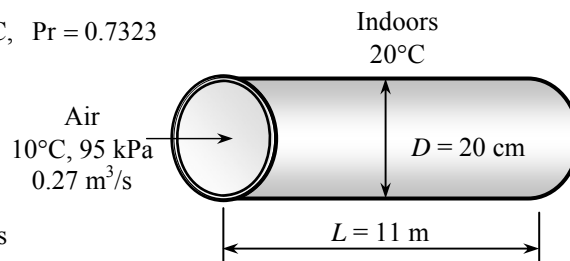

8-79 Air enters the underwater section of a duct. The outlet temperature of the air and the fan power needed to overcome the flow resistance are to be determined.

Assumptions 1 Steady flow conditions exist. 2 The inner surfaces of the duct are smooth. 3 The thermal resistance of the duct is negligible. 4 The surface of the duct is at the temperature of the water. 5 Air is an ideal gas with constant properties. 6 The pressure of air is 1 atm.

Properties We assume the bulk mean temperature for air to be 20°C since the mean temperature of air at the inlet will drop somewhat as a result of heat loss through the duct whose surface is at a lower temperature. The properties of air at 1 atm and this temperature are (Table A-15)

$$\begin{aligned}\rho &= 1.204 \text{ kg/m}^3 \\ k &= 0.02514 \text{ W/m}\cdot\text{°C} \\ \nu &= 1.516 \times 10^{-5} \text{ m}^2/\text{s} \\ c_p &= 1007 \text{ J/kg}\cdot\text{°C} \\ \text{Pr} &= 0.7309\end{aligned}$$

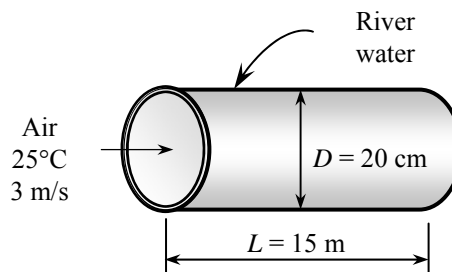

Analysis The Reynolds number is

$$\text{Re} = \frac{V_{\text{avg}} D_h}{\nu} = \frac{(3 \text{ m/s})(0.2 \text{ m})}{1.516 \times 10^{-5} \text{ m}^2/\text{s}} = 3.958 \times 10^4$$

which is greater than 10,000. Therefore, the flow is turbulent and the entry lengths in this case are roughly

$$L_h \approx L_t \approx 10D = 10(0.2 \text{ m}) = 2 \text{ m}$$

which is much shorter than the total length of the duct. Therefore, we can assume fully developed turbulent flow in the entire duct, and determine the Nusselt number from

$$\text{Nu} = \frac{hD_h}{k} = 0.023 \text{Re}^{0.8} \text{Pr}^{0.3} = 0.023(3.958 \times 10^4)^{0.8} (0.7309)^{0.3} = 99.76$$

and

$$h = \frac{k}{D_h} \text{Nu} = \frac{0.02514 \text{ W/m}\cdot\text{°C}}{0.2 \text{ m}} (99.76) = 12.54 \text{ W/m}^2\cdot\text{°C}$$

Next we determine the exit temperature of air,

$$A_s = \pi DL = \pi(0.2 \text{ m})(15 \text{ m}) = 9.425 \text{ m}^2$$

$$\dot{m} = \rho V_{\text{avg}} A_c = (1.204 \text{ kg/m}^3)(3 \text{ m/s}) \left(\frac{\pi(0.2 \text{ m})^2}{4} \right) = (1.204 \text{ kg/m}^3)(0.09425 \text{ m}^3/\text{s}) = 0.1135 \text{ kg/s}$$

and

$$T_e = T_s - (T_s - T_i) e^{-hA_s / (\dot{m}c_p)} = 15 - (15 - 25) e^{-\frac{(12.54)(9.425)}{(0.1135)(1007)}} = \mathbf{18.6^\circ\text{C}}$$

The friction factor, pressure drop, and the fan power required to overcome this pressure drop can be determined for the case of fully developed turbulent flow in smooth pipes to be

$$f = (0.790 \ln \text{Re} - 1.64)^{-2} = \left[0.790 \ln(3.958 \times 10^4) - 1.64 \right]^{-2} = 0.02212$$

$$\Delta P = f \frac{L}{D} \frac{\rho V_{\text{avg}}^2}{2} = 0.02212 \frac{15 \text{ m}}{0.2 \text{ m}} \frac{(1.204 \text{ kg/m}^3)(3 \text{ m/s})^2}{2} \left(\frac{1 \text{ N}}{1 \text{ kg}\cdot\text{m/s}^2} \right) \left(\frac{1 \text{ Pa}}{1 \text{ N/m}^2} \right) = 8.988 \text{ Pa}$$

$$\dot{W}_{\text{fan}} = \frac{\dot{W}_{\text{pump,u}}}{\eta_{\text{pump-motor}}} = \frac{\dot{V}\Delta P}{\eta_{\text{pump-motor}}} = \frac{(0.09425 \text{ m}^3/\text{s})(8.988 \text{ Pa})}{0.55} = \left(\frac{1 \text{ W}}{1 \text{ Pa}\cdot\text{m}^3/\text{s}} \right) = \mathbf{1.54 \text{ W}}$$

8-80 Air enters the underwater section of a duct. The outlet temperature of the air and the fan power needed to overcome the flow resistance are to be determined.

Assumptions 1 Steady flow conditions exist. 2 The inner surfaces of the duct are smooth. 3 The thermal resistance of the duct is negligible. 4 Air is an ideal gas with constant properties. 5 The pressure of air is 1 atm.

Properties We assume the bulk mean temperature for air to be 20°C since the mean temperature of air at the inlet will drop somewhat as a result of heat loss through the duct whose surface is at a lower temperature. The properties of air at 1 atm and this temperature are (Table A-15)

$$\begin{aligned}\rho &= 1.204 \text{ kg/m}^3 \\ k &= 0.02514 \text{ W/m}\cdot^\circ\text{C} \\ \nu &= 1.516 \times 10^{-5} \text{ m}^2/\text{s} \\ c_p &= 1007 \text{ J/kg}\cdot^\circ\text{C} \\ \text{Pr} &= 0.7309\end{aligned}$$

Analysis The Reynolds number is

$$\text{Re} = \frac{V_{\text{avg}} D_h}{\nu} = \frac{(3 \text{ m/s})(0.2 \text{ m})}{1.516 \times 10^{-5} \text{ m}^2/\text{s}} = 3.958 \times 10^4$$

which is greater than 10,000. Therefore, the flow is turbulent and the entry lengths in this case are roughly $L_h \approx L_t \approx 10D = 10(0.2 \text{ m}) = 2 \text{ m}$

which is much shorter than the total length of the duct. Therefore, we can assume fully developed turbulent flow in the entire duct, and determine the Nusselt number and h from

$$\text{Nu} = \frac{hD_h}{k} = 0.023 \text{Re}^{0.8} \text{Pr}^{0.3} = 0.023(3.958 \times 10^4)^{0.8} (0.7309)^{0.3} = 99.76$$

$$\text{and } h = \frac{k}{D_h} \text{Nu} = \frac{0.02514 \text{ W/m}\cdot^\circ\text{C}}{0.2 \text{ m}} (99.76) = 12.54 \text{ W/m}^2\cdot^\circ\text{C}$$

Next we determine the exit temperature of air,

$$A_s = \pi DL = \pi(0.2 \text{ m})(15 \text{ m}) = 9.425 \text{ m}^2$$

$$\dot{m} = \rho V_{\text{avg}} A_c = (1.204 \text{ kg/m}^3)(3 \text{ m/s}) \left(\frac{\pi(0.2 \text{ m})^2}{4} \right) = (1.204 \text{ kg/m}^3)(0.09425 \text{ m}^3/\text{s}) = 0.1135 \text{ kg/s}$$

The unit thermal resistance of the mineral deposit is

$$R_{\text{mineral}} = \frac{L}{k} = \frac{0.0025 \text{ m}}{3 \text{ W/m}\cdot^\circ\text{C}} = 0.00083 \text{ m}^2\cdot^\circ\text{C}/\text{W}$$

which is much less than (about 1%) the unit convection resistance,

$$R_{\text{conv}} = \frac{1}{h} = \frac{1}{12.54 \text{ W/m}^2\cdot^\circ\text{C}} = 0.0797 \text{ m}^2\cdot^\circ\text{C}/\text{W}$$

Therefore, the effect of 0.25 mm thick mineral deposit on heat transfer is negligible.

Next we determine the exit temperature of air

$$T_e = T_s - (T_s - T_i) e^{-\frac{hA}{\dot{m}c_p}} = 15 - (15 - 25) e^{-\frac{(12.54)(9.425)}{(0.1135)(1007)}} = \mathbf{18.6^\circ\text{C}}$$

The friction factor, pressure drop, and the fan power required to overcome this pressure drop can be determined for the case of fully developed turbulent flow in smooth pipes to be

$$f = (0.790 \ln \text{Re} - 1.64)^{-2} = \left[0.790 \ln(3.958 \times 10^4) - 1.64 \right]^{-2} = 0.02212$$

$$\Delta P = f \frac{L}{D} \frac{\rho V_{\text{avg}}^2}{2} = 0.02212 \frac{15 \text{ m}}{0.2 \text{ m}} \frac{(1.204 \text{ kg/m}^3)(3 \text{ m/s})^2}{2} \left(\frac{1 \text{ N}}{1 \text{ kg}\cdot\text{m/s}^2} \right) \left(\frac{1 \text{ Pa}}{1 \text{ N/m}^2} \right) = 8.988 \text{ Pa}$$

$$\dot{W}_{\text{fan}} = \frac{\dot{W}_{\text{pump,u}}}{\eta_{\text{pump-motor}}} = \frac{\dot{V} \Delta P}{\eta_{\text{pump-motor}}} = \frac{(0.09425 \text{ m}^3/\text{s})(8.988 \text{ Pa})}{0.55} = \left(\frac{1 \text{ W}}{1 \text{ Pa}\cdot\text{m}^3/\text{s}} \right) = \mathbf{1.54 \text{ W}}$$

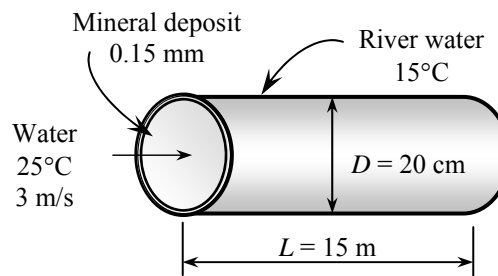

8-81E The exhaust gases of an automotive engine enter a steel exhaust pipe. The velocity of exhaust gases at the inlet and the temperature of exhaust gases at the exit are to be determined.

Assumptions 1 Steady flow conditions exist. 2 The inner surfaces of the pipe are smooth. 3 The thermal resistance of the pipe is negligible. 4 Exhaust gases have the properties of air, which is an ideal gas with constant properties.

Properties We take the bulk mean temperature for exhaust gases to be 700°C since the mean temperature of gases at the inlet will drop somewhat as a result of heat loss through the exhaust pipe whose surface is at a lower temperature. The properties of air at this temperature and 1 atm pressure are (Table A-15)

$$\rho = 0.03421 \text{ lbm/ft}^3 \quad c_p = 0.2535 \text{ Btu/lbm}\cdot^\circ\text{F}$$

$$k = 0.0280 \text{ Btu/h}\cdot\text{ft}\cdot^\circ\text{F} \quad \text{Pr} = 0.694$$

$$\nu = 6.225 \times 10^{-4} \text{ ft}^2/\text{s}$$

Noting that 1 atm = 14.7 psia, the pressure in atm is

$$P = (15.5 \text{ psia}) / (14.7 \text{ psia}) = 1.054 \text{ atm. Then,}$$

$$\rho = (0.03421 \text{ lbm/ft}^3)(1.054) = 0.03606 \text{ lbm/ft}^3$$

$$\nu = (6.225 \times 10^{-4} \text{ ft}^2/\text{s}) / (1.054) = 5.906 \times 10^{-4} \text{ ft}^2/\text{s}$$

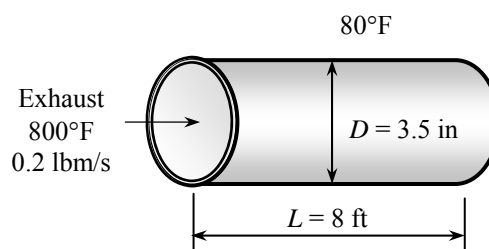

Analysis (a) The velocity of exhaust gases at the inlet of the exhaust pipe is

$$\dot{m} = \rho V_{\text{avg}} A_c \longrightarrow V_{\text{avg}} = \frac{\dot{m}}{\rho A_c} = \frac{0.2 \text{ lbm/s}}{(0.03606 \text{ lbm/ft}^3)(\pi(3.5/12 \text{ ft})^2 / 4)} = \mathbf{83.01 \text{ ft/s}}$$

(b) The Reynolds number is

$$\text{Re} = \frac{V_{\text{avg}} D_h}{\nu} = \frac{(83.01 \text{ ft/s})(3.5/12 \text{ ft})}{5.906 \times 10^{-4} \text{ ft}^2/\text{s}} = 40,990$$

which is greater than 10,000. Therefore, the flow is turbulent and the entry lengths in this case are roughly

$$L_h \approx L_t \approx 10D = 10(3.5/12 \text{ ft}) = 2.917 \text{ ft}$$

which are shorter than the total length of the duct. Therefore, we can assume fully developed turbulent flow in the entire duct, and determine the Nusselt number from

$$\text{Nu} = \frac{hD_h}{k} = 0.023 \text{Re}^{0.8} \text{Pr}^{0.3} = 0.023(40,990)^{0.8} (0.694)^{0.3} = 101.0$$

and
$$h_i = h = \frac{k}{D_h} \text{Nu} = \frac{0.0280 \text{ Btu/h}\cdot\text{ft}\cdot^\circ\text{F}}{(3.5/12 \text{ ft})} (101.0) = 9.70 \text{ Btu/h}\cdot\text{ft}^2\cdot^\circ\text{F}$$

$$A_s = \pi DL = \pi(3.5/12 \text{ ft})(8 \text{ ft}) = 7.33 \text{ ft}^2$$

In steady operation, heat transfer from exhaust gases to the duct must be equal to the heat transfer from the duct to the surroundings, which must be equal to the energy loss of the exhaust gases in the pipe. That is,

$$\dot{Q} = \dot{Q}_{\text{internal}} = \dot{Q}_{\text{external}} = \Delta \dot{E}_{\text{exhaust gases}}$$

Assuming the duct to be at an average temperature of T_s , the quantities above can be expressed as

$$\dot{Q}_{\text{internal}}: \quad \dot{Q} = h_i A_s \Delta T_{\ln} = h_i A_s \frac{T_e - T_i}{\ln\left(\frac{T_s - T_e}{T_s - T_i}\right)} \rightarrow \dot{Q} = (9.70 \text{ Btu/h}\cdot\text{ft}^2\cdot^\circ\text{F})(7.33 \text{ ft}^2) \frac{T_e - 800^\circ\text{F}}{\ln\left(\frac{T_s - T_e}{T_s - 800}\right)}$$

$$\dot{Q}_{\text{external}}: \quad \dot{Q} = h_o A_s (T_s - T_o) \rightarrow \dot{Q} = (3 \text{ Btu/h}\cdot\text{ft}^2\cdot^\circ\text{F})(7.33 \text{ ft}^2)(T_s - 80)^\circ\text{F}$$

$$\Delta \dot{E}_{\text{exhaust gases}}: \quad \dot{Q} = \dot{m} c_p (T_e - T_i) \rightarrow \dot{Q} = (0.2 \times 3600 \text{ lbm/h})(0.2535 \text{ Btu/lbm}\cdot^\circ\text{F})(800 - T_e)^\circ\text{F}$$

This is a system of three equations with three unknowns whose solution is

$$\dot{Q} = 11,528 \text{ Btu/h}, \quad T_e = \mathbf{736.8^\circ\text{F}}, \quad \text{and} \quad T_s = 604.2^\circ\text{F}$$

8-82 Hot water enters a cast iron pipe whose outer surface is exposed to cold air with a specified heat transfer coefficient. The rate of heat loss from the water and the exit temperature of the water are to be determined.

Assumptions 1 Steady flow conditions exist. **2** The inner surfaces of the pipe are smooth.

Properties We assume the water temperature not to drop significantly since the pipe is not very long. We will check this assumption later. The properties of water at 90°C are (Table A-9)

$$\rho = 965.3 \text{ kg/m}^3; \quad k = 0.675 \text{ W/m} \cdot ^\circ\text{C}$$

$$\nu = \mu / \rho = 0.326 \times 10^{-6} \text{ m}^2/\text{s}; \quad c_p = 4206 \text{ J/kg} \cdot ^\circ\text{C}$$

$$\text{Pr} = 1.96$$

Analysis (a) The mass flow rate of water is

$$\dot{m} = \rho A_c V_{\text{avg}} = (965.3 \text{ kg/m}^3) \frac{\pi(0.04 \text{ m})^2}{4} (1.2 \text{ m/s}) = 1.456 \text{ kg/s}$$

The Reynolds number is

$$\text{Re} = \frac{V_{\text{avg}} D_h}{\nu} = \frac{(1.2 \text{ m/s})(0.04 \text{ m})}{0.326 \times 10^{-6} \text{ m}^2/\text{s}} = 147,240$$

which is greater than 10,000. Therefore, the flow is turbulent and the entry lengths in this case are roughly

$$L_h \approx L_t \approx 10D = 10(0.04 \text{ m}) = 0.4 \text{ m}$$

which are much shorter than the total length of the pipe. Therefore, we can assume fully developed turbulent flow in the entire pipe. The friction factor corresponding to $\text{Re} = 147,240$ and $\varepsilon/D = (0.026 \text{ cm})/(4 \text{ cm}) = 0.0065$ is determined from the Moody chart to be $f = 0.032$. Then the Nusselt number becomes

$$\text{Nu} = \frac{hD_h}{k} = 0.125 f \text{Re} \text{Pr}^{1/3} = 0.125 \times 0.032 \times 147,240 \times 1.96^{1/3} = 737.1$$

$$\text{and } h_i = h = \frac{k}{D_h} \text{Nu} = \frac{0.675 \text{ W/m} \cdot ^\circ\text{C}}{0.04 \text{ m}} (737.1) = 12,440 \text{ W/m}^2 \cdot ^\circ\text{C}$$

which is much greater than the convection heat transfer coefficient of $12 \text{ W/m}^2 \cdot ^\circ\text{C}$. Therefore, the convection thermal resistance inside the pipe is negligible, and thus the inner surface temperature of the pipe can be taken to be equal to the water temperature. Also, we expect the pipe to be nearly isothermal since it is made of thin metal (we check this later). Then the rate of heat loss from the pipe will be the sum of the convection and radiation from the outer surface at a temperature of 90°C, and is determined to be

$$A_o = \pi D_o L = \pi(0.046 \text{ m})(15 \text{ m}) = 2.168 \text{ m}^2$$

$$\dot{Q}_{\text{conv}} = h_o A_o (T_s - T_{\text{surr}}) = (12 \text{ W/m}^2 \cdot ^\circ\text{C})(2.168 \text{ m}^2)(90 - 10)^\circ\text{C} = 2081 \text{ W}$$

$$\dot{Q}_{\text{rad}} = \varepsilon A_o \sigma (T_s^4 - T_{\text{surr}}^4)$$

$$= (0.7)(2.168 \text{ m}^2)(5.67 \times 10^{-8} \text{ W/m}^2 \cdot \text{K}^4) [(90 + 273 \text{ K})^4 - (10 + 273 \text{ K})^4] = 942 \text{ W}$$

$$\dot{Q}_{\text{total}} = \dot{Q}_{\text{conv}} + \dot{Q}_{\text{rad}} = 2081 + 942 = \mathbf{3023 \text{ W}}$$

(b) The temperature at which water leaves the basement is

$$\dot{Q} = \dot{m} c_p (T_i - T_e) \longrightarrow T_e = T_i - \frac{\dot{Q}}{\dot{m} c_p} = 90^\circ\text{C} - \frac{3023 \text{ W}}{(1.456 \text{ kg/s})(4206 \text{ J/kg} \cdot ^\circ\text{C})} = \mathbf{89.5^\circ\text{C}}$$

The result justifies our assumption that the temperature drop of water is negligible. Also, the thermal resistance of the pipe and temperature drop across it are

$$R_{\text{pipe}} = \frac{\ln(D_2 / D_1)}{2\pi k L} = \frac{\ln(4.6 / 4)}{4\pi(52 \text{ W/m} \cdot ^\circ\text{C})(15 \text{ m})} = 2.85 \times 10^{-5} \text{ } ^\circ\text{C/W}$$

$$\Delta T_{\text{pipe}} = \dot{Q}_{\text{total}} R_{\text{pipe}} = (3023 \text{ W})(2.85 \times 10^{-5} \text{ } ^\circ\text{C/W}) = 0.09^\circ\text{C}$$

which justifies our assumption that the temperature drop across the pipe is negligible.

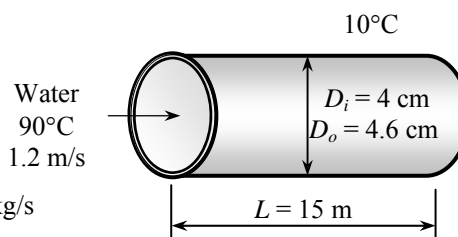

8-83 Hot water enters a copper pipe whose outer surface is exposed to cold air with a specified heat transfer coefficient. The rate of heat loss from the water and the exit temperature of the water are to be determined.

Assumptions 1 Steady flow conditions exist. **2** The inner surfaces of the pipe are smooth.

Properties We assume the water temperature not to drop significantly since the pipe is not very long. We will check this assumption later. The properties of water at 90°C are (Table A-15)

$$\rho = 965.3 \text{ kg/m}^3; \quad k = 0.675 \text{ W/m}\cdot^\circ\text{C}$$

$$\nu = \mu / \rho = 0.326 \times 10^{-6} \text{ m}^2/\text{s}; \quad c_p = 4206 \text{ J/kg}\cdot^\circ\text{C}$$

$$\text{Pr} = 1.96$$

Analysis (a) The mass flow rate of water is

$$\dot{m} = \rho A_c V_{\text{avg}} = (965.3 \text{ kg/m}^3) \frac{\pi(0.04 \text{ m})^2}{4} (1.2 \text{ m/s}) = 1.456 \text{ kg/s}$$

The Reynolds number is

$$\text{Re} = \frac{V_{\text{avg}} D_h}{\nu} = \frac{(1.2 \text{ m/s})(0.04 \text{ m})}{0.326 \times 10^{-6} \text{ m}^2/\text{s}} = 147,240$$

which is greater than 10,000. Therefore, the flow is turbulent and the entry lengths in this case are roughly

$$L_h \approx L_t \approx 10D = 10(0.04 \text{ m}) = 0.4 \text{ m}$$

which are much shorter than the total length of the pipe. Therefore, we can assume fully developed turbulent flow in the entire pipe. The friction factor corresponding to $\text{Re} = 147,240$ and $\varepsilon/D = (0.026 \text{ cm})/(4 \text{ cm}) = 0.0065$ is determined from the Moody chart to be $f = 0.032$. Then the Nusselt number becomes

$$\text{Nu} = \frac{hD_h}{k} = 0.125 f \text{ Re Pr}^{1/3} = 0.125 \times 0.032 \times 147,240 \times 1.96^{1/3} = 737.1$$

$$\text{and } h_i = h = \frac{k}{D_h} \text{Nu} = \frac{0.675 \text{ W/m}\cdot^\circ\text{C}}{0.04 \text{ m}} (737.1) = 12,440 \text{ W/m}^2\cdot^\circ\text{C}$$

which is much greater than the convection heat transfer coefficient of $12 \text{ W/m}^2\cdot^\circ\text{C}$. Therefore, the convection thermal resistance inside the pipe is negligible, and thus the inner surface temperature of the pipe can be taken to be equal to the water temperature. Also, we expect the pipe to be nearly isothermal since it is made of thin metal (we check this later). Then the rate of heat loss from the pipe will be the sum of the convection and radiation from the outer surface at a temperature of 90°C, and is determined to be

$$A_o = \pi D_o L = \pi(0.046 \text{ m})(15 \text{ m}) = 2.168 \text{ m}^2$$

$$\dot{Q}_{\text{conv}} = h_o A_o (T_s - T_{\text{surr}}) = (12 \text{ W/m}^2\cdot^\circ\text{C})(2.168 \text{ m}^2)(90 - 10)^\circ\text{C} = 2081 \text{ W}$$

$$\dot{Q}_{\text{rad}} = \varepsilon A_o \sigma (T_s^4 - T_{\text{surr}}^4)$$

$$= (0.7)(2.168 \text{ m}^2)(5.67 \times 10^{-8} \text{ W/m}^2\cdot\text{K}^4) [(90 + 273 \text{ K})^4 - (10 + 273 \text{ K})^4] = 942 \text{ W}$$

$$\dot{Q}_{\text{total}} = \dot{Q}_{\text{conv}} + \dot{Q}_{\text{rad}} = 2081 + 942 = \mathbf{3023 \text{ W}}$$

(b) The temperature at which water leaves the basement is

$$\dot{Q} = \dot{m} c_p (T_i - T_e) \longrightarrow T_e = T_i - \frac{\dot{Q}}{\dot{m} c_p} = 90^\circ\text{C} - \frac{3023 \text{ W}}{(1.456 \text{ kg/s})(4206 \text{ J/kg}\cdot^\circ\text{C})} = \mathbf{89.5^\circ\text{C}}$$

The result justifies our assumption that the temperature drop of water is negligible. Also, the thermal resistance of the pipe and temperature drop across it are

$$R_{\text{pipe}} = \frac{\ln(D_2 / D_1)}{4\pi k L} = \frac{\ln(4.6 / 4)}{2\pi(386 \text{ W/m}\cdot^\circ\text{C})(15 \text{ m})} = 3.84 \times 10^{-6} \text{ }^\circ\text{C/W}$$

$$\Delta T_{\text{pipe}} = \dot{Q}_{\text{total}} R_{\text{pipe}} = (3023 \text{ W})(3.84 \times 10^{-6} \text{ }^\circ\text{C/W}) = 0.012^\circ\text{C}$$

which justifies our assumption that the temperature drop across the pipe is negligible.

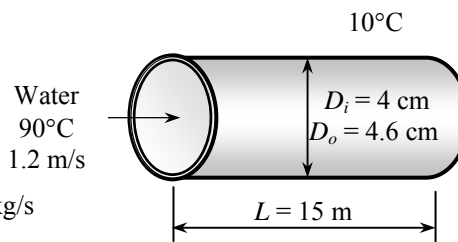

8-84 Integrated circuits are cooled by water flowing through a series of microscopic channels. The temperature rise of water across the microchannels and the average surface temperature of the microchannels are to be determined.

Assumptions 1 Steady flow conditions exist. 2 The inner surfaces of the microchannels are smooth. 3 Entrance effects are disregarded. 4 Any heat transfer from the side and cover surfaces are neglected.

Properties We assume the bulk mean temperature of water to be the inlet temperature of 20°C since the mean temperature of water at the inlet will rise somewhat as a result of heat gain through the microscopic channels. The properties of water at 20°C are (Table A-9)

$$\begin{aligned}\rho &= 998 \text{ kg/m}^3 \\ k &= 0.598 \text{ W/m}\cdot\text{°C} \\ \nu &= \mu / \rho = 1.004 \times 10^{-6} \text{ m}^2/\text{s} \\ c_p &= 4182 \text{ J/kg}\cdot\text{°C}; \text{ Pr} = 7.01\end{aligned}$$

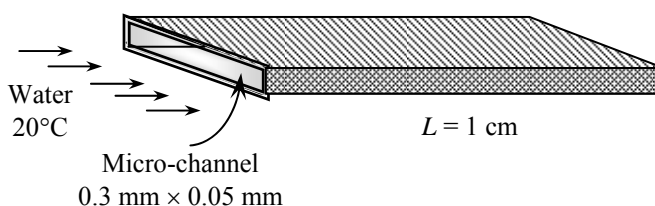

Analysis (a) The mass flow rate of water is

$$\dot{m} = \rho \dot{V} = (998 \text{ kg/m}^3)(0.01 \times 10^{-3} \text{ m}^3/\text{s}) = 0.00998 \text{ kg/s}$$

The temperature rise of water as it flows through the micro channels is

$$\dot{Q} = \dot{m} c_p \Delta T \longrightarrow \Delta T = \frac{\dot{Q}}{\dot{m} c_p} = \frac{50 \text{ J/s}}{(0.00998 \text{ kg/s})(4182 \text{ J/kg}\cdot\text{°C})} = 1.2\text{°C}$$

(b) The Reynolds number is

$$\begin{aligned}V_{\text{avg}} &= \frac{\dot{V}}{A_c} = \frac{0.01 \times 10^{-3} \text{ m}^3/\text{s}}{(0.05 \times 10^{-3} \text{ m})(0.3 \times 10^{-3} \text{ m}) \times 100} = 6.667 \text{ m/s} \\ D_h &= \frac{4A_c}{P} = \frac{4(0.05 \times 10^{-3} \text{ m})(0.3 \times 10^{-3} \text{ m})}{2(0.05 \times 10^{-3} \text{ m} + 0.3 \times 10^{-3} \text{ m})} = 8.571 \times 10^{-5} \text{ m} \\ \text{Re} &= \frac{V_{\text{avg}} D_h}{\nu} = \frac{(6.667 \text{ m/s})(8.57 \times 10^{-5} \text{ m})}{1.004 \times 10^{-6} \text{ m}^2/\text{s}} = 569.1\end{aligned}$$

which is less than 2300. Therefore, the flow is laminar, and the thermal entry length in this case is

$$L_t = 0.05 \text{ Re Pr } D_h = 0.05(569.1)(7.01)(8.571 \times 10^{-5} \text{ m}) = 0.0171 \text{ m}$$

which is longer than the total length of the channels. Therefore, we can assume thermally developing flow, and determine the Nusselt number from (actually, the relation below is for circular tubes)

$$Nu = \frac{hD}{k} = 3.66 + \frac{0.065(D/L) \text{ Re Pr}}{1 + 0.04[(D/L) \text{ Re Pr}]^{2/3}} = 3.66 + \frac{0.065 \left(\frac{8.571 \times 10^{-5} \text{ m}}{0.01 \text{ m}} \right) (569.1)(7.01)}{1 + 0.04 \left[\left(\frac{8.571 \times 10^{-5} \text{ m}}{0.01 \text{ m}} \right) (569.1)(7.01) \right]^{2/3}} = 5.224$$

$$\text{and } h = \frac{k}{D_h} Nu = \frac{0.598 \text{ W/m}\cdot\text{°C}}{8.571 \times 10^{-5} \text{ m}} (5.224) = 36,445 \text{ W/m}^2 \cdot \text{°C}$$

Then the average surface temperature of the base of the micro channels is determined to be

$$\begin{aligned}A_s &= pL = 2(0.3 + 0.05) \times 10^{-3} \times 0.01 = 7 \times 10^{-6} \text{ m}^2 \\ \dot{Q} &= hA_s (T_{s,\text{avg}} - T_{m,\text{avg}}) \\ T_{s,\text{avg}} &= T_{m,\text{avg}} + \frac{\dot{Q}}{hA_s} = \left(\frac{20 + 21.2}{2} \right) \text{°C} + \frac{(50/100) \text{ W}}{(36,445 \text{ W/m}^2 \cdot \text{°C})(7 \times 10^{-6} \text{ m}^2)} = 22.6\text{°C}\end{aligned}$$

8-85 Integrated circuits are cooled by air flowing through a series of microscopic channels. The temperature rise of air across the microchannels and the average surface temperature of the microchannels are to be determined.

Assumptions 1 Steady flow conditions exist. 2 The inner surfaces of the microchannels are smooth. 3 Entrance effects are disregarded. 4 Any heat transfer from the side and cover surfaces are neglected. 5 Air is an ideal gas with constant properties. 6 The pressure of air is 1 atm.

Properties We assume the bulk mean temperature for air to be 60°C since the mean temperature of air at the inlet will rise somewhat as a result of heat gain through the microscopic channels whose base areas are exposed to uniform heat flux. The properties of air at 1 atm and 60°C are (Table A-15)

$$\begin{aligned}\rho &= 1.059 \text{ kg/m}^3 \\ k &= 0.02808 \text{ W/m}\cdot\text{°C} \\ \nu &= 1.896 \times 10^{-5} \text{ m}^2/\text{s} \\ c_p &= 1007 \text{ J/kg}\cdot\text{°C} \\ \text{Pr} &= 0.7202\end{aligned}$$

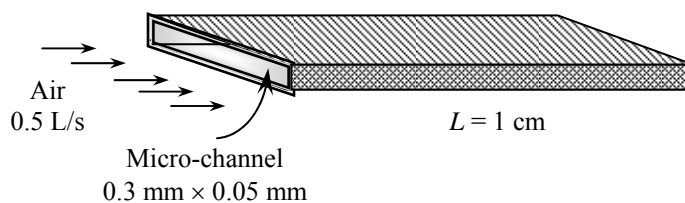

Analysis (a) The mass flow rate of air is

$$\dot{m} = \rho \dot{V} = (1.059 \text{ kg/m}^3)(0.5 \times 10^{-3} \text{ m}^3/\text{s}) = 5.295 \times 10^{-4} \text{ kg/s}$$

The temperature rise of air as it flows through the micro channels is

$$\dot{Q} = \dot{m} c_p \Delta T \rightarrow \Delta T = \frac{\dot{Q}}{\dot{m} c_p} = \frac{50 \text{ J/s}}{(5.295 \times 10^{-4} \text{ kg/s})(1007 \text{ J/kg}\cdot\text{°C})} = \mathbf{93.8^\circ\text{C}}$$

(b) The Reynolds number is

$$\begin{aligned}V_{\text{avg}} &= \frac{\dot{V}}{A_c} = \frac{(0.5 \times 10^{-3} / 100) \text{ m}^3/\text{s}}{(0.05 \times 10^{-3} \text{ m})(0.3 \times 10^{-3} \text{ m})} = 333.3 \text{ m/s} \\ D_h &= \frac{4A_c}{P} = \frac{4(0.05 \times 10^{-3} \text{ m})(0.3 \times 10^{-3} \text{ m})}{2(0.05 \times 10^{-3} \text{ m} + 0.3 \times 10^{-3} \text{ m})} = 8.571 \times 10^{-5} \text{ m} \\ \text{Re} &= \frac{V_{\text{avg}} D_h}{\nu} = \frac{(333.3 \text{ m/s})(8.571 \times 10^{-5} \text{ m})}{1.896 \times 10^{-5} \text{ m}^2/\text{s}} = 1507\end{aligned}$$

which is smaller than 2300. Therefore, the flow is laminar and the thermal entry length in this case is

$$L_t = 0.05 \text{ Re Pr } D_h = 0.05(1507)(0.7202)(8.571 \times 10^{-5} \text{ m}) = 0.004651 \text{ m}$$

which is 42% of the total length of the channels. Therefore, we can assume thermally developing flow, and determine the Nusselt number from (actually, the relation below is for circular tubes)

$$Nu = \frac{hD}{k} = 3.66 + \frac{0.065(D/L) \text{ Re Pr}}{1 + 0.04[(D/L) \text{ Re Pr}]^{2/3}} = 3.66 + \frac{0.065 \left(\frac{8.571 \times 10^{-5} \text{ m}}{0.01 \text{ m}} \right) (1507)(0.7202)}{1 + 0.04 \left[\left(\frac{8.571 \times 10^{-5} \text{ m}}{0.01 \text{ m}} \right) (1507)(0.7202) \right]^{2/3}} = 4.174$$

$$\text{and } h = \frac{k}{D_h} Nu = \frac{0.02808 \text{ W/m}\cdot\text{°C}}{8.571 \times 10^{-5} \text{ m}} (4.174) = 1367 \text{ W/m}^2\cdot\text{°C}$$

Then the average surface temperature of the base of the micro channels becomes

$$\begin{aligned}A_s &= pL = 2(0.3 + 0.05) \times 10^{-3} \times 0.01 = 7 \times 10^{-6} \text{ m}^2 \\ \dot{Q} &= hA_s (T_{s,\text{avg}} - T_{m,\text{avg}}) \\ T_{s,\text{avg}} &= T_{m,\text{avg}} + \frac{\dot{Q}}{hA_s} = \left(\frac{20 + 113.8}{2} \right)^\circ\text{C} + \frac{(50/100) \text{ W}}{(1367 \text{ W/m}^2\cdot\text{°C})(7 \times 10^{-6} \text{ m}^2)} = \mathbf{119.2^\circ\text{C}}\end{aligned}$$

8-86 Hot exhaust gases flow through a pipe. For a specified exit temperature, the pipe length is to be determined.

Assumptions 1 Steady operating conditions exist. 2 The inner surface of the pipe is smooth. 3 For hot gases, air properties are used. 4 Air is an ideal gas with constant properties. 5 The pressure of air is 1 atm.

Properties The properties of air at 1 atm and the bulk mean temperature of $(450+250)/2 = 350^\circ\text{C}$ are (Table A-15)

$$\begin{aligned}\rho &= 0.5664 \text{ kg/m}^3 \\ k &= 0.04721 \text{ W/m}\cdot^\circ\text{C} \\ \nu &= 5.475 \times 10^{-5} \text{ m}^2/\text{s} \\ c_p &= 1056 \text{ J/kg}\cdot^\circ\text{C} \\ \text{Pr} &= 0.6937\end{aligned}$$

Analysis The Reynolds number is

$$\text{Re} = \frac{V_{\text{avg}} D}{\nu} = \frac{(4.5 \text{ m/s})(0.15 \text{ m})}{5.475 \times 10^{-5} \text{ m}^2/\text{s}} = 12,330$$

which is greater than 10,000. Therefore, the flow is turbulent and the entry lengths in this case are roughly

$$L_h \approx L_t \approx 10D = 10(0.15 \text{ m}) = 1.5 \text{ m}$$

which is probably much shorter than the total length of the duct. Therefore, we can assume fully developed turbulent flow in the entire duct, and determine the Nusselt number from

$$\text{Nu} = \frac{hD}{k} = 0.023 \text{Re}^{0.8} \text{Pr}^{0.3} = 0.023(12,330)^{0.8} (0.6937)^{0.3} = 38.62$$

Heat transfer coefficient is

$$h = \frac{k}{D} \text{Nu} = \frac{0.04721 \text{ W/m}\cdot^\circ\text{C}}{0.15 \text{ m}} (38.62) = 12.16 \text{ W/m}^2\cdot^\circ\text{C}$$

The logarithmic mean temperature difference is

$$\Delta T_{\text{ln}} = \frac{T_e - T_i}{\ln\left(\frac{T_s - T_e}{T_s - T_i}\right)} = \frac{250 - 450}{\ln\left(\frac{180 - 250}{180 - 450}\right)} = 148.2^\circ\text{C}$$

The rate of heat loss from the exhaust gases can be expressed as

$$\dot{Q} = hA_s \Delta T_{\text{ln}} = (12.16 \text{ W/m}^2\cdot^\circ\text{C})[\pi(0.15 \text{ m})L](148.2^\circ\text{C}) = 848.9L$$

where L is the length of the pipe. The rate of heat loss can also be determined from

$$\dot{m} = \rho V_{\text{avg}} A_c = (0.5664 \text{ kg/m}^3)(4.5 \text{ m/s})\left[\pi(0.15 \text{ m})^2/4\right] = 0.04504 \text{ kg/s}$$

$$\dot{Q} = \dot{m} c_p \Delta T = (0.04504 \text{ kg/s})(1056 \text{ J/kg}\cdot^\circ\text{C})(450 - 250)^\circ\text{C} = 9513 \text{ W}$$

Setting this equal to rate of heat transfer expression above, the pipe length is determined to be

$$\dot{Q} = 848.9L = 9513 \text{ W} \longrightarrow L = \mathbf{11.2 \text{ m}}$$

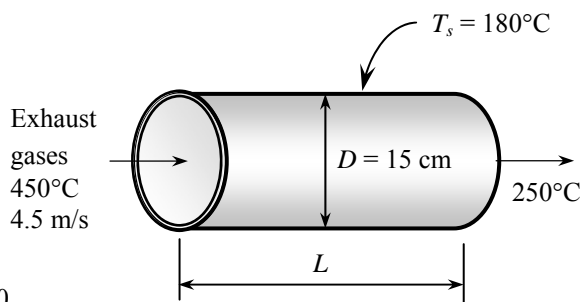

8-87 Water is heated in a heat exchanger by the condensing geothermal steam. The exit temperature of water and the rate of condensation of geothermal steam are to be determined.

Assumptions 1 Steady operating conditions exist. 2 The inner surfaces of the tube are smooth. 3 The surface temperature of the pipe is 165°C , which is the temperature at which the geothermal steam is condensing.

Properties The properties of water at the anticipated mean temperature of 85°C are (Table A-9)

$$\rho = 968.1 \text{ kg/m}^3$$

$$k = 0.673 \text{ W/m}\cdot^\circ\text{C}$$

$$c_p = 4201 \text{ J/kg}\cdot^\circ\text{C}$$

$$\text{Pr} = 2.08$$

$$\nu = \frac{\mu}{\rho} = \frac{0.333 \times 10^{-3} \text{ kg/m}\cdot\text{s}}{968.1 \text{ kg/m}^3} = 3.44 \times 10^{-7} \text{ m}^2/\text{s}$$

$$h_{fg@165^\circ\text{C}} = 2066.5 \text{ kJ/kg}$$

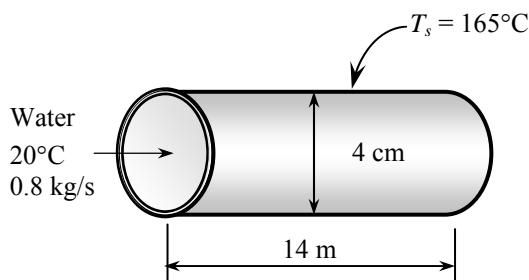

Analysis The velocity of water and the Reynolds number are

$$\dot{m} = \rho A V_{\text{avg}} \longrightarrow 0.8 \text{ kg/s} = (968.1 \text{ kg/m}^3) \pi \frac{(0.04 \text{ m})^2}{4} V_{\text{avg}} \longrightarrow V_{\text{avg}} = 0.6576 \text{ m/s}$$

$$\text{Re} = \frac{V_{\text{avg}} D}{\nu} = \frac{(0.6576 \text{ m/s})(0.04 \text{ m})}{3.44 \times 10^{-7} \text{ m}^2/\text{s}} = 76,465$$

which is greater than 10,000. Therefore, the flow is turbulent and the entry lengths in this case are roughly

$$L_h \approx L_t \approx 10D = 10(0.04 \text{ m}) = 0.4 \text{ m}$$

which is much shorter than the total length of the duct. Therefore, we can assume fully developed turbulent flow in the entire duct, and determine the Nusselt number from

$$\text{Nu} = \frac{hD}{k} = 0.023 \text{ Re}^{0.8} \text{ Pr}^{0.4} = 0.023(76,465)^{0.8} (2.08)^{0.4} = 248.7$$

Heat transfer coefficient is

$$h = \frac{k}{D} \text{Nu} = \frac{0.673 \text{ W/m}\cdot^\circ\text{C}}{0.04 \text{ m}} (248.7) = 4184 \text{ W/m}^2\cdot^\circ\text{C}$$

Next we determine the exit temperature of air,

$$A_s = \pi DL = \pi(0.04 \text{ m})(14 \text{ m}) = 1.759 \text{ m}^2$$

$$T_e = T_s - (T_s - T_i) e^{-hA_s / (\dot{m}c_p)} = 165 - (165 - 20) e^{-\frac{(4184)(1.759)}{(0.6576)(4201)}} = \mathbf{154.9^\circ\text{C}}$$

The logarithmic mean temperature difference is

$$\Delta T_{\text{ln}} = \frac{T_e - T_i}{\ln\left(\frac{T_s - T_e}{T_s - T_i}\right)} = \frac{154.9 - 20}{\ln\left(\frac{165 - 154.9}{165 - 20}\right)} = 50.63^\circ\text{C}$$

The rate of heat transfer can be expressed as

$$\dot{Q} = hA_s \Delta T_{\text{ln}} = (4185 \text{ W/m}^2\cdot^\circ\text{C})(1.759 \text{ m}^2)(50.63^\circ\text{C}) = 372,700 \text{ W}$$

The rate of condensation of steam is determined from

$$\dot{Q} = \dot{m} h_{fg} \longrightarrow 372,700 \text{ W} = \dot{m}(2066.5 \text{ kJ/kg}) \longrightarrow \dot{m} = \mathbf{0.180 \text{ kg/s}}$$

8-88 Cold-air flows through an isothermal pipe. The pipe temperature is to be estimated.

Assumptions 1 Steady operating conditions exist. 2 The inner surface of the duct is smooth. 3 Air is an ideal gas with constant properties. 4 The pressure of air is 1 atm.

Properties The properties of air at 1 atm and the bulk mean temperature of $(5+19)/2=12^\circ\text{C}$ are (Table A-15)

$$\begin{aligned}\rho &= 1.238 \text{ kg/m}^3 \\ k &= 0.02454 \text{ W/m}\cdot^\circ\text{C} \\ \nu &= 1.444 \times 10^{-5} \text{ m}^2/\text{s} \\ c_p &= 1007 \text{ J/kg}\cdot^\circ\text{C} \\ \text{Pr} &= 0.7331\end{aligned}$$

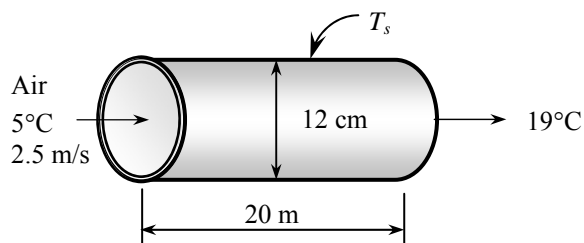

Analysis The rate of heat transfer to the air is

$$\dot{m} = \rho A_c V_{\text{avg}} = (1.238 \text{ kg/m}^3) \pi \frac{(0.12 \text{ m})^2}{4} (2.5 \text{ m/s}) = 0.0350 \text{ kg/s}$$

$$\dot{Q} = \dot{m} c_p \Delta T = (0.0350 \text{ kg/s})(1007 \text{ J/kg}\cdot^\circ\text{C})(19 - 5)^\circ\text{C} = 493.1 \text{ W}$$

Reynolds number is

$$\text{Re} = \frac{V_{\text{avg}} D}{\nu} = \frac{(2.5 \text{ m/s})(0.12 \text{ m})}{1.444 \times 10^{-5} \text{ m}^2/\text{s}} = 20,775$$

which is greater than 10,000. Therefore, the flow is turbulent and the entry lengths in this case are roughly

$$L_h \approx L_t \approx 10D = 10(0.12 \text{ m}) = 1.2 \text{ m}$$

which is much shorter than the total length of the duct. Therefore, we can assume fully developed turbulent flow in the entire duct, and determine the Nusselt number from

$$Nu = \frac{hD}{k} = 0.023 \text{ Re}^{0.8} \text{ Pr}^{0.4} = 0.023(20,775)^{0.8} (0.7331)^{0.4} = 57.79$$

Heat transfer coefficient is

$$h = \frac{k}{D} Nu = \frac{0.02454 \text{ W/m}\cdot^\circ\text{C}}{0.12 \text{ m}} (57.79) = 11.82 \text{ W/m}^2\cdot^\circ\text{C}$$

The logarithmic mean temperature difference is determined from

$$\dot{Q} = h A_s \Delta T_{\text{ln}} \longrightarrow 493.1 \text{ W} = (11.82 \text{ W/m}^2\cdot^\circ\text{C}) [\pi (0.12 \text{ m})(20 \text{ m})] \Delta T_{\text{ln}} \longrightarrow \Delta T_{\text{ln}} = 5.533^\circ\text{C}$$

Then the pipe temperature is determined from the definition of the logarithmic mean temperature difference

$$\Delta T_{\text{ln}} = \frac{T_e - T_i}{\ln\left(\frac{T_s - T_e}{T_s - T_i}\right)} \longrightarrow 5.533^\circ\text{C} = \frac{19 - 5}{\ln\left(\frac{T_s - 19}{T_s - 5}\right)} \longrightarrow T_s = \mathbf{3.8^\circ\text{C}}$$

8-89 Oil is heated by saturated steam in a double-pipe heat exchanger. The tube length is to be determined.

Assumptions 1 Steady operating conditions exist. 2 The surfaces of the tube are smooth.

Properties The properties of oil at the average temperature of $(15+25)/2=20^\circ\text{C}$ are (Table A-13)

$$\begin{aligned}\rho &= 888.1 \text{ kg/m}^3 \\ k &= 0.145 \text{ W/m}\cdot^\circ\text{C} \\ c_p &= 1881 \text{ J/kg}\cdot^\circ\text{C}\end{aligned}$$

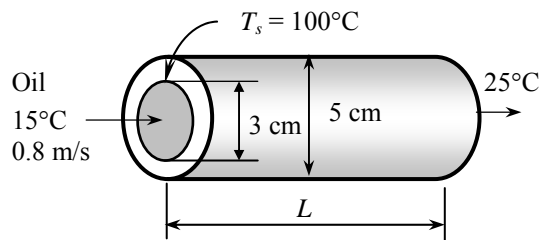

Analysis The mass flow rate and the rate of heat transfer are

$$\dot{m} = \rho A_c V_{\text{avg}} = (888.1 \text{ kg/m}^3) \pi \frac{(0.03 \text{ m})^2}{4} (0.8 \text{ m/s}) = 0.5022 \text{ kg/s}$$

$$\dot{Q} = \dot{m} c_p (T_e - T_i) = (0.5022 \text{ kg/s})(1881 \text{ J/kg}\cdot^\circ\text{C})(25 - 15)^\circ\text{C} = 9446 \text{ W}$$

The Nusselt number is determined from Table 8-4 at $D_i/D_o = 3/5 = 0.6$ to be $Nu_i = 5.564$. Then the heat transfer coefficient, the hydraulic diameter of annulus, and the logarithmic mean temperature difference are

$$h_i = \frac{k}{D_h} Nu_i = \frac{0.145 \text{ W/m}\cdot^\circ\text{C}}{0.02 \text{ m}} (5.564) = 40.34 \text{ W/m}^2\cdot^\circ\text{C}$$

$$D_h = D_o - D_i = 0.05 \text{ m} - 0.03 \text{ m} = 0.02 \text{ m}$$

$$\Delta T_{\text{ln}} = \frac{T_i - T_e}{\ln\left(\frac{T_s - T_e}{T_s - T_i}\right)} = \frac{15 - 25}{\ln\left(\frac{100 - 25}{100 - 15}\right)} = 79.90^\circ\text{C}$$

The heat transfer surface area is determined from

$$\dot{Q} = h A_s \Delta T_{\text{ln}} \longrightarrow A_s = \frac{\dot{Q}}{h \Delta T_{\text{ln}}} = \frac{9446 \text{ W}}{(40.34 \text{ W/m}^2\cdot^\circ\text{C})(79.90^\circ\text{C})} = 2.931 \text{ m}^2$$

Then the tube length becomes

$$A_s = \pi D L \longrightarrow L = \frac{A_s}{\pi D_i} = \frac{2.931 \text{ m}^2}{\pi(0.03 \text{ m})} = \mathbf{31.1 \text{ m}}$$

8-90 A liquid hydrocarbon is heated as it flows in a tube that is maintained at a specified temperature. The flow rate and the exit temperature of the liquid are given. The exit temperature is to be determined for a different flow rate.

Assumptions **1** Steady flow conditions exist. **2** The surface temperature is constant and uniform. **3** The inner surfaces of the tube are smooth. **4** Heat transfer to the surroundings is negligible.

Properties The properties of the liquid are given to $c_p = 2.0 \text{ kJ/kg}\cdot\text{K}$, $\mu = 10 \text{ mPa}\cdot\text{s} = 0.01 \text{ kg/m}\cdot\text{s}$, and $\rho = 900 \text{ kg/m}^3$.

Analysis We first determine the heat transfer coefficient from an energy balance:

$$\dot{m}c_p(T_e - T_i) = hA_s(T_s - T_{b,\text{avg}})$$

$$(1200/3600)(2000)(30 - 20) = h(\pi \times 0.025 \times 5) \left(60 - \frac{20 + 30}{2} \right)$$

$$h = 485 \text{ W/m}^2 \cdot ^\circ\text{C}$$

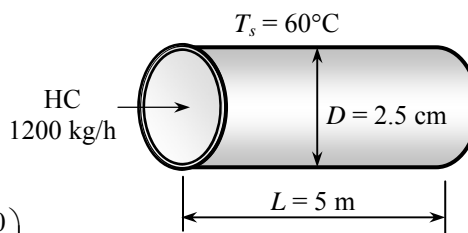

The Reynolds number for the first case is

$$\text{Re}_1 = \frac{\rho D}{\mu} V = \frac{\rho D}{\mu} \frac{\dot{m}}{\rho \pi D^2 / 4} = \frac{4\dot{m}}{\pi D \mu} = \frac{4(1200/3600 \text{ kg/s})}{\pi(0.025 \text{ m})(0.01 \text{ kg/m}\cdot\text{s})} = 1698$$

which is smaller than 2300 and therefore the flow is laminar. The Reynolds number in the second case is

$$\text{Re}_2 = \frac{4\dot{m}}{\pi D \mu} = \frac{4(400/3600 \text{ kg/s})}{\pi(0.025 \text{ m})(0.01 \text{ kg/m}\cdot\text{s})} = 566$$

Using the relationship between the Nusselt and Reynolds numbers for the laminar flow,

$$\frac{\text{Nu}_2}{\text{Nu}_1} = \frac{\text{Re}_2^{1/3}}{\text{Re}_1^{1/3}} \longrightarrow \frac{h_2}{h_1} = \frac{\dot{m}_2^{1/3}}{\dot{m}_1^{1/3}} \longrightarrow h_2 = \left(\frac{400}{1200} \right)^{1/3} (485) = 336.3 \text{ W/m}^2 \cdot ^\circ\text{C}$$

Using this new heat transfer coefficient value, the exit temperature for the second case is determined to be

$$\dot{m}c_p(T_e - T_i) = hA_s(T_s - T_{b,\text{avg}})$$

$$(400/3600)(2000)(T_e - 20) = (336.3)(\pi \times 0.025 \times 5) \left(60 - \frac{20 + T_e}{2} \right)$$

$$T_e = \mathbf{38.3^\circ\text{C}}$$

8-91 Crude oil is heated as it flows in the tube-side of a multi-tube heat exchanger. The rate of heat transfer and the tube length are to be determined.

Assumptions **1** Steady flow conditions exist. **2** The surface temperature is constant and uniform. **3** The inner surfaces of the tubes are smooth. **4** Heat transfer to the surroundings is negligible.

Properties The properties of crude oil are given to be $\rho = 950 \text{ kg/m}^3$, $c_p = 1.9 \text{ kJ/kg}\cdot\text{K}$, $k = 0.25 \text{ W/m}\cdot\text{K}$, $\mu = 12 \text{ mPa}\cdot\text{s}$.

Analysis The rate of heat transfer is

$$\dot{Q} = \dot{m}c_p(T_e - T_i) = (100 \text{ kg/s})(1900 \text{ J/kg}\cdot^\circ\text{C})(40 - 20)^\circ\text{C} = \mathbf{3.8 \times 10^6 \text{ W}}$$

The water velocity is

$$V = \frac{\dot{m}}{\rho A_c} = \frac{(100/100) \text{ kg/s}}{(950 \text{ kg/m}^3)[\pi(0.01 \text{ m})^2/4]} = 13.4 \text{ m/s}$$

The Prandtl and Reynolds number are

$$\text{Pr} = \frac{\mu c_p}{k} = \frac{(0.012 \text{ kg/m}\cdot\text{s})(1900 \text{ J/kg}\cdot\text{K})}{0.25 \text{ W/m}\cdot\text{K}} = 91.2$$

$$\text{Re} = \frac{\rho V D}{\mu} = \frac{(950 \text{ kg/m}^3)(13.4 \text{ m/s})(0.01 \text{ m})}{0.012 \text{ kg/m}\cdot\text{s}} = 10,610$$

which is greater than 10,000. Therefore, we have turbulent flow. Assuming fully developed flow in the entire tube, the Nusselt number is determined from

$$\text{Nu} = \frac{hD}{k} = 0.023 \text{Re}^{0.8} \text{Pr}^{0.4} = 0.023(10,610)^{0.8} (91.2)^{0.4} = 232.4$$

Heat transfer coefficient is

$$h = \frac{k}{D} \text{Nu} = \frac{0.25 \text{ W/m}\cdot^\circ\text{C}}{0.01 \text{ m}} (232.4) = 5811 \text{ W/m}^2\cdot^\circ\text{C}$$

Using the average fluid temperature and considering that there are 100 tubes, the length of the tubes is determined as follows:

$$\dot{Q} = hA(T_s - T_{b,\text{avg}}) \longrightarrow 3.8 \times 10^6 \text{ W} = (5811 \text{ W/m}^2\cdot^\circ\text{C})A \left(100 - \frac{20+30}{2} \right)^\circ\text{C} \longrightarrow A_s = 8.719 \text{ m}^2$$

$$A = \pi DL \longrightarrow 8.719 \text{ m}^2 = 100\pi(0.01 \text{ m})L \longrightarrow L = \mathbf{2.78 \text{ m}}$$

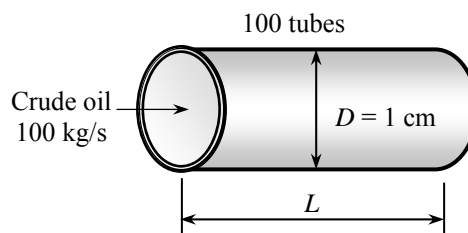

8-92 Crude oil is cooled as it flows in a pipe. The rate of heat transfer and the pipe length are to be determined.

Assumptions 1 Steady flow conditions exist. 2 The surface temperature is constant and uniform. 3 The inner surfaces of the tubes are smooth. 4 Heat transfer to the surroundings is negligible.

Properties The properties of crude oil are given in the table.

Analysis The mass flow rate of air is

$$\begin{aligned}\dot{m} &= \rho AV \\ &= (890 \text{ kg/m}^3) \left[\pi (0.20 \text{ m})^2 / 4 \right] (0.2 \text{ m/s}) \\ &= 5.59 \text{ kg/s}\end{aligned}$$

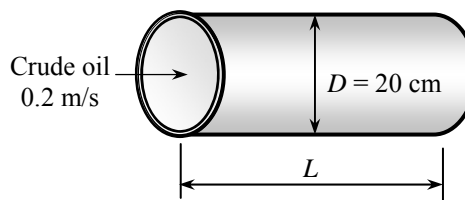

Finding the specific heat of oil at 21°C by interpolation, the rate of heat transfer is determined to be

$$\dot{Q} = \dot{m} c_p (T_e - T_i) = (5.59 \text{ kg/s})(1895 \text{ J/kg} \cdot \text{°C})(22 - 20) \text{°C} = \mathbf{21,242 \text{ W}}$$

The Prandtl and Reynolds number are

$$\text{Pr} = \frac{\mu c_p}{k} = \frac{(0.022 \text{ kg/m} \cdot \text{s})(1895 \text{ J/kg} \cdot \text{K})}{0.145 \text{ W/m} \cdot \text{K}} = 287.5$$

$$\text{Re} = \frac{\rho V D}{\mu} = \frac{(890 \text{ kg/m}^3)(0.2 \text{ m/s})(0.2 \text{ m})}{0.022 \text{ kg/m} \cdot \text{s}} = 1618$$

which is smaller than 2300. Therefore, we have laminar flow. Assuming fully developed flow in the entire tube, the Nusselt number is determined from

$$\text{Nu} = \frac{hD}{k} = 3.66 + \frac{0.065(D/L) \text{Re Pr}}{1 + 0.04[(D/L) \text{Re Pr}]^{2/3}} = 3.66 + \frac{0.065(0.2/L)(1618)(287.5)}{1 + 0.04[(0.2/L)(1618)(287.5)]^{2/3}}$$

The heat transfer coefficient is expressed as

$$h = \frac{k}{D} \text{Nu} = \left(\frac{0.145}{0.2} \right) \left(3.66 + \frac{0.065(0.2/L)(1618)(287.5)}{1 + 0.04[(0.2/L)(1618)(287.5)]^{2/3}} \right) = 0.725 \left[3.66 + \frac{6047.3/L}{1 + 82.1L^{-2/3}} \right]$$

From Newton's law of cooling

$$\begin{aligned}\dot{Q} &= hA(T_s - T_{b,\text{avg}}) \\ 21,200 &= h\pi(0.2)L \left(\frac{22 + 20}{2} - 2 \right) \\ hL &= 1776\end{aligned}$$

Setting both h equations to each other

$$hL = 0.725L \left[3.66 + \frac{6214.7/L}{1 + 82.1L^{-2/3}} \right] = 1776$$

By trial error or using an equation solver such as EES, we obtain

$$L = \mathbf{192 \text{ m}}$$

8-93 A heat exchanger is used for heating a liquid stream. The liquid outlet temperature, the rate of heat transfer, and the changes in these results if entire liquid stream is forced through a single tube are to be determined.

Assumptions 1 Steady operating conditions exist. 2 The heat exchanger is well-insulated so that heat loss to the surroundings is negligible and thus heat transfer from the hot fluid is equal to the heat transfer to the cold fluid. 3 Changes in the kinetic and potential energies of fluid streams are negligible. 4 Fluid properties are constant. 5 There is no fouling.

Properties The properties are given in problem statement.

Analysis (a) The Reynolds and Prandtl numbers are determined as follows:

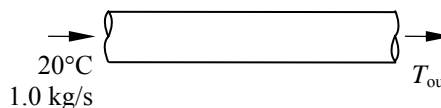

$$V = \frac{\dot{m}}{\rho \pi D^2 / 4} = \frac{(1/12) \text{ kg/s}}{(950 \text{ kg/m}^3) \pi (0.01 \text{ m})^2 / 4} = 1.12 \text{ m/s}$$

$$\text{Re} = \frac{VD\rho}{\mu} = \frac{(1.12 \text{ m/s})(0.01 \text{ m})(950 \text{ kg/m}^3)}{0.006 \text{ kg/m}\cdot\text{s}} = 1768$$

$$\text{Pr} = \frac{\mu c_p}{k} = \frac{(0.006 \text{ kg/m}\cdot\text{s})(1500 \text{ J/kg}\cdot\text{°C})}{0.5 \text{ W/m}\cdot\text{°C}} = 18$$

The flow is laminar since $\text{Re} < 2300$. The Nusselt number and the heat transfer coefficient are

$$\text{Nu} = \frac{hD}{k} = 3.66 + \frac{0.065(D/L) \text{Re Pr}}{1 + 0.04[(D/L) \text{Re Pr}]^{2/3}} = 3.66 + \frac{0.065(0.01/2)(1768)(18)}{1 + 0.04[(0.01/2)(1768)(18)]^{2/3}} = 8.42$$

$$h = \frac{k}{D} \text{Nu} = \frac{0.5 \text{ W/m}\cdot\text{°C}}{0.01 \text{ m}} (8.42) = 421 \text{ W/m}^2\cdot\text{°C}$$

The liquid outlet temperature is determined from an energy balance

$$\begin{aligned} \dot{m} c_p (T_{out} - T_{in}) &= h A_s (T_s - 0.5(T_{in} + T_{out})) \\ (1)(1500)(T_{out} - 20) &= (421)[12\pi(0.01)(2)](60 - 0.5(20 + T_{out})) \\ T_{out} &= \mathbf{27.7\text{°C}} \end{aligned}$$

Then the rate of heat transfer becomes

$$\dot{Q} = \dot{m} c_p (T_{out} - T_{in}) = (1.0 \text{ kg/s})(1500 \text{ J/kg}\cdot\text{°C})(27.7 - 20)\text{°C} = \mathbf{11,550 \text{ W}}$$

(b) The velocity, Reynolds and Prandtl numbers in this case would be

$$V = 12(1.12) = 13.4 \text{ m/s}$$

$$\text{Re} = 12(1768) = 21,216$$

$$\text{Pr} = 18$$

We have turbulent flow since $\text{Re} > 10,000$. The Nusselt number and the heat transfer coefficient are

$$\text{Nu} = 0.023 \text{Re}^{0.8} \text{Pr}^{0.4} = 0.023(21,216)^{0.8} (18)^{0.4} = 211.4$$

$$h = \frac{k}{D} \text{Nu} = \frac{0.5 \text{ W/m}\cdot\text{°C}}{0.01 \text{ m}} (211.4) = 10,572 \text{ W/m}^2\cdot\text{°C}$$

The liquid outlet temperature is

$$\begin{aligned} \dot{m} c_p (T_{out} - T_{in}) &= h A_s (T_s - 0.5(T_{in} + T_{out})) \\ (1)(1500)(T_{out} - 20) &= (10,572)[\pi(0.01)(2)](60 - 0.5(20 + T_{out})) \\ T_{out} &= \mathbf{34.5\text{°C}} \end{aligned}$$

Then the rate of heat transfer becomes

$$\dot{Q} = \dot{m} c_p (T_{out} - T_{in}) = (1.0 \text{ kg/s})(1500 \text{ J/kg}\cdot\text{°C})(34.5 - 20)\text{°C} = \mathbf{21,750 \text{ W}}$$

The rate of heat transfer increases by about 90% in this flow arrangement.

Fundamentals of Engineering (FE) Exam Problems

8-94 Internal force flows are said to be fully-developed once the ____ at a cross-section no longer changes in the direction of flow.

- (a) temperature distribution (b) entropy distribution (c) velocity distribution
 (d) pressure distribution (e) none of the above

Answer (c) velocity distribution

8-95 The bulk or mixed temperature of a fluid flowing through a pipe or duct is defined as

- (a) $T_b = \frac{1}{A_c} \int_{A_c} T dA_c$ (b) $T_b = \frac{1}{\dot{m}} \int_{A_c} T \rho V dA_c$ (c) $T_b = \frac{1}{\dot{m}} \int_{A_c} h \rho V dA_c$
 (d) $T_b = \frac{1}{A_c} \int_{A_c} h dA_c$ (e) $T_b = \frac{1}{\dot{V}} \int_{A_c} T \rho V dA_c$

Answer: (b) $T_b = \frac{1}{\dot{m}} \int_{A_c} T \rho V dA_c$

8-96 Water ($\mu = 9.0 \times 10^{-4}$ kg/m·s, $\rho = 1000$ kg/m³) enters a 2-cm-diameter, 3-m-long tube whose walls are maintained at 100°C. The water enters this tube with a bulk temperature of 25°C and a volume flow rate of 3 m³/h. The Reynolds number for this internal flow is

- (a) 59,000 (b) 105,000 (c) 178,000 (d) 236,000 (e) 342,000

Answer (a) 59,000

Solution Solved by EES Software. Solutions can be verified by copying-and-pasting the following lines on a blank EES screen.

```
rho=1000 [kg/m^3]
mu=0.0009 [kg/m-s]
Vdot=3/3600 [m^3/hr]
D=0.02 [m]
Re=4*Vdot*rho/(pi*D*mu)
```

8-97 Water enters a 2-cm-diameter, 3-m-long tube whose walls are maintained at 100°C with a bulk temperature of 25°C and volume flow rate of 3 m³/h. Neglecting the entrance effects and assuming turbulent flow, the Nusselt number can be determined from $Nu = 0.023 Re^{0.8} Pr^{0.4}$. The convection heat transfer coefficient in this case is

- (a) 4140 W/m²·K (b) 6160 W/m²·K (c) 8180 W/m²·K (d) 9410 W/m²·K (e) 2870 W/m²·K
 (For water, use $k = 0.610$ W/m·°C, $Pr = 6.0$, $\mu = 9.0 \times 10^{-4}$ kg/m·s, $\rho = 1000$ kg/m³)

Answer (d) 9410 W/m²·K

Solution Solved by EES Software. Solutions can be verified by copying-and-pasting the following lines on a blank EES screen.

```
rho=1000 [kg/m^3]
mu=0.0009 [kg/m-s]
Vdot=3/3600 [m^3/hr]
D=0.02 [m]
Pr=6
k=0.61 [W/m-K]
Re=4*rho*Vdot/(pi*D*mu)
Nus=0.023*Re^0.8*Pr^0.4
h=k*Nus/D
```

8-98 Water enters a circular tube whose walls are maintained at constant temperature at a specified flow rate and temperature. For fully developed turbulent flow, the Nusselt number can be determined from $Nu = 0.023 Re^{0.8} Pr^{0.4}$. The correct temperature difference to use in Newton's law of cooling in this case is

- (a) the difference between the inlet and outlet water bulk temperature
 (b) the difference between the inlet water bulk temperature and the tube wall temperature
 (c) the log mean temperature difference
 (d) the difference between the average water bulk temperature and the tube temperature
 (e) None of the above.

Answer (c) the log mean temperature difference

8-99 Water ($c_p = 4180 \text{ J/kg}\cdot\text{K}$) enters a 4-cm-diameter tube at 15°C at a rate of 0.06 kg/s . The tube is subjected to a uniform heat flux of 2500 W/m^2 on the surfaces. The length of the tube required in order to heat the water to 45°C is

- (a) 6 m (b) 12 m (c) 18 m (d) 24 m (e) 30 m

Answer (d) 24 m

Solution Solved by EES Software. Solutions can be verified by copying-and-pasting the following lines on a blank EES screen.

```
T_i=15 [C]
T_e=45 [C]
D=0.04 [m]
m_dot=0.06 [kg/s]
q=2500 [W/m^2]
c_p=4180 [J/kg-C]
Q_dot=m_dot*c_p*(T_e-T_i)
A_s=Q_dot/q
L=A_s/(pi*D)
```

8-100 Air ($c_p = 1000 \text{ J/kg}\cdot\text{K}$) enters a 20-cm-diameter and 19-m-long underwater duct at 50°C and 1 atm at an average velocity of 7 m/s , and is cooled by the water outside. If the average heat transfer coefficient is $35 \text{ W/m}^2\cdot^\circ\text{C}$ and the tube temperature is nearly equal to the water temperature of 5°C , the exit temperature of air is

- (a) 8°C (b) 13°C (c) 18°C (d) 28°C (e) 37°C

Answer (b) 13°C

Solution Solved by EES Software. Solutions can be verified by copying-and-pasting the following lines on a blank EES screen.

```
R=0.287 [kPa-m^3/kg-K]
cp=1000 [J/kg-K]
D=0.2 [m]
L=19 [m]
T1=50 [C]
P1=101.3 [kPa]
Vel=7 [m/s]
h=35 [W/m^2-C]
Ts=5 [C]
rho1=P1/(R*(T1+273))
As=pi*D*L
m_dot=rho1*Vel*pi*D^2/4
T2=Ts-(Ts-T1)*exp(-h*As/(m_dot*cp))
"Some Wrong Solutions with Common Mistakes:"
m_dot*cp*(T1-W1_T2)=h*As*((T1+W1_T2)/2-Ts) "Disregarding exponential variation of
temperature"
```

- 8-101** Water ($c_p = 4180 \text{ J/kg}\cdot\text{K}$) enters a 12-cm-diameter and 8.5-m-long tube at 75°C at a rate of 0.35 kg/s , and is cooled by a refrigerant evaporating outside at -10°C . If the average heat transfer coefficient on the inner surface is $500 \text{ W/m}^2\cdot\text{C}$, the exit temperature of water is
 (a) 18.4°C (b) 25.0°C (c) 33.8°C (d) 46.5°C (e) 60.2°C

Answer (a) 18.4°C

Solution Solved by EES Software. Solutions can be verified by copying-and-pasting the following lines on a blank EES screen.

```
D=0.12 [m]
L=8.5 [m]
T_i=75 [C]
T_s=-10 [C]
m_dot=0.35 [kg/s]
h=500 [W/m^2-C]
c_p=4180 [J/kg-C]
A_s=pi*D*L
T_e=T_s-(T_s-T_i)*exp((-h*A_s)/(m_dot*c_p))
```

- 8-102** Air enters a duct at 20°C at a rate of $0.08 \text{ m}^3/\text{s}$, and is heated to 150°C by steam condensing outside at 200°C . The error involved in the rate of heat transfer to the air due to using arithmetic mean temperature difference instead of logarithmic mean temperature difference is
 (a) 0% (b) 5.4% (c) 8.1% (d) 10.6% (e) 13.3%

Answer (e) 13.3%

Solution Solved by EES Software. Solutions can be verified by copying-and-pasting the following lines on a blank EES screen.

```
T_i=20 [C]
T_e=150 [C]
T_s=200 [C]
V_dot=0.08 [m^3/s]
DELTAT_am=T_s-(T_i+T_e)/2
DELTAT_ln=(T_i-T_e)/ln((T_s-T_e)/(T_s-T_i))
Error=(DELTAT_am-DELTAT_ln)/DELTAT_ln*Convert(,%)
```

8-103 Engine oil at 60°C ($\mu = 0.07399$ kg/m·s, $\rho = 864$ kg/m³) flows in a 5-cm-diameter tube with a velocity of 1.3 m/s. The pressure drop along a fully developed 6-m long section of the tube is

- (a) 2.9 kPa (b) 5.2 kPa (c) 7.4 kPa (d) 10.5 kPa (e) 20.0 kPa

Answer (c) 7.4 kPa

Solution Solved by EES Software. Solutions can be verified by copying-and-pasting the following lines on a blank EES screen.

```
T_oil=60 [C]
D=0.05 [m]
L=6 [m]
V=1.3 [m/s]
```

"The properties of engine oil at 60 C are (Table A-13)"

```
rho=864 [kg/m^3]
mu=0.07399 [kg/m-s]
```

```
Re=(rho*V*D)/mu "The calculated Re value is smaller than 2300. Therefore the flow is laminar"
f=64/Re
DELTAP=f*L/D*(rho*V^2)/2
```

8-104 Engine oil flows in a 15-cm-diameter horizontal tube with a velocity of 1.3 m/s, experiencing a pressure drop of 12 kPa. The pumping power requirement to overcome this pressure drop is

- (a) 190 W (b) 276 W (c) 407 W (d) 655 W (e) 900 W

Answer (b) 276 W

Solution Solved by EES Software. Solutions can be verified by copying-and-pasting the following lines on a blank EES screen.

```
D=0.15 [m]
V=1.3 [m/s]
DELTAP=12 [kPa]
A_c=pi*D^2/4
V_dot=V*A_c
W_dot_pump=V_dot*DELTAP
```

8-105 Water enters a 5-mm-diameter and 13-m-long tube at 15°C with a velocity of 0.3 m/s, and leaves at 45°C. The tube is subjected to a uniform heat flux of 2000 W/m² on its surface. The temperature of the tube surface at the exit is

- (a) 48.7°C (b) 49.4°C (c) 51.1°C (d) 53.7°C (e) 55.2°C

(For water, use $k = 0.615 \text{ W/m}\cdot\text{C}$, $Pr = 5.42$, $\nu = 0.801 \times 10^{-6} \text{ m}^2/\text{s}$)

Answer (a) 48.7°C

Solution Solved by EES Software. Solutions can be verified by copying-and-pasting the following lines on a blank EES screen.

```
T_i=15 [C]
T_e=45 [C]
D=0.005 [m]
L=13 [m]
V=0.3 [m/s]
q_s=2000 [W/m^2]
```

"The properties of water at $(15+45)/2 = 30 \text{ C}$ are (Table A-9)"

```
rho=996 [kg/m^3]
k=0.615 [W/m-C]
mu=0.798E-3 [kg/m-s]
Pr=5.42
```

$Re = (\rho \cdot V \cdot D) / \mu$ "The calculated Re value is smaller than 2300. Therefore the flow is laminar."

$L_t = 0.05 \cdot Re \cdot Pr \cdot D$ "Entry length is much shorter than the total length, and therefore we use fully developed relations"

$Nus = 4.36$ "laminar flow, $q_s = \text{constant}$ "

$h = k / D \cdot Nus$

$T_s = T_e + q_s / h$

"Some Wrong Solutions with Common Mistakes"

$W1_Nus = 3.66$ "Laminar flow, $T_s = \text{constant}$ "

$W1_h = k / D \cdot W1_Nus$

$W1_T_s = T_e + q_s / W1_h$

8-106 Water enters a 5-mm-diameter and 13-m-long tube at 45°C with a velocity of 0.3 m/s. The tube is maintained at a constant temperature of 5°C. The exit temperature of water is

- (a) 7.5°C (b) 7.0°C (c) 6.5°C (d) 6.0°C (e) 5.5°C

(For water, use $k = 0.607 \text{ W/m}\cdot\text{°C}$, $\text{Pr} = 6.14$, $\nu = 0.894 \times 10^{-6} \text{ m}^2/\text{s}$, $c_p = 4180 \text{ J/kg}\cdot\text{°C}$, $\rho = 997 \text{ kg/m}^3$.)

Answer (d) 6.0°C

Solution Solved by EES Software. Solutions can be verified by copying-and-pasting the following lines on a blank EES screen.

```
T_i=45 [C]
T_s=5 [C]
D=0.005 [m]
L=13 [m]
V=0.3 [m/s]
```

"The properties of water at 25 C are (Table A-9)"

```
rho=997 [kg/m^3]
c_p=4180 [J/kg-C]
k=0.607 [W/m-C]
mu=0.891E-3 [kg/m-s]
Pr=6.14
```

$\text{Re}=(\rho \cdot V \cdot D)/\mu$ "The calculated Re value is smaller than 2300. Therefore the flow is laminar."
 $L_t=0.05 \cdot \text{Re} \cdot \text{Pr} \cdot D$ "Entry length is much shorter than the total length, and therefore we use fully developed relations"

```
Nus=3.66 "laminar flow, T_s = constant"
h=k/D*Nus
A_s=pi*D*L
A_c=pi*D^2/4
m_dot=rho*A_c*V
T_e=T_s-(T_s-T_i)*exp((-h*A_s)/(m_dot*c_p))
```

"Some Wrong Solutions with Common Mistakes"

```
W1_Nus=4.36 "Laminar flow, q_s = constant"
W1_h=k/D*W1_Nus
W1_T_e=T_s-(T_s-T_i)*exp((-W1_h*A_s)/(m_dot*c_p))
```

8-107 Water enters a 5-mm-diameter and 13-m-long tube at 45°C with a velocity of 0.3 m/s. The tube is maintained at a constant temperature of 5°C. The required length of the tube in order for the water to exit the tube at 25°C is

- (a) 1.55 m (b) 1.72 m (c) 1.99 m (d) 2.37 m (e) 2.96 m

(For water, use $k = 0.623 \text{ W/m}\cdot\text{C}$, $Pr = 4.83$, $\nu = 0.724 \times 10^{-6} \text{ m}^2/\text{s}$, $c_p = 4178 \text{ J/kg}\cdot\text{C}$, $\rho = 994 \text{ kg/m}^3$.)

Answer (b) 1.72 m

Solution Solved by EES Software. Solutions can be verified by copying-and-pasting the following lines on a blank EES screen.

```
T_i=45 [C]
T_e=25 [C]
T_s=5 [C]
D=0.005 [m]
V=0.3 [m/s]
```

"The properties of water at $(45+25)/2 = 35 \text{ C}$ are (Table A-9)"

```
rho=994 [kg/m^3]
c_p=4178 [J/kg-C]
k=0.623 [W/m-C]
mu=0.720E-3 [kg/m-s]
Pr=4.83
```

```
Re=(rho*V*D)/mu "The calculated Re value is smaller than 2300. Therefore the flow is laminar."
L_t=0.05*Re*Pr*D "We assume that the entire flow remains in the entry region. We will check this
after calculating total length of the tube"
Nus=3.66+(0.065*(D/L)*Re*Pr)/(1+0.04*((D/L)*Re*Pr)^(2/3)) "laminar flow, entry region, T_s =
constant"
h=k/D*Nus
A_c=pi*D^2/4
m_dot=rho*A_c*V
T_e=T_s-(T_s-T_i)*exp((-h*A_s)/(m_dot*c_p))
A_s=pi*D*L "The total length calculated is shorter than the entry length, and therefore, the earlier
entry region assumption is validated."
```

"Some Wrong Solutions with Common Mistakes"

```
W1_Nus=3.66 "Laminar flow, T_s = constant, fully developed flow"
W1_h=k/D*W1_Nus
T_e=T_s-(T_s-T_i)*exp((-W1_h*W1_A_s)/(m_dot*c_p))
W1_A_s=pi*D*W1_L
W2_Nus=4.36 "Laminar flow, q_s = constant, fully developed flow"
W2_h=k/D*W2_Nus
T_e=T_s-(T_s-T_i)*exp((-W2_h*W2_A_s)/(m_dot*c_p))
W2_A_s=pi*D*W2_L
```

8-108 Air at 10°C enters an 18-m-long rectangular duct of cross section 0.15 m × 0.20 m at a velocity of 4.5 m/s. The duct is subjected to uniform radiation heating throughout the surface at a rate of 400 W/m². The wall temperature at the exit of the duct is

- (a) 58.8°C (b) 61.9°C (c) 64.6°C (d) 69.1°C (e) 75.5°C

(For air, use $k = 0.02551$ W/m·°C, $Pr = 0.7296$, $\nu = 1.562 \times 10^{-5}$ m²/s, $c_p = 1007$ J/kg·°C, $\rho = 1.184$ kg/m³.)

Answer (c) 64.6°C

Solution Solved by EES Software. Solutions can be verified by copying-and-pasting the following lines on a blank EES screen.

```
T_i=10 [C]
L=18 [m]
a=0.15 [m]
b=0.20 [m]
V=4.5 [m/s]
q_s=400 [W/m^2]
```

"The properties of air at 25 C are (Table A-15)"

```
rho=1.184 [kg/m^3]
c_p=1007 [J/kg-C]
k=0.02551 [W/m-C]
nu=1.562E-5 [m^2/s]
Pr=0.7296
```

```
p=2*a+2*b
```

```
A_c=a*b
```

```
D_h=4*A_c/p
```

```
Re=(V*D_h)/nu "The calculated Re value is greater than 10,000. Therefore the flow is turbulent."
```

```
L_t=10*D_h "Entry length is much shorter than the total length, and therefore we use fully developed relations"
```

```
Nus=0.023*Re^0.8*Pr^0.4
```

```
h=k/D_h*Nus
```

```
T_s=T_e+q_s/h
```

"Calculations for air temperature at the duct exit"

```
m_dot=rho*V*A_c
```

```
Q_dot=m_dot*c_p*(T_e-T_i)
```

```
A_s=p*L
```

```
Q_dot=q_s*A_s
```

8-109 Air at 110°C enters an 18-cm-diameter, 9-m-long duct at a velocity of 3 m/s. The duct is observed to be nearly isothermal at 85°C. The rate of heat loss from the air in the duct is

- (a) 375 W (b) 510 W (c) 936 W (d) 965 W (e) 987 W

(For air, use $k = 0.03095 \text{ W/m}\cdot\text{°C}$, $\text{Pr} = 0.7111$, $\nu = 2.306 \times 10^{-5} \text{ m}^2/\text{s}$, $c_p = 1009 \text{ J/kg}\cdot\text{°C}$.)

Answer (e) 987 W

Solution Solved by EES Software. Solutions can be verified by copying-and-pasting the following lines on a blank EES screen.

```
T_i=110 [C]
D=0.18 [m]
L=9 [m]
V=3 [m/s]
T_s=85 [C]
```

"The properties of air at 100 C are (Table A-15)"

```
rho=0.9458 [kg/m^3]
c_p=1009 [J/kg-C]
k=0.03095 [W/m-C]
nu=2.306E-5 [m^2/s]
Pr=0.7111
```

$\text{Re}=(V \cdot D)/\nu$ "The calculated Re value is greater than 10,000. Therefore the flow is turbulent."

$L_t=10 \cdot D$ "Entry length is much shorter than the total length, and therefore we use fully developed relations"

$\text{Nus}=0.023 \cdot \text{Re}^{0.8} \cdot \text{Pr}^{0.3}$

$h=k/D \cdot \text{Nus}$

$A_s=\pi \cdot D \cdot L$

$A_c=\pi \cdot D^2/4$

$\dot{m}=\rho \cdot V \cdot A_c$

$T_e=T_s-(T_s-T_i) \cdot \exp((-h \cdot A_s)/(\dot{m} \cdot c_p))$

$\dot{Q}=\dot{m} \cdot c_p \cdot (T_i-T_e)$

"Some Wrong Solutions with Common Mistakes"

$\text{W1_Nus}=0.023 \cdot \text{Re}^{0.8} \cdot \text{Pr}^{0.4}$ "Relation for heating case"

$\text{W1_h}=k/D \cdot \text{W1_Nus}$

$\text{W1_T}_e=T_s-(T_s-T_i) \cdot \exp((-W1_h \cdot A_s)/(\dot{m} \cdot c_p))$

$\text{W1_Q_dot}=\dot{m} \cdot c_p \cdot (T_i-\text{W1_T}_e)$

8-110 Air enters a 7-cm-diameter, 4-m-long tube at 65°C and leaves at 15°C. The duct is observed to be nearly isothermal at 5°C. If the average convection heat transfer coefficient is 20 W/m²·°C, the rate of heat transfer from the air is

- (a) 491 W (b) 616 W (c) 810 W (d) 907 W (e) 975 W

Answer (a) 491 W

Solution Solved by EES Software. Solutions can be verified by copying-and-pasting the following lines on a blank EES screen.

```
T_i=65 [C]
T_e=15 [C]
T_s=5 [C]
D=0.07 [m]
L=4 [m]
h=20 [W/m^2-C]
DELTAT_ln=(T_i-T_e)/ln((T_s-T_e)/(T_s-T_i))
A_s=pi*D*L
Q_dot=h*A_s*DELTAT_ln
"Some Wrong Solutions with Common Mistakes"
DELTAT_am=T_s-(T_i+T_e)/2 "Using arithmetic mean temperature difference"
W1_Q_dot=h*A_s*DELTAT_am
```

8-111 Air ($c_p = 1007$ J/kg·°C) enters a 17-cm-diameter and 4-m-long tube at 65°C at a rate of 0.08 kg/s and leaves at 15°C. The tube is observed to be nearly isothermal at 5°C. The average convection heat transfer coefficient is

- (a) 24.5 W/m²·°C (b) 46.2 W/m²·°C (c) 53.9 W/m²·°C (d) 67.6 W/m²·°C (e) 90.7 W/m²·°C

Answer (d) 67.6 W/m²·°C

Solution Solved by EES Software. Solutions can be verified by copying-and-pasting the following lines on a blank EES screen.

```
T_i=65 [C]
T_e=15 [C]
T_s=5 [C]
m_dot=0.08 [kg/s]
D=0.17 [m]
L=4 [m]
c_p=1007 [J/kg-C] "Table A-15"
Q_dot=m_dot*c_p*(T_e-T_i)
A_s=pi*D*L
DELTAT_ln=(T_i-T_e)/ln((T_s-T_e)/(T_s-T_i))
h=Q_dot/(A_s*DELTAT_ln)
"Some Wrong Solutions with Common Mistakes"
DELTAT_am=T_s-(T_i+T_e)/2 "Using arithmetic mean temperature difference"
W1_h=Q_dot/(A_s*DELTAT_am)
```

8-112 Air at 40°C ($\mu = 1.918 \times 10^{-5}$ kg/m·s, $\rho = 1.127$ kg/m³) flows in a 25-cm-diameter and 26-m-long horizontal tube at a velocity of 5 m/s. If the roughness of the inner surface of the pipe is 0.2 mm, the required pumping power to overcome the pressure drop is

- (a) 0.3 W (b) 0.9 W (c) 3.4 W (d) 5.5 W (e) 8.0 W

Answer (e) 8.0 W

Solution Solved by EES Software. Solutions can be verified by copying-and-pasting the following lines on a blank EES screen.

```
T_air=40 [C]
D=0.25 [m]
L=26 [m]
V=5 [m/s]
epsilon=0.0002
```

"The properties of air at 40 C are (Table A-15)"

```
rho=1.127 [kg/m^3]
mu=1.918E-5 [kg/m-s]
```

Re=(rho*V*D)/mu "The calculated Re value is greater than 10,000. Therefore the flow is turbulent"

1/sqrt(f)=-2*log10((epsilon/D)/3.7+2.51/(Re*sqrt(f))) "Colebrook equation"

```
DELTAP=f*L/D*(rho*V^2)/2
```

```
A_c=pi*D^2/4
```

```
V_dot=A_c*V
```

```
W_dot=V_dot*DELTAP
```

"Some Wrong Solutions with Common Mistakes"

```
W_f=64/Re "Using laminar flow relation"
```

```
W_DELTAP=W_f*L/D*(rho*V^2)/2
```

```
W_W_dot=V_dot*W_DELTAP
```

8-113 8-115 Design and Essay Problems

8-115 A computer is cooled by a fan blowing air through the case of the computer. The flow rate of the fan and the diameter of the casing of the fan are to be specified.

Assumptions 1 Steady flow conditions exist. 2 Heat flux is uniformly distributed. 3 Air is an ideal gas with constant properties.

Properties The relevant properties of air are (Tables A-1 and A-15)

$$c_p = 1007 \text{ J/kg}\cdot^\circ\text{C}$$

$$R = 0.287 \text{ kPa}\cdot\text{m}^3/\text{kg}\cdot\text{K}$$

Analysis We need to determine the flow rate of air for the worst case scenario. Therefore, we assume the inlet temperature of air to be 50°C , the atmospheric pressure to be 70.12 kPa , and disregard any heat transfer from the outer surfaces of the computer case. The mass flow rate of air required to absorb heat at a rate of 80 W can be determined from

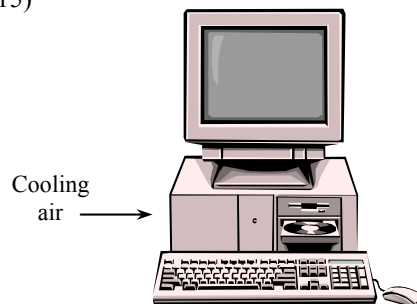

$$\dot{Q} = \dot{m}c_p(T_{out} - T_{in}) \longrightarrow \dot{m} = \frac{\dot{Q}}{c_p(T_{out} - T_{in})} = \frac{80 \text{ J/s}}{(1007 \text{ J/kg}\cdot^\circ\text{C})(60 - 50)^\circ\text{C}} = 0.007944 \text{ kg/s}$$

In the worst case the exhaust fan will handle air at 60°C . Then the density of air entering the fan and the volume flow rate becomes

$$\rho = \frac{P}{RT} = \frac{70.12 \text{ kPa}}{(0.287 \text{ kPa}\cdot\text{m}^3/\text{kg}\cdot\text{K})(60 + 273)\text{K}} = 0.7337 \text{ kg/m}^3$$

$$\dot{V} = \frac{\dot{m}}{\rho} = \frac{0.007944 \text{ kg/s}}{0.7337 \text{ kg/m}^3} = 0.01083 \text{ m}^3/\text{s} = \mathbf{0.6497 \text{ m}^3/\text{min}}$$

For an average velocity of 120 m/min , the diameter of the duct in which the fan is installed can be determined from

$$\dot{V} = A_c V = \frac{\pi D^2}{4} V \longrightarrow D = \sqrt{\frac{4\dot{V}}{\pi V}} = \sqrt{\frac{4(0.6497 \text{ m}^3/\text{min})}{\pi(120 \text{ m/min})}} = 0.083 \text{ m} = \mathbf{8.3 \text{ cm}}$$



Chapter 9

NATURAL CONVECTION

Physical Mechanisms of Natural Convection

9-1C Natural convection is the mode of heat transfer that occurs between a solid and a fluid which moves under the influence of natural means. Natural convection differs from forced convection in that fluid motion in natural convection is caused by natural effects such as buoyancy.

9-2C The convection heat transfer coefficient is usually higher in forced convection because of the higher fluid velocities involved.

9-3C The hot boiled egg in a spacecraft will cool faster when the spacecraft is on the ground since there is no gravity in space, and thus there will be no natural convection currents which is due to the buoyancy force.

9-4C The upward force exerted by a fluid on a body completely or partially immersed in it is called the buoyancy or “lifting” force. The buoyancy force is proportional to the density of the medium. Therefore, the buoyancy force is the largest in mercury, followed by in water, air, and the evacuated chamber. Note that in an evacuated chamber there will be no buoyancy force because of absence of any fluid in the medium.

9-5C The buoyancy force is proportional to the density of the medium, and thus is larger in sea water than it is in fresh water. Therefore, the hull of a ship will sink deeper in fresh water because of the smaller buoyancy force acting upwards.

9-6C A spring scale measures the “weight” force acting on it, and the person will weigh less in water because of the upward buoyancy force acting on the person’s body.

9-7C The greater the volume expansion coefficient, the greater the change in density with temperature, the greater the buoyancy force, and thus the greater the natural convection currents.

9-8C There cannot be any natural convection heat transfer in a medium that experiences no change in volume with temperature.

9-9C The lines on an interferometer photograph represent isotherms (constant temperature lines) for a gas, which correspond to the lines of constant density. Closely packed lines on a photograph represent a large temperature gradient.

9-10C The Grashof number represents the ratio of the buoyancy force to the viscous force acting on a fluid. The inertial forces in Reynolds number is replaced by the buoyancy forces in Grashof number.

9-11 The volume expansion coefficient is defined as $\beta = \frac{-1}{\rho} \left(\frac{\partial \rho}{\partial T} \right)_P$. For an ideal gas, $P = \rho RT$ or

$$\rho = \frac{P}{RT}, \text{ and thus } \beta = -\frac{1}{\rho} \left(\frac{\partial (P/RT)}{\partial T} \right)_P = \frac{-1}{\rho} \left(\frac{-P}{RT^2} \right) = \frac{1}{\rho T} \left(\frac{P}{RT} \right) = \frac{1}{\rho T} (\rho) = \frac{1}{T}$$

Natural Convection over Surfaces

9-12C Rayleigh number is the product of the Grashof and Prandtl numbers.

9-13C A vertical cylinder can be treated as a vertical plate when $D \geq \frac{35L}{Gr^{1/4}}$.

9-14C No, a hot surface will cool slower when facing down since the warmer air in this position cannot rise and escape easily.

9-15C The heat flux will be higher at the bottom of the plate since the thickness of the boundary layer which is a measure of thermal resistance is the lowest there.

9-16 Heat is generated in a horizontal plate while heat is lost from it by convection and radiation. The temperature of the plate when steady operating conditions are reached is to be determined.

Assumptions 1 Steady operating conditions exist. **2** Air is an ideal gas with constant properties. **3** The local atmospheric pressure is 1 atm.

Properties We assume the surface temperature to be 50°C . Then the properties of air at 1 atm and the film temperature of $(T_s + T_\infty)/2 = (50 + 20)/2 = 35^\circ\text{C}$ are (Table A-15)

$$k = 0.02625 \text{ W/m}\cdot^\circ\text{C}$$

$$\nu = 1.655 \times 10^{-5} \text{ m}^2/\text{s}$$

$$\text{Pr} = 0.7268$$

$$\beta = \frac{1}{T_f} = \frac{1}{(35 + 273)\text{K}} = 0.003247 \text{ K}^{-1}$$

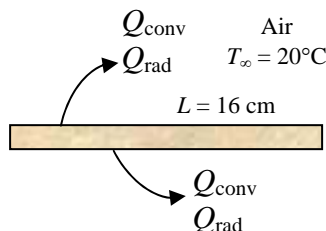

Analysis The characteristic length in this case is

$$L_c = \frac{A_s}{p} = \frac{(0.16 \text{ m})(0.20 \text{ m})}{2[(0.16 \text{ m}) + (0.20 \text{ m})]} = 0.04444 \text{ m}$$

The Rayleigh number is

$$Ra = \frac{g\beta(T_s - T_\infty)L_c^3}{\nu^2} \text{Pr} = \frac{(9.81 \text{ m/s}^2)(0.003247 \text{ K}^{-1})(50 - 20 \text{ K})(0.04444 \text{ m})^3}{(1.655 \times 10^{-5} \text{ m}^2/\text{s})^2} (0.7268) = 222,593$$

The Nusselt number relation for the top surface of the plate is

$$Nu = 0.54Ra^{0.25} = 0.54(222,593)^{0.25} = 11.73$$

Then

$$h = \frac{k}{L_c} Nu = \frac{0.02625 \text{ W/m}\cdot^\circ\text{C}}{0.04444 \text{ m}} (11.73) = 6.928 \text{ W/m}^2\cdot^\circ\text{C}$$

and

$$\dot{Q}_{\text{top}} = hA(T_s - T_\infty) = (6.928 \text{ W/m}^2\cdot^\circ\text{C})(0.16 \times 0.20 \text{ m}^2)(T_s - 20)^\circ\text{C} = 0.2217(T_s - 20)$$

The Nusselt number relation for the bottom surface of the plate is

$$Nu = 0.27Ra^{0.25} = 0.27(222,593)^{0.25} = 5.865$$

Then

$$h = \frac{k}{L_c} Nu = \frac{0.02625 \text{ W/m}\cdot^\circ\text{C}}{0.04444 \text{ m}} (5.865) = 3.464 \text{ W/m}^2\cdot^\circ\text{C}$$

$$\dot{Q}_{\text{bottom}} = hA(T_s - T_\infty) = (3.464 \text{ W/m}^2\cdot^\circ\text{C})(0.16 \times 0.20 \text{ m}^2)(T_s - 20)^\circ\text{C} = 0.1108(T_s - 20)$$

Considering that radiation heat loss to surroundings occur both from top and bottom surfaces, it may be expressed as

$$\begin{aligned} \dot{Q}_{\text{rad}} &= 2\varepsilon A \sigma (T_s^4 - T_{\text{surr}}^4) \\ &= (0.9)(2)(0.16 \times 0.20 \text{ m}^2)(5.67 \times 10^{-8} \text{ W/m}^2\cdot\text{K}^4) \left[(T_s + 273 \text{ K})^4 - (17 + 273 \text{ K})^4 \right] \\ &= 3.2659 \times 10^{-9} \left[(T_s + 273 \text{ K})^4 - (17 + 273 \text{ K})^4 \right] \end{aligned}$$

When the heat lost from the plate equals to the heat generated, the steady operating conditions are reached. The surface temperature in this case can be determined by trial-error or using EES to be

$$\begin{aligned} \dot{Q}_{\text{total}} &= \dot{Q}_{\text{top}} + \dot{Q}_{\text{bottom}} + \dot{Q}_{\text{rad}} \\ 20 \text{ W} &= 0.2217(T_s - 20) + 0.1108(T_s - 20) + 3.2659 \times 10^{-9} \left[(T_s + 273 \text{ K})^4 - (17 + 273 \text{ K})^4 \right] \\ T_s &= \mathbf{46.8^\circ\text{C}} \end{aligned}$$

9-17 Flue gases are released to atmosphere using a cylindrical stack. The rates of heat transfer from the stack with and without wind cases are to be determined.

Assumptions 1 Steady operating conditions exist. **2** Air is an ideal gas with constant properties. **3** The local atmospheric pressure is 1 atm.

Properties The properties of air at 1 atm and the film temperature of $(T_s + T_\infty)/2 = (40 + 10)/2 = 25^\circ\text{C}$ are (Table A-15)

$$k = 0.02551 \text{ W/m}\cdot^\circ\text{C}$$

$$\nu = 1.562 \times 10^{-5} \text{ m}^2/\text{s}$$

$$\text{Pr} = 0.7296$$

$$\beta = \frac{1}{T_f} = \frac{1}{(25 + 273)\text{K}} = 0.003356 \text{ K}^{-1}$$

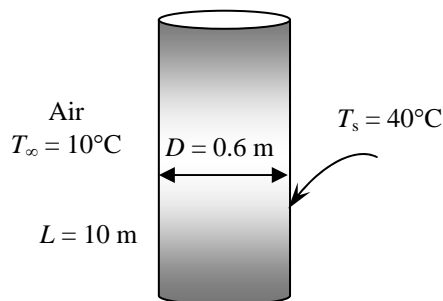

Analysis (a) When there is no wind heat transfer is by natural convection. The characteristic length in this case is the height of the stack, $L_c = L = 10 \text{ m}$. Then,

$$\text{Ra} = \frac{g\beta(T_s - T_\infty)L^3}{\nu^2} \text{Pr} = \frac{(9.81 \text{ m/s}^2)(0.003356 \text{ K}^{-1})(40 - 10 \text{ K})(10 \text{ m})^3}{(1.562 \times 10^{-5} \text{ m}^2/\text{s})^2} (0.7296) = 2.953 \times 10^{12}$$

We can treat this vertical cylinder as a vertical plate since

$$\frac{35L}{\text{Gr}^{1/4}} = \frac{35(10)}{(2.953 \times 10^{12} / 0.7296)^{1/4}} = 0.246 < 0.6 \quad \text{and thus } D \geq \frac{35L}{\text{Gr}^{1/4}}$$

The Nusselt number is determined from

$$\text{Nu} = 0.1\text{Ra}^{1/3} = 0.1(2.953 \times 10^{12})^{1/3} = 1435 \quad (\text{from Table 9-1})$$

Then

$$h = \frac{k}{L_c} \text{Nu} = \frac{0.02551 \text{ W/m}\cdot^\circ\text{C}}{10 \text{ m}} (1435) = 3.660 \text{ W/m}^2\cdot^\circ\text{C}$$

and

$$\dot{Q} = hA(T_s - T_\infty) = (3.660 \text{ W/m}^2\cdot^\circ\text{C})(\pi \times 0.6 \times 10 \text{ m}^2)(40 - 10)^\circ\text{C} = \mathbf{2070 \text{ W}}$$

(b) When the stack is exposed to 20 km/h winds, the heat transfer will be by forced convection. We have flow of air over a cylinder and the heat transfer rate is determined as follows:

$$\text{Re} = \frac{VD}{\nu} = \frac{(20 \times 1000 / 3600 \text{ m/s})(0.6 \text{ m})}{1.562 \times 10^{-5} \text{ m}^2/\text{s}} = 213,400$$

$$\text{Nu} = 0.027 \text{Re}^{0.805} \text{Pr}^{1/3} = 0.027(213,400)^{0.805} (0.7296)^{1/3} = 473.9 \quad (\text{from Table 7-1})$$

$$h = \frac{k}{D} \text{Nu} = \frac{0.02551 \text{ W/m}\cdot^\circ\text{C}}{0.6 \text{ m}} (473.9) = 20.15 \text{ W/m}^2\cdot^\circ\text{C}$$

$$\dot{Q} = hA(T_s - T_\infty) = (20.15 \text{ W/m}^2\cdot^\circ\text{C})(\pi \times 0.6 \times 10 \text{ m}^2)(40 - 10)^\circ\text{C} = \mathbf{11,390 \text{ W}}$$

Discussion There is more than five-fold increase in heat transfer due to winds.

9-18 Heat generated by the electrical resistance of a bare cable is dissipated to the surrounding air. The surface temperature of the cable is to be determined.

Assumptions 1 Steady operating conditions exist. **2** Air is an ideal gas with constant properties. **3** The local atmospheric pressure is 1 atm. **4** The temperature of the surface of the cable is constant.

Properties We assume the surface temperature to be 100°C. Then the properties of air at 1 atm and the film temperature of $(T_s + T_\infty)/2 = (100 + 20)/2 = 60^\circ\text{C}$ are (Table A-15)

$$k = 0.02808 \text{ W/m}\cdot^\circ\text{C}$$

$$\nu = 1.896 \times 10^{-5} \text{ m}^2/\text{s}$$

$$\text{Pr} = 0.7202$$

$$\beta = \frac{1}{T_f} = \frac{1}{(60 + 273)\text{K}} = 0.003003 \text{ K}^{-1}$$

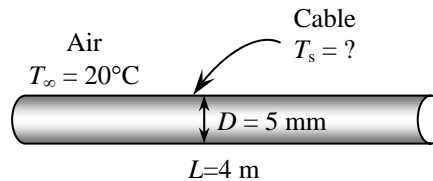

Analysis The characteristic length in this case is the outer diameter of the pipe, $L_c = D = 0.005 \text{ m}$. Then,

$$Ra = \frac{g\beta(T_s - T_\infty)D^3}{\nu^2} \text{Pr} = \frac{(9.81 \text{ m/s}^2)(0.003003 \text{ K}^{-1})(100 - 20 \text{ K})(0.005 \text{ m})^3}{(1.896 \times 10^{-5} \text{ m}^2/\text{s})^2} (0.7202) = 590.2$$

$$Nu = \left\{ 0.6 + \frac{0.387 Ra^{1/6}}{\left[1 + (0.559 / \text{Pr})^{9/16} \right]^{8/27}} \right\}^2 = \left\{ 0.6 + \frac{0.387 (590.2)^{1/6}}{\left[1 + (0.559 / 0.7202)^{9/16} \right]^{8/27}} \right\}^2 = 2.346$$

$$h = \frac{k}{D} Nu = \frac{0.02808 \text{ W/m}\cdot^\circ\text{C}}{0.005 \text{ m}} (2.346) = 13.17 \text{ W/m}^2\cdot^\circ\text{C}$$

$$A_s = \pi DL = \pi (0.005 \text{ m})(4 \text{ m}) = 0.06283 \text{ m}^2$$

$$\dot{Q} = hA_s(T_s - T_\infty)$$

$$(60 \text{ V})(1.5 \text{ A}) = (13.17 \text{ W/m}^2\cdot^\circ\text{C})(0.06283 \text{ m}^2)(T_s - 20)^\circ\text{C}$$

$$T_s = 128.8^\circ\text{C}$$

which is not close to the assumed value of 100°C . Repeating calculations for an assumed surface temperature of 120°C , [$T_f = (T_s + T_\infty)/2 = (120 + 20)/2 = 70^\circ\text{C}$]

$$k = 0.02881 \text{ W/m}\cdot^\circ\text{C}$$

$$\nu = 1.995 \times 10^{-5} \text{ m}^2/\text{s}$$

$$\text{Pr} = 0.7177$$

$$\beta = \frac{1}{T_f} = \frac{1}{(70 + 273)\text{K}} = 0.002915 \text{ K}^{-1}$$

$$Ra = \frac{g\beta(T_s - T_\infty)D^3}{\nu^2} \text{Pr} = \frac{(9.81 \text{ m/s}^2)(0.002915 \text{ K}^{-1})(120 - 20 \text{ K})(0.005 \text{ m})^3}{(1.995 \times 10^{-5} \text{ m}^2/\text{s})^2} (0.7177) = 644.6$$

$$Nu = \left\{ 0.6 + \frac{0.387 Ra^{1/6}}{\left[1 + (0.559 / \text{Pr})^{9/16} \right]^{8/27}} \right\}^2 = \left\{ 0.6 + \frac{0.387 (644.6)^{1/6}}{\left[1 + (0.559 / 0.7177)^{9/16} \right]^{8/27}} \right\}^2 = 2.387$$

$$h = \frac{k}{D} Nu = \frac{0.02881 \text{ W/m}\cdot^\circ\text{C}}{0.005 \text{ m}} (2.387) = 13.76 \text{ W/m}^2\cdot^\circ\text{C}$$

$$\dot{Q} = hA_s(T_s - T_\infty)$$

$$(60 \text{ V})(1.5 \text{ A}) = (13.76 \text{ W/m}^2\cdot^\circ\text{C})(0.06283 \text{ m}^2)(T_s - 20)^\circ\text{C}$$

$$T_s = 124.1^\circ\text{C}$$

which is sufficiently close to the assumed value of 120°C .

9-19 A horizontal hot water pipe passes through a large room. The rate of heat loss from the pipe by natural convection and radiation is to be determined.

Assumptions 1 Steady operating conditions exist. 2 Air is an ideal gas with constant properties. 3 The local atmospheric pressure is 1 atm. 4 The temperature of the outer surface of the pipe is constant.

Properties The properties of air at 1 atm and the film temperature of $(T_s + T_\infty)/2 = (73 + 27)/2 = 50^\circ\text{C}$ are (Table A-15)

$$k = 0.02735 \text{ W/m}\cdot^\circ\text{C}$$

$$\nu = 1.798 \times 10^{-5} \text{ m}^2/\text{s}$$

$$\text{Pr} = 0.7228$$

$$\beta = \frac{1}{T_f} = \frac{1}{(50 + 273)\text{K}} = 0.003096 \text{ K}^{-1}$$

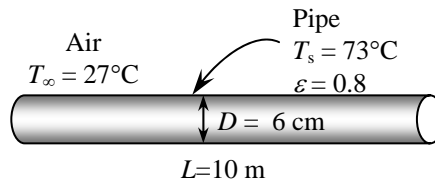

Analysis (a) The characteristic length in this case is the outer diameter of the pipe, $L_c = D = 0.06 \text{ m}$. Then,

$$Ra = \frac{g\beta(T_s - T_\infty)D^3}{\nu^2} \text{Pr} = \frac{(9.81 \text{ m/s}^2)(0.003096 \text{ K}^{-1})(73 - 27 \text{ K})(0.06 \text{ m})^3}{(1.798 \times 10^{-5} \text{ m}^2/\text{s})^2} (0.7228) = 6.747 \times 10^5$$

$$Nu = \left\{ 0.6 + \frac{0.387 Ra^{1/6}}{\left[1 + (0.559 / \text{Pr})^{9/16} \right]^{8/27}} \right\}^2 = \left\{ 0.6 + \frac{0.387 (6.747 \times 10^5)^{1/6}}{\left[1 + (0.559 / 0.7228)^{9/16} \right]^{8/27}} \right\}^2 = 13.05$$

$$h = \frac{k}{D} Nu = \frac{0.02735 \text{ W/m}\cdot^\circ\text{C}}{0.06 \text{ m}} (13.05) = 5.950 \text{ W/m}^2\cdot^\circ\text{C}$$

$$A_s = \pi DL = \pi (0.06 \text{ m})(10 \text{ m}) = 1.885 \text{ m}^2$$

$$\dot{Q} = hA_s(T_s - T_\infty) = (5.950 \text{ W/m}^2\cdot^\circ\text{C})(1.885 \text{ m}^2)(73 - 27)^\circ\text{C} = \mathbf{516 \text{ W}}$$

(b) The radiation heat loss from the pipe is

$$\begin{aligned} \dot{Q}_{rad} &= \varepsilon A_s \sigma (T_s^4 - T_{surr}^4) \\ &= (0.8)(1.885 \text{ m}^2)(5.67 \times 10^{-8} \text{ W/m}^2\cdot\text{K}^4) \left[(73 + 273 \text{ K})^4 - (27 + 273 \text{ K})^4 \right] = \mathbf{533 \text{ W}} \end{aligned}$$

9-20 A power transistor mounted on the wall dissipates 0.18 W. The surface temperature of the transistor is to be determined.

Assumptions 1 Steady operating conditions exist. 2 Air is an ideal gas with constant properties. 3 Any heat transfer from the base surface is disregarded. 4 The local atmospheric pressure is 1 atm. 5 Air properties are evaluated at 100°C.

Properties The properties of air at 1 atm and the given film temperature of 100°C are (Table A-15)

$$k = 0.03095 \text{ W/m}\cdot\text{°C}$$

$$\nu = 2.306 \times 10^{-5} \text{ m}^2/\text{s}$$

$$\text{Pr} = 0.7111$$

$$\beta = \frac{1}{T_f} = \frac{1}{(100 + 273) \text{ K}} = 0.00268 \text{ K}^{-1}$$

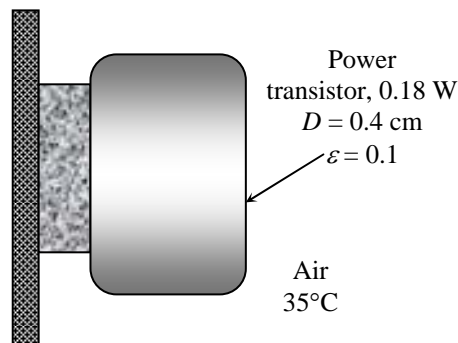

Analysis The solution of this problem requires a trial-and-error approach since the determination of the Rayleigh number and thus the Nusselt number depends on the surface temperature which is unknown. We start the solution process by “guessing” the surface temperature to be 165°C for the evaluation of h . This is the surface temperature that will give a film temperature of 100°C. We will check the accuracy of this guess later and repeat the calculations if necessary.

The transistor loses heat through its cylindrical surface as well as its top surface. For convenience, we take the heat transfer coefficient at the top surface of the transistor to be the same as that of its side surface. (The alternative is to treat the top surface as a vertical plate, but this will double the amount of calculations without providing much improvement in accuracy since the area of the top surface is much smaller and it is circular in shape instead of being rectangular). The characteristic length in this case is the outer diameter of the transistor, $L_c = D = 0.004 \text{ m}$. Then,

$$\text{Ra} = \frac{g\beta(T_s - T_\infty)D^3}{\nu^2} \text{Pr} = \frac{(9.81 \text{ m/s}^2)(0.00268 \text{ K}^{-1})(165 - 35 \text{ K})(0.004 \text{ m})^3}{(2.306 \times 10^{-5} \text{ m}^2/\text{s})^2} (0.7111) = 292.6$$

$$\text{Nu} = \left\{ 0.6 + \frac{0.387 \text{Ra}^{1/6}}{\left[1 + (0.559/\text{Pr})^{9/16} \right]^{8/27}} \right\}^2 = \left\{ 0.6 + \frac{0.387(292.6)^{1/6}}{\left[1 + (0.559/0.7111)^{9/16} \right]^{8/27}} \right\}^2 = 2.039$$

$$h = \frac{k}{D} \text{Nu} = \frac{0.03095 \text{ W/m}\cdot\text{°C}}{0.004 \text{ m}} (2.039) = 15.78 \text{ W/m}^2\cdot\text{°C}$$

$$A_s = \pi DL + \pi D^2 / 4 = \pi(0.004 \text{ m})(0.0045 \text{ m}) + \pi(0.004 \text{ m})^2 / 4 = 0.0000691 \text{ m}^2$$

and

$$\begin{aligned} \dot{Q} &= hA_s(T_s - T_\infty) + \varepsilon A_s \sigma (T_s^4 - T_{surr}^4) \\ 0.18 \text{ W} &= (15.8 \text{ W/m}^2\cdot\text{°C})(0.0000691 \text{ m}^2)(T_s - 35) \text{ °C} \\ &\quad + (0.1)(0.0000691 \text{ m}^2)(5.67 \times 10^{-8}) \left[(T_s + 273)^4 - (25 + 273 \text{ K})^4 \right] \\ \longrightarrow T_s &= 187 \text{ °C} \end{aligned}$$

which is relatively close to the assumed value of 165°C. To improve the accuracy of the result, we repeat the Rayleigh number calculation at new surface temperature of 187°C and determine the surface temperature to be

$$T_s = 183 \text{ °C}$$

Discussion W evaluated the air properties again at 100°C when repeating the calculation at the new surface temperature. It can be shown that the effect of this on the calculated surface temperature is less than 1°C.

9-21 EES Prob. 9-20 is reconsidered. The effect of ambient temperature on the surface temperature of the transistor is to be investigated.

Analysis The problem is solved using EES, and the solution is given below.

"GIVEN"

Q_dot=0.18 [W]
 T_infinity=35 [C]
 L=0.0045 [m]
 D=0.004 [m]
 epsilon=0.1
 T_surr=T_infinity-10

"PROPERTIES"

Fluid\$='air'
 k=Conductivity(Fluid\$, T=T_film)
 Pr=Prandtl(Fluid\$, T=T_film)
 rho=Density(Fluid\$, T=T_film, P=101.3)
 mu=Viscosity(Fluid\$, T=T_film)
 nu=mu/rho
 beta=1/(T_film+273)
 T_film=1/2*(T_s+T_infinity)
 sigma=5.67E-8 [W/m^2-K^4] "Stefan-Boltzmann constant"
 g=9.807 [m/s^2] "gravitational acceleration"

"ANALYSIS"

delta=D
 Ra=(g*beta*(T_s-T_infinity)*delta^3)/nu^2*Pr
 Nusselt=(0.6+(0.387*Ra^(1/6)))/(1+(0.559/Pr)^(9/16))^(8/27))^2
 h=k/delta*Nusselt
 A=pi*D*L+pi*D^2/4
 Q_dot=h*A*(T_s-T_infinity)+epsilon*A*sigma*((T_s+273)^4-(T_surr+273)^4)

T _∞ [C]	T _s [C]
10	159.9
12	161.8
14	163.7
16	165.6
18	167.5
20	169.4
22	171.3
24	173.2
26	175.1
28	177
30	178.9
32	180.7
34	182.6
36	184.5
38	186.4
40	188.2

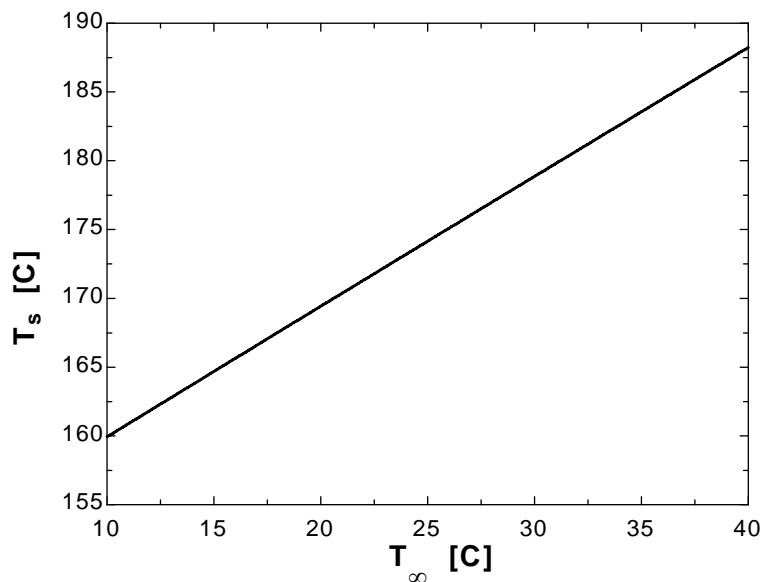

9-22E A hot plate with an insulated back is considered. The rate of heat loss by natural convection is to be determined for different orientations.

Assumptions 1 Steady operating conditions exist. 2 Air is an ideal gas with constant properties. 3 The local atmospheric pressure is 1 atm.

Properties The properties of air at 1 atm and the film temperature of $(T_s + T_\infty)/2 = (130 + 75)/2 = 102.5^\circ\text{F}$ are (Table A-15)

$$k = 0.01535 \text{ Btu/h}\cdot\text{ft}\cdot^\circ\text{F}$$

$$\nu = 0.1823 \times 10^{-3} \text{ ft}^2/\text{s}$$

$$\text{Pr} = 0.7256$$

$$\beta = \frac{1}{T_f} = \frac{1}{(102.5 + 460)\text{R}} = 0.001778 \text{ R}^{-1}$$

Analysis (a) When the plate is vertical, the characteristic length is the height of the plate. $L_c = L = 2 \text{ ft}$. Then,

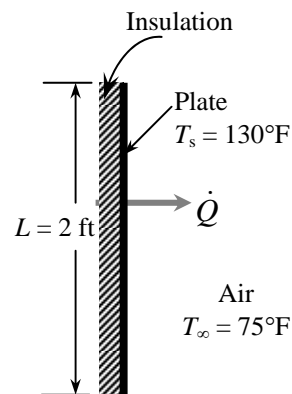

$$Ra = \frac{g\beta(T_s - T_\infty)L^3}{\nu^2} \text{Pr} = \frac{(32.2 \text{ ft/s}^2)(0.001778 \text{ R}^{-1})(130 - 75 \text{ R})(2 \text{ ft})^3}{(0.1823 \times 10^{-3} \text{ ft}^2/\text{s})^2} (0.7256) = 5.503 \times 10^8$$

$$Nu = \left\{ 0.825 + \frac{0.387 Ra^{1/6}}{\left[1 + \left(\frac{0.492}{\text{Pr}} \right)^{9/16} \right]^{8/27}} \right\}^2 = \left\{ 0.825 + \frac{0.387 (5.503 \times 10^8)^{1/6}}{\left[1 + \left(\frac{0.492}{0.7256} \right)^{9/16} \right]^{8/27}} \right\}^2 = 102.6$$

$$h = \frac{k}{L} Nu = \frac{0.01535 \text{ Btu/h}\cdot\text{ft}\cdot^\circ\text{F}}{2 \text{ ft}} (102.6) = 0.7869 \text{ Btu/h}\cdot\text{ft}^2\cdot^\circ\text{F}$$

$$A_s = L^2 = (2 \text{ ft})^2 = 4 \text{ ft}^2$$

and $\dot{Q} = hA_s(T_s - T_\infty) = (0.7869 \text{ Btu/h}\cdot\text{ft}^2\cdot^\circ\text{F})(4 \text{ ft}^2)(130 - 75)^\circ\text{C} = \mathbf{173.1 \text{ Btu/h}}$

(b) When the plate is horizontal with hot surface facing up, the characteristic length is determined from

$$L_s = \frac{A_s}{P} = \frac{L^2}{4L} = \frac{L}{4} = \frac{2 \text{ ft}}{4} = 0.5 \text{ ft}.$$

Then,

$$Ra = \frac{g\beta(T_s - T_\infty)L_c^3}{\nu^2} \text{Pr} = \frac{(32.2 \text{ ft/s}^2)(0.001778 \text{ R}^{-1})(130 - 75 \text{ R})(0.5 \text{ ft})^3}{(0.1823 \times 10^{-3} \text{ ft}^2/\text{s})^2} (0.7256) = 8.598 \times 10^6$$

$$Nu = 0.54 Ra^{1/4} = 0.54 (8.598 \times 10^6)^{1/4} = 29.24$$

$$h = \frac{k}{L_c} Nu = \frac{0.01535 \text{ Btu/h}\cdot\text{ft}\cdot^\circ\text{F}}{0.5 \text{ ft}} (29.24) = 0.8975 \text{ Btu/h}\cdot\text{ft}^2\cdot^\circ\text{F}$$

and $\dot{Q} = hA_s(T_s - T_\infty) = (0.8975 \text{ Btu/h}\cdot\text{ft}^2\cdot^\circ\text{F})(4 \text{ ft}^2)(130 - 75)^\circ\text{C} = \mathbf{197.4 \text{ Btu/h}}$

(c) When the plate is horizontal with hot surface facing down, the characteristic length is again $\delta = 0.5 \text{ ft}$ and the Rayleigh number is $Ra = 8.598 \times 10^6$. Then,

$$Nu = 0.27 Ra^{1/4} = 0.27 (8.598 \times 10^6)^{1/4} = 14.62$$

$$h = \frac{k}{L_c} Nu = \frac{0.01535 \text{ Btu/h}\cdot\text{ft}\cdot^\circ\text{F}}{0.5 \text{ ft}} (14.62) = 0.4487 \text{ Btu/h}\cdot\text{ft}^2\cdot^\circ\text{F}$$

and $\dot{Q} = hA_s(T_s - T_\infty) = (0.4487 \text{ Btu/h}\cdot\text{ft}^2\cdot^\circ\text{F})(4 \text{ ft}^2)(130 - 75)^\circ\text{C} = \mathbf{98.7 \text{ Btu/h}}$

9-23E EES Prob. 9-22E is reconsidered. The rate of natural convection heat transfer for different orientations of the plate as a function of the plate temperature is to be plotted.

Analysis The problem is solved using EES, and the solution is given below.

"GIVEN"

L=2 [ft]
T_infinity=75 [F]
T_s=130 [F]

"PROPERTIES"

Fluid\$='air'
k=Conductivity(Fluid\$, T=T_film)
Pr=Prandtl(Fluid\$, T=T_film)
rho=Density(Fluid\$, T=T_film, P=14.7)
mu=Viscosity(Fluid\$, T=T_film)*Convert(lbm/ft-h, lbm/ft-s)
nu=mu/rho
beta=1/(T_film+460)
T_film=1/2*(T_s+T_infinity)
g=32.2 [ft/s^2]

"ANALYSIS"

"(a), plate is vertical"

delta_a=L
Ra_a=(g*beta*(T_s-T_infinity)*delta_a^3)/nu^2*Pr
Nusselt_a=0.59*Ra_a^0.25
h_a=k/delta_a*Nusselt_a
A=L^2
Q_dot_a=h_a*A*(T_s-T_infinity)

"(b), plate is horizontal with hot surface facing up"

delta_b=A/p
p=4*L
Ra_b=(g*beta*(T_s-T_infinity)*delta_b^3)/nu^2*Pr
Nusselt_b=0.54*Ra_b^0.25
h_b=k/delta_b*Nusselt_b
Q_dot_b=h_b*A*(T_s-T_infinity)

"(c), plate is horizontal with hot surface facing down"

delta_c=delta_b
Ra_c=Ra_b
Nusselt_c=0.27*Ra_c^0.25
h_c=k/delta_c*Nusselt_c
Q_dot_c=h_c*A*(T_s-T_infinity)

T_s [F]	Q_a [Btu/h]	Q_b [Btu/h]	Q_c [Btu/h]
80	7.714	9.985	4.993
85	18.32	23.72	11.86
90	30.38	39.32	19.66
95	43.47	56.26	28.13
100	57.37	74.26	37.13
105	71.97	93.15	46.58
110	87.15	112.8	56.4
115	102.8	133.1	66.56
120	119	154	77.02
125	135.6	175.5	87.75
130	152.5	197.4	98.72
135	169.9	219.9	109.9
140	187.5	242.7	121.3
145	205.4	265.9	132.9
150	223.7	289.5	144.7
155	242.1	313.4	156.7
160	260.9	337.7	168.8
165	279.9	362.2	181.1
170	299.1	387.1	193.5
175	318.5	412.2	206.1
180	338.1	437.6	218.8

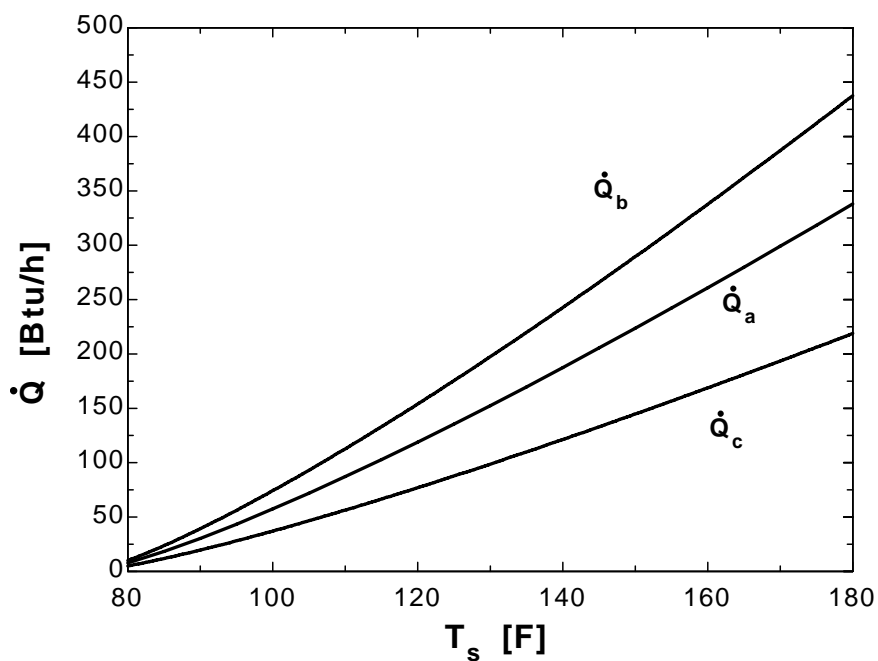

9-24 A cylindrical resistance heater is placed horizontally in a fluid. The outer surface temperature of the resistance wire is to be determined for two different fluids.

Assumptions 1 Steady operating conditions exist. 2 Air is an ideal gas with constant properties. 3 The local atmospheric pressure is 1 atm. 4 Any heat transfer by radiation is ignored. 5 Properties are evaluated at 500°C for air and 40°C for water.

Properties The properties of air at 1 atm and 500°C are (Table A-15)

$$k = 0.05572 \text{ W/m}\cdot\text{°C}$$

$$\nu = 7.804 \times 10^{-5} \text{ m}^2/\text{s}$$

$$\text{Pr} = 0.6986,$$

$$\beta = \frac{1}{T_f} = \frac{1}{(500 + 273)\text{K}} = 0.001294 \text{ K}^{-1}$$

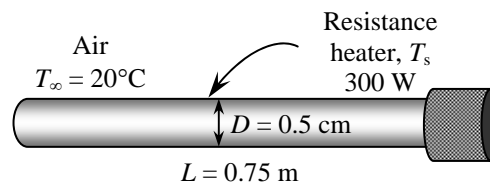

The properties of water at 40°C are (Table A-9)

$$k = 0.631 \text{ W/m}\cdot\text{°C}, \quad \nu = \mu / \rho = 0.6582 \times 10^{-6} \text{ m}^2/\text{s}$$

$$\text{Pr} = 4.32, \quad \beta = 0.000377 \text{ K}^{-1}$$

Analysis (a) The solution of this problem requires a trial-and-error approach since the determination of the Rayleigh number and thus the Nusselt number depends on the surface temperature which is unknown. We start the solution process by “guessing” the surface temperature to be 1200°C for the calculation of h . We will check the accuracy of this guess later and repeat the calculations if necessary. The characteristic length in this case is the outer diameter of the wire, $L_c = D = 0.005 \text{ m}$. Then,

$$Ra = \frac{g\beta(T_s - T_\infty)D^3}{\nu^2} \text{Pr} = \frac{(9.81 \text{ m/s}^2)(0.001294 \text{ K}^{-1})(1200 - 20)^\circ\text{C}(0.005 \text{ m})^3}{(7.804 \times 10^{-5} \text{ m}^2/\text{s})^2} (0.6986) = 214.7$$

$$Nu = \left\{ 0.6 + \frac{0.387 Ra^{1/6}}{\left[1 + (0.559 / \text{Pr})^{9/16} \right]^{8/27}} \right\}^2 = \left\{ 0.6 + \frac{0.387(214.7)^{1/6}}{\left[1 + (0.559 / 0.6986)^{9/16} \right]^{8/27}} \right\}^2 = 1.919$$

$$h = \frac{k}{D} Nu = \frac{0.05572 \text{ W/m}\cdot\text{°C}}{0.005 \text{ m}} (1.919) = 21.38 \text{ W/m}^2 \cdot \text{°C}$$

$$A_s = \pi DL = \pi(0.005 \text{ m})(0.75 \text{ m}) = 0.01178 \text{ m}^2$$

and

$$\dot{Q} = hA_s(T_s - T_\infty) \rightarrow 300 \text{ W} = (21.38 \text{ W/m}^2 \cdot \text{°C})(0.01178 \text{ m}^2)(T_s - 20)^\circ\text{C} \rightarrow T_s = \mathbf{1211^\circ\text{C}}$$

which is sufficiently close to the assumed value of 1200°C used in the evaluation of h , and thus it is not necessary to repeat calculations.

(b) For the case of water, we “guess” the surface temperature to be 40°C. The characteristic length in this case is the outer diameter of the wire, $L_c = D = 0.005 \text{ m}$. Then,

$$Ra = \frac{g\beta(T_s - T_\infty)D^3}{\nu^2} \text{Pr} = \frac{(9.81 \text{ m/s}^2)(0.000377 \text{ K}^{-1})(40 - 20)^\circ\text{C}(0.005 \text{ m})^3}{(0.6582 \times 10^{-6} \text{ m}^2/\text{s})^2} (4.32) = 92,197$$

$$Nu = \left\{ 0.6 + \frac{0.387 Ra^{1/6}}{\left[1 + (0.559 / \text{Pr})^{9/16} \right]^{8/27}} \right\}^2 = \left\{ 0.6 + \frac{0.387(92,197)^{1/6}}{\left[1 + (0.559 / 4.32)^{9/16} \right]^{8/27}} \right\}^2 = 8.986$$

$$h = \frac{k}{D} Nu = \frac{0.631 \text{ W/m}\cdot\text{°C}}{0.005 \text{ m}} (8.986) = 1134 \text{ W/m}^2 \cdot \text{°C}$$

$$\text{and } \dot{Q} = hA_s(T_s - T_\infty) \rightarrow 300 \text{ W} = (1134 \text{ W/m}^2 \cdot \text{°C})(0.01178 \text{ m}^2)(T_s - 20)^\circ\text{C} \rightarrow T_s = \mathbf{42.5^\circ\text{C}}$$

which is sufficiently close to the assumed value of 40°C in the evaluation of the properties and h . The film temperature in this case is $(T_s + T_\infty)/2 = (42.5 + 20)/2 = 31.3^\circ\text{C}$, which is close to the value of 40°C used in the evaluation of the properties.

9-25 Water is boiling in a pan that is placed on top of a stove. The rate of heat loss from the cylindrical side surface of the pan by natural convection and radiation and the ratio of heat lost from the side surfaces of the pan to that by the evaporation of water are to be determined.

Assumptions 1 Steady operating conditions exist. 2 Air is an ideal gas with constant properties. 3 The local atmospheric pressure is 1 atm.

Properties The properties of air at 1 atm and the film temperature of $(T_s + T_\infty)/2 = (98 + 25)/2 = 61.5^\circ\text{C}$ are (Table A-15)

$$k = 0.02819 \text{ W/m}\cdot^\circ\text{C}$$

$$\nu = 1.910 \times 10^{-5} \text{ m}^2/\text{s}$$

$$\text{Pr} = 0.7198$$

$$\beta = \frac{1}{T_f} = \frac{1}{(61.5 + 273)\text{K}} = 0.00299 \text{ K}^{-1}$$

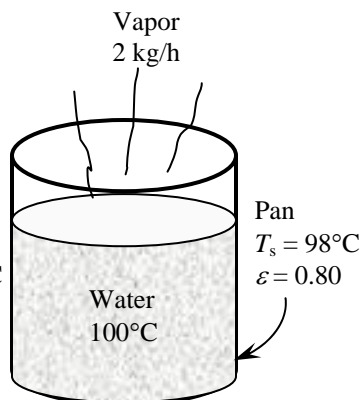

Analysis (a) The characteristic length in this case is the height of the pan, $L_c = L = 0.12 \text{ m}$. Then

$$\text{Ra} = \frac{g\beta(T_s - T_\infty)L^3}{\nu^2} \text{Pr} = \frac{(9.81 \text{ m/s}^2)(0.00299 \text{ K}^{-1})(98 - 25 \text{ K})(0.12 \text{ m})^3}{(1.910 \times 10^{-5} \text{ m}^2/\text{s})^2} (0.7198) = 7.299 \times 10^6$$

We can treat this vertical cylinder as a vertical plate since

$$\frac{35L}{\text{Gr}^{1/4}} = \frac{35(0.12)}{(7.299 \times 10^6 / 0.7198)^{1/4}} = 0.07443 < 0.25 \quad \text{and thus } D \geq \frac{35L}{\text{Gr}^{1/4}}$$

Therefore,

$$\text{Nu} = \left\{ 0.825 + \frac{0.387\text{Ra}^{1/6}}{\left[1 + \left(\frac{0.492}{\text{Pr}} \right)^{9/16} \right]^{8/27}} \right\}^2 = \left\{ 0.825 + \frac{0.387(7.299 \times 10^6)^{1/6}}{\left[1 + \left(\frac{0.492}{0.7198} \right)^{9/16} \right]^{8/27}} \right\}^2 = 28.60$$

$$h = \frac{k}{L} \text{Nu} = \frac{0.02819 \text{ W/m}\cdot^\circ\text{C}}{0.12 \text{ m}} (28.60) = 6.720 \text{ W/m}^2\cdot^\circ\text{C}$$

$$A_s = \pi DL = \pi(0.25 \text{ m})(0.12 \text{ m}) = 0.09425 \text{ m}^2$$

and

$$\dot{Q} = hA_s(T_s - T_\infty) = (6.720 \text{ W/m}^2\cdot^\circ\text{C})(0.09425 \text{ m}^2)(98 - 25)^\circ\text{C} = \mathbf{46.2 \text{ W}}$$

(b) The radiation heat loss from the pan is

$$\begin{aligned} \dot{Q}_{rad} &= \varepsilon A_s \sigma (T_s^4 - T_{surr}^4) \\ &= (0.80)(0.09425 \text{ m}^2)(5.67 \times 10^{-8} \text{ W/m}^2\cdot\text{K}^4) \left[(98 + 273 \text{ K})^4 - (25 + 273 \text{ K})^4 \right] = \mathbf{47.3 \text{ W}} \end{aligned}$$

(c) The heat loss by the evaporation of water is

$$\dot{Q} = \dot{m} h_{fg} = (1.5 / 3600 \text{ kg/s})(2257 \text{ kJ/kg}) = 0.9404 \text{ kW} = 940 \text{ W}$$

Then the ratio of the heat lost from the side surfaces of the pan to that by the evaporation of water then becomes

$$f = \frac{46.2 + 47.3}{940} = 0.099 = \mathbf{9.9\%}$$

9-26 Water is boiling in a pan that is placed on top of a stove. The rate of heat loss from the cylindrical side surface of the pan by natural convection and radiation and the ratio of heat lost from the side surfaces of the pan to that by the evaporation of water are to be determined.

Assumptions 1 Steady operating conditions exist. 2 Air is an ideal gas with constant properties. 3 The local atmospheric pressure is 1 atm.

Properties The properties of air at 1 atm and the film temperature of $(T_s + T_\infty)/2 = (98 + 25)/2 = 61.5^\circ\text{C}$ are (Table A-15)

$$k = 0.02819 \text{ W/m}\cdot^\circ\text{C}$$

$$\nu = 1.910 \times 10^{-5} \text{ m}^2/\text{s}$$

$$\text{Pr} = 0.7198$$

$$\beta = \frac{1}{T_f} = \frac{1}{(61.5 + 273)\text{K}} = 0.00299 \text{ K}^{-1}$$

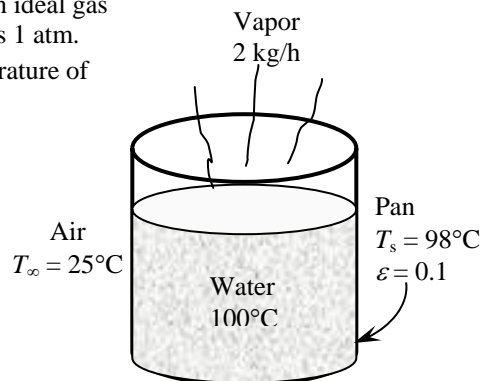

Analysis (a) The characteristic length in this case is the height of the pan, $L_c = L = 0.12 \text{ m}$. Then,

$$\text{Ra} = \frac{g\beta(T_s - T_\infty)L^3}{\nu^2} \text{Pr} = \frac{(9.81 \text{ m/s}^2)(0.00299 \text{ K}^{-1})(98 - 25 \text{ K})(0.12 \text{ m})^3}{(1.910 \times 10^{-5} \text{ m}^2/\text{s})^2} (0.7198) = 7.299 \times 10^6$$

We can treat this vertical cylinder as a vertical plate since

$$\frac{35L}{\text{Gr}^{1/4}} = \frac{35(0.12)}{(7.299 \times 10^6 / 0.7198)^{1/4}} = 0.07443 < 0.25 \quad \text{and thus } D \geq \frac{35L}{\text{Gr}^{1/4}}$$

Therefore,

$$\text{Nu} = \left\{ 0.825 + \frac{0.387\text{Ra}^{1/6}}{\left[1 + \left(\frac{0.492}{\text{Pr}} \right)^{9/16} \right]^{8/27}} \right\}^2 = \left\{ 0.825 + \frac{0.387(7.299 \times 10^6)^{1/6}}{\left[1 + \left(\frac{0.492}{0.7198} \right)^{9/16} \right]^{8/27}} \right\}^2 = 28.60$$

$$h = \frac{k}{L} \text{Nu} = \frac{0.02819 \text{ W/m}\cdot^\circ\text{C}}{0.12 \text{ m}} (28.60) = 6.720 \text{ W/m}^2\cdot^\circ\text{C}$$

$$A_s = \pi DL = \pi(0.25 \text{ m})(0.12 \text{ m}) = 0.09425 \text{ m}^2$$

and

$$\dot{Q} = hA_s(T_s - T_\infty) = (6.720 \text{ W/m}^2\cdot^\circ\text{C})(0.09425 \text{ m}^2)(98 - 25)^\circ\text{C} = \mathbf{46.2 \text{ W}}$$

(b) The radiation heat loss from the pan is

$$\begin{aligned} \dot{Q}_{rad} &= \varepsilon A_s \sigma (T_s^4 - T_{surr}^4) \\ &= (0.10)(0.09425 \text{ m}^2)(5.67 \times 10^{-8} \text{ W/m}^2\cdot\text{K}^4) \left[(98 + 273 \text{ K})^4 - (25 + 273 \text{ K})^4 \right] = \mathbf{5.9 \text{ W}} \end{aligned}$$

(c) The heat loss by the evaporation of water is

$$\dot{Q} = \dot{m} h_{fg} = (1.5 / 3600 \text{ kg/s})(2257 \text{ kJ/kg}) = 0.9404 \text{ kW} = 940 \text{ W}$$

Then the ratio of the heat lost from the side surfaces of the pan to that by the evaporation of water then becomes

$$f = \frac{46.2 + 5.9}{940} = 0.055 = \mathbf{5.5\%}$$

9-27 Some cans move slowly in a hot water container made of sheet metal. The rate of heat loss from the four side surfaces of the container and the annual cost of those heat losses are to be determined.

Assumptions 1 Steady operating conditions exist. 2 Air is an ideal gas with constant properties. 3 The local atmospheric pressure is 1 atm. 3 Heat loss from the top surface is disregarded.

Properties The properties of air at 1 atm and the film temperature of $(T_s + T_\infty)/2 = (55 + 20)/2 = 37.5^\circ\text{C}$ are (Table A-15)

$$k = 0.02644 \text{ W/m}\cdot^\circ\text{C}$$

$$\nu = 1.678 \times 10^{-5} \text{ m}^2/\text{s}$$

$$\text{Pr} = 0.7262$$

$$\beta = \frac{1}{T_f} = \frac{1}{(37.5 + 273)\text{K}} = 0.003221 \text{ K}^{-1}$$

Analysis The characteristic length in this case is the height of the bath, $L_c = L = 0.5 \text{ m}$. Then,

$$\text{Ra} = \frac{g\beta(T_s - T_\infty)L^3}{\nu^2} \text{Pr} = \frac{(9.81 \text{ m/s}^2)(0.003221 \text{ K}^{-1})(55 - 20 \text{ K})(0.5 \text{ m})^3}{(1.678 \times 10^{-5} \text{ m}^2/\text{s})^2} (0.7262) = 3.565 \times 10^8$$

$$\text{Nu} = \left\{ 0.825 + \frac{0.387\text{Ra}^{1/6}}{\left[1 + \left(\frac{0.492}{\text{Pr}} \right)^{9/16} \right]^{8/27}} \right\}^2 = \left\{ 0.825 + \frac{0.387(3.565 \times 10^8)^{1/6}}{\left[1 + \left(\frac{0.492}{0.7261} \right)^{9/16} \right]^{8/27}} \right\}^2 = 89.84$$

$$h = \frac{k}{L} \text{Nu} = \frac{0.02644 \text{ W/m}\cdot^\circ\text{C}}{0.5 \text{ m}} (89.84) = 4.75 \text{ W/m}^2 \cdot ^\circ\text{C}$$

$$A_s = 2[(0.5 \text{ m})(1 \text{ m}) + (0.5 \text{ m})(3.5 \text{ m})] = 4.5 \text{ m}^2$$

and

$$\dot{Q} = hA_s(T_s - T_\infty) = (4.75 \text{ W/m}^2 \cdot ^\circ\text{C})(4.5 \text{ m}^2)(55 - 20)^\circ\text{C} = 748.1 \text{ W}$$

The radiation heat loss is

$$\begin{aligned} \dot{Q}_{rad} &= \varepsilon A_s \sigma (T_s^4 - T_{surr}^4) \\ &= (0.7)(4.5 \text{ m}^2)(5.67 \times 10^{-8} \text{ W/m}^2 \cdot \text{K}^4) [(55 + 273 \text{ K})^4 - (20 + 273 \text{ K})^4] = 750.9 \text{ W} \end{aligned}$$

Then the total rate of heat loss becomes

$$\dot{Q}_{total} = \dot{Q}_{natural\ convection} + \dot{Q}_{rad} = 748.1 + 750.9 = \mathbf{1499 \text{ W}}$$

The amount and cost of the heat loss during one year is

$$Q_{total} = \dot{Q}_{total} \Delta t = (1.499 \text{ kW})(8760 \text{ h}) = 13,131 \text{ kWh}$$

$$\text{Cost} = (13,131 \text{ kWh})(\$0.085 / \text{kWh}) = \mathbf{\$1116}$$

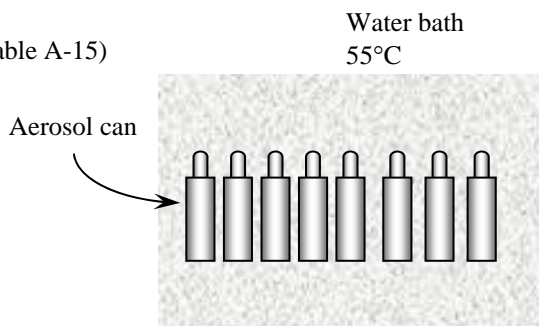

9-28 Some cans move slowly in a hot water container made of sheet metal. It is proposed to insulate the side and bottom surfaces of the container for \$350. The simple payback period of the insulation to pay for itself from the energy it saves is to be determined.

Assumptions 1 Steady operating conditions exist. **2** Air is an ideal gas with constant properties. **3** The local atmospheric pressure is 1 atm. **3** Heat loss from the top surface is disregarded.

Properties Insulation will drop the outer surface temperature to a value close to the ambient temperature. The solution of this problem requires a trial-and-error approach since the determination of the Rayleigh number and thus the Nusselt number depends on the surface temperature, which is unknown. We assume the surface temperature to be 26°C. The properties of air at the anticipated film temperature of $(26+20)/2=23^\circ\text{C}$ are (Table A-15)

$$k = 0.02536 \text{ W/m}\cdot^\circ\text{C}$$

$$\nu = 1.543 \times 10^{-5} \text{ m}^2/\text{s}$$

$$\text{Pr} = 0.7301$$

$$\beta = \frac{1}{T_f} = \frac{1}{(23+273)\text{K}} = 0.00338 \text{ K}^{-1}$$

Analysis We start the solution process by “guessing” the outer surface temperature to be 26°C. We will check the accuracy of this guess later and repeat the calculations if necessary with a better guess based on the results obtained. The characteristic length in this case is the height of the tank, $L_c = L = 0.5 \text{ m}$. Then,

$$\text{Ra} = \frac{g\beta(T_s - T_\infty)L^3}{\nu^2} \text{Pr} = \frac{(9.81 \text{ m/s}^2)(0.00338 \text{ K}^{-1})(26 - 20 \text{ K})(0.5 \text{ m})^3}{(1.543 \times 10^{-5} \text{ m}^2/\text{s})^2} (0.7301) = 7.622 \times 10^7$$

$$\text{Nu} = \left\{ 0.825 + \frac{0.387\text{Ra}^{1/6}}{\left[1 + \left(\frac{0.492}{\text{Pr}} \right)^{9/16} \right]^{8/27}} \right\}^2 = \left\{ 0.825 + \frac{0.387(7.622 \times 10^7)^{1/6}}{\left[1 + \left(\frac{0.492}{0.7301} \right)^{9/16} \right]^{8/27}} \right\}^2 = 56.53$$

$$h = \frac{k}{L} \text{Nu} = \frac{0.02536 \text{ W/m}\cdot^\circ\text{C}}{0.5 \text{ m}} (56.53) = 2.868 \text{ W/m}^2\cdot^\circ\text{C}$$

$$A_s = 2[(0.5 \text{ m})(1.10 \text{ m}) + (0.5 \text{ m})(3.60 \text{ m})] = 4.7 \text{ m}^2$$

Then the total rate of heat loss from the outer surface of the insulated tank by convection and radiation becomes

$$\begin{aligned} \dot{Q} &= \dot{Q}_{conv} + \dot{Q}_{rad} = hA_s(T_s - T_\infty) + \varepsilon A_s \sigma (T_s^4 - T_{surr}^4) \\ &= (2.868 \text{ W/m}^2\cdot^\circ\text{C})(4.7 \text{ m}^2)(26 - 20)^\circ\text{C} \\ &\quad + (0.1)(4.7 \text{ m}^2)(5.67 \times 10^{-8} \text{ W/m}^2\cdot\text{K}^4)[(26 + 273 \text{ K})^4 - (20 + 273 \text{ K})^4] \\ &= 97.5 \text{ W} \end{aligned}$$

In steady operation, the heat lost by the side surfaces of the tank must be equal to the heat lost from the exposed surface of the insulation by convection and radiation, which must be equal to the heat conducted through the insulation. The second condition requires the surface temperature to be

$$\dot{Q} = \dot{Q}_{insulation} = kA_s \frac{T_{\text{tank}} - T_s}{L} \rightarrow 97.5 \text{ W} = (0.035 \text{ W/m}\cdot^\circ\text{C})(4.7 \text{ m}^2) \frac{(55 - T_s)^\circ\text{C}}{0.05 \text{ m}}$$

It gives $T_s = 25.38^\circ\text{C}$, which is very close to the assumed temperature, 26°C. Therefore, there is no need to repeat the calculations.

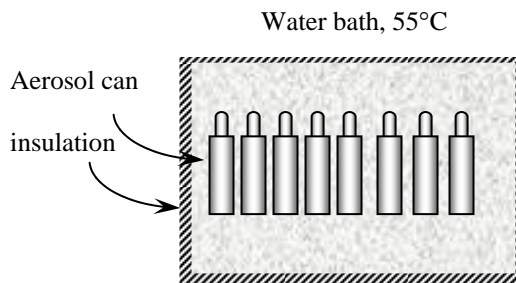

The total amount of heat loss and its cost during one year are

$$Q_{total} = \dot{Q}_{total} \Delta t = (97.5 \text{ W})(8760 \text{ h}) = 853.7 \text{ kWh}$$

$$\text{Cost} = (853.7 \text{ kWh})(\$0.085 / \text{kWh}) = \$72.6$$

Then money saved during a one-year period due to insulation becomes

$$\text{Money saved} = \text{Cost}_{\text{without insulation}} - \text{Cost}_{\text{with insulation}} = \$1116 - \$72.6 = \$1043$$

where \$1116 is obtained from the solution of Problem 9-28. The insulation will pay for itself in

$$\text{Payback period} = \frac{\text{Cost}}{\text{Money saved}} = \frac{\$350}{\$1043 / \text{yr}} = \mathbf{0.3354 \text{ yr} = 122 \text{ days}}$$

Discussion We would definitely recommend the installation of insulation in this case.

9-29 A printed circuit board (PCB) is placed in a room. The average temperature of the hot surface of the board is to be determined for different orientations.

Assumptions 1 Steady operating conditions exist. **2** Air is an ideal gas with constant properties. **3** The local atmospheric pressure is 1 atm. **3** The heat loss from the back surface of the board is negligible.

Properties The properties of air at 1 atm and the anticipated film temperature of $(T_s + T_\infty)/2 = (45 + 20)/2 = 32.5^\circ\text{C}$ are (Table A-15)

$$k = 0.02607 \text{ W/m}\cdot^\circ\text{C}$$

$$\nu = 1.631 \times 10^{-5} \text{ m}^2/\text{s}$$

$$\text{Pr} = 0.7275$$

$$\beta = \frac{1}{T_f} = \frac{1}{(32.5 + 273)\text{K}} = 0.003273 \text{ K}^{-1}$$

Analysis The solution of this problem requires a trial-and-error approach since the determination of the Rayleigh number and thus the Nusselt number depends on the surface temperature which is unknown

(a) **Vertical PCB**. We start the solution process by “guessing” the surface temperature to be 45°C for the evaluation of the properties and h . We will check the accuracy of this guess later and repeat the calculations if necessary. The characteristic length in this case is the height of the PCB, $L_c = L = 0.2 \text{ m}$. Then,

$$\text{Ra} = \frac{g\beta(T_s - T_\infty)L^3}{\nu^2} \text{Pr} = \frac{(9.81 \text{ m/s}^2)(0.003273 \text{ K}^{-1})(45 - 20 \text{ K})(0.2 \text{ m})^3}{(1.631 \times 10^{-5} \text{ m}^2/\text{s})^2} (0.7275) = 1.756 \times 10^7$$

$$\text{Nu} = \left\{ 0.825 + \frac{0.387\text{Ra}^{1/6}}{\left[1 + \left(\frac{0.492}{\text{Pr}} \right)^{9/16} \right]^{8/27}} \right\}^2 = \left\{ 0.825 + \frac{0.387(1.756 \times 10^7)^{1/6}}{\left[1 + \left(\frac{0.492}{0.7275} \right)^{9/16} \right]^{8/27}} \right\}^2 = 36.78$$

$$h = \frac{k}{L} \text{Nu} = \frac{0.02607 \text{ W/m}\cdot^\circ\text{C}}{0.2 \text{ m}} (36.78) = 4.794 \text{ W/m}^2\cdot^\circ\text{C}$$

$$A_s = (0.15 \text{ m})(0.2 \text{ m}) = 0.03 \text{ m}^2$$

Heat loss by both natural convection and radiation heat can be expressed as

$$\dot{Q} = hA_s(T_s - T_\infty) + \varepsilon A_s \sigma (T_s^4 - T_{\text{surr}}^4)$$

$$8 \text{ W} = (4.794 \text{ W/m}^2\cdot^\circ\text{C})(0.03 \text{ m}^2)(T_s - 20)^\circ\text{C} + (0.8)(0.03 \text{ m}^2)(5.67 \times 10^{-8}) \left[(T_s + 273)^4 - (20 + 273 \text{ K})^4 \right]$$

Its solution is

$$T_s = 46.6^\circ\text{C}$$

which is sufficiently close to the assumed value of 45°C for the evaluation of the properties and h .

(b) **Horizontal, hot surface facing up** Again we assume the surface temperature to be 45°C and use the properties evaluated above. The characteristic length in this case is

$$L_c = \frac{A_s}{p} = \frac{(0.20 \text{ m})(0.15 \text{ m})}{2(0.2 \text{ m} + 0.15 \text{ m})} = 0.0429 \text{ m}$$

Then

$$\text{Ra} = \frac{g\beta(T_s - T_\infty)L_c^3}{\nu^2} \text{Pr} = \frac{(9.81 \text{ m/s}^2)(0.003273 \text{ K}^{-1})(45 - 20 \text{ K})(0.0429 \text{ m})^3}{(1.631 \times 10^{-5} \text{ m}^2/\text{s})^2} (0.7275) = 1.728 \times 10^5$$

$$\text{Nu} = 0.54\text{Ra}^{1/4} = 0.54(1.728 \times 10^5)^{1/4} = 11.01$$

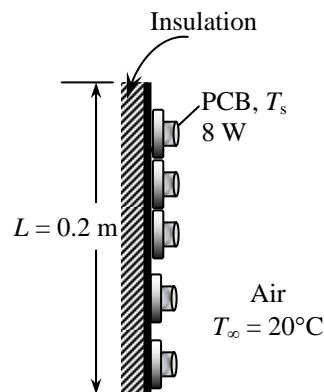

$$h = \frac{k}{L_c} Nu = \frac{0.02607 \text{ W/m}\cdot\text{°C}}{0.0429 \text{ m}} (11.01) = 6.696 \text{ W/m}^2\cdot\text{°C}$$

Heat loss by both natural convection and radiation heat can be expressed as

$$\begin{aligned} \dot{Q} &= hA_s(T_s - T_\infty) + \varepsilon A_s \sigma (T_s^4 - T_{surr}^4) \\ 8 \text{ W} &= (6.696 \text{ W/m}^2\cdot\text{°C})(0.03 \text{ m}^2)(T_s - 20)\text{°C} + (0.8)(0.03 \text{ m}^2)(5.67 \times 10^{-8})[(T_s + 273)^4 - (20 + 273 \text{ K})^4] \end{aligned}$$

Its solution is

$$T_s = \mathbf{42.6\text{°C}}$$

which is sufficiently close to the assumed value of 45°C in the evaluation of the properties and h .

(c) **Horizontal, hot surface facing down** This time we expect the surface temperature to be higher, and assume the surface temperature to be 50°C. We will check this assumption after obtaining result and repeat calculations with a better assumption, if necessary. The properties of air at the film temperature of $(50+20)/2=35\text{°C}$ are (Table A-15)

$$k = 0.02625 \text{ W/m}\cdot\text{°C}$$

$$\nu = 1.655 \times 10^{-5} \text{ m}^2/\text{s}$$

$$\text{Pr} = 0.7268$$

$$\beta = \frac{1}{T_f} = \frac{1}{(35 + 273)\text{K}} = 0.003247 \text{ K}^{-1}$$

The characteristic length in this case is, from part (b), $L_c = 0.0429 \text{ m}$. Then,

$$Ra = \frac{g\beta(T_s - T_\infty)L_c^3}{\nu^2} \text{Pr} = \frac{(9.81 \text{ m/s}^2)(0.003247 \text{ K}^{-1})(50 - 20 \text{ K})(0.0429 \text{ m})^3}{(1.655 \times 10^{-5} \text{ m}^2/\text{s})^2} (0.7268) = 200,200$$

$$Nu = 0.27 Ra^{1/4} = 0.27(200,200)^{1/4} = 5.711$$

$$h = \frac{k}{L_c} Nu = \frac{0.02625 \text{ W/m}\cdot\text{°C}}{0.0429 \text{ m}} (5.711) = 3.494 \text{ W/m}^2\cdot\text{°C}$$

Considering both natural convection and radiation heat losses

$$\begin{aligned} \dot{Q} &= hA_s(T_s - T_\infty) + \varepsilon A_s \sigma (T_s^4 - T_{surr}^4) \\ 8 \text{ W} &= (3.494 \text{ W/m}^2\cdot\text{°C})(0.03 \text{ m}^2)(T_s - 20)\text{°C} + (0.8)(0.03 \text{ m}^2)(5.67 \times 10^{-8})[(T_s + 273)^4 - (20 + 273 \text{ K})^4] \end{aligned}$$

Its solution is

$$T_s = \mathbf{50.3\text{°C}}$$

which is very close to the assumed value. Therefore, there is no need to repeat calculations.

9-30 EES Prob. 9-29 is reconsidered. The effects of the room temperature and the emissivity of the board on the temperature of the hot surface of the board for different orientations of the board are to be investigated.

Analysis The problem is solved using EES, and the solution is given below.

"GIVEN"

L=0.2 [m]
w=0.15 [m]
T_infinity=20 [C]
Q_dot=8 [W]
epsilon=0.8
T_surr=T_infinity

"PROPERTIES"

Fluid\$='air'
k=Conductivity(Fluid\$, T=T_film)
Pr=Prandtl(Fluid\$, T=T_film)
rho=Density(Fluid\$, T=T_film, P=101.3)
mu=Viscosity(Fluid\$, T=T_film)
nu=mu/rho
beta=1/(T_film+273)
T_film=1/2*(T_s_a+T_infinity)
sigma=5.67E-8 [W/m^2-K^4] "Stefan-Boltzmann constant"
g=9.807 [m/s^2] "gravitational acceleration"

"ANALYSIS"

"(a), plate is vertical"

delta_a=L
Ra_a=(g*beta*(T_s_a-T_infinity)*delta_a^3)/nu^2*Pr
Nusselt_a=0.59*Ra_a^0.25
h_a=k/delta_a*Nusselt_a
A=w*L
Q_dot=h_a*A*(T_s_a-T_infinity)+epsilon*A*sigma*((T_s_a+273)^4-(T_surr+273)^4)

"(b), plate is horizontal with hot surface facing up"

delta_b=A/p
p=2*(w+L)
Ra_b=(g*beta*(T_s_b-T_infinity)*delta_b^3)/nu^2*Pr
Nusselt_b=0.54*Ra_b^0.25
h_b=k/delta_b*Nusselt_b
Q_dot=h_b*A*(T_s_b-T_infinity)+epsilon*A*sigma*((T_s_b+273)^4-(T_surr+273)^4)

"(c), plate is horizontal with hot surface facing down"

delta_c=delta_b
Ra_c=Ra_b
Nusselt_c=0.27*Ra_c^0.25
h_c=k/delta_c*Nusselt_c
Q_dot=h_c*A*(T_s_c-T_infinity)+epsilon*A*sigma*((T_s_c+273)^4-(T_surr+273)^4)

T_{∞} [F]	$T_{s,a}$ [C]	$T_{s,b}$ [C]	$T_{s,c}$ [C]
5	32.54	28.93	38.29
7	34.34	30.79	39.97
9	36.14	32.65	41.66
11	37.95	34.51	43.35
13	39.75	36.36	45.04
15	41.55	38.22	46.73
17	43.35	40.07	48.42
19	45.15	41.92	50.12
21	46.95	43.78	51.81
23	48.75	45.63	53.51
25	50.55	47.48	55.21
27	52.35	49.33	56.91
29	54.16	51.19	58.62
31	55.96	53.04	60.32
33	57.76	54.89	62.03
35	59.56	56.74	63.74

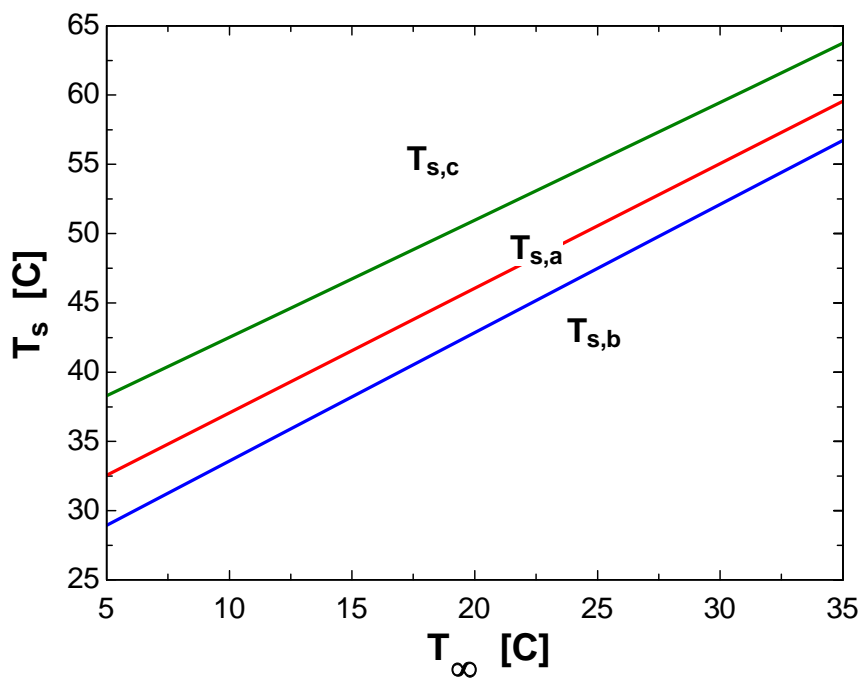

9-31 Absorber plates whose back side is heavily insulated is placed horizontally outdoors. Solar radiation is incident on the plate. The equilibrium temperature of the plate is to be determined for two cases.

Assumptions 1 Steady operating conditions exist. **2** Air is an ideal gas with constant properties. **3** The local atmospheric pressure is 1 atm.

Properties The properties of air at 1 atm and the anticipated film temperature of $(T_s + T_\infty)/2 = (115 + 25)/2 = 70^\circ\text{C}$ are (Table A-15)

$$k = 0.02881 \text{ W/m}\cdot^\circ\text{C}$$

$$\nu = 1.995 \times 10^{-5} \text{ m}^2/\text{s}$$

$$\text{Pr} = 0.7177$$

$$\beta = \frac{1}{T_f} = \frac{1}{(70 + 273)\text{K}} = 0.002915 \text{ K}^{-1}$$

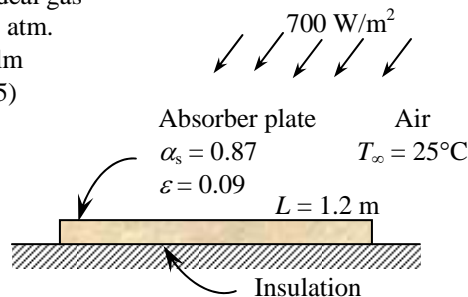

Analysis The solution of this problem requires a trial-and-error approach since the determination of the Rayleigh number and thus the Nusselt number depends on the surface temperature which is unknown. We start the solution process by “guessing” the surface temperature to be 115°C for the evaluation of the properties and h . We will check the accuracy of this guess later and repeat the calculations if necessary. The

characteristic length in this case is $L_c = \frac{A_s}{p} = \frac{(1.2 \text{ m})(0.8 \text{ m})}{2(1.2 \text{ m} + 0.8 \text{ m})} = 0.24 \text{ m}$. Then,

$$Ra = \frac{g\beta(T_s - T_\infty)L_c^3}{\nu^2} \text{Pr} = \frac{(9.81 \text{ m/s}^2)(0.002915 \text{ K}^{-1})(115 - 25 \text{ K})(0.24 \text{ m})^3}{(1.995 \times 10^{-5} \text{ m}^2/\text{s})^2} (0.7177) = 6.414 \times 10^7$$

$$Nu = 0.54Ra^{1/4} = 0.54(6.414 \times 10^7)^{1/4} = 48.33$$

$$h = \frac{k}{L_c} Nu = \frac{0.02881 \text{ W/m}\cdot^\circ\text{C}}{0.24 \text{ m}} (48.33) = 5.801 \text{ W/m}^2\cdot^\circ\text{C}$$

$$A_s = (0.8 \text{ m})(1.2 \text{ m}) = 0.96 \text{ m}^2$$

In steady operation, the heat gain by the plate by absorption of solar radiation must be equal to the heat loss by natural convection and radiation. Therefore,

$$\dot{Q} = \alpha \dot{q} A_s = (0.87)(700 \text{ W/m}^2)(0.96 \text{ m}^2) = 584.6 \text{ W}$$

$$\dot{Q} = hA_s(T_s - T_\infty) + \varepsilon A_s \sigma (T_s^4 - T_{\text{sky}}^4)$$

$$584.6 \text{ W} = (5.801 \text{ W/m}^2\cdot^\circ\text{C})(0.96 \text{ m}^2)(T_s - 25)^\circ\text{C} + (0.09)(0.96 \text{ m}^2)(5.67 \times 10^{-8})[(T_s + 273)^4 - (10 + 273 \text{ K})^4]$$

Its solution is $T_s = \mathbf{115.6^\circ\text{C}}$

which is identical to the assumed value. Therefore there is no need to repeat calculations.

If the absorber plate is made of ordinary aluminum which has a solar absorptivity of 0.28 and an emissivity of 0.07, the rate of solar gain becomes

$$\dot{Q} = \alpha \dot{q} A_s = (0.28)(700 \text{ W/m}^2)(0.96 \text{ m}^2) = 188.2 \text{ W}$$

Again noting that in steady operation the heat gain by the plate by absorption of solar radiation must be equal to the heat loss by natural convection and radiation, and using the convection coefficient determined above for convenience,

$$\dot{Q} = hA_s(T_s - T_\infty) + \varepsilon A_s \sigma (T_s^4 - T_{\text{sky}}^4)$$

$$188.2 \text{ W} = (5.801 \text{ W/m}^2\cdot^\circ\text{C})(0.96 \text{ m}^2)(T_s - 25)^\circ\text{C} + (0.07)(0.96 \text{ m}^2)(5.67 \times 10^{-8})[(T_s + 273)^4 - (10 + 273 \text{ K})^4]$$

Its solution is $T_s = \mathbf{55.2^\circ\text{C}}$

Repeating the calculations at the new film temperature of 40°C , we obtain

$$h = 4.524 \text{ W/m}^2\cdot^\circ\text{C} \text{ and } T_s = \mathbf{62.8^\circ\text{C}}$$

9-32 An absorber plate whose back side is heavily insulated is placed horizontally outdoors. Solar radiation is incident on the plate. The equilibrium temperature of the plate is to be determined for two cases.

Assumptions 1 Steady operating conditions exist. **2** Air is an ideal gas with constant properties. **3** The local atmospheric pressure is 1 atm.

Properties The properties of air at 1 atm and the anticipated film temperature of $(T_s + T_\infty)/2 = (70 + 25)/2 = 47.5^\circ\text{C}$ are (Table A-15)

$$k = 0.02717 \text{ W/m}\cdot^\circ\text{C}$$

$$\nu = 1.774 \times 10^{-5} \text{ m}^2/\text{s}$$

$$\text{Pr} = 0.7235$$

$$\beta = \frac{1}{T_f} = \frac{1}{(47.5 + 273)\text{K}} = 0.00312 \text{ K}^{-1}$$

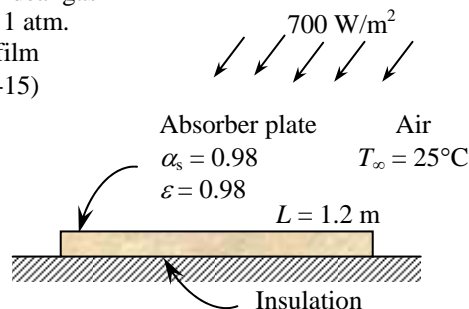

Analysis The solution of this problem requires a trial-and-error approach since the determination of the Rayleigh number and thus the Nusselt number depends on the surface temperature which is unknown. We start the solution process by “guessing” the surface temperature to be 70°C for the evaluation of the properties and h . We will check the accuracy of this guess later and repeat the calculations if necessary. The

characteristic length in this case is $L_c = \frac{A_s}{p} = \frac{(1.2 \text{ m})(0.8 \text{ m})}{2(1.2 \text{ m} + 0.8 \text{ m})} = 0.24 \text{ m}$. Then,

$$\text{Ra} = \frac{g\beta(T_s - T_\infty)L_c^3}{\nu^2} \text{Pr} = \frac{(9.81 \text{ m/s}^2)(0.00312 \text{ K}^{-1})(70 - 25 \text{ K})(0.24 \text{ m})^3}{(1.774 \times 10^{-5} \text{ m}^2/\text{s})^2} (0.7235) = 4.379 \times 10^7$$

$$\text{Nu} = 0.54\text{Ra}^{1/4} = 0.54(4.379 \times 10^7)^{1/4} = 43.93$$

$$h = \frac{k}{L_c} \text{Nu} = \frac{0.02717 \text{ W/m}\cdot^\circ\text{C}}{0.24 \text{ m}} (43.93) = 4.973 \text{ W/m}^2\cdot^\circ\text{C}$$

$$A_s = (0.8 \text{ m})(1.2 \text{ m}) = 0.96 \text{ m}^2$$

In steady operation, the heat gain by the plate by absorption of solar radiation must be equal to the heat loss by natural convection and radiation. Therefore,

$$\dot{Q} = \alpha \dot{q} A_s = (0.98)(700 \text{ W/m}^2)(0.96 \text{ m}^2) = 658.6 \text{ W}$$

$$\dot{Q} = hA_s(T_s - T_\infty) + \varepsilon A_s \sigma (T_s^4 - T_{\text{surr}}^4)$$

$$658.6 \text{ W} = (4.973 \text{ W/m}^2\cdot^\circ\text{C})(0.96 \text{ m}^2)(T_s - 25)^\circ\text{C} \\ + (0.98)(0.96 \text{ m}^2)(5.67 \times 10^{-8})[(T_s + 273)^4 - (10 + 273 \text{ K})^4]$$

Its solution is $T_s = 73.5^\circ\text{C}$

which is close to the assumed value. Therefore there is no need to repeat calculations.

For a white painted absorber plate, the solar absorptivity is 0.26 and the emissivity is 0.90. Then the rate of solar gain becomes

$$\dot{Q} = \alpha \dot{q} A_s = (0.26)(700 \text{ W/m}^2)(0.96 \text{ m}^2) = 174.7 \text{ W}$$

Again noting that in steady operation the heat gain by the plate by absorption of solar radiation must be equal to the heat loss by natural convection and radiation, and using the convection coefficient determined above for convenience (actually, we should calculate the new h using data at a lower temperature, and iterating if necessary for better accuracy),

$$\dot{Q} = hA_s(T_s - T_\infty) + \varepsilon A_s \sigma (T_s^4 - T_{\text{surr}}^4)$$

$$174.7 \text{ W} = (4.973 \text{ W/m}^2\cdot^\circ\text{C})(0.96 \text{ m}^2)(T_s - 25)^\circ\text{C} \\ + (0.90)(0.96 \text{ m}^2)(5.67 \times 10^{-8})[(T_s + 273)^4 - (10 + 273 \text{ K})^4]$$

Its solution is $T_s = 35.0^\circ\text{C}$

Discussion If we recalculated the h using air properties at 30°C , we would obtain

$$h = 3.47 \text{ W/m}^2\cdot^\circ\text{C} \text{ and } T_s = 36.6^\circ\text{C}$$

9-33 A resistance heater is placed along the centerline of a horizontal cylinder whose two circular side surfaces are well insulated. The natural convection heat transfer coefficient and whether the radiation effect is negligible are to be determined.

Assumptions 1 Steady operating conditions exist. 2 Air is an ideal gas with constant properties. 3 The local atmospheric pressure is 1 atm.

Analysis The heat transfer surface area of the cylinder is

$$A = \pi DL = \pi(0.02 \text{ m})(0.8 \text{ m}) = 0.05027 \text{ m}^2$$

Noting that in steady operation the heat dissipated from the outer surface must equal to the electric power consumed, and radiation is negligible, the convection heat transfer is determined to be

$$\dot{Q} = hA_s(T_s - T_\infty) \rightarrow h = \frac{\dot{Q}}{A_s(T_s - T_\infty)} = \frac{60 \text{ W}}{(0.05027 \text{ m}^2)(120 - 20)^\circ\text{C}} = \mathbf{11.9 \text{ W/m}^2 \cdot ^\circ\text{C}}$$

The radiation heat loss from the cylinder is

$$\begin{aligned} \dot{Q}_{rad} &= \varepsilon A_s \sigma (T_s^4 - T_{surr}^4) \\ &= (0.1)(0.05027 \text{ m}^2)(5.67 \times 10^{-8} \text{ W/m}^2 \cdot \text{K}^4)[(120 + 273 \text{ K})^4 - (20 + 273 \text{ K})^4] = 4.7 \text{ W} \end{aligned}$$

Therefore, the fraction of heat loss by radiation is

$$\text{Radiation fraction} = \frac{\dot{Q}_{radiation}}{\dot{Q}_{total}} = \frac{4.7 \text{ W}}{60 \text{ W}} = 0.078 = 7.8\%$$

which is greater than 5%. Therefore, the radiation effect is still more than acceptable, and corrections must be made for the radiation effect.

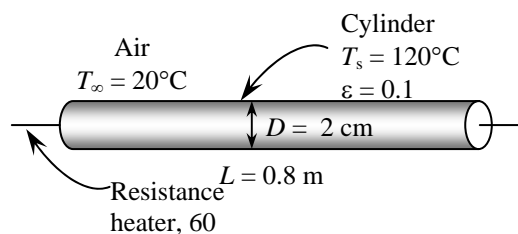

9-34 A thick fluid flows through a pipe in calm ambient air. The pipe is heated electrically. The power rating of the electric resistance heater and the cost of electricity during a 10-h period are to be determined. \checkmark
Assumptions 1 Steady operating conditions exist. 2 Air is an ideal gas with constant properties. 3 The local atmospheric pressure is 1 atm.

Properties The properties of air at 1 atm and the film temperature of $(T_s + T_\infty)/2 = (25 + 0)/2 = 12.5^\circ\text{C}$ (Table A-15)

$$k = 0.02458 \text{ W/m}\cdot^\circ\text{C}$$

$$\nu = 1.448 \times 10^{-5} \text{ m}^2/\text{s}$$

$$\text{Pr} = 0.7330$$

$$\beta = \frac{1}{T_f} = \frac{1}{(12.5 + 273)\text{K}} = 0.003503 \text{ K}^{-1}$$

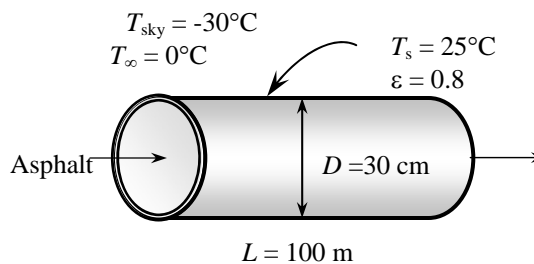

Analysis The characteristic length in this case is the outer diameter of the pipe, $L_c = D = 0.3 \text{ m}$. Then,

$$Ra = \frac{g\beta(T_s - T_\infty)L_c^3}{\nu^2} \text{Pr} = \frac{(9.81 \text{ m/s}^2)(0.003503 \text{ K}^{-1})(25 - 0 \text{ K})(0.3 \text{ m})^3}{(1.448 \times 10^{-5} \text{ m}^2/\text{s})^2} (0.7330) = 8.106 \times 10^7$$

$$Nu = \left\{ 0.6 + \frac{0.387 Ra^{1/6}}{\left[1 + (0.559 / \text{Pr})^{9/16} \right]^{8/27}} \right\}^2 = \left\{ 0.6 + \frac{0.387 (8.106 \times 10^7)^{1/6}}{\left[1 + (0.559 / 0.7330)^{9/16} \right]^{8/27}} \right\}^2 = 53.29$$

$$h = \frac{k}{L_c} Nu = \frac{0.02458 \text{ W/m}\cdot^\circ\text{C}}{0.3 \text{ m}} (53.29) = 4.366 \text{ W/m}^2\cdot^\circ\text{C}$$

$$A_s = \pi DL = \pi(0.3 \text{ m})(100 \text{ m}) = 94.25 \text{ m}^2$$

and

$$\dot{Q} = hA_s(T_s - T_\infty) = (4.366 \text{ W/m}^2\cdot^\circ\text{C})(94.25 \text{ m}^2)(25 - 0)^\circ\text{C} = 10,287 \text{ W}$$

The radiation heat loss from the cylinder is

$$\begin{aligned} \dot{Q}_{rad} &= \varepsilon A_s \sigma (T_s^4 - T_{surr}^4) \\ &= (0.8)(94.25 \text{ m}^2)(5.67 \times 10^{-8} \text{ W/m}^2\cdot\text{K}^4)[(25 + 273 \text{ K})^4 - (-30 + 273 \text{ K})^4] = 18,808 \text{ W} \end{aligned}$$

Then,

$$\dot{Q}_{total} = \dot{Q}_{\substack{\text{natural} \\ \text{convection}}} + \dot{Q}_{\text{radiation}} = 10,287 + 18,808 = 29,094 \text{ W} = \mathbf{29.1 \text{ kW}}$$

The total amount and cost of heat loss during a 10 hour period is

$$Q = \dot{Q} \Delta t = (29.1 \text{ kW})(10 \text{ h}) = 290.9 \text{ kWh}$$

$$\text{Cost} = (290.9 \text{ kWh})(\$0.09/\text{kWh}) = \mathbf{\$26.18}$$

9-35 A fluid flows through a pipe in calm ambient air. The pipe is heated electrically. The thickness of the insulation needed to reduce the losses by 85% and the money saved during 10-h are to be determined.

Assumptions 1 Steady operating conditions exist. **2** Air is an ideal gas with constant properties. **3** The local atmospheric pressure is 1 atm.

Properties Insulation will drop the outer surface temperature to a value close to the ambient temperature, and possibly below it because of the very low sky temperature for radiation heat loss. For convenience, we use the properties of air at 1 atm and 5°C (the anticipated film temperature) (Table A-15),

$$k = 0.02401 \text{ W/m}\cdot\text{°C}$$

$$\nu = 1.382 \times 10^{-5} \text{ m}^2/\text{s}$$

$$\text{Pr} = 0.7350$$

$$\beta = \frac{1}{T_f} = \frac{1}{(5 + 273)\text{K}} = 0.003597 \text{ K}^{-1}$$

Analysis The rate of heat loss in the previous problem was obtained to be 29,094 W. Noting that insulation will cut down the heat losses by 85%, the rate of heat loss will be

$$\dot{Q} = (1 - 0.85)\dot{Q}_{\text{no insulation}} = 0.15 \times 29,094 \text{ W} = 4364 \text{ W}$$

The amount of energy and money insulation will save during a 10-h period is simply determined from

$$Q_{\text{saved, total}} = \dot{Q}_{\text{saved}} \Delta t = (0.85 \times 29,094 \text{ kW})(10 \text{ h}) = 247.3 \text{ kWh}$$

$$\text{Money saved} = (\text{Energy saved})(\text{Unit cost of energy}) = (247.3 \text{ kWh})(\$0.09 / \text{kWh}) = \mathbf{\$22.26}$$

The characteristic length in this case is the outer diameter of the insulated pipe,

$L_c = D + 2t_{\text{insul}} = 0.3 + 2t_{\text{insul}}$ where t_{insul} is the thickness of insulation in m. Then the problem can be formulated for T_s and t_{insul} as follows:

$$Ra = \frac{g\beta(T_s - T_\infty)L_c^3}{\nu^2} \text{Pr} = \frac{(9.81 \text{ m/s}^2)(0.003597 \text{ K}^{-1})(T_s - 273)\text{K}(0.3 + 2t_{\text{insul}})^3}{(1.382 \times 10^{-5} \text{ m}^2/\text{s})^2} (0.7350)$$

$$Nu = \left\{ 0.6 + \frac{0.387 Ra^{1/6}}{\left[1 + (0.559 / \text{Pr})^{9/16} \right]^{8/27}} \right\}^2 = \left\{ 0.6 + \frac{0.387 Ra^{1/6}}{\left[1 + (0.559 / 0.7350)^{9/16} \right]^{8/27}} \right\}^2$$

$$h = \frac{k}{L_c} Nu = \frac{0.02401 \text{ W/m}\cdot\text{°C}}{L_c} Nu$$

$$A_s = \pi D_0 L = \pi(0.3 + 2t_{\text{insul}})(100 \text{ m})$$

The total rate of heat loss from the outer surface of the insulated pipe by convection and radiation becomes

$$\dot{Q} = \dot{Q}_{\text{conv}} + \dot{Q}_{\text{rad}} = hA_s(T_s - T_\infty) + \varepsilon A_s \sigma (T_s^4 - T_{\text{surr}}^4)$$

$$4364 = hA_s(T_s - 273) + (0.1)A_s(5.67 \times 10^{-8} \text{ W/m}^2 \cdot \text{K}^4)[T_s^4 - (-30 + 273 \text{ K})^4]$$

In steady operation, the heat lost by the side surfaces of the pipe must be equal to the heat lost from the exposed surface of the insulation by convection and radiation, which must be equal to the heat conducted through the insulation. Therefore,

$$\dot{Q} = \dot{Q}_{\text{insulation}} = \frac{2\pi k L (T_{\text{tank}} - T_s)}{\ln(D_o / D)} \rightarrow 4364 \text{ W} = \frac{2\pi(0.035 \text{ W/m}\cdot\text{°C})(100 \text{ m})(298 - T_s)\text{K}}{\ln[(0.3 + 2t_{\text{insul}}) / 0.3]}$$

The solution of all of the equations above simultaneously using an equation solver gives $T_s = 281.5 \text{ K} = 8.5\text{°C}$ and $t_{\text{insul}} = \mathbf{0.013 \text{ m} = 1.3 \text{ cm}}$.

Note that the film temperature is $(8.5 + 0)/2 = 4.25\text{°C}$ which is very close to the assumed value of 5°C. Therefore, there is no need to repeat the calculations using properties at this new film temperature.

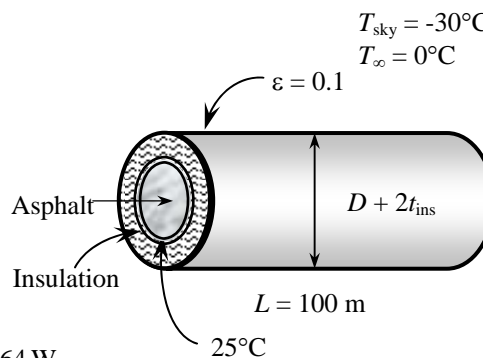

9-36E An industrial furnace that resembles a horizontal cylindrical enclosure whose end surfaces are well insulated. The highest allowable surface temperature of the furnace and the annual cost of this loss to the plant are to be determined.

Assumptions 1 Steady operating conditions exist. 2 Air is an ideal gas with constant properties. 3 The local atmospheric pressure is 1 atm.

Properties The properties of air at 1 atm and the anticipated film temperature of $(T_s + T_\infty)/2 = (140 + 75)/2 = 107.5^\circ\text{F}$ are (Table A-15)

$$k = 0.01546 \text{ Btu/h}\cdot\text{ft}\cdot^\circ\text{F}$$

$$\nu = 0.1852 \times 10^{-3} \text{ ft}^2/\text{s}$$

$$\text{Pr} = 0.7249$$

$$\beta = \frac{1}{T_f} = \frac{1}{(107.5 + 460)\text{R}} = 0.001762 \text{ R}^{-1}$$

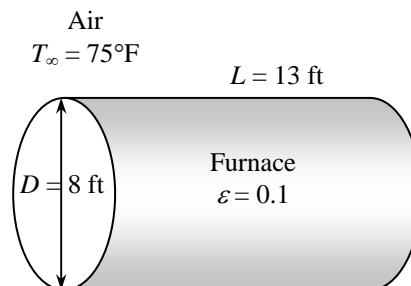

Analysis The solution of this problem requires a trial-and-error approach since the determination of the Rayleigh number and thus the Nusselt number depends on the surface temperature which is unknown. We start the solution process by “guessing” the surface temperature to be 140°F for the evaluation of the properties and h . We will check the accuracy of this guess later and repeat the calculations if necessary. The characteristic length in this case is the outer diameter of the furnace, $L_c = D = 8 \text{ ft}$. Then,

$$Ra = \frac{g\beta(T_s - T_\infty)D^3}{\nu^2} \text{Pr} = \frac{(32.2 \text{ ft/s}^2)(0.001762 \text{ R}^{-1})(140 - 75 \text{ R})(8 \text{ ft})^3}{(0.1852 \times 10^{-3} \text{ ft}^2/\text{s})^2} (0.7249) = 3.991 \times 10^{10}$$

$$Nu = \left\{ 0.6 + \frac{0.387 Ra^{1/6}}{\left[1 + (0.559 / \text{Pr})^{9/16} \right]^{8/27}} \right\}^2 = \left\{ 0.6 + \frac{0.387 (3.991 \times 10^{10})^{1/6}}{\left[1 + (0.559 / 0.7249)^{9/16} \right]^{8/27}} \right\}^2 = 376.8$$

$$h = \frac{k}{D} Nu = \frac{0.01546 \text{ Btu/h}\cdot\text{ft}\cdot^\circ\text{F}}{8 \text{ ft}} (376.8) = 0.7287 \text{ Btu/h}\cdot\text{ft}^2\cdot^\circ\text{F}$$

$$A_s = \pi DL = \pi (8 \text{ ft})(13 \text{ ft}) = 326.7 \text{ ft}^2$$

The total rate of heat generated in the furnace is

$$\dot{Q}_{gen} = (0.82)(48 \text{ therms/h})(100,000 \text{ Btu/therm}) = 3.936 \times 10^6 \text{ Btu/h}$$

Noting that 1% of the heat generated can be dissipated by natural convection and radiation ,

$$\dot{Q} = (0.01)(3.936 \times 10^6 \text{ Btu/h}) = 39,360 \text{ Btu/h}$$

The total rate of heat loss from the furnace by natural convection and radiation can be expressed as

$$\begin{aligned} \dot{Q} &= hA_s(T_s - T_\infty) + \varepsilon A_s \sigma (T_s^4 - T_{surr}^4) \\ 39,360 \text{ Btu/h} &= (0.7287 \text{ Btu/h}\cdot\text{ft}^2\cdot^\circ\text{F})(326.7 \text{ ft}^2)[T_s - (75 + 460 \text{ R})] \\ &\quad + (0.85)(326.7 \text{ m}^2)(0.1714 \times 10^{-8} \text{ Btu/h}\cdot\text{ft}^2\cdot\text{R}^4)[T_s^4 - (75 + 460 \text{ R})^4] \end{aligned}$$

Its solution is

$$T_s = 601.8 \text{ R} = \mathbf{141.8^\circ\text{F}}$$

which is very close to the assumed value. Therefore, there is no need to repeat calculations. The total amount of heat loss and its cost during a 2800-hour period is

$$Q_{total} = \dot{Q}_{total} \Delta t = (39,360 \text{ Btu/h})(2800 \text{ h}) = 1.102 \times 10^8 \text{ Btu}$$

$$\text{Cost} = (1.102 \times 10^8 / 100,000 \text{ therm})(\$1.15 / \text{therm}) = \mathbf{\$1267}$$

9-37 A glass window is considered. The convection heat transfer coefficient on the inner side of the window, the rate of total heat transfer through the window, and the combined natural convection and radiation heat transfer coefficient on the outer surface of the window are to be determined.

Assumptions 1 Steady operating conditions exist. **2** Air is an ideal gas with constant properties. **3** The local atmospheric pressure is 1 atm.

Properties The properties of air at 1 atm and the film temperature of $(T_s + T_\infty)/2 = (5 + 25)/2 = 15^\circ\text{C}$ are (Table A-15)

$$k = 0.02476 \text{ W/m}\cdot^\circ\text{C}$$

$$\nu = 1.470 \times 10^{-5} \text{ m}^2/\text{s}$$

$$\text{Pr} = 0.7323$$

$$\beta = \frac{1}{T_f} = \frac{1}{(15 + 273)\text{K}} = 0.003472 \text{ K}^{-1}$$

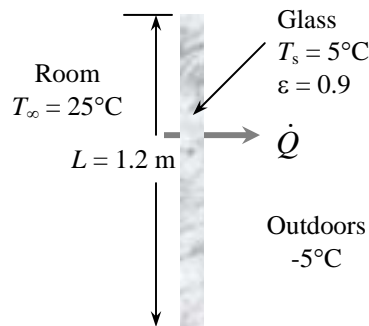

Analysis (a) The characteristic length in this case is the height of the window, $L_c = L = 1.2 \text{ m}$. Then,

$$\text{Ra} = \frac{g\beta(T_\infty - T_s)L_c^3}{\nu^2} \text{Pr} = \frac{(9.81 \text{ m/s}^2)(0.003472 \text{ K}^{-1})(25 - 5 \text{ K})(1.2 \text{ m})^3}{(1.470 \times 10^{-5} \text{ m}^2/\text{s})^2} (0.7323) = 3.989 \times 10^9$$

$$\text{Nu} = \left\{ 0.825 + \frac{0.387\text{Ra}^{1/6}}{\left[1 + \left(\frac{0.492}{\text{Pr}} \right)^{9/16} \right]^{8/27}} \right\}^2 = \left\{ 0.825 + \frac{0.387(3.989 \times 10^9)^{1/6}}{\left[1 + \left(\frac{0.492}{0.7323} \right)^{9/16} \right]^{8/27}} \right\}^2 = 189.7$$

$$h = \frac{k}{L} \text{Nu} = \frac{0.02476 \text{ W/m}\cdot^\circ\text{C}}{1.2 \text{ m}} (189.7) = \mathbf{3.915 \text{ W/m}^2 \cdot ^\circ\text{C}}$$

$$A_s = (1.2 \text{ m})(2 \text{ m}) = 2.4 \text{ m}^2$$

(b) The sum of the natural convection and radiation heat transfer from the room to the window is

$$\dot{Q}_{\text{convection}} = hA_s(T_\infty - T_s) = (3.915 \text{ W/m}^2 \cdot ^\circ\text{C})(2.4 \text{ m}^2)(25 - 5)^\circ\text{C} = 187.9 \text{ W}$$

$$\begin{aligned} \dot{Q}_{\text{radiation}} &= \varepsilon A_s \sigma (T_{\text{surr}}^4 - T_s^4) \\ &= (0.9)(2.4 \text{ m}^2)(5.67 \times 10^{-8} \text{ W/m}^2 \cdot \text{K}^4)[(25 + 273 \text{ K})^4 - (5 + 273 \text{ K})^4] = 234.3 \text{ W} \end{aligned}$$

$$\dot{Q}_{\text{total}} = \dot{Q}_{\text{convection}} + \dot{Q}_{\text{radiation}} = 187.9 + 234.3 = \mathbf{422.2 \text{ W}}$$

(c) The outer surface temperature of the window can be determined from

$$\dot{Q}_{\text{total}} = \frac{kA_s}{t} (T_{s,i} - T_{s,o}) \longrightarrow T_{s,o} = T_{s,i} - \frac{\dot{Q}_{\text{total}} t}{kA_s} = 5^\circ\text{C} - \frac{(422.2 \text{ W})(0.006 \text{ m})}{(0.78 \text{ W/m}\cdot^\circ\text{C})(2.4 \text{ m}^2)} = 3.65^\circ\text{C}$$

Then the combined natural convection and radiation heat transfer coefficient on the outer window surface becomes

$$\dot{Q}_{\text{total}} = h_{\text{combined}} A_s (T_{s,o} - T_{\infty,o})$$

$$\text{or } h_{\text{combined}} = \frac{\dot{Q}_{\text{total}}}{A_s (T_{s,o} - T_{\infty,o})} = \frac{422.2 \text{ W}}{(2.4 \text{ m}^2)[3.65 - (-5)]^\circ\text{C}} = \mathbf{20.35 \text{ W/m}^2 \cdot ^\circ\text{C}}$$

Note that $\Delta T = \dot{Q}R$ and thus the thermal resistance R of a layer is proportional to the temperature drop across that layer. Therefore, the fraction of thermal resistance of the glass is equal to the ratio of the temperature drop across the glass to the overall temperature difference,

$$\frac{R_{\text{glass}}}{R_{\text{total}}} = \frac{\Delta T_{\text{glass}}}{\Delta T_{\text{total}}} = \frac{5 - 3.65}{25 - (-5)} = 0.045 \quad (\text{or } 4.5\%)$$

which is low. Thus it is reasonable to neglect the thermal resistance of the glass.

9-38 An insulated electric wire is exposed to calm air. The temperature at the interface of the wire and the plastic insulation is to be determined.

Assumptions 1 Steady operating conditions exist. 2 Air is an ideal gas with constant properties. 3 The local atmospheric pressure is 1 atm.

Properties The properties of air at 1 atm and the anticipated film temperature of $(T_s + T_\infty)/2 = (50 + 30)/2 = 40^\circ\text{C}$ are (Table A-15)

$$k = 0.02662 \text{ W/m}\cdot^\circ\text{C}$$

$$\nu = 1.702 \times 10^{-5} \text{ m}^2/\text{s}$$

$$\text{Pr} = 0.7255$$

$$\beta = \frac{1}{T_f} = \frac{1}{(40 + 273)\text{K}} = 0.003195 \text{ K}^{-1}$$

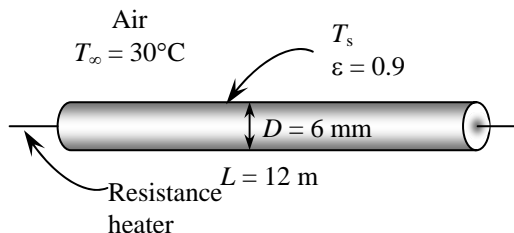

Analysis The solution of this problem requires a trial-and-error approach since the determination of the Rayleigh number and thus the Nusselt number depends on the surface temperature which is unknown. We start the solution process by “guessing” the surface temperature to be 50°C for the evaluation of the properties and h . We will check the accuracy of this guess later and repeat the calculations if necessary. The characteristic length in this case is the outer diameter of the insulated wire $L_c = D = 0.006 \text{ m}$. Then,

$$Ra = \frac{g\beta(T_s - T_\infty)D^3}{\nu^2} \text{Pr} = \frac{(9.81 \text{ m/s}^2)(0.003195 \text{ K}^{-1})(50 - 30 \text{ K})(0.006 \text{ m})^3}{(1.702 \times 10^{-5} \text{ m}^2/\text{s})^2} (0.7255) = 339.3$$

$$Nu = \left\{ 0.6 + \frac{0.387 Ra^{1/6}}{\left[1 + (0.559 / \text{Pr})^{9/16} \right]^{8/27}} \right\}^2 = \left\{ 0.6 + \frac{0.387 (339.3)^{1/6}}{\left[1 + (0.559 / 0.7255)^{9/16} \right]^{8/27}} \right\}^2 = 2.101$$

$$h = \frac{k}{D} Nu = \frac{0.02662 \text{ W/m}\cdot^\circ\text{C}}{0.006 \text{ m}} (2.101) = 9.327 \text{ W/m}^2\cdot^\circ\text{C}$$

$$A_s = \pi DL = \pi (0.006 \text{ m})(12 \text{ m}) = 0.2262 \text{ m}^2$$

The rate of heat generation, and thus the rate of heat transfer is

$$\dot{Q} = VI = (7 \text{ V})(10 \text{ A}) = 70 \text{ W}$$

Considering both natural convection and radiation, the total rate of heat loss can be expressed as

$$\begin{aligned} \dot{Q} &= hA_s(T_s - T_\infty) + \varepsilon A_s \sigma (T_s^4 - T_{surr}^4) \\ 70 \text{ W} &= (9.327 \text{ W/m}^2\cdot^\circ\text{C})(0.226 \text{ m}^2)(T_s - 30)^\circ\text{C} \\ &\quad + (0.9)(0.2262 \text{ m}^2)(5.67 \times 10^{-8} \text{ W/m}^2\cdot\text{K}^4)[(T_s + 273)^4 - (30 + 273 \text{ K})^4] \end{aligned}$$

Its solution is

$$T_s = 49.9^\circ\text{C}$$

which is very close to the assumed value of 50°C . Then the temperature at the interface of the wire and the plastic cover in steady operation becomes

$$\dot{Q} = \frac{2\pi kL}{\ln(D_2/D_1)}(T_i - T_s) \longrightarrow T_i = T_s + \frac{\dot{Q} \ln(D_2/D_1)}{2\pi kL} = 49.9^\circ\text{C} + \frac{(70 \text{ W}) \ln(6/3)}{2\pi(0.20 \text{ W/m}\cdot^\circ\text{C})(12 \text{ m})} = \mathbf{53.1^\circ\text{C}}$$

9-39 A steam pipe extended from one end of a plant to the other with no insulation on it. The rate of heat loss from the steam pipe and the annual cost of those heat losses are to be determined.

Assumptions 1 Steady operating conditions exist. 2 Air is an ideal gas with constant properties. 3 The local atmospheric pressure is 1 atm.

Properties The properties of air at 1 atm and the film temperature of $(T_s + T_\infty)/2 = (170 + 20)/2 = 95^\circ\text{C}$ are (Table A-15)

$$k = 0.0306 \text{ W/m}\cdot^\circ\text{C}$$

$$\nu = 2.254 \times 10^{-5} \text{ m}^2/\text{s}$$

$$\text{Pr} = 0.7122$$

$$\beta = \frac{1}{T_f} = \frac{1}{(95 + 273)\text{K}} = 0.002717 \text{ K}^{-1}$$

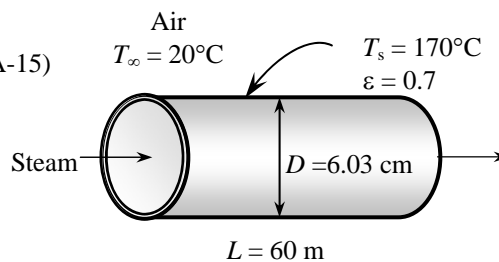

Analysis The characteristic length in this case is the outer diameter of the pipe, $L_c = D = 0.0603 \text{ m}$. Then,

$$Ra = \frac{g\beta(T_s - T_\infty)D^3}{\nu^2} \text{Pr} = \frac{(9.81 \text{ m/s}^2)(0.002717 \text{ K}^{-1})(170 - 20 \text{ K})(0.0603 \text{ m})^3}{(2.254 \times 10^{-5} \text{ m}^2/\text{s})^2} (0.7122) = 1.229 \times 10^6$$

$$Nu = \left\{ 0.6 + \frac{0.387 Ra^{1/6}}{\left[1 + (0.559 / \text{Pr})^{9/16} \right]^{8/27}} \right\}^2 = \left\{ 0.6 + \frac{0.387 (1.229 \times 10^6)^{1/6}}{\left[1 + (0.559 / 0.7122)^{9/16} \right]^{8/27}} \right\}^2 = 15.41$$

$$h = \frac{k}{D} Nu = \frac{0.0306 \text{ W/m}\cdot^\circ\text{C}}{0.0603 \text{ m}} (15.41) = 7.821 \text{ W/m}^2\cdot^\circ\text{C}$$

$$A_s = \pi DL = \pi(0.0603 \text{ m})(60 \text{ m}) = 11.37 \text{ m}^2$$

Then the total rate of heat transfer by natural convection and radiation becomes

$$\begin{aligned} \dot{Q} &= hA_s(T_s - T_\infty) + \varepsilon A_s \sigma (T_s^4 - T_{surr}^4) \\ &= (7.821 \text{ W/m}^2\cdot^\circ\text{C})(11.37 \text{ m}^2)(170 - 20)^\circ\text{C} \\ &\quad + (0.7)(11.37 \text{ m}^2)(5.67 \times 10^{-8} \text{ W/m}^2\cdot\text{K}^4)[(170 + 273 \text{ K})^4 - (20 + 273 \text{ K})^4] \\ &= 27,393 \text{ W} = \mathbf{27.4 \text{ kW}} \end{aligned}$$

The total amount of gas consumption and its cost during a one-year period is

$$Q_{gas} = \frac{\dot{Q}\Delta t}{\eta} = \frac{27.393 \text{ kJ/s}}{0.78} \left(\frac{1 \text{ therm}}{105,500 \text{ kJ}} \right) (8760 \text{ h/yr} \times 3600 \text{ s/h}) = 10,498 \text{ therms/yr}$$

$$\text{Cost} = (10,498 \text{ therms/yr})(\$1.10 / \text{therm}) = \mathbf{\$11,550/yr}$$

9-40 EES Prob. 9-39 is reconsidered. The effect of the surface temperature of the steam pipe on the rate of heat loss from the pipe and the annual cost of this heat loss is to be investigated.

Analysis The problem is solved using EES, and the solution is given below.

"GIVEN"

L=60 [m]
 D=0.0603 [m]
 T_s=170 [C]
 T_infinity=20 [C]
 epsilon=0.7
 T_surr=T_infinity
 eta_furnace=0.78
 UnitCost=1.10 [\$/therm]
 time=24*365 [h]

"PROPERTIES"

Fluid\$='air'
 k=Conductivity(Fluid\$, T=T_film)
 Pr=Prandtl(Fluid\$, T=T_film)
 rho=Density(Fluid\$, T=T_film, P=101.3)
 mu=Viscosity(Fluid\$, T=T_film)
 nu=mu/rho
 beta=1/(T_film+273)
 T_film=1/2*(T_s+T_infinity)
 sigma=5.67E-8 [W/m^2-K^4] "Stefan-Boltzmann constant"
 g=9.807 [m/s^2] "gravitational acceleration"

"ANALYSIS"

delta=D
 Ra=(g*beta*(T_s-T_infinity)*delta^3)/nu^2*Pr
 Nusselt=(0.6+(0.387*Ra^(1/6)))/(1+(0.559/Pr)^(9/16))^(8/27))^2
 h=k/delta*Nusselt
 A=pi*D*L
 Q_dot=h*A*(T_s-T_infinity)+epsilon*A*sigma*((T_s+273)^4-(T_surr+273)^4)
 Q_gas=(Q_dot*time)/eta_furnace*Convert(h, s)*Convert(J, kJ)*Convert(kJ, therm)
 Cost=Q_gas*UnitCost

T_s [C]	Q [W]	Cost [\$]
100	11636	4905
105	12594	5309
110	13577	5723
115	14585	6148
120	15618	6584
125	16676	7030
130	17760	7486
135	18869	7954
140	20004	8432
145	21166	8922
150	22355	9423
155	23570	9936
160	24814	10460
165	26085	10996
170	27385	11543
175	28713	12103
180	30071	12676
185	31459	13261
190	32877	13859
195	34327	14470
200	35807	15094

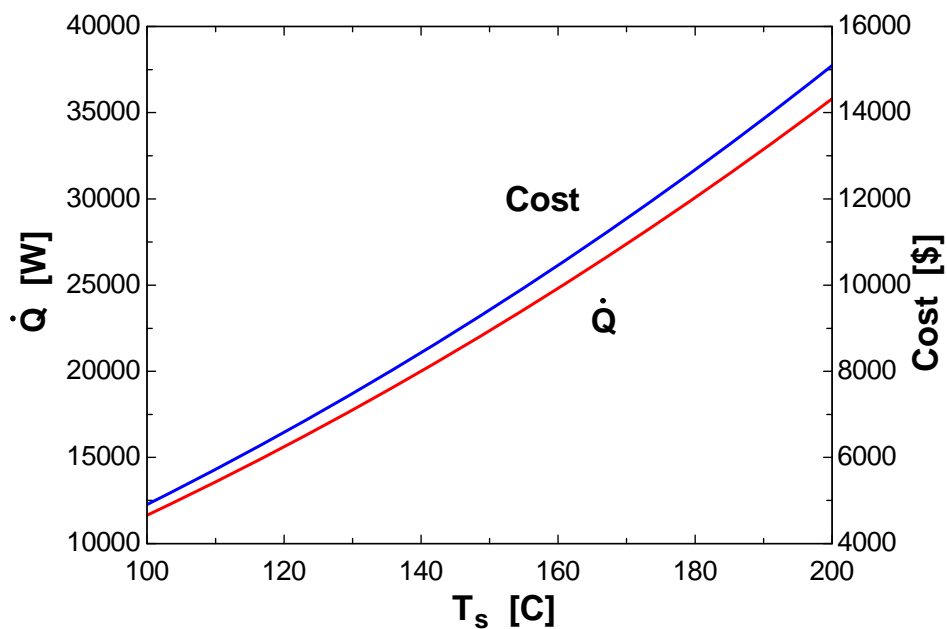

9-41 A steam pipe extended from one end of a plant to the other. It is proposed to insulate the steam pipe for \$750. The simple payback period of the insulation to pay for itself from the energy it saves are to be determined.

Assumptions 1 Steady operating conditions exist. 2 Air is an ideal gas with constant properties. 3 The local atmospheric pressure is 1 atm.

Properties The properties of air at 1 atm and the anticipated film temperature of $(T_s + T_\infty)/2 = (35 + 20)/2 = 27.5^\circ\text{C}$ are (Table A-15)

$$k = 0.0257 \text{ W/m}\cdot^\circ\text{C}$$

$$\nu = 1.584 \times 10^{-5} \text{ m}^2/\text{s}$$

$$\text{Pr} = 0.7289$$

$$\beta = \frac{1}{T_f} = \frac{1}{(27.5 + 273)\text{K}} = 0.003328 \text{ K}^{-1}$$

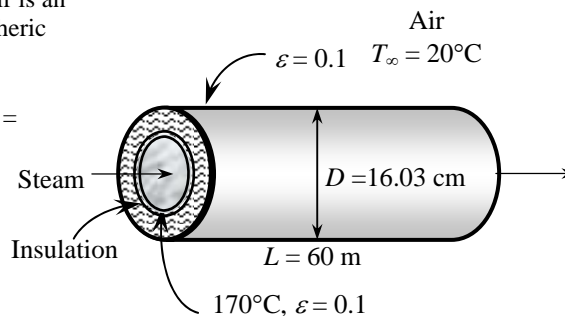

Analysis Insulation will drop the outer surface temperature to a value close to the ambient temperature. The solution of this problem requires a trial-and-error approach since the determination of the Rayleigh number and thus the Nusselt number depends on the surface temperature which is unknown. We start the solution process by “guessing” the outer surface temperature to be 35°C for the evaluation of the properties and h . We will check the accuracy of this guess later and repeat the calculations if necessary. The characteristic length in this case is the outer diameter of the insulated pipe, $L_c = D = 0.1603 \text{ m}$. Then,

$$Ra = \frac{g\beta(T_s - T_\infty)D^3}{\nu^2} \text{Pr} = \frac{(9.81 \text{ m/s}^2)(0.003328 \text{ K}^{-1})(35 - 20 \text{ K})(0.1603 \text{ m})^3}{(1.584 \times 10^{-5} \text{ m}^2/\text{s})^2} (0.7289) = 5.856 \times 10^6$$

$$Nu = \left\{ 0.6 + \frac{0.387 Ra^{1/6}}{\left[1 + (0.559 / \text{Pr})^{9/16} \right]^{8/27}} \right\}^2 = \left\{ 0.6 + \frac{0.387 (5.856 \times 10^6)^{1/6}}{\left[1 + (0.559 / 0.7289)^{9/16} \right]^{8/27}} \right\}^2 = 24.23$$

$$h = \frac{k}{D} Nu = \frac{0.0257 \text{ W/m}\cdot^\circ\text{C}}{0.1603 \text{ m}} (24.23) = 3.884 \text{ W/m}^2 \cdot^\circ\text{C}$$

$$A_s = \pi DL = \pi(0.1603 \text{ m})(60 \text{ m}) = 30.22 \text{ m}^2$$

Then the total rate of heat loss from the outer surface of the insulated pipe by convection and radiation becomes

$$\begin{aligned} \dot{Q} &= \dot{Q}_{conv} + \dot{Q}_{rad} = hA_s(T_s - T_\infty) + \varepsilon A_s \sigma (T_s^4 - T_{surr}^4) \\ &= (3.884 \text{ W/m}^2 \cdot^\circ\text{C})(30.22 \text{ m}^2)(35 - 20)^\circ\text{C} \\ &\quad + (0.1)(30.22 \text{ m}^2)(5.67 \times 10^{-8} \text{ W/m}^2 \cdot \text{K}^4)[(35 + 273 \text{ K})^4 - (20 + 273 \text{ K})^4] \\ &= 2039 \text{ W} \end{aligned}$$

In steady operation, the heat lost from the exposed surface of the insulation by convection and radiation must be equal to the heat conducted through the insulation. This requirement gives the surface temperature to be

$$\dot{Q} = \dot{Q}_{insulation} = \frac{T_{s,i} - T_s}{R_{ins}} = \frac{T_{s,i} - T_s}{\frac{\ln(D_2 / D_1)}{2\pi kL}} \rightarrow 2039 \text{ W} = \frac{(170 - T_s)^\circ\text{C}}{\frac{\ln(16.03 / 6.03)}{2\pi(0.038 \text{ W/m}\cdot^\circ\text{C})(60 \text{ m})}}$$

It gives 30.8°C for the surface temperature, which is somewhat different than the assumed value of 35°C .

Repeating the calculations with other surface temperatures gives

$$T_s = 34.3^\circ\text{C} \quad \text{and} \quad \dot{Q} = 1988 \text{ W}$$

Heat loss and its cost without insulation was determined in the Prob. 9-39 to be 27.388 kW and \$11,550. Then the reduction in the heat losses becomes

$$\dot{Q}_{saved} = 27.388 - 1.988 \cong 25.40 \text{ kW} \quad \text{or} \quad 25.388/27.40 = 0.927 \quad (92.7\%)$$

Therefore, the money saved by insulation will be $0.927 \times (\$11,550/\text{yr}) = \mathbf{\$10,700/\text{yr}}$ which will pay for the cost of \$750 in $\$750/(\$10,640/\text{yr}) = 0.0701 \text{ year} = \mathbf{26 \text{ days}}$.

9-42 A circuit board containing square chips is mounted on a vertical wall in a room. The surface temperature of the chips is to be determined.

Assumptions 1 Steady operating conditions exist. 2 Air is an ideal gas with constant properties. 3 The local atmospheric pressure is 1 atm. 4 The heat transfer from the back side of the circuit board is negligible.

Properties The properties of air at 1 atm and the anticipated film temperature of $(T_s + T_\infty)/2 = (35 + 25)/2 = 30^\circ\text{C}$ are (Table A-15)

$$k = 0.02588 \text{ W/m}\cdot^\circ\text{C}$$

$$\nu = 1.608 \times 10^{-5} \text{ m}^2/\text{s}$$

$$\text{Pr} = 0.7282$$

$$\beta = \frac{1}{T_f} = \frac{1}{(30 + 273)\text{K}} = 0.0033 \text{ K}^{-1}$$

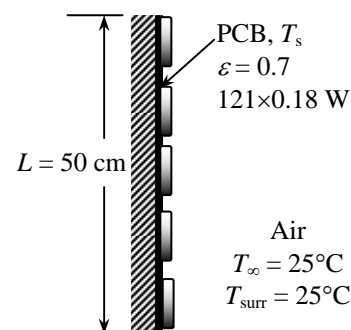

Analysis The solution of this problem requires a trial-and-error approach since the determination of the Rayleigh number and thus the Nusselt number depends on the surface temperature which is unknown. We start the solution process by “guessing” the surface temperature to be 35°C for the evaluation of the properties and h . We will check the accuracy of this guess later and repeat the calculations if necessary. The characteristic length in this case is the height of the board, $L_c = L = 0.5 \text{ m}$. Then,

$$\text{Ra} = \frac{g\beta(T_s - T_\infty)L^3}{\nu^2} \text{Pr} = \frac{(9.81 \text{ m/s}^2)(0.0033 \text{ K}^{-1})(35 - 25 \text{ K})(0.5 \text{ m})^3}{(1.608 \times 10^{-5} \text{ m}^2/\text{s})^2} (0.7282) = 1.140 \times 10^8$$

$$\text{Nu} = \left\{ 0.825 + \frac{0.387\text{Ra}^{1/6}}{\left[1 + \left(\frac{0.492}{\text{Pr}} \right)^{9/16} \right]^{8/27}} \right\}^2 = \left\{ 0.825 + \frac{0.387(1.140 \times 10^8)^{1/6}}{\left[1 + \left(\frac{0.492}{0.7282} \right)^{9/16} \right]^{8/27}} \right\}^2 = 63.72$$

$$h = \frac{k}{L} \text{Nu} = \frac{0.02588 \text{ W/m}\cdot^\circ\text{C}}{0.5 \text{ m}} (63.72) = 3.30 \text{ W/m}^2 \cdot ^\circ\text{C}$$

$$A_s = (0.5 \text{ m})^2 = 0.25 \text{ m}^2$$

Considering both natural convection and radiation, the total rate of heat loss can be expressed as

$$\begin{aligned} \dot{Q} &= hA_s(T_s - T_\infty) + \epsilon A_s \sigma (T_s^4 - T_{\text{surr}}^4) \\ (121 \times 0.18) \text{ W} &= (3.30 \text{ W/m}^2 \cdot ^\circ\text{C})(0.25 \text{ m}^2)(T_s - 25)^\circ\text{C} \\ &\quad + (0.7)(0.25 \text{ m}^2)(5.67 \times 10^{-8} \text{ W/m}^2 \cdot \text{K}^4)[(T_s + 273 \text{ K})^4 - (25 + 273 \text{ K})^4] \end{aligned}$$

Its solution is

$$T_s = \mathbf{36.2^\circ\text{C}}$$

which is sufficiently close to the assumed value in the evaluation of properties and h . Therefore, there is no need to repeat calculations by reevaluating the properties and h at the new film temperature.

9-43 A circuit board containing square chips is positioned horizontally in a room. The surface temperature of the chips is to be determined for two orientations.

Assumptions 1 Steady operating conditions exist. **2** Air is an ideal gas with constant properties. **3** The local atmospheric pressure is 1 atm. **4** The heat transfer from the back side of the circuit board is negligible.

Properties The properties of air at 1 atm and the anticipated film temperature of $(T_s + T_\infty)/2 = (35 + 25)/2 = 30^\circ\text{C}$ are (Table A-15)

$$k = 0.02588 \text{ W/m}\cdot^\circ\text{C}$$

$$\nu = 1.608 \times 10^{-5} \text{ m}^2/\text{s}$$

$$\text{Pr} = 0.7282$$

$$\beta = \frac{1}{T_f} = \frac{1}{(30 + 273)\text{K}} = 0.0033 \text{ K}^{-1}$$

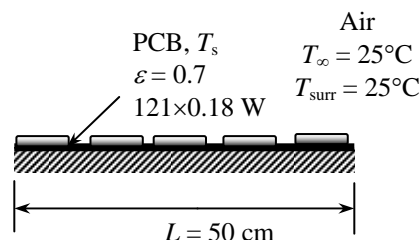

Analysis The solution of this problem requires a trial-and-error approach since the determination of the Rayleigh number and thus the Nusselt number depends on the surface temperature which is unknown. We start the solution process by “guessing” the surface temperature to be 35°C for the evaluation of the properties and h . The characteristic length for both cases is determined from

$$L_c = \frac{A_s}{p} = \frac{(0.5 \text{ m})^2}{2[(0.5 \text{ m}) + (0.5 \text{ m})]} = 0.125 \text{ m.}$$

Then,

$$Ra = \frac{g\beta(T_s - T_\infty)L_c^3}{\nu^2} \text{Pr} = \frac{(9.81 \text{ m/s}^2)(0.0033 \text{ K}^{-1})(35 - 25 \text{ K})(0.125 \text{ m})^3}{(1.608 \times 10^{-5} \text{ m}^2/\text{s})^2} (0.7282) = 1.781 \times 10^6$$

(a) Chips (hot surface) facing up:

$$Nu = 0.54Ra^{1/4} = 0.54(1.781 \times 10^6)^{1/4} = 19.73$$

$$h = \frac{k}{L_c} Nu = \frac{0.02588 \text{ W/m}\cdot^\circ\text{C}}{0.125 \text{ m}} (19.73) = 4.08 \text{ W/m}^2\cdot^\circ\text{C}$$

$$A_s = (0.5 \text{ m})^2 = 0.25 \text{ m}^2$$

Considering both natural convection and radiation, the total rate of heat loss can be expressed as

$$\begin{aligned} \dot{Q} &= hA_s(T_s - T_\infty) + \varepsilon A_s \sigma (T_s^4 - T_{\text{surr}}^4) \\ (121 \times 0.18) \text{ W} &= (4.08 \text{ W/m}^2\cdot^\circ\text{C})(0.25 \text{ m}^2)(T_s - 25)^\circ\text{C} \\ &\quad + (0.7)(0.25 \text{ m}^2)(5.67 \times 10^{-8} \text{ W/m}^2\cdot\text{K}^4)[(T_s + 273 \text{ K})^4 - (25 + 273 \text{ K})^4] \end{aligned}$$

Its solution is $T_s = 35.2^\circ\text{C}$

which is sufficiently close to the assumed value. Therefore, there is no need to repeat calculations.

(b) Chips (hot surface) facing up:

$$Nu = 0.27Ra^{1/4} = 0.27(1.781 \times 10^6)^{1/4} = 9.863$$

$$h = \frac{k}{L_c} Nu = \frac{0.02588 \text{ W/m}\cdot^\circ\text{C}}{0.125 \text{ m}} (9.863) = 2.04 \text{ W/m}^2\cdot^\circ\text{C}$$

Considering both natural convection and radiation, the total rate of heat loss can be expressed as

$$\begin{aligned} \dot{Q} &= hA_s(T_s - T_\infty) + \varepsilon A_s \sigma (T_s^4 - T_{\text{surr}}^4) \\ (121 \times 0.18) \text{ W} &= (2.04 \text{ W/m}^2\cdot^\circ\text{C})(0.25 \text{ m}^2)(T_s - 25)^\circ\text{C} \\ &\quad + (0.7)(0.25 \text{ m}^2)(5.67 \times 10^{-8} \text{ W/m}^2\cdot\text{K}^4)[(T_s + 273 \text{ K})^4 - (25 + 273 \text{ K})^4] \end{aligned}$$

Its solution is $T_s = 38.3^\circ\text{C}$

which is identical to the assumed value in the evaluation of properties and h . Therefore, there is no need to repeat calculations.

9-44 It is proposed that the side surfaces of a cubic industrial furnace be insulated for \$550 in order to reduce the heat loss by 90 percent. The thickness of the insulation and the payback period of the insulation to pay for itself from the energy it saves are to be determined.

Assumptions 1 Steady operating conditions exist. 2 Air is an ideal gas with constant properties. 3 The local atmospheric pressure is 1 atm.

Properties The properties of air at 1 atm and the film temperature of $(T_s + T_\infty)/2 = (110 + 30)/2 = 70^\circ\text{C}$ are (Table A-15)

$$k = 0.02881 \text{ W/m}\cdot^\circ\text{C}$$

$$\nu = 1.995 \times 10^{-5} \text{ m}^2/\text{s}$$

$$\text{Pr} = 0.7177$$

$$\beta = \frac{1}{T_f} = \frac{1}{(70 + 273)\text{K}} = 0.002915 \text{ K}^{-1}$$

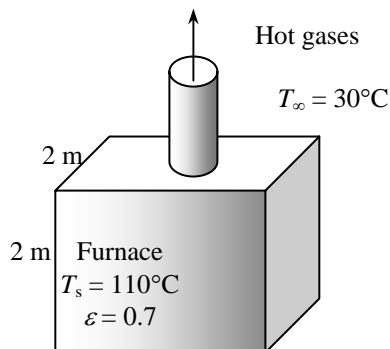

Analysis The characteristic length in this case is the height of the furnace, $L_c = L = 2 \text{ m}$. Then,

$$\text{Ra} = \frac{g\beta(T_s - T_\infty)L^3}{\nu^2} \text{Pr} = \frac{(9.81 \text{ m/s}^2)(0.002915 \text{ K}^{-1})(110 - 30 \text{ K})(2 \text{ m})^3}{(1.995 \times 10^{-5} \text{ m}^2/\text{s})^2} (0.7177) = 3.301 \times 10^{10}$$

$$\text{Nu} = \left\{ 0.825 + \frac{0.387\text{Ra}^{1/6}}{\left[1 + \left(\frac{0.492}{\text{Pr}} \right)^{9/16} \right]^{8/27}} \right\}^2 = \left\{ 0.825 + \frac{0.387(3.301 \times 10^{10})^{1/6}}{\left[1 + \left(\frac{0.492}{0.7177} \right)^{9/16} \right]^{8/27}} \right\}^2 = 369.2$$

$$h = \frac{k}{L_c} \text{Nu} = \frac{0.02881 \text{ W/m}\cdot^\circ\text{C}}{2 \text{ m}} (369.2) = 5.318 \text{ W/m}^2\cdot^\circ\text{C}$$

$$A_s = 4(2 \text{ m})^2 = 16 \text{ m}^2$$

Then the heat loss by combined natural convection and radiation becomes

$$\begin{aligned} \dot{Q} &= hA_s(T_s - T_\infty) + \varepsilon A_s \sigma (T_s^4 - T_{\text{surr}}^4) \\ &= (5.318 \text{ W/m}^2\cdot^\circ\text{C})(16 \text{ m}^2)(110 - 30)^\circ\text{C} \\ &\quad + (0.7)(16 \text{ m}^2)(5.67 \times 10^{-8} \text{ W/m}^2\cdot\text{K}^4)[(110 + 273 \text{ K})^4 - (30 + 273 \text{ K})^4] \\ &= 15,119 \text{ W} \end{aligned}$$

Noting that insulation will reduce the heat losses by 90%, the rate of heat loss after insulation will be

$$\begin{aligned} \dot{Q}_{\text{saved}} &= 0.9\dot{Q}_{\text{no insulation}} = 0.9 \times 15,119 \text{ W} = 13,607 \text{ W} \\ \dot{Q}_{\text{loss}} &= (1 - 0.9)\dot{Q}_{\text{no insulation}} = 0.1 \times 15,119 \text{ W} = 1512 \text{ W} \end{aligned}$$

The furnace operates continuously and thus 8760 h. Then the amount of energy and money the insulation will save becomes

$$\text{Energy saved} = \dot{Q}_{\text{saved}} \Delta t = \frac{13.607 \text{ kJ/s}}{0.78} \left(\frac{1 \text{ therm}}{105,500 \text{ kJ}} \right) (8760 \times 3600 \text{ s/yr}) = 5215 \text{ therms/yr}$$

$$\text{Money saved} = (\text{Energy saved})(\text{Unit cost of energy}) = (5215 \text{ therms})(\$0.55/\text{therm}) = \$2868$$

Therefore, the money saved by insulation will pay for the cost of \$550 in

$$550/(\$2868/\text{yr}) = 0.1918 \text{ yr} = \mathbf{70 \text{ days.}}$$

Insulation will lower the outer surface temperature, the Rayleigh and Nusselt numbers, and thus the convection heat transfer coefficient. For the evaluation of the heat transfer coefficient, we assume the surface temperature in this case to be 50°C. The properties of air at the film temperature of $(T_s + T_\infty)/2 = (50 + 30)/2 = 40^\circ\text{C}$ are (Table A-15)

$$k = 0.02662 \text{ W/m}\cdot^\circ\text{C}$$

$$\nu = 1.702 \times 10^{-5} \text{ m}^2/\text{s}$$

$$\text{Pr} = 0.7255$$

$$\beta = \frac{1}{T_f} = \frac{1}{(40 + 273)\text{K}} = 0.003195 \text{ K}^{-1}$$

Then,

$$\text{Ra} = \frac{g\beta(T_s - T_\infty)L^3}{\nu^2} \text{Pr} = \frac{(9.81 \text{ m/s}^2)(0.003195 \text{ K}^{-1})(50 - 30 \text{ K})(2 \text{ m})^3}{(1.702 \times 10^{-5} \text{ m}^2/\text{s})^2} (0.7255) = 1.256 \times 10^{10}$$

$$\text{Nu} = \left\{ 0.825 + \frac{0.387\text{Ra}^{1/6}}{\left[1 + \left(\frac{0.492}{\text{Pr}} \right)^{9/16} \right]^{8/27}} \right\}^2 = \left\{ 0.825 + \frac{0.387(1.256 \times 10^{10})^{1/6}}{\left[1 + \left(\frac{0.492}{0.7255} \right)^{9/16} \right]^{8/27}} \right\}^2 = 272.0$$

$$h = \frac{k}{L} \text{Nu} = \frac{0.02662 \text{ W/m}\cdot^\circ\text{C}}{2 \text{ m}} (272.0) = 3.620 \text{ W/m}^2\cdot^\circ\text{C}$$

$$A_s = 4 \times (2 \text{ m})(2 + 2t_{\text{insul}}) \text{ m}$$

The total rate of heat loss from the outer surface of the insulated furnace by convection and radiation becomes

$$\begin{aligned} \dot{Q} &= \dot{Q}_{\text{conv}} + \dot{Q}_{\text{rad}} = hA_s(T_s - T_\infty) + \varepsilon A_s \sigma (T_s^4 - T_{\text{surr}}^4) \\ 1512 \text{ W} &= (3.620 \text{ W/m}^2\cdot^\circ\text{C})A_s(T_s - 30)^\circ\text{C} \\ &\quad + (0.7)A_s(5.67 \times 10^{-8} \text{ W/m}^2\cdot\text{K}^4)[(T_s + 273 \text{ K})^4 - (30 + 273 \text{ K})^4] \end{aligned}$$

In steady operation, the heat lost by the side surfaces of the pipe must be equal to the heat lost from the exposed surface of the insulation by convection and radiation, which must be equal to the heat conducted through the insulation. Therefore,

$$\dot{Q} = \dot{Q}_{\text{insulation}} = kA_s \frac{(T_{\text{furnace}} - T_s)}{t_{\text{ins}}} \rightarrow 1512 \text{ W} = (0.038 \text{ W/m}\cdot^\circ\text{C})A_s \frac{(110 - T_s)^\circ\text{C}}{t_{\text{insul}}}$$

Solving the two equations above by trial-and-error (or better yet, an equation solver) gives

$$T_s = 41.1^\circ\text{C} \text{ and } t_{\text{insul}} = 0.0285 \text{ m} = \mathbf{2.85 \text{ cm}}$$

9-45 A cylindrical propane tank is exposed to calm ambient air. The propane is slowly vaporized due to a crack developed at the top of the tank. The time it will take for the tank to empty is to be determined.

Assumptions 1 Steady operating conditions exist. 2 Air is an ideal gas with constant properties. 3 The local atmospheric pressure is 1 atm. 4 Radiation heat transfer is negligible.

Properties The properties of air at 1 atm and the film temperature of $(T_s + T_\infty)/2 = (-42 + 25)/2 = -8.5^\circ\text{C}$ are (Table A-15)

$$k = 0.02299 \text{ W/m}\cdot^\circ\text{C}$$

$$\nu = 1.265 \times 10^{-5} \text{ m}^2/\text{s}$$

$$\text{Pr} = 0.7383$$

$$\beta = \frac{1}{T_f} = \frac{1}{(-8.5 + 273)\text{K}} = 0.003781 \text{ K}^{-1}$$

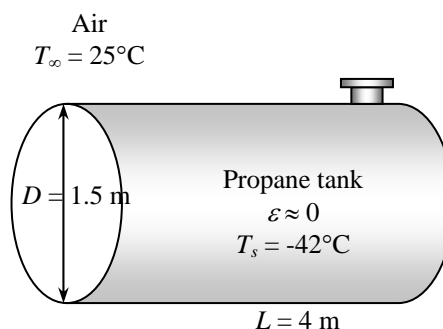

Analysis The tank gains heat through its cylindrical surface as well as its circular end surfaces. For convenience, we take the heat transfer coefficient at the end surfaces of the tank to be the same as that of its side surface. (The alternative is to treat the end surfaces as a vertical plate, but this will double the amount of calculations without providing much improvement in accuracy since the area of the end surfaces is much smaller and it is circular in shape rather than being rectangular). The characteristic length in this case is the outer diameter of the tank, $L_c = D = 1.5 \text{ m}$. Then,

$$Ra = \frac{g\beta(T_\infty - T_s)D^3}{\nu^2} \text{Pr} = \frac{(9.81 \text{ m/s}^2)(0.003781 \text{ K}^{-1})[(25 - (-42))\text{K}](1.5 \text{ m})^3}{(1.265 \times 10^{-5} \text{ m}^2/\text{s})^2} (0.7383) = 3.869 \times 10^{10}$$

$$Nu = \left\{ 0.6 + \frac{0.387 Ra^{1/6}}{\left[1 + (0.559 / \text{Pr})^{9/16} \right]^{8/27}} \right\}^2 = \left\{ 0.6 + \frac{0.387 (3.869 \times 10^{10})^{1/6}}{\left[1 + (0.559 / 0.7383)^{9/16} \right]^{8/27}} \right\}^2 = 374.1$$

$$h = \frac{k}{D} Nu = \frac{0.02299 \text{ W/m}\cdot^\circ\text{C}}{1.5 \text{ m}} (374.1) = 5.733 \text{ W/m}^2\cdot^\circ\text{C}$$

$$A_s = \pi DL + 2\pi D^2 / 4 = \pi(1.5 \text{ m})(4 \text{ m}) + 2\pi(1.5 \text{ m})^2 / 4 = 22.38 \text{ m}^2$$

and

$$\dot{Q} = hA_s(T_\infty - T_s) = (5.733 \text{ W/m}^2\cdot^\circ\text{C})(22.38 \text{ m}^2)[(25 - (-42))^\circ\text{C}] = 8598 \text{ W}$$

The total mass and the rate of evaporation of propane are

$$m = \rho V = \rho \frac{\pi D^2}{4} L = (581 \text{ kg/m}^3) \frac{\pi(1.5 \text{ m})^2}{4} (4 \text{ m}) = 4107 \text{ kg}$$

$$\dot{m} = \frac{\dot{Q}}{h_{fg}} = \frac{8.598 \text{ kJ/s}}{425 \text{ kJ/kg}} = 0.02023 \text{ kg/s}$$

and it will take

$$\Delta t = \frac{m}{\dot{m}} = \frac{4107 \text{ kg}}{0.02023 \text{ kg/s}} = 202,996 \text{ s} = \mathbf{56.4 \text{ hours}}$$

for the propane tank to empty.

9-46E The average surface temperature of a human head is to be determined when it is not covered.

Assumptions 1 Steady operating conditions exist. 2 Air is an ideal gas with constant properties. 3 The local atmospheric pressure is 1 atm. 4 The head can be approximated as a 12-in.-diameter sphere.

Properties The solution of this problem requires a trial-and-error approach since the determination of the Rayleigh number and thus the Nusselt number depends on the surface temperature which is unknown. We start the solution process by “guessing” the surface temperature to be 90°F for the evaluation of the properties and h . We will check the accuracy of this guess later and repeat the calculations if necessary. The properties of air at 1 atm and the anticipated film temperature of $(T_s + T_\infty)/2 = (90 + 70)/2 = 80^\circ\text{F}$ are (Table A-15E)

$$k = 0.01481 \text{ Btu/h}\cdot\text{ft}\cdot^\circ\text{F}$$

$$\nu = 1.697 \times 10^{-4} \text{ ft}^2/\text{s}$$

$$\text{Pr} = 0.7290$$

$$\beta = \frac{1}{T_f} = \frac{1}{(80 + 460)\text{R}} = 0.001852 \text{ R}^{-1}$$

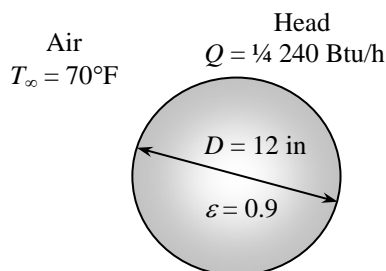

Analysis The characteristic length for a spherical object is $L_c = D = 12/12 = 1 \text{ ft}$. Then,

$$Ra = \frac{g\beta(T_s - T_\infty)D^3}{\nu^2} \text{Pr} = \frac{(32.2 \text{ ft/s}^2)(0.001852 \text{ R}^{-1})(90 - 70 \text{ R})(1 \text{ ft})^3}{(1.697 \times 10^{-4} \text{ ft}^2/\text{s})^2} (0.7290) = 3.019 \times 10^7$$

$$Nu = 2 + \frac{0.589 Ra^{1/4}}{\left[1 + \left(\frac{0.469}{\text{Pr}}\right)^{9/16}\right]^{4/9}} = 2 + \frac{0.589(3.019 \times 10^7)^{1/4}}{\left[1 + \left(\frac{0.469}{0.7290}\right)^{9/16}\right]^{4/9}} = 35.79$$

$$h = \frac{k}{D} Nu = \frac{0.01481 \text{ Btu/h}\cdot\text{ft}\cdot^\circ\text{F}}{1 \text{ ft}} (35.79) = 0.5300 \text{ Btu/h}\cdot\text{ft}^2\cdot^\circ\text{F}$$

$$A_s = \pi D^2 = \pi(1 \text{ ft})^2 = 3.142 \text{ ft}^2$$

Considering both natural convection and radiation, the total rate of heat loss can be written as

$$\begin{aligned} \dot{Q} &= hA_s(T_s - T_\infty) + \varepsilon A_s \sigma (T_s^4 - T_{surr}^4) \\ (240/4 \text{ Btu/h}) &= (0.5300 \text{ Btu/h}\cdot\text{ft}^2\cdot^\circ\text{F})(3.142 \text{ ft}^2)(T_s - 70)^\circ\text{F} \\ &\quad + (0.9)(3.142 \text{ m}^2)(0.1714 \times 10^{-8} \text{ Btu/h}\cdot\text{ft}^2\cdot\text{R}^4)[(T_s + 460 \text{ R})^4 - (70 + 460 \text{ R})^4] \end{aligned}$$

Its solution is

$$T_s = \mathbf{82.9^\circ\text{F}}$$

which is sufficiently close to the assumed value in the evaluation of the properties and h . Therefore, there is no need to repeat calculations.

9-47 The equilibrium temperature of a light glass bulb in a room is to be determined.

Assumptions 1 Steady operating conditions exist. 2 Air is an ideal gas with constant properties. 3 The local atmospheric pressure is 1 atm. 4 The light bulb is approximated as an 8-cm-diameter sphere.

Properties The solution of this problem requires a trial-and-error approach since the determination of the Rayleigh number and thus the Nusselt number depends on the surface temperature which is unknown. We start the solution process by “guessing” the surface temperature to be 170°C for the evaluation of the properties and h . We will check the accuracy of this guess later and repeat the calculations if necessary. The properties of air at 1 atm and the anticipated film temperature of $(T_s + T_\infty)/2 = (170 + 25)/2 = 97.5^\circ\text{C}$ are (Table A-15)

$$k = 0.03077 \text{ W/m}\cdot^\circ\text{C}$$

$$\nu = 2.279 \times 10^{-5} \text{ m}^2/\text{s}$$

$$\text{Pr} = 0.7116$$

$$\beta = \frac{1}{T_f} = \frac{1}{(97.5 + 273)\text{K}} = 0.002699 \text{ K}^{-1}$$

Analysis The characteristic length in this case is $L_c = D = 0.08 \text{ m}$. Then,

$$\begin{aligned} Ra &= \frac{g\beta(T_s - T_\infty)D^3}{\nu^2} \text{Pr} \\ &= \frac{(9.81 \text{ m/s}^2)(0.002699 \text{ K}^{-1})(170 - 25 \text{ K})(0.08 \text{ m})^3}{(2.279 \times 10^{-5} \text{ m}^2/\text{s})^2} (0.7116) = 2.694 \times 10^6 \end{aligned}$$

$$Nu = 2 + \frac{0.589Ra^{1/4}}{\left[1 + (0.469/\text{Pr})^{9/16}\right]^{4/9}} = 2 + \frac{0.589(2.694 \times 10^6)^{1/4}}{\left[1 + (0.469/0.7116)^{9/16}\right]^{4/9}} = 20.42$$

Then

$$h = \frac{k}{D} Nu = \frac{0.03077 \text{ W/m}\cdot^\circ\text{C}}{0.08 \text{ m}} (20.42) = 7.854 \text{ W/m}^2\cdot^\circ\text{C}$$

$$A_s = \pi D^2 = \pi(0.08 \text{ m})^2 = 0.02011 \text{ m}^2$$

Considering both natural convection and radiation, the total rate of heat loss can be written as

$$\begin{aligned} \dot{Q} &= hA_s(T_s - T_\infty) + \varepsilon A_s \sigma (T_s^4 - T_{surr}^4) \\ (0.90 \times 60) \text{ W} &= (7.854 \text{ W/m}^2\cdot^\circ\text{C})(0.02011 \text{ m}^2)(T_s - 25)^\circ\text{C} \\ &\quad + (0.9)(0.02011 \text{ m}^2)(5.67 \times 10^{-8} \text{ W/m}^2\cdot\text{K}^4)[(T_s + 273)^4 - (25 + 273 \text{ K})^4] \end{aligned}$$

Its solution is

$$T_s = \mathbf{169.4^\circ\text{C}}$$

which is sufficiently close to the value assumed in the evaluation of properties and h . Therefore, there is no need to repeat calculations.

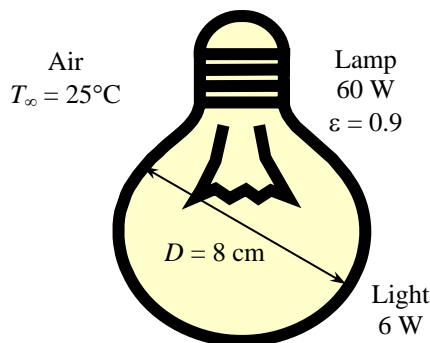

9-48 A vertically oriented cylindrical hot water tank is located in a bathroom. The rate of heat loss from the tank by natural convection and radiation is to be determined.

Assumptions 1 Steady operating conditions exist. 2 Air is an ideal gas with constant properties. 3 The local atmospheric pressure is 1 atm. 4 The temperature of the outer surface of the tank is constant.

Properties The properties of air at 1 atm and the film temperature of $(T_s + T_\infty)/2 = (44 + 20)/2 = 32^\circ\text{C}$ are (Table A-15)

$$k = 0.02603 \text{ W/m}\cdot^\circ\text{C}$$

$$\nu = 1.627 \times 10^{-5} \text{ m}^2/\text{s}$$

$$\text{Pr} = 0.7276$$

$$\beta = \frac{1}{T_f} = \frac{1}{(32 + 273)\text{K}} = 0.003279 \text{ K}^{-1}$$

Analysis The characteristic length in this case is the height of the cylinder, $L_c = L = 1.1 \text{ m}$. Then,

$$\text{Gr} = \frac{g\beta(T_s - T_\infty)L^3}{\nu^2} = \frac{(9.81 \text{ m/s}^2)(0.003279 \text{ K}^{-1})(44 - 20 \text{ K})(1.1 \text{ m})^3}{(1.627 \times 10^{-5} \text{ m}^2/\text{s})^2} = 3.883 \times 10^9$$

A vertical cylinder can be treated as a vertical plate when

$$D (= 0.4 \text{ m}) \geq \frac{35L}{\text{Gr}^{1/4}} = \frac{35(1.1 \text{ m})}{(3.883 \times 10^9)^{1/4}} = 0.1542 \text{ m}$$

which is satisfied. That is, the Nusselt number relation for a vertical plate can be used for the side surfaces. For the top and bottom surfaces we use the relevant Nusselt number relations. First, for the side surfaces,

$$\text{Ra} = \text{GrPr} = (3.883 \times 10^9)(0.7276) = 2.825 \times 10^9$$

$$\text{Nu} = \left\{ 0.825 + \frac{0.387\text{Ra}^{1/6}}{\left[1 + \left(\frac{0.492}{\text{Pr}} \right)^{9/16} \right]^{8/27}} \right\}^2 = \left\{ 0.825 + \frac{0.387(2.825 \times 10^9)^{1/6}}{\left[1 + \left(\frac{0.492}{0.7276} \right)^{9/16} \right]^{8/27}} \right\}^2 = 170.2$$

$$h = \frac{k}{L} \text{Nu} = \frac{0.02603 \text{ W/m}\cdot^\circ\text{C}}{1.1 \text{ m}} (170.2) = 4.027 \text{ W/m}^2\cdot^\circ\text{C}$$

$$A_s = \pi DL = \pi(0.4 \text{ m})(1.1 \text{ m}) = 1.382 \text{ m}^2$$

$$\dot{Q}_{\text{side}} = hA_s(T_s - T_\infty) = (4.027 \text{ W/m}^2\cdot^\circ\text{C})(1.382 \text{ m}^2)(44 - 20)^\circ\text{C} = 133.6 \text{ W}$$

For the top surface,

$$L_c = \frac{A_s}{p} = \frac{\pi D^2 / 4}{\pi D} = \frac{D}{4} = \frac{0.4 \text{ m}}{4} = 0.1 \text{ m}$$

$$\text{Ra} = \frac{g\beta(T_s - T_\infty)L_c^3}{\nu^2} \text{Pr} = \frac{(9.81 \text{ m/s}^2)(0.003279 \text{ K}^{-1})(44 - 20 \text{ K})(0.1 \text{ m})^3}{(1.627 \times 10^{-5} \text{ m}^2/\text{s})^2} (0.7276) = 2.123 \times 10^6$$

$$\text{Nu} = 0.54\text{Ra}^{1/4} = 0.54(2.123 \times 10^6)^{1/4} = 20.61$$

$$h = \frac{k}{L_c} \text{Nu} = \frac{0.02603 \text{ W/m}\cdot^\circ\text{C}}{0.1 \text{ m}} (20.61) = 5.365 \text{ W/m}^2\cdot^\circ\text{C}$$

$$A_s = \pi D^2 / 4 = \pi(0.4 \text{ m})^2 / 4 = 0.1257 \text{ m}^2$$

$$\dot{Q}_{\text{top}} = hA_s(T_s - T_\infty) = (5.365 \text{ W/m}^2\cdot^\circ\text{C})(0.1257 \text{ m}^2)(44 - 20)^\circ\text{C} = 16.2 \text{ W}$$

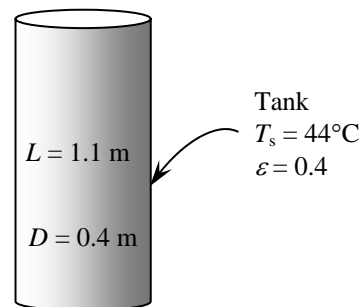

For the bottom surface,

$$Nu = 0.27Ra^{1/4} = 0.27(2.123 \times 10^6)^{1/4} = 10.31$$

$$h = \frac{k}{L_c} Nu = \frac{0.02603 \text{ W/m}\cdot\text{°C}}{0.1 \text{ m}} (10.31) = 2.683 \text{ W/m}^2 \cdot \text{°C}$$

$$\dot{Q}_{\text{bottom}} = hA_s(T_s - T_\infty) = (2.683 \text{ W/m}^2 \cdot \text{°C})(0.1257 \text{ m}^2)(44 - 20)\text{°C} = 8.1 \text{ W}$$

The total heat loss by natural convection is

$$\dot{Q}_{\text{conv}} = \dot{Q}_{\text{side}} + \dot{Q}_{\text{top}} + \dot{Q}_{\text{bottom}} = 133.6 + 16.2 + 8.1 = \mathbf{157.9 \text{ W}}$$

The radiation heat loss from the tank is

$$\begin{aligned} \dot{Q}_{\text{rad}} &= \varepsilon A_s \sigma (T_s^4 - T_{\text{surr}}^4) \\ &= (0.4)(1.382 + 0.1257 + 0.1257 \text{ m}^2)(5.67 \times 10^{-8} \text{ W/m}^2 \cdot \text{K}^4) \left[(44 + 273 \text{ K})^4 - (20 + 273 \text{ K})^4 \right] \\ &= \mathbf{101.1 \text{ W}} \end{aligned}$$

9-49 A rectangular container filled with cold water is gaining heat from its surroundings by natural convection and radiation. The water temperature in the container after a 3 hours and the average rate of heat transfer are to be determined.

Assumptions 1 Steady operating conditions exist. 2 Air is an ideal gas with constant properties. 3 The local atmospheric pressure is 1 atm. 4 The heat transfer coefficient at the top and bottom surfaces is the same as that on the side surfaces.

Properties The properties of air at 1 atm and the anticipated film temperature of $(T_s + T_\infty)/2 = (10 + 24)/2 = 17^\circ\text{C}$ are (Table A-15)

$$k = 0.02491 \text{ W/m}\cdot^\circ\text{C}$$

$$\nu = 1.489 \times 10^{-5} \text{ m}^2/\text{s}$$

$$\text{Pr} = 0.7317$$

$$\beta = \frac{1}{T_f} = \frac{1}{(17 + 273)\text{K}} = 0.003448 \text{ K}^{-1}$$

$$\text{Air} \\ T_\infty = 24^\circ\text{C}$$

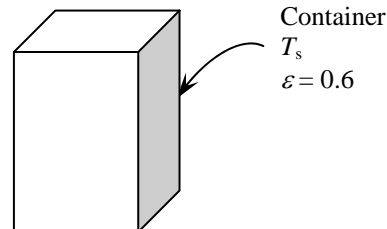

The properties of water at 2°C are (Table A-9)

$$\rho = 1000 \text{ kg/m}^3 \text{ and } c_p = 4214 \text{ J/kg}\cdot^\circ\text{C}$$

Analysis We first evaluate the heat transfer coefficient on the side surfaces. The characteristic length in this case is the height of the container,

$L_c = L = 0.28 \text{ m}$. Then,

$$\text{Ra} = \frac{g\beta(T_\infty - T_s)L^3}{\nu^2} \text{Pr} = \frac{(9.81 \text{ m/s}^2)(0.003448 \text{ K}^{-1})(24 - 10 \text{ K})(0.28 \text{ m})^3}{(1.489 \times 10^{-5} \text{ m}^2/\text{s})^2} (0.7317) = 1.133 \times 10^7$$

$$\text{Nu} = \left\{ 0.825 + \frac{0.387\text{Ra}^{1/6}}{\left[1 + \left(\frac{0.492}{\text{Pr}} \right)^{9/16} \right]^{8/27}} \right\}^2 = \left\{ 0.825 + \frac{0.387(1.133 \times 10^7)^{1/6}}{\left[1 + \left(\frac{0.492}{0.7317} \right)^{9/16} \right]^{8/27}} \right\}^2 = 30.52$$

$$h = \frac{k}{L} \text{Nu} = \frac{0.02491 \text{ W/m}\cdot^\circ\text{C}}{0.28 \text{ m}} (30.52) = 4.224 \text{ W/m}^2\cdot^\circ\text{C}$$

$$A_s = 2(0.28 \times 0.18 + 0.28 \times 0.18 + 0.18 \times 0.18) = 0.2664 \text{ m}^2$$

The rate of heat transfer can be expressed as

$$\begin{aligned} \dot{Q} &= \dot{Q}_{\text{conv}} + \dot{Q}_{\text{rad}} = hA_s \left(T_\infty - \frac{T_1 + T_2}{2} \right) + \varepsilon\sigma A_s \left[T_{\text{surr}}^4 - \left(\frac{T_1 + T_2}{2} \right)^4 \right] \\ &= (4.224 \text{ W/m}^2\cdot^\circ\text{C})(0.2664 \text{ m}^2) \left[297 - \left(\frac{275 + T_2}{2} \right) \right] \\ &\quad + (0.6)(0.2664 \text{ m}^2)(5.67 \times 10^{-8} \text{ W/m}^2\cdot\text{K}^4) \left[297^4 - \left(\frac{275 + T_2}{2} \right)^4 \right] \end{aligned} \quad (\text{Eq. 1})$$

where $(T_1 + T_2)/2$ is the average temperature of water (or the container surface). The mass of water in the container is

$$m = \rho V = (1000 \text{ kg/m}^3)(0.28 \times 0.18 \times 0.18) \text{m}^3 = 9.072 \text{ kg}$$

Then the amount of heat transfer to the water is

$$Q = mc_p(T_2 - T_1) = (9.072 \text{ kg})(4214 \text{ J/kg}\cdot^\circ\text{C})(T_2 - 275)^\circ\text{C} = 38,229(T_2 - 275)$$

The average rate of heat transfer can be expressed as

$$\dot{Q} = \frac{Q}{\Delta t} = \frac{38,229(T_2 - 275)}{3 \times 3600 \text{ s}} = 3.53976(T_2 - 275) \quad (\text{Eq. 2})$$

Setting Eq. 1 and Eq. 2 equal to each other, we obtain the final water temperature.

$$T_2 = 284.7 \text{ K} = \mathbf{11.7^\circ\text{C}}$$

We could repeat the solution using air properties at the new film temperature using this value to increase the accuracy. However, this would only affect the heat transfer value somewhat, which would not have significant effect on the final water temperature. The average rate of heat transfer can be determined from Eq. 2

$$\dot{Q} = 3.53976(11.7 - 2) = \mathbf{34.3 \text{ W}}$$

9-50 EES Prob. 9-49 is reconsidered. The water temperature in the container as a function of the heating time is to be plotted.

Analysis The problem is solved using EES, and the solution is given below.

"GIVEN"

height=0.28 [m]
 L=0.18 [m]
 w=0.18 [m]
 T_infinity=24 [C]
 T_w1=2 [C]
 epsilon=0.6
 T_surr=T_infinity
 time=3 [h]

"PROPERTIES"

Fluid\$='air'
 k=Conductivity(Fluid\$, T=T_film)
 Pr=Prandtl(Fluid\$, T=T_film)
 rho=Density(Fluid\$, T=T_film, P=101.3)
 mu=Viscosity(Fluid\$, T=T_film)
 nu=mu/rho
 beta=1/(T_film+273)
 T_film=1/2*(T_w_ave+T_infinity)
 T_w_ave=1/2*(T_w1+T_w2)
 rho_w=Density(water, T=T_w_ave, P=101.3)
 C_p_w=CP(water, T=T_w_ave, P=101.3)*Convert(kJ/kg-C, J/kg-C)
 sigma=5.67E-8 [W/m^2-K^4] "Stefan-Boltzmann constant"
 g=9.807 [m/s^2] "gravitational acceleration"

"ANALYSIS"

delta=height
 Ra=(g*beta*(T_infinity-T_w_ave)*delta^3)/nu^2*Pr
 Nusselt=0.59*Ra^0.25
 h=k/delta*Nusselt
 A=2*(height*L+height*w+w*L)
 Q_dot=h*A*(T_infinity-T_w_ave)+epsilon*A*sigma*((T_surr+273)^4-(T_w_ave+273)^4)

 m_w=rho_w*V_w
 V_w=height*L*w
 Q=m_w*C_p_w*(T_w2-T_w1)
 Q_dot=Q/(time*Convert(h, s))

time [h]	T_{w2} [C]
0.5	4.013
1	5.837
1.5	7.496
2	9.013
2.5	10.41
3	11.69
3.5	12.88
4	13.98
4.5	15
5	15.96
5.5	16.85
6	17.69
6.5	18.48
7	19.22
7.5	19.92
8	20.59
8.5	21.21
9	21.81
9.5	22.37
10	22.91

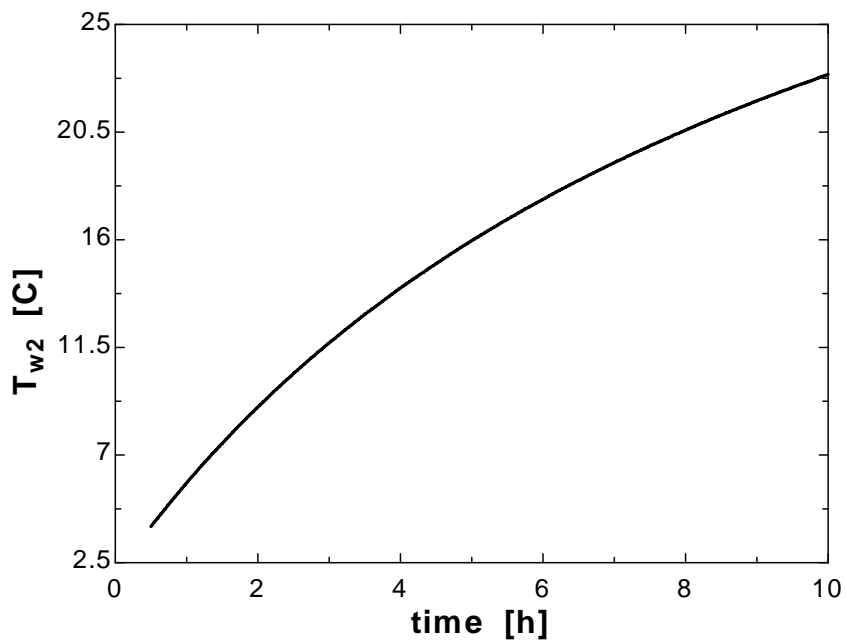

9-51 A room is to be heated by a cylindrical coal-burning stove. The surface temperature of the stove and the amount of coal burned during a 14-h period are to be determined.

Assumptions 1 Steady operating conditions exist. 2 Air is an ideal gas with constant properties. 3 The local atmospheric pressure is 1 atm. 4 The temperature of the outer surface of the stove is constant. 5 The heat transfer from the bottom surface is negligible. 6 The heat transfer coefficient at the top surface is the same as that on the side surface.

Properties The properties of air at 1 atm and the anticipated film temperature of $(T_s + T_\infty)/2 = (130 + 24)/2 = 77^\circ\text{C}$ are (Table A-15)

$$k = 0.02931 \text{ W/m}\cdot^\circ\text{C}$$

$$\nu = 2.066 \times 10^{-5} \text{ m}^2/\text{s}$$

$$\text{Pr} = 0.7161$$

$$\beta = \frac{1}{T_f} = \frac{1}{(77 + 273)\text{K}} = 0.002857 \text{ K}^{-1}$$

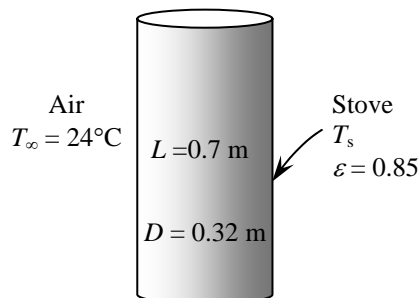

Analysis The characteristic length in this case is the height of the cylinder, $L_c = L = 0.7 \text{ m}$. Then,

$$\text{Gr} = \frac{g\beta(T_s - T_\infty)L^3}{\nu^2} = \frac{(9.81 \text{ m/s}^2)(0.002857 \text{ K}^{-1})(130 - 24 \text{ K})(0.70 \text{ m})^3}{(2.066 \times 10^{-5} \text{ m}^2/\text{s})^2} = 2.387 \times 10^9$$

A vertical cylinder can be treated as a vertical plate when

$$D (= 0.32 \text{ m}) \geq \frac{35L}{\text{Gr}^{1/4}} = \frac{35(0.7 \text{ m})}{(2.387 \times 10^9)^{1/4}} = 0.1108 \text{ m}$$

which is satisfied. That is, the Nusselt number relation for a vertical plate can be used for side surfaces.

$$\text{Ra} = \text{GrPr} = (2.387 \times 10^9)(0.7161) = 1.709 \times 10^9$$

$$\text{Nu} = \left\{ 0.825 + \frac{0.387\text{Ra}^{1/6}}{\left[1 + \left(\frac{0.492}{\text{Pr}} \right)^{9/16} \right]^{8/27}} \right\}^2 = \left\{ 0.825 + \frac{0.387(1.709 \times 10^9)^{1/6}}{\left[1 + \left(\frac{0.492}{0.7161} \right)^{9/16} \right]^{8/27}} \right\}^2 = 145.2$$

$$h = \frac{k}{L} \text{Nu} = \frac{0.02931 \text{ W/m}\cdot^\circ\text{C}}{0.7 \text{ m}} (145.2) = 6.080 \text{ W/m}^2\cdot^\circ\text{C}$$

$$A_s = \pi DL + \pi D^2 / 4 = \pi(0.32 \text{ m})(0.7 \text{ m}) + \pi(0.32 \text{ m})^2 / 4 = 0.7841 \text{ m}^2$$

Then the surface temperature of the stove is determined from

$$\begin{aligned} \dot{Q} &= \dot{Q}_{\text{conv}} + \dot{Q}_{\text{rad}} = hA_s(T_s - T_\infty) + \varepsilon\sigma A_s(T_s^4 - T_{\text{surr}}^4) \\ 1500 \text{ W} &= (6.080 \text{ W/m}^2\cdot^\circ\text{C})(0.7841 \text{ m}^2)(T_s - 297) \\ &\quad + (0.85)(0.7841 \text{ m}^2)(5.67 \times 10^{-8} \text{ W/m}^2\cdot\text{K}^4)(T_s^4 - 287^4) \\ T_s &= 419.6 \text{ K} = \mathbf{146.6^\circ\text{C}} \end{aligned}$$

The amount of coal used is determined from

$$\begin{aligned} Q &= \dot{Q}\Delta t = (1.5 \text{ kJ/s})(14 \text{ h/day} \times 3600 \text{ s/h}) = 75,600 \text{ kJ} \\ m_{\text{coal}} &= \frac{Q/\eta}{HV} = \frac{(75,600 \text{ kJ})/0.65}{30,000 \text{ kJ/kg}} = \mathbf{3.88 \text{ kg}} \end{aligned}$$

9-52 Water in a tank is to be heated by a spherical heater. The heating time is to be determined.

Assumptions 1 Steady operating conditions exist. 2 The temperature of the outer surface of the sphere is constant.

Properties Using the average temperature for water $(15+45)/2=30^\circ\text{C}$ as the fluid temperature, the properties of water at the film temperature of $(T_s+T_\infty)/2 = (85+30)/2 = 57.5^\circ\text{C}$ are (Table A-15)

$$k = 0.6515 \text{ W/m}\cdot^\circ\text{C}$$

$$\nu = 0.493 \times 10^{-6} \text{ m}^2/\text{s}$$

$$\text{Pr} = 3.12$$

$$\beta = 0.501 \times 10^{-3} \text{ K}^{-1}$$

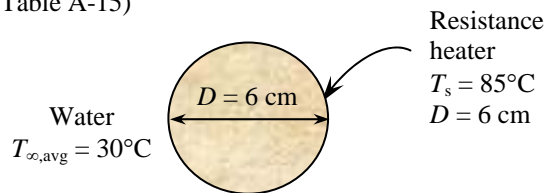

Also, the properties of water at 30°C are (Table A-15)

$$\rho = 996 \text{ kg/m}^3 \text{ and } c_p = 4178 \text{ J/kg}\cdot^\circ\text{C}$$

Analysis The characteristic length in this case is $L_c = D = 0.06 \text{ m}$. Then,

$$\text{Ra} = \frac{g\beta(T_s - T_\infty)D^3}{\nu^2} \text{Pr} = \frac{(9.81 \text{ m/s}^2)(0.501 \times 10^{-3} \text{ K}^{-1})(85 - 30 \text{ K})(0.06 \text{ m})^3}{(0.493 \times 10^{-6} \text{ m}^2/\text{s})^2} (3.12) = 7.495 \times 10^8$$

$$\text{Nu} = 2 + \frac{0.589\text{Ra}^{1/4}}{\left[1 + (0.469/\text{Pr})^{9/16}\right]^{4/9}} = 2 + \frac{0.589(7.495 \times 10^8)^{1/4}}{\left[1 + (0.469/3.12)^{9/16}\right]^{4/9}} = 87.44$$

$$h = \frac{k}{D} \text{Nu} = \frac{0.6515 \text{ W/m}\cdot^\circ\text{C}}{0.06 \text{ m}} (87.44) = 949.5 \text{ W/m}^2\cdot^\circ\text{C}$$

$$A_s = \pi D^2 = \pi(0.06 \text{ m})^2 = 0.01131 \text{ m}^2$$

The rate of heat transfer by convection is

$$\dot{Q}_{\text{conv}} = hA_s(T_s - T_\infty) = (949.5 \text{ W/m}^2\cdot^\circ\text{C})(0.01131 \text{ m}^2)(85 - 30) = 590.6 \text{ W}$$

The mass of water in the container is

$$m = \rho V = (996 \text{ kg/m}^3)(0.040 \text{ m}^3) = 39.84 \text{ kg}$$

The amount of heat transfer to the water is

$$Q = mc_p(T_2 - T_1) = (39.84 \text{ kg})(4178 \text{ J/kg}\cdot^\circ\text{C})(45 - 15)^\circ\text{C} = 4.994 \times 10^6 \text{ J}$$

Then the time the heater should be on becomes

$$\Delta t = \frac{Q}{\dot{Q}} = \frac{4.994 \times 10^6 \text{ J}}{590.6 \text{ J/s}} = 8456 \text{ s} = \mathbf{2.35 \text{ hours}}$$

Natural Convection from Finned Surfaces and PCBs

9-53C Finned surfaces are frequently used in practice to enhance heat transfer by providing a larger heat transfer surface area. Finned surfaces are referred to as heat sinks in the electronics industry since they provide a medium to which the waste heat generated in the electronic components can be transferred effectively.

9-54C A heat sink with closely packed fins will have greater surface area for heat transfer, but smaller heat transfer coefficient because of the extra resistance the additional fins introduce to fluid flow through the interfin passages.

9-55C Removing some of the fins on the heat sink will decrease heat transfer surface area, but will increase heat transfer coefficient. The decrease on heat transfer surface area more than offsets the increase in heat transfer coefficient, and thus heat transfer rate will decrease. In the second case, the decrease on heat transfer coefficient more than offsets the increase in heat transfer surface area, and thus heat transfer rate will again decrease.

9-56 An aluminum heat sink of rectangular profile oriented vertically is used to cool a power transistor. The average natural convection heat transfer coefficient is to be determined.

Assumptions 1 Steady operating conditions exist. 2 Air is an ideal gas with constant properties. 3 Radiation heat transfer from the sink is negligible. 4 The entire sink is at the base temperature.

Analysis The total surface area of the heat sink is

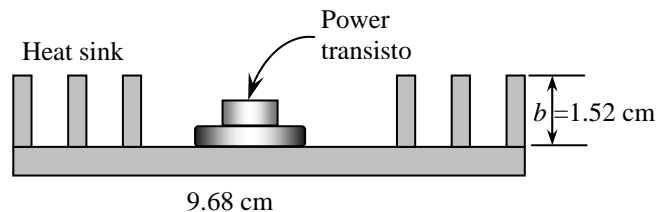

$$A_{fins} = 2nLb = (2)(6)(0.0762 \text{ m})(0.0152 \text{ m}) + (2)(0.0048 \text{ m})(0.0762 \text{ m}) = 0.01463 \text{ m}^2$$

$$A_{unfinned} = (4)(0.0145 \text{ m})(0.0762 \text{ m}) + (0.0317 \text{ m})(0.0762 \text{ m}) = 0.006835 \text{ m}^2$$

$$A_{total} = A_{fins} + A_{unfinned} = 0.01463 + 0.006835 = 0.021465 \text{ m}^2$$

Then the average natural convection heat transfer coefficient becomes

$$\dot{Q} = hA_{total}(T_s - T_\infty) \longrightarrow h = \frac{\dot{Q}}{A_{total}(T_s - T_\infty)} = \frac{15 \text{ W}}{(0.021465 \text{ m}^2)(120 - 22)^\circ\text{C}} = 7.13 \text{ W/m}^2 \cdot ^\circ\text{C}$$

9-57 Aluminum heat sinks of rectangular profile oriented vertically are used to cool a power transistor. A shroud is placed very close to the tips of fins. The average natural convection heat transfer coefficient is to be determined.

Assumptions 1 Steady operating conditions exist. 2 Air is an ideal gas with constant properties. 3 Radiation heat transfer from the sink is negligible. 4 The entire sink is at the base temperature.

Analysis The total surface area of the shrouded heat sink is

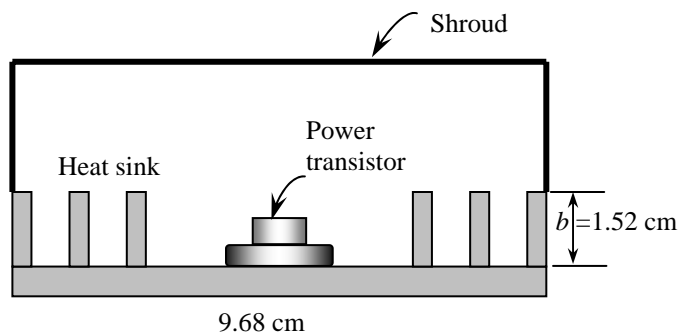

$$A_{fins} = 2nLb = (2)(6)(0.0762 \text{ m})(0.0152 \text{ m}) = 0.013898 \text{ m}^2$$

$$A_{unfanned} = (4)(0.0145 \text{ m})(0.0762 \text{ m}) + (0.0317 \text{ m})(0.0762 \text{ m}) = 0.006835 \text{ m}^2$$

$$A_{shroud} = (2)(0.0968 \text{ m})(0.0762 \text{ m}) = 0.014752 \text{ m}^2$$

$$A_{total} = A_{fins} + A_{unfanned} + A_{shroud} = 0.013898 + 0.006835 + 0.014752 = 0.035486 \text{ m}^2$$

Then the average natural convection heat transfer coefficient becomes

$$\dot{Q} = hA_{total}(T_s - T_\infty) \longrightarrow h = \frac{\dot{Q}}{A_{total}(T_s - T_\infty)} = \frac{15 \text{ W}}{(0.035486 \text{ m}^2)(108 - 22)^\circ\text{C}} = \mathbf{4.92 \text{ W/m}^2 \cdot ^\circ\text{C}}$$

9-58E A heat sink with equally spaced rectangular fins is to be used to cool a hot surface. The optimum fin spacing and the rate of heat transfer from the heat sink are to be determined.

Assumptions 1 Steady operating conditions exist. 2 Air is an ideal gas with constant properties. 3 The atmospheric pressure at that location is 1 atm. 4 The thickness t of the fins is very small relative to the fin spacing S so that Eqs. 9-32 and 9-33 for optimum fin spacing are applicable.

Properties The properties of air at 1 atm and 1 atm and the film temperature of $(T_s + T_\infty)/2 = (180 + 78)/2 = 129^\circ\text{F}$ are (Table A-15E)

$$k = 0.01597 \text{ Btu/h}\cdot\text{ft}\cdot^\circ\text{F}$$

$$\nu = 0.1975 \times 10^{-3} \text{ ft}^2/\text{s}$$

$$\text{Pr} = 0.7217$$

$$\beta = \frac{1}{T_f} = \frac{1}{(129 + 460) \text{ R}} = 0.001698 \text{ R}^{-1}$$

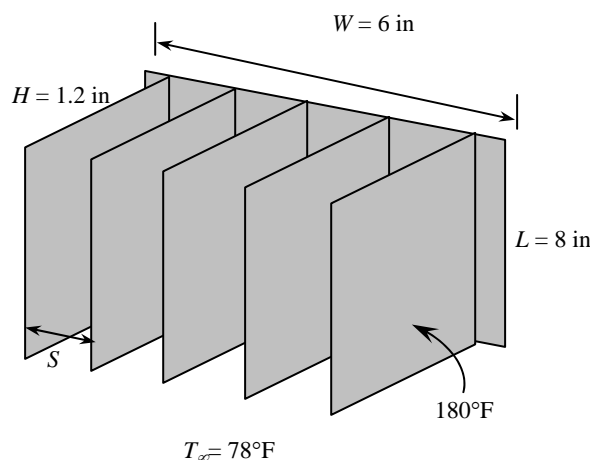

Analysis The characteristic length in this case is the fin height, $L_c = L = 8 \text{ in}$. Then,

$$Ra = \frac{g\beta(T_1 - T_2)L^3}{\nu^2} \text{Pr} = \frac{(32.2 \text{ ft/s}^2)(0.001698 \text{ R}^{-1})(180 - 78 \text{ R})(8/12 \text{ ft})^3}{(0.1975 \times 10^{-3} \text{ ft}^2/\text{s})^2} (0.7217) = 3.058 \times 10^7$$

The optimum fin spacing is

$$S = 2.714 \frac{L}{Ra^{1/4}} = 2.714 \frac{8/12 \text{ ft}}{(3.058 \times 10^7)^{1/4}} = 0.02433 \text{ ft} = \mathbf{0.292 \text{ in}}$$

The heat transfer coefficient for this optimum spacing case is

$$h = 1.307 \frac{k}{S} = 1.307 \frac{0.01597 \text{ Btu/h}\cdot\text{ft}\cdot^\circ\text{F}}{0.02433 \text{ ft}} = 0.8578 \text{ Btu/h}\cdot\text{ft}^2\cdot^\circ\text{F}$$

The number of fins and the total heat transfer surface area is

$$n = \frac{w}{S + t} = \frac{6}{0.2916 + 0.08} = 16 \text{ fins}$$

$$A_s = 2nLH + ntL + 2ntH = 2 \times 16 \times (8/12 \text{ ft})(1.2/12 \text{ ft}) + 16 \times (0.08/12 \text{ ft})(8/12 \text{ ft}) + 2 \times 16 \times (0.08/12 \text{ ft})(1.2/12 \text{ ft}) = 2.226 \text{ ft}^2$$

Then the rate of natural convection heat transfer becomes

$$\dot{Q} = hA_s(T_s - T_\infty) = (0.8578 \text{ Btu/h}\cdot\text{ft}^2\cdot^\circ\text{F})(2.226 \text{ ft}^2)(180 - 78)^\circ\text{F} = \mathbf{196 \text{ Btu/h}}$$

Discussion If the fin height is disregarded, the number of fins and the rate of heat transfer become

$$n = \frac{w}{s + t} \cong \frac{w}{s} = \frac{6}{0.2916} \cong 21 \text{ fins}$$

$$A_s = 2nLH = 2 \times 21 \times (8/12 \text{ ft})(1.2/12 \text{ ft}) = 2.8 \text{ ft}^2$$

$$\dot{Q} = hA_s(T_s - T_\infty) = (0.8578 \text{ Btu/h}\cdot\text{ft}^2\cdot^\circ\text{F})(2.8 \text{ ft}^2)(180 - 78)^\circ\text{F} = \mathbf{245 \text{ Btu/h}}$$

Therefore, the fin tip area is significant in this case.

9-59E EES Prob. 9-58E is reconsidered. The effect of the length of the fins in the vertical direction on the optimum fin spacing and the rate of heat transfer by natural convection is to be investigated.

Analysis The problem is solved using EES, and the solution is given below.

"GIVEN"

w_s=6/12 [ft]
 H_s=8/12 [ft]
 T_infinity=78 [F]
 t_fin=0.08/12 [ft]
 L_fin=8 [in]
 H_fin=1.2/12 [ft]
 T_s=180 [F]

"PROPERTIES"

Fluid\$='air'
 k=Conductivity(Fluid\$, T=T_film)
 Pr=Prandtl(Fluid\$, T=T_film)
 rho=Density(Fluid\$, T=T_film, P=14.7)
 mu=Viscosity(Fluid\$, T=T_film)*Convert(lbm/ft-h, lbm/ft-s)
 nu=mu/rho
 beta=1/(T_film+460)
 T_film=1/2*(T_s+T_infinity)
 g=32.2 [ft/s^2] "gravitational acceleration"

"ANALYSIS"

L_fin_ft=L_fin*Convert(in, ft)
 delta=L_fin_ft
 Ra=(g*beta*(T_s-T_infinity)*delta^3)/nu^2*Pr
 S_ft=2.714*L_fin_ft/Ra^0.25
 S=S_ft*Convert(ft, in)
 h=1.307*k/S_ft
 n_fin=w_s/(S_ft+t_fin)
 A=2*n_fin*L_fin_ft*H_fin+n_fin*t_fin*L_fin_ft+2*n_fin*t_fin*H_fin
 Q_dot=h*A*(T_s-T_infinity)

L_{fin} [in]	S [in]	Q [Btu/h]
2	0.2183	104.5
2.5	0.2285	115.3
3	0.2375	125.3
3.5	0.2455	134.7
4	0.2529	143.6
4.5	0.2596	152
5	0.2659	160.1
5.5	0.2717	167.9
6	0.2772	175.4
6.5	0.2824	182.6
7	0.2873	189.6
7.5	0.292	196.3
8	0.2964	202.9
8.5	0.3007	209.3
9	0.3048	215.6
9.5	0.3087	221.7
10	0.2183	104.5

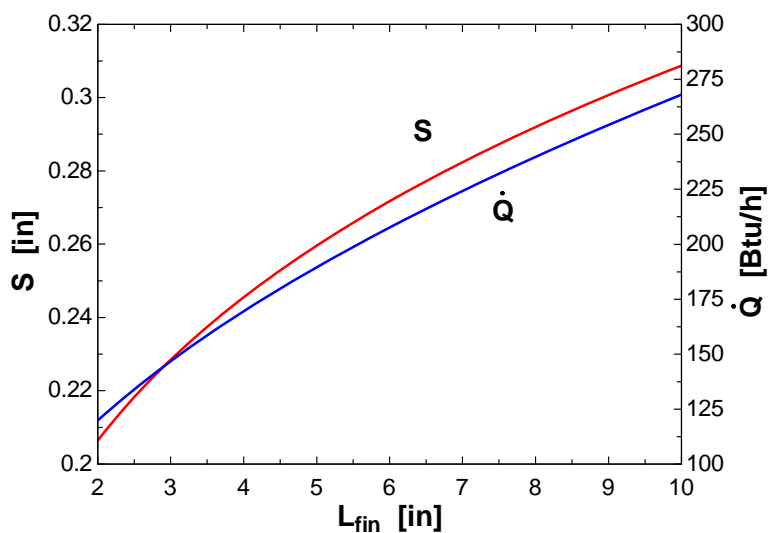

9-60 A heat sink with equally spaced rectangular fins is to be used to cool a hot surface. The optimum fin height and the rate of heat transfer from the heat sink are to be determined.

Assumptions 1 Steady operating conditions exist. 2 Air is an ideal gas with constant properties. 3 The atmospheric pressure at that location is 1 atm.

Properties The properties of air at 1 atm and the film temperature of $(T_s + T_\infty)/2 = (85 + 25)/2 = 55^\circ\text{C}$ are (Table A-15)

$$k = 0.02772 \text{ W/m}\cdot^\circ\text{C}$$

$$\nu = 1.847 \times 10^{-5} \text{ m}^2/\text{s}$$

$$\text{Pr} = 0.7215$$

$$\beta = \frac{1}{T_f} = \frac{1}{(55 + 273)\text{K}} = 0.003049 \text{ K}^{-1}$$

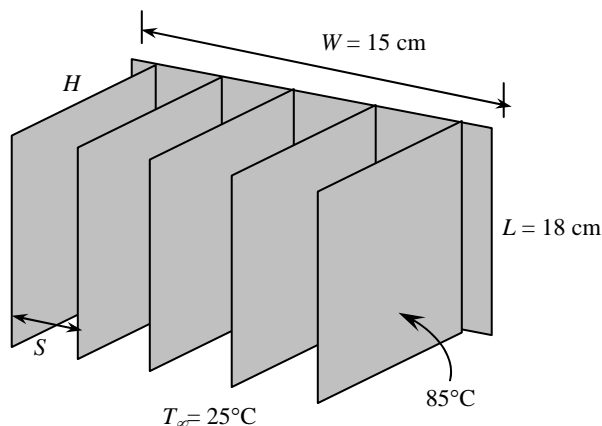

Analysis The characteristic length in this case is the height of the surface $L_c = L = 0.18 \text{ m}$. Then,

$$\text{Ra} = \frac{g\beta(T_s - T_\infty)L^3}{\nu^2} \text{Pr} = \frac{(9.81 \text{ m/s}^2)(0.003049 \text{ K}^{-1})(85 - 25 \text{ K})(0.18 \text{ m})^3}{(1.847 \times 10^{-5} \text{ m}^2/\text{s})^2} (0.7215) = 2.214 \times 10^7$$

The optimum fin spacing is

$$S = 2.714 \frac{L}{\text{Ra}^{1/4}} = 2.714 \frac{0.18 \text{ m}}{(2.214 \times 10^7)^{1/4}} = 0.007122 \text{ m} = 7.122 \text{ mm}$$

The heat transfer coefficient for this optimum fin spacing case is

$$h = 1.307 \frac{k}{S} = 1.307 \frac{0.02772 \text{ W/m}\cdot^\circ\text{C}}{0.007122 \text{ m}} = 5.087 \text{ W/m}^2 \cdot ^\circ\text{C}$$

The criteria for optimum fin height H in the literature is given by $H = \sqrt{hA_c / pk}$ (not in the text) where $A_c/p \cong t/2$ for rectangular fins. Therefore,

$$H = \sqrt{\frac{ht}{2k}} = \sqrt{\frac{(5.087 \text{ W/m}^2 \cdot ^\circ\text{C})(0.001 \text{ m})}{2 \times (177 \text{ W/m}\cdot^\circ\text{C})}} = 0.00379 \text{ m}$$

The number of fins and the total heat transfer surface area is

$$n = \frac{w}{S+t} \cong \frac{w}{s} = \frac{0.15}{0.007122} \cong 21 \text{ fins}$$

$$A_s = 2nLH = 2 \times 21 \times (0.18 \text{ m})(0.00379 \text{ m}) = 0.02865 \text{ m}^2$$

Then the rate of natural convection heat transfer becomes

$$\dot{Q} = hA_s(T_s - T_\infty) = (5.087 \text{ W/m}^2 \cdot ^\circ\text{C})(0.02865 \text{ m}^2)(85 - 25)^\circ\text{C} = 8.75 \text{ W}$$

Natural Convection inside Enclosures

9-61C We would recommend putting the hot fluid into the upper compartment of the container. In this case no convection currents will develop in the enclosure since the lighter (hot) fluid will always be on top of the heavier (cold) fluid.

9-62C We would disagree with this recommendation since the air space introduces some thermal resistance to heat transfer. The thermal resistance of air space will be zero only when the convection coefficient approaches infinity, which is never the case. However, when the air space is eliminated, so is its thermal resistance.

9-63C Yes, dividing the air space into two compartments will retard air motion in the air space, and thus slow down heat transfer by natural convection. The vinyl sheet will also act as a radiation shield and reduce heat transfer by radiation.

9-64C The effective thermal conductivity of an enclosure represents the enhancement on heat transfer as result of convection currents relative to conduction. The ratio of the effective thermal conductivity to the ordinary thermal conductivity yields Nusselt number $Nu = k_{eff} / k$.

9-65 Conduction thermal resistance of a medium is expressed as $R = L / (kA)$. Thermal resistance of a rectangular enclosure can be expressed by replacing L with characteristic length of enclosure L_c , and thermal conductivity k with effective thermal conductivity k_{eff} to give

$$R = L_c / (k_{eff} A) = L_c / (kNuA)$$

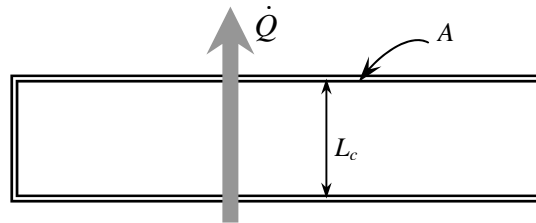

9-66 The U-factors for the center-of-glass section of a double-pane window and a triple-pane window are to be determined. Also, the percentage decrease in total heat transfer when triple-pane window is used is to be estimated.

Assumptions **1** Steady operating conditions exist. **2** Heat transfer through the window is one-dimensional. **3** The thermal resistance of glass sheets is negligible.

Properties The thermal conductivity of air space is given to be $0.025 \text{ W/m}\cdot^\circ\text{C}$.

Analysis The convection heat transfer coefficient of the air space is determined from

$$h_{\text{conv}} = \frac{k}{L} Nu = \frac{0.025 \text{ W/m}\cdot^\circ\text{C}}{0.015 \text{ m}} (1.2) = 2 \text{ W/m}^2\cdot^\circ\text{C}$$

Noting that the radiation across the air space is of the same magnitude as the convection, the combined heat transfer coefficient of the space is

$$h_{\text{space}} = h_{\text{conv}} + h_{\text{rad}} = 2h_{\text{conv}} = 2(2 \text{ W/m}^2\cdot^\circ\text{C}) = 4 \text{ W/m}^2\cdot^\circ\text{C}$$

Disregarding the thermal resistance of glass sheets, which are small, the U-factor for the center region of a double pane window is determined from

$$\frac{1}{U_{\text{double}}} = \frac{1}{h_i} + \frac{1}{h_{\text{space}}} + \frac{1}{h_o} = \frac{1}{6} + \frac{1}{4} + \frac{1}{25} \longrightarrow U_{\text{double}} = \mathbf{2.190 \text{ W/m}^2\cdot^\circ\text{C}}$$

Noting that there are two air spaces, the U-factor for triple-pane window is

$$\frac{1}{U_{\text{triple}}} = \frac{1}{h_i} + \frac{1}{h_{\text{space}}} + \frac{1}{h_{\text{space}}} + \frac{1}{h_o} = \frac{1}{6} + \frac{1}{4} + \frac{1}{4} + \frac{1}{25} \longrightarrow U_{\text{triple}} = \mathbf{1.415 \text{ W/m}^2\cdot^\circ\text{C}}$$

Considering that about 70 percent of total heat transfer through a window is due to center-of-glass section, the percentage decrease in total heat transfer when triple-pane window is used in place of double-pane window is

$$\% \text{ Decrease} = (0.70) \frac{U_{\text{double}} - U_{\text{triple}}}{U_{\text{double}}} = (0.70) \frac{2.190 - 1.415}{2.190} = (0.70)(0.354) = 0.248 = \mathbf{24.8\%}$$

That is, triple-pane window decreases the heat transfer through the center region by 35.4 percent while the decrease for the entire window is 24.8 percent. The use of triple-pane window is usually not justified economically except for extremely cold regions.

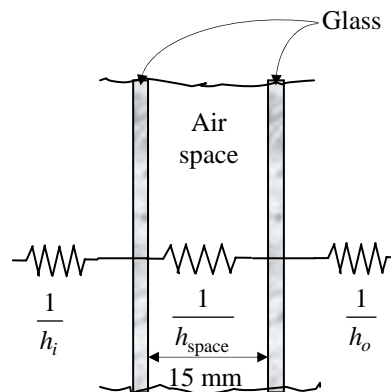

9-67 Two glasses of a double pane window are maintained at specified temperatures. The fraction of heat transferred through the enclosure by radiation is to be determined.

Assumptions **1** Steady operating conditions exist. **2** Air is an ideal gas with constant properties. **3** The air pressure in the enclosure is 1 atm.

Properties The properties of air at 1 atm and the average temperature of $(T_1 + T_2)/2 = (280 + 336)/2 = 308 \text{ K} = 35^\circ\text{C}$ are (Table A-15E)

$$k = 0.02625 \text{ W/m}\cdot^\circ\text{C}$$

$$\nu = 1.655 \times 10^{-5} \text{ m}^2/\text{s}$$

$$\text{Pr} = 0.7268$$

$$\beta = \frac{1}{T_f} = \frac{1}{308 \text{ K}} = 0.003247 \text{ K}^{-1}$$

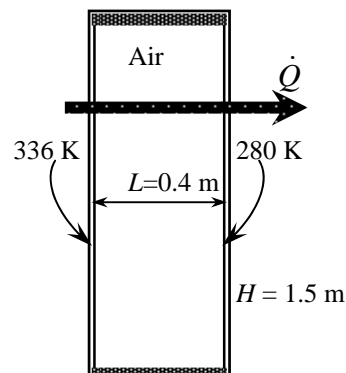

Analysis The characteristic length in this case is the distance between the two glasses, $L_c = L = 0.4 \text{ m}$. Then,

$$Ra_L = \frac{g\beta(T_1 - T_2)L_c^3}{\nu^2} \text{Pr} = \frac{(9.81 \text{ m/s}^2)(0.003247 \text{ K}^{-1})(336 - 280 \text{ K})(0.4 \text{ m})^3}{(1.655 \times 10^{-5} \text{ m}^2/\text{s})^2} (0.7268) = 3.029 \times 10^8$$

The aspect ratio of the geometry is $H/L = 1.5/0.4 = 3.75$. For this value of H/L the Nusselt number can be determined from

$$Nu = 0.22 \left(\frac{\text{Pr}}{0.2 + \text{Pr}} Ra \right)^{0.28} \left(\frac{H}{L} \right)^{-1/4} = 0.22 \left(\frac{0.7268}{0.2 + 0.7268} (3.029 \times 10^8) \right)^{0.28} \left(\frac{1.5}{0.4} \right)^{-1/4} = 35.00$$

Then,

$$A_s = H \times W = (1.5 \text{ m})(3 \text{ m}) = 4.5 \text{ m}^2$$

$$\dot{Q}_{\text{conv}} = kNuA_s \frac{T_1 - T_2}{L} = (0.02625 \text{ W/m}\cdot^\circ\text{C})(35.00)(4.5 \text{ m}^2) \frac{(336 - 280) \text{ K}}{0.4 \text{ m}} = 578.9 \text{ W}$$

The effective emissivity is

$$\frac{1}{\varepsilon_{\text{eff}}} = \frac{1}{\varepsilon_1} + \frac{1}{\varepsilon_2} - 1 = \frac{1}{0.15} + \frac{1}{0.90} - 1 = 6.778 \longrightarrow \varepsilon_{\text{eff}} = 0.1475$$

The rate of heat transfer by radiation is

$$\begin{aligned} \dot{Q}_{\text{rad}} &= \varepsilon_{\text{eff}} A_s \sigma (T_1^4 - T_2^4) \\ &= (0.1475)(4.5 \text{ m}^2)(5.67 \times 10^{-8} \text{ W/m}^2 \cdot \text{K}^4)[(336 \text{ K})^4 - (280 \text{ K})^4] = 248.4 \text{ W} \end{aligned}$$

Then the fraction of heat transferred through the enclosure by radiation becomes

$$f_{\text{rad}} = \frac{\dot{Q}_{\text{rad}}}{\dot{Q}_{\text{conv}} + \dot{Q}_{\text{rad}}} = \frac{248.4}{578.9 + 248.4} = \mathbf{0.30}$$

9-68E Two glasses of a double pane window are maintained at specified temperatures. The rate of heat transfer through the window by natural convection and radiation, and the R-value of insulation are to be determined.

Assumptions 1 Steady operating conditions exist. 2 Air is an ideal gas with constant properties. 3 The air pressure in the enclosure is 1 atm.

Properties The properties of air at 1 atm and the average temperature of $(T_1 + T_2)/2 = (65 + 40)/2 = 52.5^\circ\text{F}$ are (Table A-15E)

$$k = 0.01415 \text{ Btu/h}\cdot\text{ft}\cdot^\circ\text{F}$$

$$\nu = 0.1548 \times 10^{-3} \text{ ft}^2/\text{s}$$

$$\text{Pr} = 0.7332$$

$$\beta = \frac{1}{T_f} = \frac{1}{(52.5 + 460) \text{ R}} = 0.001951 \text{ R}^{-1}$$

Analysis (a) The characteristic length in this case is the distance between the two glasses, $L_c = L = 1 \text{ in}$. Then,

$$\text{Ra}_L = \frac{g\beta(T_1 - T_2)L_c^3}{\nu^2} \text{Pr} = \frac{(32.2 \text{ ft/s}^2)(0.001951 \text{ R}^{-1})(65 - 40 \text{ R})(1/12 \text{ ft})^3}{(0.1548 \times 10^{-3} \text{ ft}^2/\text{s})^2} (0.7332) = 27,824$$

The aspect ratio of the geometry is $H/L = 4 \times 12/1 = 48$ (which is a little over 40, but still close enough for an approximate analysis). For these values of H/L and Ra_L , the Nusselt number can be determined from

$$\text{Nu} = 0.42 \text{Ra}^{1/4} \text{Pr}^{0.012} \left(\frac{H}{L}\right)^{-0.3} = 0.42(27,824)^{1/4} (0.7332)^{0.012} \left(\frac{4 \text{ ft}}{1/12 \text{ ft}}\right)^{-0.3} = 1.692$$

Then,

$$A_s = H \times W = (4 \text{ ft})(6 \text{ ft}) = 24 \text{ ft}^2$$

$$\dot{Q} = k \text{Nu} A_s \frac{T_1 - T_2}{L} = (0.01415 \text{ Btu/h}\cdot\text{ft}\cdot^\circ\text{F})(1.692)(24 \text{ ft}^2) \frac{(65 - 40)^\circ\text{F}}{(1/12) \text{ ft}} = \mathbf{172.4 \text{ Btu/h}}$$

(b) The rate of heat transfer by radiation is

$$\begin{aligned} \dot{Q}_{rad} &= \varepsilon A_s \sigma (T_1^4 - T_2^4) \\ &= (0.82)(24 \text{ ft}^2)(0.1714 \times 10^{-8} \text{ Btu/h}\cdot\text{ft}^2\cdot\text{R}^4)[(65 + 460 \text{ R})^4 - (40 + 460 \text{ R})^4] = \mathbf{454.3 \text{ Btu/h}} \end{aligned}$$

Then the total rate of heat transfer is

$$\dot{Q}_{total} = \dot{Q}_{convection} + \dot{Q}_{rad} = 172.4 + 454.3 = 626.7 \text{ Btu/h}$$

Then the effective thermal conductivity of the air, which also accounts for the radiation effect and the R-value become

$$\dot{Q}_{total} = k_{eff} A_s \frac{T_1 - T_2}{L} \longrightarrow k_{eff} = \frac{\dot{Q}L}{A_s(T_1 - T_2)} = \frac{(626.7 \text{ Btu/h})(1/12 \text{ ft})}{(24 \text{ ft}^2)(65 - 40)^\circ\text{F}} = 0.08704 \text{ Btu/h}\cdot\text{ft}\cdot^\circ\text{F}$$

$$R_{value} = \frac{L}{k_{eff}} = \frac{(1/12 \text{ ft})}{0.08704 \text{ Btu/h}\cdot\text{ft}\cdot^\circ\text{F}} = 0.957 \text{ h}\cdot\text{ft}^2\cdot^\circ\text{F}/\text{Btu} = \mathbf{R - 0.96}$$

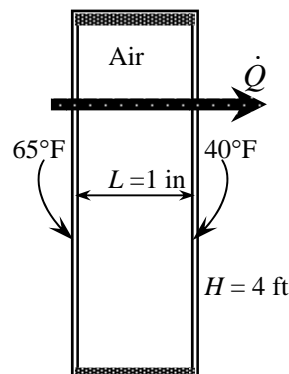

9-69E EES Prob. 9-68E is reconsidered. The effect of the air gap thickness on the rates of heat transfer by natural convection and radiation, and the R -value of insulation is to be investigated.

Analysis The problem is solved using EES, and the solution is given below.

"GIVEN"

H=4 [ft]
 W=6 [ft]
 L=1 [in]
 T_1=65 [F]
 T_2=40 [F]
 epsilon_eff=0.82

"PROPERTIES"

Fluid\$='air'
 k=Conductivity(Fluid\$, T=T_ave)
 Pr=Prandtl(Fluid\$, T=T_ave)
 rho=Density(Fluid\$, T=T_ave, P=14.7)
 mu=Viscosity(Fluid\$, T=T_ave)*Convert(lbm/ft-h, lbm/ft-s)
 nu=mu/rho
 beta=1/(T_ave+460)
 T_ave=1/2*(T_1+T_2)
 g=32.2 [ft/s^2]
 sigma=0.1714E-8 [Btu/h-ft^2-R^4]

"ANALYSIS"

L_ft=L*Convert(in, ft)
 Ra=(g*beta*(T_1-T_2)*L_ft^3)/nu^2*Pr
 Ratio=H/L_ft
 Nusselt=0.42*Ra^0.25*Pr^0.012*(H/L_ft)^(-0.3)
 A=H*W
 Q_dot_conv=k*Nusselt*A*(T_1-T_2)/L_ft
 Q_dot_rad=epsilon_eff*A*sigma*((T_1+460)^4-(T_2+460)^4)
 Q_dot_total=Q_dot_conv+Q_dot_rad
 Q_dot_total=k_eff*A*(T_1-T_2)/L_ft
 R_value=L_ft/k_eff

L [in]	Q _{conv} [Btu/h]	Q _{rad} [Btu/h]	R-value [h.ft ² .F/Btu]
0.2	159.1	454.3	0.9781
0.3	162.3	454.3	0.973
0.4	164.7	454.3	0.9693
0.5	166.5	454.3	0.9664
0.6	168.1	454.3	0.964
0.7	169.4	454.3	0.962
0.8	170.5	454.3	0.9603
0.9	171.5	454.3	0.9587
1	172.4	454.3	0.9573
1.1	173.2	454.3	0.9561
1.2	174	454.3	0.9549
1.3	174.7	454.3	0.9539
1.4	175.3	454.3	0.9529
1.5	175.9	454.3	0.952

1.6	176.5	454.3	0.9511
1.7	177	454.3	0.9503
1.8	177.5	454.3	0.9496
1.9	178	454.3	0.9488
2	178.5	454.3	0.9481

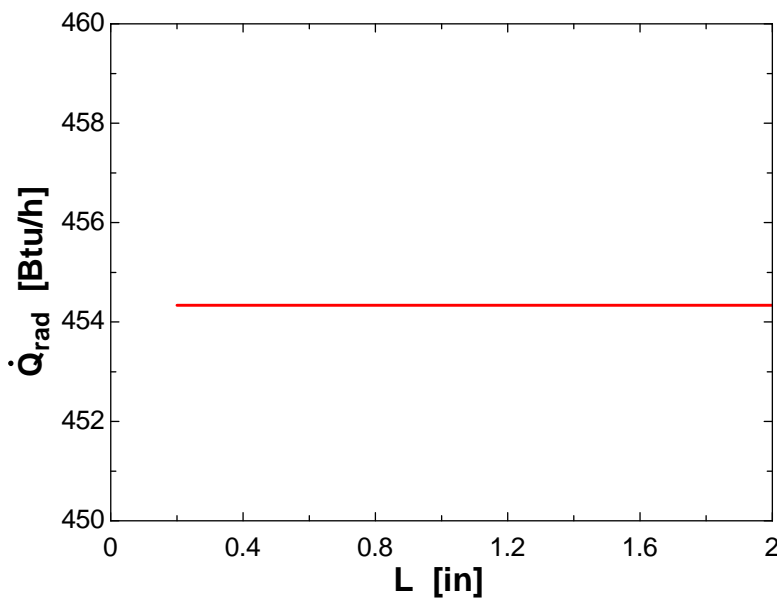
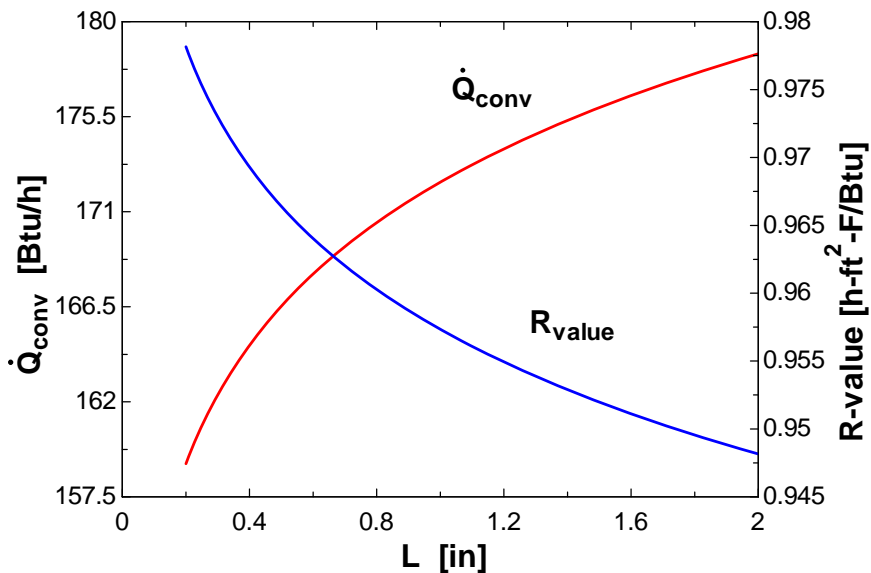

9-70 Two surfaces of a spherical enclosure are maintained at specified temperatures. The rate of heat transfer through the enclosure is to be determined.

Assumptions 1 Steady operating conditions exist. 2 Air is an ideal gas with constant properties. 3 The air pressure in the enclosure is 1 atm.

Properties The properties of air at 1 atm and the average temperature of $(T_1+T_2)/2 = (350+275)/2 = 312.5 \text{ K} = 39.5^\circ\text{C}$ are (Table A-15)

$$k = 0.02658 \text{ W/m}\cdot^\circ\text{C}$$

$$\nu = 1.697 \times 10^{-5} \text{ m}^2/\text{s}$$

$$\text{Pr} = 0.7256$$

$$\beta = \frac{1}{T_f} = \frac{1}{312.5 \text{ K}} = 0.003200 \text{ K}^{-1}$$

Analysis The characteristic length in this case is determined from

$$L_c = \frac{D_2 - D_1}{2} = \frac{25 - 15}{2} = 5 \text{ cm.}$$

Then,

$$Ra = \frac{g\beta(T_1 - T_2)L_c^3}{\nu^2} \text{Pr} = \frac{(9.81 \text{ m/s}^2)(0.003200 \text{ K}^{-1})(350 - 275 \text{ K})(0.05 \text{ m})^3}{(1.697 \times 10^{-5} \text{ m}^2/\text{s})^2} (0.7256) = 7.415 \times 10^5$$

The effective thermal conductivity is

$$F_{\text{sph}} = \frac{L_c}{(D_i D_o)^4 (D_i^{-7/5} + D_o^{-7/5})^5} = \frac{0.05 \text{ m}}{[(0.15 \text{ m})(0.25 \text{ m})]^4 [(0.15 \text{ m})^{-7/5} + (0.25 \text{ m})^{-7/5}]^5} = 0.005900$$

$$\begin{aligned} k_{\text{eff}} &= 0.74k \left(\frac{\text{Pr}}{0.861 + \text{Pr}} \right)^{1/4} (F_{\text{sph}} Ra)^{1/4} \\ &= 0.74(0.02658 \text{ W/m}\cdot^\circ\text{C}) \left(\frac{0.7256}{0.861 + 0.7256} \right)^{1/4} [(0.005900)(7.415 \times 10^5)]^{1/4} = 0.1315 \text{ W/m}\cdot^\circ\text{C} \end{aligned}$$

Then the rate of heat transfer between the spheres becomes

$$\dot{Q} = k_{\text{eff}} \pi \left(\frac{D_i D_o}{L_c} \right) (T_i - T_o) = (0.1315 \text{ W/m}\cdot^\circ\text{C}) \pi \left[\frac{(0.15 \text{ m})(0.25 \text{ m})}{(0.05 \text{ m})} \right] (350 - 275) \text{ K} = \mathbf{23.3 \text{ W}}$$

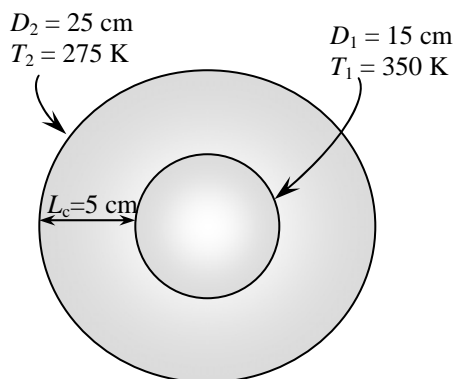

9-71 EES Prob. 9-70 is reconsidered. The rate of natural convection heat transfer as a function of the hot surface temperature of the sphere is to be plotted.

Analysis The problem is solved using EES, and the solution is given below.

"GIVEN"

$$D_1 = 0.15 \text{ [m]}$$

$$D_2 = 0.25 \text{ [m]}$$

$$T_1 = 350 \text{ [K]}$$

$$T_2 = 275 \text{ [K]}$$

"PROPERTIES"

$$\text{Fluid\$} = \text{'air'}$$

$$k = \text{Conductivity}(\text{Fluid\$}, T = T_{\text{ave}})$$

$$\text{Pr} = \text{Prandtl}(\text{Fluid\$}, T = T_{\text{ave}})$$

$$\rho = \text{Density}(\text{Fluid\$}, T = T_{\text{ave}}, P = 101.3)$$

$$\mu = \text{Viscosity}(\text{Fluid\$}, T = T_{\text{ave}})$$

$$\nu = \mu / \rho$$

$$\beta = 1 / T_{\text{ave}}$$

$$T_{\text{ave}} = 1/2 * (T_1 + T_2)$$

$$g = 9.807 \text{ [m/s}^2\text{]}$$

"ANALYSIS"

$$L = (D_2 - D_1) / 2$$

$$\text{Ra} = (g * \beta * (T_1 - T_2) * L^3) / \nu^2 * \text{Pr}$$

$$F_{\text{sph}} = L / ((D_1 * D_2)^4 * (D_1^{-7/5} + D_2^{-7/5}))^{5/4}$$

$$k_{\text{eff}} = 0.74 * k * (\text{Pr} / (0.861 + \text{Pr}))^{0.25} * (F_{\text{sph}} * \text{Ra})^{0.25}$$

$$\dot{Q} = k_{\text{eff}} * \pi * (D_1 * D_2) / L * (T_1 - T_2)$$

T_1 [K]	\dot{Q} [W]
300	6.038
310	9.147
320	12.46
330	15.93
340	19.53
350	23.25
360	27.05
370	30.94
380	34.9
390	38.93
400	43.01
410	47.15
420	51.33
430	55.55
440	59.81
450	64.11
460	68.44
470	72.8
480	77.19
490	81.61
500	86.05

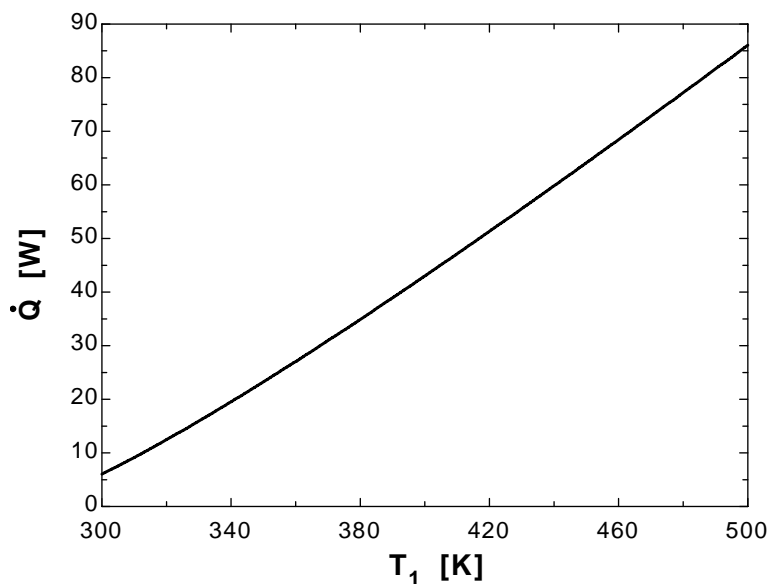

9-72 The absorber plate and the glass cover of a flat-plate solar collector are maintained at specified temperatures. The rate of heat loss from the absorber plate by natural convection is to be determined.

Assumptions 1 Steady operating conditions exist. **2** Air is an ideal gas with constant properties. **3** Heat loss by radiation is negligible. **4** The air pressure in the enclosure is 1 atm.

Properties The properties of air at 1 atm and the average temperature of $(T_1+T_2)/2 = (80+40)/2 = 60^\circ\text{C}$ are (Table A-15)

$$k = 0.02808 \text{ W/m}\cdot^\circ\text{C}$$

$$\nu = 1.896 \times 10^{-5} \text{ m}^2/\text{s}$$

$$\text{Pr} = 0.7202$$

$$\beta = \frac{1}{T_f} = \frac{1}{(60 + 273)\text{K}} = 0.003003 \text{ K}^{-1}$$

Analysis For $\theta = 0^\circ$, we have horizontal rectangular enclosure. The characteristic length in this case is the distance between the two glasses $L_c = L = 0.025 \text{ m}$. Then,

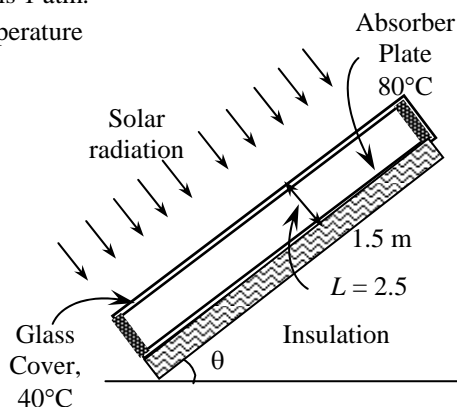

$$\text{Ra} = \frac{g\beta(T_1 - T_2)L^3}{\nu^2} \text{Pr} = \frac{(9.81 \text{ m/s}^2)(0.003003 \text{ K}^{-1})(80 - 40 \text{ K})(0.025 \text{ m})^3}{(1.896 \times 10^{-5} \text{ m}^2/\text{s})^2} (0.7202) = 3.689 \times 10^4$$

$$\begin{aligned} \text{Nu} &= 1 + 1.44 \left[1 - \frac{1708}{\text{Ra}} \right]^+ + \left[\frac{\text{Ra}^{1/3}}{18} - 1 \right]^+ \\ &= 1 + 1.44 \left[1 - \frac{1708}{3.689 \times 10^4} \right]^+ + \left[\frac{(3.689 \times 10^4)^{1/3}}{18} - 1 \right]^+ = 3.223 \end{aligned}$$

Then

$$A_s = H \times W = (1.5 \text{ m})(3 \text{ m}) = 4.5 \text{ m}^2$$

$$\dot{Q} = k\text{Nu}A_s \frac{T_1 - T_2}{L} = (0.02808 \text{ W/m}\cdot^\circ\text{C})(3.223)(4.5 \text{ m}^2) \frac{(80 - 40)^\circ\text{C}}{0.025 \text{ m}} = \mathbf{652 \text{ W}}$$

For $\theta = 30^\circ$, we obtain

$$\begin{aligned} \text{Nu} &= 1 + 1.44 \left[1 - \frac{1708}{\text{Ra} \cos \theta} \right]^+ \left[1 - \frac{1708(\sin 1.8\theta)^{1.6}}{\text{Ra} \cos \theta} \right]^+ + \left[\frac{(\text{Ra} \cos \theta)^{1/3}}{18} - 1 \right]^+ \\ &= 1 + 1.44 \left[1 - \frac{1708}{(3.689 \times 10^4) \cos(30)} \right]^+ \left[1 - \frac{1708[\sin(1.8 \times 30)]^{1.6}}{(3.689 \times 10^4) \cos(30)} \right]^+ + \left[\frac{[(3.689 \times 10^4) \cos(30)]^{1/3}}{18} - 1 \right]^+ \\ &= 3.074 \end{aligned}$$

$$\dot{Q} = k\text{Nu}A_s \frac{T_1 - T_2}{L} = (0.02808 \text{ W/m}\cdot^\circ\text{C})(3.074)(4.5 \text{ m}^2) \frac{(80 - 40)^\circ\text{C}}{0.025 \text{ m}} = \mathbf{621 \text{ W}}$$

For $\theta = 90^\circ$, we have vertical rectangular enclosure. The Nusselt number for this geometry and orientation can be determined from ($\text{Ra} = 3.689 \times 10^4$ - same as that for horizontal case)

$$\text{Nu} = 0.42\text{Ra}^{1/4} \text{Pr}^{0.012} \left(\frac{H}{L} \right)^{-0.3} = 0.42(3.689 \times 10^4)^{1/4} (0.7202)^{0.012} \left(\frac{2 \text{ m}}{0.025 \text{ m}} \right)^{-0.3} = 1.557$$

$$\dot{Q} = k\text{Nu}A_s \frac{T_1 - T_2}{L} = (0.02808 \text{ W/m}\cdot^\circ\text{C})(1.557)(4.5 \text{ m}^2) \frac{(80 - 40)^\circ\text{C}}{0.025 \text{ m}} = \mathbf{315 \text{ W}}$$

Discussion Caution is advised for the vertical case since the condition $H/L < 40$ is not satisfied.

9-73 A simple solar collector is built by placing a clear plastic tube around a garden hose. The rate of heat loss from the water in the hose per meter of its length by natural convection is to be determined.

Assumptions 1 Steady operating conditions exist. 2 Air is an ideal gas with constant properties. 3 Heat loss by radiation is negligible. 3 The air pressure in the enclosure is 1 atm.

Properties The properties of air at 1 atm and the anticipated average temperature of $(T_i + T_o)/2 = (65 + 35)/2 = 50^\circ\text{C}$ are (Table A-15)

$$k = 0.02735 \text{ W/m}\cdot^\circ\text{C}$$

$$\nu = 1.798 \times 10^{-5} \text{ m}^2/\text{s}$$

$$\text{Pr} = 0.7228$$

$$\beta = \frac{1}{T_f} = \frac{1}{(50 + 273)\text{K}} = 0.003096 \text{ K}^{-1}$$

Analysis We assume the plastic tube temperature to be 35°C . We will check this assumption later, and repeat calculations, if necessary. The characteristic length in this case is

$$L_c = \frac{D_o - D_i}{2} = \frac{5 - 1.6}{2} = 1.7 \text{ cm}$$

Then,

$$\text{Ra} = \frac{g\beta(T_i - T_o)L_c^3}{\nu^2} \text{Pr} = \frac{(9.81 \text{ m/s}^2)(0.003096 \text{ K}^{-1})(65 - 35 \text{ K})(0.017 \text{ m})^3}{(1.798 \times 10^{-5} \text{ m}^2/\text{s})^2} (0.7228) = 10,000$$

The effective thermal conductivity is

$$F_{\text{cyl}} = \frac{[\ln(D_o / D_i)]^4}{L_c^3 (D_i^{-3/5} + D_o^{-3/5})^5} = \frac{[\ln(0.05 / 0.016)]^4}{(0.017 \text{ m})^3 [(0.016 \text{ m})^{-3/5} + (0.05 \text{ m})^{-3/5}]^5} = 0.1821$$

$$k_{\text{eff}} = 0.386k \left(\frac{\text{Pr}}{0.861 + \text{Pr}} \right)^{1/4} (F_{\text{cyl}} \text{Ra})^{1/4}$$

$$= 0.386(0.02735 \text{ W/m}\cdot^\circ\text{C}) \left(\frac{0.7228}{0.861 + 0.7228} \right)^{1/4} [(0.1821)(10,000)]^{1/4} = 0.05670 \text{ W/m}\cdot^\circ\text{C}$$

Then the rate of heat transfer between the cylinders becomes

$$\dot{Q} = \frac{2\pi k_{\text{eff}}}{\ln(D_o / D_i)} (T_i - T_o) = \frac{2\pi(0.05670 \text{ W/m}\cdot^\circ\text{C})}{\ln(0.05 / 0.016)} (65 - T_o) \quad (\text{Eq. 1})$$

Now we will calculate heat transfer from plastic tube to the ambient air by natural convection. Note that we should find a result close to the value we have already calculated since in steady operation they must be equal to each other. Also note that we neglect radiation heat transfer. We will use the same assumption for the plastic tube temperature (i.e., 35°C). The properties of air at 1 atm and the film temperature of $T_{\text{avg}} = (T_s + T_\infty) / 2 = (35 + 26) / 2 = 30.5^\circ\text{C}$ are

$$k = 0.02592 \text{ W/m}\cdot^\circ\text{C}, \quad \nu = 1.613 \times 10^{-5} \text{ m}^2/\text{s},$$

$$\text{Pr} = 0.7281, \quad \text{and } \beta = 1/T_f = 1/(30.5 + 273)\text{K} = 0.003295 \text{ K}^{-1}$$

The characteristic length in this case is the outer diameter of the solar collector $L_c = D_o = 0.05 \text{ m}$. Then,

$$\text{Ra} = \frac{g\beta(T_s - T_\infty)D_o^3}{\nu^2} \text{Pr} = \frac{(9.81 \text{ m/s}^2)(0.003295 \text{ K}^{-1})(35 - 26 \text{ K})(0.05 \text{ m})^3}{(1.613 \times 10^{-5} \text{ m}^2/\text{s})^2} (0.7281) = 1.018 \times 10^5$$

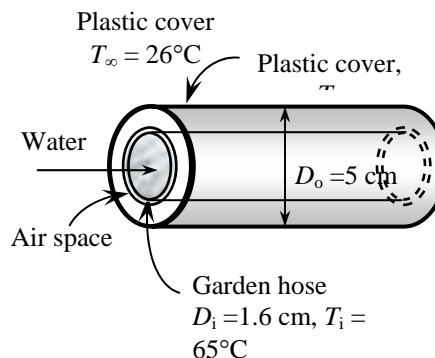

$$Nu = \left\{ 0.6 + \frac{0.387 Ra^{1/6}}{\left[1 + (0.559 / Pr)^{9/16} \right]^{8/27}} \right\}^2 = \left\{ 0.6 + \frac{0.387 (1.018 \times 10^5)^{1/6}}{\left[1 + (0.559 / 0.7281)^{9/16} \right]^{8/27}} \right\}^2 = 7.838$$

$$A_o = \pi D_o L = \pi (0.05 \text{ m})(1 \text{ m}) = 0.1571 \text{ m}^2$$

$$h_o = \frac{k}{D_o} Nu = \frac{0.02592 \text{ W/m} \cdot \text{°C}}{0.05 \text{ m}} (7.838) = 4.063 \text{ W/m}^2 \cdot \text{°C}$$

$$\dot{Q} = h A_o (T_o - T_\infty) = (4.063 \text{ W/m}^2 \cdot \text{°C})(0.1571 \text{ m}^2)(T_o - 26) \text{°C} \quad (\text{Eq. 2})$$

Solving Eq. 1 and Eq. 2 simultaneously, we find

$$T_o = 38.8 \text{°C}, \quad \dot{Q} = 8.18 \text{ W}$$

Repeating the calculations at the new average temperature for enclosure analysis and at the new film temperature for convection at the outer surface analysis using the new calculated temperature 38.8°C, we find

$$T_o = 39.0 \text{°C}, \quad \dot{Q} = \mathbf{8.22 \text{ W}}$$

9-74 EES Prob. 9-73 is reconsidered. The rate of heat loss from the water by natural convection as a function of the ambient air temperature is to be plotted.

Analysis The problem is solved using EES, and the solution is given below.

"GIVEN"

D_1=0.016 [m]
 D_2=0.05 [m]
 T_1=65 "[C]"
 T_infinity=26 [C]
 Length=1 [m] "unit length of the tube is considered"

"PROPERTIES for enclosure"

Fluid\$='air'
 k_1=Conductivity(Fluid\$, T=T_ave)
 Pr_1=Prandtl(Fluid\$, T=T_ave)
 rho_1=Density(Fluid\$, T=T_ave, P=101.3)
 mu_1=Viscosity(Fluid\$, T=T_ave)
 nu_1=mu_1/rho_1
 beta_1=1/(T_ave+273)
 T_ave=1/2*(T_1+T_2)
 g=9.807 [m/s^2]

"ANALYSIS for enclosure"

L=(D_2-D_1)/2
 Ra_1=(g*beta_1*(T_1-T_2)*L^3)/nu_1^2*Pr_1
 F_cyl=(ln(D_2/D_1))^4/(L^3*(D_1^(-3/5)+D_2^(-3/5))^5)
 k_eff=0.386*k_1*(Pr_1/(0.861+Pr_1))^0.25*(F_cyl*Ra_1)^0.25
 Q_dot=(2*pi*k_eff)/ln(D_2/D_1)*(T_1-T_2)

"PROPERTIES for convection on the outer surface"

k_2=Conductivity(Fluid\$, T=T_film)
 Pr_2=Prandtl(Fluid\$, T=T_film)
 rho_2=Density(Fluid\$, T=T_film, P=101.3)
 mu_2=Viscosity(Fluid\$, T=T_film)
 nu_2=mu_2/rho_2
 beta_2=1/(T_film+273)
 T_film=1/2*(T_2+T_infinity)

"ANALYSIS for convection on the outer surface"

delta=D_2
 Ra_2=(g*beta_2*(T_2-T_infinity)*delta^3)/nu_2^2*Pr_2
 Nusselt=(0.6+(0.387*Ra_2^(1/6)))/(1+(0.559/Pr_2)^(9/16))^(8/27))^2
 h=k_2/delta*Nusselt
 A=pi*D_2*Length
 Q_dot=h*A*(T_2-T_infinity)

T_{∞} [W]	Q [W]
4	14.6
6	13.98
8	13.37
10	12.77
12	12.18
14	11.59
16	11.01
18	10.44
20	9.871
22	9.314
24	8.764
26	8.222
28	7.688
30	7.163
32	6.647
34	6.139
36	5.641
38	5.153
40	4.675

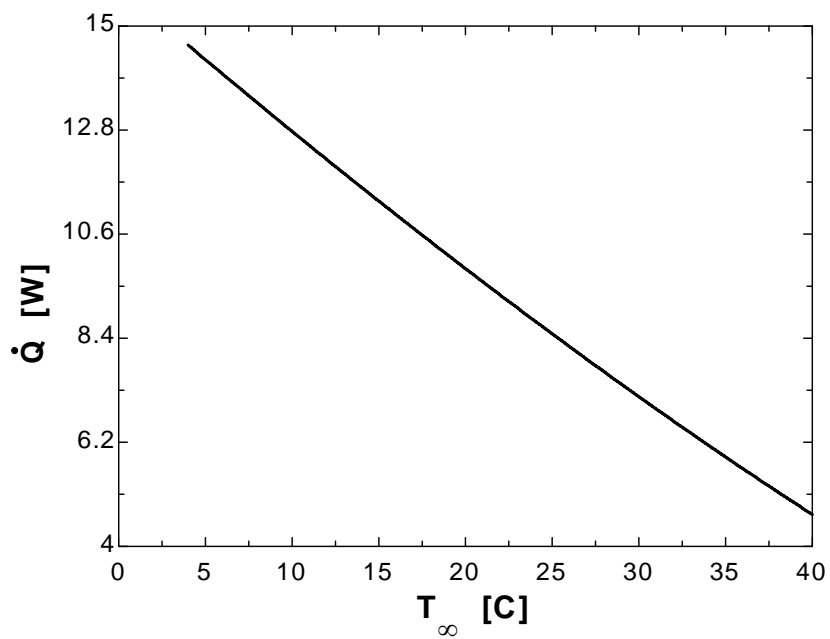

9-75 A double pane window with an air gap is considered. The rate of heat transfer through the window by natural convection the temperature of the outer glass layer are to be determined.

Assumptions 1 Steady operating conditions exist. 2 Air is an ideal gas with constant properties. 3 The air pressure in the enclosure is 1 atm. 4 Radiation heat transfer is neglected.

Properties For natural convection between the inner surface of the window and the room air, the properties of air at 1 atm and the film temperature of $(T_s+T_\infty)/2 = (18+26)/2 = 22^\circ\text{C}$ are (Table A-15)

$$k = 0.02529 \text{ W/m}\cdot^\circ\text{C}$$

$$\nu = 1.534 \times 10^{-5} \text{ m}^2/\text{s}$$

$$\text{Pr} = 0.7304$$

$$\beta = \frac{1}{T_f} = \frac{1}{(22+273)\text{K}} = 0.00339 \text{ K}^{-1}$$

For natural convection between the two glass sheets separated by an air gap, the properties of air at 1 atm and the anticipated average temperature of $(T_1+T_2)/2 = (18+0)/2 = 9^\circ\text{C}$ are (Table A-15)

$$k = 0.02431 \text{ W/m}\cdot^\circ\text{C}, \quad \nu = 1.417 \times 10^{-5} \text{ m}^2/\text{s}$$

$$\text{Pr} = 0.7339, \quad \beta = \frac{1}{T_f} = \frac{1}{(9+273)\text{K}} = 0.003546 \text{ K}^{-1}$$

Analysis We first calculate the natural convection heat transfer between the room air and the inner surface of the window.

$$L_c = H = 1.3 \text{ m}$$

$$\text{Ra} = \frac{g\beta(T_s - T_\infty)H^3}{\nu^2} \text{Pr} = \frac{(9.81 \text{ m/s}^2)(0.00339 \text{ K}^{-1})(26-18)\text{K}(1.3 \text{ m})^3}{(1.534 \times 10^{-5} \text{ m}^2/\text{s})^2} (0.7304) = 1.813 \times 10^9$$

$$\text{Nu} = \left\{ 0.825 + \frac{0.387\text{Ra}^{1/6}}{\left[1 + \left(\frac{0.492}{\text{Pr}} \right)^{9/16} \right]^{8/27}} \right\}^2 = \left\{ 0.825 + \frac{0.387(1.813 \times 10^9)^{1/6}}{\left[1 + \left(\frac{0.492}{0.7304} \right)^{9/16} \right]^{8/27}} \right\}^2 = 148.3$$

$$h = \frac{k}{H} \text{Nu} = \frac{0.02529 \text{ W/m}\cdot^\circ\text{C}}{1.3 \text{ m}} (148.3) = 2.884 \text{ W/m}^2 \cdot ^\circ\text{C}$$

$$A_s = H \times W = (1.3 \text{ m})(2.8 \text{ m}) = 3.64 \text{ m}^2$$

$$\dot{Q}_{\text{conv}} = hA_s(T_\infty - T_s) = (2.884 \text{ W/m}^2 \cdot ^\circ\text{C})(3.64 \text{ m}^2)(26-18)^\circ\text{C} = \mathbf{84.0 \text{ W}}$$

Next, we consider the natural convection between the two glass sheets separated by an air gap.

$$L_c = L = 2.2 \text{ cm}$$

$$\text{Ra} = \frac{g\beta(T_1 - T_2)L^3}{\nu^2} \text{Pr} = \frac{(9.81 \text{ m/s}^2)(0.003546 \text{ K}^{-1})(18-0)\text{K}(0.022 \text{ m})^3}{(1.417 \times 10^{-5} \text{ m}^2/\text{s})^2} (0.7339) = 24,370$$

$$\text{Nu} = 0.42\text{Ra}^{1/4} \text{Pr}^{0.012} \left(\frac{H}{L} \right)^{-0.3} = 0.42(24,370)^{1/4} (0.7339)^{0.012} \left(\frac{1.3 \text{ m}}{0.022 \text{ m}} \right)^{-0.3} = 1.538$$

Under steady operation, the rate of heat transfer between the room air and the inner surface of the window is equal to the heat transfer through the air gap. Setting these two equal to each other we obtain the temperature of the outer glass sheet

$$\dot{Q} = k\text{Nu}A_s \frac{T_1 - T_2}{L} \longrightarrow 84 \text{ W} = (0.02431 \text{ W/m}\cdot^\circ\text{C})(1.538)(3.64 \text{ m}^2) \frac{(18 - T_2)^\circ\text{C}}{0.022 \text{ m}} \longrightarrow T_2 = \mathbf{4.4^\circ\text{C}}$$

which is sufficiently close to the assumed temperature 0°C . Therefore, there is no need to repeat the calculations.

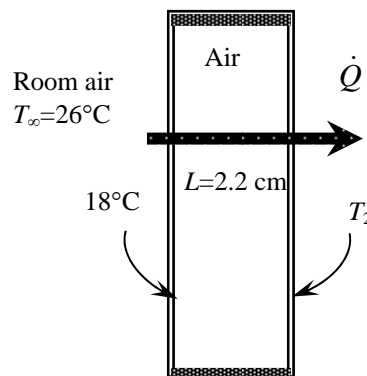

9-76 The space between the two concentric cylinders is filled with water or air. The rate of heat transfer from the outer cylinder to the inner cylinder by natural convection is to be determined for both cases.

Assumptions 1 Steady operating conditions exist. 2 Air is an ideal gas with constant properties. 3 The air pressure in the enclosure is 1 atm. 4 Heat transfer by radiation is negligible.

Properties The properties of water air at the average temperature of $(T_i+T_o)/2 = (54+106)/2 = 80^\circ\text{C}$ are (Table A-9)

$$k = 0.670 \text{ W/m}\cdot^\circ\text{C}$$

$$\nu = 3.653 \times 10^{-7} \text{ m}^2/\text{s}$$

$$\text{Pr} = 2.22$$

$$\beta = 0.653 \times 10^{-3} \text{ K}^{-1}$$

The properties of air at 1 atm and the average temperature of $(T_i+T_o)/2 = (54+106)/2 = 80^\circ\text{C}$ are (Table A-15)

$$k = 0.02953 \text{ W/m}\cdot^\circ\text{C}$$

$$\nu = 2.097 \times 10^{-5} \text{ m}^2/\text{s}$$

$$\text{Pr} = 0.7154$$

$$\beta = \frac{1}{T_f} = \frac{1}{(80+273)\text{K}} = 0.002833 \text{ K}^{-1}$$

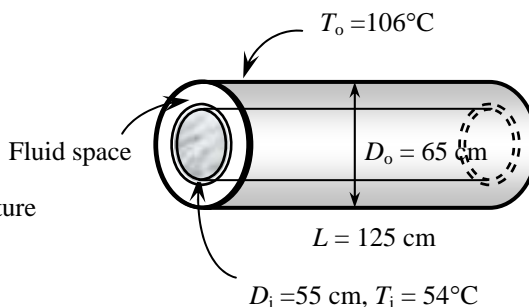

Analysis (a) The fluid is water:

$$L_c = \frac{D_o - D_i}{2} = \frac{65 - 55}{2} = 5 \text{ cm.}$$

$$\text{Ra} = \frac{g\beta(T_o - T_i)L_c^3}{\nu^2} \text{Pr} = \frac{(9.81 \text{ m/s}^2)(0.653 \times 10^{-3} \text{ K}^{-1})(106 - 54)\text{K}(0.05 \text{ m})^3}{(3.653 \times 10^{-7} \text{ m}^2/\text{s})^2} (2.22) = 6.927 \times 10^8$$

The effective thermal conductivity is

$$F_{\text{cyl}} = \frac{\left[\ln \frac{D_o}{D_i} \right]^4}{L_c^3 (D_i^{-3/5} + D_o^{-3/5})^5} = \frac{\left[\ln \frac{0.65 \text{ m}}{0.55 \text{ m}} \right]^4}{(0.05 \text{ m})^3 \left[(0.55 \text{ m})^{-7/5} + (0.65 \text{ m})^{-7/5} \right]^5} = 0.04136$$

$$k_{\text{eff}} = 0.386k \left(\frac{\text{Pr}}{0.861 + \text{Pr}} \right)^{1/4} (F_{\text{cyl}} \text{Ra})^{1/4}$$

$$= 0.386(0.670 \text{ W/m}\cdot^\circ\text{C}) \left(\frac{2.22}{0.861 + 2.22} \right)^{1/4} \left[(0.04136)(6.927 \times 10^8) \right]^{1/4} = 17.43 \text{ W/m}\cdot^\circ\text{C}$$

Then the rate of heat transfer between the cylinders becomes

$$\dot{Q} = \frac{2\pi k_{\text{eff}}}{\ln \left(\frac{D_o}{D_i} \right)} (T_o - T_i) = \frac{2\pi(17.43 \text{ W/m}\cdot^\circ\text{C})}{\ln \left(\frac{0.65 \text{ m}}{0.55 \text{ m}} \right)} (106 - 54) = 34,090 \text{ W} = \mathbf{34.1 \text{ kW}}$$

(b) The fluid is air:

$$\text{Ra} = \frac{g\beta(T_o - T_i)L_c^3}{\nu^2} \text{Pr} = \frac{(9.81 \text{ m/s}^2)(0.002833 \text{ K}^{-1})(106 - 54)\text{K}(0.05 \text{ m})^3}{(2.097 \times 10^{-5} \text{ m}^2/\text{s})^2} (0.7154) = 2.939 \times 10^5$$

The effective thermal conductivity is

$$F_{\text{cyl}} = \frac{\left[\ln \frac{D_o}{D_i} \right]^4}{L_c^3 (D_i^{-3/5} + D_o^{-3/5})^5} = \frac{\left[\ln \frac{0.65 \text{ m}}{0.55 \text{ m}} \right]^4}{(0.05 \text{ m})^3 [(0.55 \text{ m})^{-7/5} + (0.65 \text{ m})^{-7/5}]^5} = 0.04136$$

$$k_{\text{eff}} = 0.386k \left(\frac{\text{Pr}}{0.861 + \text{Pr}} \right)^{1/4} (F_{\text{cyl}} \text{Ra})^{1/4}$$

$$= 0.386(0.02953 \text{ W/m}\cdot\text{C}) \left(\frac{0.7154}{0.861 + 0.7154} \right)^{1/4} [(0.04136)(2.939 \times 10^5)]^{1/4} = 0.09824 \text{ W/m}\cdot\text{C}$$

Then the rate of heat transfer between the cylinders becomes

$$\dot{Q} = \frac{2\pi k_{\text{eff}}}{\ln \left(\frac{D_o}{D_i} \right)} (T_o - T_i) = \frac{2\pi(0.09824 \text{ W/m}\cdot\text{C})}{\ln \left(\frac{0.65 \text{ m}}{0.55 \text{ m}} \right)} (106 - 54) = \mathbf{192 \text{ W}}$$

Combined Natural and Forced Convection

9-77C In combined natural and forced convection, the natural convection is negligible when $Gr/Re^2 < 0.1$. Otherwise it is not.

9-78C In assisting or transverse flows, natural convection enhances forced convection heat transfer while in opposing flow it hurts forced convection.

9-79C When neither natural nor forced convection is negligible, it is not correct to calculate each separately and to add them to determine the total convection heat transfer. Instead, the correlation

$$Nu_{\text{combined}} = \left(Nu_{\text{forced}}^n + Nu_{\text{natural}}^n \right)^{1/n}$$

based on the experimental studies should be used.

9-80 A vertical plate in air is considered. The forced motion velocity above which natural convection heat transfer from the plate is negligible is to be determined.

Assumptions 1 Steady operating conditions exist. 2 Air is an ideal gas with constant properties. 3 The atmospheric pressure at that location is 1 atm.

Properties The properties of air at 1 atm and 1 atm and the film temperature of $(T_s + T_\infty)/2 = (85 + 30)/2 = 57.5^\circ\text{C}$ are (Table A-15)

$$\nu = 1.872 \times 10^{-5} \text{ m}^2/\text{s}$$

$$\beta = \frac{1}{T_f} = \frac{1}{(57.5 + 273)\text{K}} = 0.003026 \text{ K}^{-1}$$

Analysis The characteristic length is the height of the plate, $L_c = L = 5 \text{ m}$. The Grashof and Reynolds numbers are

$$Gr = \frac{g\beta(T_s - T_\infty)L^3}{\nu^2} = \frac{(9.81 \text{ m/s}^2)(0.003026 \text{ K}^{-1})(85 - 30 \text{ K})(5 \text{ m})^3}{(1.872 \times 10^{-5} \text{ m}^2/\text{s})^2} = 5.823 \times 10^{11}$$

$$Re = \frac{VL}{\nu} = \frac{V_\infty(5 \text{ m})}{1.872 \times 10^{-5} \text{ m}^2/\text{s}} = 2.67 \times 10^5 V$$

and the forced motion velocity above which natural convection heat transfer from this plate is negligible is

$$\frac{Gr}{Re^2} = 0.1 \longrightarrow \frac{5.823 \times 10^{11}}{(2.67 \times 10^5 V)^2} = 0.1 \longrightarrow V = \mathbf{9.04 \text{ m/s}}$$

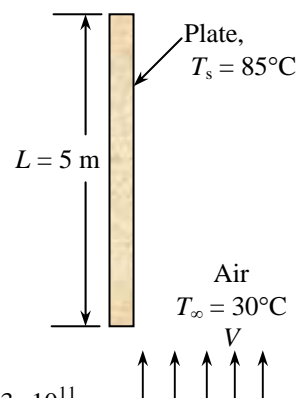

9-81 EES Prob. 9-80 is reconsidered. The forced motion velocity above which natural convection heat transfer is negligible as a function of the plate temperature is to be plotted.

Analysis The problem is solved using EES, and the solution is given below.

"GIVEN"

L=5 [m]

T_s=85 [C]

T_infinity=30 [C]

"PROPERTIES"

Fluid\$='air'

rho=Density(Fluid\$, T=T_film, P=101.3)

mu=Viscosity(Fluid\$, T=T_film)

nu=mu/rho

beta=1/(T_film+273)

T_film=1/2*(T_s+T_infinity)

g=9.807 [m/s^2]

"ANALYSIS"

Gr=(g*beta*(T_s-T_infinity)*L^3)/nu^2

Re=(Vel*L)/nu

Gr/Re^2=0.1

T _s [C]	Vel [m/s]
50	5.598
55	6.233
60	6.801
65	7.318
70	7.793
75	8.233
80	8.646
85	9.033
90	9.4
95	9.747
100	10.08
105	10.39
110	10.69
115	10.98
120	11.26
125	11.53
130	11.79
135	12.03
140	12.27
145	12.51
150	12.73

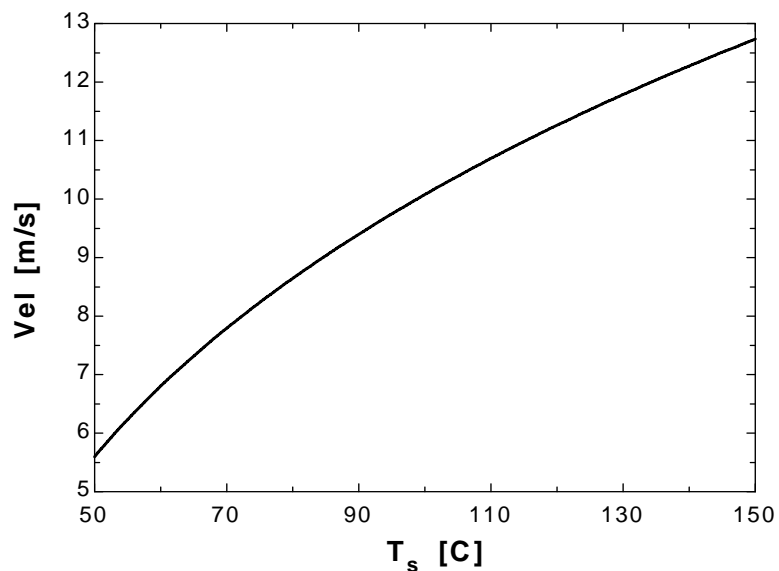

9-82 A vertical plate in water is considered. The forced motion velocity above which natural convection heat transfer from the plate is negligible is to be determined.

Assumptions 1 Steady operating conditions exist.

Properties The properties of water at the film temperature of $(T_s + T_\infty)/2 = (60 + 25)/2 = 42.5^\circ\text{C}$ are (Table A-9)

$$\nu = \mu / \rho = 0.630 \times 10^{-6} \text{ m}^2/\text{s}$$

$$\beta = 0.396 \times 10^{-3} \text{ K}^{-1}$$

Analysis The characteristic length is the height of the plate $L_c = L = 5 \text{ m}$. The Grashof and Reynolds numbers are

$$Gr = \frac{g\beta(T_s - T_\infty)L^3}{\nu^2} = \frac{(9.81 \text{ m/s}^2)(0.396 \times 10^{-3} \text{ K}^{-1})(60 - 25 \text{ K})(5 \text{ m})^3}{(0.630 \times 10^{-6} \text{ m}^2/\text{s})^2} = 4.28 \times 10^{13}$$

$$Re = \frac{V_\infty L}{\nu} = \frac{V(5 \text{ m})}{0.630 \times 10^{-6} \text{ m}^2/\text{s}} = 7.94 \times 10^6 V$$

and the forced motion velocity above which natural convection heat transfer from this plate is negligible is

$$\frac{Gr}{Re^2} = 0.1 \longrightarrow \frac{4.28 \times 10^{13}}{(7.94 \times 10^6 V)^2} = 0.1 \longrightarrow V = \mathbf{2.61 \text{ m/s}}$$

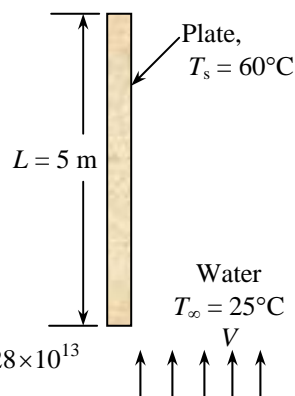

9-83 Thin square plates coming out of the oven in a production facility are cooled by blowing ambient air horizontally parallel to their surfaces. The air velocity above which the natural convection effects on heat transfer are negligible is to be determined.

Assumptions 1 Steady operating conditions exist. **2** Air is an ideal gas with constant properties. **3** The atmospheric pressure at that location is 1 atm.

Properties The properties of air at 1 atm and 1 atm and the film temperature of $(T_s + T_\infty)/2 = (270 + 18)/2 = 144^\circ\text{C}$ are (Table A-15)

$$\nu = 2.791 \times 10^{-5} \text{ m}^2/\text{s}$$

$$\beta = \frac{1}{T_f} = \frac{1}{(144 + 273)\text{K}} = 0.002398 \text{ K}^{-1}$$

Analysis The characteristic length is the height of the plate $L_c = L = 2 \text{ m}$. The Grashof and Reynolds numbers are

$$Gr = \frac{g\beta(T_s - T_\infty)L^3}{\nu^2} = \frac{(9.81 \text{ m/s}^2)(0.002398 \text{ K}^{-1})(270 - 18 \text{ K})(2 \text{ m})^3}{(2.791 \times 10^{-5} \text{ m}^2/\text{s})^2} = 6.09 \times 10^{10}$$

$$Re = \frac{VL}{\nu} = \frac{V(2 \text{ m})}{2.791 \times 10^{-5} \text{ m}^2/\text{s}} = 7.166 \times 10^4 V$$

and the forced motion velocity above which natural convection heat transfer from this plate is negligible is

$$\frac{Gr}{Re^2} = 0.1 \longrightarrow \frac{6.09 \times 10^{10}}{(7.166 \times 10^4 V)^2} = 0.1 \longrightarrow V = \mathbf{10.9 \text{ m/s}}$$

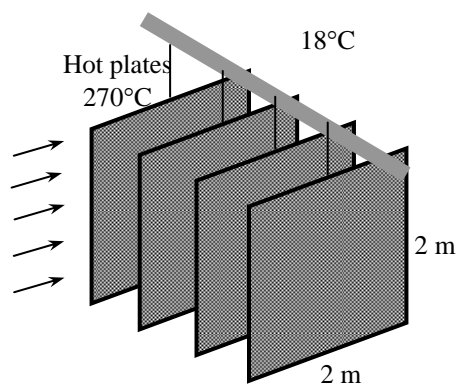

9-84 A circuit board is cooled by a fan that blows air upwards. The average temperature on the surface of the circuit board is to be determined for two cases.

Assumptions 1 Steady operating conditions exist. 2 Air is an ideal gas with constant properties. 3 The atmospheric pressure at that location is 1 atm.

Properties The properties of air at 1 atm and 1 atm and the anticipated film temperature of $(T_s + T_\infty)/2 = (60 + 35)/2 = 47.5^\circ\text{C}$ are (Table A-15)

$$k = 0.02717 \text{ W/m}\cdot^\circ\text{C}$$

$$\nu = 1.774 \times 10^{-5} \text{ m}^2/\text{s}$$

$$\text{Pr} = 0.7235$$

$$\beta = \frac{1}{T_f} = \frac{1}{(47.5 + 273)\text{K}} = 0.00312 \text{ K}^{-1}$$

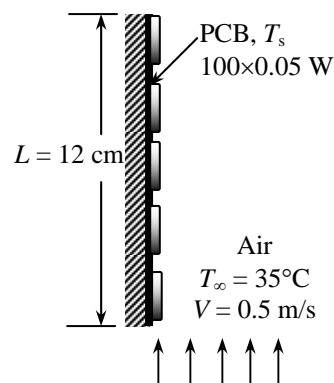

Analysis We assume the surface temperature to be 60°C . We will check this assumption later on and repeat calculations with a better assumption, if necessary. The characteristic length in this case is the length of the board in the flow (vertical) direction, $L_c = L = 0.12 \text{ m}$. Then the Reynolds number becomes

$$\text{Re} = \frac{VL}{\nu} = \frac{(0.5 \text{ m/s})(0.12 \text{ m})}{1.774 \times 10^{-5} \text{ m}^2/\text{s}} = 3383$$

which is less than critical Reynolds number (5×10^5). Therefore the flow is laminar and the forced convection Nusselt number and h are determined from

$$\text{Nu} = \frac{hL}{k} = 0.664 \text{Re}^{0.5} \text{Pr}^{1/3} = 0.664(3383)^{0.5} (0.7235)^{1/3} = 34.67$$

$$h = \frac{k}{L} \text{Nu} = \frac{0.02717 \text{ W/m}\cdot^\circ\text{C}}{0.12 \text{ m}} (34.67) = 7.85 \text{ W/m}^2\cdot^\circ\text{C}$$

$$A_s = L \times W = (0.12 \text{ m})(0.2 \text{ m}) = 0.024 \text{ m}^2$$

$$\text{Then, } \dot{Q} = hA_s(T_s - T_\infty) \longrightarrow T_s = T_\infty + \frac{\dot{Q}}{hA_s} = 35^\circ\text{C} + \frac{(100)(0.05 \text{ W})}{(7.85 \text{ W/m}^2\cdot^\circ\text{C})(0.024 \text{ m}^2)} = \mathbf{61.5^\circ\text{C}}$$

which is sufficiently close to the assumed value in the evaluation of properties. Therefore, there is no need to repeat calculations.

(b) The Rayleigh number is

$$\text{Ra} = \frac{g\beta(T_s - T_\infty)L^3}{\nu^2} \text{Pr} = \frac{(9.81 \text{ m/s}^2)(0.00312 \text{ K}^{-1})(60 - 35 \text{ K})(0.12 \text{ m})^3}{(1.774 \times 10^{-5} \text{ m}^2/\text{s})^2} (0.7235) = 3.041 \times 10^6$$

$$\text{Nu} = \left\{ 0.825 + \frac{0.387\text{Ra}^{1/6}}{\left[1 + \left(\frac{0.492}{\text{Pr}} \right)^{9/16} \right]^{8/27}} \right\}^2 = \left\{ 0.825 + \frac{0.387(3.041 \times 10^6)^{1/6}}{\left[1 + \left(\frac{0.492}{0.7235} \right)^{9/16} \right]^{8/27}} \right\}^2 = 22.42$$

This is an assisting flow and the combined Nusselt number is determined from

$$\text{Nu}_{\text{combined}} = (\text{Nu}_{\text{forced}}^n + \text{Nu}_{\text{natural}}^n)^{1/n} = (34.67^3 + 22.42^3)^{1/3} = 37.55$$

$$\text{Then, } h = \frac{k}{L} \text{Nu}_{\text{combined}} = \frac{0.02717 \text{ W/m}\cdot^\circ\text{C}}{0.12 \text{ m}} (37.55) = 8.502 \text{ W/m}^2\cdot^\circ\text{C}$$

$$\text{and } \dot{Q} = hA_s(T_s - T_\infty) \longrightarrow T_s = T_\infty + \frac{\dot{Q}}{hA_s} = 35^\circ\text{C} + \frac{(100)(0.05 \text{ W})}{(8.502 \text{ W/m}^2\cdot^\circ\text{C})(0.024 \text{ m}^2)} = \mathbf{59.5^\circ\text{C}}$$

Therefore, natural convection lowers the surface temperature in this case by about 2°C .

Special Topic: Heat Transfer through Windows

9-85C Windows are considered in three regions when analyzing heat transfer through them because the structure and properties of the frame are quite different than those of the glazing. As a result, heat transfer through the frame and the edge section of the glazing adjacent to the frame is two-dimensional. Even in the absence of solar radiation and air infiltration, heat transfer through the windows is more complicated than it appears to be. Therefore, it is customary to consider the windows in three regions when analyzing heat transfer through them: (1) the *center-of-glass*, (2) the *edge-of-glass*, and (3) the *frame* regions. When the heat transfer coefficient for all three regions are known, the overall U-value of the window is determined from

$$U_{\text{window}} = (U_{\text{center}}A_{\text{center}} + U_{\text{edge}}A_{\text{edge}} + U_{\text{frame}}A_{\text{frame}}) / A_{\text{window}}$$

where A_{window} is the window area, and A_{center} , A_{edge} , and A_{frame} are the areas of the center, edge, and frame sections of the window, respectively, and U_{center} , U_{edge} , and U_{frame} are the heat transfer coefficients for the center, edge, and frame sections of the window.

9-86C Of the three similar double pane windows with air gap widths of 5, 10, and 20 mm, the U-factor and thus the rate of heat transfer through the window will be a minimum for the window with 10-mm air gap, as can be seen from Fig. 9-37.

9-87C In an ordinary double pane window, about half of the heat transfer is by radiation. A practical way of reducing the radiation component of heat transfer is to reduce the emissivity of glass surfaces by coating them with low-emissivity (or “low-e”) material.

9-88C When a thin polyester film is used to divide the 20-mm wide air of a double pane window space into two 10-mm wide layers, both (a) convection and (b) radiation heat transfer through the window will be reduced.

9-89C When a double pane window whose air space is flashed and filled with argon gas, (a) convection heat transfer will be reduced but (b) radiation heat transfer through the window will remain the same.

9-90C The heat transfer rate through the glazing of a double pane window is higher at the edge section than it is at the center section because of the two-dimensional effects due to heat transfer through the frame.

9-91C The U-factors of windows with aluminum frames will be highest because of the higher conductivity of aluminum. The U-factors of wood and vinyl frames are comparable in magnitude.

9-92 The U-factor for the center-of-glass section of a double pane window is to be determined.

Assumptions **1** Steady operating conditions exist. **2** Heat transfer through the window is one-dimensional. **3** The thermal resistance of glass sheets is negligible.

Properties The emissivity of clear glass is given to be 0.84. The values of h_i and h_o for winter design conditions are $h_i = 8.29 \text{ W/m}^2 \cdot ^\circ\text{C}$ and $h_o = 34.0 \text{ W/m}^2 \cdot ^\circ\text{C}$ (from the text).

Analysis Disregarding the thermal resistance of glass sheets, which are small, the U-factor for the center region of a double pane window is determined from

$$\frac{1}{U_{\text{center}}} \cong \frac{1}{h_i} + \frac{1}{h_{\text{space}}} + \frac{1}{h_o}$$

where h_i , h_{space} , and h_o are the heat transfer coefficients at the inner surface of window, the air space between the glass layers, and the outer surface of the window, respectively. The effective emissivity of the air space of the double pane window is

$$\varepsilon_{\text{effective}} = \frac{1}{1/\varepsilon_1 + 1/\varepsilon_2 - 1} = \frac{1}{1/0.84 + 1/0.84 - 1} = 0.72$$

For this value of emissivity and an average air space temperature of 10°C with a temperature difference across the air space to be 15°C , we read $h_{\text{space}} = 5.7 \text{ W/m}^2 \cdot ^\circ\text{C}$ from Table 9-3 for 13-mm thick air space. Therefore,

$$\frac{1}{U_{\text{center}}} = \frac{1}{8.29} + \frac{1}{5.7} + \frac{1}{34.0} \longrightarrow U_{\text{center}} = \mathbf{3.07 \text{ W/m}^2 \cdot ^\circ\text{C}}$$

Discussion The overall U-factor of the window will be higher because of the edge effects of the frame.

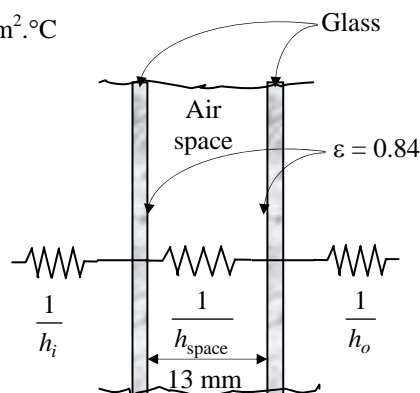

9-93 The rate of heat loss through a double-door wood framed window and the inner surface temperature are to be determined for the cases of single pane, double pane, and low-e triple pane windows.

Assumptions **1** Steady operating conditions exist. **2** Heat transfer through the window is one-dimensional. **3** Thermal properties of the windows and the heat transfer coefficients are constant. **4** Infiltration heat losses are not considered.

Properties The U-factors of the windows are given in Table 9-6.

Analysis The rate of heat transfer through the window can be determined from

$$\dot{Q}_{\text{window}} = U_{\text{overall}} A_{\text{window}} (T_i - T_o)$$

where T_i and T_o are the indoor and outdoor air temperatures, respectively, U_{overall} is the U-factor (the overall heat transfer coefficient) of the window, and A_{window} is the window area which is determined to be

$$A_{\text{window}} = \text{Height} \times \text{Width} = (1.2 \text{ m})(1.8 \text{ m}) = 2.16 \text{ m}^2$$

The U-factors for the three cases can be determined directly from Table 9-6 to be 5.57, 2.86, and 1.46 W/m²·°C, respectively. Also, the inner surface temperature of the window glass can be determined from Newton's law,

$$\dot{Q}_{\text{window}} = h_i A_{\text{window}} (T_i - T_{\text{glass}}) \longrightarrow T_{\text{glass}} = T_i - \frac{\dot{Q}_{\text{window}}}{h_i A_{\text{window}}}$$

where h_i is the heat transfer coefficient on the inner surface of the window which is determined from Table 9-5 to be $h_i = 8.3 \text{ W/m}^2 \cdot \text{°C}$. Then the rate of heat loss and the interior glass temperature for each case are determined as follows:

(a) Single glazing:

$$\dot{Q}_{\text{window}} = (5.57 \text{ W/m}^2 \cdot \text{°C})(2.16 \text{ m}^2)[20 - (-8) \text{°C}] = \mathbf{337 \text{ W}}$$

$$T_{\text{glass}} = T_i - \frac{\dot{Q}_{\text{window}}}{h_i A_{\text{window}}} = 20 \text{°C} - \frac{337 \text{ W}}{(8.29 \text{ W/m}^2 \cdot \text{°C})(2.16 \text{ m}^2)} = \mathbf{1.2 \text{°C}}$$

(b) Double glazing (13 mm air space):

$$\dot{Q}_{\text{window}} = (2.86 \text{ W/m}^2 \cdot \text{°C})(2.16 \text{ m}^2)[20 - (-8) \text{°C}] = \mathbf{173 \text{ W}}$$

$$T_{\text{glass}} = T_i - \frac{\dot{Q}_{\text{window}}}{h_i A_{\text{window}}} = 20 \text{°C} - \frac{173 \text{ W}}{(8.29 \text{ W/m}^2 \cdot \text{°C})(2.16 \text{ m}^2)} = \mathbf{10.3 \text{°C}}$$

(c) Triple glazing (13 mm air space, low-e coated):

$$\dot{Q}_{\text{window}} = (1.46 \text{ W/m}^2 \cdot \text{°C})(2.16 \text{ m}^2)[20 - (-8) \text{°C}] = \mathbf{88.3 \text{ W}}$$

$$T_{\text{glass}} = T_i - \frac{\dot{Q}_{\text{window}}}{h_i A_{\text{window}}} = 20 - \frac{88.3 \text{ W}}{(8.3 \text{ W/m}^2 \cdot \text{°C})(2.16 \text{ m}^2)} = \mathbf{15.1 \text{°C}}$$

Discussion Note that heat loss through the window will be reduced by 49 percent in the case of double glazing and by 74 percent in the case of triple glazing relative to the single glazing case. Also, in the case of single glazing, the low inner glass surface temperature will cause considerable discomfort in the occupants because of the excessive heat loss from the body by radiation. It is raised from 1.2°C to 10.3°C in the case of double glazing and to 15.1°C in the case of triple glazing.

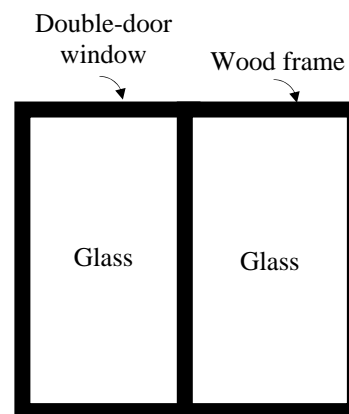

9-94 The overall U-factor for a double-door type window is to be determined, and the result is to be compared to the value listed in Table 9-6.

Assumptions 1 Steady operating conditions exist. 2 Heat transfer through the window is one-dimensional.

Properties The U-factors for the various sections of windows are given in Table 9-6.

Analysis The areas of the window, the glazing, and the frame are

$$A_{\text{window}} = \text{Height} \times \text{Width} = (2 \text{ m})(2.4 \text{ m}) = 4.80 \text{ m}^2$$

$$A_{\text{glazing}} = 2 \times \text{Height} \times \text{Width} = 2(1.92 \text{ m})(1.14 \text{ m}) = 4.38 \text{ m}^2$$

$$A_{\text{frame}} = A_{\text{window}} - A_{\text{glazing}} = 4.80 - 4.38 = 0.42 \text{ m}^2$$

The edge-of-glass region consists of a 6.5-cm wide band around the perimeter of the glazings, and the areas of the center and edge sections of the glazing are determined to be

$$A_{\text{center}} = 2(\text{Height} \times \text{Width}) = 2(1.92 - 0.13 \text{ m})(1.14 - 0.13 \text{ m}) = 3.62 \text{ m}^2$$

$$A_{\text{edge}} = A_{\text{glazing}} - A_{\text{center}} = 4.38 - 3.62 = 0.76 \text{ m}^2$$

The U-factor for the frame section is determined from Table 9-4 to be $U_{\text{frame}} = 2.8 \text{ W/m}^2 \cdot ^\circ\text{C}$. The U-factor for the center and edge sections are determined from Table 9-6 to be $U_{\text{center}} = 2.78 \text{ W/m}^2 \cdot ^\circ\text{C}$ and $U_{\text{edge}} = 3.40 \text{ W/m}^2 \cdot ^\circ\text{C}$. Then the overall U-factor of the entire window becomes

$$\begin{aligned} U_{\text{window}} &= (U_{\text{center}}A_{\text{center}} + U_{\text{edge}}A_{\text{edge}} + U_{\text{frame}}A_{\text{frame}}) / A_{\text{window}} \\ &= (2.78 \times 3.62 + 3.40 \times 0.76 + 2.8 \times 0.42) / 4.80 \\ &= \mathbf{2.88 \text{ W/m}^2 \cdot ^\circ\text{C}} \end{aligned}$$

Discussion The overall U-factor listed in Table 9-6 for the specified type of window is $2.86 \text{ W/m}^2 \cdot ^\circ\text{C}$, which is sufficiently close to the value obtained above.

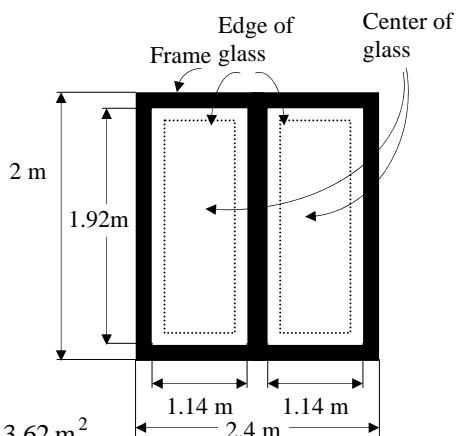

9-95 The windows of a house in Atlanta are of double door type with wood frames and metal spacers. The average rate of heat loss through the windows in winter is to be determined.

Assumptions 1 Steady operating conditions exist. 2 Heat transfer through the window is one-dimensional. 3 Thermal properties of the windows and the heat transfer coefficients are constant. 4 Infiltration heat losses are not considered.

Properties The U-factor of the window is given in Table 9-6 to be $2.13 \text{ W/m}^2 \cdot ^\circ\text{C}$.

Analysis The rate of heat transfer through the window can be determined from

$$\dot{Q}_{\text{window, avg}} = U_{\text{overall}} A_{\text{window}} (T_i - T_{o, \text{avg}})$$

where T_i and T_o are the indoor and outdoor air temperatures, respectively, U_{overall} is the U-factor (the overall heat transfer coefficient) of the window, and A_{window} is the window area. Substituting,

$$\dot{Q}_{\text{window, avg}} = (2.13 \text{ W/m}^2 \cdot ^\circ\text{C})(14 \text{ m}^2)(22 - 11.3)^\circ\text{C} = \mathbf{319 \text{ W}}$$

Discussion This is the “average” rate of heat transfer through the window in winter in the absence of any infiltration.

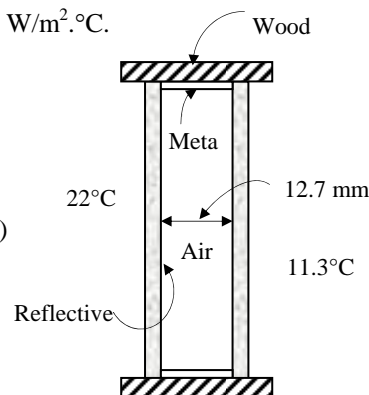

9-96E The R -value of the common double door windows that are double pane with 1/4-in of air space and have aluminum frames is to be compared to the R -value of R -13 wall. It is also to be determined if more heat is transferred through the windows or the walls.

Assumptions **1** Steady operating conditions exist. **2** Heat transfer through the window is one-dimensional. **3** Thermal properties of the windows and the heat transfer coefficients are constant. **4** Infiltration heat losses are not considered.

Properties The U -factor of the window is given in Table 9-6 to be $4.55 \times 0.176 = 0.801 \text{ Btu/h}\cdot\text{ft}^2\cdot^\circ\text{F}$.

Analysis The R -value of the windows is simply the inverse of its U -factor, and is determined to be

$$R_{\text{window}} = \frac{1}{U} = \frac{1}{0.801 \text{ Btu/h}\cdot\text{ft}^2\cdot^\circ\text{F}} = 1.25 \text{ h}\cdot\text{ft}^2\cdot^\circ\text{F/Btu}$$

which is less than 13. Therefore, the R -value of a double pane window is **much less** than the R -value of an R -13 wall.

Now consider a 1-ft^2 section of a wall. The solid wall and the window areas of this section are $A_{\text{wall}} = 0.8 \text{ ft}^2$ and $A_{\text{window}} = 0.2 \text{ ft}^2$. Then the rates of heat transfer through the two sections are determined to be

$$\dot{Q}_{\text{wall}} = U_{\text{wall}} A_{\text{wall}} (T_i - T_o) = A_{\text{wall}} \frac{T_i - T_o}{R\text{-value, wall}} = (0.8 \text{ ft}^2) \frac{\Delta T (^\circ\text{F})}{(13 \text{ h}\cdot\text{ft}^2\cdot^\circ\text{F/Btu})} = 0.0615 \Delta T \text{ Btu/h}$$

$$\dot{Q}_{\text{window}} = U_{\text{window}} A_{\text{window}} (T_i - T_o) = A_{\text{window}} \frac{T_i - T_o}{R\text{-value}} = (0.2 \text{ ft}^2) \frac{\Delta T (^\circ\text{F})}{(1.25 \text{ h}\cdot\text{ft}^2\cdot^\circ\text{F/Btu})} = 0.160 \Delta T \text{ Btu/h}$$

Therefore, the rate of heat transfer through a double pane window is **much more** than the rate of heat transfer through an R -13 wall.

Discussion The ratio of heat transfer through the wall and through the window is

$$\frac{\dot{Q}_{\text{window}}}{\dot{Q}_{\text{wall}}} = \frac{0.160 \text{ Btu/h}}{0.0615 \text{ Btu/h}} = 2.60$$

Therefore, 2.6 times more heat is lost through the windows than through the walls although the windows occupy only 20% of the wall area.

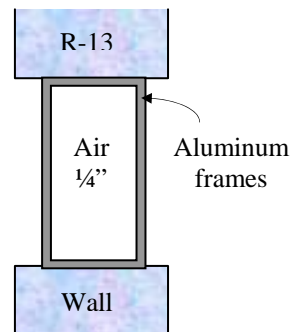

9-97 The overall U-factor of a window is given to be $U = 2.76 \text{ W/m}^2 \cdot ^\circ\text{C}$ for 12 km/h winds outside. The new U-factor when the wind velocity outside is doubled is to be determined.

Assumptions Thermal properties of the windows and the heat transfer coefficients are constant.

Properties The heat transfer coefficients at the outer surface of the window are $h_o = 22.7 \text{ W/m}^2 \cdot ^\circ\text{C}$ for 12 km/h winds, and $h_o = 34.0 \text{ W/m}^2 \cdot ^\circ\text{C}$ for 24 km/h winds (from the text).

Analysis The corresponding convection resistances for the outer surfaces of the window are

$$R_{o,12 \text{ km/h}} = \frac{1}{h_{o,12 \text{ km/h}}} = \frac{1}{22.7 \text{ W/m}^2 \cdot ^\circ\text{C}} = 0.044 \text{ m}^2 \cdot ^\circ\text{C/W}$$

$$R_{o,24 \text{ km/h}} = \frac{1}{h_{o,24 \text{ km/h}}} = \frac{1}{34.0 \text{ W/m}^2 \cdot ^\circ\text{C}} = 0.029 \text{ m}^2 \cdot ^\circ\text{C/W}$$

Also, the R-value of the window at 12 km/h winds is

$$R_{\text{window},12 \text{ km/h}} = \frac{1}{U_{\text{window},12 \text{ km/h}}} = \frac{1}{2.76 \text{ W/m}^2 \cdot ^\circ\text{C}} = 0.362 \text{ m}^2 \cdot ^\circ\text{C/W}$$

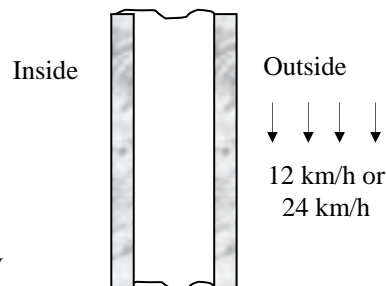

Noting that all thermal resistances are in series, the thermal resistance of the window for 24 km/h winds is determined by replacing the convection resistance for 12 km/h winds by the one for 24 km/h:

$$R_{\text{window},24 \text{ km/h}} = R_{\text{window},12 \text{ km/h}} - R_{o,12 \text{ km/h}} + R_{o,24 \text{ km/h}} = 0.362 - 0.044 + 0.029 = 0.347 \text{ m}^2 \cdot ^\circ\text{C/W}$$

Then the U-factor for the case of 24 km/h winds becomes

$$U_{\text{window},24 \text{ km/h}} = \frac{1}{R_{\text{window},24 \text{ km/h}}} = \frac{1}{0.347 \text{ m}^2 \cdot ^\circ\text{C/W}} = \mathbf{2.88 \text{ W/m}^2 \cdot ^\circ\text{C}}$$

Discussion Note that doubling of the wind velocity increases the U-factor only slightly (about 4%) from 2.76 to 2.88 $\text{W/m}^2 \cdot ^\circ\text{C}$.

9-98 The existing wood framed single pane windows of an older house in Wichita are to be replaced by double-door type vinyl framed double pane windows with an air space of 6.4 mm. The amount of money the new windows will save the home owner per month is to be determined.

Assumptions **1** Steady operating conditions exist. **2** Heat transfer through the window is one-dimensional. **3** Thermal properties of the windows and the heat transfer coefficients are constant. **4** Infiltration heat losses are not considered.

Properties The U-factors of the windows are $5.57 \text{ W/m}^2 \cdot ^\circ\text{C}$ for the old single pane windows, and $3.20 \text{ W/m}^2 \cdot ^\circ\text{C}$ for the new double pane windows (Table 9-6).

Analysis The rate of heat transfer through the window can be determined from

$$\dot{Q}_{\text{window}} = U_{\text{overall}} A_{\text{window}} (T_i - T_o)$$

where T_i and T_o are the indoor and outdoor air temperatures, respectively, U_{overall} is the U-factor (the overall heat transfer coefficient) of the window, and A_{window} is the window area. Noting that the heaters will turn on only when the outdoor temperature drops below 18°C , the rates of heat transfer due to electric heating for the old and new windows are determined to be

$$\dot{Q}_{\text{window, old}} = (5.57 \text{ W/m}^2 \cdot ^\circ\text{C})(17 \text{ m}^2)(18 - 7.1)^\circ\text{C} = 1032 \text{ W}$$

$$\dot{Q}_{\text{window, new}} = (3.20 \text{ W/m}^2 \cdot ^\circ\text{C})(17 \text{ m}^2)(18 - 7.1)^\circ\text{C} = 593 \text{ W}$$

$$\dot{Q}_{\text{saved}} = \dot{Q}_{\text{window, old}} - \dot{Q}_{\text{window, new}} = 1032 - 593 = 439 \text{ W}$$

Then the electrical energy and cost savings per month becomes

$$\text{Energy savings} = \dot{Q}_{\text{saved}} \Delta t = (0.439 \text{ kW})(30 \times 24 \text{ h/month}) = 316 \text{ kWh/month}$$

$$\text{Cost savings} = (\text{Energy savings})(\text{Unit cost of energy}) = (316 \text{ kWh/month})(\$0.085/\text{kWh}) = \mathbf{\$26.9/\text{month}}$$

Discussion We would obtain the same result if we used the actual indoor temperature (probably 22°C) for T_i instead of the balance point temperature of 18°C .

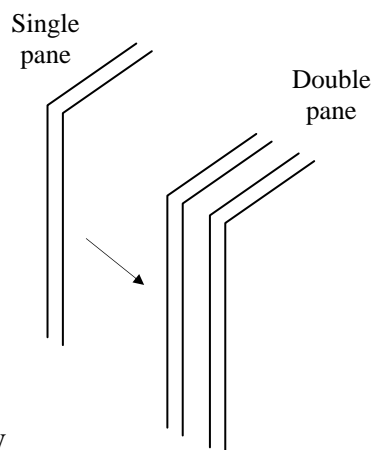

Review Problems

9-99 A cold cylinder is placed horizontally in hot air. The rates of heat transfer from the stack with and without wind cases are to be determined.

Assumptions 1 Steady operating conditions exist. 2 Air is an ideal gas with constant properties. 3 The local atmospheric pressure is 1 atm.

Properties The properties of air at 1 atm and the film temperature of $(T_s + T_\infty)/2 = (40 + 10)/2 = 25^\circ\text{C}$ are (Table A-15)

$$k = 0.02551 \text{ W/m}\cdot^\circ\text{C}$$

$$\nu = 1.562 \times 10^{-5} \text{ m}^2/\text{s}$$

$$\text{Pr} = 0.7296$$

$$\beta = \frac{1}{T_f} = \frac{1}{(25 + 273)\text{K}} = 0.003356 \text{ K}^{-1}$$

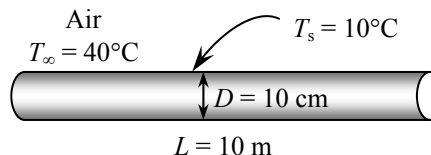

Analysis (a) When the stack is exposed to 10 m/s winds, the heat transfer will be by forced convection. We have flow of air over a cylinder and the heat transfer rate is determined as follows:

$$\text{Re} = \frac{VD}{\nu} = \frac{(10 \text{ m/s})(0.1 \text{ m})}{1.562 \times 10^{-5} \text{ m}^2/\text{s}} = 64,020$$

$$\text{Nu} = 0.027 \text{Re}^{0.805} \text{Pr}^{1/3} = 0.027(64,020)^{0.805} (0.7296)^{1/3} = 179.8 \quad (\text{from Table 7-1})$$

$$h = \frac{k}{D} \text{Nu} = \frac{0.02551 \text{ W/m}\cdot^\circ\text{C}}{0.1 \text{ m}} (179.8) = 45.87 \text{ W/m}^2\cdot^\circ\text{C}$$

$$\dot{Q}_{\text{forced conv}} = hA(T_\infty - T_s) = (45.87 \text{ W/m}^2\cdot^\circ\text{C})(\pi \times 0.1 \times 10 \text{ m}^2)(40 - 10)^\circ\text{C} = \mathbf{4323 \text{ W}}$$

(b) Without wind the heat transfer will be by natural convection. The characteristic length in this case is the outer diameter of the cylinder, $L_c = D = 0.1 \text{ m}$. Then,

$$\text{Ra} = \frac{g\beta(T_\infty - T_s)D^3}{\nu^2} \text{Pr} = \frac{(9.81 \text{ m/s}^2)(0.003356 \text{ K}^{-1})(40 - 10 \text{ K})(0.1 \text{ m})^3}{(1.562 \times 10^{-5} \text{ m}^2/\text{s})^2} (0.7296) = 2.953 \times 10^6$$

$$\text{Nu} = \left\{ 0.6 + \frac{0.387 \text{Ra}^{1/6}}{\left[1 + (0.559 / \text{Pr})^{9/16} \right]^{8/27}} \right\}^2 = \left\{ 0.6 + \frac{0.387(2.953 \times 10^6)^{1/6}}{\left[1 + (0.559 / 0.7296)^{9/16} \right]^{8/27}} \right\}^2 = 19.86$$

$$h = \frac{k}{D} \text{Nu} = \frac{0.02551 \text{ W/m}\cdot^\circ\text{C}}{0.1 \text{ m}} (19.86) = 5.066 \text{ W/m}^2\cdot^\circ\text{C}$$

$$\dot{Q}_{\text{nat. conv}} = hA(T_\infty - T_s) = (5.066 \text{ W/m}^2\cdot^\circ\text{C})(\pi \times 0.1 \times 10 \text{ m}^2)(40 - 10)^\circ\text{C} = \mathbf{477 \text{ W}}$$

9-100 A spherical vessel is completely submerged in a large water-filled tank. The rates of heat transfer from the vessel by natural convection, conduction, and forced convection are to be determined.

Assumptions 1 Steady operating conditions exist. 2 The surface temperature is constant.

Properties The properties of water at the film temperature of $(T_s + T_\infty)/2 = (30 + 20)/2 = 25^\circ\text{C}$ are (Table A-9)

$$\begin{aligned}\rho &= 997 \text{ kg/m}^3 \\ k &= 0.607 \text{ W/m}\cdot^\circ\text{C} \\ \mu &= 0.891 \times 10^{-3} \text{ kg/m}\cdot\text{s} \\ \nu &= \mu / \rho = 8.937 \times 10^{-7} \text{ m}^2/\text{s} \\ \text{Pr} &= 6.14 \\ \beta &= 0.247 \times 10^{-3} \text{ K}^{-1}\end{aligned}$$

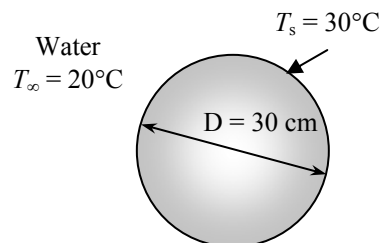

Analysis (a) Heat transfer in this case will be by natural convection.

The characteristic length in this case is $L_c = D = 0.3 \text{ m}$. Then,

$$\begin{aligned}Ra &= \frac{g\beta(T_s - T_\infty)D^3}{\nu^2} \text{Pr} = \frac{(9.81 \text{ m/s}^2)(0.247 \times 10^{-3} \text{ K}^{-1})(30 - 20 \text{ K})(0.3 \text{ m})^3}{(8.937 \times 10^{-7} \text{ m}^2/\text{s})^2} (6.14) = 5.029 \times 10^9 \\ Nu &= 2 + \frac{0.589Ra^{1/4}}{\left[1 + (0.469/\text{Pr})^{9/16}\right]^{4/9}} = 2 + \frac{0.589(5.029 \times 10^9)^{1/4}}{\left[1 + (0.469/6.14)^{9/16}\right]^{4/9}} = 144.8\end{aligned}$$

Then

$$\begin{aligned}h &= \frac{k}{D} Nu = \frac{0.607 \text{ W/m}\cdot^\circ\text{C}}{0.3 \text{ m}} (144.8) = 293.0 \text{ W/m}^2 \cdot ^\circ\text{C} \\ A_s &= \pi D^2 = \pi(0.3 \text{ m})^2 = 0.2827 \text{ m}^2\end{aligned}$$

The rate of heat transfer is

$$\dot{Q}_{\text{nat.conv}} = hA(T_s - T_\infty) = (293.0 \text{ W/m}^2 \cdot ^\circ\text{C})(0.2827 \text{ m}^2)(30 - 20)^\circ\text{C} = \mathbf{828 \text{ W}}$$

(b) When buoyancy force is neglected, there will be no convection currents (since $\beta = 0$) and the heat transfer will be by conduction. Then Rayleigh number becomes zero ($Ra = 0$). The Nusselt number in this case is

$$\text{Nu} = 2$$

Then

$$h = \frac{k}{D} Nu = \frac{0.607 \text{ W/m}\cdot^\circ\text{C}}{0.3 \text{ m}} (2) = 4.047 \text{ W/m}^2 \cdot ^\circ\text{C}$$

$$\dot{Q}_{\text{cond}} = hA(T_s - T_\infty) = (4.047 \text{ W/m}^2 \cdot ^\circ\text{C})(0.2827 \text{ m}^2)(30 - 20)^\circ\text{C} = \mathbf{11.4 \text{ W}}$$

(c) In this case, the heat transfer from the vessel is by forced convection. The properties of water at the free stream temperature of 20°C are (Table A-9)

$$\begin{aligned}\rho &= 998 \text{ kg/m}^3 \\ k &= 0.598 \text{ W/m}\cdot^\circ\text{C} \\ \mu_\infty &= 1.002 \times 10^{-3} \text{ kg/m}\cdot\text{s} \\ \nu &= \mu_\infty / \rho = 1.004 \times 10^{-6} \text{ m}^2/\text{s} \\ \mu_{s,@30^\circ\text{C}} &= 0.798 \times 10^{-3} \text{ kg/m}\cdot\text{s} \\ \text{Pr} &= 7.01\end{aligned}$$

The Reynolds number is

$$\text{Re} = \frac{VD}{\nu} = \frac{(0.2 \text{ m/s})(0.3 \text{ m})}{1.004 \times 10^{-6} \text{ m}^2/\text{s}} = 59,760$$

The Nusselt number is

$$\begin{aligned} Nu = \frac{hD}{k} &= 2 + \left[0.4 \text{Re}^{0.5} + 0.06 \text{Re}^{2/3} \right] \text{Pr}^{0.4} \left(\frac{\mu_{\infty}}{\mu_s} \right)^{1/4} \\ &= 2 + \left[0.4(59,760)^{0.5} + 0.06(59,760)^{2/3} \right] (7.01)^{0.4} \left(\frac{1.002 \times 10^{-3}}{0.798 \times 10^{-3}} \right)^{1/4} = 439.1 \end{aligned}$$

The heat transfer coefficient is

$$h = \frac{k}{D} Nu = \frac{0.598 \text{ W/m} \cdot ^\circ\text{C}}{0.3 \text{ m}} (439.1) = 875.3 \text{ W/m}^2 \cdot ^\circ\text{C}$$

The rate of heat transfer is

$$\dot{Q}_{\text{forced conv}} = hA(T_s - T_{\infty}) = (875.3 \text{ W/m}^2 \cdot ^\circ\text{C})(0.2827 \text{ m}^2)(30 - 20)^\circ\text{C} = \mathbf{2474 \text{ W}}$$

9-101 A vertical cylindrical vessel loses heat to the surrounding air. The rates of heat transfer from the vessel with and without wind cases are to be determined.

Assumptions 1 Steady operating conditions exist. 2 Air is an ideal gas with constant properties. 3 The local atmospheric pressure is 1 atm.

Properties The properties of air at 1 atm and the film temperature of $(T_s + T_\infty)/2 = (60 + 0)/2 = 30^\circ\text{C}$ are (Table A-15)

$$k = 0.02588 \text{ W/m}\cdot^\circ\text{C}$$

$$\nu = 1.608 \times 10^{-5} \text{ m}^2/\text{s}$$

$$\text{Pr} = 0.7282$$

$$\beta = \frac{1}{T_f} = \frac{1}{(30 + 273)\text{K}} = 0.003300 \text{ K}^{-1}$$

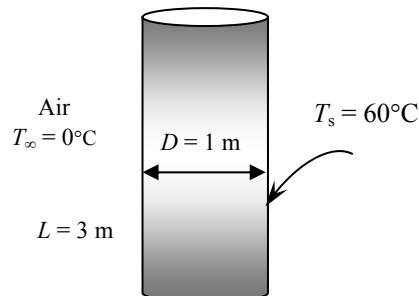

Analysis (a) When there is no wind heat transfer is by natural convection. The characteristic length in this case is the height of the vessel, $L_c = L = 3 \text{ m}$. Then,

$$Ra = \frac{g\beta(T_s - T_\infty)L^3}{\nu^2} \text{Pr} = \frac{(9.81 \text{ m/s}^2)(0.003300 \text{ K}^{-1})(60 - 0 \text{ K})(3 \text{ m})^3}{(1.608 \times 10^{-5} \text{ m}^2/\text{s})^2} (0.7282) = 1.477 \times 10^{11}$$

We can treat this vertical cylinder as a vertical plate since

$$\frac{35L}{Gr^{1/4}} = \frac{35(3)}{(1.477 \times 10^{11} / 0.7282)^{1/4}} = 0.156 < 1.0 \quad \text{and thus } D \geq \frac{35L}{Gr^{1/4}}$$

The Nusselt number is determined from

$$Nu = 0.1Ra^{1/3} = 0.1(1.477 \times 10^{11})^{1/3} = 528.6 \quad (\text{from Table 9-1})$$

Then

$$h = \frac{k}{L_c} Nu = \frac{0.02588 \text{ W/m}\cdot^\circ\text{C}}{3 \text{ m}} (528.6) = 4.560 \text{ W/m}^2\cdot^\circ\text{C}$$

and

$$\dot{Q} = hA(T_s - T_\infty) = (4.560 \text{ W/m}^2\cdot^\circ\text{C})(\pi \times 1 \times 3 \text{ m}^2)(60 - 0)^\circ\text{C} = \mathbf{2579 \text{ W}}$$

(b) When the vessel is exposed to 20 km/h winds, the heat transfer will be by forced convection. We have flow of air over a cylinder and the heat transfer rate is determined as follows:

$$\text{Re} = \frac{VD}{\nu} = \frac{(20 \times 100 / 3600 \text{ m/s})(1.0 \text{ m})}{1.608 \times 10^{-5} \text{ m}^2/\text{s}} = 3.455 \times 10^5$$

$$\text{Nu} = 0.027 \text{Re}^{0.805} \text{Pr}^{1/3} = 0.027(3.455 \times 10^5)^{0.805} (0.7282)^{1/3} = 698.1 \quad (\text{from Table 7-1})$$

$$h = \frac{k}{D} \text{Nu} = \frac{0.02588 \text{ W/m}\cdot^\circ\text{C}}{1.0 \text{ m}} (698.1) = 18.07 \text{ W/m}^2\cdot^\circ\text{C}$$

$$\dot{Q} = hA(T_s - T_\infty) = (18.07 \text{ W/m}^2\cdot^\circ\text{C})(\pi \times 1 \times 3 \text{ m}^2)(60 - 0)^\circ\text{C} = \mathbf{10,220 \text{ W}}$$

Discussion There is about four-fold increase in heat transfer due to winds.

9-102 A solid sphere is completely submerged in a large pool of oil. The rates of heat transfer from the sphere by natural convection, conduction, and forced convection are to be determined.

Assumptions 1 Steady operating conditions exist. **2** The surface temperature is constant.

Properties The properties of oil are given in problem statement.

Analysis (a) For conduction heat transfer, $\beta = 0$ and $Ra = 0$. Then the Nusselt number is

$$Nu = 2$$

Then

$$h = \frac{k}{D} Nu = \frac{0.22 \text{ W/m}\cdot\text{C}}{0.5 \text{ m}} (2) = 0.88 \text{ W/m}^2\cdot\text{C}$$

$$\dot{Q}_{\text{cond}} = hA(T_s - T_\infty) = (0.88 \text{ W/m}^2\cdot\text{C})[\pi \times (0.5 \text{ m})^2](60 - 20)\text{C} = \mathbf{27.6 \text{ W}}$$

(b) In this case, the heat transfer from the vessel is by forced convection. Note that the fluid properties in this case are to be evaluated at the free stream temperature T_∞ except for μ_s , which is evaluated at the surface temperature, T_s . The Prandtl number and Reynolds number are

$$Pr = \frac{\mu c_p}{k} = \frac{(0.010 \text{ kg/m}\cdot\text{s})(1880 \text{ J/kg}\cdot\text{C})}{0.22 \text{ W/m}\cdot\text{C}} = 85.45$$

$$Re = \frac{VD\rho}{\mu} = \frac{(1.5 \text{ m/s})(0.5 \text{ m})(888 \text{ kg/m}^3)}{0.010 \text{ kg/m}\cdot\text{s}} = 66,600$$

The Nusselt number is

$$Nu = \frac{hD}{k} = 2 + \left[0.4 Re^{0.5} + 0.06 Re^{2/3} \right] Pr^{0.4} \left(\frac{\mu_\infty}{\mu_s} \right)^{1/4}$$

$$= 2 + \left[0.4(66,600)^{0.5} + 0.06(66,600)^{2/3} \right] (85.45)^{0.4} \left(\frac{0.010}{0.004} \right)^{1/4} = 1506$$

The heat transfer coefficient is

$$h = \frac{k}{D} Nu = \frac{0.22 \text{ W/m}\cdot\text{C}}{0.5 \text{ m}} (1506) = 662.4 \text{ W/m}^2\cdot\text{C}$$

The rate of heat transfer is

$$\dot{Q}_{\text{forced conv}} = hA(T_s - T_\infty) = (662.4 \text{ W/m}^2\cdot\text{C})[\pi \times (0.5 \text{ m})^2](60 - 20)\text{C} = \mathbf{20,810 \text{ W}}$$

(c) Heat transfer in this case will be by natural convection. Note that the fluid properties in this case are to be evaluated at the film temperature of 40°C . The characteristic length in this case is $L_c = D = 0.5 \text{ m}$. Then,

$$Ra = \frac{g\beta(T_s - T_\infty)D^3}{\nu^2} Pr = \frac{(9.81 \text{ m/s}^2)(0.00070 \text{ K}^{-1})(60 - 20 \text{ K})(0.5 \text{ m})^3}{(0.007/876 \text{ m}^2/\text{s})^2} (65.5) = 3.522 \times 10^{10}$$

where $Pr = \frac{\mu c_p}{k} = \frac{(0.007 \text{ kg/m}\cdot\text{s})(1965 \text{ J/kg}\cdot\text{C})}{0.21 \text{ W/m}\cdot\text{C}} = 65.5$

Then

$$Nu = 2 + \frac{0.589 Ra^{1/4}}{\left[1 + (0.469 / Pr)^{9/16} \right]^{4/9}} = 2 + \frac{0.589(3.522 \times 10^{10})^{1/4}}{\left[1 + (0.469 / 65.5)^{9/16} \right]^{4/9}} = 250.4$$

$$h = \frac{k}{D} Nu = \frac{0.21 \text{ W/m}\cdot\text{C}}{0.5 \text{ m}} (250.4) = 105.2 \text{ W/m}^2\cdot\text{C}$$

$$\dot{Q}_{\text{nat. conv}} = hA(T_s - T_\infty) = (105.2 \text{ W/m}^2\cdot\text{C})[\pi \times (0.5 \text{ m})^2](60 - 20)\text{C} = \mathbf{3304 \text{ W}}$$

Discussion The heat transfer from the sphere by forced convection is much greater than that by natural convection and the heat transfer by natural convection is much greater than that by conduction.

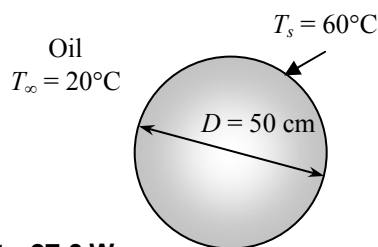

9-103E A small cylindrical resistor mounted on the lower part of a vertical circuit board. The approximate surface temperature of the resistor is to be determined.

Assumptions 1 Steady operating conditions exist. 2 Air is an ideal gas with constant properties. 3 The local atmospheric pressure is 1 atm. 4 Radiation effects are negligible. 5 Heat transfer through the connecting wires is negligible.

Properties The properties of air at 1 atm and the anticipated film temperature of $(T_s + T_\infty)/2 = (220 + 120)/2 = 170^\circ\text{F}$ are (Table A-15E)

$$k = 0.01692 \text{ Btu/h}\cdot\text{ft}\cdot^\circ\text{F}$$

$$\nu = 0.222 \times 10^{-3} \text{ ft}^2/\text{s}$$

$$\text{Pr} = 0.7161$$

$$\beta = \frac{1}{T_f} = \frac{1}{(170 + 460)\text{R}} = 0.001587 \text{ R}^{-1}$$

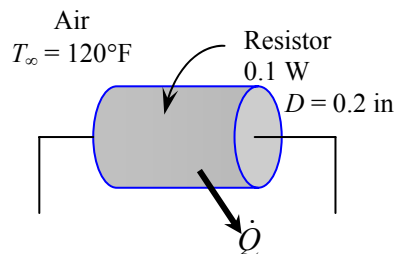

Analysis The solution of this problem requires a trial-and-error approach since the determination of the Rayleigh number and thus the Nusselt number depends on the surface temperature which is unknown. We start the solution process by “guessing” the surface temperature to be 220°F for the evaluation of the properties and h . We will check the accuracy of this guess later and repeat the calculations if necessary. The characteristic length in this case is the diameter of resistor, $L_c = D = 0.2 \text{ in}$. Then,

$$Ra = \frac{g\beta(T_s - T_\infty)D^3}{\nu^2} \text{Pr} = \frac{(32.2 \text{ ft/s}^2)(0.001587 \text{ R}^{-1})(220 - 120 \text{ R})(0.2 / 12 \text{ ft})^3}{(0.222 \times 10^{-3} \text{ ft}^2/\text{s})^2} (0.7161) = 343.8$$

$$Nu = \left\{ 0.6 + \frac{0.387 Ra^{1/6}}{\left[1 + (0.559 / \text{Pr})^{9/16} \right]^{8/27}} \right\}^2 = \left\{ 0.6 + \frac{0.387(343.8)^{1/6}}{\left[1 + (0.559 / 0.7161)^{9/16} \right]^{8/27}} \right\}^2 = 2.105$$

$$h = \frac{k}{D} Nu = \frac{0.01692 \text{ Btu/h}\cdot\text{ft}\cdot^\circ\text{F}}{0.2 / 12 \text{ ft}} (2.105) = 2.138 \text{ Btu/h}\cdot\text{ft}^2\cdot^\circ\text{F}$$

$$A_s = \pi DL + 2\pi D^2 / 4 = \pi(0.2 / 12 \text{ ft})(0.3 / 12 \text{ ft}) + 2\pi(0.2 / 12 \text{ ft})^2 / 4 = 0.00175 \text{ ft}^2$$

$$\text{and } \dot{Q} = hA_s(T_s - T_\infty) \longrightarrow T_s = T_\infty + \frac{\dot{Q}}{hA_s} = 120^\circ\text{F} + \frac{(0.1 \times 3.412) \text{ Btu/h}}{(2.138 \text{ Btu/h}\cdot\text{ft}^2\cdot^\circ\text{F})(0.00175 \text{ ft}^2)} = \mathbf{211^\circ\text{F}}$$

which is sufficiently close to the assumed temperature for the evaluation of properties. Therefore, there is no need to repeat calculations.

9-104 An ice chest filled with ice at 0°C is exposed to ambient air. The time it will take for the ice in the chest to melt completely is to be determined for natural and forced convection cases.

Assumptions 1 Steady operating conditions exist. 2 Air is an ideal gas with constant properties. 3 Heat transfer from the base of the ice chest is disregarded. 4 Radiation effects are negligible. 5 Heat transfer coefficient is the same for all surfaces considered. 6 The local atmospheric pressure is 1 atm.

Properties The properties of air at 1 atm and the anticipated film temperature of $(T_s + T_\infty)/2 = (15 + 20)/2 = 17.5^\circ\text{C}$ are (Table A-15)

$$k = 0.02495 \text{ W/m}\cdot^\circ\text{C}$$

$$\nu = 1.493 \times 10^{-5} \text{ m}^2/\text{s}$$

$$\text{Pr} = 0.7316$$

$$\beta = \frac{1}{T_f} = \frac{1}{(17.5 + 273)\text{K}} = 0.003442 \text{ K}^{-1}$$

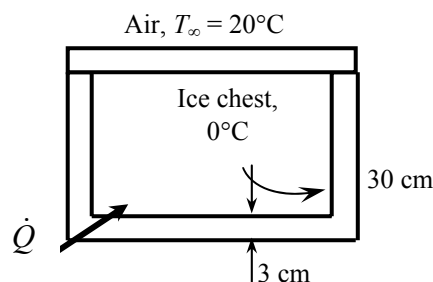

Analysis The solution of this problem requires a trial-and-error approach since the determination of the Rayleigh number and thus the Nusselt number depends on the surface temperature which is unknown. We start the solution process by “guessing” the surface temperature to be 15°C for the evaluation of the properties and h . We will check the accuracy of this guess later and repeat the calculations if necessary. The characteristic length for the side surfaces is the height of the chest, $L_c = L = 0.3 \text{ m}$. Then,

$$\text{Ra} = \frac{g\beta(T_\infty - T_s)L^3}{\nu^2} \text{Pr} = \frac{(9.81 \text{ m/s}^2)(0.003442 \text{ K}^{-1})(20 - 15 \text{ K})(0.3 \text{ m})^3}{(1.493 \times 10^{-5} \text{ m}^2/\text{s})^2} (0.7316) = 1.495 \times 10^7$$

$$\text{Nu} = \left\{ 0.825 + \frac{0.387\text{Ra}^{1/6}}{\left[1 + \left(\frac{0.492}{\text{Pr}} \right)^{9/16} \right]^{8/27}} \right\}^2 = \left\{ 0.825 + \frac{0.387(1.495 \times 10^7)^{1/6}}{\left[1 + \left(\frac{0.492}{0.7316} \right)^{9/16} \right]^{8/27}} \right\}^2 = 35.15$$

$$h = \frac{k}{L} \text{Nu} = \frac{0.02495 \text{ W/m}\cdot^\circ\text{C}}{0.3 \text{ m}} (35.15) = 2.923 \text{ W/m}^2\cdot^\circ\text{C}$$

The heat transfer coefficient at the top surface can be determined similarly. However, the top surface constitutes only about one-fourth of the heat transfer area, and thus we can use the heat transfer coefficient for the side surfaces for the top surface also for simplicity. The heat transfer surface area is

$$A_s = 4(0.3 \text{ m})(0.4 \text{ m}) + (0.4 \text{ m})(0.4 \text{ m}) = 0.64 \text{ m}^2$$

Then the rate of heat transfer becomes

$$\dot{Q} = \frac{T_\infty - T_{s,i}}{R_{\text{wall}} + R_{\text{conv},o}} = \frac{T_\infty - T_{s,i}}{\frac{L}{kA_s} + \frac{1}{hA_s}} = \frac{(20 - 0)^\circ\text{C}}{\frac{0.03 \text{ m}}{(0.033 \text{ W/m}\cdot^\circ\text{C})(0.64 \text{ m}^2)} + \frac{1}{(2.923 \text{ W/m}^2\cdot^\circ\text{C})(0.64 \text{ m}^2)}} = 10.23 \text{ W}$$

The outer surface temperature of the ice chest is determined from Newton’s law of cooling to be

$$\dot{Q} = hA_s(T_\infty - T_s) \rightarrow T_s = T_\infty - \frac{\dot{Q}}{hA_s} = 20^\circ\text{C} - \frac{10.23 \text{ W}}{(2.923 \text{ W/m}^2\cdot^\circ\text{C})(0.64 \text{ m}^2)} = 14.53^\circ\text{C}$$

which is almost identical to the assumed value of 15°C used in the evaluation of properties and h . Therefore, there is no need to repeat the calculations.

The rate at which the ice will melt is

$$\dot{Q} = \dot{m}h_{if} \rightarrow \dot{m} = \frac{\dot{Q}}{h_{if}} = \frac{10.23 \times 10^{-3} \text{ kJ/s}}{333.7 \text{ kJ/kg}} = 3.066 \times 10^{-5} \text{ kg/s}$$

Therefore, the melting of the ice in the chest completely will take

$$m = \dot{m}\Delta t \longrightarrow \Delta t = \frac{m}{\dot{m}} = \frac{30 \text{ kg}}{3.066 \times 10^{-5} \text{ kg/s}} = 9.786 \times 10^5 \text{ s} = \mathbf{271.8 \text{ h} = 11.3 \text{ days}}$$

(b) The temperature drop across the styrofoam will be much greater in this case than that across thermal boundary layer on the surface. Thus we assume outer surface temperature of the styrofoam to be 19°C . Radiation heat transfer will be neglected. The properties of air at 1 atm and the film temperature of $(T_s + T_\infty)/2 = (19 + 20)/2 = 19.5^\circ\text{C}$ are (Table A-15)

$$k = 0.0251 \text{ W/m}\cdot^\circ\text{C}$$

$$\nu = 1.511 \times 10^{-5} \text{ m}^2/\text{s}$$

$$\text{Pr} = 0.7310$$

$$\beta = \frac{1}{T_f} = \frac{1}{(19.5 + 273)\text{K}} = 0.00342 \text{ K}^{-1}$$

The characteristic length in this case is the width of the chest, $L_c = W = 0.4 \text{ m}$. Then,

$$\text{Re} = \frac{VW}{\nu} = \frac{(50 \times 1000 / 3600 \text{ m/s})(0.4 \text{ m})}{1.511 \times 10^{-5} \text{ m}^2/\text{s}} = 367,700$$

which is less than critical Reynolds number (5×10^5). Therefore the flow is laminar, and the Nusselt number is determined from

$$\text{Nu} = \frac{hW}{k} = 0.664 \text{ Re}^{0.5} \text{ Pr}^{1/3} = 0.664(367,700)^{0.5} (0.7310)^{1/3} = 362.7$$

$$h = \frac{k}{W} \text{Nu} = \frac{0.0251 \text{ W/m}\cdot^\circ\text{C}}{0.4 \text{ m}} (362.7) = 22.76 \text{ W/m}^2\cdot^\circ\text{C}$$

Then the rate of heat transfer becomes

$$\dot{Q} = \frac{T_\infty - T_{s,i}}{R_{\text{wall}} + R_{\text{conv},o}} = \frac{T_\infty - T_{s,i}}{\frac{L}{kA_s} + \frac{1}{hA_s}} = \frac{(20 - 0)^\circ\text{C}}{\frac{0.03 \text{ m}}{(0.033 \text{ W/m}\cdot^\circ\text{C})(0.64 \text{ m}^2)} + \frac{1}{(22.76 \text{ W/m}^2\cdot^\circ\text{C})(0.64 \text{ m}^2)}} = 13.43 \text{ W}$$

The outer surface temperature of the ice chest is determined from Newton's law of cooling to be

$$\dot{Q} = hA_s(T_\infty - T_s) \rightarrow T_s = T_\infty - \frac{\dot{Q}}{hA_s} = 20^\circ\text{C} - \frac{13.43 \text{ W}}{(22.76 \text{ W/m}^2\cdot^\circ\text{C})(0.64 \text{ m}^2)} = 19.1^\circ\text{C}$$

which is almost identical to the assumed value of 19°C used in the evaluation of properties and h . Therefore, there is no need to repeat the calculations. Then the rate at which the ice will melt becomes

$$\dot{Q} = \dot{m}h_{if} \rightarrow \dot{m} = \frac{\dot{Q}}{h_{if}} = \frac{13.43 \times 10^{-3} \text{ kJ/s}}{333.7 \text{ kJ/kg}} = 4.025 \times 10^{-5} \text{ kg/s}$$

Therefore, the melting of the ice in the chest completely will take

$$m = \dot{m}\Delta t \longrightarrow \Delta t = \frac{m}{\dot{m}} = \frac{30}{4.025 \times 10^{-5}} = 7.454 \times 10^5 \text{ s} = \mathbf{207.05 \text{ h} = 8.6 \text{ days}}$$

9-105 An electronic box is cooled internally by a fan blowing air into the enclosure. The fraction of the heat lost from the outer surfaces of the electronic box is to be determined.

Assumptions 1 Steady operating conditions exist. **2** Air is an ideal gas with constant properties. **3** Heat transfer from the base surface is disregarded. **4** The pressure of air inside the enclosure is 1 atm.

Properties The properties of air at 1 atm and the film temperature of $(T_s + T_\infty)/2 = (32 + 15)/2 = 28.5^\circ\text{C}$ are (Table A-15)

$$k = 0.02577 \text{ W/m}\cdot^\circ\text{C}$$

$$\nu = 1.594 \times 10^{-5} \text{ m}^2/\text{s}$$

$$\text{Pr} = 0.7286$$

$$\beta = \frac{1}{T_f} = \frac{1}{(28.5 + 273)\text{K}} = 0.003317 \text{ K}^{-1}$$

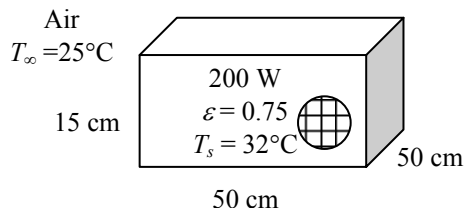

Analysis Heat loss from the horizontal top surface:

The characteristic length in this case is $\delta = \frac{A}{P} = \frac{(0.5 \text{ m})^2}{2[(0.5 \text{ m}) + (0.5 \text{ m})]} = 0.125 \text{ m}$. Then,

$$\text{Ra} = \frac{g\beta(T_s - T_\infty)L_c^3}{\nu^2} \text{Pr} = \frac{(9.81 \text{ m/s}^2)(0.003317 \text{ K}^{-1})(32 - 25 \text{ K})(0.125 \text{ m})^3}{(1.594 \times 10^{-5} \text{ m}^2/\text{s})^2} (0.7286) = 1.275 \times 10^6$$

$$\text{Nu} = 0.54 \text{Ra}^{1/4} = 0.54(1.275 \times 10^6)^{1/4} = 18.15$$

$$h = \frac{k}{L_c} \text{Nu} = \frac{0.02577 \text{ W/m}\cdot^\circ\text{C}}{0.125 \text{ m}} (18.15) = 3.741 \text{ W/m}^2\cdot^\circ\text{C}$$

$$A_{\text{top}} = (0.5 \text{ m})^2 = 0.25 \text{ m}^2$$

and $\dot{Q}_{\text{top}} = hA_{\text{top}}(T_s - T_\infty) = (3.741 \text{ W/m}^2\cdot^\circ\text{C})(0.25 \text{ m}^2)(32 - 25)^\circ\text{C} = 6.55 \text{ W}$

Heat loss from vertical side surfaces:

The characteristic length in this case is the height of the box $L_c = L = 0.15 \text{ m}$. Then,

$$\text{Ra} = \frac{g\beta(T_s - T_\infty)L_c^3}{\nu^2} \text{Pr} = \frac{(9.81 \text{ m/s}^2)(0.003317 \text{ K}^{-1})(32 - 25 \text{ K})(0.15 \text{ m})^3}{(1.594 \times 10^{-5} \text{ m}^2/\text{s})^2} (0.7286) = 2.204 \times 10^6$$

$$\text{Nu} = \left\{ 0.825 + \frac{0.387 \text{Ra}^{1/6}}{\left[1 + \left(\frac{0.492}{\text{Pr}} \right)^{9/16} \right]^{8/27}} \right\}^2 = \left\{ 0.825 + \frac{0.387(2.204 \times 10^6)^{1/6}}{\left[1 + \left(\frac{0.492}{0.7286} \right)^{9/16} \right]^{8/27}} \right\}^2 = 20.55$$

$$h = \frac{k}{L} \text{Nu} = \frac{0.02577 \text{ W/m}\cdot^\circ\text{C}}{0.15 \text{ m}} (20.55) = 3.530 \text{ W/m}^2\cdot^\circ\text{C}$$

$$A_{\text{side}} = 4(0.15 \text{ m})(0.5 \text{ m}) = 0.3 \text{ m}^2$$

and $\dot{Q}_{\text{side}} = hA_{\text{side}}(T_s - T_\infty) = (3.530 \text{ W/m}^2\cdot^\circ\text{C})(0.3 \text{ m}^2)(32 - 25)^\circ\text{C} = 7.41 \text{ W}$

The radiation heat loss is

$$\begin{aligned} \dot{Q}_{\text{rad}} &= \varepsilon A_s \sigma (T_s^4 - T_{\text{surr}}^4) \\ &= (0.75)(0.25 + 0.3 \text{ m}^2)(5.67 \times 10^{-8} \text{ W/m}^2\cdot\text{K}^4)[(32 + 273 \text{ K})^4 - (25 + 273 \text{ K})^4] = 17.95 \text{ W} \end{aligned}$$

Then the fraction of the heat loss from the outer surfaces of the box is determined to be

$$f = \frac{(6.55 + 7.41 + 17.95) \text{ W}}{200 \text{ W}} = 0.160 = \mathbf{16.0\%}$$

9-106 A spherical tank made of stainless steel is used to store iced water. The rate of heat transfer to the iced water and the amount of ice that melts during a 24-h period are to be determined.

Assumptions 1 Steady operating conditions exist. 2 Air is an ideal gas with constant properties. 3 Thermal resistance of the tank is negligible. 4 The local atmospheric pressure is 1 atm.

Properties The properties of air at 1 atm and the film temperature of $(T_s + T_\infty)/2 = (0 + 20)/2 = 10^\circ\text{C}$ are (Table A-15)

$$k = 0.02439 \text{ W/m}\cdot^\circ\text{C}$$

$$\nu = 1.426 \times 10^{-5} \text{ m}^2/\text{s}$$

$$\text{Pr} = 0.7336$$

$$\beta = \frac{1}{T_f} = \frac{1}{(10 + 273)\text{K}} = 0.003534 \text{ K}^{-1}$$

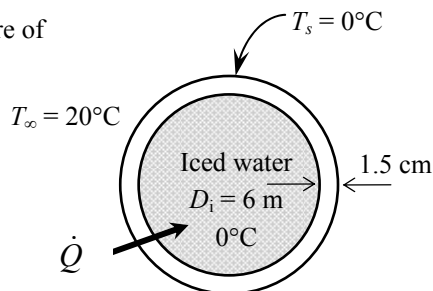

Analysis (a) The characteristic length in this case is $L_c = D_o = 6.03 \text{ m}$. Then,

$$Ra = \frac{g\beta(T_\infty - T_s)D_o^3}{\nu^2} \text{Pr} = \frac{(9.81 \text{ m/s}^2)(0.003534 \text{ K}^{-1})(20 - 0 \text{ K})(6.03 \text{ m})^3}{(1.426 \times 10^{-5} \text{ m}^2/\text{s})^2} (0.7336) = 5.485 \times 10^{11}$$

$$Nu = 2 + \frac{0.589Ra^{1/4}}{\left[1 + (0.469/\text{Pr})^{9/16}\right]^{4/9}} = 2 + \frac{0.589(5.485 \times 10^{11})^{1/4}}{\left[1 + (0.469/0.7336)^{9/16}\right]^{4/9}} = 394.5$$

$$h = \frac{k}{D_o} Nu = \frac{0.02439 \text{ W/m}\cdot^\circ\text{C}}{6.03 \text{ m}} (394.5) = 1.596 \text{ W/m}^2\cdot^\circ\text{C}$$

$$A_s = \pi D_o^2 = \pi (6.03 \text{ m})^2 = 114.2 \text{ m}^2$$

and

$$\dot{Q} = hA_s(T_\infty - T_s) = (1.596 \text{ W/m}^2\cdot^\circ\text{C})(114.2 \text{ m}^2)(20 - 0)^\circ\text{C} = 3646 \text{ W}$$

Heat transfer by radiation and the total rate of heat transfer are

$$\begin{aligned} \dot{Q}_{rad} &= \varepsilon A_s \sigma (T_s^4 - T_{surr}^4) \\ &= (1)(114.2 \text{ m}^2)(5.67 \times 10^{-8} \text{ W/m}^2\cdot\text{K}^4)[(20 + 273 \text{ K})^4 - (0 + 273 \text{ K})^4] = 11,759 \text{ W} \end{aligned}$$

$$\dot{Q}_{total} = 3646 + 11,759 = 15,404 \text{ W} \cong \mathbf{15.4 \text{ kW}}$$

(b) The total amount of heat transfer during a 24-hour period is

$$Q = \dot{Q}\Delta t = (15.4 \text{ kJ/s})(24 \text{ h/day} \times 3600 \text{ s/h}) = 1.331 \times 10^6 \text{ kJ/day}$$

Then the amount of ice that melts during this period becomes

$$Q = mh_{if} \longrightarrow m = \frac{Q}{h_{if}} = \frac{1.331 \times 10^6 \text{ kJ}}{333.7 \text{ kJ/kg}} = \mathbf{3988 \text{ kg}}$$

9-107 A double-pane window consisting of two layers of glass separated by an air space is considered. The rate of heat transfer through the window and the temperature of its inner surface are to be determined.

Assumptions 1 Steady operating conditions exist. 2 Air is an ideal gas with constant properties. 3 Radiation effects are negligible. 4 The pressure of air inside the enclosure is 1 atm.

Properties We expect the average temperature of the air gap to be roughly the average of the indoor and outdoor temperatures, and evaluate The properties of air at 1 atm and the average temperature of $(T_{\infty 1} + T_{\infty 2})/2 = (20 + 0)/2 = 10^\circ\text{C}$ are (Table A-15)

$$k = 0.02439 \text{ W/m}\cdot^\circ\text{C}$$

$$\nu = 1.426 \times 10^{-5} \text{ m}^2/\text{s}$$

$$\text{Pr} = 0.7336$$

$$\beta = \frac{1}{T_f} = \frac{1}{(10 + 273)\text{K}} = 0.003534 \text{ K}^{-1}$$

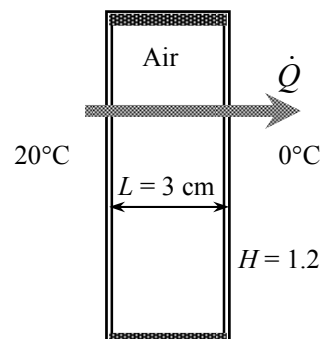

Analysis We “guess” the temperature difference across the air gap to be $15^\circ\text{C} = 15 \text{ K}$ for use in the Ra relation. The characteristic length in this case is the air gap thickness, $L_c = L = 0.03 \text{ m}$. Then,

$$Ra = \frac{g\beta(T_1 - T_2)L^3}{\nu^2} \text{Pr} = \frac{(9.81 \text{ m/s}^2)(0.003534 \text{ K}^{-1})(15 \text{ K})(0.03 \text{ m})^3}{(1.426 \times 10^{-5} \text{ m}^2/\text{s})^2} (0.7336) = 5.065 \times 10^4$$

Then the Nusselt number and the heat transfer coefficient are determined to be

$$Nu = 0.42 Ra^{1/4} \text{Pr}^{0.012} \left(\frac{H}{L}\right)^{-0.3} = 0.42(5.065 \times 10^4)^{1/4} (0.7336)^{0.012} \left(\frac{1.2 \text{ m}}{0.03 \text{ m}}\right)^{-0.3} = 2.076$$

$$h_{air} = \frac{k}{L} Nu = \frac{0.02439 \text{ W/m}\cdot^\circ\text{C}}{0.03 \text{ m}} (2.076) = 1.688 \text{ W/m}^2 \cdot^\circ\text{C}$$

Then the rate of heat transfer through this double pane window is determined to be

$$A_s = H \times W = (1.2 \text{ m})(2 \text{ m}) = 2.4 \text{ m}^2$$

$$\begin{aligned} \dot{Q} &= \frac{T_{\infty, i} - T_{\infty, o}}{R_{conv, i} + R_{cond, glasses} + R_{conv, air} + R_{conv, o}} = \frac{T_{\infty} - T_{s, i}}{\frac{1}{h_i A_s} + \frac{2t_{glass}}{k_{glass} A_s} + \frac{1}{h_{air} A_s} + \frac{1}{h_o A_s}} \\ &= \frac{20 - 0}{\frac{1}{(10)(2.4)} + \frac{2(0.003)}{(0.78)(2.4)} + \frac{1}{(1.688)(2.4)} + \frac{1}{(25)(2.4)}} = \mathbf{65 \text{ W}} \end{aligned}$$

Check: The temperature drop across the air gap is determined from

$$\dot{Q} = h A_s \Delta T \rightarrow \Delta T = \frac{\dot{Q}}{h A_s} = \frac{65 \text{ W}}{(1.688 \text{ W/m}^2 \cdot^\circ\text{C})(2.4 \text{ m}^2)} = 16.0^\circ\text{C}$$

which is very close to the assumed value of 15°C used in the evaluation of the Ra number.

9-108 An electric resistance space heater filled with oil is placed against a wall. The power rating of the heater and the time it will take for the heater to reach steady operation when it is first turned on are to be determined.

Assumptions 1 Steady operating conditions exist. 2 Air is an ideal gas with constant properties. 3 Heat transfer from the back, bottom, and top surfaces are disregarded. 4 The local atmospheric pressure is 1 atm.

Properties The properties of air at 1 atm and the film temperature of $(T_s + T_\infty)/2 = (75 + 25)/2 = 50^\circ\text{C}$ are (Table A-15)

$$k = 0.02735 \text{ W/m}\cdot^\circ\text{C}$$

$$\nu = 1.798 \times 10^{-5} \text{ m}^2/\text{s}$$

$$\text{Pr} = 0.7228$$

$$\beta = \frac{1}{T_f} = \frac{1}{(50 + 273)\text{K}} = 0.003096 \text{ K}^{-1}$$

Analysis Heat transfer from the top and bottom surfaces are said to be negligible, and thus the heat transfer area in this case consists of the three exposed side surfaces. The characteristic length is the height of the box, $L_c = L = 0.5 \text{ m}$. Then,

$$\text{Ra} = \frac{g\beta(T_s - T_\infty)L^3}{\nu^2} \text{Pr} = \frac{(9.81 \text{ m/s}^2)(0.003096 \text{ K}^{-1})(75 - 25 \text{ K})(0.5 \text{ m})^3}{(1.798 \times 10^{-5} \text{ m}^2/\text{s})^2} (0.7228) = 4.244 \times 10^8$$

$$\text{Nu} = \left\{ 0.825 + \frac{0.387\text{Ra}^{1/6}}{\left[1 + \left(\frac{0.492}{\text{Pr}} \right)^{9/16} \right]^{8/27}} \right\}^2 = \left\{ 0.825 + \frac{0.387(4.244 \times 10^8)^{1/6}}{\left[1 + \left(\frac{0.492}{0.7228} \right)^{9/16} \right]^{8/27}} \right\}^2 = 94.68$$

$$h = \frac{k}{L} \text{Nu} = \frac{0.02735 \text{ W/m}\cdot^\circ\text{C}}{0.5 \text{ m}} (94.68) = 5.179 \text{ W/m}^2\cdot^\circ\text{C}$$

$$A_s = (0.5 \text{ m})(0.8 \text{ m}) + 2(0.15 \text{ m})(0.5 \text{ m}) = 0.55 \text{ m}^2$$

and $\dot{Q} = hA_s(T_s - T_\infty) = (5.179 \text{ W/m}^2\cdot^\circ\text{C})(0.55 \text{ m}^2)(75 - 25)^\circ\text{C} = 142.4 \text{ W}$

The radiation heat loss is

$$\begin{aligned} \dot{Q}_{rad} &= \varepsilon A_s \sigma (T_s^4 - T_{surr}^4) \\ &= (0.8)(0.55 \text{ m}^2)(5.67 \times 10^{-8} \text{ W/m}^2\cdot\text{K}^4)[(75 + 273 \text{ K})^4 - (25 + 273 \text{ K})^4] = 169.1 \text{ W} \end{aligned}$$

Then the total rate of heat transfer, thus the power rating of the heater becomes

$$\dot{Q}_{total} = 142.4 + 169.1 = \mathbf{311.5 \text{ W}}$$

The specific heat of the oil at the average temperature of the oil is $2006 \text{ J/kg}\cdot^\circ\text{C}$ (Table A-13). Then the amount of heat transfer needed to raise the temperature of the oil to the steady operating temperature and the time it takes become

$$Q = mc_p(T_2 - T_1) = (45 \text{ kg})(2006 \text{ J/kg}\cdot^\circ\text{C})(75 - 25)^\circ\text{C} = 4.514 \times 10^6 \text{ J}$$

$$Q = \dot{Q}\Delta t \longrightarrow \Delta t = \frac{Q}{\dot{Q}} = \frac{4.514 \times 10^6 \text{ kJ}}{311.5 \text{ J/s}} = 14,490 \text{ s} = \mathbf{4.03 \text{ h}}$$

which is not practical. Therefore, the surface temperature of the heater must be allowed to be higher than 75°C .

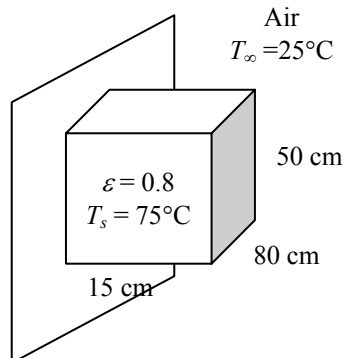

9-109 A horizontal skylight made of a single layer of glass on the roof of a house is considered. The rate of heat loss through the skylight is to be determined for two cases.

Assumptions 1 Steady operating conditions exist. 2 Air is an ideal gas with constant properties. 3 The local atmospheric pressure is 1 atm.

Properties The properties of air at 1 atm and the anticipated film temperature of $(T_s + T_\infty)/2 = (-4 - 10)/2 = -7^\circ\text{C}$ are (Table A-15)

$$k = 0.02311 \text{ W/m}\cdot^\circ\text{C}$$

$$\nu = 1.278 \times 10^{-5} \text{ m}^2/\text{s}$$

$$\text{Pr} = 0.738$$

$$\beta = \frac{1}{T_f} = \frac{1}{(-7 + 273)\text{K}} = 0.003759 \text{ K}^{-1}$$

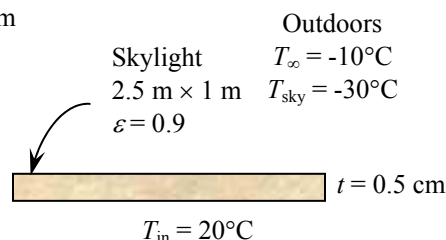

Analysis We assume radiation heat transfer inside the house to be negligible. We start the calculations by “guessing” the glass temperature to be -4°C for the evaluation of the properties and h . We will check the accuracy of this guess later and repeat the calculations if necessary. The characteristic length in this case is

determined from $L_c = \frac{A_s}{p} = \frac{(1 \text{ m})(2.5 \text{ m})}{2(1 \text{ m} + 2.5 \text{ m})} = 0.357 \text{ m}$. Then,

$$Ra = \frac{g\beta(T_1 - T_2)L_c^3}{\nu^2} \text{Pr} = \frac{(9.81 \text{ m/s}^2)(0.003759 \text{ K}^{-1})[-4 - (-10) \text{ K}](0.357 \text{ m})^3}{(1.278 \times 10^{-5} \text{ m}^2/\text{s})^2} (0.738) = 4.553 \times 10^7$$

$$Nu = 0.15Ra^{1/3} = 0.15(4.553 \times 10^7)^{1/3} = 53.56$$

$$h_o = \frac{k}{L_c} Nu = \frac{0.02311 \text{ W/m}\cdot^\circ\text{C}}{0.357 \text{ m}} (53.56) = 3.467 \text{ W/m}^2\cdot^\circ\text{C}$$

$$A_s = (1 \text{ m})(2.5 \text{ m}) = 2.5 \text{ m}^2$$

Using the assumed value of glass temperature, the radiation heat transfer coefficient is determined to be

$$\begin{aligned} h_{rad} &= \varepsilon\sigma(T_s + T_{sky})(T_s^2 + T_{sky}^2) \\ &= 0.9(5.67 \times 10^{-8} \text{ W/m}^2\cdot\text{K}^4)[(-4 + 273) + (-30 + 273)][(-4 + 273)^2 + (-30 + 273)^2] \text{K}^3 \\ &= 3.433 \text{ W/m}^2\cdot\text{K} \end{aligned}$$

Then the combined convection and radiation heat transfer coefficient outside becomes

$$h_{o,combined} = h_o + h_{rad} = 3.467 + 3.433 = 6.90 \text{ W/m}^2$$

Again we take the glass temperature to be -4°C for the evaluation of the properties and h for the inner surface of the skylight. The properties of air at 1 atm and the film temperature of $T_f = (-4 + 20)/2 = 8^\circ\text{C}$ are (Table A-15)

$$k = 0.02424 \text{ W/m}\cdot^\circ\text{C}$$

$$\nu = 1.408 \times 10^{-5} \text{ m}^2/\text{s}$$

$$\text{Pr} = 0.7342$$

$$\beta = \frac{1}{T_f} = \frac{1}{(8 + 273)\text{K}} = 0.003559 \text{ K}^{-1}$$

The characteristic length in this case is also 0.357 m. Then,

$$Ra = \frac{g\beta(T_1 - T_2)L_c^3}{\nu^2} \text{Pr} = \frac{(9.81 \text{ m/s}^2)(0.003559 \text{ K}^{-1})[20 - (-4) \text{ K}](0.357 \text{ m})^3}{(1.408 \times 10^{-5} \text{ m}^2/\text{s})^2} (0.7342) = 1.412 \times 10^8$$

$$Nu = 0.27Ra^{1/4} = 0.27(1.412 \times 10^8)^{1/4} = 29.43$$

$$h_i = \frac{k}{L_c} Nu = \frac{0.02424 \text{ W/m}\cdot\text{°C}}{0.357 \text{ m}} (29.43) = 1.998 \text{ W/m}^2\cdot\text{°C}$$

Using the thermal resistance network, the rate of heat loss through the skylight is determined to be

$$\begin{aligned} \dot{Q}_{\text{skylight}} &= \frac{T_{s,i} - T_{\infty,o}}{R_{\text{conv},i} + R_{\text{cond,glas}} + R_{\text{combined},o}} \\ &= \frac{A_s (T_{\text{room}} - T_{\text{out}})}{\frac{1}{h_i} + \frac{t_{\text{glass}}}{k_{\text{glass}}} + \frac{1}{h}} = \frac{(2.5 \text{ m}^2)[20 - (-10)]\text{°C}}{\frac{1}{1.998 \text{ W/m}^2\cdot\text{°C}} + \frac{0.005 \text{ m}}{0.78 \text{ W/m}\cdot\text{°C}} + \frac{1}{6.90 \text{ W/m}^2\cdot\text{°C}}} = 115 \text{ W} \end{aligned}$$

Using the same heat transfer coefficients for simplicity, the rate of heat loss through the roof in the case of R-5.34 construction is determined to be

$$\begin{aligned} \dot{Q}_{\text{roof}} &= \frac{T_{s,i} - T_{\infty,o}}{R_{\text{conv},i} + R_{\text{cond}} + R_{\text{combined},o}} \\ &= \frac{A_s (T_{\text{room}} - T_{\text{out}})}{\frac{1}{h_i} + R_{\text{glass}} + \frac{1}{h}} = \frac{(2.5 \text{ m}^2)[20 - (-10)]\text{°C}}{\frac{1}{1.998 \text{ W/m}^2\cdot\text{°C}} + 5.34 \text{ m}^2\cdot\text{°C/W} + \frac{1}{6.90 \text{ W/m}^2\cdot\text{°C}}} = 12.5 \text{ W} \end{aligned}$$

Therefore, a house loses $115/12.5 \cong 9$ times more heat through the skylights than it does through an insulated wall of the same size.

Using Newton's law of cooling, the glass temperature corresponding to a heat transfer rate of 115 W is calculated to be -3.3°C , which is sufficiently close to the assumed value of -4°C . Therefore, there is no need to repeat the calculations.

9-110 A solar collector consists of a horizontal copper tube enclosed in a concentric thin glass tube. Water is heated in the tube, and the annular space between the copper and glass tube is filled with air. The rate of heat loss from the collector by natural convection is to be determined.

Assumptions 1 Steady operating conditions exist. 2 Air is an ideal gas with constant properties. 3 Radiation effects are negligible. 3 The pressure of air in the enclosure is 1 atm.

Properties The properties of air at 1 atm and the average temperature of $(T_i + T_o)/2 = (60 + 32)/2 = 46^\circ\text{C}$ are (Table A-15)

$$k = 0.02706 \text{ W/m}\cdot^\circ\text{C}$$

$$\nu = 1.760 \times 10^{-5} \text{ m}^2/\text{s}$$

$$\text{Pr} = 0.7238$$

$$\beta = \frac{1}{T_f} = \frac{1}{(46 + 273)\text{K}} = 0.003135 \text{ K}^{-1}$$

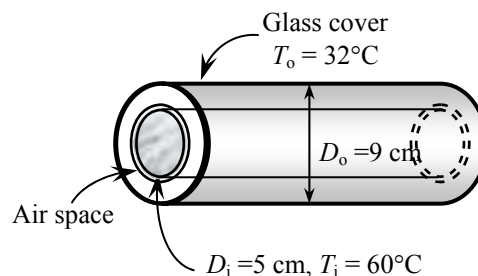

Analysis The characteristic length in this case is the distance between the two cylinders

$$L_c = \frac{D_o - D_i}{2} = \frac{(9 - 5) \text{ cm}}{2} = 2 \text{ cm}$$

and,

$$\text{Ra} = \frac{g\beta(T_i - T_o)L_c^3}{\nu^2} \text{Pr} = \frac{(9.81 \text{ m/s}^2)(0.003135 \text{ K}^{-1})(60 - 32 \text{ K})(0.02 \text{ m})^3}{(1.760 \times 10^{-5} \text{ m}^2/\text{s})^2} (0.7238) = 16,100$$

The effective thermal conductivity is

$$F_{\text{cyl}} = \frac{\left[\ln \frac{D_o}{D_i} \right]^4}{L_c^3 (D_i^{-3/5} + D_o^{-3/5})^5} = \frac{\left[\ln \frac{0.09 \text{ m}}{0.05 \text{ m}} \right]^4}{(0.02 \text{ m})^3 [(0.05 \text{ m})^{-7/5} + (0.09 \text{ m})^{-7/5}]^5} = 0.1303$$

$$k_{\text{eff}} = 0.386k \left(\frac{\text{Pr}}{0.861 + \text{Pr}} \right)^{1/4} (F_{\text{cyl}} \text{Ra})^{1/4}$$

$$= 0.386(0.02706 \text{ W/m}\cdot^\circ\text{C}) \left(\frac{0.7238}{0.861 + 0.7238} \right)^{1/4} [(0.1303)(16,100)]^{1/4} = 0.05811 \text{ W/m}\cdot^\circ\text{C}$$

Then the heat loss from the collector per meter length of the tube becomes

$$\dot{Q} = \frac{2\pi k_{\text{eff}}}{\ln \left(\frac{D_o}{D_i} \right)} (T_i - T_o) = \frac{2\pi(0.05811 \text{ W/m}\cdot^\circ\text{C})}{\ln \left(\frac{0.09 \text{ m}}{0.05 \text{ m}} \right)} (60 - 32)^\circ\text{C} = \mathbf{17.4 \text{ W}}$$

9-111 A solar collector consists of a horizontal tube enclosed in a concentric thin glass tube is considered. The pump circulating the water fails. The temperature of the aluminum tube when equilibrium is established is to be determined.

Assumptions 1 Steady operating conditions exist. 2 Air is an ideal gas with constant properties. 3 The local atmospheric pressure is 1 atm.

Properties The properties of air at 1 atm and the anticipated film temperature of $(T_s + T_\infty)/2 = (33 + 30)/2 = 31.5^\circ\text{C}$ are (Table A-15)

$$k = 0.02599 \text{ W/m}\cdot^\circ\text{C}$$

$$\nu = 1.622 \times 10^{-5} \text{ m}^2/\text{s}$$

$$\text{Pr} = 0.7278$$

$$\beta = \frac{1}{T_f} = \frac{1}{(31.5 + 273)\text{K}} = 0.003284 \text{ K}^{-1}$$

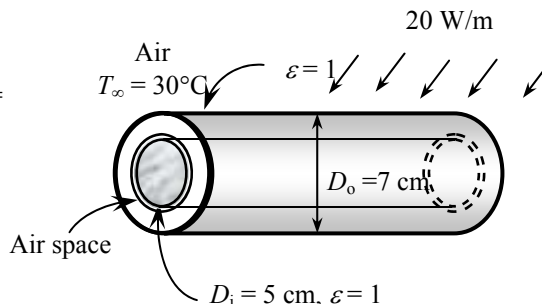

Analysis This problem involves heat transfer from the aluminum tube to the glass cover, and from the outer surface of the glass cover to the surrounding ambient air. When steady operation is reached, these two heat transfers will be equal to the rate of heat gain. That is,

$$\dot{Q}_{\text{tube-glass}} = \dot{Q}_{\text{glass-ambient}} = \dot{Q}_{\text{solar gain}} = 20 \text{ W (per meter length)}$$

Now we assume the surface temperature of the glass cover to be 33°C . We will check this assumption later on, and repeat calculations with a better assumption, if necessary.

The characteristic length for the outer diameter of the glass cover $L_c = D_o = 0.07 \text{ m}$. Then,

$$\text{Ra} = \frac{g\beta(T_s - T_\infty)D_o^3}{\nu^2} \text{Pr} = \frac{(9.81 \text{ m/s}^2)(0.003284 \text{ K}^{-1})(33 - 30 \text{ K})(0.07 \text{ m})^3}{(1.622 \times 10^{-5} \text{ m}^2/\text{s})^2} (0.7278) = 91,700$$

$$\text{Nu} = \left\{ 0.6 + \frac{0.387 \text{Ra}^{1/6}}{\left[1 + (0.559 / \text{Pr})^{9/16} \right]^{8/27}} \right\}^2 = \left\{ 0.6 + \frac{0.387(91,700)^{1/6}}{\left[1 + (0.559 / 0.7278)^{9/16} \right]^{8/27}} \right\}^2 = 7.626$$

$$A_s = \pi D_o L = \pi(0.07 \text{ m})(1 \text{ m}) = 0.2199 \text{ m}^2$$

$$h = \frac{k}{D_o} \text{Nu} = \frac{0.02599 \text{ W/m}\cdot^\circ\text{C}}{0.07 \text{ m}} (7.626) = 2.832 \text{ W/m}^2\cdot^\circ\text{C}$$

and,

$$\dot{Q}_{\text{conv}} = hA_s(T_s - T_\infty) = (2.832 \text{ W/m}^2\cdot^\circ\text{C})(0.2199 \text{ m}^2)(T_{\text{glass}} - 30)^\circ\text{C}$$

The radiation heat loss is

$$\dot{Q}_{\text{rad}} = \varepsilon A_s \sigma (T_s^4 - T_{\text{surr}}^4) = (1)(0.2199 \text{ m}^2)(5.67 \times 10^{-8} \text{ W/m}^2\cdot\text{K}^4) \left[(T_{\text{glass}} + 273 \text{ K})^4 - (20 + 273 \text{ K})^4 \right]$$

The expression for the total rate of heat transfer is

$$\begin{aligned} \dot{Q}_{\text{total}} &= \dot{Q}_{\text{conv}} + \dot{Q}_{\text{rad}} \\ 20 \text{ W} &= (2.832 \text{ W/m}^2\cdot^\circ\text{C})(0.2199 \text{ m}^2)(T_{\text{glass}} - 30)^\circ\text{C} \\ &\quad + (1)(0.2199 \text{ m}^2)(5.67 \times 10^{-8} \text{ W/m}^2\cdot\text{K}^4) \left[(T_{\text{glass}} + 273 \text{ K})^4 - (20 + 273 \text{ K})^4 \right] \end{aligned}$$

Its solution is $T_{\text{glass}} = 33.34^\circ\text{C}$, which is sufficiently close to the assumed value of 33°C .

Now we will calculate heat transfer through the air layer between aluminum tube and glass cover. We will assume the aluminum tube temperature to be 45°C and evaluate properties at the average temperature of $(T_i + T_o)/2 = (45 + 33.34)/2 = 39.17^\circ\text{C}$ are (Table A-15)

$$k = 0.02656 \text{ W/m}\cdot^\circ\text{C}$$

$$\nu = 1.694 \times 10^{-5} \text{ m}^2/\text{s}$$

$$\text{Pr} = 0.7257$$

$$\beta = \frac{1}{T_f} = \frac{1}{(39.17 + 273)\text{K}} = 0.003203 \text{ K}^{-1}$$

The characteristic length in this case is the distance between the two cylinders,

$$L_c = (D_o - D_i) / 2 = (7 - 5) / 2 \text{ cm} = 1 \text{ cm}$$

Then,

$$\text{Ra} = \frac{g\beta(T_1 - T_2)L_c^3}{\nu^2} \text{Pr} = \frac{(9.81 \text{ m/s}^2)(0.003203 \text{ K}^{-1})(45 - 33.34 \text{ K})(0.01 \text{ m})^3}{(1.694 \times 10^{-5} \text{ m}^2/\text{s})^2} (0.7257) = 926.5$$

The effective thermal conductivity is

$$F_{\text{cyl}} = \frac{\left[\ln \frac{D_o}{D_i} \right]^4}{L_c^3 (D_i^{-3/5} + D_o^{-3/5})^5} = \frac{\left[\ln \frac{0.07 \text{ m}}{0.05 \text{ m}} \right]^4}{(0.01 \text{ m})^3 [(0.05 \text{ m})^{-3/5} + (0.07 \text{ m})^{-3/5}]^5} = 0.08085$$

$$k_{\text{eff}} = 0.386k \left(\frac{\text{Pr}}{0.861 + \text{Pr}} \right)^{1/4} (F_{\text{cyl}} \text{Ra})^{1/4}$$

$$= 0.386(0.02656 \text{ W/m}\cdot^\circ\text{C}) \left(\frac{0.7257}{0.861 + 0.7257} \right)^{1/4} [(0.08085)(926.5)]^{1/4} = 0.02480 \text{ W/m}\cdot^\circ\text{C}$$

The heat transfer expression is

$$\dot{Q} = \frac{2\pi k_{\text{eff}}}{\ln \left(\frac{D_o}{D_i} \right)} (T_1 - T_2) = \frac{2\pi(0.02480 \text{ W/m}\cdot^\circ\text{C})}{\ln \left(\frac{0.07 \text{ m}}{0.05 \text{ m}} \right)} (T_{\text{tube}} - 33.34)^\circ\text{C}$$

The radiation heat loss is

$$A_s = \pi D_i L = \pi(0.05 \text{ m})^2 (1 \text{ m}) = 0.1571 \text{ m}^2$$

$$\dot{Q}_{\text{rad}} = \varepsilon A_s \sigma (T_s^4 - T_{\text{surr}}^4)$$

$$= (1)(0.1571 \text{ m}^2)(5.67 \times 10^{-8} \text{ W/m}^2 \cdot \text{K}^4) [(T_{\text{tube}} + 273 \text{ K})^4 - (33.34 + 273 \text{ K})^4]$$

The expression for the total rate of heat transfer is

$$\dot{Q}_{\text{total}} = \dot{Q}_{\text{conv}} + \dot{Q}_{\text{rad}}$$

$$20 \text{ W} = \frac{2\pi(0.02480 \text{ W/m}\cdot^\circ\text{C})}{\ln \left(\frac{0.07 \text{ m}}{0.05 \text{ m}} \right)} (T_{\text{tube}} - 33.34)^\circ\text{C}$$

$$+ (1)(0.1571 \text{ m}^2)(5.67 \times 10^{-8} \text{ W/m}^2 \cdot \text{K}^4) [(T_{\text{tube}} + 273 \text{ K})^4 - (33.34 + 273 \text{ K})^4]$$

Its solution is $T_{\text{tube}} = 46.3^\circ\text{C}$,

which is sufficiently close to the assumed value of 45°C. Therefore, there is no need to repeat the calculations.

9-112E The components of an electronic device located in a horizontal duct of rectangular cross section is cooled by forced air. The heat transfer from the outer surfaces of the duct by natural convection and the average temperature of the duct are to be determined.

Assumptions 1 Steady operating conditions exist. 2 Air is an ideal gas with constant properties. 3 The local atmospheric pressure is 1 atm. 4 Radiation effects are negligible. 5 The thermal resistance of the duct is negligible.

Properties The properties of air at 1 atm and the anticipated film temperature of $(T_s + T_\infty)/2 = (120 + 80)/2 = 100^\circ\text{F}$ are (Table A-15E)

$$k = 0.01529 \text{ Btu/h}\cdot\text{ft}\cdot^\circ\text{F}$$

$$\nu = 0.1809 \times 10^{-3} \text{ ft}^2/\text{s}$$

$$\text{Pr} = 0.726$$

$$\beta = 1/T_f = 1/(100 + 460)\text{R} = 0.001786 \text{ R}^{-1}$$

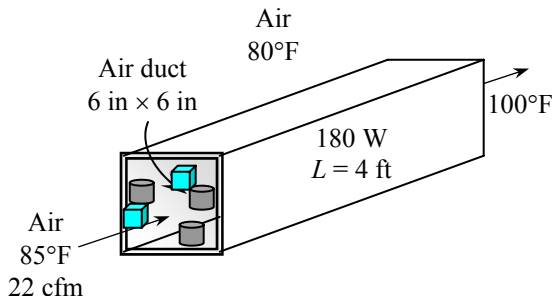

Analysis (a) Using air properties at the average temperature of $(85 + 100)/2 = 92.5^\circ\text{F}$ and 1 atm for the forced air, the mass flow rate of air and the heat transfer rate by forced convection are determined to be

$$\dot{m} = \rho \dot{V} = (0.07186 \text{ lbm/ft}^3)(22 \text{ ft}^3/\text{min}) = 1.581 \text{ lbm/min}$$

$$\dot{Q}_{\text{forced}} = \dot{m} c_p (T_{\text{out}} - T_{\text{in}}) = (1.581 \times 60 \text{ lbm/h})(0.2405 \text{ Btu/lbm}\cdot^\circ\text{F})(100 - 85)^\circ\text{F} = 342.1 \text{ Btu/h}$$

Noting that radiation heat transfer is negligible, the rest of the 180 W heat generated must be dissipated by natural convection,

$$\dot{Q}_{\text{natural}} = \dot{Q}_{\text{total}} - \dot{Q}_{\text{forced}} = (180 \times 3.412) - 342.1 = \mathbf{272 \text{ Btu/h}}$$

(b) We start the calculations by “guessing” the surface temperature to be 120°F for the evaluation of the properties and h . We will check the accuracy of this guess later and repeat the calculations if necessary.

Horizontal top surface: The characteristic length is $L_c = \frac{A_s}{P} = \frac{(4 \text{ ft})(6/12 \text{ ft})}{2(4 \text{ ft} + 6/12 \text{ ft})} = 0.2222 \text{ ft}$. Then,

$$Ra = \frac{g\beta(T_s - T_\infty)L_c^3}{\nu^2} \text{Pr} = \frac{(32.2 \text{ ft/s}^2)(0.001786 \text{ R}^{-1})(120 - 80 \text{ R})(0.2222 \text{ ft})^3}{(0.1809 \times 10^{-3} \text{ ft}^2/\text{s})^2} (0.726) = 5.599 \times 10^5$$

$$Nu = 0.54Ra^{1/4} = 0.54(5.599 \times 10^5)^{1/4} = 14.77$$

$$h_{\text{top}} = \frac{k}{L_c} Nu = \frac{0.01529 \text{ Btu/h}\cdot\text{ft}\cdot^\circ\text{F}}{0.2222 \text{ ft}} (14.77) = 1.016 \text{ Btu/h}\cdot\text{ft}^2\cdot^\circ\text{F}$$

$$A_{\text{top}} = (4 \text{ ft})(6/12 \text{ ft}) = 2 \text{ ft}^2 = A_{\text{bottom}}$$

Horizontal bottom surface: The Nusselt number for this geometry and orientation can be determined from

$$Nu = 0.27Ra^{1/4} = 0.27(5.599 \times 10^5)^{1/4} = 7.386$$

$$h_{\text{bottom}} = \frac{k}{L_c} Nu = \frac{0.01529 \text{ Btu/h}\cdot\text{ft}\cdot^\circ\text{F}}{0.2222 \text{ ft}} (7.386) = 0.5082 \text{ Btu/h}\cdot\text{ft}^2\cdot^\circ\text{F}$$

Vertical side surfaces: The characteristic length in this case is the height of the duct, $L_c = L = 6 \text{ in}$. Then,

$$Ra = \frac{g\beta(T_s - T_\infty)L_c^3}{\nu^2} \text{Pr} = \frac{(32.2 \text{ ft/s}^2)(0.001786 \text{ R}^{-1})(120 - 80 \text{ R})(0.5 \text{ ft})^3}{(0.1809 \times 10^{-3} \text{ ft}^2/\text{s})^2} (0.726) = 6.379 \times 10^6$$

$$Nu = \left\{ 0.825 + \frac{0.387Ra^{1/6}}{\left[1 + \left(\frac{0.492}{Pr} \right)^{9/16} \right]^{8/27}} \right\}^2 = \left\{ 0.825 + \frac{0.387(6.379 \times 10^6)^{1/6}}{\left[1 + \left(\frac{0.492}{0.726} \right)^{9/16} \right]^{8/27}} \right\}^2 = 27.57$$

$$h_{side} = \frac{k}{L} Nu = \frac{0.01529 \text{ Btu/h.ft.}^\circ\text{F}}{0.5 \text{ ft}} (27.57) = 0.843 \text{ Btu/h.ft}^2 \cdot ^\circ\text{F}$$

$$A_{side} = 2(4 \text{ ft})(0.5 \text{ ft}) = 4 \text{ ft}^2$$

Then the total heat loss from the duct can be expressed as

$$\dot{Q}_{total} = \dot{Q}_{top} + \dot{Q}_{bottom} + \dot{Q}_{side} = [(hA)_{top} + (hA)_{bottom} + (hA)_{side}](T_s - T_\infty)$$

Substituting and solving for the surface temperature,

$$272 \text{ Btu/h} = [(1.016 \times 2 + 0.5082 \times 2 + 0.843 \times 4) \text{ Btu/h.}^\circ\text{F}](T_s - 80)^\circ\text{F}$$

$$T_s = \mathbf{122.4^\circ\text{F}}$$

which is sufficiently close to the assumed value of 120°F used in the evaluation of properties and h . Therefore, there is no need to repeat the calculations.

9-113E The components of an electronic system located in a horizontal duct of circular cross section is cooled by forced air. The heat transfer from the outer surfaces of the duct by natural convection and the average temperature of the duct are to be determined.

Assumptions 1 Steady operating conditions exist. 2 Air is an ideal gas with constant properties. 3 The local atmospheric pressure is 1 atm. 4 Radiation effects are negligible. 5 The thermal resistance of the duct is negligible.

Properties The properties of air at 1 atm and the anticipated film temperature of $(T_s + T_\infty)/2 = (150 + 80)/2 = 115^\circ\text{F}$ are (Table A-15E)

$$k = 0.01564 \text{ Btu/h}\cdot\text{ft}\cdot^\circ\text{F}$$

$$\nu = 0.1895 \times 10^{-3} \text{ ft}^2/\text{s}$$

$$\text{Pr} = 0.7238$$

$$\beta = \frac{1}{T_f} = \frac{1}{(115 + 460) \text{ R}} = 0.001739 \text{ R}^{-1}$$

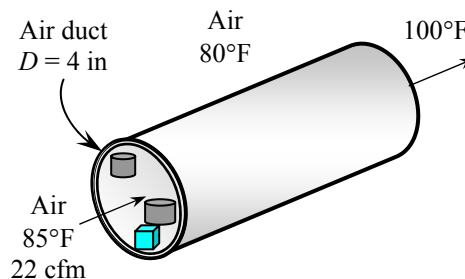

Analysis (a) Using air properties at the average temperature of $(85 + 100)/2 = 92.5^\circ\text{F}$ and 1 atm for the forced air, the mass flow rate of air and the heat transfer rate by forced convection are determined to be

$$\dot{m} = \rho \dot{V} = (0.07185 \text{ lbm/ft}^3)(22 \text{ ft}^3/\text{min}) = 1.581 \text{ lbm/min}$$

$$\dot{Q}_{\text{forced}} = \dot{m} c_p (T_{\text{out}} - T_{\text{in}}) = (1.581 \times 60 \text{ lbm/h})(0.2404 \text{ Btu/lbm}\cdot^\circ\text{F})(100 - 85)^\circ\text{F} = 342.1 \text{ Btu/h}$$

Noting that radiation heat transfer is negligible, the rest of the 180 W heat generated must be dissipated by natural convection,

$$\dot{Q}_{\text{natural}} = \dot{Q}_{\text{total}} - \dot{Q}_{\text{forced}} = (180 \times 3.412) - 342.1 = \mathbf{272 \text{ Btu/h}}$$

(b) We start the calculations by “guessing” the surface temperature to be 150°F for the evaluation of the properties and h . We will check the accuracy of this guess later and repeat the calculations if necessary. The characteristic length in this case is the outer diameter of the duct, $L_c = D = 4 \text{ in}$. Then,

$$\text{Ra} = \frac{g\beta(T_1 - T_2)D^3}{\nu^2} \text{Pr} = \frac{(32.2 \text{ ft/s}^2)(0.001739 \text{ R}^{-1})(150 - 80 \text{ R})(4/12 \text{ ft})^3}{(0.1895 \times 10^{-3} \text{ ft}^2/\text{s})^2} (0.7238) = 2.926 \times 10^6$$

$$\text{Nu} = \left\{ 0.6 + \frac{0.387 \text{Ra}^{1/6}}{\left[1 + (0.559/\text{Pr})^{9/16} \right]^{8/27}} \right\}^2 = \left\{ 0.6 + \frac{0.387(2.926 \times 10^6)^{1/6}}{\left[1 + (0.559/0.7238)^{9/16} \right]^{8/27}} \right\}^2 = 19.79$$

$$h = \frac{k}{D} \text{Nu} = \frac{0.01564 \text{ Btu/h}\cdot\text{ft}\cdot^\circ\text{F}}{4/12 \text{ ft}} (19.79) = 0.9285 \text{ Btu/h}\cdot\text{ft}^2\cdot^\circ\text{F}$$

$$A_s = \pi DL = \pi(4/12 \text{ ft})(4 \text{ ft}) = 4.19 \text{ ft}^2$$

Then the surface temperature is determined to be

$$\dot{Q} = hA_s(T_s - T_\infty) \rightarrow T_s = T_\infty + \frac{\dot{Q}}{hA_s} = 80^\circ\text{F} + \frac{272 \text{ Btu/h}}{(0.9285 \text{ Btu/h}\cdot\text{ft}^2\cdot^\circ\text{F})(4.19 \text{ ft}^2)} = \mathbf{149.9^\circ\text{F}}$$

which is practically equal to the assumed value of 150°F used in the evaluation of properties and h . Therefore, there is no need to repeat the calculations.

9-114E The components of an electronic system located in a horizontal duct of rectangular cross section is cooled by natural convection. The heat transfer from the outer surfaces of the duct by natural convection and the average temperature of the duct are to be determined.

Assumptions 1 Steady operating conditions exist. 2 Air is an ideal gas with constant properties. 3 The local atmospheric pressure is 1 atm. 4 Radiation effects are negligible. 5 The thermal resistance of the duct is negligible.

Properties The properties of air at 1 atm and the anticipated film temperature of $(T_s + T_\infty)/2 = (160 + 80)/2 = 120^\circ\text{F}$ are (Table A-15E)

$$k = 0.01576 \text{ Btu/h}\cdot\text{ft}\cdot^\circ\text{F}$$

$$\nu = 0.1923 \times 10^{-3} \text{ ft}^2/\text{s}$$

$$\text{Pr} = 0.723$$

$$\beta = 1/T_f = 1/(120 + 460 \text{ R}) = 0.001724 \text{ R}^{-1}$$

Analysis (a) Noting that radiation heat transfer is negligible and no heat is removed by forced convection because of the failure of the fan, the entire 180 W heat generated must be dissipated by natural convection,

$$\dot{Q}_{\text{natural}} = \dot{Q}_{\text{total}} = \mathbf{180 \text{ W}}$$

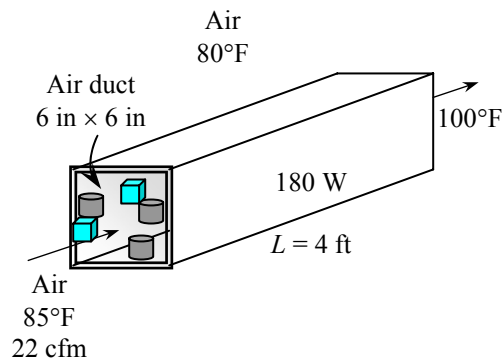

(b) We start the calculations by “guessing” the surface temperature to be 160°F for the evaluation of the properties and h . We will check the accuracy of this guess later and repeat the calculations if necessary.

Horizontal top surface: The characteristic length is $L_c = \frac{A_s}{p} = \frac{(4 \text{ ft})(6/12 \text{ ft})}{2(4 \text{ ft} + 6/12 \text{ ft})} = 0.2222 \text{ ft}$. Then,

$$Ra = \frac{g\beta(T_s - T_\infty)L_c^3}{\nu^2} \text{Pr} = \frac{(32.2 \text{ ft/s}^2)(0.001724 \text{ R}^{-1})(160 - 80 \text{ R})(0.2222 \text{ ft})^3}{(0.1923 \times 10^{-3} \text{ ft}^2/\text{s})^2} (0.723) = 9.534 \times 10^5$$

$$Nu = 0.54Ra^{1/4} = 0.54(9.534 \times 10^5)^{1/4} = 16.87$$

$$h_{\text{top}} = \frac{k}{L_c} Nu = \frac{0.01576 \text{ Btu/h}\cdot\text{ft}\cdot^\circ\text{F}}{0.2222 \text{ ft}} (16.87) = 1.197 \text{ Btu/h}\cdot\text{ft}^2\cdot^\circ\text{F}$$

$$A_{\text{top}} = (4 \text{ ft})(6/12 \text{ ft}) = 2 \text{ ft}^2 = A_{\text{bottom}}$$

Horizontal bottom surface: The Nusselt number for this geometry and orientation can be determined from

$$Nu = 0.27Ra^{1/4} = 0.27(9.534 \times 10^5)^{1/4} = 8.437$$

$$h_{\text{bottom}} = \frac{k}{L_c} Nu = \frac{0.01576 \text{ Btu/h}\cdot\text{ft}\cdot^\circ\text{F}}{0.2222 \text{ ft}} (8.437) = 0.5983 \text{ Btu/h}\cdot\text{ft}^2\cdot^\circ\text{F}$$

Vertical side surfaces: The characteristic length in this case is the height of the duct, $L_c = L = 6 \text{ in}$. Then,

$$Ra = \frac{g\beta(T_s - T_\infty)L_c^3}{\nu^2} \text{Pr} = \frac{(32.2 \text{ ft/s}^2)(0.001724 \text{ R}^{-1})(160 - 80 \text{ R})(0.5 \text{ ft})^3}{(0.1923 \times 10^{-3} \text{ ft}^2/\text{s})^2} (0.723) = 1.086 \times 10^7$$

$$Nu = \left\{ 0.825 + \frac{0.387Ra^{1/6}}{\left[1 + \left(\frac{0.492}{\text{Pr}} \right)^{9/16} \right]^{8/27}} \right\}^2 = \left\{ 0.825 + \frac{0.387(1.086 \times 10^7)^{1/6}}{\left[1 + \left(\frac{0.492}{0.723} \right)^{9/16} \right]^{8/27}} \right\}^2 = 32.03$$

$$h_{side} = \frac{k}{L} Nu = \frac{0.01576 \text{ Btu/h.ft.}^\circ\text{F}}{0.5 \text{ ft}} (32.03) = 1.009 \text{ Btu/h.ft}^2 \cdot ^\circ\text{F}$$

$$A_{side} = 2(4 \text{ ft})(0.5 \text{ ft}) = 4 \text{ ft}^2$$

Then the total heat loss from the duct can be expressed as

$$\dot{Q}_{total} = \dot{Q}_{top} + \dot{Q}_{bottom} + \dot{Q}_{side} = [(hA)_{top} + (hA)_{bottom} + (hA)_{side}](T_s - T_\infty)$$

Substituting and solving for the surface temperature,

$$180 \text{ W} \left(\frac{3.41214 \text{ Btu/h}}{1 \text{ W}} \right) = [(1.197 \times 2 + 0.5983 \times 2 + 1.009 \times 4) \text{ Btu/h.}^\circ\text{F}](T_s - 80)^\circ\text{F}$$

$$T_s = \mathbf{160.5^\circ\text{F}}$$

which is sufficiently close to the assumed value of 160°F used in the evaluation of properties and h . Therefore, there is no need to repeat the calculations.

9-115 A cold aluminum canned drink is exposed to ambient air. The time it will take for the average temperature to rise to a specified value is to be determined.

Assumptions 1 Steady operating conditions exist. **2** Air is an ideal gas with constant properties. **3** The local atmospheric pressure is 1 atm. **4** Any heat transfer from the bottom surface of the can is disregarded. **5** The thermal resistance of the can is negligible.

Properties The properties of air at 1 atm and the anticipated film temperature of $(T_s + T_\infty)/2 = (6 + 25)/2 = 15.5^\circ\text{C}$ are (Table A-15)

$$k = 0.0248 \text{ W/m}\cdot^\circ\text{C}$$

$$\nu = 1.475 \times 10^{-5} \text{ m}^2/\text{s}$$

$$\text{Pr} = 0.7322$$

$$\beta = 1/T_f = 1/(15.5 + 273 \text{ K}) = 0.003466 \text{ K}^{-1}$$

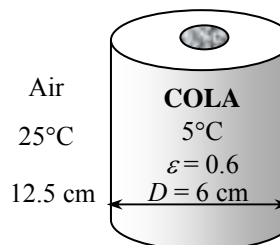

Analysis We assume the surface temperature of aluminum can to be equal to the temperature of the drink in the can since the can is made of a very thin layer of aluminum. Noting that the temperature of the drink rises from 5°C to 7°C , we take the average surface temperature to be 6°C . The characteristic length in this case is the height of the box $L_c = L = 0.125 \text{ m}$. Then,

$$\text{Ra} = \frac{g\beta(T_\infty - T_s)L^3}{\nu^2} \text{Pr} = \frac{(9.81 \text{ m/s}^2)(0.003466 \text{ K}^{-1})(25 - 6 \text{ K})(0.125 \text{ m})^3}{(1.475 \times 10^{-5} \text{ m}^2/\text{s})^2} (0.7322) = 4.246 \times 10^6$$

At this point we should check if we can treat this aluminum can as a vertical plate. The criteria is

$$D \geq \frac{35L}{\text{Gr}^{1/4}} \longrightarrow \frac{35(12.5 \text{ cm})}{(4.246 \times 10^6 / 0.7322)^{1/4}} = 8.92 \text{ cm}$$

which is not smaller than the diameter of the can (6 cm), but close to it. Therefore, we can still use vertical plate relation approximately (besides, we do not have another relation available). Then

$$\text{Nu} = \left\{ 0.825 + \frac{0.387\text{Ra}^{1/6}}{\left[1 + \left(\frac{0.492}{\text{Pr}} \right)^{9/16} \right]^{8/27}} \right\}^2 = \left\{ 0.825 + \frac{0.387(4.246 \times 10^6)^{1/6}}{\left[1 + \left(\frac{0.492}{0.7322} \right)^{9/16} \right]^{8/27}} \right\}^2 = 24.63$$

$$h = \frac{k}{L} \text{Nu} = \frac{0.0248 \text{ W/m}\cdot^\circ\text{C}}{0.125 \text{ m}} (24.63) = 4.887 \text{ W/m}^2\cdot^\circ\text{C}$$

$$A_s = \pi DL + \frac{\pi D^2}{4} = \pi(0.06 \text{ m})(0.125 \text{ m}) + \frac{\pi(0.06 \text{ m})^2}{4} = 0.02639 \text{ m}^2$$

Note that we also include top surface area of the can to the total surface area, and assume the heat transfer coefficient for that area to be the same for simplicity (actually, it will be a little lower). Then heat transfer rate from outer surfaces of the can by natural convection becomes

$$\dot{Q} = hA_s(T_\infty - T_s) = (4.887 \text{ W/m}^2\cdot^\circ\text{C})(0.02639 \text{ m}^2)(25 - 6)^\circ\text{C} = 2.45 \text{ W}$$

The radiation heat loss is

$$\dot{Q}_{\text{rad}} = \varepsilon A_s \sigma (T_{\text{surr}}^4 - T_s^4) = (0.6)(0.02639 \text{ m}^2)(5.67 \times 10^{-8} \text{ W/m}^2\cdot\text{K}^4)[(298 \text{ K})^4 - (6 + 273 \text{ K})^4] = 1.64 \text{ W}$$

and $\dot{Q}_{\text{total}} = 2.41 + 1.64 = 4.09 \text{ W}$

Using the properties of water for the cold drink at 6°C , the amount of heat transfer to the drink is

$$m = \rho \mathcal{V} = \rho \frac{\pi D^2}{4} L = (999.9 \text{ kg/m}^3) \frac{\pi(0.06 \text{ m})^2}{4} (0.125 \text{ m}) = 0.3534 \text{ kg}$$

$$Q = mc_p(T_2 - T_1) = (0.3534 \text{ kg})(4203 \text{ J/kg}\cdot^\circ\text{C})(7 - 5)^\circ\text{C} = 2971 \text{ J}$$

Then the time required for the temperature of the cold drink to rise to 7°C becomes

$$Q = \dot{Q} \Delta t \longrightarrow \Delta t = \frac{Q}{\dot{Q}} = \frac{2971 \text{ J}}{4.09 \text{ J/s}} = 726 \text{ s} = \mathbf{12.1 \text{ min}}$$

9-116 An electric hot water heater is located in a small room. A hot water tank insulation kit is available for \$60. The payback period of this insulation to pay for itself from the energy it saves is to be determined.

Assumptions 1 Steady operating conditions exist. 2 Air is an ideal gas with constant properties. 3 The local atmospheric pressure is 1 atm. 4 Any heat transfer from the top and bottom surfaces of the tank is disregarded. 5 The thermal resistance of the metal sheet is negligible.

Properties The properties of air at 1 atm and the film temperature of $(T_s + T_\infty)/2 = (40 + 20)/2 = 30^\circ\text{C}$ are (Table A-15)

$$k = 0.02588 \text{ W/m}\cdot^\circ\text{C}$$

$$\nu = 1.608 \times 10^{-5} \text{ m}^2/\text{s}$$

$$\text{Pr} = 0.7282$$

$$\beta = \frac{1}{T_f} = \frac{1}{(30 + 273)\text{K}} = 0.0033 \text{ K}^{-1}$$

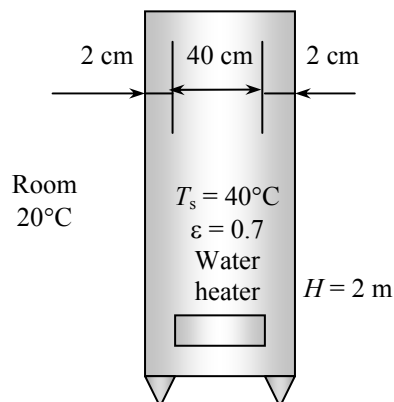

Analysis The characteristic length in this case is the height of the heater, $L_c = L = 2 \text{ m}$. Then,

$$\text{Ra} = \frac{g\beta(T_\infty - T_s)L^3}{\nu^2} \text{Pr} = \frac{(9.81 \text{ m/s}^2)(0.0033 \text{ K}^{-1})(40 - 20 \text{ K})(2 \text{ m})^3}{(1.608 \times 10^{-5} \text{ m}^2/\text{s})^2} (0.7282) = 1.459 \times 10^{10}$$

$$\text{Nu} = \left\{ 0.825 + \frac{0.387\text{Ra}^{1/6}}{\left[1 + \left(\frac{0.492}{\text{Pr}} \right)^{9/16} \right]^{8/27}} \right\}^2 = \left\{ 0.825 + \frac{0.387(1.459 \times 10^{10})^{1/6}}{\left[1 + \left(\frac{0.492}{0.7282} \right)^{9/16} \right]^{8/27}} \right\}^2 = 285.4$$

$$h = \frac{k}{L} \text{Nu} = \frac{0.02588 \text{ W/m}\cdot^\circ\text{C}}{2 \text{ m}} (285.4) = 3.693 \text{ W/m}^2\cdot^\circ\text{C}$$

$$A_s = \pi DL = \pi(0.44 \text{ m})(2 \text{ m}) = 2.765 \text{ m}^2$$

$$\text{and } \dot{Q} = hA_s(T_\infty - T_s) = (3.693 \text{ W/m}^2\cdot^\circ\text{C})(2.765 \text{ m}^2)(40 - 20)^\circ\text{C} = 204.2 \text{ W}$$

The radiation heat loss is

$$\begin{aligned} \dot{Q}_{\text{rad}} &= \varepsilon A_s \sigma (T_{\text{surr}}^4 - T_s^4) \\ &= (0.7)(2.765 \text{ m}^2)(5.67 \times 10^{-8} \text{ W/m}^2\cdot\text{K}^4)[(40 + 273 \text{ K})^4 - (20 + 273 \text{ K})^4] = 244.5 \text{ W} \end{aligned}$$

$$\text{and } \dot{Q}_{\text{total}} = 204.2 + 244.5 = 448.7 \text{ W}$$

The reduction in heat loss after adding insulation is

$$\dot{Q} = (0.80)(448.7) = 359.0 \text{ W}$$

The amount of heat and money saved per hour is

$$Q_{\text{saved}} = \dot{Q}_{\text{saved}} \Delta t = (0.3590 \text{ kW})(1 \text{ h}) = 0.3590 \text{ kWh}$$

$$\text{Money saved} = (0.3590 \text{ kWh})(\$0.08/\text{kWh}) = \$0.02872$$

$$\text{Then it will take } \Delta t = \frac{\$60}{\$0.02872} = 2089 \text{ h} = \mathbf{87.0 \text{ days}}$$

for the additional insulation to pay for itself from the energy it saves.

9-117 A hot part of the vertical front section of a natural gas furnace in a plant is considered. The rate of heat loss from this section and the annual cost of this heat loss are to be determined.

Assumptions 1 Steady operating conditions exist. 2 Air is an ideal gas with constant properties. 3 The local atmospheric pressure is 1 atm. 4 Any heat transfer from other surfaces of the tank is disregarded.

Properties The properties of air at 1 atm and the film temperature of $(T_s + T_\infty)/2 = (110 + 25)/2 = 67.5^\circ\text{C}$ are (Table A-15)

$$k = 0.02863 \text{ W/m}\cdot^\circ\text{C}$$

$$\nu = 1.97 \times 10^{-5} \text{ m}^2/\text{s}$$

$$\text{Pr} = 0.7183$$

$$\beta = \frac{1}{T_f} = \frac{1}{(67.5 + 273)\text{K}} = 0.002937 \text{ K}^{-1}$$

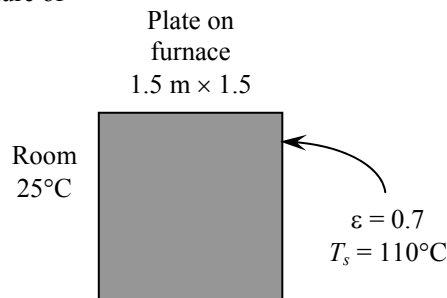

Analysis The characteristic length in this case is the height of that section of furnace, $L_c = L = 1.5 \text{ m}$. Then,

$$\text{Ra} = \frac{g\beta(T_s - T_\infty)L^3}{\nu^2} \text{Pr} = \frac{(9.81 \text{ m/s}^2)(0.002937 \text{ K}^{-1})(110 - 25 \text{ K})(1.5 \text{ m})^3}{(1.97 \times 10^{-5} \text{ m}^2/\text{s})^2} (0.7183) = 1.530 \times 10^{10}$$

$$\text{Nu} = \left\{ 0.825 + \frac{0.387\text{Ra}^{1/6}}{\left[1 + \left(\frac{0.492}{\text{Pr}} \right)^{9/16} \right]^{8/27}} \right\}^2 = \left\{ 0.825 + \frac{0.387(1.530 \times 10^{10})^{1/6}}{\left[1 + \left(\frac{0.492}{0.7183} \right)^{9/16} \right]^{8/27}} \right\}^2 = 289.1$$

$$h = \frac{k}{L} \text{Nu} = \frac{0.02863 \text{ W/m}\cdot^\circ\text{C}}{1.5 \text{ m}} (289.1) = 5.518 \text{ W/m}^2\cdot^\circ\text{C}$$

$$A_s = (1 \text{ m})(1.5 \text{ m}) = 1.5 \text{ m}^2$$

and

$$\dot{Q} = hA_s(T_s - T_\infty) = (5.518 \text{ W/m}^2\cdot^\circ\text{C})(1.5 \text{ m}^2)(110 - 25)^\circ\text{C} = 703.5 \text{ W}$$

The radiation heat loss is

$$\begin{aligned} \dot{Q}_{rad} &= \varepsilon A_s \sigma (T_{surr}^4 - T_s^4) \\ &= (0.7)(1.5 \text{ m}^2)(5.67 \times 10^{-8} \text{ W/m}^2\cdot\text{K}^4)[(110 + 273 \text{ K})^4 - (25 + 273 \text{ K})^4] = 812 \text{ W} \end{aligned}$$

$$\dot{Q}_{total} = 703.5 + 812 = \mathbf{1515 \text{ W}}$$

The amount and cost of natural gas used to overcome this heat loss per year is

$$Q_{gas} = \dot{Q}_{gas} \Delta t = \frac{\dot{Q}_{total}}{0.79} \Delta t = \frac{(1.515 \text{ kJ/s})}{0.79} (310 \text{ days/yr} \times 10 \text{ hr/day} \times 3600 \text{ s/hr}) = 2.14 \times 10^7 \text{ kJ}$$

$$\text{Cost} = (2.14 \times 10^7 / 105,500 \text{ therm})(\$1.20/\text{therm}) = \mathbf{\$243}$$

9-118 A group of 25 transistors are cooled by attaching them to a square aluminum plate and mounting the plate on the wall of a room. The required size of the plate to limit the surface temperature to 50°C is to be determined.

Assumptions 1 Steady operating conditions exist. 2 Air is an ideal gas with constant properties. 3 The local atmospheric pressure is 1 atm. 4 Any heat transfer from the back side of the plate is negligible.

Properties The properties of air at 1 atm and the film temperature of $(T_s + T_\infty)/2 = (50 + 30)/2 = 40^\circ\text{C}$ are (Table A-15)

$$k = 0.02662 \text{ W/m}\cdot^\circ\text{C}$$

$$\nu = 1.702 \times 10^{-5} \text{ m}^2/\text{s}$$

$$\text{Pr} = 0.7255$$

$$\beta = \frac{1}{T_f} = \frac{1}{(40 + 273)\text{K}} = 0.003195 \text{ K}^{-1}$$

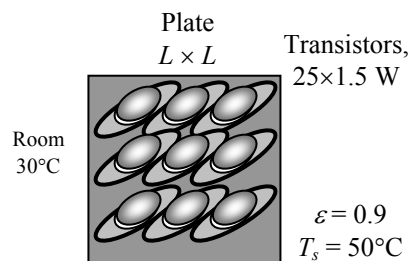

Analysis The Rayleigh number can be determined in terms of the characteristic length (length of the plate) to be

$$\text{Ra} = \frac{g\beta(T_\infty - T_s)L_c^3}{\nu^2} \text{Pr} = \frac{(9.81 \text{ m/s}^2)(0.003195 \text{ K}^{-1})(50 - 30 \text{ K})(L)^3}{(1.702 \times 10^{-5} \text{ m}^2/\text{s})^2} (0.7255) = 1.571 \times 10^9 L^3$$

The Nusselt number relation is

$$\text{Nu} = \left\{ 0.825 + \frac{0.387\text{Ra}^{1/6}}{\left[1 + \left(\frac{0.492}{\text{Pr}} \right)^{9/16} \right]^{8/27}} \right\}^2 = \left\{ 0.825 + \frac{0.387(1.571 \times 10^9 L^3)^{1/6}}{\left[1 + \left(\frac{0.492}{0.7255} \right)^{9/16} \right]^{8/27}} \right\}^2$$

The heat transfer coefficient is

$$h = \frac{k}{L} \text{Nu} = \frac{0.02662 \text{ W/m}\cdot^\circ\text{C}}{L} \text{Nu}$$

$$A_s = L^2$$

Noting that both the surface and surrounding temperatures are known, the rate of convection and radiation heat transfer are expressed as

$$\dot{Q}_{\text{conv}} = hA_s(T_s - T_\infty) = \frac{0.02662 \text{ W/m}\cdot^\circ\text{C}}{L} \text{Nu}L^2 (50 - 30)^\circ\text{C}$$

$$\dot{Q}_{\text{rad}} = \varepsilon A_s \sigma (T_s^4 - T_{\text{sky}}^4) = (0.9)L^2 (5.67 \times 10^{-8} \text{ W/m}^2 \cdot \text{K}^4) [(50 + 273)^4 - (30 + 273)^4] \text{K}^4 = 125.3L^2$$

The rate of total heat transfer is expressed as

$$\begin{aligned} \dot{Q}_{\text{total}} &= \dot{Q}_{\text{conv}} + \dot{Q}_{\text{rad}} \\ 25 \times (1.5 \text{ W}) &= \frac{0.02662 \text{ W/m}\cdot^\circ\text{C}}{L} \text{Nu}L^2 (50 - 30)^\circ\text{C} + 125.3L^2 \end{aligned}$$

Substituting Nusselt number expression above into this equation and solving for L , the length of the plate is determined to be

$$L = \mathbf{0.426 \text{ m}}$$

9-119 A group of 25 transistors are cooled by attaching them to a square aluminum plate and positioning the plate horizontally in a room. The required size of the plate to limit the surface temperature to 50°C is to be determined for two cases.

Assumptions 1 Steady operating conditions exist. **2** Air is an ideal gas with constant properties. **3** The local atmospheric pressure is 1 atm. **4** Any heat transfer from the back side of the plate is negligible.

Properties The properties of air at 1 atm and the film temperature of $(T_s + T_\infty)/2 = (50 + 30)/2 = 40^\circ\text{C}$ are (Table A-15)

$$k = 0.02662 \text{ W/m}\cdot^\circ\text{C}$$

$$\nu = 1.702 \times 10^{-5} \text{ m}^2/\text{s}$$

$$\text{Pr} = 0.7255$$

$$\beta = \frac{1}{T_f} = \frac{1}{(40 + 273)\text{K}} = 0.003195 \text{ K}^{-1}$$

Analysis The characteristic length and the Rayleigh number for the horizontal case are determined to be

$$L_c = \frac{A_s}{p} = \frac{L^2}{4L} = \frac{L}{4}$$

$$\text{Ra} = \frac{g\beta(T_\infty - T_s)L_c^3}{\nu^2} \text{Pr} = \frac{(9.81 \text{ m/s}^2)(0.003195 \text{ K}^{-1})(50 - 30 \text{ K})(L/4)^3}{(1.702 \times 10^{-5} \text{ m}^2/\text{s})^2} (0.7255) = 2.454 \times 10^7 L^3$$

Noting that both the surface and surrounding temperatures are known, the rate of radiation heat transfer is determined to be

$$\dot{Q}_{\text{rad}} = \varepsilon A_s \sigma (T_s^4 - T_{\text{sky}}^4) = (0.9)L^2 (5.67 \times 10^{-8} \text{ W/m}^2 \cdot \text{K}^4) [(50 + 273)^4 - (30 + 273)^4] \text{K}^4 = 125.3L^2$$

(a) **Hot surface facing up:** We assume $\text{Ra} < 10^7$ and thus $L < 0.74 \text{ m}$ so that we can determine the Nu number from Eq. 9-22. Then the Nusselt number and the convection heat transfer coefficient become

$$\text{Nu} = 0.54 \text{Ra}^{1/4} = 0.54(2.454 \times 10^7 L^3)^{1/4} = 38.0L^{3/4}$$

Then,

$$h = \frac{k}{L} \text{Nu} = \frac{0.02662 \text{ W/m}\cdot^\circ\text{C}}{L/4} (38.0L^{3/4}) = 4.047L^{-1/4} \text{ W/m}^2 \cdot ^\circ\text{C}$$

$$A_s = L^2$$

The rate of convection heat transfer is

$$\dot{Q}_{\text{conv}} = hA_s(T_s - T_\infty) = (4.047L^{-1/4})L^2(50 - 30) = 80.94L^{7/4} \text{ W}$$

Then,

$$\dot{Q}_{\text{total}} = \dot{Q}_{\text{conv}} + \dot{Q}_{\text{rad}} \longrightarrow 25 \times (1.5 \text{ W}) = 80.94L^{7/4} + 125.3L^2 \text{ W}$$

Solving for L , the length of the plate is determined to be

$$L = \mathbf{0.407 \text{ m}}$$

Note that $L < 0.75 \text{ m}$, and therefore the assumption of $\text{Ra} < 10^7$ is verified. That is,

(b) **Hot surface facing down:** The Nusselt number in this case is determined from

$$\text{Nu} = 0.27 \text{Ra}^{1/4} = 0.27(2.454 \times 10^7 L^3)^{1/4} = 19.0L^{3/4}$$

$$\text{Then, } h = \frac{k}{L_c} \text{Nu} = \frac{0.02662 \text{ W/m}\cdot^\circ\text{C}}{L/4} (19.0L^{3/4}) = 2.023L^{-1/4}$$

The rate of convection heat transfer is

$$\dot{Q}_{\text{conv}} = hA_s(T_s - T_\infty) = (2.023L^{-1/4})L^2(50 - 30) = 40.47L^{7/4} \text{ W}$$

Then,

$$\dot{Q}_{\text{total}} = \dot{Q}_{\text{conv}} + \dot{Q}_{\text{rad}} \longrightarrow 25 \times (1.5 \text{ W}) = 40.47L^{7/4} + 125.3L^2 \text{ W}$$

Solving for L , the length of the plate is determined to be

$$L = \mathbf{0.464 \text{ m}}$$

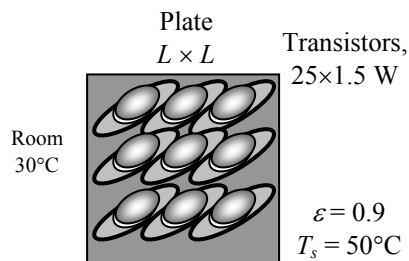

9-120E A hot water pipe passes through a basement. The temperature drop of water in the basement due to heat loss from the pipe is to be determined.

Assumptions 1 Steady operating conditions exist. 2 Air is an ideal gas with constant properties. 3 The local atmospheric pressure is 1 atm.

Properties The properties of air at 1 atm and the anticipated film temperature of $(T_s + T_\infty)/2 = (150 + 60)/2 = 105^\circ\text{F}$ are (Table A-15E)

$$k = 0.01541 \text{ Btu/h}\cdot\text{ft}\cdot^\circ\text{F}$$

$$\nu = 0.1838 \times 10^{-3} \text{ ft}^2/\text{s}$$

$$\text{Pr} = 0.7253$$

$$\beta = \frac{1}{T_f} = \frac{1}{(105 + 460)\text{R}} = 0.00177 \text{ R}^{-1}$$

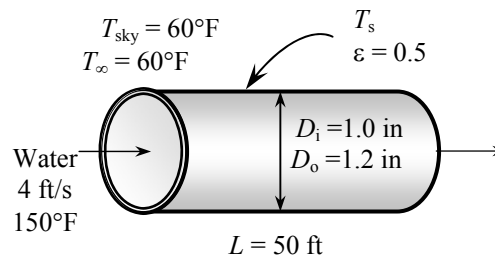

Analysis We expect the pipe temperature to be very close to the water temperature, and start the calculations by “guessing” the average outer surface temperature of the pipe to be 150°F for the evaluation of the properties and h . We will check the accuracy of this guess later and repeat the calculations if necessary. The characteristic length in this case is the outer diameter of the pipe, $L_c = D_o = 1.2$ in. Then,

$$Ra = \frac{g\beta(T_\infty - T_s)D_o^3}{\nu^2} \text{Pr} = \frac{(32.2 \text{ ft/s}^2)(0.00177 \text{ R}^{-1})(150 - 60 \text{ R})(1.2/12 \text{ ft})^3}{(0.1838 \times 10^{-3} \text{ ft}^2/\text{s})^2} (0.7253) = 1.101 \times 10^5$$

The natural convection Nusselt number can be determined from

$$Nu = \left\{ 0.6 + \frac{0.387 Ra^{1/6}}{\left[1 + (0.559/\text{Pr})^{9/16} \right]^{8/27}} \right\}^2 = \left\{ 0.6 + \frac{0.387(1.101 \times 10^5)^{1/6}}{\left[1 + (0.559/0.7253)^{9/16} \right]^{8/27}} \right\}^2 = 7.998$$

$$h_o = \frac{k}{D_o} Nu = \frac{0.01541 \text{ W/m}\cdot^\circ\text{C}}{(1.2/12) \text{ ft}} (7.998) = 1.232 \text{ Btu/h}\cdot\text{ft}^2\cdot^\circ\text{F}$$

$$A_i = \pi D_i L = \pi(1/12 \text{ ft})(50 \text{ ft}) = 13.09 \text{ ft}^2$$

$$A_o = \pi D_o L = \pi(1.2/12 \text{ ft})(50 \text{ ft}) = 15.708 \text{ ft}^2$$

Using the assumed value of glass temperature, the radiation heat transfer coefficient is determined to be

$$\begin{aligned} h_{rad} &= \varepsilon\sigma(T_s + T_{surr})(T_s^2 + T_{surr}^2) \\ &= (0.5)(0.1714 \times 10^{-8} \text{ Btu/h}\cdot\text{ft}^2\cdot\text{R}^4)[(150 + 460) + (60 + 460)][(150 + 460)^2 + (60 + 460)^2] \text{R}^3 \\ &= 0.6222 \text{ Btu/ft}^2\cdot\text{R} \end{aligned}$$

Then the combined convection and radiation heat transfer coefficient outside becomes

$$h_{o,combined} = h_o + h_{rad} = 1.232 + 0.6222 = 1.854 \text{ Btu/ft}^2\cdot\text{R}$$

$$\text{and } \dot{Q} = \frac{T_{water} - T_\infty}{\frac{1}{h_i A_i} + \frac{\ln(D_o/D_i)}{4\pi k L} + \frac{1}{h_o A_o}} = \frac{150 - 60}{\frac{1}{(30)(13.09)} + \frac{\ln(1.2/1)}{4\pi(30)(50)} + \frac{1}{(1.854)(15.708)}} = 2440 \text{ Btu/h}$$

The mass flow rate of water

$$\dot{m} = \rho A_c V = (61.2 \text{ lbm/ft}^3) \left[\pi(1/12 \text{ ft})^2 / 4 \right] (4 \text{ ft/s}) = 1.335 \text{ lbm/s} = 4807 \text{ lbm/h}$$

Then the temperature drop of water as it flows through the pipe becomes

$$\dot{Q} = \dot{m} c_p \Delta T \rightarrow \Delta T = \frac{\dot{Q}}{\dot{m} c_p} = \frac{2440 \text{ Btu/h}}{(4807 \text{ lbm/h})(1.0 \text{ Btu/lbm}\cdot^\circ\text{F})} = \mathbf{0.51^\circ\text{F}}$$

9-121 A flat-plate solar collector placed horizontally on the flat roof of a house is exposed to the calm ambient air. The rate of heat loss from the collector by natural convection and radiation are to be determined.

Assumptions 1 Steady operating conditions exist. 2 Air is an ideal gas with constant properties. 3 The local atmospheric pressure is 1 atm.

Properties The properties of air at 1 atm and the film temperature of $(T_s + T_\infty)/2 = (42 + 8)/2 = 25^\circ\text{C}$ are (Table A-15)

$$k = 0.02551 \text{ W/m}\cdot^\circ\text{C}$$

$$\nu = 1.562 \times 10^{-5} \text{ m}^2/\text{s}$$

$$\text{Pr} = 0.7296$$

$$\beta = \frac{1}{T_f} = \frac{1}{(25 + 273)\text{K}} = 0.003356 \text{ K}^{-1}$$

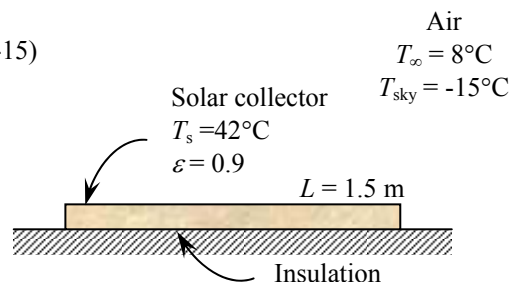

Analysis The characteristic length in this case is determined from

$$L_c = \frac{A_s}{p} = \frac{(1.5 \text{ m})(6 \text{ m})}{2(1.5 \text{ m} + 6 \text{ m})} = 0.6 \text{ m}$$

Then,

$$Ra = \frac{g\beta(T_\infty - T_s)L_c^3}{\nu^2} \text{Pr} = \frac{(9.81 \text{ m/s}^2)(0.003356 \text{ K}^{-1})(42 - 8 \text{ K})(0.6 \text{ m})^3}{(1.562 \times 10^{-5} \text{ m}^2/\text{s})^2} (0.7296) = 7.230 \times 10^8$$

$$Nu = 0.15Ra^{1/3} = 0.15(7.230 \times 10^8)^{1/3} = 134.6$$

$$h = \frac{k}{L_c} Nu = \frac{0.02551 \text{ W/m}\cdot^\circ\text{C}}{0.6 \text{ m}} (134.6) = 5.72 \text{ W/m}^2\cdot^\circ\text{C}$$

$$A_s = (1.5 \text{ m})(6 \text{ m}) = 9 \text{ m}^2$$

and

$$\dot{Q}_{conv} = hA_s(T_s - T_\infty) = (5.72 \text{ W/m}^2\cdot^\circ\text{C})(9 \text{ m}^2)(42 - 8)^\circ\text{C} = \mathbf{1750 \text{ W}}$$

Heat transfer rate by radiation is

$$\begin{aligned} \dot{Q}_{rad} &= \varepsilon A_s \sigma (T_{surr}^4 - T_s^4) \\ &= (0.9)(9 \text{ m}^2)(5.67 \times 10^{-8} \text{ W/m}^2\cdot\text{K}^4)[(42 + 273 \text{ K})^4 - (-15 + 273 \text{ K})^4] = \mathbf{2490 \text{ W}} \end{aligned}$$

9-122 A flat-plate solar collector tilted 40°C from the horizontal is exposed to the calm ambient air. The total rate of heat loss from the collector, the collector efficiency, and the temperature rise of water in the collector are to be determined.

Assumptions 1 Steady operating conditions exist. 2 Air is an ideal gas with constant properties. 3 The local atmospheric pressure is 1 atm. 4 There is no heat loss from the back surface of the absorber plate.

Properties The properties of air at 1 atm and the film temperature of $(T_s + T_\infty)/2 = (40 + 20)/2 = 30^\circ\text{C}$ are (Table A-15)

$$k = 0.02588 \text{ W/m}\cdot^\circ\text{C}$$

$$\nu = 1.608 \times 10^{-5} \text{ m}^2/\text{s}$$

$$\text{Pr} = 0.7282$$

$$\beta = \frac{1}{T_f} = \frac{1}{(30 + 273)\text{K}} = 0.0033 \text{ K}^{-1}$$

Analysis (a) The characteristic length in this case is determined from

$$L_c = \frac{A_s}{p} = \frac{(1.5 \text{ m})(2 \text{ m})}{2(1.5 \text{ m} + 2 \text{ m})} = 0.429 \text{ m}^2$$

Then,

$$\begin{aligned} Ra &= \frac{g\beta(T_\infty - T_s)L_c^3}{\nu^2} \text{Pr} \\ &= \frac{(9.81 \text{ m/s}^2)(\cos 40^\circ)(0.0033 \text{ K}^{-1})(40 - 20 \text{ K})(0.429 \text{ m})^3}{(1.608 \times 10^{-5} \text{ m}^2/\text{s})^2} (0.7282) = 1.103 \times 10^8 \end{aligned}$$

$$Nu = 0.15Ra^{1/3} = 0.15(1.103 \times 10^8)^{1/3} = 71.94$$

$$h = \frac{k}{L_s} Nu = \frac{0.02588 \text{ W/m}\cdot^\circ\text{C}}{0.429 \text{ m}} (71.94) = 4.340 \text{ W/m}^2\cdot^\circ\text{C}$$

$$A_s = (1.5 \text{ m})(2 \text{ m}) = 3 \text{ m}^2$$

and $\dot{Q}_{conv} = hA_s(T_s - T_\infty) = (4.340 \text{ W/m}^2\cdot^\circ\text{C})(3 \text{ m}^2)(40 - 20)^\circ\text{C} = 260.4 \text{ W}$

Heat transfer rate by radiation is

$$\begin{aligned} \dot{Q}_{rad} &= \varepsilon A_s \sigma (T_{surr}^4 - T_s^4) \\ &= (0.9)(3 \text{ m}^2)(5.67 \times 10^{-8} \text{ W/m}^2\cdot\text{K}^4)[(40 + 273 \text{ K})^4 - (-40 + 273 \text{ K})^4] = 1018 \text{ W} \end{aligned}$$

and $\dot{Q}_{total} = 260.4 + 1018 = \mathbf{1278 \text{ W}}$

(b) The solar energy incident on the collector is

$$\dot{Q}_{incident} = \alpha \dot{q} A_s = (0.88)(650 \text{ W/m}^2)(3 \text{ m}^2) = 1716 \text{ W}$$

Then the collector efficiency becomes

$$\text{efficiency} = \frac{\dot{Q}_{incident} - \dot{Q}_{lost}}{\dot{Q}_{incident}} = \frac{1716 - 1278}{1716} = 0.255 = \mathbf{25.5\%}$$

(c) The temperature rise of the water as it passes through the collector is

$$\dot{Q} = \dot{m} c_p \Delta T \rightarrow \Delta T = \frac{\dot{Q}}{\dot{m} c_p} = \frac{(1716 - 1278) \text{ W}}{(1/60 \text{ kg/s})(4180 \text{ J/kg}\cdot^\circ\text{C})} = \mathbf{6.3^\circ\text{C}}$$

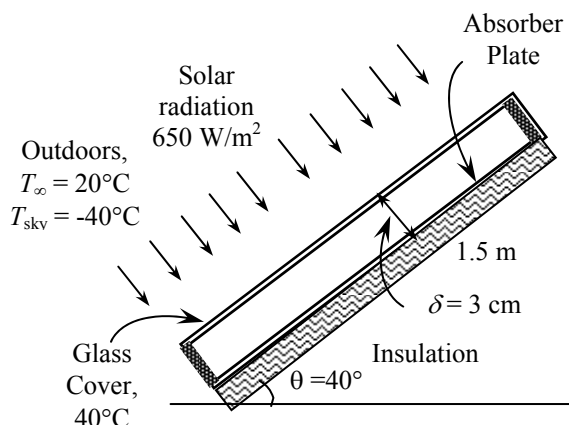

Fundamentals of Engineering (FE) Exam Problems

9-123 Consider a hot boiled egg in a spacecraft that is filled with air at atmospheric pressure and temperature at all times. Disregarding any radiation effect, will the egg cool faster or slower when the spacecraft is in space instead of on the ground?

- (a) faster (b) no difference (c) slower (d) insufficient information

Answer (c) slower [there is no gravity and thus no natural convection currents in space]

9-124 A hot object suspended by a string is to be cooled by natural convection in fluids whose volume changes differently with temperature at constant pressure. In which fluid will the rate of cooling be lowest?

With increasing temperature, a fluid whose volume

- (a) increases a lot (b) increases slightly (c) does not change (d) decreases slightly (e) decreases a lot

Answer (c) A fluid whose volume **does not change** [since there will be no natural convection currents in this case]

9-125 The primary driving force for natural convection is

- (a) shear stress forces (b) buoyancy forces (c) pressure forces
(d) surface tension forces (e) None of them

Answer (b) buoyancy forces

9-126 A spherical block of dry ice at -79°C is exposed to atmospheric air at 30°C . The general direction in which the air moves in this situation is

- (a) horizontal (b) up (c) down
(d) recirculation around the sphere (e) no motion

Answer (c) down

9-127 Consider a horizontal 0.7-m-wide and 0.85-m-long plate in a room at 30°C. Top side of the plate is insulated while the bottom side is maintained at 0°C. The rate of heat transfer from the room air to the plate by natural convection is

- (a) 36.8 W (b) 43.7 W (c) 128.5 W (d) 92.7 W (e) 69.7 W

(For air, use $k = 0.02476 \text{ W/m}\cdot\text{C}$, $Pr = 0.7323$, $\nu = 1.470 \times 10^{-5} \text{ m}^2/\text{s}$)

Answer (b) 43.7 W

Solution Solved by EES Software. Solutions can be verified by copying-and-pasting the following lines on a blank EES screen.

Width=0.7 [m]
Height=0.85 [m]
T_infinity=30 [C]
T_s=0 [C]

"The properties of air at $(0+30)/2 = 15 \text{ C}$ are (Table A-15)"

$k=0.02476 \text{ [W/m}\cdot\text{C]}$
 $\nu=1.470\text{E-}5 \text{ [m}^2/\text{s]}$
 $Pr=0.7323$
 $\beta=1/T_f$
 $T_f=(T_s+T_{\text{infinity}})/2+273$
 $g=9.81 \text{ [m/s}^2\text{]}$

$L=(\text{Width}\cdot\text{Height})/(2\cdot(\text{Width}+\text{Height}))$
 $Ra=(g\cdot\beta\cdot(T_{\text{infinity}}-T_s)\cdot L^3)/\nu^2\cdot Pr$
 $Nus=0.27\cdot Ra^{0.25}$
 $h=k/L\cdot Nus$
 $A_s=\text{Width}\cdot\text{Height}$
 $Q_{\text{dot}}=h\cdot A_s\cdot(T_{\text{infinity}}-T_s)$

9-128 Consider a 0.3-m-diameter, 1.8-m-long horizontal cylinder in a room at 20°C. If the outer surface temperature of the cylinder is 40°C, the natural convection heat transfer coefficient is

- (a) 3.0 W/m²·°C (b) 3.5 W/m²·°C (c) 3.9 W/m²·°C (d) 4.6 W/m²·°C (e) 5.7 W/m²·°C

(For air, use $k = 0.02588$ W/m·°C, $Pr = 0.7282$, $\nu = 1.608 \times 10^{-5}$ m²/s)

Answer (c) 3.9 W/m²·°C

Solution Solved by EES Software. Solutions can be verified by copying-and-pasting the following lines on a blank EES screen.

```
D=0.3 [m]
L=1.8 [m]
T_infinity=20 [C]
T_s=40 [C]
```

"The properties of air at (20+40)/2 = 30 C are (Table A-15)"

```
k=0.02588 [W/m-C]
nu=1.608E-5 [m^2/s]
Pr=0.7282
beta=1/T_f
T_f=(T_s+T_infinity)/2+273
g=9.81 [m/s^2]
```

```
Ra=(g*beta*(T_s-T_infinity)*D^3)/nu^2*Pr
Nus=((0.6+(0.387*Ra^(1/6)))/(1+(0.559/Pr)^(9/16))^(8/27))^2
h=k/D*Nus
```

9-129 A 4-m-diameter spherical tank contains iced water at 0°C. The tank is thin-shelled and thus its outer surface temperature may be assumed to be same as the temperature of the iced water inside. Now the tank is placed in a large lake at 20°C. The rate at which the ice melts is

- (a) 0.42 kg/s (b) 0.58 kg/s (c) 0.70 kg/s (d) 0.83 kg/s (e) 0.98 kg/s

(For lake water, use $k = 0.580 \text{ W/m}\cdot\text{°C}$, $Pr = 9.45$, $\nu = 0.1307 \times 10^{-5} \text{ m}^2/\text{s}$, $\beta = 0.138 \times 10^{-3} \text{ K}^{-1}$)

Answer (a) 0.42 kg/s

Solution Solved by EES Software. Solutions can be verified by copying-and-pasting the following lines on a blank EES screen.

D=4 [m]
T_infinity=20 [C]
T_s=0 [C]

"The properties of water at $(20+0)/2 = 10 \text{ C}$ are (Table A-9)"

k=0.580 [W/m-C]
nu=0.1307E-5 [m^2/s]
Pr=9.45
beta=0.138E-3 [1/K]
g=9.81 [m/s^2]

Ra=(g*beta*(T_infinity-T_s)*D^3)/nu^2*Pr
Nus=2+(0.589*Ra^(1/4))/(1+(0.469/Pr)^(9/16))^(4/9)
h=k/D*Nus
A_s=pi*D^2
Q_dot=h*A_s*(T_infinity-T_s)
h_if=333700 [J/kg]
m_dot_melt=Q_dot/h_if

9-130 A 4-m-long section of a 5-cm-diameter horizontal pipe in which a refrigerant flows passes through a room at 20°C. The pipe is not well insulated and the outer surface temperature of the pipe is observed to be -10°C. The emissivity of the pipe surface is 0.85 and the surrounding surfaces are at 15°C. The fraction of heat transferred to the pipe by radiation is

- (a) 0.24 (b) 0.30 (c) 0.37 (d) 0.48 (e) 0.58

(For air, use $k = 0.02401$ W/m·°C, $Pr = 0.735$, $\nu = 1.382 \times 10^{-5}$ m²/s)

Answer (c) 0.37

Solution Solved by EES Software. Solutions can be verified by copying-and-pasting the following lines on a blank EES screen.

```
L=4 [m]
D=0.05 [m]
T_infinity=20 [C]
T_s=-10 [C]
T_surr=15 [C]
epsilon=0.85
```

"The properties of air at $(20-10)/2 = 5$ C are (Table A-15)"

```
k=0.02401 [W/m-C]
nu=1.382E-5 [m^2/s]
Pr=0.7350
beta=1/T_f
T_f=(T_s+T_infinity)/2+273
g=9.81 [m/s^2]
sigma=5.67E-8 [W/m^2-K^4]
```

```
Ra=(g*beta*(T_infinity-T_s)*D^3)/nu^2*Pr
Nus=((0.6+(0.387*Ra^(1/6)))/(1+(0.559/Pr)^(9/16)))^(8/27))^2
h=k/D*Nus
A_s=pi*D*L
Q_dot_conv=h*A_s*(T_infinity-T_s)
Q_dot_rad=epsilon*A_s*sigma*((T_surr+273)^4-(T_s+273)^4)
f_rad=Q_dot_rad/(Q_dot_conv+Q_dot_rad)
```

"Some Wrong Solutions with Common Mistakes"

```
W_f_rad=Q_dot_rad/Q_dot_conv "Finding the ratio of radiation to convection"
```

9-131 A vertical 0.9-m-high and 1.8-m-wide double-pane window consists of two sheets of glass separated by a 2.2-cm air gap at atmospheric pressure. If the glass surface temperatures across the air gap are measured to be 20°C and 30°C, the rate of heat transfer through the window is

- (a) 19.8 W (b) 26.1 W (c) 30.5 W (d) 34.7 W (e) 55.0 W

(For air, use $k = 0.02551 \text{ W/m}\cdot\text{°C}$, $\text{Pr} = 0.7296$, $\nu = 1.562 \times 10^{-5} \text{ m}^2/\text{s}$. Also, the applicable correlation is $\text{Nu} = 0.42 \text{ Ra}^{1/4} \text{ Pr}^{0.012} (H/L)^{-0.3}$)

Answer (b) 26.1 W

Solution Solved by EES Software. Solutions can be verified by copying-and-pasting the following lines on a blank EES screen.

```
H=0.9 [m]
W=1.8 [m]
L=0.022 [m]
T1=30 [C]
T2=20 [C]
```

"The properties of air at $(20+30)/2 = 25 \text{ C}$ are (Table A-15)"

```
k=0.02551 [W/m-C]
nu=1.562E-5 [m^2/s]
Pr=0.7296
beta=1/T_ave
T_ave=(T1+T2)/2+273
g=9.81 [m/s^2]
```

```
Ra=(g*beta*(T1-T2)*L^3)/nu^2*Pr
Nus=0.42*Ra^(1/4)*Pr^0.012*(H/L)^(-0.3)
A_s=H*W
Q_dot=k*Nus*A_s*(T1-T2)/L
```

9-132 A horizontal 1.5-m-wide, 4.5-m-long double-pane window consists of two sheets of glass separated by a 3.5-cm gap filled with water. If the glass surface temperatures at the bottom and the top are measured to be 60°C and 40°C, respectively, the rate of heat transfer through the window is

- (a) 27.6 kW (b) 39.4 kW (c) 59.6 kW (d) 66.4 kW (e) 75.5 kW

(For water, use $k = 0.644 \text{ W/m}\cdot\text{°C}$, $\text{Pr} = 3.55$, $\nu = 0.554 \times 10^{-6} \text{ m}^2/\text{s}$, $\beta = 0.451 \times 10^{-3} \text{ K}^{-1}$. Also, the applicable correlation is $\text{Nu} = 0.069\text{Ra}^{1/3} \text{Pr}^{0.074}$).

Answer (d) 66.4 kW

Solution Solved by EES Software. Solutions can be verified by copying-and-pasting the following lines on a blank EES screen.

```
Width=1.5 [m]
Length=4.5 [m]
L=0.035 [m]
T1=60 [C]
T2=40 [C]
```

"The properties of water at $(60+40)/2 = 50 \text{ C}$ are (Table A-9)"

```
k=0.644 [W/m-C]
nu=0.554E-6 [m^2/s]
Pr=3.55
beta=0.451E-3 [1/K]
g=9.81 [m/s^2]
```

```
Ra=(g*beta*(T1-T2)*L^3)/nu^2*Pr
Nus=0.069*Ra^(1/3)*Pr^(0.074)
A_s=Width*Length
Q_dot=k*Nus*A_s*(T1-T2)/L
```

"Some Wrong Solutions with Common Mistakes"

```
W1_Nus=0.068*Ra^(1/3) "Relation for air gap, Eq. 9-45"
W1_Q_dot=k*W1_Nus*A_s*(T1-T2)/L
W2_Nus=0.195*Ra^(1/4) "Relation for air gap, Eq. 9-44"
W2_Q_dot=k*W2_Nus*A_s*(T1-T2)/L
```

9-133 Two concentric cylinders of diameters $D_i = 30$ cm and $D_o = 40$ cm and $L = 5$ m are separated by air at 1 atm pressure. Heat is generated within the inner cylinder uniformly at a rate of 1100 W/m³ and the inner surface temperature of the outer cylinder is 300 K. The steady-state outer surface temperature of the inner cylinder is

- (a) 402 K (b) 415 K (c) 429 K (d) 442 K (e) 456 K

(For air, use $k = 0.03095$ W/m \cdot °C, $Pr = 0.7111$, $\nu = 2.306 \times 10^{-5}$ m²/s.)

Answer (c) 429 K

Solution Solved by EES Software. Solutions can be verified by copying-and-pasting the following lines on a blank EES screen.

$D_i = 0.30$ [m]

$D_o = 0.40$ [m]

$L = 5$ [m]

$\dot{g} = 1100$ [W/m³]

$T_o = 300$ [K]

"The properties of air at 100 C are (Table A-15)"

$k = 0.03095$ [W/m-K]

$\nu = 2.306E-5$ [m²/s]

$Pr = 0.7111$

$\beta = 1/T_{ave}$

$T_{ave} = 100$ [C] + 273 [K]

$g = 9.81$ [m/s²]

$L_c = (D_o - D_i)/2$

$Ra = (g \cdot \beta \cdot (T_i - T_o) \cdot L_c^3) / (\nu^2 \cdot Pr)$

$F_{cyl} = (\ln(D_o/D_i))^4 / (L_c^3 \cdot (D_i^{-3/5} + D_o^{-3/5}))^5$

$k_{eff} = k \cdot 0.386 \cdot (Pr / (0.861 + Pr))^{0.25} \cdot (F_{cyl} \cdot Ra)^{0.25}$

$Vol = \pi \cdot D_i^2 / 4 \cdot L$

$\dot{Q} = \dot{g} \cdot Vol$

$\dot{Q} = (2 \cdot \pi \cdot k_{eff} / \ln(D_o/D_i)) \cdot (T_i - T_o)$

9-134 A vertical double-pane window consists of two sheets of glass separated by a 1.5-cm air gap at atmospheric pressure. The glass surface temperatures across the air gap are measured to be 278 K and 288 K. If it is estimated that the heat transfer by convection through the enclosure is 1.5 times that by pure conduction and that the rate of heat transfer by radiation through the enclosure is about the same magnitude as the convection, the effective emissivity of the two glass surfaces is

- (a) 0.47 (b) 0.53 (c) 0.61 (d) 0.65 (e) 0.72

Answer (a) 0.47

Solution Solved by EES Software. Solutions can be verified by copying-and-pasting the following lines on a blank EES screen.

```
L=0.015 [m]
T1=288 [C]
T2=278 [C]
Nus=1.5
```

"The properties of air at $(278+288)/2 = 283$ K = 10 C are (Table A-15)"

```
k=0.02439 [W/m-K]
sigma=5.67E-8 [W/m^2-K^4]
```

```
q_dot_conv=k*Nus*(T1-T2)/L
q_dot_rad=q_dot_conv
q_dot_rad=epsilon_eff*sigma*(T1^4-T2^4)
```

9-135 9-138 Design and Essay Problems



Chapter 10

BOILING AND CONDENSATION

Boiling Heat Transfer

10-1C Boiling is the liquid-to-vapor phase change process that occurs at a solid-liquid interface when the surface is heated above the saturation temperature of the liquid. The formation and rise of the bubbles and the liquid entrainment coupled with the large amount of heat absorbed during liquid-vapor phase change at essentially constant temperature are responsible for the very high heat transfer coefficients associated with nucleate boiling.

10-2C Yes. Otherwise we can create energy by alternately vaporizing and condensing a substance.

10-3C Both boiling and evaporation are liquid-to-vapor phase change processes, but evaporation occurs at the *liquid-vapor interface* when the vapor pressure is less than the saturation pressure of the liquid at a given temperature, and it involves no bubble formation or bubble motion. Boiling, on the other hand, occurs at the *solid-liquid interface* when a liquid is brought into contact with a surface maintained at a temperature T_s sufficiently above the saturation temperature T_{sat} of the liquid.

10-4C Boiling is called *pool boiling* in the absence of bulk fluid flow, and *flow boiling* (or *forced convection boiling*) in the presence of it. In pool boiling, the fluid is stationary, and any motion of the fluid is due to natural convection currents and the motion of the bubbles due to the influence of buoyancy.

10-5C Boiling is said to be *subcooled* (or *local*) when the bulk of the liquid is subcooled (i.e., the temperature of the main body of the liquid is below the saturation temperature T_{sat}), and *saturated* (or *bulk*) when the bulk of the liquid is saturated (i.e., the temperature of all the liquid is equal to T_{sat}).

10-6C The boiling curve is given in Figure 10-6 in the text. In the *natural convection boiling* regime, the fluid motion is governed by natural convection currents, and heat transfer from the heating surface to the fluid is by natural convection. In the *nucleate boiling* regime, bubbles form at various preferential sites on the heating surface, and rise to the top. In the *transition boiling* regime, part of the surface is covered by a vapor film. In the *film boiling* regime, the heater surface is completely covered by a continuous stable vapor film, and heat transfer is by combined convection and radiation.

10-7C In the *film boiling* regime, the heater surface is completely covered by a continuous stable vapor film, and heat transfer is by combined convection and radiation. In the nucleate boiling regime, the heater surface is covered by the liquid. The boiling heat flux in the stable film boiling regime can be higher or lower than that in the nucleate boiling regime, as can be seen from the boiling curve.

10-8C The boiling curve is given in Figure 10-6 in the text. The burnout point in the curve is point C. The *burnout* during boiling is caused by the heater surface being blanketed by a continuous layer of vapor film at increased heat fluxes, and the resulting rise in heater surface temperature in order to maintain the same heat transfer rate across a low-conducting vapor film. Any attempt to increase the heat flux beyond \dot{q}_{\max} will cause the operation point on the boiling curve to jump suddenly from point C to point E. However, the surface temperature that corresponds to point E is beyond the melting point of most heater materials, and burnout occurs. The burnout point is avoided in the design of boilers in order to avoid the disastrous explosions of the boilers.

10-9C Pool boiling heat transfer can be increased *permanently* by increasing the number of nucleation sites on the heater surface by *coating* the surface with a thin layer (much less than 1 mm) of very porous material, or by *forming cavities* on the surface mechanically to facilitate continuous vapor formation. Such surfaces are reported to enhance heat transfer in the nucleate boiling regime by a factor of up to 10, and the critical heat flux by a factor of 3. The use of finned surfaces is also known to enhance nucleate boiling heat transfer and the critical heat flux.

10-10C The different boiling regimes that occur in a vertical tube during flow boiling are forced convection of liquid, bubbly flow, slug flow, annular flow, transition flow, mist flow, and forced convection of vapor.

10-11 Water is boiled at $T_{\text{sat}} = 120^\circ\text{C}$ in a mechanically polished stainless steel pressure cooker whose inner surface temperature is maintained at $T_s = 130^\circ\text{C}$. The heat flux on the surface is to be determined.

Assumptions 1 Steady operating conditions exist. 2 Heat losses from the heater and the boiler are negligible.

Properties The properties of water at the saturation temperature of 120°C are (Tables 10-1 and A-9)

$$\begin{aligned}\rho_l &= 943.4 \text{ kg/m}^3 & h_{fg} &= 2203 \times 10^3 \text{ J/kg} \\ \rho_v &= 1.121 \text{ kg/m}^3 & \mu_l &= 0.232 \times 10^{-3} \text{ kg/m}\cdot\text{s} \\ \sigma &= 0.0550 \text{ N/m} & c_{p,l} &= 4244 \text{ J/kg}\cdot^\circ\text{C} \\ \text{Pr}_l &= 1.44\end{aligned}$$

Also, $C_{sf} = 0.0130$ and $n = 1.0$ for the boiling of water on a mechanically polished stainless steel surface (Table 10-3). Note that we expressed the properties in units specified under Eq. 10-2 in connection with their definitions in order to avoid unit manipulations.

Analysis The excess temperature in this case is $\Delta T = T_s - T_{\text{sat}} = 130 - 120 = 10^\circ\text{C}$ which is relatively low (less than 30°C). Therefore, nucleate boiling will occur. The heat flux in this case can be determined from Rohsenow relation to be

$$\begin{aligned}\dot{q}_{\text{nucleate}} &= \mu_l h_{fg} \left[\frac{g(\rho_l - \rho_v)}{\sigma} \right]^{1/2} \left(\frac{c_{p,l}(T_s - T_{\text{sat}})}{C_{sf} h_{fg} \text{Pr}_l^n} \right)^3 \\ &= (0.232 \times 10^{-3})(2203 \times 10^3) \left[\frac{9.81(943.4 - 1.121)}{0.0550} \right]^{1/2} \left(\frac{4244(130 - 120)}{0.0130(2203 \times 10^3)1.44} \right)^3 \\ &= 228,400 \text{ W/m}^2 = \mathbf{228.4 \text{ kW/m}^2}\end{aligned}$$

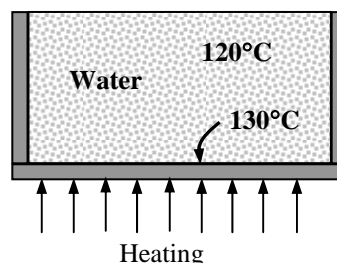

10-12 Water is boiled at the saturation (or boiling) temperature of $T_{\text{sat}} = 90^\circ\text{C}$ by a horizontal brass heating element. The maximum heat flux in the nucleate boiling regime is to be determined.

Assumptions 1 Steady operating conditions exist. 2 Heat losses from the boiler are negligible.

Properties The properties of water at the saturation temperature of 90°C are (Tables 10-1 and A-9)

$$\begin{aligned}\rho_l &= 965.3 \text{ kg/m}^3 & h_{fg} &= 2283 \times 10^3 \text{ J/kg} \\ \rho_v &= 0.4235 \text{ kg/m}^3 & \mu_l &= 0.315 \times 10^{-3} \text{ kg/m}\cdot\text{s} \\ \sigma &= 0.0608 \text{ N/m} & c_{pl} &= 4206 \text{ J/kg}\cdot^\circ\text{C} \\ \text{Pr}_l &= 1.96\end{aligned}$$

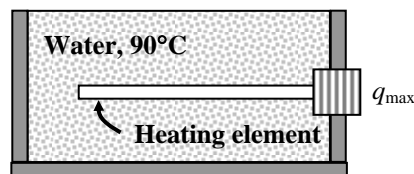

Also, $C_{sf} = 0.0060$ and $n = 1.0$ for the boiling of water on a brass heating (Table 10-3). Note that we expressed the properties in units specified under Eqs. 10-2 and 10-3 in connection with their definitions in order to avoid unit manipulations. For a large horizontal heating element, $C_{cr} = 0.12$ (Table 10-4). (It can be shown that $L^* = 1.38 > 1.2$ and thus the restriction in Table 10-4 is satisfied).

Analysis The maximum or critical heat flux is determined from

$$\begin{aligned}\dot{q}_{\text{max}} &= C_{cr} h_{fg} [\sigma g \rho_v^2 (\rho_l - \rho_v)]^{1/4} \\ &= 0.12(2283 \times 10^3) [0.0608 \times 9.81 \times (0.4235)^2 (965.3 - 0.4235)]^{1/4} \\ &= 873,200 \text{ W/m}^2 = \mathbf{873.2 \text{ kW/m}^2}\end{aligned}$$

10-13 Water is boiled at $T_{\text{sat}} = 90^\circ\text{C}$ in a brass heating element. The surface temperature of the heater is to be determined.

Assumptions 1 Steady operating conditions exist. 2 Heat losses from the heater and the boiler are negligible.

Properties The properties of water at the saturation temperature of 90°C are (Tables 10-1 and A-9)

$$\begin{aligned}\rho_l &= 965.3 \text{ kg/m}^3 & h_{fg} &= 2283 \times 10^3 \text{ J/kg} \\ \rho_v &= 0.4235 \text{ kg/m}^3 & \mu_l &= 0.315 \times 10^{-3} \text{ kg/m}\cdot\text{s} \\ \sigma &= 0.0608 \text{ N/m} & c_{pl} &= 4206 \text{ J/kg}\cdot^\circ\text{C} \\ \text{Pr}_l &= 1.96\end{aligned}$$

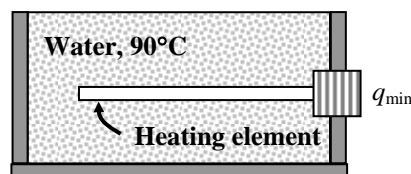

Also, $C_{sf} = 0.0060$ and $n = 1.0$ for the boiling of water on a brass heating (Table 10-3).

Analysis The minimum heat flux is determined from

$$\begin{aligned}\dot{q}_{\text{min}} &= 0.09 \rho_v h_{fg} \left[\frac{\sigma g (\rho_l - \rho_v)}{(\rho_l + \rho_v)^2} \right]^{1/4} \\ &= 0.09(0.4235)(2283 \times 10^3) \left[\frac{(0.0608)(9.81)(965.3 - 0.4235)}{(965.3 + 0.4235)^2} \right]^{1/4} = 13,715 \text{ W/m}^2\end{aligned}$$

The surface temperature can be determined from Rohsenow equation to be

$$\begin{aligned}\dot{q}_{\text{nucleate}} &= \mu_l h_{fg} \left[\frac{g(\rho_l - \rho_v)}{\sigma} \right]^{1/2} \left(\frac{c_{p,l}(T_s - T_{\text{sat}})}{C_{sf} h_{fg} \text{Pr}_l^n} \right)^3 \\ 13,715 \text{ W/m}^2 &= (0.315 \times 10^{-3})(2283 \times 10^3) \left[\frac{9.81(965.3 - 0.4235)}{0.0608} \right]^{1/2} \left(\frac{4206(T_s - 90)}{0.0060(2283 \times 10^3)(1.96)} \right)^3 \\ T_s &= \mathbf{92.3^\circ\text{C}}\end{aligned}$$

10-14 Water is boiled at 1 atm pressure and thus at a saturation (or boiling) temperature of $T_{\text{sat}} = 100^\circ\text{C}$ in a mechanically polished stainless steel pan whose inner surface temperature is maintained at $T_s = 110^\circ\text{C}$. The rate of heat transfer to the water and the rate of evaporation of water are to be determined.

Assumptions 1 Steady operating conditions exist. 2 Heat losses from the heater and the boiler are negligible.

Properties The properties of water at the saturation temperature of 100°C are (Tables 10-1 and A-9)

$$\rho_l = 957.9 \text{ kg/m}^3$$

$$\rho_v = 0.60 \text{ kg/m}^3$$

$$\sigma = 0.0589 \text{ N/m}$$

$$\text{Pr}_l = 1.75$$

$$h_{fg} = 2257 \times 10^3 \text{ J/kg}$$

$$\mu_l = 0.282 \times 10^{-3} \text{ kg} \cdot \text{m/s}$$

$$c_{pl} = 4217 \text{ J/kg} \cdot ^\circ\text{C}$$

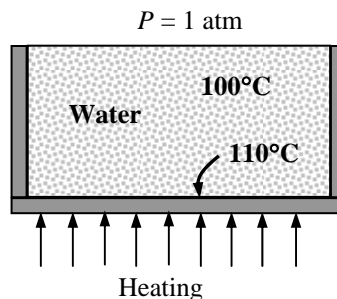

Also, $C_{sf} = 0.0130$ and $n = 1.0$ for the boiling of water on a mechanically polished stainless steel surface (Table 10-3). Note that we expressed the properties in units specified under Eq. 10-2 in connection with their definitions in order to avoid unit manipulations.

Analysis The excess temperature in this case is $\Delta T = T_s - T_{\text{sat}} = 110 - 100 = 10^\circ\text{C}$ which is relatively low (less than 30°C). Therefore, nucleate boiling will occur. The heat flux in this case can be determined from Rohsenow relation to be

$$\begin{aligned} \dot{q}_{\text{nucleate}} &= \mu_l h_{fg} \left[\frac{g(\rho_l - \rho_v)}{\sigma} \right]^{1/2} \left(\frac{c_{p,l}(T_s - T_{\text{sat}})}{C_{sf} h_{fg} \text{Pr}_l^n} \right)^3 \\ &= (0.282 \times 10^{-3})(2257 \times 10^3) \left[\frac{9.8(957.9 - 0.60)}{0.0589} \right]^{1/2} \left(\frac{4217(110 - 100)}{(0.0130)(2257 \times 10^3)1.75} \right)^3 \\ &= 140,700 \text{ W/m}^2 \end{aligned}$$

The surface area of the bottom of the pan is

$$A_s = \pi D^2 / 4 = \pi(0.30 \text{ m})^2 / 4 = 0.07069 \text{ m}^2$$

Then the rate of heat transfer during nucleate boiling becomes

$$\dot{Q}_{\text{boiling}} = A_s \dot{q}_{\text{nucleate}} = (0.07069 \text{ m}^2)(140,700 \text{ W/m}^2) = \mathbf{9945 \text{ W}}$$

(b) The rate of evaporation of water is determined from

$$\dot{m}_{\text{evaporation}} = \frac{\dot{Q}_{\text{boiling}}}{h_{fg}} = \frac{9945 \text{ J/s}}{2257 \times 10^3 \text{ J/kg}} = \mathbf{0.00441 \text{ kg/s}}$$

That is, water in the pan will boil at a rate of 4.4 grams per second.

10-15 Water is boiled at 1 atm pressure and thus at a saturation (or boiling) temperature of $T_{\text{sat}} = 100^\circ\text{C}$ by a mechanically polished stainless steel heating element. The maximum heat flux in the nucleate boiling regime and the surface temperature of the heater for that case are to be determined.

Assumptions 1 Steady operating conditions exist.

2 Heat losses from the boiler are negligible.

Properties The properties of water at the saturation temperature of 100°C are (Tables 10-1 and A-9)

$$\begin{aligned}\rho_l &= 957.9 \text{ kg/m}^3 & h_{fg} &= 2257 \times 10^3 \text{ J/kg} \\ \rho_v &= 0.60 \text{ kg/m}^3 & \mu_l &= 0.282 \times 10^{-3} \text{ kg} \cdot \text{m/s} \\ \sigma &= 0.0589 \text{ N/m} & c_{pl} &= 4217 \text{ J/kg} \cdot ^\circ\text{C} \\ \text{Pr}_l &= 1.75\end{aligned}$$

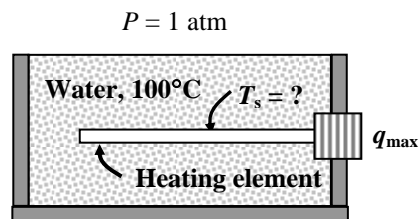

Also, $C_{sf} = 0.0130$ and $n = 1.0$ for the boiling of water on a mechanically polished stainless steel surface (Table 10-3). Note that we expressed the properties in units specified under Eqs. 10-2 and 10-3 in connection with their definitions in order to avoid unit manipulations. For a large horizontal heating element, $C_{cr} = 0.12$ (Table 10-4). (It can be shown that $L^* = 5.99 > 1.2$ and thus the restriction in Table 10-4 is satisfied).

Analysis The maximum or critical heat flux is determined from

$$\begin{aligned}\dot{q}_{\text{max}} &= C_{cr} h_{fg} [\sigma g \rho_v^2 (\rho_l - \rho_v)]^{1/4} \\ &= 0.12 (2257 \times 10^3) [0.0589 \times 9.8 \times (0.6)^2 (957.9 - 0.60)]^{1/4} \\ &= \mathbf{1,017,000 \text{ W/m}^2}\end{aligned}$$

The Rohsenow relation which gives the nucleate boiling heat flux for a specified surface temperature can also be used to determine the surface temperature when the heat flux is given. Substituting the maximum heat flux into the Rohsenow relation together with other properties gives

$$\begin{aligned}\dot{q}_{\text{nucleate}} &= \mu_l h_{fg} \left[\frac{g(\rho_l - \rho_v)}{\sigma} \right]^{1/2} \left(\frac{c_{p,l}(T_s - T_{\text{sat}})}{C_{sf} h_{fg} \text{Pr}_l^n} \right)^3 \\ 1,017,000 &= (0.282 \times 10^{-3})(2257 \times 10^3) \left[\frac{9.8(957.9 - 0.60)}{0.0589} \right]^{1/2} \left(\frac{4217(T_s - 100)}{(0.0130)(2257 \times 10^3)(1.75)} \right)^3\end{aligned}$$

It gives

$$T_s = \mathbf{119.3^\circ\text{C}}$$

Therefore, the temperature of the heater surface will be only 19.3°C above the boiling temperature of water when burnout occurs.

10-16 EES Prob. 10-15 is reconsidered. The effect of local atmospheric pressure on the maximum heat flux and the temperature difference $T_s - T_{\text{sat}}$ is to be investigated.

Analysis The problem is solved using EES, and the solution is given below.

"GIVEN"

D=0.003 [m]

P_sat=101.3 [kPa]

"PROPERTIES"

Fluid\$='steam_IAPWS'

T_sat=temperature(Fluid\$, P=P_sat, x=1)

rho_l=density(Fluid\$, T=T_sat, x=0)

rho_v=density(Fluid\$, T=T_sat, x=1)

sigma=SurfaceTension(Fluid\$, T=T_sat)

mu_l=Viscosity(Fluid\$, T=T_sat, x=0)

Pr_l=Prandtl(Fluid\$, T=T_sat, P=P_sat)

C_l=CP(Fluid\$, T=T_sat, x=0)

h_f=enthalpy(Fluid\$, T=T_sat, x=0)

h_g=enthalpy(Fluid\$, T=T_sat, x=1)

h_fg=h_g-h_f

C_sf=0.0130 "from Table 10-3 of the text"

n=1 "from Table 10-3 of the text"

C_cr=0.12 "from Table 10-4 of the text"

g=9.8 [m/s^2] "gravitational acceleraton"

"ANALYSIS"

q_dot_max=C_cr*h_fg*(sigma*g*rho_v^2*(rho_l-rho_v))^0.25

q_dot_nucleate=q_dot_max

q_dot_nucleate=mu_l*h_fg*(((g*(rho_l-rho_v))/sigma)^0.5)*((C_l*(T_s-T_sat))/(C_sf*h_fg*Pr_l^n))^3

DELTAT=T_s-T_sat

P _{sat} [kPa]	q _{max} [kW/m ²]	ΔT [C]
70	871.9	20.12
71.65	880.3	20.07
73.29	888.6	20.02
74.94	896.8	19.97
76.59	904.9	19.92
78.24	912.8	19.88
79.88	920.7	19.83
81.53	928.4	19.79
83.18	936.1	19.74
84.83	943.6	19.7
86.47	951.1	19.66
88.12	958.5	19.62
89.77	965.8	19.58
91.42	973	19.54
93.06	980.1	19.5
94.71	987.2	19.47
96.36	994.1	19.43
98.01	1001	19.4
99.65	1008	19.36
101.3	1015	19.33

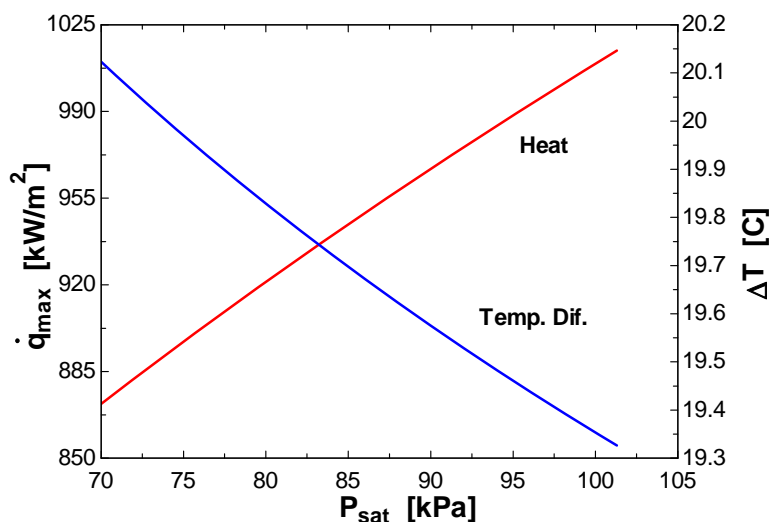

10-17E Water is boiled at 1 atm pressure and thus at a saturation (or boiling) temperature of $T_{\text{sat}} = 212^\circ\text{F}$ by a horizontal polished copper heating element whose surface temperature is maintained at $T_s = 788^\circ\text{F}$. The rate of heat transfer to the water per unit length of the heater is to be determined.

Assumptions 1 Steady operating conditions exist. 2 Heat losses from the boiler are negligible.

Properties The properties of water at the saturation temperature of 212°F are $\rho_l = 59.82 \text{ lbm/ft}^3$ and $h_{fg} = 970 \text{ Btu/lbm}$ (Table A-9E). The properties of the vapor at the film temperature of $T_f = (T_{\text{sat}} + T_s) / 2 = (212 + 788) / 2 = 500^\circ\text{F}$ are (Table A-16E)

$$\rho_v = 0.02571 \text{ lbm/ft}^3$$

$$\mu_v = 1.267 \times 10^{-5} \text{ lbm/ft} \cdot \text{s} = 0.04561 \text{ lbm/ft} \cdot \text{h}$$

$$c_{pv} = 0.4707 \text{ Btu/lbm} \cdot ^\circ\text{F}$$

$$k_v = 0.02267 \text{ Btu/h} \cdot \text{ft} \cdot ^\circ\text{F}$$

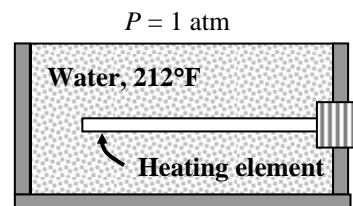

Also, $g = 32.2 \text{ ft/s}^2 = 32.2 \times (3600)^2 \text{ ft/h}^2$. Note that we expressed the properties in units that will cancel each other in boiling heat transfer relations. Also note that we used vapor properties at 1 atm pressure from Table A-16E instead of the properties of saturated vapor from Table A-9E since the latter are at the saturation pressure of 680 psia (46 atm).

Analysis The excess temperature in this case is $\Delta T = T_s - T_{\text{sat}} = 788 - 212 = 576^\circ\text{F}$, which is much larger than 30°C or 54°F . Therefore, film boiling will occur. The film boiling heat flux in this case can be determined to be

$$\begin{aligned} \dot{q}_{\text{film}} &= 0.62 \left[\frac{g k_v^3 \rho_v (\rho_l - \rho_v) [h_{fg} + 0.4 c_{pv} (T_s - T_{\text{sat}})]}{\mu_v D (T_s - T_{\text{sat}})} \right]^{1/4} (T_s - T_{\text{sat}}) \\ &= 0.62 \left[\frac{32.2 (3600)^2 (0.02267)^3 (0.02571) (59.82 - 0.02571) [970 + 0.4 \times 0.4707 (788 - 212)]}{(0.04561) (0.5 / 12) (788 - 212)} \right]^{1/4} (788 - 212) \\ &= 18,600 \text{ Btu/h} \cdot \text{ft}^2 \end{aligned}$$

The radiation heat flux is determined from

$$\begin{aligned} \dot{q}_{\text{rad}} &= \varepsilon \sigma (T_s^4 - T_{\text{sat}}^4) \\ &= (0.05) (0.1714 \times 10^{-8} \text{ Btu/h} \cdot \text{ft}^2 \cdot \text{R}^4) [(788 + 460 \text{ R})^4 - (212 + 460 \text{ R})^4] \\ &= 190 \text{ Btu/h} \cdot \text{ft}^2 \end{aligned}$$

Note that heat transfer by radiation is very small in this case because of the low emissivity of the surface and the relatively low surface temperature of the heating element. Then the total heat flux becomes

$$\dot{q}_{\text{total}} = \dot{q}_{\text{film}} + \frac{3}{4} \dot{q}_{\text{rad}} = 18,600 + \frac{3}{4} \times 190 = 18,743 \text{ Btu/h} \cdot \text{ft}^2$$

Finally, the rate of heat transfer from the heating element to the water is determined by multiplying the heat flux by the heat transfer surface area,

$$\begin{aligned} \dot{Q}_{\text{total}} &= A_s \dot{q}_{\text{total}} = (\pi DL) \dot{q}_{\text{total}} \\ &= (\pi \times 0.5 / 12 \text{ ft} \times 1 \text{ ft}) (18,743 \text{ Btu/h} \cdot \text{ft}^2) \\ &= \mathbf{2453 \text{ Btu/h}} \end{aligned}$$

10-18E Water is boiled at 1 atm pressure and thus at a saturation (or boiling) temperature of $T_{\text{sat}} = 212^\circ\text{F}$ by a horizontal polished copper heating element whose surface temperature is maintained at $T_s = 988^\circ\text{F}$. The rate of heat transfer to the water per unit length of the heater is to be determined.

Assumptions 1 Steady operating conditions exist. 2 Heat losses from the boiler are negligible.

Properties The properties of water at the saturation temperature of 212°F are $\rho_l = 59.82 \text{ lbm/ft}^3$ and $h_{fg} = 970 \text{ Btu/lbm}$ (Table A-9E). The properties of the vapor at the film temperature of $T_f = (T_{\text{sat}} + T_s) / 2 = (212 + 988) / 2 = 600^\circ\text{F}$ are, by interpolation, (Table A-16E)

$$\begin{aligned}\rho_v &= 0.02395 \text{ lbm/ft}^3 \\ \mu_v &= 1.416 \times 10^{-5} \text{ lbm/ft} \cdot \text{s} = 0.05099 \text{ lbm/ft} \cdot \text{h} \\ c_{pv} &= 0.4799 \text{ Btu/lbm} \cdot ^\circ\text{F} \\ k_v &= 0.02640 \text{ Btu/h} \cdot \text{ft} \cdot ^\circ\text{F}\end{aligned}$$

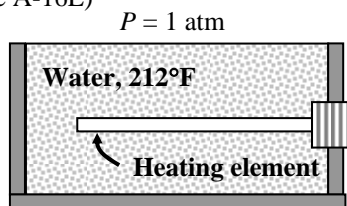

Also, $g = 32.2 \text{ ft/s}^2 = 32.2 \times (3600)^2 \text{ ft/h}^2$. Note that we expressed the properties in units that will cancel each other in boiling heat transfer relations. Also note that we used vapor properties at 1 atm pressure from Table A-16E instead of the properties of saturated vapor from Table A-9E since the latter are at the saturation pressure of 1541 psia (105 atm).

Analysis The excess temperature in this case is $\Delta T = T_s - T_{\text{sat}} = 988 - 212 = 776^\circ\text{F}$, which is much larger than 30°C or 54°F . Therefore, film boiling will occur. The film boiling heat flux in this case can be determined from

$$\begin{aligned}\dot{q}_{\text{film}} &= 0.62 \left[\frac{g k_v^3 \rho_v (\rho_l - \rho_v) [h_{fg} + 0.4 C_{pv} (T_s - T_{\text{sat}})]}{\mu_v D (T_s - T_{\text{sat}})} \right]^{1/4} (T_s - T_{\text{sat}}) \\ &= 0.62 \left[\frac{32.2 (3600)^2 (0.0264)^3 (0.02395) (59.82 - 0.02395) [970 + 0.4 \times 0.4799 (988 - 212)]}{(0.05099) (0.5 / 12) (988 - 212)} \right]^{1/4} (988 - 212) \\ &= 25,147 \text{ Btu/h} \cdot \text{ft}^2\end{aligned}$$

The radiation heat flux is determined from

$$\begin{aligned}\dot{q}_{\text{rad}} &= \varepsilon \sigma (T_s^4 - T_{\text{sat}}^4) \\ &= (0.05) (0.1714 \times 10^{-8} \text{ Btu/h} \cdot \text{ft}^2 \cdot \text{R}^4) [(988 + 460 \text{ R})^4 - (212 + 460 \text{ R})^4] \\ &= 359 \text{ Btu/h} \cdot \text{ft}^2\end{aligned}$$

Note that heat transfer by radiation is very small in this case because of the low emissivity of the surface and the relatively low surface temperature of the heating element. Then the total heat flux becomes

$$\dot{q}_{\text{total}} = \dot{q}_{\text{film}} + \frac{3}{4} \dot{q}_{\text{rad}} = 25,147 + \frac{3}{4} \times 359 = 25,416 \text{ Btu/h} \cdot \text{ft}^2$$

Finally, the rate of heat transfer from the heating element to the water is determined by multiplying the heat flux by the heat transfer surface area,

$$\begin{aligned}\dot{Q}_{\text{total}} &= A_s \dot{q}_{\text{total}} = (\pi DL) \dot{q}_{\text{total}} \\ &= (\pi \times 0.5 / 12 \text{ ft} \times 1 \text{ ft}) (25,416 \text{ Btu/h} \cdot \text{ft}^2) \\ &= \mathbf{3327 \text{ Btu/h}}\end{aligned}$$

10-19 Water is boiled at sea level (1 atm pressure) and thus at a saturation (or boiling) temperature of $T_{\text{sat}} = 100^\circ\text{C}$ in a mechanically polished AISI 304 stainless steel pan placed on top of a 3-kW electric burner. Only 60% of the heat (1.8 kW) generated is transferred to the water. The inner surface temperature of the pan and the temperature difference across the bottom of the pan are to be determined.

Assumptions 1 Steady operating conditions exist. 2 Heat losses from the boiler are negligible. 3 The boiling regime is nucleate boiling (this assumption will be checked later). 4 Heat transfer through the bottom of the pan is one-dimensional.

Properties The properties of water at the saturation temperature of 100°C are (Tables 10-1 and A-9)

$$\rho_l = 957.9 \text{ kg/m}^3$$

$$\rho_v = 0.60 \text{ kg/m}^3$$

$$\sigma = 0.0589 \text{ N/m}$$

$$\text{Pr}_l = 1.75$$

$$h_{fg} = 2257 \times 10^3 \text{ J/kg}$$

$$\mu_l = 0.282 \times 10^{-3} \text{ kg} \cdot \text{m/s}$$

$$c_{pl} = 4217 \text{ J/kg} \cdot ^\circ\text{C}$$

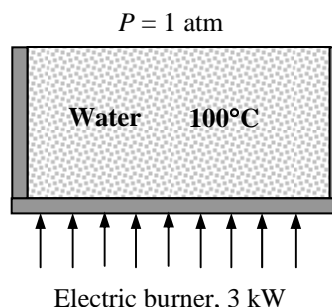

Also, $k_{\text{steel}} = 14.9 \text{ W/m} \cdot ^\circ\text{C}$ (Table A-3), $C_{sf} = 0.0130$ and $n = 1.0$ for the boiling of water on a mechanically polished stainless steel surface (Table 10-3). Note that we expressed the properties in units specified under Eq. 10-2 connection with their definitions in order to avoid unit manipulations.

Analysis The rate of heat transfer to the water and the heat flux are

$$\dot{Q} = 0.60 \times 3 \text{ kW} = 1.8 \text{ kW} = 1800 \text{ W}$$

$$A_s = \pi D^2 / 4 = \pi (0.30 \text{ m})^2 / 4 = 0.07069 \text{ m}^2$$

$$\dot{q} = \dot{Q} / A_s = (1800 \text{ W}) / (0.07069 \text{ m}^2) = 25.46 \text{ W/m}^2$$

Then temperature difference across the bottom of the pan is determined directly from the steady one-dimensional heat conduction relation to be

$$\dot{q} = k_{\text{steel}} \frac{\Delta T}{L} \rightarrow \Delta T = \frac{\dot{q}L}{k_{\text{steel}}} = \frac{(25,460 \text{ W/m}^2)(0.006 \text{ m})}{14.9 \text{ W/m} \cdot ^\circ\text{C}} = \mathbf{10.3^\circ\text{C}}$$

The Rohsenow relation which gives the nucleate boiling heat flux for a specified surface temperature can also be used to determine the surface temperature when the heat flux is given.

Assuming nucleate boiling, the temperature of the inner surface of the pan is determined from Rohsenow relation to be

$$\dot{q}_{\text{nucleate}} = \mu_l h_{fg} \left[\frac{g(\rho_l - \rho_v)}{\sigma} \right]^{1/2} \left(\frac{c_{p,l}(T_s - T_{\text{sat}})}{C_{sf} h_{fg} \text{Pr}_l^n} \right)^3$$

$$25,460 = (0.282 \times 10^{-3})(2257 \times 10^3) \left[\frac{9.81(957.9 - 0.60)}{0.0589} \right]^{1/2} \left(\frac{4217(T_s - 100)}{0.0130(2257 \times 10^3)1.75} \right)^3$$

It gives

$$T_s = \mathbf{105.7^\circ\text{C}}$$

which is in the nucleate boiling range (5 to 30°C above surface temperature). Therefore, the nucleate boiling assumption is valid.

10-20 Water is boiled at 84.5 kPa pressure and thus at a saturation (or boiling) temperature of $T_{\text{sat}} = 95^\circ\text{C}$ in a mechanically polished AISI 304 stainless steel pan placed on top of a 3-kW electric burner. Only 60% of the heat (1.8 kW) generated is transferred to the water. The inner surface temperature of the pan and the temperature difference across the bottom of the pan are to be determined.

Assumptions 1 Steady operating conditions exist. 2 Heat losses from the boiler are negligible. 3 The boiling regime is nucleate boiling (this assumption will be checked later). 4 Heat transfer through the bottom of the pan is one-dimensional.

Properties The properties of water at the saturation temperature of 95°C are (Tables 10-1 and A-9)

$$\rho_l = 961.5 \text{ kg/m}^3$$

$$\rho_v = 0.50 \text{ kg/m}^3$$

$$\sigma = 0.0599 \text{ N/m}$$

$$\text{Pr}_l = 1.85$$

$$h_{fg} = 2270 \times 10^3 \text{ J/kg}$$

$$\mu_l = 0.297 \times 10^{-3} \text{ kg} \cdot \text{m/s}$$

$$c_{pl} = 4212 \text{ J/kg} \cdot ^\circ\text{C}$$

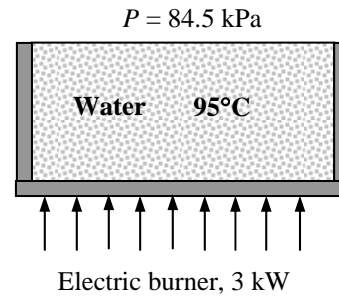

Also, $k_{\text{steel}} = 14.9 \text{ W/m} \cdot ^\circ\text{C}$ (Table A-3), $C_{sf} = 0.0130$ and $n = 1.0$ for the boiling of water on a mechanically polished stainless steel surface (Table 10-3). Note that we expressed the properties in units specified under Eq. 10-2 in connection with their definitions in order to avoid unit manipulations.

Analysis The rate of heat transfer to the water and the heat flux are

$$\dot{Q} = 0.60 \times 3 \text{ kW} = 1.8 \text{ kW} = 1800 \text{ W}$$

$$A_s = \pi D^2 / 4 = \pi (0.30 \text{ m})^2 / 4 = 0.07069 \text{ m}^2$$

$$\dot{q} = \dot{Q} / A_s = (1800 \text{ W}) / (0.07069 \text{ m}^2) = 25,460 \text{ W/m}^2 = 25.46 \text{ kW/m}^2$$

Then temperature difference across the bottom of the pan is determined directly from the steady one-dimensional heat conduction relation to be

$$\dot{q} = k_{\text{steel}} \frac{\Delta T}{L} \rightarrow \Delta T = \frac{\dot{q}L}{k_{\text{steel}}} = \frac{(25,460 \text{ W/m}^2)(0.006 \text{ m})}{14.9 \text{ W/m} \cdot ^\circ\text{C}} = \mathbf{10.3^\circ\text{C}}$$

The Rohsenow relation which gives the nucleate boiling heat flux for a specified surface temperature can also be used to determine the surface temperature when the heat flux is given.

Assuming nucleate boiling, the temperature of the inner surface of the pan is determined from Rohsenow relation to be

$$\dot{q}_{\text{nucleate}} = \mu_l h_{fg} \left[\frac{g(\rho_l - \rho_v)}{\sigma} \right]^{1/2} \left(\frac{c_{p,l}(T_s - T_{\text{sat}})}{C_{sf} h_{fg} \text{Pr}_l^n} \right)^3$$

$$25,460 = (0.297 \times 10^{-3})(2270 \times 10^3) \left[\frac{9.81(961.5 - 0.50)}{0.0599} \right]^{1/2} \left(\frac{4212(T_s - 95)}{(0.0130)(2270 \times 10^3)1.85} \right)^3$$

It gives

$$T_s = \mathbf{100.9^\circ\text{C}}$$

which is in the nucleate boiling range (5 to 30°C above surface temperature). Therefore, the nucleate boiling assumption is valid.

10-21 Water is boiled at sea level (1 atm pressure) and thus at a saturation (or boiling) temperature of $T_{\text{sat}} = 100^\circ\text{C}$ by a stainless steel heating element. The surface temperature of the heating element and its power rating are to be determined.

Assumptions **1** Steady operating conditions exist. **2** Heat losses from the coffee maker are negligible. **3** The boiling regime is nucleate boiling (this assumption will be checked later).

Properties The properties of water at the saturation temperature of 100°C are (Tables 10-1 and A-9)

$$\rho_l = 957.9 \text{ kg/m}^3$$

$$\rho_v = 0.60 \text{ kg/m}^3$$

$$\sigma = 0.0589 \text{ N/m}$$

$$\text{Pr}_l = 1.75$$

$$h_{fg} = 2257 \times 10^3 \text{ J/kg}$$

$$\mu_l = 0.282 \times 10^{-3} \text{ kg} \cdot \text{m/s}$$

$$c_{pl} = 4217 \text{ J/kg} \cdot ^\circ\text{C}$$

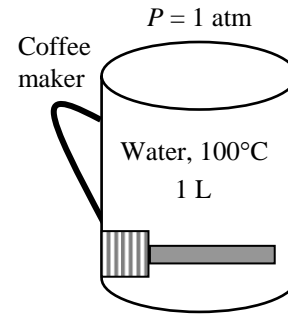

Also, $C_{sf} = 0.0130$ and $n = 1.0$ for the boiling of water on a stainless steel surface (Table 10-3). Note that we expressed the properties in units specified under Eq. 10-2 connection with their definitions in order to avoid unit manipulations.

Analysis The density of water at room temperature is very nearly 1 kg/L , and thus the mass of 1 L water at 18°C is nearly 1 kg . The rate of energy transfer needed to evaporate half of this water in 25 min and the heat flux are

$$Q = \dot{Q}\Delta t = mh_{fg} \rightarrow \dot{Q} = \frac{mh_{fg}}{\Delta t} = \frac{(0.5 \text{ kg})(2257 \text{ kJ/kg})}{(25 \times 60 \text{ s})} = 0.7523 \text{ kW}$$

$$A_s = \pi DL = \pi(0.04 \text{ m})(0.2 \text{ m}) = 0.02513 \text{ m}^2$$

$$\dot{q} = \dot{Q} / A_s = (0.7523 \text{ kW}) / (0.02513 \text{ m}^2) = 29.94 \text{ kW/m}^2 = 29,940 \text{ W/m}^2$$

The Rohsenow relation which gives the nucleate boiling heat flux for a specified surface temperature can also be used to determine the surface temperature when the heat flux is given.

Assuming nucleate boiling, the temperature of the inner surface of the pan is determined from Rohsenow relation to be

$$\dot{q}_{\text{nucleate}} = \mu_l h_{fg} \left[\frac{g(\rho_l - \rho_v)}{\sigma} \right]^{1/2} \left(\frac{c_{p,l}(T_s - T_{\text{sat}})}{C_{sf} h_{fg} \text{Pr}_l^n} \right)^3$$

$$29,940 = (0.282 \times 10^{-3})(2257 \times 10^3) \left[\frac{9.81(957.9 - 0.60)}{0.0589} \right]^{1/2} \left(\frac{4217(T_s - 100)}{0.0130(2257 \times 10^3)1.75} \right)^3$$

It gives

$$T_s = \mathbf{106.0^\circ\text{C}}$$

which is in the nucleate boiling range (5 to 30°C above surface temperature). Therefore, the nucleate boiling assumption is valid.

The specific heat of water at the average temperature of $(14+100)/2 = 57^\circ\text{C}$ is $c_p = 4.184 \text{ kJ/kg} \cdot ^\circ\text{C}$. Then the time it takes for the entire water to be heated from 14°C to 100°C is determined to be

$$Q = \dot{Q}\Delta t = mc_p \Delta T \rightarrow \Delta t = \frac{mc_p \Delta T}{\dot{Q}} = \frac{(1 \text{ kg})(4.184 \text{ kJ/kg} \cdot ^\circ\text{C})(100 - 14)^\circ\text{C}}{0.7523 \text{ kJ/s}} = 478 \text{ s} = \mathbf{7.97 \text{ min}}$$

10-22 Water is boiled at sea level (1 atm pressure) and thus at a saturation (or boiling) temperature of $T_{\text{sat}} = 100^\circ\text{C}$ by a copper heating element. The surface temperature of the heating element and its power rating are to be determined.

Assumptions 1 Steady operating conditions exist. 2 Heat losses from the coffee maker are negligible. 3 The boiling regime is nucleate boiling (this assumption will be checked later).

Properties The properties of water at the saturation temperature of 100°C are (Tables 10-1 and A-9)

$$\rho_l = 957.9 \text{ kg/m}^3$$

$$\rho_v = 0.60 \text{ kg/m}^3$$

$$\sigma = 0.0589 \text{ N/m}$$

$$\text{Pr}_l = 1.75$$

$$h_{fg} = 2257 \times 10^3 \text{ J/kg}$$

$$\mu_l = 0.282 \times 10^{-3} \text{ kg}\cdot\text{m/s}$$

$$c_{pl} = 4217 \text{ J/kg}\cdot^\circ\text{C}$$

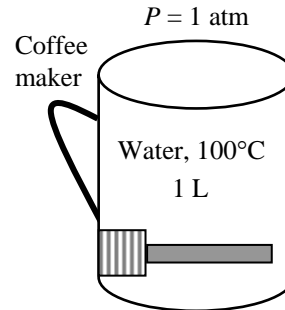

Also, $C_{sf} = 0.0130$ and $n = 1.0$ for the boiling of water on a copper surface (Table 10-3). Note that we expressed the properties in units specified under Eq. 10-2 connection with their definitions in order to avoid unit manipulations.

Analysis The density of water at room temperature is very nearly 1 kg/L, and thus the mass of 1 L water at 18°C is nearly 1 kg. The rate of energy transfer needed to evaporate half of this water in 25 min and the heat flux are

$$Q = \dot{Q}\Delta t = mh_{fg} \rightarrow \dot{Q} = \frac{mh_{fg}}{\Delta t} = \frac{(0.5 \text{ kg})(2257 \text{ kJ/kg})}{(25 \times 60 \text{ s})} = 0.7523 \text{ kW}$$

$$A_s = \pi DL = \pi(0.04 \text{ m})(0.2 \text{ m}) = 0.02513 \text{ m}^2$$

$$\dot{q} = \dot{Q} / A_s = (0.7523 \text{ kW}) / (0.02513 \text{ m}^2) = 29.94 \text{ kW/m}^2 = 29,940 \text{ W/m}^2$$

The Rohsenow relation which gives the nucleate boiling heat flux for a specified surface temperature can also be used to determine the surface temperature when the heat flux is given.

Assuming nucleate boiling, the temperature of the inner surface of the pan is determined from Rohsenow relation to be

$$\dot{q}_{\text{nucleate}} = \mu_l h_{fg} \left[\frac{g(\rho_l - \rho_v)}{\sigma} \right]^{1/2} \left(\frac{c_{p,l}(T_s - T_{\text{sat}})}{C_{sf} h_{fg} \text{Pr}_l^n} \right)^3$$

$$29,940 = (0.282 \times 10^{-3})(2257 \times 10^3) \left[\frac{9.81(957.9 - 0.60)}{0.0589} \right]^{1/2} \left(\frac{4217(T_s - 100)}{0.0130(2257 \times 10^3)1.75} \right)^3$$

It gives

$$T_s = \mathbf{106.0^\circ\text{C}}$$

which is in the nucleate boiling range (5 to 30°C above surface temperature). Therefore, the nucleate boiling assumption is valid.

The specific heat of water at the average temperature of $(14+100)/2 = 57^\circ\text{C}$ is $c_p = 4.184 \text{ kJ/kg}\cdot^\circ\text{C}$. Then the time it takes for the entire water to be heated from 14°C to 100°C is determined to be

$$Q = \dot{Q}\Delta t = mc_p\Delta T \rightarrow \Delta t = \frac{mc_p\Delta T}{\dot{Q}} = \frac{(1 \text{ kg})(4.184 \text{ kJ/kg}\cdot^\circ\text{C})(100 - 14)^\circ\text{C}}{0.7523 \text{ kW}} = 478 \text{ s} = \mathbf{7.97 \text{ min}}$$

10-23 Water is boiled at a saturation (or boiling) temperature of $T_{\text{sat}} = 120^\circ\text{C}$ by a brass heating element whose temperature is not to exceed $T_s = 125^\circ\text{C}$. The highest rate of steam production is to be determined.

Assumptions **1** Steady operating conditions exist. **2** Heat losses from the boiler are negligible. **3** The boiling regime is nucleate boiling since $\Delta T = T_s - T_{\text{sat}} = 125 - 120 = 5^\circ\text{C}$ which is in the nucleate boiling range of 5 to 30°C for water.

Properties The properties of water at the saturation temperature of 120°C are (Tables 10-1 and A-9)

$$\rho_l = 943.4 \text{ kg/m}^3$$

$$\rho_v = 1.12 \text{ kg/m}^3$$

$$\sigma = 0.0550 \text{ N/m}$$

$$\text{Pr}_l = 1.44$$

$$h_{fg} = 2203 \times 10^3 \text{ J/kg}$$

$$\mu_l = 0.232 \times 10^{-3} \text{ kg} \cdot \text{m/s}$$

$$c_{pl} = 4244 \text{ J/kg} \cdot ^\circ\text{C}$$

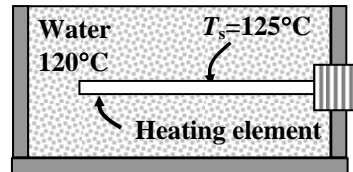

Also, $C_{sf} = 0.0060$ and $n = 1.0$ for the boiling of water on a brass surface (Table 10-3). Note that we expressed the properties in units specified under Eq. 10-2 in connection with their definitions in order to avoid unit manipulations.

Analysis Assuming nucleate boiling, the heat flux in this case can be determined from Rohsenow relation to be

$$\begin{aligned} \dot{q}_{\text{nucleate}} &= \mu_l h_{fg} \left[\frac{g(\rho_l - \rho_v)}{\sigma} \right]^{1/2} \left(\frac{c_{p,l}(T_s - T_{\text{sat}})}{C_{sf} h_{fg} \text{Pr}_l^n} \right)^3 \\ &= (0.232 \times 10^{-3})(2203 \times 10^3) \left[\frac{9.81(943.4 - 1.12)}{0.0550} \right]^{1/2} \left(\frac{4244(125 - 120)}{0.0060(2203 \times 10^3)1.44} \right)^3 \\ &= 290,300 \text{ W/m}^2 \end{aligned}$$

The surface area of the heater is

$$A_s = \pi DL = \pi(0.02 \text{ m})(0.65 \text{ m}) = 0.04084 \text{ m}^2$$

Then the rate of heat transfer during nucleate boiling becomes

$$\dot{Q}_{\text{boiling}} = A_s \dot{q}_{\text{nucleate}} = (0.04084 \text{ m}^2)(290,300 \text{ W/m}^2) = 11,856 \text{ W}$$

(b) The rate of evaporation of water is determined from

$$\dot{m}_{\text{evaporation}} = \frac{\dot{Q}_{\text{boiling}}}{h_{fg}} = \frac{11,856 \text{ J/s}}{2203 \times 10^3 \text{ J/kg}} \left(\frac{3600 \text{ s}}{1 \text{ h}} \right) = \mathbf{19.4 \text{ kg/h}}$$

Therefore, steam can be produced at a rate of about 20 kg/h by this heater.

10-24 Water is boiled at 1 atm pressure and thus at a saturation (or boiling) temperature of $T_{\text{sat}} = 100^\circ\text{C}$ by a horizontal nickel plated copper heating element. The maximum (critical) heat flux and the temperature jump of the wire when the operating point jumps from nucleate boiling to film boiling regime are to be determined.

Assumptions 1 Steady operating conditions exist. 2 Heat losses from the boiler are negligible.

Properties The properties of water at the saturation temperature of 100°C are (Tables 10-1 and A-9)

$$\rho_l = 957.9 \text{ kg/m}^3$$

$$\rho_v = 0.5978 \text{ kg/m}^3$$

$$\sigma = 0.0589 \text{ N/m}$$

$$\text{Pr}_l = 1.75$$

$$h_{fg} = 2257 \times 10^3 \text{ J/kg}$$

$$\mu_l = 0.282 \times 10^{-3} \text{ kg} \cdot \text{m/s}$$

$$c_{pl} = 4217 \text{ J/kg} \cdot ^\circ\text{C}$$

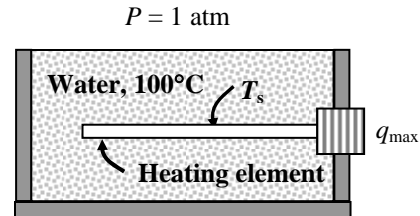

Also, $C_{sf} = 0.0060$ and $n = 1.0$ for the boiling of water on a nickel plated surface (Table 10-3). Note that we expressed the properties in units specified under Eqs. 10-2 and 10-3 in connection with their definitions in order to avoid unit manipulations. The vapor properties at the anticipated film temperature of $T_f = (T_s + T_{\text{sat}})/2$ of 100°C (will be checked) (Table A-16)

$$\rho_v = 0.1725 \text{ kg/m}^3$$

$$c_{pv} = 2471 \text{ J/kg} \cdot ^\circ\text{C}$$

$$k_v = 0.1362 \text{ W/m} \cdot ^\circ\text{C}$$

$$\mu_v = 4.762 \times 10^{-5} \text{ kg/m} \cdot \text{s}$$

Analysis (a) For a horizontal heating element, the coefficient C_{cr} is determined from Table 10-4 to be

$$L^* = L \left(\frac{g(\rho_l - \rho_v)}{\sigma} \right)^{1/2} = (0.0015) \left(\frac{9.8(957.9 - 0.5978)}{0.0589} \right)^{1/2} = 0.60 < 1.2$$

$$C_{cr} = 0.12 L^{*-0.25} = 0.12(0.60)^{-0.25} = 0.136$$

Then the maximum or critical heat flux is determined from

$$\begin{aligned} \dot{q}_{\text{max}} &= C_{cr} h_{fg} [\sigma g \rho_v^2 (\rho_l - \rho_v)]^{1/4} \\ &= 0.136 (2257 \times 10^3) [0.0589 \times 9.81 \times (0.5978)^2 (957.9 - 0.5978)]^{1/4} \\ &= \mathbf{1,151,000 \text{ W/m}^2} \end{aligned}$$

The Rohsenow relation which gives the nucleate boiling heat flux for a specified surface temperature can also be used to determine the surface temperature when the heat flux is given. Substituting the maximum heat flux into the Rohsenow relation together with other properties gives

$$\begin{aligned} \dot{q}_{\text{nucleate}} &= \mu_l h_{fg} \left[\frac{g(\rho_l - \rho_v)}{\sigma} \right]^{1/2} \left(\frac{c_{p,l}(T_s - T_{\text{sat}})}{C_{sf} h_{fg} \text{Pr}_l^n} \right)^3 \\ 1,151,000 &= (0.282 \times 10^{-3}) (2257 \times 10^3) \left[\frac{9.81(957.9 - 0.60)}{0.0060} \right]^{1/2} \left(\frac{4217(T_s - 100)}{0.0130(2257 \times 10^3)1.75} \right)^3 \end{aligned}$$

It gives

$$T_s = 100.9^\circ\text{C}$$

(b) Heat transfer in the film boiling region can be expressed as

$$\begin{aligned}\dot{q}_{\text{total}} &= \dot{q}_{\text{film}} + \frac{3}{4} \dot{q}_{\text{rad}} \\ &= 0.62 \left[\frac{gk_v^3 \rho_v (\rho_l - \rho_v) [h_{fg} + 0.4c_{pv}(T_s - T_{sat})]}{\mu_v D (T_s - T_{sat})} \right]^{1/4} (T_s - T_{sat}) + \frac{3}{4} \epsilon \sigma (T_s^4 - T_{sat}^4)\end{aligned}$$

Substituting,

$$\begin{aligned}1,151,000 &= 0.62 \left[\frac{9.81(0.1362)^3 (0.1725)(957.9 - 0.1725)[2257 \times 10^3 + 0.4 \times 2471(T_s - 100)]}{(4.762 \times 10^{-5})(0.003)(T_s - 100)} \right]^{1/4} \\ &\quad \times (T_s - 100) + \frac{3}{4} (0.5)(5.67 \times 10^{-8} \text{ W/m}^2 \cdot \text{K}^4) [(T_s + 273)^4 - (100 + 273)^4]\end{aligned}$$

Solving for the surface temperature gives $T_s = 1996^\circ\text{C}$. Therefore, the temperature jump of the wire when the operating point jumps from nucleate boiling to film boiling is

Temperature jump: $\Delta T = T_{s, \text{film}} - T_{s, \text{crit}} = 1996 - 101 = \mathbf{1895^\circ\text{C}}$

Note that the film temperature is $(1996+100)/2=1048^\circ\text{C}$, which is close enough to the assumed value of 1000°C for the evaluation of vapor properties.

10-25 EES Prob. 10-24 is reconsidered. The effects of the local atmospheric pressure and the emissivity of the wire on the critical heat flux and the temperature rise of wire are to be investigated.

Analysis The problem is solved using EES, and the solution is given below.

"GIVEN"

L=0.3 [m]
D=0.003 [m]
epsilon=0.5
P=101.3 [kPa]

"PROPERTIES"

Fluid\$='steam_IAPWS'
T_sat=temperature(Fluid\$, P=P, x=1)
rho_l=density(Fluid\$, T=T_sat, x=0)
rho_v=density(Fluid\$, T=T_sat, x=1)
sigma=SurfaceTension(Fluid\$, T=T_sat)
mu_l=Viscosity(Fluid\$, T=T_sat, x=0)
Pr_l=Prandtl(Fluid\$, T=T_sat, P=P)
C_l=CP(Fluid\$, T=T_sat, x=0)*Convert(kJ/kg-C, J/kg-C)
h_f=enthalpy(Fluid\$, T=T_sat, x=0)
h_g=enthalpy(Fluid\$, T=T_sat, x=1)
h_fg=(h_g-h_f)*Convert(kJ/kg, J/kg)
C_sf=0.0060 "from Table 10-3 of the text"
n=1 "from Table 10-3 of the text"

T_vapor=1000-273 "[C], assumed vapor temperature in the film boiling region"
rho_v_f=density(Fluid\$, T=T_vapor, P=P) "f stands for film"
C_v_f=CP(Fluid\$, T=T_vapor, P=P)*Convert(kJ/kg-C, J/kg-C)
k_v_f=Conductivity(Fluid\$, T=T_vapor, P=P)
mu_v_f=Viscosity(Fluid\$, T=T_vapor, P=P)

g=9.8 [m/s^2] "gravitational acceleration"
sigma_rad=5.67E-8 [W/m^2-K^4] "Stefan-Boltzmann constant"

"ANALYSIS"

"(a)"

"C_cr is to be determined from Table 10-4 of the text"

C_cr=0.12*L_star^(-0.25)
L_star=D/2*((g*(rho_l-rho_v))/sigma)^0.5
q_dot_max=C_cr*h_fg*(sigma*g*rho_v^2*(rho_l-rho_v))^0.25
q_dot_nucleate=q_dot_max
q_dot_nucleate=mu_l*h_fg*(((g*(rho_l-rho_v))/sigma)^0.5)*((C_l*(T_s_crit-T_sat))/(C_sf*h_fg*Pr_l^n))^3

"(b)"

q_dot_total=q_dot_film+3/4*q_dot_rad "Heat transfer in the film boiling region"
q_dot_total=q_dot_nucleate
q_dot_film=0.62*((g*k_v_f^3*rho_v_f*(rho_l-rho_v_f)*(h_fg+0.4*C_v_f*(T_s_film-T_sat)))/(mu_v_f*D*(T_s_film-T_sat)))^0.25*(T_s_film-T_sat)
q_dot_rad=epsilon*sigma_rad*((T_s_film+273)^4-(T_sat+273)^4)
DELTAT=T_s_film-T_s_crit

P [kPa]	q_{max} [kW/m²]	ΔT [C]
70	994227	1865
71.65	1003642	1870
73.29	1012919	1876
74.94	1022063	1881
76.59	1031078	1886
78.24	1039970	1891
79.88	1048741	1896
81.53	1057396	1900
83.18	1065939	1905
84.83	1074373	1909
86.47	1082702	1914
88.12	1090928	1918
89.77	1099055	1923
91.42	1107085	1927
93.06	1115022	1931
94.71	1122867	1935
96.36	1130624	1939
98.01	1138294	1943
99.65	1145883	1947
101.3	1153386	1951

ε	q_{max} [kW/m²]	ΔT [C]
0.1	1153386	2800
0.15	1153386	2574
0.2	1153386	2418
0.25	1153386	2299
0.3	1153386	2205
0.35	1153386	2126
0.4	1153386	2059
0.45	1153386	2002
0.5	1153386	1951
0.55	1153386	1905
0.6	1153386	1864
0.65	1153386	1827
0.7	1153386	1793
0.75	1153386	1761
0.8	1153386	1732
0.85	1153386	1705
0.9	1153386	1680
0.95	1153386	1657
1	1153386	1634

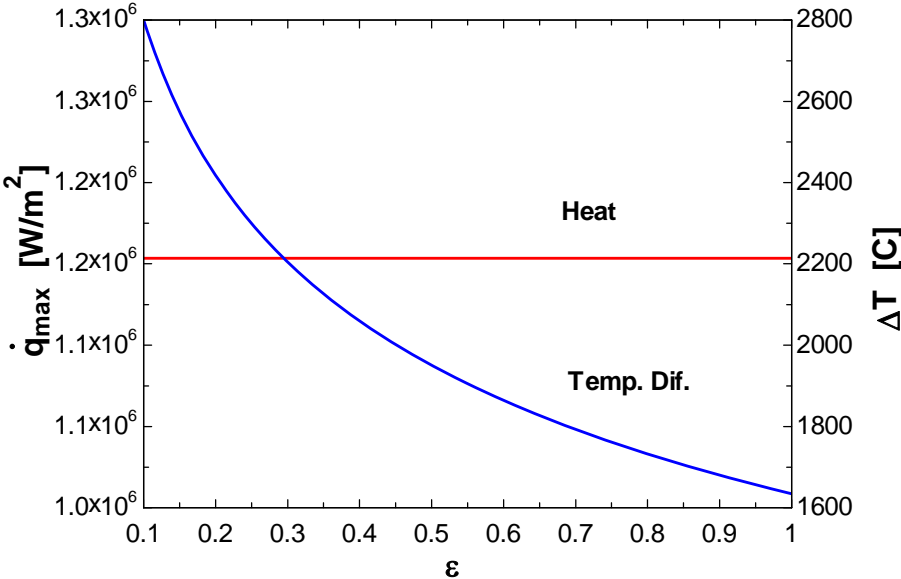
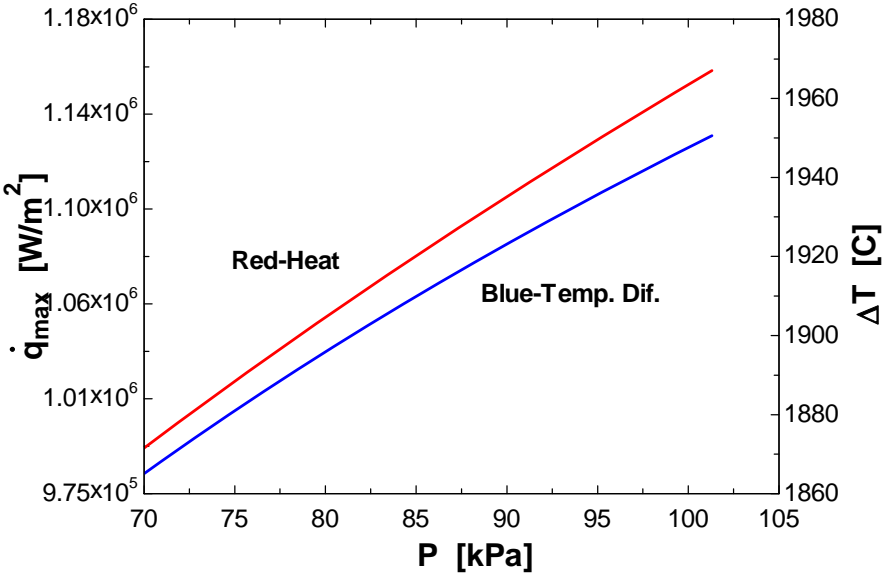

10-26 Water is boiled at sea level (1 atm pressure) and thus at a saturation (or boiling) temperature of $T_{\text{sat}} = 100^\circ\text{C}$ in a teflon-pitted stainless steel pan placed on an electric burner. The water level drops by 10 cm in 30 min during boiling. The inner surface temperature of the pan is to be determined.

Assumptions 1 Steady operating conditions exist. 2 Heat losses from the pan are negligible. 3 The boiling regime is nucleate boiling (this assumption will be checked later).

Properties The properties of water at the saturation temperature of 100°C are (Tables 10-1 and A-9)

$$\rho_l = 957.9 \text{ kg/m}^3$$

$$\rho_v = 0.60 \text{ kg/m}^3$$

$$\sigma = 0.0589 \text{ N/m}$$

$$\text{Pr}_l = 1.75$$

$$h_{fg} = 2257 \times 10^3 \text{ J/kg}$$

$$\mu_l = 0.282 \times 10^{-3} \text{ kg} \cdot \text{m/s}$$

$$c_{pl} = 4217 \text{ J/kg} \cdot ^\circ\text{C}$$

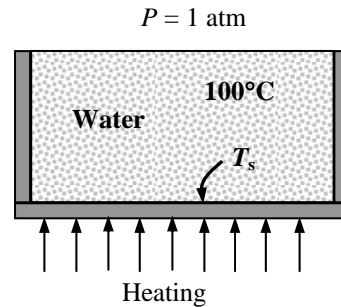

Also, $C_{sf} = 0.0058$ and $n = 1.0$ for the boiling of water on a teflon-pitted stainless steel surface (Table 10-3). Note that we expressed the properties in units specified under Eq. 10-2 connection with their definitions in order to avoid unit manipulations.

Analysis The rate of heat transfer to the water and the heat flux are

$$\dot{m}_{\text{evap}} = \frac{m_{\text{evap}}}{\Delta t} = \frac{\rho \Delta V}{\Delta t} = \frac{(957.9 \text{ kg/m}^3)(\pi \times (0.2 \text{ m})^2 / 4 \times 0.10 \text{ m})}{15 \times 60 \text{ s}} = 0.003344 \text{ kg/s}$$

$$\dot{Q} = \dot{m}_{\text{evap}} h_{fg} = (0.003344 \text{ kg/s})(2257 \text{ kJ/kg}) = 7.547 \text{ kW}$$

$$A_s = \pi D^2 / 4 = \pi (0.20 \text{ m})^2 / 4 = 0.03142 \text{ m}^2$$

$$\dot{q} = \dot{Q} / A_s = (7547 \text{ W}) / (0.03142 \text{ m}^2) = 240,200 \text{ W/m}^2$$

The Rohsenow relation which gives the nucleate boiling heat flux for a specified surface temperature can also be used to determine the surface temperature when the heat flux is given. Assuming nucleate boiling, the temperature of the inner surface of the pan is determined from Rohsenow relation to be

$$\dot{q}_{\text{nucleate}} = \mu_l h_{fg} \left[\frac{g(\rho_l - \rho_v)}{\sigma} \right]^{1/2} \left(\frac{c_{p,l}(T_s - T_{\text{sat}})}{C_{sf} h_{fg} \text{Pr}_l^n} \right)^3$$

$$240,200 = (0.282 \times 10^{-3})(2257 \times 10^3) \left[\frac{9.8(957.9 - 0.60)}{0.0589} \right]^{1/2} \left(\frac{4217(T_s - 100)}{0.0058(2257 \times 10^3)1.75} \right)^3$$

It gives

$$T_s = \mathbf{105.3^\circ\text{C}}$$

which is in the nucleate boiling range (5 to 30°C above surface temperature). Therefore, the nucleate boiling assumption is valid.

10-27 Water is boiled at sea level (1 atm pressure) and thus at a saturation (or boiling) temperature of $T_{\text{sat}} = 100^\circ\text{C}$ in a polished copper pan placed on an electric burner. The water level drops by 10 cm in 30 min during boiling. The inner surface temperature of the pan is to be determined.

Assumptions 1 Steady operating conditions exist. 2 Heat losses from the pan are negligible. 3 The boiling regime is nucleate boiling (this assumption will be checked later).

Properties The properties of water at the saturation temperature of 100°C are (Tables 10-1 and A-9)

$$\rho_l = 957.9 \text{ kg/m}^3$$

$$\rho_v = 0.60 \text{ kg/m}^3$$

$$\sigma = 0.0589 \text{ N/m}$$

$$\text{Pr}_l = 1.75$$

$$h_{fg} = 2257 \times 10^3 \text{ J/kg}$$

$$\mu_l = 0.282 \times 10^{-3} \text{ kg} \cdot \text{m/s}$$

$$c_{pl} = 4217 \text{ J/kg} \cdot ^\circ\text{C}$$

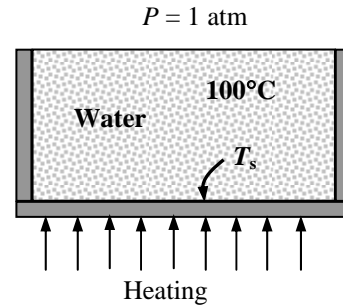

Also, $C_{sf} = 0.0130$ and $n = 1.0$ for the boiling of water on a copper surface (Table 10-3). Note that we expressed the properties in units specified under Eq. 10-2 connection with their definitions in order to avoid unit manipulations.

Analysis The rate of heat transfer to the water and the heat flux are

$$\dot{m}_{\text{evap}} = \frac{m_{\text{evap}}}{\Delta t} = \frac{\rho \Delta V}{\Delta t} = \frac{(957.9 \text{ kg/m}^3)(\pi \times (0.2 \text{ m})^2 / 4 \times 0.10 \text{ m})}{15 \times 60 \text{ s}} = 0.003344 \text{ kg/s}$$

$$\dot{Q} = \dot{m}_{\text{evap}} h_{fg} = (0.003344 \text{ kg/s})(2257 \text{ kJ/kg}) = 7.547 \text{ kW}$$

$$A_s = \pi D^2 / 4 = \pi (0.20 \text{ m})^2 / 4 = 0.03142 \text{ m}^2$$

$$\dot{q} = \dot{Q} / A_s = (7547 \text{ W}) / (0.03142 \text{ m}^2) = 240,200 \text{ W/m}^2$$

The Rohsenow relation which gives the nucleate boiling heat flux for a specified surface temperature can also be used to determine the surface temperature when the heat flux is given. Assuming nucleate boiling, the temperature of the inner surface of the pan is determined from Rohsenow relation to be

$$\dot{q}_{\text{nucleate}} = \mu_l h_{fg} \left[\frac{g(\rho_l - \rho_v)}{\sigma} \right]^{1/2} \left(\frac{c_{p,l}(T_s - T_{\text{sat}})}{C_{sf} h_{fg} \text{Pr}_l^n} \right)^3$$

$$240,200 = (0.282 \times 10^{-3})(2257 \times 10^3) \left[\frac{9.8(957.9 - 0.60)}{0.0589} \right]^{1/2} \left(\frac{4217(T_s - 100)}{0.0130(2257 \times 10^3)1.75} \right)^3$$

It gives

$$T_s = \mathbf{111.9^\circ\text{C}}$$

which is in the nucleate boiling range (5 to 30°C above surface temperature). Therefore, the nucleate boiling assumption is valid.

10-28 Water is boiled at a temperature of $T_{\text{sat}} = 150^\circ\text{C}$ by hot gases flowing through a mechanically polished stainless steel pipe submerged in water whose outer surface temperature is maintained at $T_s = 165^\circ\text{C}$. The rate of heat transfer to the water, the rate of evaporation, the ratio of critical heat flux to current heat flux, and the pipe surface temperature at critical heat flux conditions are to be determined.

Assumptions 1 Steady operating conditions exist. 2 Heat losses from the boiler are negligible. 3 The boiling regime is nucleate boiling since $\Delta T = T_s - T_{\text{sat}} = 165 - 150 = 15^\circ\text{C}$ which is in the nucleate boiling range of 5 to 30°C for water.

Properties The properties of water at the saturation temperature of 150°C are (Tables 10-1 and A-9)

$$\rho_l = 916.6 \text{ kg/m}^3$$

$$\rho_v = 2.55 \text{ kg/m}^3$$

$$\sigma = 0.0488 \text{ N/m}$$

$$\text{Pr}_l = 1.16$$

$$h_{fg} = 2114 \times 10^3 \text{ J/kg}$$

$$\mu_l = 0.183 \times 10^{-3} \text{ kg} \cdot \text{m/s}$$

$$c_{pl} = 4311 \text{ J/kg} \cdot ^\circ\text{C}$$

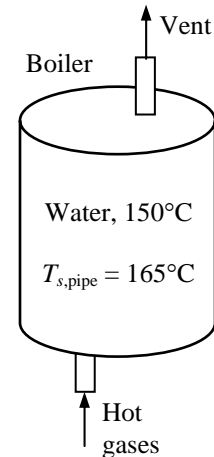

Also, $C_{sf} = 0.0130$ and $n = 1.0$ for the boiling of water on a mechanically polished stainless steel surface (Table 10-3). Note that we expressed the properties in units specified under Eq. 10-2 in connection with their definitions in order to avoid unit manipulations.

Analysis (a) Assuming nucleate boiling, the heat flux can be determined from Rohsenow relation to be

$$\begin{aligned} \dot{q}_{\text{nucleate}} &= \mu_l h_{fg} \left[\frac{g(\rho_l - \rho_v)}{\sigma} \right]^{1/2} \left(\frac{c_{p,l}(T_s - T_{\text{sat}})}{C_{sf} h_{fg} \text{Pr}_l^n} \right)^3 \\ &= (0.183 \times 10^{-3})(2114 \times 10^3) \left[\frac{9.8(916.6 - 2.55)}{0.0488} \right]^{1/2} \left(\frac{4311(165 - 150)}{0.0130(2114 \times 10^3)1.16} \right)^3 \\ &= 1,383,000 \text{ W/m}^2 \end{aligned}$$

The heat transfer surface area is

$$A_s = \pi DL = \pi(0.05 \text{ m})(50 \text{ m}) = 7.854 \text{ m}^2$$

Then the rate of heat transfer during nucleate boiling becomes

$$\dot{Q}_{\text{boiling}} = A_s \dot{q}_{\text{nucleate}} = (7.854 \text{ m}^2)(1,383,000 \text{ W/m}^2) = \mathbf{10,865,000 \text{ W}}$$

(b) The rate of evaporation of water is determined from

$$\dot{m}_{\text{evaporation}} = \frac{\dot{Q}_{\text{boiling}}}{h_{fg}} = \frac{10,865 \text{ kJ/s}}{2114 \text{ kJ/kg}} = \mathbf{5.139 \text{ kg/s}}$$

(c) For a horizontal cylindrical heating element, the coefficient C_{cr} is determined from Table 10-4 to be

$$L^* = L \left(\frac{g(\rho_l - \rho_v)}{\sigma} \right)^{1/2} = (0.025) \left(\frac{9.8(916.6 - 2.55)}{0.0488} \right)^{1/2} = 10.7 > 1.2$$

$$C_{cr} = 0.12 \quad (\text{since } L^* > 1.2 \text{ and thus large cylinder})$$

Then the maximum or critical heat flux is determined from

$$\begin{aligned}\dot{q}_{\max} &= C_{cr} h_{fg} [\sigma g \rho_v^2 (\rho_l - \rho_v)]^{1/4} \\ &= 0.12(2114 \times 10^3) [0.0488 \times 9.8 \times (2.55)^2 (916.6 - 2.55)]^{1/4} \\ &= 1,852,000 \text{ W/m}^2\end{aligned}$$

Therefore,
$$\frac{\dot{q}_{\max}}{\dot{q}_{\text{current}}} = \frac{1,852,000}{1,383,000} = \mathbf{1.34}$$

(d) The surface temperature of the pipe at the burnout point is determined from Rohsenow relation at the critical heat flux value to be

$$\begin{aligned}\dot{q}_{\text{nucleate,cr}} &= \mu_l h_{fg} \left[\frac{g(\rho_l - \rho_v)}{\sigma} \right]^{1/2} \left(\frac{c_{p,l}(T_{s,cr} - T_{\text{sat}})}{C_{sf} h_{fg} \text{Pr}_l^n} \right)^3 \\ 1,852,000 &= (0.183 \times 10^{-3})(2114 \times 10^3) \left[\frac{9.8(916.6 - 2.55)}{0.0488} \right]^{1/2} \left(\frac{4311(T_{s,cr} - 150)}{0.0130(2114 \times 10^3)1.16} \right)^3 \\ T_{s,cr} &= \mathbf{166.5^\circ\text{C}}\end{aligned}$$

10-29 Water is boiled at a temperature of $T_{\text{sat}} = 160^\circ\text{C}$ by hot gases flowing through a mechanically polished stainless steel pipe submerged in water whose outer surface temperature is maintained at $T_s = 165^\circ\text{C}$. The rate of heat transfer to the water, the rate of evaporation, the ratio of critical heat flux to current heat flux, and the pipe surface temperature at critical heat flux conditions are to be determined.

Assumptions 1 Steady operating conditions exist. 2 Heat losses from the boiler are negligible. 3 The boiling regime is nucleate boiling since $\Delta T = T_s - T_{\text{sat}} = 165 - 160 = 5^\circ\text{C}$ which is in the nucleate boiling range of 5 to 30°C for water.

Properties The properties of water at the saturation temperature of 160°C are (Tables 10-1 and A-9)

$$\rho_l = 907.4 \text{ kg/m}^3$$

$$\rho_v = 3.26 \text{ kg/m}^3$$

$$\sigma = 0.0466 \text{ N/m}$$

$$\text{Pr}_l = 1.09$$

$$h_{fg} = 2083 \times 10^3 \text{ J/kg}$$

$$\mu_l = 0.170 \times 10^{-3} \text{ kg} \cdot \text{m/s}$$

$$c_{pl} = 4340 \text{ J/kg} \cdot ^\circ\text{C}$$

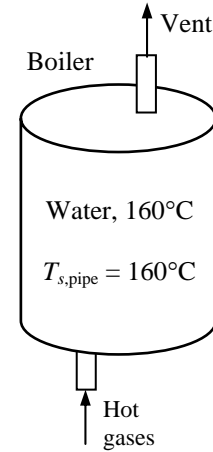

Also, $C_{sf} = 0.0130$ and $n = 1.0$ for the boiling of water on a mechanically polished stainless steel surface (Table 10-3). Note that we expressed the properties in units specified under Eq. 10-2 in connection with their definitions in order to avoid unit manipulations.

Analysis (a) Assuming nucleate boiling, the heat flux can be determined from Rohsenow relation to be

$$\begin{aligned} \dot{q}_{\text{nucleate}} &= \mu_l h_{fg} \left[\frac{g(\rho_l - \rho_v)}{\sigma} \right]^{1/2} \left(\frac{c_{p,l}(T_s - T_{\text{sat}})}{C_{sf} h_{fg} \text{Pr}_l^n} \right)^3 \\ &= (0.170 \times 10^{-3})(2083 \times 10^3) \left[\frac{9.8(907.4 - 3.26)}{0.0466} \right]^{1/2} \left(\frac{4340(165 - 160)}{0.0130(2083 \times 10^3)(1.09)} \right)^3 \\ &= 61,359 \text{ W/m}^2 \end{aligned}$$

The heat transfer surface area is

$$A_s = \pi DL = \pi(0.05 \text{ m})(50 \text{ m}) = 7.854 \text{ m}^2$$

Then the rate of heat transfer during nucleate boiling becomes

$$\dot{Q}_{\text{boiling}} = A_s \dot{q}_{\text{nucleate}} = (7.854 \text{ m}^2)(61,359 \text{ W/m}^2) = \mathbf{481,900 \text{ W}}$$

(b) The rate of evaporation of water is determined from

$$\dot{m}_{\text{evaporation}} = \frac{\dot{Q}_{\text{boiling}}}{h_{fg}} = \frac{481.9 \text{ kJ/s}}{2083 \text{ kJ/kg}} = \mathbf{0.231 \text{ kg/s}}$$

(c) For a horizontal cylindrical heating element, the coefficient C_{cr} is determined from Table 10-4 to be

$$L^* = L \left(\frac{g(\rho_l - \rho_v)}{\sigma} \right)^{1/2} = (0.025) \left(\frac{9.8(907.4 - 3.26)}{0.0466} \right)^{1/2} = 10.9 > 0.12$$

$$C_{cr} = 0.12 \quad (\text{since } L^* > 1.2 \text{ and thus large cylinder})$$

Then the maximum or critical heat flux is determined from

$$\begin{aligned}\dot{q}_{\max} &= C_{cr} h_{fg} [\sigma g \rho_v^2 (\rho_l - \rho_v)]^{1/4} \\ &= 0.12(2083 \times 10^3) [0.0466 \times 9.8 \times (3.26)^2 (907.4 - 3.26)]^{1/4} \\ &= 2,034,000 \text{ W/m}^2\end{aligned}$$

Therefore,
$$\frac{\dot{q}_{\max}}{\dot{q}_{\text{current}}} = \frac{2,034,000}{61,359} = \mathbf{33.2}$$

(d) The surface temperature of the pipe at the burnout point is determined from Rohsenow relation at the critical heat flux value to be

$$\begin{aligned}\dot{q}_{\text{nucleate,cr}} &= \mu_l h_{fg} \left[\frac{g(\rho_l - \rho_v)}{\sigma} \right]^{1/2} \left(\frac{c_{p,l}(T_{s,cr} - T_{\text{sat}})}{C_{sf} h_{fg} \text{Pr}_l^n} \right)^3 \\ 2,034,000 &= (0.170 \times 10^{-3})(2083 \times 10^3) \left[\frac{9.8(907.4 - 3.26)}{0.0466} \right]^{1/2} \left(\frac{4340(T_{s,cr} - 160)}{0.0130(2083 \times 10^3)1.09} \right)^3 \\ T_{s,cr} &= \mathbf{176.1^\circ\text{C}}\end{aligned}$$

10-30E Water is boiled at a temperature of $T_{\text{sat}} = 250^\circ\text{F}$ by a nickel-plated heating element whose surface temperature is maintained at $T_s = 280^\circ\text{F}$. The boiling heat transfer coefficient, the electric power consumed, and the rate of evaporation of water are to be determined.

Assumptions **1** Steady operating conditions exist. **2** Heat losses from the boiler are negligible. **3** The boiling regime is nucleate boiling since $\Delta T = T_s - T_{\text{sat}} = 280 - 250 = 30^\circ\text{F}$ which is in the nucleate boiling range of 9 to 55°F for water.

Properties The properties of water at the saturation temperature of 250°F are (Tables 10-1 and A-9E)

$$\rho_l = 58.82 \text{ lbm/ft}^3$$

$$\rho_v = 0.0723 \text{ lbm/ft}^3$$

$$\sigma = 0.003755 \text{ lbf/ft} = 0.1208 \text{ lbm/s}^2$$

$$\text{Pr}_l = 1.43$$

$$h_{fg} = 946 \text{ Btu/lbm}$$

$$\mu_l = 1.544 \times 10^{-4} \text{ lbm/ft} \cdot \text{s} = 0.556 \text{ lbm/ft} \cdot \text{h}$$

$$c_{pl} = 1.015 \text{ Btu/lbm} \cdot ^\circ\text{F}$$

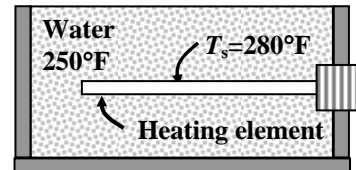

Also, $g = 32.2 \text{ ft/s}^2$ and $C_{sf} = 0.0060$ and $n = 1.0$ for the boiling of water on a nickel plated surface (Table 10-3). Note that we expressed the properties in units that will cancel each other in boiling heat transfer relations.

Analysis (a) Assuming nucleate boiling, the heat flux can be determined from Rohsenow relation to be

$$\begin{aligned} \dot{q}_{\text{nucleate}} &= \mu_l h_{fg} \left[\frac{g(\rho_l - \rho_v)}{\sigma} \right]^{1/2} \left(\frac{c_{p,l}(T_s - T_{\text{sat}})}{C_{sf} h_{fg} \text{Pr}_l^n} \right)^3 \\ &= (0.556)(946) \left[\frac{32.2(58.82 - 0.0723)}{0.1208} \right]^{1/2} \left(\frac{1.015(280 - 250)}{0.0060(946)1.43} \right)^3 \\ &= 3,475,221 \text{ Btu/h} \cdot \text{ft}^2 \end{aligned}$$

Then the convection heat transfer coefficient becomes

$$\dot{q} = h(T_s - T_{\text{sat}}) \rightarrow h = \frac{\dot{q}}{T_s - T_{\text{sat}}} = \frac{3,475,221 \text{ Btu/h} \cdot \text{ft}^2}{(280 - 250)^\circ\text{F}} = \mathbf{115,840 \text{ Btu/h} \cdot \text{ft}^2 \cdot ^\circ\text{F}}$$

(b) The electric power consumed is equal to the rate of heat transfer to the water, and is determined from

$$\begin{aligned} \dot{W}_e = \dot{Q} = \dot{q}A_s &= (\pi DL)\dot{q} = (\pi \times 0.5 / 12 \text{ ft} \times 2 \text{ ft})(3,475,221 \text{ Btu/h} \cdot \text{ft}^2) = 909,811 \text{ Btu/h} \\ &= \mathbf{266.7 \text{ kW}} \quad (\text{since } 1 \text{ kW} = 3412 \text{ Btu/h}) \end{aligned}$$

(c) Finally, the rate of evaporation of water is determined from

$$\dot{m}_{\text{evaporation}} = \frac{\dot{Q}_{\text{boiling}}}{h_{fg}} = \frac{909,811 \text{ Btu/h}}{946 \text{ Btu/lbm}} = \mathbf{961.7 \text{ lbm/h}}$$

10-31E Water is boiled at a temperature of $T_{\text{sat}} = 250^\circ\text{F}$ by a platinum-plated heating element whose surface temperature is maintained at $T_s = 280^\circ\text{F}$. The boiling heat transfer coefficient, the electric power consumed, and the rate of evaporation of water are to be determined.

Assumptions **1** Steady operating conditions exist. **2** Heat losses from the boiler are negligible. **3** The boiling regime is nucleate boiling since $\Delta T = T_s - T_{\text{sat}} = 280 - 250 = 30^\circ\text{F}$ which is in the nucleate boiling range of 9 to 55°F for water.

Properties The properties of water at the saturation temperature of 250°F are (Tables 10-1 and A-9E)

$$\rho_l = 58.82 \text{ lbm/ft}^3$$

$$\rho_v = 0.0723 \text{ lbm/ft}^3$$

$$\sigma = 0.003755 \text{ lbf/ft} = 0.1208 \text{ lbm/s}^2$$

$$\text{Pr}_l = 1.43$$

$$h_{fg} = 946 \text{ Btu/lbm}$$

$$\mu_l = 1.544 \times 10^{-4} \text{ lbm/ft} \cdot \text{s} = 0.556 \text{ lbm/ft} \cdot \text{h}$$

$$c_{pl} = 1.015 \text{ Btu/lbm} \cdot ^\circ\text{F}$$

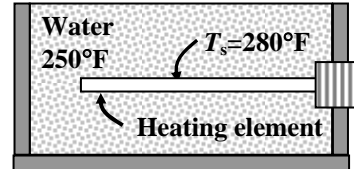

Also, $g = 32.2 \text{ ft/s}^2$ and $C_{sf} = 0.0130$ and $n = 1.0$ for the boiling of water on a platinum plated surface (Table 10-3). Note that we expressed the properties in units that will cancel each other in boiling heat transfer relations.

Analysis (a) Assuming nucleate boiling, the heat flux can be determined from Rohsenow relation to be

$$\begin{aligned} \dot{q}_{\text{nucleate}} &= \mu_l h_{fg} \left[\frac{g(\rho_l - \rho_v)}{\sigma} \right]^{1/2} \left(\frac{c_{p,l}(T_s - T_{\text{sat}})}{C_{sf} h_{fg} \text{Pr}_l^n} \right)^3 \\ &= (0.556)(946) \left[\frac{32.2(58.82 - 0.0723)}{0.1208} \right]^{1/2} \left(\frac{1.015(280 - 250)}{0.0130(0.1208 \times 10^3)1.43} \right)^3 \\ &= 341,670 \text{ Btu/h} \cdot \text{ft}^2 \end{aligned}$$

Then the convection heat transfer coefficient becomes

$$\dot{q} = h(T_s - T_{\text{sat}}) \rightarrow h = \frac{\dot{q}}{T_s - T_{\text{sat}}} = \frac{341,670 \text{ Btu/h} \cdot \text{ft}^2}{(280 - 250)^\circ\text{F}} = \mathbf{11,390 \text{ Btu/h} \cdot \text{ft}^2 \cdot ^\circ\text{F}}$$

(b) The electric power consumed is equal to the rate of heat transfer to the water, and is determined from

$$\begin{aligned} \dot{W}_e = \dot{Q} = \dot{q}A_s &= (\pi DL)\dot{q} = (\pi \times 0.5 / 12 \text{ ft} \times 2 \text{ ft})(341,670 \text{ Btu/h} \cdot \text{ft}^2) = 89,450 \text{ Btu/h} \\ &= \mathbf{26.2 \text{ kW}} \quad (\text{since } 1 \text{ kW} = 3412 \text{ Btu/h}) \end{aligned}$$

(c) Finally, the rate of evaporation of water is determined from

$$\dot{m}_{\text{evaporation}} = \frac{\dot{Q}_{\text{boiling}}}{h_{fg}} = \frac{89,450 \text{ Btu/h}}{946 \text{ Btu/lbm}} = \mathbf{94.6 \text{ lbm/h}}$$

10-32E EES Prob. 10-30E is reconsidered. The effect of surface temperature of the heating element on the boiling heat transfer coefficient, the electric power, and the rate of evaporation of water is to be investigated.

Analysis The problem is solved using EES, and the solution is given below.

"GIVEN"

T_sat=250 [F]

L=2 [ft]

D=0.5/12 [ft]

T_s=280 [F]

"PROPERTIES"

Fluid\$='steam_IAPWS'

P_sat=pressure(Fluid\$, T=T_sat, x=1)

rho_l=density(Fluid\$, T=T_sat, x=0)

rho_v=density(Fluid\$, T=T_sat, x=1)

sigma=SurfaceTension(Fluid\$, T=T_sat)*Convert(lbf/ft, lbm/s^2)

mu_l=Viscosity(Fluid\$, T=T_sat, x=0)

Pr_l=Prandtl(Fluid\$, T=T_sat, P=P_sat+1) "P=P_sat+1 is used to get liquid state"

C_l=CP(Fluid\$, T=T_sat, x=0)

h_f=enthalpy(Fluid\$, T=T_sat, x=0)

h_g=enthalpy(Fluid\$, T=T_sat, x=1)

h_fg=h_g-h_f

C_sf=0.0060 "from Table 10-3 of the text"

n=1 "from Table 10-3 of the text"

g=32.2 [ft/s^2]

"ANALYSIS"

"(a)"

q_dot_nucleate=mu_l*h_fg*(((g*(rho_l-rho_v))/sigma)^0.5)*((C_l*(T_s-T_sat))/(C_sf*h_fg*Pr_l^n))^3

q_dot_nucleate=h*(T_s-T_sat)

"(b)"

W_dot_e=q_dot_nucleate*A*Convert(Btu/h, kW)

A=pi*D*L

"(c)"

m_dot_evap=Q_dot_boiling/h_fg

Q_dot_boiling=W_dot_e*Convert(kW, Btu/h)

T _s [F]	h [Btu/h.ft ² .F]	W _e [kW]	m _{evap} [lbm/h]
260	12908	9.903	35.74
262	18587	17.11	61.76
264	25299	27.18	98.07
266	33043	40.56	146.4
268	41821	57.76	208.4
270	51630	79.23	285.9
272	62473	105.5	380.5
274	74348	136.9	494.1
276	87255	174.1	628.1
278	101195	217.4	784.5
280	116168	267.4	964.9
282	132174	324.5	1171
284	149212	389.2	1405

286	167282	462.1	1667
288	186386	543.4	1961
290	206521	633.8	2287
292	227690	733.7	2648
294	249891	843.6	3044
296	273125	964	3479
298	297391	1095	3952
300	322690	1238	4467

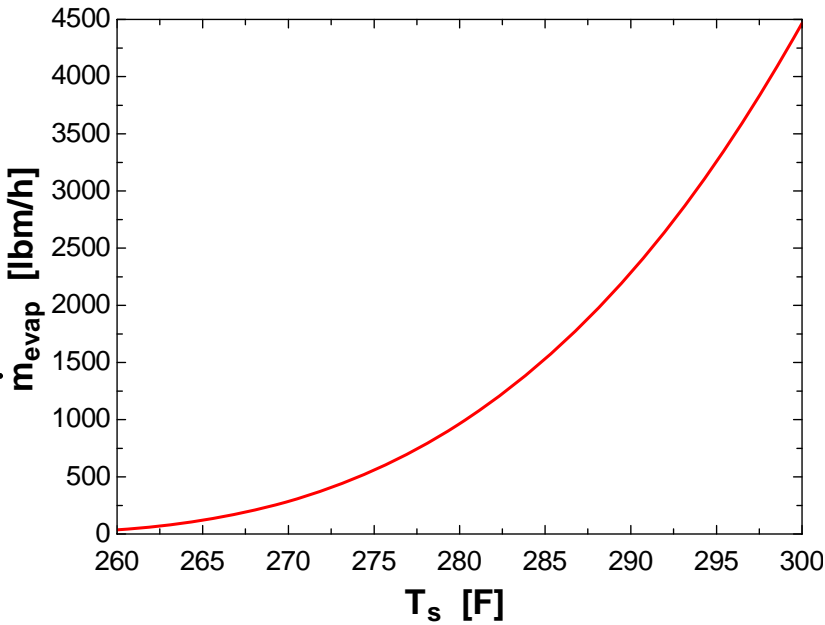
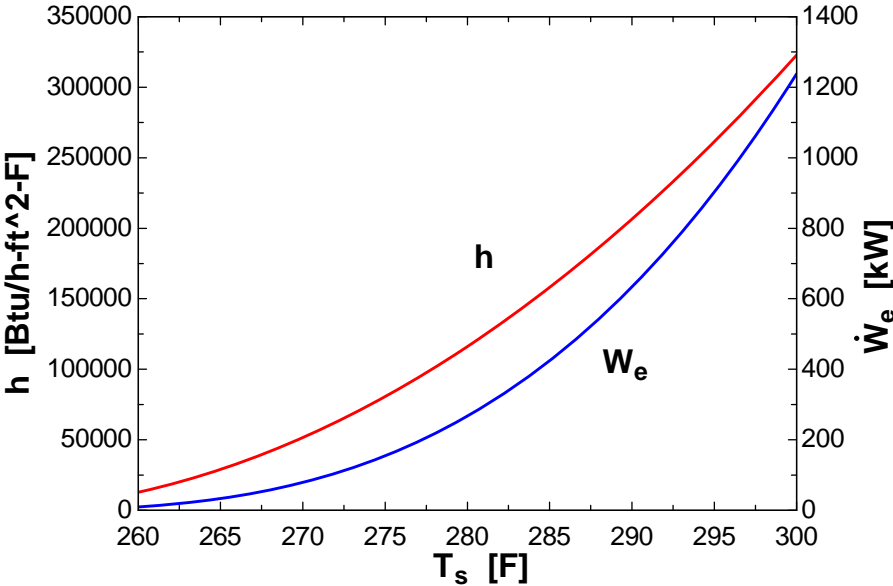

10-33 Cold water enters a steam generator at 15°C and is boiled, and leaves as saturated vapor at $T_{\text{sat}} = 200^\circ\text{C}$. The fraction of heat used to preheat the liquid water from 15°C to saturation temperature of 200°C is to be determined.

Assumptions 1 Steady operating conditions exist. 2 Heat losses from the steam generator are negligible.

Properties The heat of vaporization of water at 200°C is $h_{\text{fg}} = 1941 \text{ kJ/kg}$ and the specific heat of liquid water at the average temperature of $(15+200)/2 = 107.5^\circ\text{C}$ is $c_{pl} = 4.226 \text{ kJ/kg}\cdot^\circ\text{C}$ (Table A-9).

Analysis The heat of vaporization of water represents the amount of heat needed to vaporize a unit mass of liquid at a specified temperature. Using the average specific heat, the amount of heat needed to preheat a unit mass of water from 15°C to 200°C is determined to be

$$q_{\text{preheating}} = c_{pl} \Delta T = (4.226 \text{ kJ/kg}\cdot^\circ\text{C})(200 - 15)^\circ\text{C} = 782 \text{ kJ/kg}$$

and
$$q_{\text{total}} = q_{\text{boiling}} + q_{\text{preheating}} = 1941 + 782 = 2723 \text{ kJ/kg}$$

Therefore, the fraction of heat used to preheat the water is

$$\text{Fraction to preheat} = \frac{q_{\text{preheating}}}{q_{\text{total}}} = \frac{782}{2723} = \mathbf{0.287} \text{ (or } \mathbf{28.7\%})$$

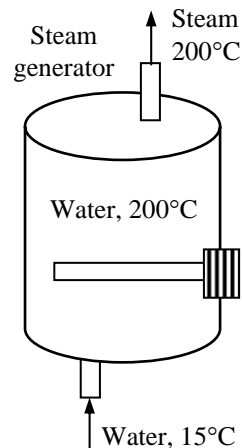

10-34 Cold water enters a steam generator at 20°C and is boiled, and leaves as saturated vapor at boiler pressure. The boiler pressure at which the amount of heat needed to preheat the water to saturation temperature is equal to the heat of vaporization is to be determined.

Assumptions 1 Steady operating conditions exist. 2 Heat losses from the steam generator are negligible.

Properties The properties needed to solve this problem are the heat of vaporization h_{fg} and the specific heat of water c_p at specified temperatures, and they can be obtained from Table A-9.

Analysis The heat of vaporization of water represents the amount of heat needed to vaporize a unit mass of liquid at a specified temperature, and $c_p \Delta T$ represents the amount of heat needed to preheat a unit mass of water from 20°C to the saturation temperature. Therefore,

$$q_{\text{preheating}} = q_{\text{boiling}}$$

$$c_{p,avg} (T_{\text{sat}} - 20) = h_{\text{fg}} @ T_{\text{sat}}$$

The solution of this problem requires choosing a boiling temperature, reading the heat of vaporization at that temperature, evaluating the specific heat at the average temperature, and substituting the values into the relation above to see if it is satisfied. By trial and error, the temperature that satisfies this condition is determined to be 315°C at which (Table A-9)

$$h_{\text{fg}} @ 315^\circ\text{C} = 1281 \text{ kJ/kg} \quad \text{and} \quad T_{\text{avg}} = (20 + 315)/2 = 167.5^\circ\text{C} \quad \rightarrow \quad c_{p,avg} = 4.36 \text{ kJ/kg}\cdot^\circ\text{C}$$

Substituting,

$$c_{p,avg} (T_{\text{sat}} - 20) = (4.36 \text{ kJ/kg}\cdot^\circ\text{C})(315 - 20)^\circ\text{C} = 1289 \text{ kJ/kg}$$

which is practically identical to the heat of vaporization. Therefore,

$$P_{\text{boiler}} = P_{\text{sat}} @ T_{\text{sat}} = \mathbf{10.6 \text{ MPa}}$$

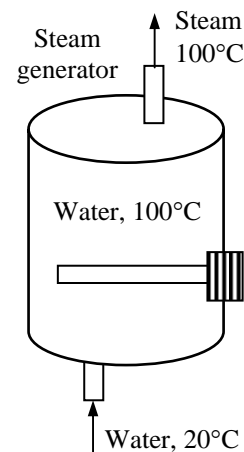

10-35 EES Prob. 10-34 is reconsidered. The boiler pressure as a function of the cold water temperature is to be plotted.

Analysis The problem is solved using EES, and the solution is given below.

"GIVEN"

$T_{\text{cold}}=20$ [C]

"ANALYSIS"

Fluid\$='steam_IAPWS'

$q_{\text{preheating}}=q_{\text{boiling}}$

$q_{\text{preheating}}=c_p(T_{\text{sat}}-T_{\text{cold}})$

$T_{\text{sat}}=\text{temperature}(\text{Fluid}\$, P=P, x=1)$

$c_p=\text{CP}(\text{Fluid}\$, T=T_{\text{ave}}, x=0)$

$T_{\text{ave}}=1/2(T_{\text{cold}}+T_{\text{sat}})$

$q_{\text{boiling}}=h_{\text{fg}}$

$h_{\text{f}}=\text{enthalpy}(\text{Fluid}\$, T=T_{\text{sat}}, x=0)$

$h_{\text{g}}=\text{enthalpy}(\text{Fluid}\$, T=T_{\text{sat}}, x=1)$

$h_{\text{fg}}=h_{\text{g}}-h_{\text{f}}$

T_{cold} [C]	P [kPa]
0	9726
1	9766
2	9806
3	9846
4	9886
5	9926
6	9966
7	10006
8	10046
9	10086
10	10127
11	10167
12	10207
13	10247
14	10287
15	10328
16	10368
17	10408
18	10449
19	10489
20	10529
21	10570
22	10610
23	10650
24	10691
25	10731
26	10772
27	10812
28	10852
29	10893
30	10933

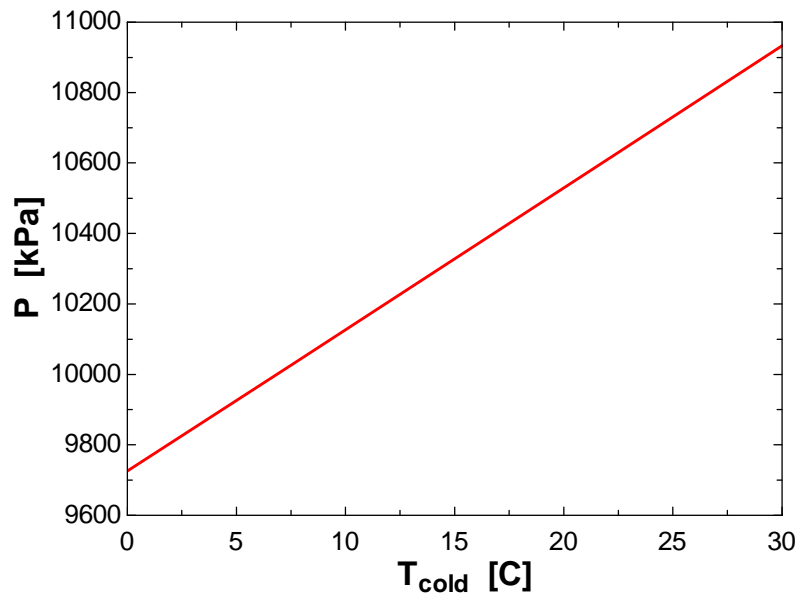

10-36 Boiling experiments are conducted by heating water at 1 atm pressure with an electric resistance wire, and measuring the power consumed by the wire as well as temperatures. The boiling heat transfer coefficient is to be determined.

Assumptions 1 Steady operating conditions exist. 2 Heat losses from the water are negligible.

Analysis The heat transfer area of the heater wire is

$$A_s = \pi DL = \pi(0.002 \text{ m})(0.50 \text{ m}) = 0.003142 \text{ m}^2$$

Noting that 3800 W of electric power is consumed when the heater surface temperature is 130°C, the boiling heat transfer coefficient is determined from Newton's law of cooling to be

$$\dot{Q} = hA_s(T_s - T_{\text{sat}}) \rightarrow h = \frac{\dot{Q}}{A_s(T_s - T_{\text{sat}})} = \frac{3800 \text{ W}}{(0.003142 \text{ m}^2)(130 - 100)^\circ\text{C}} = \mathbf{40,320 \text{ W/m}^2 \cdot ^\circ\text{C}}$$

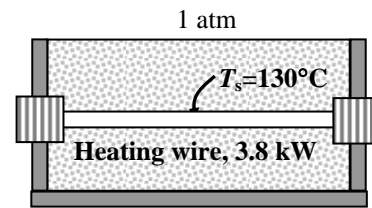

10-37 Water is boiled at $T_{\text{sat}} = 120^\circ\text{C}$ in a mechanically polished stainless steel pressure cooker whose inner surface temperature is maintained at $T_s = 132^\circ\text{C}$. The boiling heat transfer coefficient is to be determined.

Assumptions 1 Steady operating conditions exist. 2 Heat losses from the heater and the boiler are negligible.

Properties The properties of water at the saturation temperature of 120°C are (Tables 10-1 and A-9)

$$\begin{aligned} \rho_l &= 943.4 \text{ kg/m}^3 & h_{fg} &= 2203 \times 10^3 \text{ J/kg} \\ \rho_v &= 1.121 \text{ kg/m}^3 & \mu_l &= 0.232 \times 10^{-3} \text{ kg/m} \cdot \text{s} \\ \sigma &= 0.0550 \text{ N/m} & c_{pl} &= 4244 \text{ J/kg} \cdot ^\circ\text{C} \\ \text{Pr}_l &= 1.44 \end{aligned}$$

Also, $C_{sf} = 0.0130$ and $n = 1.0$ for the boiling of water on a mechanically polished stainless steel surface (Table 10-3). Note that we expressed the properties in units specified under Eq. 10-2 in connection with their definitions in order to avoid unit manipulations.

Analysis The excess temperature in this case is $\Delta T = T_s - T_{\text{sat}} = 132 - 120 = 12^\circ\text{C}$ which is relatively low (less than 30°C). Therefore, nucleate boiling will occur. The heat flux in this case can be determined from Rohsenow relation to be

$$\begin{aligned} \dot{q}_{\text{nucleate}} &= \mu_l h_{fg} \left[\frac{g(\rho_l - \rho_v)}{\sigma} \right]^{1/2} \left(\frac{c_{p,l}(T_s - T_{\text{sat}})}{C_{sf} h_{fg} \text{Pr}_l^n} \right)^3 \\ &= (0.232 \times 10^{-3})(2203 \times 10^3) \left[\frac{9.8(943.4 - 1.121)}{0.0550} \right]^{1/2} \left(\frac{4244(132 - 120)}{0.0130(2203 \times 10^3)^{1.44}} \right)^3 \\ &= \mathbf{394,600 \text{ W/m}^2} \end{aligned}$$

The boiling heat transfer coefficient is

$$\dot{q}_{\text{nucleate}} = h(T_s - T_{\text{sat}}) \rightarrow h = \frac{\dot{q}_{\text{nucleate}}}{T_s - T_{\text{sat}}} = \frac{394,600 \text{ W/m}^2}{(132 - 120)^\circ\text{C}} = \mathbf{32,880 \text{ W/m}^2 \cdot ^\circ\text{C}}$$

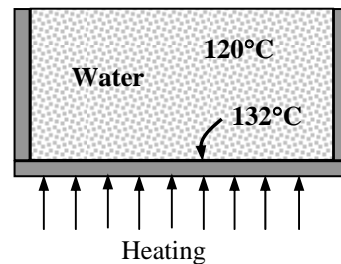

10-38 Water is boiled at $T_{\text{sat}} = 100^\circ\text{C}$ by a spherical platinum heating element immersed in water. The surface temperature is $T_s = 350^\circ\text{C}$. The rate of heat transfer is to be determined.

Assumptions 1 Steady operating conditions exist. 2 Heat losses from the heater and the boiler are negligible.

Properties The properties of water at the saturation temperature of 100°C are (Table A-9)

$$h_{fg} = 2257 \times 10^3 \text{ J/kg}$$

$$\rho_l = 957.9 \text{ kg/m}^3$$

The properties of water vapor at $(350+100)/2 = 225^\circ\text{C}$ are (Table A-16)

$$\rho_v = 0.444 \text{ kg/m}^3$$

$$\mu_v = 1.749 \times 10^{-5} \text{ kg/m} \cdot \text{s}$$

$$c_{pv} = 1951 \text{ J/kg} \cdot ^\circ\text{C}$$

$$k_v = 0.03581 \text{ W/m} \cdot ^\circ\text{C}$$

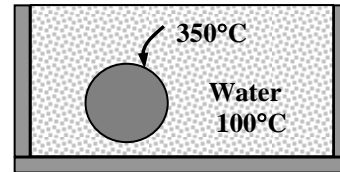

Analysis The film boiling occurs since the temperature difference between the surface and the fluid. The heat flux in this case can be determined from

$$\begin{aligned} \dot{q}_{\text{film}} &= 0.67 \left[\frac{gk_v^3 \rho_v (\rho_l - \rho_v) [h_{fg} + 0.4c_{pv}(T_s - T_{\text{sat}})]}{\mu_v D (T_s - T_{\text{sat}})} \right]^{1/4} (T_s - T_{\text{sat}}) \\ &= 0.67 \left[\frac{(9.81)(0.03581)^3 (0.444)(957.9 - 0.444) [2257 \times 10^3 + 0.4(1951)(350 - 100)]}{(1.749 \times 10^{-5})(0.15)(350 - 100)} \right]^{1/4} (350 - 100) \\ &= 25,207 \text{ W/m}^2 \end{aligned}$$

The radiation heat transfer is

$$\dot{q}_{\text{rad}} = \varepsilon \sigma (T_s^4 - T_{\text{sat}}^4) = (0.10)(5.67 \times 10^{-8}) [(350 + 273)^4 - (100 + 273)^4] = 745 \text{ W/m}^2$$

The total heat flux is

$$\dot{q}_{\text{total}} = \dot{q}_{\text{film}} + \frac{3}{4} \dot{q}_{\text{rad}} = 25,207 + \frac{3}{4}(745) = 25,766 \text{ W/m}^2$$

Then the total rate of heat transfer becomes

$$\dot{Q}_{\text{total}} = A \dot{q}_{\text{total}} = \pi (0.15)^2 (25,766 \text{ W/m}^2) = \mathbf{1821 \text{ W}}$$

Condensation Heat Transfer

10-39C Condensation is a vapor-to-liquid phase change process. It occurs when the temperature of a vapor is reduced *below* its saturation temperature T_{sat} . This is usually done by bringing the vapor into contact with a solid surface whose temperature T_s is *below* the saturation temperature T_{sat} of the vapor.

10-40C In *film condensation*, the condensate wets the surface and forms a liquid film on the surface which slides down under the influence of gravity. The thickness of the liquid film increases in the flow direction as more vapor condenses on the film. This is how condensation normally occurs in practice. In *dropwise condensation*, the condensed vapor forms droplets on the surface instead of a continuous film, and the surface is covered by countless droplets of varying diameters. Dropwise condensation is a much more effective mechanism of heat transfer.

10-41C In condensate flow, the wetted perimeter is defined as the length of the surface-condensate interface at a cross-section of condensate flow. It differs from the ordinary perimeter in that the latter refers to the entire circumference of the condensate at some cross-section.

10-42C The modified latent heat of vaporization h_{fg}^* is the amount of heat released as a unit mass of vapor condenses at a specified temperature, plus the amount of heat released as the condensate is cooled further to some average temperature between T_{sat} and T_s . It is defined as $h_{fg}^* = h_{fg} + 0.68c_{pl}(T_{\text{sat}} - T_s)$ where c_{pl} is the specific heat of the liquid at the average film temperature.

10-43C During film condensation on a vertical plate, heat flux at the top will be higher since the thickness of the film at the top, and thus its thermal resistance, is lower.

10-44C Setting the heat transfer coefficient relations for a vertical tube of height L and a horizontal tube of diameter D equal to each other yields $L = 2.77D$, which implies that for a tube whose length is 2.77 times its diameter, the average heat transfer coefficient for laminar film condensation will be the *same* whether the tube is positioned horizontally or vertically. For $L = 10D$, the heat transfer coefficient and thus the heat transfer rate will be higher in the horizontal position since $L > 2.77D$ in that case.

10-45C The condensation heat transfer coefficient for the tubes will be the highest for the case of horizontal side by side (case b) since (1) for long tubes, the horizontal position gives the highest heat transfer coefficients, and (2) for tubes in a vertical tier, the average thickness of the liquid film at the lower tubes is much larger as a result of condensate falling on top of them from the tubes directly above, and thus the average heat transfer coefficient at the lower tubes in such arrangements is smaller.

10-46C The presence of noncondensable gases in the vapor has a detrimental effect on condensation heat transfer. Even small amounts of a noncondensable gas in the vapor cause significant drops in heat transfer coefficient during condensation.

10-47 The hydraulic diameter D_h for all 4 cases are expressed in terms of the boundary layer thickness δ as follows:

$$(a) \text{ Vertical plate: } D_h = \frac{4A_c}{p} = \frac{4w\delta}{w} = 4\delta$$

$$(b) \text{ Tilted plate: } D_h = \frac{4A_c}{p} = \frac{4w\delta}{w} = 4\delta$$

$$(c) \text{ Vertical cylinder: } D_h = \frac{4A_c}{p} = \frac{4\pi D\delta}{\pi D} = 4\delta$$

$$(d) \text{ Horizontal cylinder: } D_h = \frac{4A_c}{p} = \frac{4(2L\delta)}{2L} = 4\delta$$

$$(e) \text{ Sphere: } D_h = \frac{4A_c}{p} = \frac{4\pi D\delta}{\pi D} = 4\delta$$

Therefore, the Reynolds number for all 5 cases can be expressed as

$$\text{Re} = \frac{4\dot{m}}{p\mu_l} = \frac{4A_c\rho_l V_l}{p\mu_l} = \frac{D_h\rho_l V_l}{\mu_l} = \frac{4\delta\rho_l V_l}{\mu_l}$$

10-48 There is film condensation on the outer surfaces of N horizontal tubes arranged in a vertical tier. The value of N for which the average heat transfer coefficient for the entire tier be equal to half of the value for a single horizontal tube is to be determined.

Assumptions Steady operating conditions exist.

Analysis The relation between the heat transfer coefficients for the two cases is given to be

$$h_{\text{horizontal, N tubes}} = \frac{h_{\text{horizontal, 1 tube}}}{N^{1/4}}$$

Therefore,

$$\frac{h_{\text{horizontal, N tubes}}}{h_{\text{horizontal, 1 tube}}} = \frac{1}{2} = \frac{1}{N^{1/4}} \longrightarrow N = \mathbf{16}$$

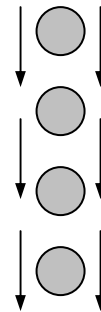

10-49 Saturated steam at atmospheric pressure thus at a saturation temperature of $T_{\text{sat}} = 100^\circ\text{C}$ condenses on a vertical plate which is maintained at 90°C by circulating cooling water through the other side. The rate of heat transfer to the plate and the rate of condensation of steam are to be determined.

Assumptions 1 Steady operating conditions exist. 2 The plate is isothermal. 3 The condensate flow is wavy-laminar over the entire plate (this assumption will be verified). 4 The density of vapor is much smaller than the density of liquid, $\rho_v \ll \rho_l$.

Properties The properties of water at the saturation temperature of 100°C are $h_{fg} = 2257 \times 10^3 \text{ J/kg}$ and $\rho_v = 0.60 \text{ kg/m}^3$. The properties of liquid water at the film temperature of $T_f = (T_{\text{sat}} + T_s)/2 = (100 + 90)/2 = 95^\circ\text{C}$ are (Table A-9),

$$\begin{aligned}\rho_l &= 961.5 \text{ kg/m}^3 \\ \mu_l &= 0.297 \times 10^{-3} \text{ kg/m}\cdot\text{s} \\ \nu_l &= \mu_l / \rho_l = 0.309 \times 10^{-6} \text{ m}^2/\text{s} \\ c_{pl} &= 4212 \text{ J/kg}\cdot^\circ\text{C} \\ k_l &= 0.677 \text{ W/m}\cdot^\circ\text{C}\end{aligned}$$

Analysis The modified latent heat of vaporization is

$$\begin{aligned}h_{fg}^* &= h_{fg} + 0.68c_{pl}(T_{\text{sat}} - T_s) \\ &= 2257 \times 10^3 \text{ J/kg} + 0.68 \times 4212 \text{ J/kg}\cdot^\circ\text{C}(100 - 90)^\circ\text{C} = 2,286 \times 10^3 \text{ J/kg}\end{aligned}$$

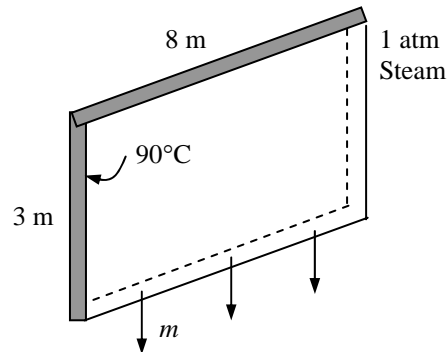

Assuming wavy-laminar flow, the Reynolds number is determined from

$$\begin{aligned}\text{Re} = \text{Re}_{\text{vertical,wavy}} &= \left[4.81 + \frac{3.70Lk_l(T_{\text{sat}} - T_s)}{\mu_l h_{fg}^*} \left(\frac{g}{\nu_l^2} \right)^{1/3} \right]^{0.820} \\ &= \left[4.81 + \frac{3.70 \times (3 \text{ m}) \times (0.677 \text{ W/m}\cdot^\circ\text{C}) \times (100 - 90)^\circ\text{C}}{(0.297 \times 10^{-3} \text{ kg/m}\cdot\text{s}) (2286 \times 10^3 \text{ J/kg})} \left(\frac{9.8 \text{ m/s}^2}{(0.309 \times 10^{-6} \text{ m}^2/\text{s})^2} \right)^{1/3} \right]^{0.82} = 1112\end{aligned}$$

which is between 30 and 1800, and thus our assumption of wavy laminar flow is verified. Then the condensation heat transfer coefficient is determined to be

$$\begin{aligned}h &= h_{\text{vertical,wavy}} = \frac{\text{Re} k_l}{1.08 \text{Re}^{1.22} - 5.2} \left(\frac{g}{\nu_l^2} \right)^{1/3} \\ &= \frac{1112 \times (0.677 \text{ W/m}\cdot^\circ\text{C})}{1.08(1112)^{1.22} - 5.2} \left(\frac{9.8 \text{ m/s}^2}{(0.309 \times 10^{-6} \text{ m}^2/\text{s})^2} \right)^{1/3} = 6279 \text{ W/m}^2\cdot^\circ\text{C}\end{aligned}$$

The heat transfer surface area of the plate is

$$A_s = W \times L = (3 \text{ m})(8 \text{ m}) = 24 \text{ m}^2$$

Then the rate of heat transfer during this condensation process becomes

$$\dot{Q} = hA_s(T_{\text{sat}} - T_s) = (6279 \text{ W/m}^2\cdot^\circ\text{C})(24 \text{ m}^2)(100 - 90)^\circ\text{C} = 1,506,960 \text{ W} = \mathbf{1507 \text{ kW}}$$

(b) The rate of condensation of steam is determined from

$$\dot{m}_{\text{condensation}} = \frac{\dot{Q}}{h_{fg}^*} = \frac{1,506,960 \text{ J/s}}{2286 \times 10^3 \text{ J/kg}} = \mathbf{0.659 \text{ kg/s}}$$

10-50 Saturated steam at a saturation temperature of $T_{\text{sat}} = 100^\circ\text{C}$ condenses on a plate which is tilted 60° from the vertical and maintained at 90°C by circulating cooling water through the other side. The rate of heat transfer to the plate and the rate of condensation of the steam are to be determined.

Assumptions 1 Steady operating conditions exist. 2 The plate is isothermal. 3 The condensate flow is wavy-laminar over the entire plate (this assumption will be verified). 4 The density of vapor is much smaller than the density of liquid, $\rho_v \ll \rho_l$.

Properties The properties of water at the saturation temperature of 100°C are $h_{fg} = 2257 \times 10^3 \text{ J/kg}$ and $\rho_v = 0.60 \text{ kg/m}^3$. The properties of liquid water at the film temperature of $T_f = (T_{\text{sat}} + T_s)/2 = (100 + 90)/2 = 95^\circ\text{C}$ are (Table A-9),

$$\begin{aligned}\rho_l &= 961.5 \text{ kg/m}^3 \\ \mu_l &= 0.297 \times 10^{-3} \text{ kg/m}\cdot\text{s} \\ \nu_l &= \mu_l / \rho_l = 0.309 \times 10^{-6} \text{ m}^2/\text{s} \\ c_{pl} &= 4212 \text{ J/kg}\cdot^\circ\text{C} \\ k_l &= 0.677 \text{ W/m}\cdot^\circ\text{C}\end{aligned}$$

Analysis The modified latent heat of vaporization is

$$\begin{aligned}h_{fg}^* &= h_{fg} + 0.68c_{pl}(T_{\text{sat}} - T_s) \\ &= 2257 \times 10^3 \text{ J/kg} + 0.68 \times 4212 \text{ J/kg}\cdot^\circ\text{C}(100 - 90)^\circ\text{C} \\ &= 2,286 \times 10^3 \text{ J/kg}\end{aligned}$$

Assuming wavy-laminar flow, the Reynolds number is determined from the vertical plate relation by replacing g by $g \cos \theta$ where $\theta = 60^\circ$ to be

$$\begin{aligned}\text{Re} &= \text{Re}_{\text{tilted,wavy}} = \left[4.81 + \frac{3.70Lk_l(T_{\text{sat}} - T_s)}{\mu_l h_{fg}^*} \left(\frac{g \cos 60}{\nu_l^2} \right)^{1/3} \right]^{0.820} \\ &= \left[4.81 + \frac{3.70 \times (3 \text{ m}) \times (0.677 \text{ W/m}\cdot^\circ\text{C}) \times (100 - 90)^\circ\text{C}}{(0.297 \times 10^{-3} \text{ kg/m}\cdot\text{s})(2286 \times 10^3 \text{ J/kg})} \left(\frac{(9.8 \text{ m/s}^2) \cos 60}{(0.309 \times 10^{-6} \text{ m}^2/\text{s})^2} \right)^{1/3} \right]^{0.82} = 920.5\end{aligned}$$

which is between 30 and 1800, and thus our assumption of wavy laminar flow is verified. Then the condensation heat transfer coefficient is determined from

$$\begin{aligned}h &= h_{\text{tilted,wavy}} = \frac{\text{Re} k_l}{1.08 \text{Re}^{1.22} - 5.2} \left(\frac{g \cos \theta}{\nu_l^2} \right)^{1/3} \\ &= \frac{920.5 \times (0.677 \text{ W/m}\cdot^\circ\text{C})}{1.08(920.5)^{1.22} - 5.2} \left(\frac{(9.8 \text{ m/s}^2) \cos 60}{(0.309 \times 10^{-6} \text{ m}^2/\text{s})^2} \right)^{1/3} = 5196 \text{ W/m}^2 \cdot^\circ\text{C}\end{aligned}$$

The heat transfer surface area of the plate is $A_s = W \times L = (3 \text{ m})(8 \text{ m}) = 24 \text{ m}^2$.

Then the rate of heat transfer during this condensation process becomes

$$\dot{Q} = hA_s(T_{\text{sat}} - T_s) = (5196 \text{ W/m}^2 \cdot^\circ\text{C})(24 \text{ m}^2)(100 - 90)^\circ\text{C} = 1,247,040 \text{ W} = \mathbf{1247 \text{ kW}}$$

(b) The rate of condensation of steam is determined from

$$\dot{m}_{\text{condensation}} = \frac{\dot{Q}}{h_{fg}^*} = \frac{1,247,040 \text{ J/s}}{2286 \times 10^3 \text{ J/kg}} = \mathbf{0.546 \text{ kg/s}}$$

Discussion Using the heat transfer coefficient determined in the previous problem for the vertical plate, we could also determine the heat transfer coefficient from $h_{\text{inclined}} = h_{\text{vert}}(\cos \theta)^{1/4}$. It would give $5280 \text{ W/m}^2 \cdot^\circ\text{C}$, which is 2.3% different than the value determined above.

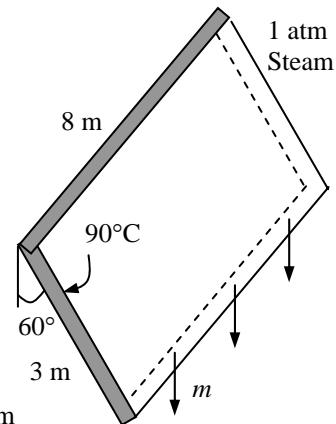

10-51 Saturated steam condenses outside of vertical tube. The rate of heat transfer to the coolant, the rate of condensation and the thickness of the condensate layer at the bottom are to be determined.

Assumptions 1 Steady operating conditions exist. 2 The tube is isothermal. 3 The tube can be treated as a vertical plate. 4 The condensate flow is wavy-laminar over the entire tube (this assumption will be verified). 5 Nusselt's analysis can be used to determine the thickness of the condensate film layer. 6 The density of vapor is much smaller than the density of liquid, $\rho_v \ll \rho_l$.

Properties The properties of water at the saturation temperature of 30°C are $h_{fg} = 2431 \times 10^3 \text{ J/kg}$ and $\rho_v = 0.03 \text{ kg/m}^3$. The properties of liquid water at the film temperature of $T_f = (T_{\text{sat}} + T_s)/2 = (30 + 20)/2 = 25^\circ\text{C}$ are (Table A-9),

$$\begin{aligned}\rho_l &= 997.0 \text{ kg/m}^3 \\ \mu_l &= 0.891 \times 10^{-3} \text{ kg/m}\cdot\text{s} \\ \nu_l &= \mu_l / \rho_l = 0.894 \times 10^{-6} \text{ m}^2/\text{s} \\ c_{pl} &= 4180 \text{ J/kg}\cdot^\circ\text{C} \\ k_l &= 0.607 \text{ W/m}\cdot^\circ\text{C}\end{aligned}$$

Analysis (a) The modified latent heat of vaporization is

$$\begin{aligned}h_{fg}^* &= h_{fg} + 0.68c_{pl}(T_{\text{sat}} - T_s) \\ &= 2431 \times 10^3 \text{ J/kg} + 0.68 \times 4180 \text{ J/kg}\cdot^\circ\text{C}(30 - 20)^\circ\text{C} = 2459 \times 10^3 \text{ J/kg}\end{aligned}$$

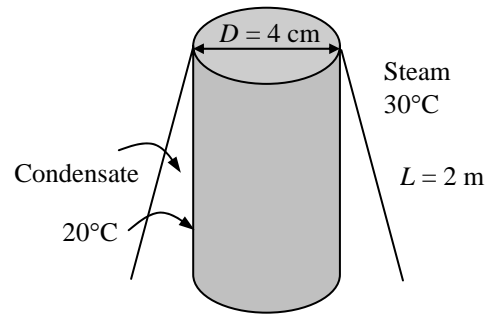

Assuming wavy-laminar flow, the Reynolds number is determined from

$$\begin{aligned}\text{Re} &= \text{Re}_{\text{vertical,wavy}} = \left[4.81 + \frac{3.70Lk_l(T_{\text{sat}} - T_s)}{\mu_l h_{fg}^*} \left(\frac{g}{\nu_l^2} \right)^{1/3} \right]^{0.820} \\ &= \left[4.81 + \frac{3.70 \times (2 \text{ m}) \times (0.607 \text{ W/m}\cdot^\circ\text{C}) \times (30 - 20)^\circ\text{C}}{(0.891 \times 10^{-3} \text{ kg/m}\cdot\text{s})(2459 \times 10^3 \text{ J/kg})} \left(\frac{9.8 \text{ m/s}^2}{(0.894 \times 10^{-6} \text{ m}^2/\text{s})^2} \right)^{1/3} \right]^{0.82} = 157.3\end{aligned}$$

which is between 30 and 1800, and thus our assumption of wavy laminar flow is verified. Then the condensation heat transfer coefficient is determined to be

$$\begin{aligned}h &= h_{\text{vertical,wavy}} = \frac{\text{Re} k_l}{1.08 \text{Re}^{1.22} - 5.2} \left(\frac{g}{\nu_l^2} \right)^{1/3} \\ &= \frac{157.3 \times (0.607 \text{ W/m}\cdot^\circ\text{C})}{1.08(157.3)^{1.22} - 5.2} \left(\frac{9.8 \text{ m/s}^2}{(0.894 \times 10^{-6} \text{ m}^2/\text{s})^2} \right)^{1/3} = 4302 \text{ W/m}^2\cdot^\circ\text{C}\end{aligned}$$

The heat transfer surface area of the tube is $A_s = \pi DL = \pi(0.04 \text{ m})(2 \text{ m}) = 0.2513 \text{ m}^2$. Then the rate of heat transfer during this condensation process becomes

$$\dot{Q} = hA_s(T_{\text{sat}} - T_s) = (4302 \text{ W/m}^2\cdot^\circ\text{C})(0.2513 \text{ m}^2)(30 - 20)^\circ\text{C} = \mathbf{10,811 \text{ W}}$$

(b) The rate of condensation of steam is determined from

$$\dot{m}_{\text{condensation}} = \frac{\dot{Q}}{h_{fg}^*} = \frac{10,811 \text{ J/s}}{2459 \times 10^3 \text{ J/kg}} = \mathbf{4.40 \times 10^{-3} \text{ kg/s}}$$

(c) Combining equations $\delta_L = k_l / h_l$ and $h = (4/3)h_L$, the thickness of the liquid film at the bottom of the tube is determined to be

$$\delta_L = \frac{4k_l}{3h} = \frac{4(0.607 \text{ W/m}\cdot^\circ\text{C})}{3(4302 \text{ W/m}^2\cdot^\circ\text{C})} = 0.188 \times 10^{-3} \text{ m} = \mathbf{0.2 \text{ mm}}$$

10-52E Saturated steam at a saturation temperature of $T_{\text{sat}} = 95^\circ\text{F}$ condenses on the outer surfaces of horizontal pipes which are maintained at 65°F by circulating cooling water. The rate of heat transfer to the cooling water and the rate of condensation per unit length of a single horizontal pipe are to be determined.

Assumptions 1 Steady operating conditions exist. 2 The pipe is isothermal. 3 There is no interference between the pipes (no drip of the condensate from one tube to another).

Properties The properties of water at the saturation temperature of 95°F are $h_{fg} = 1040 \text{ Btu/lbm}$ and $\rho_v = 0.0025 \text{ lbm/ft}^3$. The properties of liquid water at the film temperature of $T_f = (T_{\text{sat}} + T_s) / 2 = (95 + 65) / 2 = 80^\circ\text{F}$ are (Table A-9E),

$$\begin{aligned}\rho_l &= 62.22 \text{ lbm/ft}^3 \\ \mu_l &= 5.764 \times 10^{-4} \text{ lbm/ft} \cdot \text{s} = 2.075 \text{ lbm/ft} \cdot \text{h} \\ \nu_l &= \mu_l / \rho_l = 0.03335 \text{ ft}^2 / \text{h} \\ c_{pl} &= 0.999 \text{ Btu/lbm} \cdot ^\circ\text{F} \\ k_l &= 0.352 \text{ Btu/h} \cdot \text{ft} \cdot ^\circ\text{F}\end{aligned}$$

Analysis The modified latent heat of vaporization is

$$\begin{aligned}h_{fg}^* &= h_{fg} + 0.68c_{pl}(T_{\text{sat}} - T_s) \\ &= 1040 \text{ Btu/lbm} + 0.68 \times (0.999 \text{ Btu/lbm} \cdot ^\circ\text{F})(95 - 65)^\circ\text{F} \\ &= 1060 \text{ Btu/lbm}\end{aligned}$$

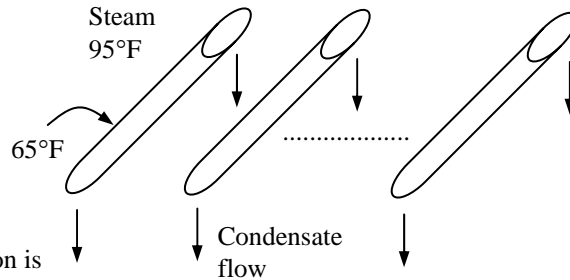

Noting that we have condensation on a horizontal tube, the heat transfer coefficient is determined from

$$\begin{aligned}h &= h_{\text{horiz}} = 0.729 \left[\frac{g\rho_l(\rho_l - \rho_v)h_{fg}^*k_l^3}{\mu_l(T_{\text{sat}} - T_s)D} \right]^{1/4} \\ &= 0.729 \left[\frac{(32.2 \text{ ft/s}^2)(62.22 \text{ lbm/ft}^3)(62.22 - 0.0025 \text{ lbm/ft}^3)(1060 \text{ Btu/lbm})(0.352 \text{ Btu/h} \cdot \text{ft} \cdot ^\circ\text{F})^3}{[(1 \text{ h}/3600 \text{ s})^2](2.075 \text{ lbm/ft} \cdot \text{h})(95 - 65)^\circ\text{F}(1/12 \text{ ft})} \right]^{1/4} \\ &= 1420 \text{ Btu/h} \cdot \text{ft}^2 \cdot ^\circ\text{F}\end{aligned}$$

The heat transfer surface area of the tube per unit length is

$$A_s = \pi DL = \pi(1/12 \text{ ft})(1 \text{ ft}) = 0.2618 \text{ ft}^2$$

Then the rate of heat transfer during this condensation process becomes

$$\dot{Q} = hA_s(T_{\text{sat}} - T_s) = (1420 \text{ Btu/h} \cdot \text{ft}^2 \cdot ^\circ\text{F})(0.2618 \text{ ft}^2)(95 - 65)^\circ\text{F} = \mathbf{11,150 \text{ Btu/h}}$$

(b) The rate of condensation of steam is determined from

$$\dot{m}_{\text{condensation}} = \frac{\dot{Q}}{h_{fg}^*} = \frac{11,150 \text{ Btu/h}}{1060 \text{ Btu/lbm}} = \mathbf{10.52 \text{ lbm/h}}$$

10-53E Saturated steam at a saturation temperature of $T_{\text{sat}} = 95^\circ\text{F}$ condenses on the outer surfaces of 20 horizontal pipes which are maintained at 65°F by circulating cooling water and arranged in a rectangular array of 4 pipes high and 5 pipes wide. The rate of heat transfer to the cooling water and the rate of condensation per unit length of the pipes are to be determined.

Assumptions 1 Steady operating conditions exist. 2 The pipes are isothermal.

Properties The properties of water at the saturation temperature of 95°F are $h_{fg} = 1040 \text{ Btu/lbm}$ and $\rho_v = 0.0025 \text{ lbm/ft}^3$. The properties of liquid water at the film temperature of $T_f = (T_{\text{sat}} + T_s) / 2 = (95 + 65) / 2 = 80^\circ\text{F}$ are (Table A-9E),

$$\begin{aligned}\rho_l &= 62.22 \text{ lbm/ft}^3 \\ \mu_l &= 5.764 \times 10^{-4} \text{ lbm/ft} \cdot \text{s} = 2.075 \text{ lbm/ft} \cdot \text{h} \\ \nu_l &= \mu_l / \rho_l = 0.03335 \text{ ft}^2/\text{h} \\ c_{pl} &= 0.999 \text{ Btu/lbm} \cdot ^\circ\text{F} \\ k_l &= 0.352 \text{ Btu/h} \cdot \text{ft} \cdot ^\circ\text{F}\end{aligned}$$

Analysis The modified latent heat of vaporization is

$$\begin{aligned}h_{fg}^* &= h_{fg} + 0.68c_{pl}(T_{\text{sat}} - T_s) \\ &= 1040 \text{ Btu/lbm} + 0.68 \times (0.999 \text{ Btu/lbm} \cdot ^\circ\text{F})(95 - 65)^\circ\text{F} \\ &= 1060 \text{ Btu/lbm}\end{aligned}$$

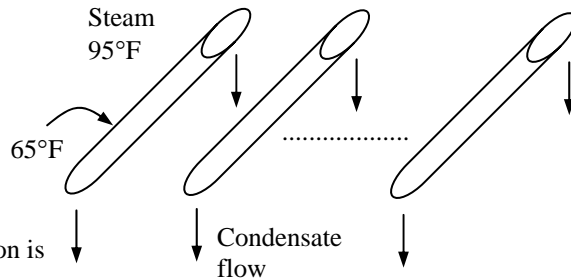

Noting that we have condensation on a horizontal tube, the heat transfer coefficient is determined from

$$\begin{aligned}h &= h_{\text{horiz}} = 0.729 \left[\frac{g\rho_l(\rho_l - \rho_v)h_{fg}^*k_l^3}{\mu_l(T_{\text{sat}} - T_s)D} \right]^{1/4} \\ &= 0.729 \left[\frac{(32.2 \text{ ft/s}^2)(62.22 \text{ lbm/ft}^3)(62.22 - 0.0025 \text{ lbm/ft}^3)(1060 \text{ Btu/lbm})(0.352 \text{ Btu/h} \cdot \text{ft} \cdot ^\circ\text{F})^3}{[(1 \text{ h}/3600 \text{ s})^2](2.075 \text{ lbm/ft} \cdot \text{h})(95 - 65)^\circ\text{F}(1/12 \text{ ft})} \right]^{1/4} \\ &= 1420 \text{ Btu/h} \cdot \text{ft}^2 \cdot ^\circ\text{F}\end{aligned}$$

Then the average heat transfer coefficient for a 4-pipe high vertical tier becomes

$$h_{\text{horiz, N tubes}} = \frac{1}{N^{1/4}} h_{\text{horiz, 1 tube}} = \frac{1}{4^{1/4}} (1420 \text{ Btu/h} \cdot \text{ft}^2 \cdot ^\circ\text{F}) = 1004 \text{ Btu/h} \cdot \text{ft}^2 \cdot ^\circ\text{F}$$

The surface area for all 32 pipes per unit length of the pipes is

$$A_s = N_{\text{total}} \pi DL = 32\pi(1/12 \text{ ft})(1 \text{ ft}) = 8.378 \text{ ft}^2$$

Then the rate of heat transfer during this condensation process becomes

$$\dot{Q} = hA_s(T_{\text{sat}} - T_s) = (1004 \text{ Btu/h} \cdot \text{ft}^2 \cdot ^\circ\text{F})(8.378 \text{ ft}^2)(95 - 65)^\circ\text{F} = \mathbf{252,345 \text{ Btu/h}}$$

(b) The rate of condensation of steam is determined from

$$\dot{m}_{\text{condensation}} = \frac{\dot{Q}}{h_{fg}^*} = \frac{252,345 \text{ Btu/h}}{1060 \text{ Btu/lbm}} = \mathbf{238.1 \text{ lbm/h}}$$

10-54 Saturated steam at a saturation temperature of $T_{\text{sat}} = 55^\circ\text{C}$ condenses on the outer surface of a vertical tube which is maintained at 45°C . The required tube length to condense steam at a rate of 10 kg/h is to be determined.

Assumptions **1** Steady operating conditions exist. **2** The tube is isothermal. **3** The vertical tube can be treated as a vertical plate. **4** The density of vapor is much smaller than the density of liquid, $\rho_v \ll \rho_l$.

Properties The properties of water at the saturation temperature of 55°C are $h_{fg} = 2371 \times 10^3 \text{ J/kg}$ and $\rho_v = 0.1045 \text{ kg/m}^3$. The properties of liquid water at the film temperature of $T_f = (T_{\text{sat}} + T_s) / 2 = (55 + 45) / 2 = 50^\circ\text{C}$ are (Table A-9),

$$\begin{aligned}\rho_l &= 988.1 \text{ kg/m}^3 \\ \mu_l &= 0.547 \times 10^{-3} \text{ kg/m} \cdot \text{s} \\ \nu_l &= \mu_l / \rho_l = 0.554 \times 10^{-6} \text{ m}^2/\text{s} \\ c_{pl} &= 4181 \text{ J/kg} \cdot ^\circ\text{C} \\ k_l &= 0.644 \text{ W/m} \cdot ^\circ\text{C}\end{aligned}$$

Analysis The modified latent heat of vaporization is

$$\begin{aligned}h_{fg}^* &= h_{fg} + 0.68c_{pl}(T_{\text{sat}} - T_s) \\ &= 2371 \times 10^3 \text{ J/kg} + 0.68 \times 4181 \text{ J/kg} \cdot ^\circ\text{C} (55 - 45)^\circ\text{C} = 2399 \times 10^3 \text{ J/kg}\end{aligned}$$

The Reynolds number is determined from its definition to be

$$\text{Re} = \frac{4\dot{m}}{p\mu_l} = \frac{4(10/3600 \text{ kg/s})}{\pi(0.03 \text{ m})(0.547 \times 10^{-3} \text{ kg/m} \cdot \text{s})} = 215.5$$

which is between 30 and 1800. Therefore the condensate flow is wavy laminar, and the condensation heat transfer coefficient is determined from

$$\begin{aligned}h &= h_{\text{vertical,wavy}} = \frac{\text{Re} k_l}{1.08 \text{Re}^{1.22} - 5.2} \left(\frac{g}{\nu_l^2} \right)^{1/3} \\ &= \frac{215.5 \times (0.644 \text{ W/m} \cdot ^\circ\text{C})}{1.08(215.5)^{1.22} - 5.2} \left(\frac{9.8 \text{ m/s}^2}{(0.554 \times 10^{-6} \text{ m}^2/\text{s})^2} \right)^{1/3} = 5644 \text{ W/m}^2 \cdot ^\circ\text{C}\end{aligned}$$

The rate of heat transfer during this condensation process is

$$\dot{Q} = \dot{m}h_{fg}^* = (10/3600 \text{ kg/s})(2399 \times 10^3 \text{ J/kg}) = 6,664 \text{ W}$$

Heat transfer can also be expressed as

$$\dot{Q} = hA_s(T_{\text{sat}} - T_s) = h(\pi DL)(T_{\text{sat}} - T_s)$$

Then the required length of the tube becomes

$$L = \frac{\dot{Q}}{h(\pi D)(T_{\text{sat}} - T_s)} = \frac{6664 \text{ W}}{(5644 \text{ W/m}^2 \cdot ^\circ\text{C})\pi(0.03 \text{ m})(55 - 45)^\circ\text{C}} = \mathbf{1.21 \text{ m}}$$

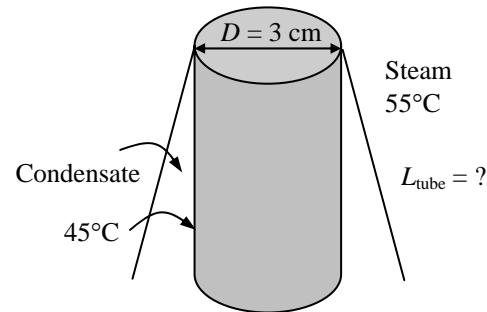

10-55 Saturated steam at a saturation temperature of $T_{\text{sat}} = 55^\circ\text{C}$ condenses on the outer surface of a horizontal tube which is maintained at 45°C . The required tube length to condense steam at a rate of 10 kg/h is to be determined.

Assumptions 1 Steady operating conditions exist. 2 The tube is isothermal.

Properties The properties of water at the saturation temperature of 55°C are $h_{fg} = 2371 \times 10^3 \text{ J/kg}$ and $\rho_v = 0.1045 \text{ kg/m}^3$. The properties of liquid water at the film temperature of $T_f = (T_{\text{sat}} + T_s) / 2 = (55 + 45) / 2 = 50^\circ\text{C}$ are (Table A-9),

$$\begin{aligned}\rho_l &= 988.1 \text{ kg/m}^3 \\ \mu_l &= 0.547 \times 10^{-3} \text{ kg/m}\cdot\text{s} \\ \nu_l &= \mu_l / \rho_l = 0.554 \times 10^{-6} \text{ m}^2/\text{s} \\ c_{pl} &= 4181 \text{ J/kg}\cdot^\circ\text{C} \\ k_l &= 0.644 \text{ W/m}\cdot^\circ\text{C}\end{aligned}$$

Analysis The modified latent heat of vaporization is

$$\begin{aligned}h_{fg}^* &= h_{fg} + 0.68c_{pl}(T_{\text{sat}} - T_s) \\ &= 2371 \times 10^3 \text{ J/kg} + 0.68 \times 4181 \text{ J/kg}\cdot^\circ\text{C}(55 - 45)^\circ\text{C} = 2399 \times 10^3 \text{ J/kg}\end{aligned}$$

Noting that the tube is horizontal, the condensation heat transfer coefficient is determined from

$$\begin{aligned}h &= h_{\text{horizontal}} = 0.729 \left[\frac{g\rho_l(\rho_l - \rho_v)h_{fg}^*k_l^3}{\mu_l(T_{\text{sat}} - T_s)D} \right]^{1/4} \\ &= 0.729 \left[\frac{(9.8 \text{ m/s}^2)(988.1 \text{ kg/m}^3)(988.1 - 0.10 \text{ kg/m}^3)(2399 \times 10^3 \text{ J/kg})(0.644 \text{ W/m}\cdot^\circ\text{C})^3}{(0.547 \times 10^{-3} \text{ kg/m}\cdot\text{s})(55 - 45)^\circ\text{C}(0.03 \text{ m})} \right]^{1/4} \\ &= 10,135 \text{ W/m}^2\cdot^\circ\text{C}\end{aligned}$$

The rate of heat transfer during this condensation process is

$$\dot{Q} = \dot{m}h_{fg}^* = (10 / 3600 \text{ kg/s})(2399 \times 10^3 \text{ J/kg}) = 6,664 \text{ W}$$

Heat transfer can also be expressed as

$$\dot{Q} = hA_s(T_{\text{sat}} - T_s) = h(\pi DL)(T_{\text{sat}} - T_s)$$

Then the required length of the tube becomes

$$L = \frac{\dot{Q}}{h(\pi D)(T_{\text{sat}} - T_s)} = \frac{6664 \text{ W}}{(10,135 \text{ W/m}^2\cdot^\circ\text{C})\pi(0.03 \text{ m})(55 - 45)^\circ\text{C}} = \mathbf{0.70 \text{ m}}$$

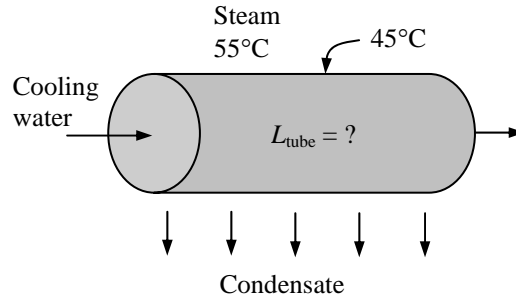

10-56 Saturated steam at a saturation temperature of $T_{\text{sat}} = 100^\circ\text{C}$ condenses on a plate which is tilted 40° from the vertical and maintained at 80°C by circulating cooling water through the other side. The rate of heat transfer to the plate and the rate of condensation of the steam are to be determined.

Assumptions **1** Steady operating conditions exist. **2** The plate is isothermal. **3** The condensate flow is wavy-laminar over the entire plate (this assumption will be verified). **4** The density of vapor is much smaller than the density of liquid, $\rho_v \ll \rho_l$.

Properties The properties of water at the saturation temperature of 100°C are $h_{fg} = 2257 \times 10^3 \text{ J/kg}$ and $\rho_v = 0.60 \text{ kg/m}^3$. The properties of liquid water at the film temperature of $T_f = (T_{\text{sat}} + T_s) / 2 = (100 + 80) / 2 = 90^\circ\text{C}$ are (Table A-9),

$$\begin{aligned}\rho_l &= 965.3 \text{ kg/m}^3 \\ \mu_l &= 0.315 \times 10^{-3} \text{ kg/m} \cdot \text{s} \\ \nu_l &= \mu_l / \rho_l = 0.326 \times 10^{-6} \text{ m}^2/\text{s} \\ c_{pl} &= 4206 \text{ J/kg} \cdot ^\circ\text{C} \\ k_l &= 0.675 \text{ W/m} \cdot ^\circ\text{C}\end{aligned}$$

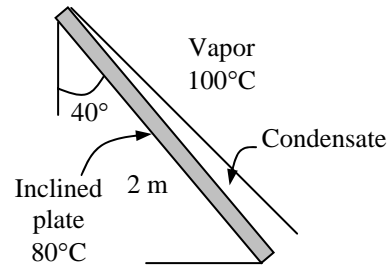

Analysis The modified latent heat of vaporization is

$$\begin{aligned}h_{fg}^* &= h_{fg} + 0.68c_{pl}(T_{\text{sat}} - T_s) \\ &= 2257 \times 10^3 \text{ J/kg} + 0.68 \times 4206 \text{ J/kg} \cdot ^\circ\text{C} (100 - 80)^\circ\text{C} = 2,314 \times 10^3 \text{ J/kg}\end{aligned}$$

Assuming wavy-laminar flow, the Reynolds number is determined from the vertical plate relation by replacing g by $g \cos \theta$ where $\theta = 60^\circ$ to be

$$\begin{aligned}\text{Re} &= \text{Re}_{\text{tilted, wavy}} = \left[4.81 + \frac{3.70 L k_l (T_{\text{sat}} - T_s)}{\mu_l h_{fg}^*} \left(\frac{g \cos \theta}{\nu_l^2} \right)^{1/3} \right]^{0.820} \\ &= \left[4.81 + \frac{3.70 \times (2 \text{ m}) \times (0.675 \text{ W/m} \cdot ^\circ\text{C}) \times (100 - 80)^\circ\text{C}}{(0.315 \times 10^{-3} \text{ kg/m} \cdot \text{s}) (2314 \times 10^3 \text{ J/kg})} \left(\frac{(9.8 \text{ m/s}^2) \cos 40}{(0.326 \times 10^{-6} \text{ m}^2/\text{s})^2} \right)^{1/3} \right]^{0.82} = 1197\end{aligned}$$

which is between 30 and 1800, and thus our assumption of wavy laminar flow is verified. Then the condensation heat transfer coefficient is determined from

$$\begin{aligned}h &= h_{\text{tilted, wavy}} = \frac{\text{Re} k_l}{1.08 \text{Re}^{1.22} - 5.2} \left(\frac{g \cos \theta}{\nu_l^2} \right)^{1/3} \\ &= \frac{1197 \times (0.675 \text{ W/m} \cdot ^\circ\text{C})}{1.08(1197)^{1.22} - 5.2} \left(\frac{(9.8 \text{ m/s}^2) \cos 40}{(0.326 \times 10^{-6} \text{ m}^2/\text{s})^2} \right)^{1/3} = 5438 \text{ W/m}^2 \cdot ^\circ\text{C}\end{aligned}$$

The heat transfer surface area of the plate is: $A = w \times L = (2 \text{ m})(2 \text{ m}) = 4 \text{ m}^2$.

Then the rate of heat transfer during this condensation process becomes

$$\dot{Q} = hA(T_{\text{sat}} - T_s) = (5438 \text{ W/m}^2 \cdot ^\circ\text{C})(4 \text{ m}^2)(100 - 80)^\circ\text{C} = 435,000 \text{ W}$$

(b) The rate of condensation of steam is determined from

$$\dot{m}_{\text{condensation}} = \frac{\dot{Q}}{h_{fg}^*} = \frac{435,000 \text{ J/s}}{2314 \times 10^3 \text{ J/kg}} = 0.188 \text{ kg/s}$$

Discussion We could also determine the heat transfer coefficient from $h_{\text{inclined}} = h_{\text{vert}} (\cos \theta)^{1/4}$.

10-57 EES Prob. 10-56 is reconsidered. The effects of plate temperature and the angle of the plate from the vertical on the average heat transfer coefficient and the rate at which the condensate drips off are to be investigated.

Analysis The problem is solved using EES, and the solution is given below.

"GIVEN"

T_sat=100 [C]
L=2 [m]
theta=40 [degrees]
T_s=80 [C]

"PROPERTIES"

Fluid\$='steam_IAPWS'
T_f=1/2*(T_sat+T_s)
P_sat=pressure(Fluid\$, T=T_sat, x=1)
rho_l=density(Fluid\$, T=T_f, x=0)
mu_l=Viscosity(Fluid\$, T=T_f, x=0)
nu_l=mu_l/rho_l
C_l=CP(Fluid\$, T=T_f, x=0)*Convert(kJ/kg-C, J/kg-C)
k_l=Conductivity(Fluid\$, T=T_f, P=P_sat+1)
h_f=enthalpy(Fluid\$, T=T_sat, x=0)
h_g=enthalpy(Fluid\$, T=T_sat, x=1)
h_fg=(h_g-h_f)*Convert(kJ/kg, J/kg)
g=9.8 [m/s^2]

"ANALYSIS"

"(a)"

h_fg_star=h_fg+0.68*C_l*(T_sat-T_s)
Re=(4.81+(3.7*L*k_l*(T_sat-T_s))/(mu_l*h_fg_star))*((g*cos(theta))/nu_l^2)^(1/3)^0.820
h=(Re*k_l)/(1.08*Re^1.22-5.2)*((g*cos(theta))/nu_l^2)^(1/3)
Q_dot=h*A*(T_sat-T_s)

A=L^2

"(b)"

m_dot_cond=Q_dot/h_fg_star

T _s [C]	h [W/m ² .C]	m _{cond} [kg/s]
40	4073	0.4027
42.5	4131	0.3926
45	4191	0.3821
47.5	4253	0.3712
50	4317	0.3599
52.5	4383	0.3482
55	4453	0.3361
57.5	4525	0.3235
60	4601	0.3105
62.5	4681	0.2971
65	4766	0.2832
67.5	4857	0.2687
70	4954	0.2538
72.5	5059	0.2383
75	5173	0.2222
77.5	5299	0.2055
80	5440	0.1881
82.5	5600	0.1699
85	5786	0.151
87.5	6009	0.1311
90	6285	0.11

θ [degrees]	h [$W/m^2 \cdot C$]	m_{cond} [kg/s]
0	5851	0.2023
3	5848	0.2022
6	5842	0.202
9	5831	0.2016
12	5815	0.2011
15	5796	0.2004
18	5771	0.1995
21	5742	0.1985
24	5708	0.1974
27	5669	0.196
30	5625	0.1945
33	5576	0.1928
36	5522	0.1909
39	5462	0.1888
42	5395	0.1865
45	5323	0.184
48	5243	0.1813
51	5156	0.1783
54	5061	0.175
57	4956	0.1714
60	4842	0.1674

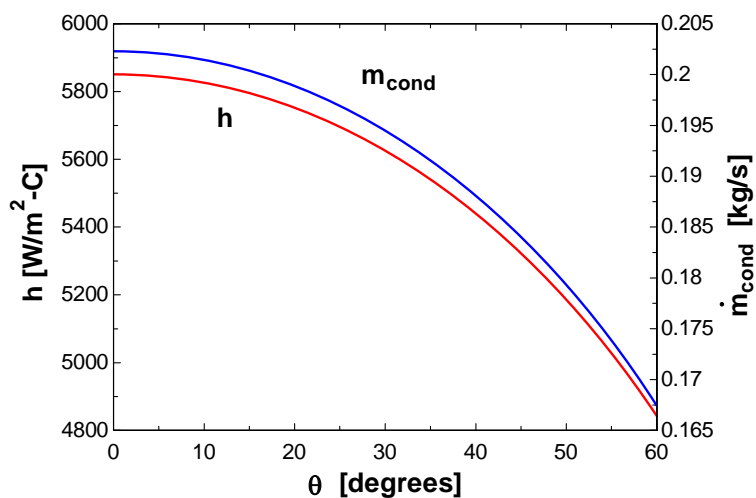
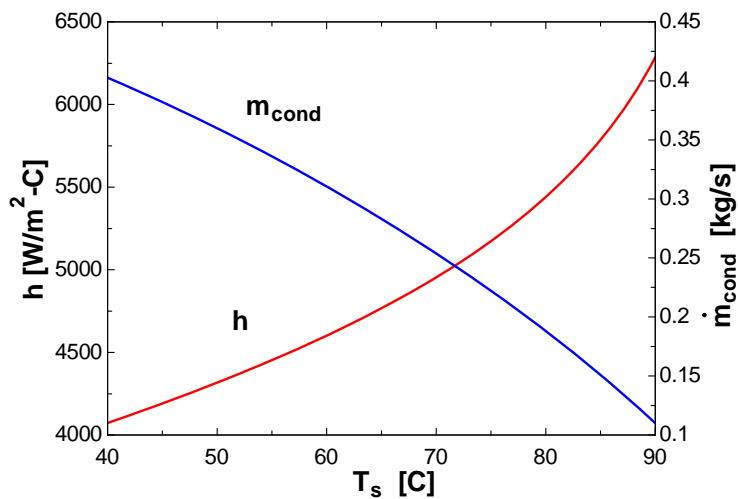

10-58 Saturated ammonia vapor at a saturation temperature of $T_{\text{sat}} = 10^\circ\text{C}$ condenses on the outer surface of a horizontal tube which is maintained at -10°C . The rate of heat transfer from the ammonia and the rate of condensation of ammonia are to be determined.

Assumptions 1 Steady operating conditions exist. 2 The tube is isothermal.

Properties The properties of ammonia at the saturation temperature of 10°C are $h_{fg} = 1226 \times 10^3 \text{ J/kg}$ and $\rho_v = 4.870 \text{ kg/m}^3$ (Table A-11). The properties of liquid ammonia at the film temperature of $T_f = (T_{\text{sat}} + T_s)/2 = (10 + (-10))/2 = 0^\circ\text{C}$ are (Table A-11),

$$\begin{aligned}\rho_l &= 638.6 \text{ kg/m}^3 \\ \mu_l &= 1.896 \times 10^{-4} \text{ kg/m} \cdot \text{s} \\ \nu_l &= 0.2969 \times 10^{-6} \text{ m}^2/\text{s} \\ c_{pl} &= 4617 \text{ J/kg} \cdot ^\circ\text{C} \\ k_l &= 0.5390 \text{ W/m} \cdot ^\circ\text{C}\end{aligned}$$

Analysis The modified latent heat of vaporization is

$$\begin{aligned}h_{fg}^* &= h_{fg} + 0.68c_{pl}(T_{\text{sat}} - T_s) \\ &= 1226 \times 10^3 \text{ J/kg} + 0.68 \times 4617 \text{ J/kg} \cdot ^\circ\text{C} [10 - (-10)]^\circ\text{C} = 1288 \times 10^3 \text{ J/kg}\end{aligned}$$

Noting that the tube is horizontal, the condensation heat transfer coefficient is determined from

$$\begin{aligned}h &= h_{\text{horizontal}} = 0.729 \left[\frac{g\rho_l(\rho_l - \rho_v)h_{fg}^*k_l^3}{\mu_l(T_{\text{sat}} - T_s)D} \right]^{1/4} \\ &= 0.729 \left[\frac{(9.81 \text{ m/s}^2)(638.6 \text{ kg/m}^3)(638.6 - 4.870 \text{ kg/m}^3)(1288 \times 10^3 \text{ J/kg})(0.5390 \text{ W/m} \cdot ^\circ\text{C})^3}{(1.896 \times 10^{-4} \text{ kg/m} \cdot \text{s})[10 - (-10)]^\circ\text{C}(0.02 \text{ m})} \right]^{1/4} \\ &= 7390 \text{ W/m}^2 \cdot ^\circ\text{C}\end{aligned}$$

The heat transfer surface area of the tube is

$$A_s = \pi DL = \pi(0.04 \text{ m})(15 \text{ m}) = 1.885 \text{ m}^2$$

Then the rate of heat transfer during this condensation process becomes

$$\dot{Q} = hA_s(T_{\text{sat}} - T_s) = (7390 \text{ W/m}^2 \cdot ^\circ\text{C})(1.885 \text{ m}^2)[10 - (-10)]^\circ\text{C} = \mathbf{278,600 \text{ W}}$$

(b) The rate of condensation of ammonia is determined from

$$\dot{m}_{\text{condensation}} = \frac{\dot{Q}}{h_{fg}^*} = \frac{278,600 \text{ J/s}}{1288 \times 10^3 \text{ J/kg}} = \mathbf{0.216 \text{ kg/s}}$$

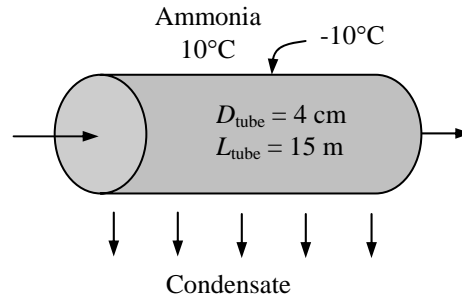

10-59 Saturated steam at a pressure of 4.25 kPa and thus at a saturation temperature of $T_{\text{sat}} = 30^\circ\text{C}$ (Table A-9) condenses on the outer surfaces of 100 horizontal tubes arranged in a 10×10 square array maintained at 20°C by circulating cooling water. The rate of heat transfer to the cooling water and the rate of condensation of steam on the tubes are to be determined.

Assumptions 1 Steady operating conditions exist. 2 The tubes are isothermal.

Properties The properties of water at the saturation temperature of 30°C are $h_{fg} = 2431 \times 10^3 \text{ J/kg}$ and $\rho_v = 0.03 \text{ kg/m}^3$. The properties of liquid water at the film temperature of $T_f = (T_{\text{sat}} + T_s) / 2 = (30 + 20) / 2 = 25^\circ\text{C}$ are (Table A-9),

$$\begin{aligned}\rho_l &= 997.0 \text{ kg/m}^3 \\ \mu_l &= 0.891 \times 10^{-3} \text{ kg/m} \cdot \text{s} \\ \nu_l &= \mu_l / \rho_l = 0.894 \times 10^{-6} \text{ m}^2/\text{s} \\ c_{pl} &= 4180 \text{ J/kg} \cdot ^\circ\text{C} \\ k_l &= 0.607 \text{ W/m} \cdot ^\circ\text{C}\end{aligned}$$

Analysis (a) The modified latent heat of vaporization is

$$\begin{aligned}h_{fg}^* &= h_{fg} + 0.68c_{pl}(T_{\text{sat}} - T_s) \\ &= 2431 \times 10^3 \text{ J/kg} + 0.68 \times 4180 \text{ J/kg} \cdot ^\circ\text{C} (30 - 20)^\circ\text{C} = 2,459 \times 10^3 \text{ J/kg}\end{aligned}$$

The heat transfer coefficient for condensation on a single horizontal tube is

$$\begin{aligned}h &= h_{\text{horizontal}} = 0.729 \left[\frac{g\rho_l(\rho_l - \rho_v)h_{fg}^*k_l^3}{\mu_l(T_{\text{sat}} - T_s)D} \right]^{1/4} \\ &= 0.729 \left[\frac{(9.8 \text{ m/s}^2)(997 \text{ kg/m}^3)(997 - 0.03 \text{ kg/m}^3)(2459 \times 10^3 \text{ J/kg})(0.607 \text{ W/m} \cdot ^\circ\text{C})^3}{(0.891 \times 10^{-3} \text{ kg/m} \cdot \text{s})(30 - 20)^\circ\text{C}(0.03 \text{ m})} \right]^{1/4} \\ &= 8674 \text{ W/m}^2 \cdot ^\circ\text{C}\end{aligned}$$

Then the average heat transfer coefficient for a 10-pipe high vertical tier becomes

$$h_{\text{horiz, N tubes}} = \frac{1}{N^{1/4}} h_{\text{horiz, 1 tube}} = \frac{1}{10^{1/4}} (8674 \text{ W/m}^2 \cdot ^\circ\text{C}) = 4878 \text{ W/m}^2 \cdot ^\circ\text{C}$$

The surface area for all 100 tubes is

$$A_s = N_{\text{total}} \pi D L = 100 \pi (0.03 \text{ m})(8 \text{ m}) = 75.40 \text{ m}^2$$

Then the rate of heat transfer during this condensation process becomes

$$\dot{Q} = h A_s (T_{\text{sat}} - T_s) = (4878 \text{ W/m}^2 \cdot ^\circ\text{C})(75.40 \text{ m}^2)(30 - 20)^\circ\text{C} = 3,678,000 \text{ W} = \mathbf{3678 \text{ kW}}$$

(b) The rate of condensation of steam is determined from

$$\dot{m}_{\text{condensation}} = \frac{\dot{Q}}{h_{fg}^*} = \frac{3,678,000 \text{ J/s}}{2459 \times 10^3 \text{ J/kg}} = \mathbf{1.496 \text{ kg/s}}$$

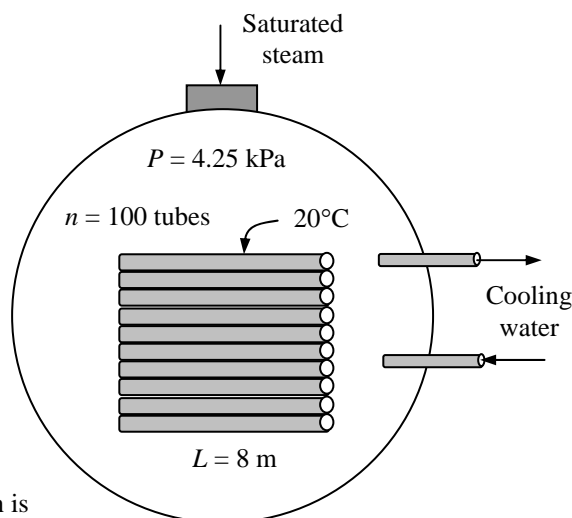

10-60 EES Prob. 10-59 is reconsidered. The effect of the condenser pressure on the rate of heat transfer and the rate of condensation of the steam is to be investigated.

Analysis The problem is solved using EES, and the solution is given below.

"GIVEN"

P_sat=4.25 [kPa]
 n_tube=100
 N=10
 L=8 [m]
 D=0.03 [m]
 T_s=20 [C]

"PROPERTIES"

Fluid\$='steam_IAPWS'
 T_sat=temperature(Fluid\$, P=P_sat, x=1)
 T_f=1/2*(T_sat+T_s)
 h_f=enthalpy(Fluid\$, T=T_sat, x=0)
 h_g=enthalpy(Fluid\$, T=T_sat, x=1)
 h_fg=(h_g-h_f)*Convert(kJ/kg, J/kg)
 rho_v=density(Fluid\$, T=T_sat, x=1)
 rho_l=density(Fluid\$, T=T_f, x=0)
 mu_l=Viscosity(Fluid\$, T=T_f, x=0)
 nu_l=mu_l/rho_l
 C_l=CP(Fluid\$, T=T_f, x=0)*Convert(kJ/kg-C, J/kg-C)
 k_l=Conductivity(Fluid\$, T=T_f, P=P_sat+1)
 g=9.8 [m/s^2]

"ANALYSIS"

h_fg_star=h_fg+0.68*C_l*(T_sat-T_s)
 h_1tube=0.729*((g*rho_l*(rho_l-rho_v)*h_fg_star*k_l^3)/(mu_l*(T_sat-T_s)*D))^0.25
 h=1/N^0.25*h_1tube
 Q_dot=h*A*(T_sat-T_s)
 A=n_tube*pi*D*L
 m_dot_cond=Q_dot/h_fg_star

P _{sat} [kPa]	Q [W]	m _{cond} [kg/s]
3	1836032	0.7478
4	3376191	1.374
5	4497504	1.829
6	5399116	2.194
7	6160091	2.502
8	6814744	2.766
9	7402573	3.004
10	7932545	3.218
11	8415994	3.413
12	8861173	3.592
13	9274152	3.758
14	9659732	3.914
15	1002165	4.059
0		

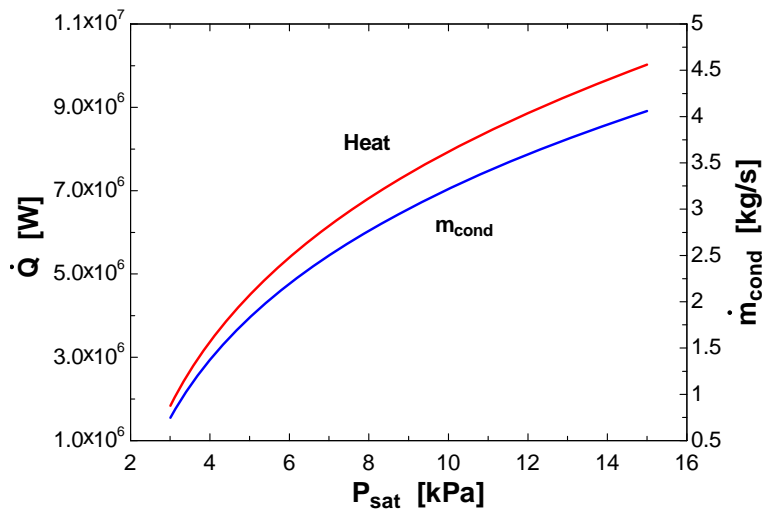

10-61 Saturated steam at a saturation temperature of $T_{\text{sat}} = 50^\circ\text{C}$ condenses on the outer surfaces of a tube bank with 33 tubes in each column maintained at 20°C . The average heat transfer coefficient and the rate of condensation of steam on the tubes are to be determined.

Assumptions 1 Steady operating conditions exist. 2 The tubes are isothermal.

Properties The properties of water at the saturation temperature of 50°C are $h_{fg} = 2383 \times 10^3 \text{ J/kg}$ and $\rho_v = 0.0831 \text{ kg/m}^3$. The properties of liquid water at the film temperature of $T_f = (T_{\text{sat}} + T_s) / 2 = (50 + 20) / 2 = 35^\circ\text{C}$ are (Table A-9),

$$\begin{aligned}\rho_l &= 994.0 \text{ kg/m}^3 \\ \mu_l &= 0.720 \times 10^{-3} \text{ kg/m}\cdot\text{s} \\ \nu_l &= \mu_l / \rho_l = 0.724 \times 10^{-6} \text{ m}^2/\text{s} \\ c_{pl} &= 4178 \text{ J/kg}\cdot^\circ\text{C} \\ k_l &= 0.623 \text{ W/m}\cdot^\circ\text{C}\end{aligned}$$

Analysis (a) The modified latent heat of vaporization is

$$\begin{aligned}h_{fg}^* &= h_{fg} + 0.68c_{pl}(T_{\text{sat}} - T_s) \\ &= 2383 \times 10^3 \text{ J/kg} + 0.68 \times 4178 \text{ J/kg}\cdot^\circ\text{C}(50 - 20)^\circ\text{C} \\ &= 2468 \times 10^3 \text{ J/kg}\end{aligned}$$

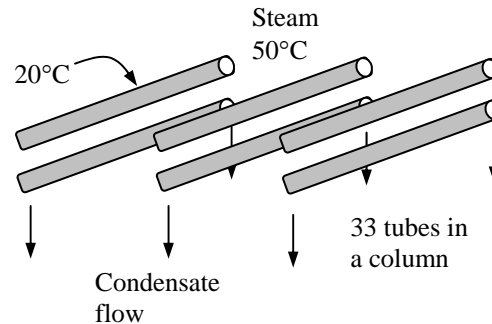

The heat transfer coefficient for condensation on a single horizontal tube is

$$\begin{aligned}h &= h_{\text{horizontal}} = 0.729 \left[\frac{g\rho_l(\rho_l - \rho_v)h_{fg}^*k_l^3}{\mu_l(T_{\text{sat}} - T_s)D} \right]^{1/4} \\ &= 0.729 \left[\frac{(9.8 \text{ m/s}^2)(994 \text{ kg/m}^3)(994 - 0.08 \text{ kg/m}^3)(2468 \times 10^3 \text{ J/kg})(0.623 \text{ W/m}\cdot^\circ\text{C})^3}{(0.720 \times 10^{-3} \text{ kg/m}\cdot\text{s})(50 - 20)^\circ\text{C}(0.015 \text{ m})} \right]^{1/4} \\ &= 8425 \text{ W/m}^2\cdot^\circ\text{C}\end{aligned}$$

Then the average heat transfer coefficient for a 33-tube high vertical tier becomes

$$h_{\text{horiz, N tubes}} = \frac{1}{N^{1/4}} h_{\text{horiz, 1 tube}} = \frac{1}{33^{1/4}} (8425 \text{ W/m}^2\cdot^\circ\text{C}) = \mathbf{3515 \text{ W/m}^2\cdot^\circ\text{C}}$$

The surface area for all 33 tubes per unit length is

$$A_s = N_{\text{total}} \pi DL = 33\pi(0.015 \text{ m})(1 \text{ m}) = 1.555 \text{ m}^2$$

Then the rate of heat transfer during this condensation process becomes

$$\dot{Q} = hA_s(T_{\text{sat}} - T_s) = (3515 \text{ W/m}^2\cdot^\circ\text{C})(1.555 \text{ m}^2)(50 - 20)^\circ\text{C} = 164,000 \text{ W}$$

(b) The rate of condensation of steam is determined from

$$\dot{m}_{\text{condensation}} = \frac{\dot{Q}}{h_{fg}^*} = \frac{164,000 \text{ J/s}}{2468 \times 10^3 \text{ J/kg}} = \mathbf{0.0664 \text{ kg/s}}$$

10-62 Saturated refrigerant-134a vapor at a saturation temperature of $T_{\text{sat}} = 30^\circ\text{C}$ condenses inside a horizontal tube which is maintained at 20°C . The fraction of the refrigerant that will condense at the end of the tube is to be determined.

Assumptions 1 Steady operating conditions exist. 2 The tube is isothermal. 3 The vapor velocity is low so that $\text{Re}_{\text{vapor}} < 35,000$.

Properties The properties of refrigerant-134a at the saturation temperature of 30°C are $h_{fg} = 173.1 \times 10^3$ J/kg and $\rho_v = 37.53$ kg/m³. The properties of liquid R-134a at the film temperature of $T_f = (T_{\text{sat}} + T_s) / 2 = (30 + 20) / 2 = 25^\circ\text{C}$ are (Table A-10)

$$\begin{aligned}\rho_l &= 1207 \text{ kg/m}^3 \\ \mu_l &= 2.012 \times 10^{-4} \text{ kg/m}\cdot\text{s} \\ \nu_l &= \mu_l / \rho_l = 0.1667 \times 10^{-6} \text{ m}^2/\text{s} \\ c_{pl} &= 1427 \text{ J/kg}\cdot^\circ\text{C} \\ k_l &= 0.08325 \text{ W/m}\cdot^\circ\text{C}\end{aligned}$$

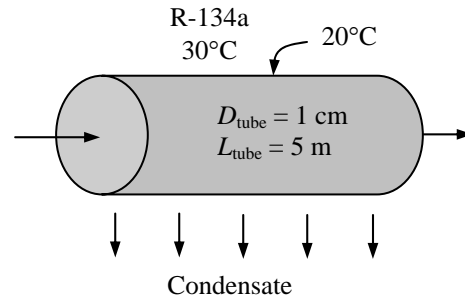

Analysis The heat transfer coefficient for condensation inside horizontal tubes is

$$\begin{aligned}h &= h_{\text{internal}} = 0.555 \left[\frac{g \rho_l (\rho_l - \rho_v) k_l^3}{\mu_l (T_{\text{sat}} - T_s)} \left(h_{fg} + \frac{3}{8} c_{pl} (T_{\text{sat}} - T_s) \right) \right]^{1/4} \\ &= 0.555 \left[\frac{(9.81 \text{ m/s}^2)(1207 \text{ kg/m}^3)(1207 - 37.53) \text{ kg/m}^3 (0.08325 \text{ W/m}\cdot^\circ\text{C})^3}{(2.012 \times 10^{-4} \text{ kg/m}\cdot\text{s})(30 - 20)^\circ\text{C}} \right. \\ &\quad \left. \times \left(173.1 \times 10^3 \text{ J/kg} + \frac{3}{8} (1427 \text{ J/kg}\cdot^\circ\text{C})(30 - 20)^\circ\text{C} \right) \right]^{1/4} \\ &= 509.2 \text{ W/m}^2 \cdot ^\circ\text{C}\end{aligned}$$

The heat transfer surface area of the pipe is

$$A_s = \pi DL = \pi(0.01 \text{ m})(5 \text{ m}) = 0.1571 \text{ m}^2$$

Then the rate of heat transfer during this condensation process becomes

$$\dot{Q} = hA_s(T_{\text{sat}} - T_s) = (509.2 \text{ W/m}^2 \cdot ^\circ\text{C})(0.1571 \text{ m}^2)(30 - 20)^\circ\text{C} = 800.0 \text{ W}$$

The modified latent heat of vaporization in this case is, as indicated in the h relation,

$$h_{fg}^* = h_{fg} + \frac{3}{8} c_{pl} (T_{\text{sat}} - T_s) = 173.1 \times 10^3 \text{ J/kg} + \frac{3}{8} (1427 \text{ J/kg}\cdot^\circ\text{C})(30 - 20)^\circ\text{C} = 178.5 \times 10^3 \text{ J/kg}$$

Then the rate of condensation becomes

$$\dot{m}_{\text{condensation}} = \frac{\dot{Q}}{h_{fg}^*} = \frac{800 \text{ J/s}}{178.5 \times 10^3 \text{ J/kg}} = 0.004482 \text{ kg/s} = 0.2689 \text{ kg/min}$$

Therefore, the fraction of the refrigerant that will condense at the end of the tube is

$$\text{Fraction condensed} = \frac{\dot{m}_{\text{condensed}}}{\dot{m}_{\text{total}}} = \frac{0.2689 \text{ kg/min}}{2.5 \text{ kg/min}} = \mathbf{0.108 \text{ (or 10.8\%)}}$$

Discussions Note that we used the modified h_{fg}^* instead of just h_{fg} in heat transfer calculations to account for heat transfer due to the cooling of the condensate below the saturation temperature.

10-63 Saturated refrigerant-134a vapor condenses inside a horizontal tube maintained at a uniform temperature. The fraction of the refrigerant that will condense at the end of the tube is to be determined.

Assumptions 1 Steady operating conditions exist. 2 The tube is isothermal. 3 The vapor velocity is low so that $Re_{\text{vapor}} < 35,000$.

Properties The properties of refrigerant-134a at the saturation temperature of 30°C are $h_{fg} = 173.1 \times 10^3$ J/kg and $\rho_v = 37.53$ kg/m³. The properties of liquid R-134a at the film temperature of $T_f = (T_{\text{sat}} + T_s) / 2 = (30 + 20) / 2 = 25^\circ\text{C}$ are (Table A-10)

$$\begin{aligned}\rho_l &= 1207 \text{ kg/m}^3 \\ \mu_l &= 2.012 \times 10^{-4} \text{ kg/m}\cdot\text{s} \\ \nu_l &= \mu_l / \rho_l = 0.1667 \times 10^{-6} \text{ m}^2/\text{s} \\ c_{pl} &= 1427 \text{ J/kg}\cdot^\circ\text{C} \\ k_l &= 0.0833 \text{ W/m}\cdot^\circ\text{C}\end{aligned}$$

Analysis The heat transfer coefficient for condensation inside horizontal tubes is

$$\begin{aligned}h &= h_{\text{internal}} = 0.555 \left[\frac{g\rho_l(\rho_l - \rho_v)k_l^3}{\mu_l(T_{\text{sat}} - T_s)} \left(h_{fg} + \frac{3}{8}c_{pl}(T_{\text{sat}} - T_s) \right) \right]^{1/4} \\ &= 0.555 \left[\frac{(9.81 \text{ m/s}^2)(1207 \text{ kg/m}^3)(1207 - 37.53) \text{ kg/m}^3(0.0833 \text{ W/m}\cdot^\circ\text{C})^3}{(2.012 \times 10^{-4} \text{ kg/m}\cdot\text{s})(30 - 20)^\circ\text{C}} \right. \\ &\quad \left. \times \left(173.1 \times 10^3 \text{ J/kg} + \frac{3}{8}(1427 \text{ J/kg}\cdot^\circ\text{C})(30 - 20)^\circ\text{C} \right) \right]^{1/4} \\ &= 509.4 \text{ W/m}^2\cdot^\circ\text{C}\end{aligned}$$

The heat transfer surface area of the pipe is

$$A_s = \pi DL = \pi(0.01 \text{ m})(8 \text{ m}) = 0.2513 \text{ m}^2$$

Then the rate of heat transfer during this condensation process becomes

$$\dot{Q} = hA_s(T_{\text{sat}} - T_s) = (509.4 \text{ W/m}^2\cdot^\circ\text{C})(0.2513 \text{ m}^2)(30 - 20)^\circ\text{C} = 1280 \text{ W}$$

The modified latent heat of vaporization in this case is, as indicated in the h relation,

$$h_{fg}^* = h_{fg} + \frac{3}{8}c_{pl}(T_{\text{sat}} - T_s) = 173.1 \times 10^3 \text{ J/kg} + \frac{3}{8}(1427 \text{ J/kg}\cdot^\circ\text{C})(30 - 20)^\circ\text{C} = 178.5 \times 10^3 \text{ J/kg}$$

Then the rate of condensation becomes

$$\dot{m}_{\text{condensation}} = \frac{\dot{Q}}{h_{fg}^*} = \frac{1280 \text{ J/s}}{178.5 \times 10^3 \text{ J/kg}} = 0.007169 \text{ kg/s} = 0.4301 \text{ kg/min}$$

Therefore, the fraction of the refrigerant that will condense at the end of the tube is

$$\text{Fraction condensed} = \frac{\dot{m}_{\text{condensed}}}{\dot{m}_{\text{total}}} = \frac{0.4301 \text{ kg/min}}{2.5 \text{ kg/min}} = \mathbf{0.172 \text{ (or 17.2%)}}$$

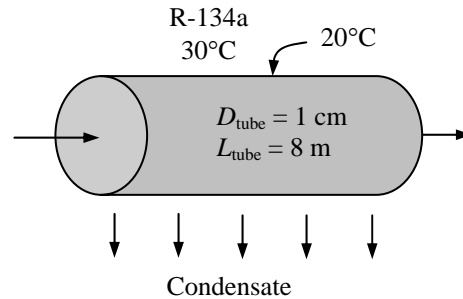

10-64 EES Prob. 10-62 is reconsidered. The the fraction of the refrigerant condensed at the end of the tube as a function of the temperature of the saturated R-134a vapor is to be plotted.

Analysis The problem is solved using EES, and the solution is given below.

"GIVEN"

T_sat=30 [C]
L=5 [m]
D=0.01 [m]
T_s=20 [C]
m_dot_total=2.5 [kg/min]

"PROPERTIES"

rho_l=1187 [kg/m^3]
rho_v=37.5 [kg/m^3]
mu_l=0.201E-3 [kg/m-s]
C_l=1447 [J/kg-C]
k_l=0.0796 [W/m-C]
h_fg=173.3E3 [J/kg]
g=9.8 [m/s^2] "gravitational acceleraton"

"ANALYSIS"

$h=0.555*((g*\rho_l*(\rho_l-\rho_v)*k_l^3)/(\mu_l*(T_{sat}-T_s))*(h_{fg}+3/8*C_l*(T_{sat}-T_s)))^{0.25}$
 $Q_{dot}=h*A*(T_{sat}-T_s)$
 $A=\pi*D*L$
 $m_{dot_cond}=Q_{dot}/h_{fg}*Convert(kg/s, kg/min)$
 $f_{condensed}=m_{dot_cond}/m_{dot_total}*Convert(, %)$

T _{sat} [C]	f _{condensed} [%]
25	6.293
26.25	7.447
27.5	8.546
28.75	9.603
30	10.62
31.25	11.62
32.5	12.58
33.75	13.53
35	14.45
36.25	15.36
37.5	16.26
38.75	17.14
40	18
41.25	18.86
42.5	19.7
43.75	20.53
45	21.36
46.25	22.18
47.5	22.98
48.75	23.78
50	24.58

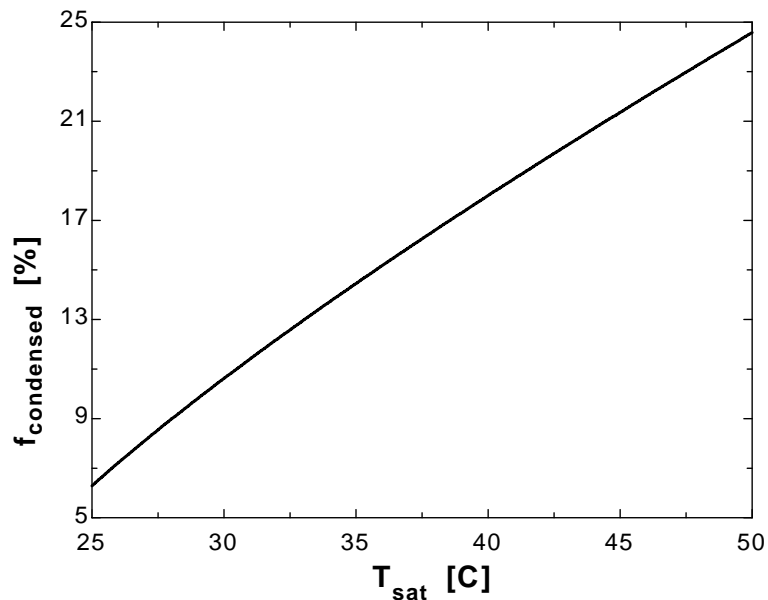

10-65 Saturated steam at a saturation temperature of $T_{\text{sat}} = 100^\circ\text{C}$ condenses on the outer surfaces of a tube bank maintained at 80°C . The rate of condensation of steam on the tubes are to be determined.

Assumptions 1 Steady operating conditions exist. 2 The tubes are isothermal.

Properties The properties of water at the saturation temperature of 100°C are $h_{fg} = 2257 \times 10^3 \text{ J/kg}$ and $\rho_v = 0.5978 \text{ kg/m}^3$ (Table A-9). The properties of liquid water at the film temperature of $T_f = (T_{\text{sat}} + T_s) / 2 = (100 + 80) / 2 = 90^\circ\text{C}$ are (Table A-9),

$$\begin{aligned}\rho_l &= 965.3 \text{ kg/m}^3 \\ \mu_l &= 0.315 \times 10^{-3} \text{ kg/m} \cdot \text{s} \\ c_{pl} &= 4206 \text{ J/kg} \cdot ^\circ\text{C} \\ k_l &= 0.675 \text{ W/m} \cdot ^\circ\text{C}\end{aligned}$$

Analysis (a) The modified latent heat of vaporization is

$$\begin{aligned}h_{fg}^* &= h_{fg} + 0.68c_{pl}(T_{\text{sat}} - T_s) \\ &= 2357 \times 10^3 \text{ J/kg} + 0.68 \times 4206 \text{ J/kg} \cdot ^\circ\text{C}(100 - 80)^\circ\text{C} \\ &= 2314 \times 10^3 \text{ J/kg}\end{aligned}$$

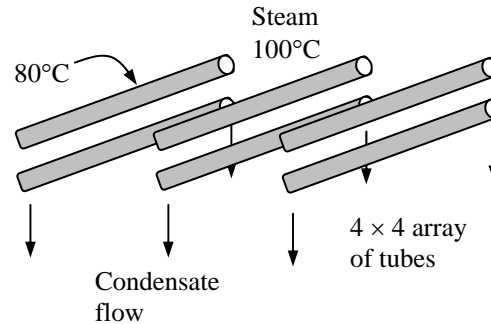

The heat transfer coefficient for condensation on a single horizontal tube is

$$\begin{aligned}h &= h_{\text{horizontal}} = 0.729 \left[\frac{g\rho_l(\rho_l - \rho_v)h_{fg}^*k_l^3}{\mu_l(T_{\text{sat}} - T_s)D} \right]^{1/4} \\ &= 0.729 \left[\frac{(9.8 \text{ m/s}^2)(965.3 \text{ kg/m}^3)(965.3 - 0.5978 \text{ kg/m}^3)(2314 \times 10^3 \text{ J/kg})(0.675 \text{ W/m} \cdot ^\circ\text{C})^3}{(0.315 \times 10^{-3} \text{ kg/m} \cdot \text{s})(100 - 80)^\circ\text{C}(0.05 \text{ m})} \right]^{1/4} \\ &= 8736 \text{ W/m}^2 \cdot ^\circ\text{C}\end{aligned}$$

Then the average heat transfer coefficient for a 4-pipe high vertical tier becomes

$$h_{\text{horiz, N tubes}} = \frac{1}{N^{1/4}} h_{\text{horiz, 1 tube}} = \frac{1}{4^{1/4}} (8736 \text{ W/m}^2 \cdot ^\circ\text{C}) = 6177 \text{ W/m}^2 \cdot ^\circ\text{C}$$

The surface area for all 16 tubes is

$$A_s = N_{\text{total}} \pi DL = 16\pi(0.05 \text{ m})(2 \text{ m}) = 5.027 \text{ m}^2$$

Then the rate of heat transfer during this condensation process becomes

$$\dot{Q} = hA_s(T_{\text{sat}} - T_s) = (6177 \text{ W/m}^2 \cdot ^\circ\text{C})(5.027 \text{ m}^2)(100 - 80)^\circ\text{C} = 621,000 \text{ W}$$

The rate of condensation of steam is determined from

$$\dot{m}_{\text{condensation}} = \frac{\dot{Q}}{h_{fg}^*} = \frac{621,000 \text{ J/s}}{2314 \times 10^3 \text{ J/kg}} = 0.2684 \text{ kg/s} = \mathbf{966 \text{ kg/h}}$$

10-66 Saturated ammonia at a saturation temperature of $T_{\text{sat}} = 30^\circ\text{C}$ condenses on vertical plates which are maintained at 10°C . The average heat transfer coefficient and the rate of condensation of ammonia are to be determined.

Assumptions 1 Steady operating conditions exist. 2 The plate is isothermal. 3 The condensate flow is wavy-laminar over the entire plate (this assumption will be verified). 4 The density of vapor is much smaller than the density of liquid, $\rho_v \ll \rho_l$.

Properties The properties of ammonia at the saturation temperature of 30°C are $h_{fg} = 1144 \times 10^3 \text{ J/kg}$ and $\rho_v = 9.055 \text{ kg/m}^3$. The properties of liquid ammonia at the film temperature of $T_f = (T_{\text{sat}} + T_s) / 2 = (30 + 10) / 2 = 20^\circ\text{C}$ are (Table A-11),

$$\begin{aligned}\rho_l &= 610.2 \text{ kg/m}^3 \\ \mu_l &= 1.519 \times 10^{-4} \text{ kg/m} \cdot \text{s} \\ \nu_l &= \mu_l / \rho_l = 2.489 \times 10^{-7} \text{ m}^2/\text{s} \\ c_{pl} &= 4745 \text{ J/kg} \cdot ^\circ\text{C} \\ k_l &= 0.4927 \text{ W/m} \cdot ^\circ\text{C}\end{aligned}$$

Analysis The modified latent heat of vaporization is

$$\begin{aligned}h_{fg}^* &= h_{fg} + 0.68c_{pl}(T_{\text{sat}} - T_s) \\ &= 1144 \times 10^3 \text{ J/kg} + 0.68 \times 4745 \text{ J/kg} \cdot ^\circ\text{C}(30 - 10)^\circ\text{C} \\ &= 1209 \times 10^3 \text{ J/kg}\end{aligned}$$

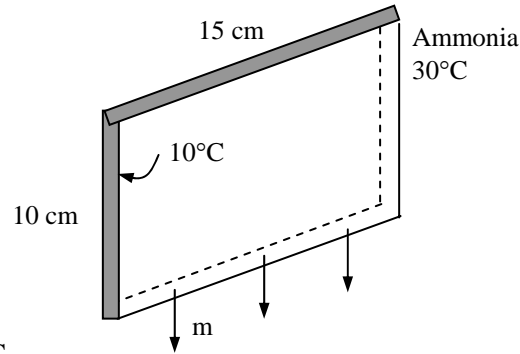

Assuming wavy-laminar flow, the Reynolds number is determined from

$$\begin{aligned}\text{Re} &= \text{Re}_{\text{vertical,wavy}} = \left[4.81 + \frac{3.70Lk_l(T_{\text{sat}} - T_s)}{\mu_l h_{fg}^*} \left(\frac{g}{\nu_l^2} \right)^{1/3} \right]^{0.820} \\ &= \left[4.81 + \frac{3.70 \times (0.1 \text{ m}) \times (0.4927 \text{ W/m} \cdot ^\circ\text{C}) \times (30 - 10)^\circ\text{C}}{(1.519 \times 10^{-4} \text{ kg/m} \cdot \text{s})(1209 \times 10^3 \text{ J/kg})} \left(\frac{9.8 \text{ m/s}^2}{(2.489 \times 10^{-7} \text{ m}^2/\text{s})^2} \right)^{1/3} \right]^{0.82} = 307.0\end{aligned}$$

which is between 30 and 1800, and thus our assumption of wavy laminar flow is verified. Then the condensation heat transfer coefficient is determined to be

$$\begin{aligned}h &= h_{\text{vertical,wavy}} = \frac{\text{Re} k_l}{1.08 \text{Re}^{1.22} - 5.2} \left(\frac{g}{\nu_l^2} \right)^{1/3} \\ &= \frac{307 \times (0.4927 \text{ W/m} \cdot ^\circ\text{C})}{1.08(307)^{1.22} - 5.2} \left(\frac{9.8 \text{ m/s}^2}{(2.489 \times 10^{-7} \text{ m}^2/\text{s})^2} \right)^{1/3} = \mathbf{7032 \text{ W/m}^2 \cdot ^\circ\text{C}}\end{aligned}$$

The total heat transfer surface area of the plates is

$$A_s = W \times L = 20(0.15 \text{ m})(0.10 \text{ m}) = 0.3 \text{ m}^2$$

Then the rate of heat transfer during this condensation process becomes

$$\dot{Q} = hA_s(T_{\text{sat}} - T_s) = (7032 \text{ W/m}^2 \cdot ^\circ\text{C})(0.3 \text{ m}^2)(30 - 10)^\circ\text{C} = 42,190 \text{ W}$$

(b) The rate of condensation of steam is determined from

$$\dot{m}_{\text{condensation}} = \frac{\dot{Q}}{h_{fg}^*} = \frac{42,190 \text{ J/s}}{1209 \times 10^3 \text{ J/kg}} = \mathbf{0.0349 \text{ kg/s}}$$

Special Topic: Heat Pipes

10-67C A heat pipe is a simple device with no moving parts which can transfer large quantities of heat over fairly large distances essentially at a constant temperature without requiring any power input. A heat pipe is basically a sealed slender tube containing a wick structure lined on the inner surface and a small amount of fluid such as water at the saturated state. It is composed of three sections: the evaporator section at one end where heat is absorbed and the fluid is vaporized, a condenser section at the other end where the vapor is condensed and heat is rejected, and the adiabatic section in between where the vapor and the liquid phases of the fluid flow in opposite directions through the core and the wick, respectively, to complete the cycle with no significant heat transfer between the fluid and the surrounding medium.

10-68C The boiling and condensation processes are associated with extremely high heat transfer coefficients, and thus it is natural to expect the heat pipe to be an extremely effective heat transfer device since its operation is based on alternate boiling and condensation of the working fluid.

10-69C The non-condensable gases such as air degrade the performance of the heat pipe, and can destroy it in a short time.

10-70C The heat pipes with water as the working fluid are designed to remove heat at temperatures below the boiling temperature of water at atmospheric pressure (i.e., 100°C). Therefore, the pressure inside the heat pipe must be maintained below the atmospheric pressure to provide boiling at such temperatures.

10-71C Liquid motion in the wick depends on the dynamic balance between two opposing effects: the capillary pressure which pumps the liquid through the pores, and the internal resistance to flow due to the friction between the mesh surface and the liquid. Small pores increase the capillary action, but it also increases the friction force opposing the fluid motion. At optimum core size, the difference between the capillary force and the friction force is maximum.

10-72C The orientation of the heat pipe affects its performance. The performance of a heat pipe will be best when the capillary and gravity forces act in the same direction (evaporator end down), and it will be worst when these two forces act in opposite directions (evaporator end up).

10-73C The capillary pressure which creates the suction effect to draw the liquid forces the liquid in a heat pipe to move up against the gravity without a pump. For the heat pipes which work against the gravity, it is better to have fine wicks since the capillary pressure is inversely proportional to the effective capillary radius of the mesh.

10-74C The most important consideration in the design of a heat pipe is the compatibility of the materials used for the tube, wick and the fluid.

10-75C The major cause for the premature degradation of the performance of some heat pipes is contamination which occurs during the sealing of the ends of the heat pipe tube.

10-76 A 40-cm long cylindrical heat pipe dissipates heat at a rate of 150 W. The diameter and mass of a 40-cm long copper rod that can conduct heat at the same rate are to be determined.

Assumptions Steady operating conditions exist.

Properties The properties of copper are given to be $\rho = 8933 \text{ kg/m}^3$ and $k = 401 \text{ W/m}\cdot^\circ\text{C}$.

Analysis The rate of heat transfer through the copper rod can be expressed as

$$\dot{Q} = kA \frac{\Delta T}{L}$$

Solving for the cross-sectional area A and the diameter D gives

$$A = \frac{L}{k\Delta T} \dot{Q} = \frac{0.4 \text{ m}}{(401 \text{ W/m}\cdot^\circ\text{C})(4^\circ\text{C})} (150 \text{ W}) = 0.03741 \text{ m}^2 = 374.1 \text{ cm}^2$$

$$A = \frac{\pi D^2}{4} \longrightarrow D = \sqrt{\frac{4A}{\pi}} = \sqrt{\frac{4(374.1 \text{ cm}^2)}{\pi}} = \mathbf{21.8 \text{ cm}}$$

The mass of this copper rod is

$$m = \rho V = \rho AL = (8933 \text{ kg/m}^3)(0.03741 \text{ m}^2)(0.4 \text{ m}) = \mathbf{134 \text{ kg}}$$

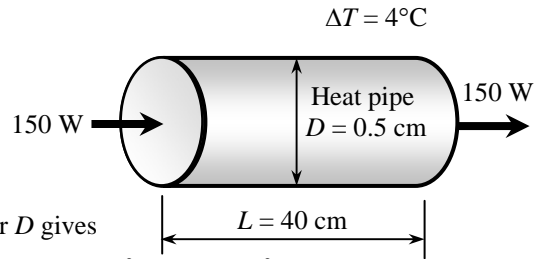

10-77 A 40-cm long cylindrical heat pipe dissipates heat at a rate of 150 W. The diameter and mass of a 40-cm long aluminum rod that can conduct heat at the same rate are to be determined.

Assumptions Steady operating conditions exist.

Properties The properties of aluminum at room temperature are $\rho = 2702 \text{ kg/m}^3$ and $k = 237 \text{ W/m}\cdot^\circ\text{C}$ (Table A-3).

Analysis The rate of heat transfer through the aluminum rod can be expressed as

$$\dot{Q} = kA \frac{\Delta T}{L}$$

Solving for the cross-sectional area A and the diameter D gives

$$A = \frac{L}{k\Delta T} \dot{Q} = \frac{0.4 \text{ m}}{(237 \text{ W/m}\cdot^\circ\text{C})(4^\circ\text{C})} (150 \text{ W}) = 0.06329 \text{ m}^2 = 632.9 \text{ cm}^2$$

$$A = \frac{\pi D^2}{4} \longrightarrow D = \sqrt{\frac{4A}{\pi}} = \sqrt{\frac{4(632.9 \text{ cm}^2)}{\pi}} = \mathbf{28.4 \text{ cm}}$$

The mass of this aluminum rod is

$$m = \rho V = \rho AL = (2702 \text{ kg/m}^3)(0.06329 \text{ m}^2)(0.4 \text{ m}) = \mathbf{68.4 \text{ kg}}$$

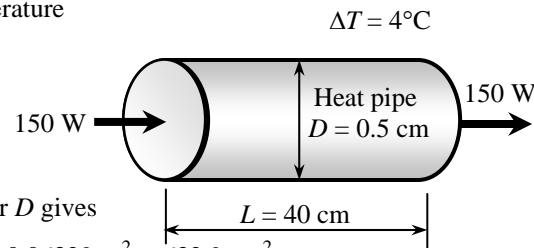

10-78E A plate that supports 10 power transistors is to be cooled with heat pipes. The number of pipes need to be attached to this plate is to be determined.

Assumptions Steady operating conditions exist.

Analysis The heat removal rate of heat pipes that have an outside diameter of 0.64 cm and length of 45.7 cm is given in Table 10-6 to be 150 W. The total rate of heat dissipated by 10 transistors each dissipating 45 W is

$$\dot{Q}_{total} = (10)(45 \text{ W}) = 450 \text{ W}$$

Then the number of heat pipes need to be attached to the plate becomes

$$n = \frac{\dot{Q}_{total}}{\dot{Q}} = \frac{450 \text{ W}}{150 \text{ W}} = \mathbf{3}$$

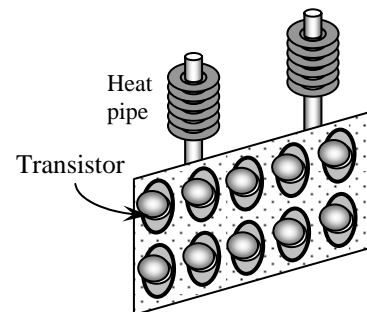

Review Problems

10-79 Water is boiled at $T_{\text{sat}} = 100^\circ\text{C}$ by a spherical platinum heating element immersed in water. The surface temperature is $T_s = 350^\circ\text{C}$. The boiling heat transfer coefficient is to be determined.

Assumptions 1 Steady operating conditions exist. 2 Heat losses from the heater and the boiler are negligible.

Properties The properties of water at the saturation temperature of 100°C are (Table A-9)

$$h_{fg} = 2257 \times 10^3 \text{ J/kg}$$

$$\rho_l = 957.9 \text{ kg/m}^3$$

The properties of water vapor at $(350+100)/2 = 225^\circ\text{C}$ are (Table A-16)

$$\rho_v = 0.444 \text{ kg/m}^3$$

$$\mu_v = 1.749 \times 10^{-5} \text{ kg/m} \cdot \text{s}$$

$$c_{pv} = 1951 \text{ J/kg} \cdot ^\circ\text{C}$$

$$k_v = 0.03581 \text{ W/m} \cdot ^\circ\text{C}$$

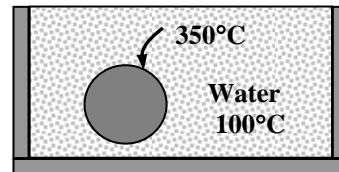

Analysis The film boiling occurs since the temperature difference between the surface and the fluid. The heat flux in this case can be determined from

$$\begin{aligned} \dot{q}_{\text{film}} &= 0.67 \left[\frac{g k_v^3 \rho_v (\rho_l - \rho_v) [h_{fg} + 0.4 c_{pv} (T_s - T_{\text{sat}})]}{\mu_v D (T_s - T_{\text{sat}})} \right]^{1/4} (T_s - T_{\text{sat}}) \\ &= 0.67 \left[\frac{(9.81)(0.03581)^3 (0.444)(957.9 - 0.444) [2257 \times 10^3 + 0.4(1951)(350 - 100)]}{(1.749 \times 10^{-5})(0.15)(350 - 100)} \right]^{1/4} (350 - 100) \\ &= 27,386 \text{ W/m}^2 \end{aligned}$$

The boiling heat transfer coefficient is

$$\dot{q}_{\text{film}} = h(T_s - T_{\text{sat}}) \longrightarrow h = \frac{\dot{q}_{\text{film}}}{T_s - T_{\text{sat}}} = \frac{27,386 \text{ W/m}^2}{(350 - 100)^\circ\text{C}} = \mathbf{109.5 \text{ W/m}^2 \cdot ^\circ\text{C}}$$

10-80 Water is boiled at $T_{\text{sat}} = 120^\circ\text{C}$ in a mechanically polished stainless steel pressure cooker whose inner surface temperature is maintained at $T_s = 130^\circ\text{C}$. The time it will take for the tank to empty is to be determined.

Assumptions 1 Steady operating conditions exist. 2 Heat losses from the heater and the boiler are negligible.

Properties The properties of water at the saturation temperature of 120°C are (Tables 10-1 and A-9)

$$\begin{aligned}\rho_l &= 943.4 \text{ kg/m}^3 & h_{fg} &= 2203 \times 10^3 \text{ J/kg} \\ \rho_v &= 1.121 \text{ kg/m}^3 & \mu_l &= 0.232 \times 10^{-3} \text{ kg/m}\cdot\text{s} \\ \sigma &= 0.0550 \text{ N/m} & c_{pl} &= 4244 \text{ J/kg}\cdot^\circ\text{C} \\ \text{Pr}_l &= 1.44\end{aligned}$$

Also, $C_{sf} = 0.0130$ and $n = 1.0$ for the boiling of water on a mechanically polished stainless steel surface (Table 10-3). Note that we expressed the properties in units specified under Eq. 10-2 in connection with their definitions in order to avoid unit manipulations.

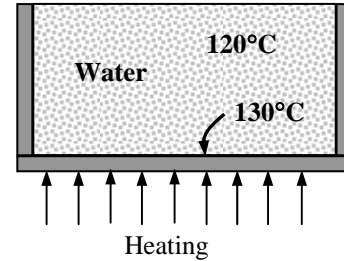

Analysis The excess temperature in this case is $\Delta T = T_s - T_{\text{sat}} = 130 - 120 = 10^\circ\text{C}$ which is relatively low (less than 30°C). Therefore, nucleate boiling will occur. The heat flux in this case can be determined from Rohsenow relation to be

$$\begin{aligned}\dot{q}_{\text{nucleate}} &= \mu_l h_{fg} \left[\frac{g(\rho_l - \rho_v)}{\sigma} \right]^{1/2} \left(\frac{c_{p,l}(T_s - T_{\text{sat}})}{C_{sf} h_{fg} \text{Pr}_l^n} \right)^3 \\ &= (0.232 \times 10^{-3})(2203 \times 10^3) \left[\frac{9.8(943.4 - 1.121)}{0.0550} \right]^{1/2} \left(\frac{4244(130 - 120)}{0.0130(2203 \times 10^3)1.44} \right)^3 \\ &= 228,400 \text{ W/m}^2\end{aligned}$$

The rate of heat transfer is

$$\dot{Q} = A \dot{q}_{\text{nucleate}} = \frac{1}{4} \pi (0.20 \text{ m})^2 (228,400 \text{ W/m}^2) = 7174 \text{ W}$$

The rate of evaporation is

$$\dot{m}_{\text{evap}} = \frac{\dot{Q}}{h_{fg}} = \frac{7174 \text{ W}}{2203 \times 10^3 \text{ kJ/kg}} = 0.003256 \text{ kg/s}$$

Noting that the tank is half-filled, the mass of the water and the time it will take for the tank to empty are

$$m = \frac{1}{2} \rho_l \mathcal{V} = \frac{1}{2} (943.4 \text{ kg/m}^3) \left[\pi (0.20 \text{ m})^2 / 4 \times (0.30 \text{ m}) \right] = 4.446 \text{ kg}$$

$$t = \frac{m}{\dot{m}_{\text{evap}}} = \frac{4.446 \text{ kg}}{0.003256 \text{ kg/s}} = 1365 \text{ s} = \mathbf{22.8 \text{ min}}$$

10-81 Saturated ammonia vapor at a saturation temperature of $T_{\text{sat}} = 25^\circ\text{C}$ condenses on the outer surfaces of a tube bank in which cooling water flows. The rate of condensation of ammonia, the overall heat transfer coefficient, and the tube length are to be determined.

Assumptions **1** Steady operating conditions exist. **2** The tubes are isothermal. **3** The thermal resistance of the tube walls is negligible.

Properties The properties of ammonia at the saturation temperature of 25°C are $h_{\text{fg}} = 1166 \times 10^3 \text{ J/kg}$ and $\rho_v = 7.809 \text{ kg/m}^3$ (Table A-11). We assume that the tube temperature is 20°C . Then, the properties of liquid ammonia at the film temperature of $T_f = (T_{\text{sat}} + T_s) / 2 = (25 + 20) / 2 = 22.5^\circ\text{C}$ are (Table A-11)

$$\begin{aligned}\rho_l &= 606.5 \text{ kg/m}^3 \\ \mu_l &= 1.479 \times 10^{-4} \text{ kg/m} \cdot \text{s} \\ c_{pl} &= 4765 \text{ J/kg} \cdot ^\circ\text{C} \\ k_l &= 0.4869 \text{ W/m} \cdot ^\circ\text{C}\end{aligned}$$

The water properties at the average temperature of $(14+17)/2 = 15.5^\circ\text{C}$ are (Table A-9)

$$\begin{aligned}\rho &= 999.0 \text{ kg/m}^3 \\ c_p &= 4185 \text{ J/kg} \cdot ^\circ\text{C} \\ \mu &= 1.124 \times 10^{-3} \text{ kg/m} \cdot \text{s} \\ k &= 0.590 \text{ W/m} \cdot ^\circ\text{C} \\ \text{Pr} &= 7.98\end{aligned}$$

Analysis (a) The modified latent heat of vaporization is

$$\begin{aligned}h_{fg}^* &= h_{fg} + 0.68c_{pl}(T_{\text{sat}} - T_s) \\ &= 1166 \times 10^3 \text{ J/kg} + 0.68 \times 4765 \text{ J/kg} \cdot ^\circ\text{C}(25 - 20)^\circ\text{C} \\ &= 1182 \times 10^3 \text{ J/kg}\end{aligned}$$

The heat transfer coefficient for condensation on a single horizontal tube is

$$\begin{aligned}h &= h_{\text{horizontal}} = 0.729 \left[\frac{g\rho_l(\rho_l - \rho_v)h_{fg}^*k_l^3}{\mu_l(T_{\text{sat}} - T_s)D} \right]^{1/4} \\ &= 0.729 \left[\frac{(9.8 \text{ m/s}^2)(606.5 \text{ kg/m}^3)(606.5 - 7.809 \text{ kg/m}^3)(1182 \times 10^3 \text{ J/kg})(0.4869 \text{ W/m} \cdot ^\circ\text{C})^3}{(1.479 \times 10^{-4} \text{ kg/m} \cdot \text{s})(25 - 20)^\circ\text{C}(0.025 \text{ m})} \right]^{1/4} \\ &= 9280 \text{ W/m}^2 \cdot ^\circ\text{C}\end{aligned}$$

Then the average heat transfer coefficient for a 4-pipe high vertical tier becomes

$$h_o = h_{\text{horiz, N tubes}} = \frac{1}{N^{1/4}} h_{\text{horiz, 1 tube}} = \frac{1}{4^{1/4}} (9280 \text{ W/m}^2 \cdot ^\circ\text{C}) = 6562 \text{ W/m}^2 \cdot ^\circ\text{C}$$

The rate of heat transfer in the condenser is

$$\begin{aligned}\dot{m} &= 16\rho A_c \mathbf{V} = 16(999 \text{ kg/m}^3)\pi(0.25)(0.025 \text{ m})^2(2 \text{ m/s}) = 15.69 \text{ kg/s} \\ \dot{Q} &= \dot{m}c_p(T_{\text{out}} - T_{\text{in}}) = (15.69 \text{ kg/s})(4185 \text{ J/kg} \cdot ^\circ\text{C})(17 - 14) = 1.970 \times 10^5 \text{ W}\end{aligned}$$

Then the rate of condensation becomes

$$\dot{m}_{\text{cond}} = \frac{\dot{Q}}{h_{fg}^*} = \frac{1.970 \times 10^5 \text{ W}}{1182 \times 10^3 \text{ J/kg}} = \mathbf{0.167 \text{ kg/s}}$$

(b) For the calculation of the heat transfer coefficient on the inner surfaces of the tubes, we first determine the Reynolds number

$$\text{Re} = \frac{VD\rho}{\mu} = \frac{(2 \text{ m/s})(0.025 \text{ m})(999.0 \text{ kg/m}^3)}{1.124 \times 10^{-3} \text{ kg/m} \cdot \text{s}} = 44,440$$

which is greater than 10,000. Therefore, the flow is turbulent. Assuming fully developed flow, the Nusselt number and the heat transfer coefficient are determined to be

$$Nu = 0.023 \text{ Re}^{0.8} \text{ Pr}^{0.4} = 0.023(44,440)^{0.8} (7.98)^{0.4} = 275.9$$

$$h_i = \frac{k}{D} Nu = \frac{(0.590 \text{ W/m} \cdot ^\circ\text{C})}{0.025 \text{ m}} (275.9) = 6511 \text{ W/m}^2 \cdot ^\circ\text{C}$$

Let us check if the assumed value for the tube temperature was reasonable

$$\begin{aligned} h_i \Delta T_i &= h_o \Delta T_o \\ (6511)(T_{\text{tube}} - 15.5) &= (6562)(25 - T_{\text{tube}}) \\ T_{\text{tube}} &= 20.3^\circ\text{C} \end{aligned}$$

which is sufficiently close to the assumed value of 20°C. Disregarding thermal resistance of the tube walls, the overall heat transfer coefficient is determined from

$$U = \left(\frac{1}{h_i} + \frac{1}{h_o} \right)^{-1} = \left(\frac{1}{6511} + \frac{1}{6562} \right)^{-1} = \mathbf{3268 \text{ W/m}^2 \cdot ^\circ\text{C}}$$

(c) The tube length may be determined from

$$\begin{aligned} \dot{Q} &= UA\Delta T \\ 1.970 \times 10^5 \text{ W} &= (3268 \text{ W/m}^2 \cdot ^\circ\text{C})(16) \pi (0.025 \text{ m}) L \left[25 - \frac{1}{2}(14 + 17) \right] \\ L &= \mathbf{5.05 \text{ m}} \end{aligned}$$

10-82 Steam at a saturation temperature of $T_{\text{sat}} = 40^\circ\text{C}$ condenses on the outside of a thin horizontal tube. Heat is transferred to the cooling water that enters the tube at 25°C and exits at 35°C . The rate of condensation of steam, the average overall heat transfer coefficient, and the tube length are to be determined.

Assumptions **1** Steady operating conditions exist. **2** The tube can be taken to be isothermal at the bulk mean fluid temperature in the evaluation of the condensation heat transfer coefficient. **3** Liquid flow through the tube is fully developed. **4** The thickness and the thermal resistance of the tube is negligible.

Properties The properties of water at the saturation temperature of 40°C are $h_{\text{fg}} = 2407 \times 10^3 \text{ J/kg}$ and $\rho_v = 0.05 \text{ kg/m}^3$. The properties of liquid water at the film temperature of $T_f = (T_{\text{sat}} + T_s) / 2 = (50 + 20) / 2 = 35^\circ\text{C}$ and at the bulk fluid temperature of $T_b = (T_{\text{in}} + T_{\text{out}}) / 2 = (25 + 35) / 2 = 30^\circ\text{C}$ are (Table A-9),

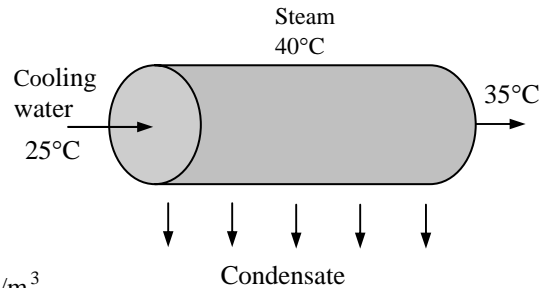

At 35°C :

$$\rho_l = 994.0 \text{ kg/m}^3$$

$$\mu_l = 0.720 \times 10^{-3} \text{ kg/m} \cdot \text{s}$$

$$c_{pl} = 4178 \text{ J/kg} \cdot ^\circ\text{C}$$

$$k_l = 0.623 \text{ W/m} \cdot ^\circ\text{C}$$

At 30°C :

$$\rho_l = 996.0 \text{ kg/m}^3$$

$$\nu_l = \mu_l / \rho_l = 0.801 \times 10^{-6} \text{ m}^2/\text{s}$$

$$c_{pl} = 4178 \text{ J/kg} \cdot ^\circ\text{C}$$

$$k_l = 0.615 \text{ W/m} \cdot ^\circ\text{C}$$

$$\text{Pr} = 5.42$$

Analysis The mass flow rate of water and the rate of heat transfer to the water are

$$\dot{m}_{\text{water}} = \rho V A_c = (996 \text{ kg/m}^3)(2 \text{ m/s})[\pi(0.03 \text{ m})^2 / 4] = 1.408 \text{ kg/s}$$

$$\dot{Q} = \dot{m} c_p (T_{\text{out}} - T_{\text{in}}) = (1.408 \text{ kg/s})(4178 \text{ J/kg} \cdot ^\circ\text{C})(35 - 25)^\circ\text{C} = \mathbf{58,820 \text{ W}}$$

The modified latent heat of vaporization is

$$\begin{aligned} h_{\text{fg}}^* &= h_{\text{fg}} + 0.68 c_{pl} (T_{\text{sat}} - T_s) \\ &= 2407 \times 10^3 \text{ J/kg} + 0.68 \times 4178 \text{ J/kg} \cdot ^\circ\text{C} (40 - 30)^\circ\text{C} = 2435 \times 10^3 \text{ J/kg} \end{aligned}$$

The heat transfer coefficient for condensation on a single horizontal tube is

$$\begin{aligned} h_o &= h_{\text{horizontal}} = 0.729 \left[\frac{g \rho_l (\rho_l - \rho_v) h_{\text{fg}}^* k_l^3}{\mu_l (T_{\text{sat}} - T_s) D} \right]^{1/4} \\ &= 0.729 \left[\frac{(9.8 \text{ m/s}^2)(994 \text{ kg/m}^3)(994 - 0.05 \text{ kg/m}^3)(2435 \times 10^3 \text{ J/kg})(0.623 \text{ W/m} \cdot ^\circ\text{C})^3}{(0.720 \times 10^{-3} \text{ kg/m} \cdot \text{s})(40 - 30)^\circ\text{C}(0.03 \text{ m})} \right]^{1/4} \\ &= 9292 \text{ W/m}^2 \cdot ^\circ\text{C} \end{aligned}$$

The average heat transfer coefficient for flow inside the tube is determined as follows:

$$\text{Re} = \frac{V_{\text{avg}} D}{\nu} = \frac{(2 \text{ m/s})(0.03 \text{ m})}{0.801 \times 10^{-6}} = 74,906$$

$$\text{Nu} = 0.023 \text{Re}^{0.8} \text{Pr}^{0.4} = 0.023(74,906)^{0.8} (5.42)^{0.4} = 359$$

$$h_i = \frac{k \text{Nu}}{D} = \frac{(0.615 \text{ W/m} \cdot ^\circ\text{C}) \times 359}{0.03 \text{ m}} = 7357 \text{ W/m}^2 \cdot ^\circ\text{C}$$

Noting that the thermal resistance of the tube is negligible, the overall heat transfer coefficient becomes

$$U = \frac{1}{1/h_i + 1/h_o} = \frac{1}{1/7357 + 1/9292} = \mathbf{4106 \text{ W/m}^2 \cdot ^\circ\text{C}}$$

The logarithmic mean temperature difference is:

$$\Delta T_{\ln} = \frac{\Delta T_i - \Delta T_e}{\ln(\Delta T_i / \Delta T_e)} = \frac{15 - 5}{\ln(15/5)} = 9.10^\circ\text{C}$$

The tube length is determined from

$$\dot{Q} = hA_s \Delta T_{\ln} \rightarrow L = \frac{\dot{Q}}{h(\pi D) \Delta T_{\ln}} = \frac{58,820 \text{ W}}{(4106 \text{ W/m}^2 \cdot ^\circ\text{C})\pi(0.03 \text{ m})(9.10^\circ\text{C})} = \mathbf{16.7 \text{ m}}$$

Note that the flow is turbulent, and thus the entry length in this case is $10D = 0.3 \text{ m}$ is much shorter than the total tube length. This verifies our assumption of fully developed flow.

10-83 Saturated ammonia at a saturation temperature of $T_{\text{sat}} = 25^\circ\text{C}$ condenses on the outer surface of vertical tube which is maintained at 15°C by circulating cooling water. The rate of heat transfer to the coolant and the rate of condensation of ammonia are to be determined.

Assumptions 1 Steady operating conditions exist. 2 The tube is isothermal. 3 The tube can be treated as a vertical plate. 4 The condensate flow is turbulent over the entire tube (this assumption will be verified). 5 The density of vapor is much smaller than the density of liquid, $\rho_v \ll \rho_l$.

Properties The properties of ammonia at the saturation temperature of 25°C are $h_{\text{fg}} = 1166 \times 10^3 \text{ J/kg}$ and $\rho_v = 7.809 \text{ kg/m}^3$. The properties of liquid ammonia at the film temperature of $T_f = (T_{\text{sat}} + T_s) / 2 = (25 + 15) / 2 = 20^\circ\text{C}$ are (Table A-11),

$$\begin{aligned}\rho_l &= 610.2 \text{ kg/m}^3 \\ \mu_l &= 1.519 \times 10^{-4} \text{ kg/m}\cdot\text{s} \\ \nu_l &= \mu_l / \rho_l = 0.2489 \times 10^{-6} \text{ m}^2/\text{s} \\ c_{pl} &= 4745 \text{ J/kg}\cdot^\circ\text{C} \\ k_l &= 0.4927 \text{ W/m}\cdot^\circ\text{C} \\ \text{Pr}_l &= 1.463\end{aligned}$$

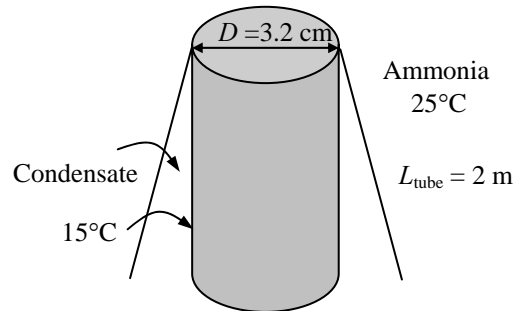

Analysis (a) The modified latent heat of vaporization is

$$\begin{aligned}h_{fg}^* &= h_{fg} + 0.68c_{pl}(T_{\text{sat}} - T_s) \\ &= 1166 \times 10^3 \text{ J/kg} + 0.68 \times 4745 \text{ J/kg}\cdot^\circ\text{C}(25 - 15)^\circ\text{C} = 1198 \times 10^3 \text{ J/kg}\end{aligned}$$

Assuming turbulent flow, the Reynolds number is determined from

$$\begin{aligned}\text{Re} &= \text{Re}_{\text{vertical,turb}} = \left[\frac{0.0690 L k_l \text{Pr}^{0.5} (T_{\text{sat}} - T_s) \left(\frac{g}{\nu_l^2} \right)^{1/3}}{\mu_l h_{fg}^*} - 151 \text{Pr}^{0.5} + 253 \right]^{4/3} \\ &= \left[\frac{0.0690 \times 2 \times 0.4927 (1.463)^{0.5} (25 - 15) \left(\frac{9.81}{(0.2489 \times 10^{-6} \text{ m}^2/\text{s})^2} \right)^{1/3}}{(1.519 \times 10^{-4} \text{ kg/m}\cdot\text{s})(1198 \times 10^3 \text{ J/kg})} - 151(1.463)^{0.5} + 253 \right]^{4/3} \\ &= 2142\end{aligned}$$

which is greater than 1800, and thus our assumption of turbulent flow is verified. Then the condensation heat transfer coefficient is determined from

$$\begin{aligned}h &= h_{\text{vertical,turbulent}} = \frac{\text{Re} k_l}{8750 + 58 \text{Pr}^{-0.5} (\text{Re}^{0.75} - 253)} \left(\frac{g}{\nu_l^2} \right)^{1/3} \\ &= \frac{2142 \times (0.4927 \text{ W/m}\cdot^\circ\text{C})}{8750 + 58 \times 1.463^{-0.5} (2142^{0.75} - 253)} \left(\frac{9.81 \text{ m/s}^2}{(0.2489 \times 10^{-6} \text{ m}^2/\text{s})^2} \right)^{1/3} = 4873 \text{ W/m}^2 \cdot^\circ\text{C}\end{aligned}$$

The heat transfer surface area of the tube is $A_s = \pi DL = \pi(0.032 \text{ m})(2 \text{ m}) = 0.2011 \text{ m}^2$. Then the rate of heat transfer during this condensation process becomes

$$\dot{Q} = hA_s(T_{\text{sat}} - T_s) = (4873 \text{ W/m}^2 \cdot^\circ\text{C})(0.2011 \text{ m}^2)(25 - 15)^\circ\text{C} = \mathbf{9800 \text{ W}}$$

(b) The rate of condensation of ammonia is determined from

$$\dot{m}_{\text{condensation}} = \frac{\dot{Q}}{h_{fg}^*} = \frac{9800 \text{ J/s}}{1198 \times 10^3 \text{ J/kg}} = \mathbf{8.180 \times 10^{-3} \text{ kg/s}}$$

10-84 There is film condensation on the outer surfaces of 8 horizontal tubes arranged in a horizontal or vertical tier. The ratio of the condensation rate for the cases of the tubes being arranged in a horizontal tier versus in a vertical tier is to be determined.

Assumptions Steady operating conditions exist.

Analysis The heat transfer coefficients for the two cases are related to the heat transfer coefficient on a single horizontal tube by

$$\text{Horizontal tier: } h_{\text{horizontal tier of N tubes}} = h_{\text{horizontal, 1 tube}}$$

$$\text{Vertical tier: } h_{\text{vertical tier of N tubes}} = \frac{h_{\text{horizontal, 1 tube}}}{N^{1/4}}$$

Therefore,

$$\begin{aligned} \text{Ratio} &= \frac{\dot{m}_{\text{horizontal tier of N tubes}}}{\dot{m}_{\text{vertical tier of N tubes}}} \\ &= \frac{h_{\text{horizontal tier of N tubes}}}{h_{\text{vertical tier of N tubes}}} \\ &= \frac{h_{\text{horizontal, 1 tube}}}{h_{\text{horizontal, 1 tube}} / N^{1/4}} \\ &= N^{1/4} \\ &= 8^{1/4} = \mathbf{1.68} \end{aligned}$$



Horizontal tier



Vertical tier

10-85E Saturated steam at a saturation pressure of 0.95 psia and thus at a saturation temperature of $T_{\text{sat}} = 100^\circ\text{F}$ (Table A-9E) condenses on the outer surfaces of 144 horizontal tubes which are maintained at 80°F by circulating cooling water and arranged in a 12×12 square array. The rate of heat transfer to the cooling water and the rate of condensation of steam are to be determined.

Assumptions 1 Steady operating conditions exist.
2 The tubes are isothermal.

Properties The properties of water at the saturation temperature of 100°F are $h_{fg} = 1037$ Btu/lbm and $\rho_v = 0.00286$ lbm/ft³. The properties of liquid water at the film temperature of $T_f = (T_{\text{sat}} + T_s)/2 = (100 + 80)/2 = 90^\circ\text{F}$ are (Table A-9E),

$$\begin{aligned}\rho_l &= 62.12 \text{ lbm/ft}^3 \\ \mu_l &= 5.117 \times 10^{-4} \text{ lbm/ft} \cdot \text{s} = 1.842 \text{ lbm/ft} \cdot \text{h} \\ \nu_l &= \mu_l / \rho_l = 0.02965 \text{ ft}^2/\text{h} \\ c_{pl} &= 0.999 \text{ Btu/lbm} \cdot ^\circ\text{F} \\ k_l &= 0.358 \text{ Btu/h} \cdot \text{ft} \cdot ^\circ\text{F}\end{aligned}$$

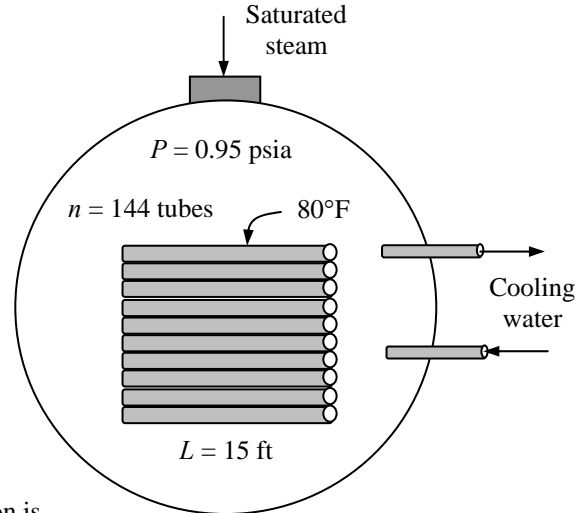

Analysis (a) The modified latent heat of vaporization is

$$\begin{aligned}h_{fg}^* &= h_{fg} + 0.68c_{pl}(T_{\text{sat}} - T_s) \\ &= 1037 \text{ Btu/lbm} + 0.68 \times (0.999 \text{ Btu/lbm} \cdot ^\circ\text{F})(100 - 80)^\circ\text{F} \\ &= 1051 \text{ Btu/lbm}\end{aligned}$$

The heat transfer coefficient for condensation on a single horizontal tube is

$$\begin{aligned}h &= h_{\text{horiz}} = 0.729 \left[\frac{g\rho_l(\rho_l - \rho_v)h_{fg}^*k_l^3}{\mu_l(T_{\text{sat}} - T_s)D} \right]^{1/4} \\ &= 0.729 \left[\frac{(32.2 \text{ ft/s}^2)(62.12 \text{ lbm/ft}^3)(62.12 - 0.00286 \text{ lbm/ft}^3)(1051 \text{ Btu/lbm})(0.358 \text{ Btu/h} \cdot \text{ft} \cdot ^\circ\text{F})^3}{[(1 \text{ h}/3600 \text{ s})^2](1.842 \text{ lbm/ft} \cdot \text{h})(100 - 80)^\circ\text{F}(1.2/12 \text{ ft})} \right]^{1/4} \\ &= 1562 \text{ Btu/h} \cdot \text{ft}^2 \cdot ^\circ\text{F}\end{aligned}$$

Then the average heat transfer coefficient for a 4-tube high vertical tier becomes

$$h_{\text{horiz, N tubes}} = \frac{1}{N^{1/4}} h_{\text{horiz, 1 tube}} = \frac{1}{12^{1/4}} (1562 \text{ Btu/h} \cdot \text{ft}^2 \cdot ^\circ\text{F}) = 839 \text{ Btu/h} \cdot \text{ft}^2 \cdot ^\circ\text{F}$$

The surface area for all 144 tubes is

$$A_s = N_{\text{total}} \pi DL = 144 \pi (1.2/12 \text{ ft})(15 \text{ ft}) = 678.6 \text{ ft}^2$$

Then the rate of heat transfer during this condensation process becomes

$$\dot{Q} = hA_s(T_{\text{sat}} - T_s) = (839 \text{ Btu/h} \cdot \text{ft}^2 \cdot ^\circ\text{F})(678.6 \text{ ft}^2)(100 - 80)^\circ\text{F} = \mathbf{11,387,000 \text{ Btu/h}}$$

(b) The rate of condensation of steam is determined from

$$\dot{m}_{\text{condensation}} = \frac{\dot{Q}}{h_{fg}^*} = \frac{11,387,000 \text{ Btu/h}}{1051 \text{ Btu/lbm}} = \mathbf{10,830 \text{ lbm/h}}$$

10-86E Saturated steam at a saturation pressure of 0.95 psia and thus at a saturation temperature of $T_{\text{sat}} = 100^\circ\text{F}$ (Table A-9E) condenses on the outer surfaces of 144 horizontal tubes which are maintained at 80°F by circulating cooling water and arranged in a 12×12 square array. The rate of heat transfer to the cooling water and the rate of condensation of steam are to be determined.

Assumptions 1 Steady operating conditions exist.
2 The tubes are isothermal.

Properties The properties of water at the saturation temperature of 100°F are $h_{fg} = 1037$ Btu/lbm and $\rho_v = 0.00286$ lbm/ft³. The properties of liquid water at the film temperature of $T_f = (T_{\text{sat}} + T_s)/2 = (100 + 80)/2 = 90^\circ\text{F}$ are (Table A-9E),

$$\begin{aligned}\rho_l &= 62.12 \text{ lbm/ft}^3 \\ \mu_l &= 5.117 \times 10^{-4} \text{ lbm/ft} \cdot \text{s} = 1.842 \text{ lbm/ft} \cdot \text{h} \\ \nu_l &= \mu_l / \rho_l = 0.02965 \text{ ft}^2/\text{h} \\ c_{pl} &= 0.999 \text{ Btu/lbm} \cdot ^\circ\text{F} \\ k_l &= 0.358 \text{ Btu/h} \cdot \text{ft} \cdot ^\circ\text{F}\end{aligned}$$

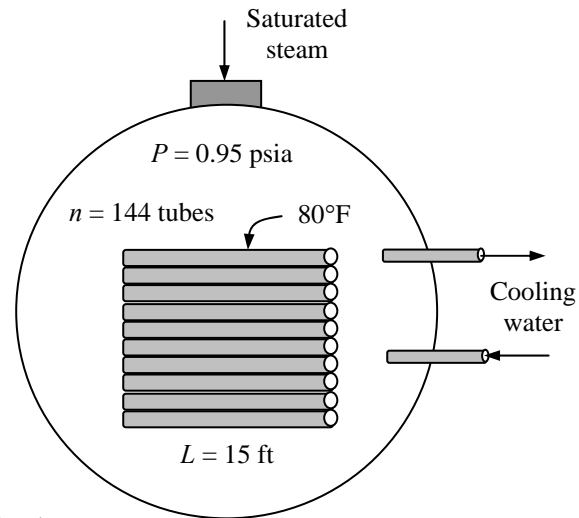

Analysis (a) The modified latent heat of vaporization is

$$\begin{aligned}h_{fg}^* &= h_{fg} + 0.68c_{pl}(T_{\text{sat}} - T_s) \\ &= 1037 \text{ Btu/lbm} + 0.68 \times (0.999 \text{ Btu/lbm} \cdot ^\circ\text{F})(100 - 80)^\circ\text{F} \\ &= 1051 \text{ Btu/lbm}\end{aligned}$$

The heat transfer coefficient for condensation on a single horizontal tube is

$$\begin{aligned}h &= h_{\text{horiz}} = 0.729 \left[\frac{g\rho_l(\rho_l - \rho_v)h_{fg}^*k_l^3}{\mu_l(T_{\text{sat}} - T_s)D} \right]^{1/4} \\ &= 0.729 \left[\frac{(32.2 \text{ ft/s}^2)(62.12 \text{ lbm/ft}^3)(62.12 - 0.00286 \text{ lbm/ft}^3)(1051 \text{ Btu/lbm})(0.358 \text{ Btu/h} \cdot \text{ft} \cdot ^\circ\text{F})^3}{[(1 \text{ h}/3600 \text{ s})^2](1.842 \text{ lbm/ft} \cdot \text{h})(100 - 80)^\circ\text{F}(2.0/12 \text{ ft})} \right]^{1/4} \\ &= 1374 \text{ Btu/h} \cdot \text{ft}^2 \cdot ^\circ\text{F}\end{aligned}$$

Then the average heat transfer coefficient for a 4-tube high vertical tier becomes

$$h_{\text{horiz, N tubes}} = \frac{1}{N^{1/4}} h_{\text{horiz, 1 tube}} = \frac{1}{12^{1/4}} (1374 \text{ Btu/h} \cdot \text{ft}^2 \cdot ^\circ\text{F}) = 739 \text{ Btu/h} \cdot \text{ft}^2 \cdot ^\circ\text{F}$$

The surface area for all 144 tubes is

$$A_s = N_{\text{total}} \pi DL = 144 \pi (2/12 \text{ ft})(15 \text{ ft}) = 1131 \text{ ft}^2$$

Then the rate of heat transfer during this condensation process becomes

$$\dot{Q} = hA_s(T_{\text{sat}} - T_s) = (739 \text{ Btu/h} \cdot \text{ft}^2 \cdot ^\circ\text{F})(1131 \text{ ft}^2)(100 - 80)^\circ\text{F} = \mathbf{16,716,000 \text{ Btu/h}}$$

(b) The rate of condensation of steam is determined from

$$\dot{m}_{\text{condensation}} = \frac{\dot{Q}}{h_{fg}^*} = \frac{16,716,000 \text{ Btu/h}}{1051 \text{ Btu/lbm}} = \mathbf{15,900 \text{ lbm/h}}$$

10-87 Water is boiled at $T_{\text{sat}} = 100^\circ\text{C}$ by a chemically etched stainless steel electric heater whose surface temperature is maintained at $T_s = 115^\circ\text{C}$. The rate of heat transfer to the water, the rate of evaporation of water, and the maximum rate of evaporation are to be determined.

Assumptions 1 Steady operating conditions exist. 2 Heat losses from the heater and the boiler are negligible.

Properties The properties of water at the saturation temperature of 100°C are (Tables 10-1 and A-9)

$$\rho_l = 957.9 \text{ kg/m}^3$$

$$\rho_v = 0.60 \text{ kg/m}^3$$

$$\sigma = 0.0589 \text{ N/m}$$

$$\text{Pr}_l = 1.75$$

$$h_{fg} = 2257 \times 10^3 \text{ J/kg}$$

$$\mu_l = 0.282 \times 10^{-3} \text{ kg}\cdot\text{m/s}$$

$$c_{pl} = 4217 \text{ J/kg}\cdot^\circ\text{C}$$

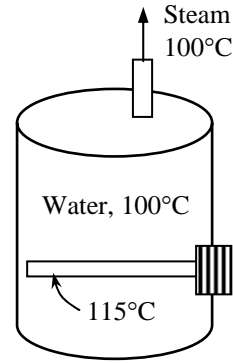

Also, $C_{sf} = 0.0130$ and $n = 1.0$ for the boiling of water on a chemically etched stainless steel surface (Table 10-3). Note that we expressed the properties in units specified under Eq. 10-2 in connection with their definitions in order to avoid unit manipulations.

Analysis (a) The excess temperature in this case is $\Delta T = T_s - T_{\text{sat}} = 115 - 100 = 15^\circ\text{C}$ which is relatively low (less than 30°C). Therefore, nucleate boiling will occur. The heat flux in this case can be determined from Rohsenow relation to be

$$\begin{aligned} \dot{q}_{\text{nucleate}} &= \mu_l h_{fg} \left[\frac{g(\rho_l - \rho_v)}{\sigma} \right]^{1/2} \left(\frac{c_{p,l}(T_s - T_{\text{sat}})}{C_{sf} h_{fg} \text{Pr}_l^n} \right)^3 \\ &= (0.282 \times 10^{-3})(2257 \times 10^3) \left[\frac{9.8(957.9 - 0.60)}{0.0589} \right]^{1/2} \left(\frac{4217(115 - 100)}{0.0130(2257 \times 10^3)1.75} \right)^3 \\ &= 474,900 \text{ W/m}^2 \end{aligned}$$

The surface area of the bottom of the heater is $A_s = \pi DL = \pi(0.002 \text{ m})(0.8 \text{ m}) = 0.005027 \text{ m}^2$.

Then the rate of heat transfer during nucleate boiling becomes

$$\dot{Q}_{\text{boiling}} = A_s \dot{q}_{\text{nucleate}} = (0.005027 \text{ m}^2)(474,900 \text{ W/m}^2) = \mathbf{2387 \text{ W}}$$

The rate of evaporation of water is determined from

$$\dot{m}_{\text{evaporation}} = \frac{\dot{Q}_{\text{boiling}}}{h_{fg}} = \frac{2387 \text{ J/s}}{2257 \times 10^3 \text{ J/kg}} = \mathbf{1.058 \times 10^{-3} \text{ kg/s} = 3.81 \text{ kg/h}}$$

(b) For a horizontal heating wire, the coefficient C_{cr} is determined from Table 10-4 to be

$$L^* = L \left(\frac{g(\rho_l - \rho_v)}{\sigma} \right)^{1/2} = (0.001) \left(\frac{9.8(957.9 - 0.60)}{0.0589} \right)^{1/2} = 0.399 < 1.2$$

$$C_{cr} = 0.12 L^{*-0.25} = 0.12(0.399)^{-0.25} = 0.151$$

Then the maximum or critical heat flux is determined from

$$\begin{aligned} \dot{q}_{\text{max}} &= C_{cr} h_{fg} [\sigma g \rho_v^2 (\rho_l - \rho_v)]^{1/4} = 0.151(2257 \times 10^3)[0.0589 \times 9.8 \times (0.6)^2 (957.9 - 0.60)]^{1/4} \\ &= 1,280,000 \text{ W/m}^2 = \mathbf{1280 \text{ kW/m}^2} \end{aligned}$$

10-88E Steam at a saturation temperature of $T_{\text{sat}} = 100^\circ\text{F}$ condenses on a vertical plate which is maintained at 80°C . The rate of heat transfer to the plate and the rate of condensation of steam per ft width of the plate are to be determined.

Assumptions **1** Steady operating conditions exist. **2** The plate is isothermal. **3** The condensate flow is wavy-laminar over the entire plate (this assumption will be verified). **4** The density of vapor is much smaller than the density of liquid, $\rho_v \ll \rho_l$.

Properties The properties of water at the saturation temperature of 100°F are $h_{fg} = 1037 \text{ Btu/lbm}$ and $\rho_v = 0.00286 \text{ lbm/ft}^3$. The properties of liquid water at the film temperature of $T_f = (T_{\text{sat}} + T_s)/2 = (100 + 80)/2 = 90^\circ\text{F}$ are (Table A-9E),

$$\begin{aligned}\rho_l &= 62.12 \text{ lbm/ft}^3 \\ \mu_l &= 5.117 \times 10^{-4} \text{ lbm/ft} \cdot \text{s} = 1.842 \text{ lbm/ft} \cdot \text{h} \\ \nu_l &= \mu_l / \rho_l = 0.02965 \text{ ft}^2/\text{h} \\ c_{pl} &= 0.999 \text{ Btu/lbm} \cdot ^\circ\text{F} \\ k_l &= 0.358 \text{ Btu/h} \cdot \text{ft} \cdot ^\circ\text{F}\end{aligned}$$

Analysis The modified latent heat of vaporization is

$$\begin{aligned}h_{fg}^* &= h_{fg} + 0.68c_{pl}(T_{\text{sat}} - T_s) \\ &= 1037 \text{ Btu/lbm} + 0.68 \times (0.999 \text{ Btu/lbm} \cdot ^\circ\text{F})(100 - 80)^\circ\text{F} \\ &= 1051 \text{ Btu/lbm}\end{aligned}$$

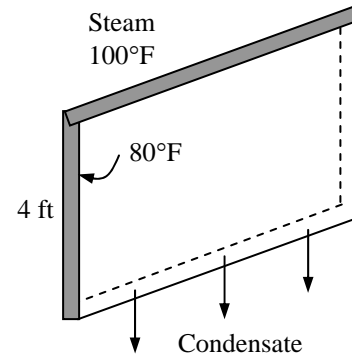

Assuming wavy-laminar flow, the Reynolds number is determined from

$$\begin{aligned}\text{Re} &= \text{Re}_{\text{vertical,wavy}} = \left[4.81 + \frac{3.70Lk_l(T_{\text{sat}} - T_s)}{\mu_l h_{fg}^*} \left(\frac{g}{\nu_l^2} \right)^{1/3} \right]^{0.820} \\ &= \left[4.81 + \frac{3.70 \times (6 \text{ ft}) \times (0.358 \text{ Btu/h} \cdot \text{ft} \cdot ^\circ\text{F}) \times (100 - 80)^\circ\text{F}}{(1.842 \text{ lbm/ft} \cdot \text{h})(1051 \text{ Btu/lbm})} \left(\frac{32.2 \text{ ft/s}^2}{(0.02965 \text{ ft}^2/\text{h})^2} \frac{(3600 \text{ s})^2}{(1 \text{ h})^2} \right)^{1/3} \right]^{0.820} = 201\end{aligned}$$

which is between 30 and 1800, and thus our assumption of wavy laminar flow is verified. Then the condensation heat transfer coefficient is determined from

$$\begin{aligned}h &= h_{\text{vertical,wavy}} = \frac{\text{Re} k_l}{1.08 \text{Re}^{1.22} - 5.2} \left(\frac{g}{\nu_l^2} \right)^{1/3} \\ &= \frac{201 \times (0.358 \text{ Btu/h} \cdot \text{ft} \cdot ^\circ\text{F})}{1.08(201)^{1.22} - 5.2} \left(\frac{32.2 \text{ ft/s}^2}{(0.02965 \text{ ft}^2/\text{h})^2} \frac{(3600 \text{ s})^2}{(1 \text{ h})^2} \right)^{1/3} = 811 \text{ Btu/h} \cdot \text{ft}^2 \cdot ^\circ\text{F}\end{aligned}$$

The heat transfer surface area of the plate is

$$A_s = W \times L = (4 \text{ ft})(1 \text{ ft}) = 4 \text{ ft}^2$$

Then the rate of heat transfer during this condensation process becomes

$$\dot{Q} = hA_s(T_{\text{sat}} - T_s) = (811 \text{ Btu/h} \cdot \text{ft}^2 \cdot ^\circ\text{F})(4 \text{ ft}^2)(100 - 80)^\circ\text{F} = \mathbf{64,880 \text{ Btu/h}}$$

The rate of condensation of steam is determined from

$$\dot{m}_{\text{condensation}} = \frac{\dot{Q}}{h_{fg}^*} = \frac{64,880 \text{ Btu/h}}{1051 \text{ Btu/lbm}} = \mathbf{61.7 \text{ lbm/h}}$$

10-89 Saturated refrigerant-134a vapor condenses on the outside of a horizontal tube maintained at a specified temperature. The rate of condensation of the refrigerant is to be determined.

Assumptions 1 Steady operating conditions exist. 2 The tube is isothermal.

Properties The properties of refrigerant-134a at the saturation temperature of 35°C are $h_{fg} = 168.2 \times 10^3$ J/kg and $\rho_v = 43.41$ kg/m³. The properties of liquid R-134a at the film temperature of $T_f = (T_{\text{sat}} + T_s) / 2 = (35 + 25) / 2 = 30^\circ\text{C}$ are (Table A-10),

$$\rho_l = 1188 \text{ kg/m}^3$$

$$\mu_l = 1.888 \times 10^{-4} \text{ kg/m}\cdot\text{s}$$

$$c_{pl} = 1448 \text{ J/kg}\cdot^\circ\text{C}$$

$$k_l = 0.0808 \text{ W/m}\cdot^\circ\text{C}$$

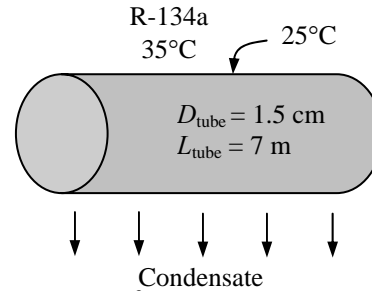

Analysis The modified latent heat of vaporization is

$$\begin{aligned} h_{fg}^* &= h_{fg} + 0.68c_{pl}(T_{\text{sat}} - T_s) \\ &= 168.2 \times 10^3 \text{ J/kg} + 0.68 \times 1448 \text{ J/kg}\cdot^\circ\text{C}(35 - 25)^\circ\text{C} = 178.0 \times 10^3 \text{ J/kg} \end{aligned}$$

The heat transfer coefficient for condensation on a single horizontal tube is

$$\begin{aligned} h &= h_{\text{horizontal}} = 0.729 \left[\frac{g\rho_l(\rho_l - \rho_v)h_{fg}^*k_l^3}{\mu_l(T_{\text{sat}} - T_s)D} \right]^{1/4} \\ &= 0.729 \left[\frac{(9.81 \text{ m/s}^2)(1188 \text{ kg/m}^3)(1188 - 43.41 \text{ kg/m}^3)(178.0 \times 10^3 \text{ J/kg})(0.0808 \text{ W/m}\cdot^\circ\text{C})^3}{(1.888 \times 10^{-4} \text{ kg/m}\cdot\text{s})(35 - 25)^\circ\text{C}(0.015 \text{ m})} \right]^{1/4} \\ &= 1880 \text{ W/m}^2 \cdot ^\circ\text{C} \end{aligned}$$

The heat transfer surface area of the pipe is

$$A_s = \pi DL = \pi(0.015 \text{ m})(7 \text{ m}) = 0.3299 \text{ m}^2$$

Then the rate of heat transfer during this condensation process becomes

$$\dot{Q} = hA_s(T_{\text{sat}} - T_s) = (1880 \text{ W/m}^2 \cdot ^\circ\text{C})(0.3299 \text{ m}^2)(35 - 25)^\circ\text{C} = 6200 \text{ W}$$

The rate of condensation of steam is determined from

$$\dot{m}_{\text{condensation}} = \frac{\dot{Q}}{h_{fg}^*} = \frac{6200 \text{ J/s}}{178.0 \times 10^3 \text{ J/kg}} = 0.0348 \text{ kg/s} = \mathbf{2.09 \text{ kg/min}}$$

10-90 Saturated refrigerant-134a vapor condenses on the outside of a horizontal tube maintained at a specified temperature. The rate of condensation of the refrigerant is to be determined.

Assumptions 1 Steady operating conditions exist. 2 The tube is isothermal.

Properties The properties of refrigerant-134a at the saturation temperature of 35°C are $h_{fg} = 168.2 \times 10^3$ J/kg and $\rho_v = 43.41$ kg/m³. The properties of liquid R-134a at the film temperature of $T_f = (T_{\text{sat}} + T_s) / 2 = (35 + 25) / 2 = 30^\circ\text{C}$ are (Table A-10),

$$\begin{aligned}\rho_l &= 1188 \text{ kg/m}^3 \\ \mu_l &= 1.888 \times 10^{-4} \text{ kg/m}\cdot\text{s} \\ \nu_l &= \mu_l / \rho_l = 0.1590 \times 10^{-6} \text{ m}^2/\text{s} \\ c_{pl} &= 1448 \text{ J/kg}\cdot^\circ\text{C} \\ k_l &= 0.0808 \text{ W/m}\cdot^\circ\text{C}\end{aligned}$$

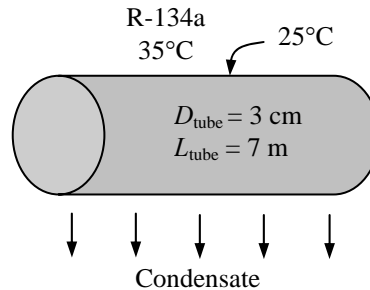

Analysis The modified latent heat of vaporization is

$$\begin{aligned}h_{fg}^* &= h_{fg} + 0.68c_{pl}(T_{\text{sat}} - T_s) \\ &= 168.2 \times 10^3 \text{ J/kg} + 0.68 \times 1448 \text{ J/kg}\cdot^\circ\text{C}(35 - 25)^\circ\text{C} = 178.0 \times 10^3 \text{ J/kg}\end{aligned}$$

The heat transfer coefficient for condensation on a single horizontal tube is

$$\begin{aligned}h &= h_{\text{horizontal}} = 0.729 \left[\frac{g\rho_l(\rho_l - \rho_v)h_{fg}^*k_l^3}{\mu_l(T_{\text{sat}} - T_s)D} \right]^{1/4} \\ &= 0.729 \left[\frac{(9.81 \text{ m/s}^2)(1188 \text{ kg/m}^3)(1188 - 43.41 \text{ kg/m}^3)(178.0 \times 10^3 \text{ J/kg})(0.0808 \text{ W/m}\cdot^\circ\text{C})^3}{(1.888 \times 10^{-4} \text{ kg/m}\cdot\text{s})(35 - 25)^\circ\text{C}(0.03 \text{ m})} \right]^{1/4} \\ &= 1581 \text{ W/m}^2\cdot^\circ\text{C}\end{aligned}$$

The heat transfer surface area of the pipe is

$$A_s = \pi DL = \pi(0.03 \text{ m})(7 \text{ m}) = 0.6597 \text{ m}^2$$

Then the rate of heat transfer during this condensation process becomes

$$\dot{Q} = hA_s(T_{\text{sat}} - T_s) = (1581 \text{ W/m}^2\cdot^\circ\text{C})(0.6597 \text{ m}^2)(35 - 25)^\circ\text{C} = 10,430 \text{ W}$$

The rate of condensation of steam is determined from

$$\dot{m}_{\text{condensation}} = \frac{\dot{Q}}{h_{fg}^*} = \frac{10,430 \text{ J/s}}{178.0 \times 10^3 \text{ J/kg}} = 0.0586 \text{ kg/s} = \mathbf{3.52 \text{ kg/min}}$$

10-91 Saturated steam at 270.1 kPa pressure and thus at a saturation temperature of $T_{\text{sat}} = 130^\circ\text{C}$ (Table A-9) condenses inside a horizontal tube which is maintained at 110°C . The average heat transfer coefficient and the rate of condensation of steam are to be determined.

Assumptions 1 Steady operating conditions exist. 2 The tube is isothermal. 3 The vapor velocity is low so that $\text{Re}_{\text{vapor}} < 35,000$.

Properties The properties of water at the saturation temperature of 130°C are $h_{fg} = 2174 \times 10^3 \text{ J/kg}$ and $\rho_v = 1.50 \text{ kg/m}^3$. The properties of liquid water at the film temperature of $T_f = (T_{\text{sat}} + T_s) / 2 = (130 + 110) / 2 = 120^\circ\text{C}$ are (Table A-9),

$$\begin{aligned}\rho_l &= 943.4 \text{ kg/m}^3 \\ \mu_l &= 0.232 \times 10^{-3} \text{ kg/m}\cdot\text{s} \\ \nu_l &= \mu_l / \rho_l = 0.246 \times 10^{-6} \text{ m}^2/\text{s} \\ c_{pl} &= 4244 \text{ J/kg}\cdot^\circ\text{C} \\ k_l &= 0.683 \text{ W/m}\cdot^\circ\text{C}\end{aligned}$$

Analysis The condensation heat transfer coefficient is determined from

$$\begin{aligned}h &= h_{\text{internal}} = 0.555 \left[\frac{g\rho_l(\rho_l - \rho_v)k_l^3}{\mu_l(T_{\text{sat}} - T_s)} \left(h_{fg} + \frac{3}{8}c_{pl}(T_{\text{sat}} - T_s) \right) \right]^{1/4} \\ &= 0.555 \left[\frac{(9.8 \text{ m/s}^2)(943.4 \text{ kg/m}^3)(943.4 - 1.50) \text{ kg/m}^3)(0.683 \text{ W/m}\cdot^\circ\text{C})^3}{(0.232 \times 10^{-3} \text{ kg/m}\cdot\text{s})(130 - 110)^\circ\text{C}} \right. \\ &\quad \left. \times \left(2174 \times 10^3 \text{ J/kg} + \frac{3}{8}(4244 \text{ kJ/kg}\cdot^\circ\text{C})(130 - 110)^\circ\text{C} \right) \right]^{1/4} \\ &= \mathbf{3345 \text{ W/m}^2\cdot^\circ\text{C}}\end{aligned}$$

The heat transfer surface area of the pipe is

$$A_s = \pi DL = \pi(0.025 \text{ m})(10 \text{ m}) = 0.7854 \text{ m}^2$$

Then the rate of heat transfer during this condensation process becomes

$$\dot{Q} = hA_s(T_{\text{sat}} - T_s) = (3345 \text{ W/m}^2\cdot^\circ\text{C})(0.7854 \text{ m}^2)(130 - 110)^\circ\text{C} = 52,543 \text{ W}$$

The rate of condensation of steam is determined from

$$\dot{m}_{\text{condensation}} = \frac{\dot{Q}}{h_{fg}} = \frac{52,543 \text{ J/s}}{2174 \times 10^3 \text{ J/kg}} = \mathbf{0.0242 \text{ kg/s}}$$

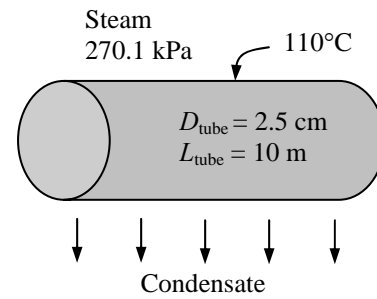

10-92 Saturated steam condenses on a suspended silver sphere which is initially at 30°C. The time needed for the temperature of the sphere to rise to 50°C and the amount of steam condenses are to be determined.

Assumptions **1** The temperature of the sphere changes uniformly and thus the lumped system analysis is applicable. **2** The average condensation heat transfer coefficient evaluated for the average temperature can be used for the entire process. **3** Constant properties at room temperature can be used for the silver ball.

Properties The properties of water at the saturation temperature of 100°C are $h_{fg} = 2257 \times 10^3 \text{ J/kg}$ and $\rho_v = 0.60 \text{ kg/m}^3$. The properties of the silver ball at room temperature and the properties of liquid water at the average film temperature of $T_f = (T_{\text{sat}} + T_{s,\text{avg}}) / 2 = (100 + 40) / 2 = 70^\circ\text{C}$ are (Tables A-3 and A-9),

Silver Ball :

$$\begin{aligned}\rho &= 10,500 \text{ kg/m}^3 \\ \alpha &= 174 \times 10^{-6} \text{ m}^2/\text{s} \\ c_p &= 235 \text{ J/kg} \cdot ^\circ\text{C} \\ k_l &= 429 \text{ W/m} \cdot ^\circ\text{C}\end{aligned}$$

Liquid Water :

$$\begin{aligned}\rho_l &= 977.5 \text{ kg/m}^3 \\ \mu_l &= 0.404 \times 10^{-3} \text{ kg/m} \cdot \text{s} \\ c_{pl} &= 4190 \text{ J/kg} \cdot ^\circ\text{C} \\ k_l &= 0.663 \text{ W/m} \cdot ^\circ\text{C}\end{aligned}$$

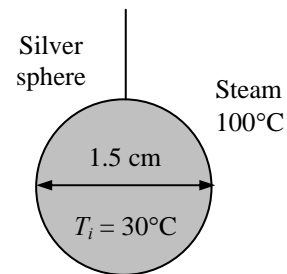

Analysis The modified latent heat of vaporization is

$$\begin{aligned}h_{fg}^* &= h_{fg} + 0.68c_{pl}(T_{\text{sat}} - T_s) \\ &= 2257 \times 10^3 \text{ J/kg} + 0.68 \times 4190 \text{ J/kg} \cdot ^\circ\text{C}(100 - 40)^\circ\text{C} = 2428 \times 10^3 \text{ J/kg}\end{aligned}$$

Noting that the tube is horizontal, the condensation heat transfer coefficient is determined from

$$\begin{aligned}h &= h_{\text{sph}} = 0.813 \left[\frac{g\rho_l(\rho_l - \rho_v)h_{fg}^*k_l^3}{\mu_l(T_{\text{sat}} - T_s)D} \right]^{1/4} \\ &= 0.813 \left[\frac{(9.8 \text{ m/s}^2)(977.5 \text{ kg/m}^3)(977.5 - 0.60 \text{ kg/m}^3)(2428 \times 10^3 \text{ J/kg})(0.663 \text{ W/m} \cdot ^\circ\text{C})^3}{(0.404 \times 10^{-3} \text{ kg/m} \cdot \text{s})(100 - 40)^\circ\text{C}(0.015 \text{ m})} \right]^{1/4} \\ &= 9445 \text{ W/m}^2 \cdot ^\circ\text{C}\end{aligned}$$

The characteristic length and the Biot number for the lumped system analysis is (see Chap. 4)

$$\begin{aligned}L_c &= \frac{\mathcal{V}}{A} = \frac{\pi D^3 / 6}{\pi D^2} = \frac{D}{6} = \frac{0.015 \text{ m}}{6} = 0.0025 \text{ m} \\ Bi &= \frac{hL_c}{k} = \frac{(9445 \text{ W/m}^2 \cdot ^\circ\text{C})(0.0025 \text{ m})}{(429 \text{ W/m} \cdot ^\circ\text{C})} = 0.055 < 0.1\end{aligned}$$

The lumped system analysis is applicable since $Bi < 0.1$. Then the time needed for the temperature of the sphere to rise from 30 to 50°C is determined to be

$$\begin{aligned}b &= \frac{hA_s}{\rho c_p \mathcal{V}} = \frac{h}{\rho c_p L_c} = \frac{9445 \text{ W/m}^2 \cdot ^\circ\text{C}}{(10,500 \text{ kg/m}^3)(235 \text{ J/kg} \cdot ^\circ\text{C})(0.0025 \text{ m})} = 1.531 \text{ s}^{-1} \\ \frac{T(t) - T_\infty}{T_i - T_\infty} &= e^{-bt} \longrightarrow \frac{50 - 100}{30 - 100} = e^{-1.531t} \longrightarrow t = \mathbf{0.22 \text{ s}}\end{aligned}$$

The total heat transfer to the ball and the amount of steam that condenses become

$$\begin{aligned}m_{\text{sphere}} &= \rho \mathcal{V} = \rho \frac{\pi D^3}{6} = (10,500 \text{ kg/m}^3) \frac{\pi (0.015 \text{ m})^3}{6} = 0.0186 \text{ kg} \\ Q &= mc_p [T(t) - T_i]_{\text{sphere}} = (0.0186 \text{ kg})(235 \text{ J/kg} \cdot ^\circ\text{C})(50 - 30)^\circ\text{C} = 87.2 \text{ J} \\ \dot{m}_{\text{condensation}} &= \frac{\dot{Q}}{h_{fg}^*} = \frac{87.2 \text{ J/s}}{2428 \times 10^3 \text{ J/kg}} = \mathbf{0.0359 \times 10^{-3} \text{ kg/s}}\end{aligned}$$

10-93 Steam at a saturation temperature of $T_{\text{sat}} = 100^\circ\text{C}$ condenses on a suspended silver sphere which is initially at 30°C . The time needed for the temperature of the sphere to rise to 50°C and the amount of steam condenses during this process are to be determined.

Assumptions 1 The temperature of the sphere changes uniformly and thus the lumped system analysis is applicable. 2 The average condensation heat transfer coefficient evaluated for the average temperature can be used for the entire process. 3 Constant properties at room temperature can be used for the silver ball.

Properties The properties of water at the saturation temperature of 100°C are $h_{fg} = 2257 \times 10^3 \text{ J/kg}$ and $\rho_v = 0.60 \text{ kg/m}^3$. The properties of the silver ball at room temperature and the properties of liquid water at the average film temperature of $T_f = (T_{\text{sat}} + T_{s,\text{avg}})/2 = (100 + 40)/2 = 70^\circ\text{C}$ are (Tables A-3 and A-9),

Silver Ball :

$$\begin{aligned}\rho &= 10,500 \text{ kg/m}^3 \\ \alpha &= 174 \times 10^{-6} \text{ m}^2/\text{s} \\ c_p &= 235 \text{ J/kg} \cdot ^\circ\text{C} \\ k_l &= 429 \text{ W/m} \cdot ^\circ\text{C}\end{aligned}$$

Liquid Water :

$$\begin{aligned}\rho_l &= 977.5 \text{ kg/m}^3 \\ \mu_l &= 0.404 \times 10^{-3} \text{ kg/m} \cdot \text{s} \\ c_{pl} &= 4190 \text{ J/kg} \cdot ^\circ\text{C} \\ k_l &= 0.663 \text{ W/m} \cdot ^\circ\text{C}\end{aligned}$$

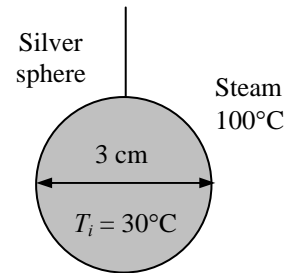

Analysis The modified latent heat of vaporization is

$$\begin{aligned}h_{fg}^* &= h_{fg} + 0.68c_{pl}(T_{\text{sat}} - T_s) \\ &= 2257 \times 10^3 \text{ J/kg} + 0.68 \times 4190 \text{ J/kg} \cdot ^\circ\text{C}(100 - 40)^\circ\text{C} = 2428 \times 10^3 \text{ J/kg}\end{aligned}$$

Noting that the tube is horizontal, the condensation heat transfer coefficient is determined from

$$\begin{aligned}h &= h_{\text{sph}} = 0.813 \left[\frac{g\rho_l(\rho_l - \rho_v)h_{fg}^*k_l^3}{\mu_l(T_{\text{sat}} - T_s)D} \right]^{1/4} \\ &= 0.813 \left[\frac{(9.8 \text{ m/s}^2)(977.5 \text{ kg/m}^3)(977.5 - 0.60 \text{ kg/m}^3)(2428 \times 10^3 \text{ J/kg})(0.663 \text{ W/m} \cdot ^\circ\text{C})^3}{(0.404 \times 10^{-3} \text{ kg/m} \cdot \text{s})(100 - 40)^\circ\text{C}(0.03 \text{ m})} \right]^{1/4} \\ &= 7942 \text{ W/m}^2 \cdot ^\circ\text{C}\end{aligned}$$

The characteristic length and the Biot number for the lumped system analysis is (see Chap. 4)

$$\begin{aligned}L_c &= \frac{\mathcal{V}}{A_s} = \frac{\pi D^3 / 6}{\pi D^2} = \frac{D}{6} = \frac{0.03 \text{ m}}{6} = 0.005 \text{ m} \\ Bi &= \frac{hL_c}{k} = \frac{(7942 \text{ W/m}^2 \cdot ^\circ\text{C})(0.005 \text{ m})}{(429 \text{ W/m} \cdot ^\circ\text{C})} = 0.093 < 0.1\end{aligned}$$

The lumped system analysis is applicable since $Bi < 0.1$. Then the time needed for the temperature of the sphere to rise from 30 to 50°C is determined to be

$$\begin{aligned}b &= \frac{hA_s}{\rho c_p \mathcal{V}} = \frac{h}{\rho c_p L_c} = \frac{7942 \text{ W/m}^2 \cdot ^\circ\text{C}}{(10,500 \text{ kg/m}^3)(235 \text{ J/kg} \cdot ^\circ\text{C})(0.005 \text{ m})} = 0.644 \text{ s}^{-1} \\ \frac{T(t) - T_\infty}{T_i - T_\infty} &= e^{-bt} \longrightarrow \frac{50 - 100}{30 - 100} = e^{-0.644t} \longrightarrow t = \mathbf{0.52 \text{ s}}\end{aligned}$$

The total heat transfer to the ball and the amount of steam that condenses become

$$\begin{aligned}m_{\text{sphere}} &= \rho \mathcal{V} = \rho \frac{\pi D^3}{6} = (10,500 \text{ kg/m}^3) \frac{\pi(0.03 \text{ m})^3}{6} = 0.148 \text{ kg} \\ Q &= mc_p [T(t) - T_i]_{\text{sphere}} = (0.148 \text{ kg})(235 \text{ J/kg} \cdot ^\circ\text{C})(50 - 30)^\circ\text{C} = 698 \text{ J} \\ \dot{m}_{\text{condensation}} &= \frac{\dot{Q}}{h_{fg}^*} = \frac{698 \text{ J/s}}{2428 \times 10^3 \text{ J/kg}} = \mathbf{0.287 \times 10^{-3} \text{ kg/s}}\end{aligned}$$

10-94 Saturated steam at a saturation temperature of $T_{\text{sat}} = 95^\circ\text{C}$ (Table A-9) condenses on a canned drink at 2°C in a dropwise manner. The heat transfer coefficient for this dropwise condensation is to be determined.

Assumptions The heat transfer coefficient relation for dropwise condensation that was developed for copper surfaces is also applicable for aluminum surfaces.

Analysis Noting that the saturation temperature is less than 100°C , the heat transfer coefficient for dropwise condensation can be determined from Griffith's relation to be

$$h = h_{\text{dropwise}} = 51,104 + 2044T_{\text{sat}} = 51,104 + 2044 \times 95 = \mathbf{245,284 \text{ W/m}^2 \cdot ^\circ\text{C}}$$

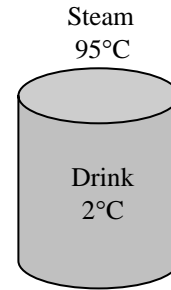

10-95 Water is boiled at 1 atm pressure and thus at a saturation temperature of $T_{\text{sat}} = 100^\circ\text{C}$ by a nickel electric heater whose diameter is 2 mm. The highest temperature at which this heater can operate without burnout is to be determined.

Assumptions 1 Steady operating conditions exist. **2** Heat losses from the water are negligible.

Properties The properties of water at the saturation temperature of 100°C are (Tables 10-1 and A-9)

$$\begin{aligned} \rho_l &= 957.9 \text{ kg/m}^3 & h_{fg} &= 2257 \times 10^3 \text{ J/kg} \\ \rho_v &= 0.60 \text{ kg/m}^3 & \mu_l &= 0.282 \times 10^{-3} \text{ kg} \cdot \text{m/s} \\ \sigma &= 0.0589 \text{ N/m} & c_{pl} &= 4217 \text{ J/kg} \cdot ^\circ\text{C} \\ \text{Pr}_l &= 1.75 \end{aligned}$$

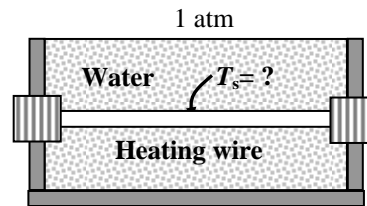

Also, $C_{sf} = 0.0060$ and $n = 1.0$ for the boiling of water on a nickel surface (Table 10-3).

Analysis The maximum rate of heat transfer without the burnout is simply the critical heat flux. For a horizontal heating wire, the coefficient C_{cr} is determined from Table 10-4 to be

$$L^* = L \left(\frac{g(\rho_l - \rho_v)}{\sigma} \right)^{1/2} = (0.001) \left(\frac{9.8(957.9 - 0.60)}{0.0589} \right)^{1/2} = 0.399 < 1.2$$

$$C_{cr} = 0.12L^{*-0.25} = 0.12(0.399)^{-0.25} = 0.151$$

Then the maximum or critical heat flux is determined from

$$\begin{aligned} \dot{q}_{\text{max}} &= C_{cr} h_{fg} [\sigma g \rho_v^2 (\rho_l - \rho_v)]^{1/4} = 0.151(2257 \times 10^3)[0.0589 \times 9.8 \times (0.6)^2 (957.9 - 0.60)]^{1/4} \\ &= 1,280,000 \text{ W/m}^2 \end{aligned}$$

Rohsenow relation which gives the nucleate boiling heat flux for a specified surface temperature can also be used to determine the surface temperature when the heat flux is given. Substituting the maximum heat flux into Rohsenow relation together with other properties gives

$$\begin{aligned} \dot{q}_{\text{nucleate}} &= \mu_l h_{fg} \left[\frac{g(\rho_l - \rho_v)}{\sigma} \right]^{1/2} \left(\frac{c_{p,l}(T_s - T_{\text{sat}})}{C_{sf} h_{fg} \text{Pr}_l^n} \right)^3 \\ 1,280,000 &= (0.282 \times 10^{-3})(2257 \times 10^3) \left[\frac{9.8(957.9 - 0.60)}{0.0589} \right]^{1/2} \left(\frac{4217(T_s - 100)}{0.0060(2257 \times 10^3)1.75} \right)^3 \end{aligned}$$

It gives the maximum temperature to be: $T_s = \mathbf{109.6^\circ\text{C}}$

10-96 Saturated steam is generated at 100°C in a horizontal heat exchanger. The tube surface temperature is to be determined.

Assumptions **1** Steady operating conditions exist. **2** The tubes are isothermal.

Properties The latent of vaporization of water at 100°C is $h_{fg} = 2257$ kJ/kg (Table A-9).

Analysis The rate of heat transfer is

$$\dot{Q} = \dot{m}_{\text{condensation}} h_{fg} = (50 / 60 \text{ kg/s})(2257 \times 10^3 \text{ J/kg}) = 1.881 \times 10^6 \text{ W}$$

Substituting the relation for the heat transfer coefficient, the tube surface temperature is determined from

$$\begin{aligned} \dot{Q} &= hA_s(T_s - T_{\text{sat}}) \\ \dot{Q} &= 5.56(T_s - T_{\text{sat}})^3(100\pi DL)(T_s - T_{\text{sat}}) \\ 1.881 \times 10^6 \text{ W} &= 5.56(T_s - 100)^3[100\pi(0.05 \text{ m})(2 \text{ m})](T_s - 100) \\ T_s &= \mathbf{110.2^\circ\text{C}} \end{aligned}$$

10-97 Steam is generated by an electrical heater rod with a rating of 1.5 kW. The heater surface temperature and the rate of steam generation are to be determined.

Assumptions **1** Steady operating conditions exist. **2** The heater surfaces are isothermal.

Properties The latent of vaporization of water at 1 atm (101.3 kPa) ($T_{\text{sat}} = 100^\circ\text{C}$) is $h_{fg} = 2257$ kJ/kg (Table A-9).

Analysis The tube surface temperature is determined from

$$\begin{aligned} \dot{Q} &= hA_s(T_s - T_{\text{sat}}) \\ \dot{Q} &= 5.56(T_s - T_{\text{sat}})^3(\pi DL)(T_s - T_{\text{sat}}) \\ 1.500 \text{ W} &= 5.56(T_s - 100)^3[\pi(0.01 \text{ m})(0.30 \text{ m})](T_s - 100) \\ T_s &= \mathbf{113^\circ\text{C}} \end{aligned}$$

The rate of condensation of steam is determined from

$$\dot{m}_{\text{condensation}} = \frac{\dot{Q}}{h_{fg}} = \frac{1500 \text{ J/s}}{2257 \times 10^3 \text{ J/kg}} = 6.646 \times 10^{-4} \text{ kg/s} = \mathbf{2.39 \text{ kg/h}}$$

10-98 Ammonia is liquefied in a horizontal condenser at 37°C by a coolant at 20°C. The average value of overall heat transfer coefficient and the tube length are to be determined.

Assumptions 1 Steady operating conditions exist. 2 The tubes are isothermal. 3 The thermal resistance of the tube walls is negligible.

Properties The properties of ammonia at the saturation temperature of 310 K (37°C) are $h_{fg} = 1113 \times 10^3$ J/kg and $\rho_v = 11.09$ kg/m³ (Table A-11). We assume a tube outer surface temperature of 31°C. The properties of liquid ammonia at the film temperature of $T_f = (T_{sat} + T_s)/2 = (37 + 31)/2 = 34^\circ\text{C}$ are (Table A-11)

$$\rho_l = 589.0 \text{ kg/m}^3$$

$$\mu_l = 1.303 \times 10^{-4} \text{ kg/m} \cdot \text{s}$$

$$c_{pl} = 4867 \text{ J/kg} \cdot ^\circ\text{C}$$

$$k_l = 0.4602 \text{ W/m} \cdot ^\circ\text{C}$$

The thermal conductivity of copper is 401 W/m·°C (Table A-3).

Analysis (a) The modified latent heat of vaporization is

$$\begin{aligned} h_{fg}^* &= h_{fg} + 0.68c_{pl}(T_{sat} - T_s) \\ &= 1113 \times 10^3 \text{ J/kg} + 0.68 \times 4867 \text{ J/kg} \cdot ^\circ\text{C}(37 - 31)^\circ\text{C} \\ &= 1133 \times 10^3 \text{ J/kg} \end{aligned}$$

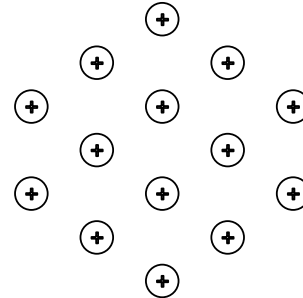

The heat transfer coefficient for condensation on a single horizontal tube is

$$\begin{aligned} h &= h_{\text{horizontal}} = 0.729 \left[\frac{g\rho_l(\rho_l - \rho_v)h_{fg}^*k_l^3}{\mu_l(T_{sat} - T_s)D} \right]^{1/4} \\ &= 0.729 \left[\frac{(9.8 \text{ m/s}^2)(589.0 \text{ kg/m}^3)(589.0 - 11.09 \text{ kg/m}^3)(1133 \times 10^3 \text{ J/kg})(0.4602 \text{ W/m} \cdot ^\circ\text{C})^3}{(1.303 \times 10^{-4} \text{ kg/m} \cdot \text{s})(37 - 31)^\circ\text{C}(0.038 \text{ m})} \right]^{1/4} \\ &= 7693 \text{ W/m}^2 \cdot ^\circ\text{C} \end{aligned}$$

Noting that there are two 2-pipe high, two 3-pipe high, and one 4-pipe high vertical tiers in the tube-layout, the average heat transfer coefficient is to be determined as follows

$$\begin{aligned} h_1 &= \frac{1}{N^{1/4}} h_{\text{horiz, 1 tube}} = \frac{1}{2^{1/4}} (7693 \text{ W/m}^2 \cdot ^\circ\text{C}) = 6469 \text{ W/m}^2 \cdot ^\circ\text{C} \\ h_2 &= \frac{1}{N^{1/4}} h_{\text{horiz, 1 tube}} = \frac{1}{3^{1/4}} (7693 \text{ W/m}^2 \cdot ^\circ\text{C}) = 5845 \text{ W/m}^2 \cdot ^\circ\text{C} \\ h_3 &= \frac{1}{N^{1/4}} h_{\text{horiz, 1 tube}} = \frac{1}{4^{1/4}} (7693 \text{ W/m}^2 \cdot ^\circ\text{C}) = 5440 \text{ W/m}^2 \cdot ^\circ\text{C} \\ h_o &= \frac{2 \times 2h_1 + 2 \times 3h_2 + 1 \times 4h_3}{2 \times 2 + 2 \times 3 + 1 \times 4} = \frac{4 \times 6469 + 6 \times 5845 + 4 \times 5440}{14} = 5908 \text{ W/m}^2 \cdot ^\circ\text{C} \end{aligned}$$

Let us check if the assumed value for the tube temperature was reasonable

$$\begin{aligned} h_i A_i \Delta T_i &= h_o A_o \Delta T_o \\ (4000)\pi(0.030)L(T_{\text{tube}} - 20) &= (5908)\pi(0.038)L(37 - T_{\text{tube}}) \\ T_{\text{tube}} &= 31.1^\circ\text{C} \end{aligned}$$

which is very close to the assumed value of 31°C. The overall heat transfer coefficient based on the outer surface is determined from

$$\begin{aligned}
 U_o &= \left(\frac{D_o}{D_i h_i} + \frac{D_o \ln(D_o / D_i)}{2k} + \frac{1}{h_o} \right)^{-1} \\
 &= \left(\frac{0.038}{0.030 \times 4000} + \frac{0.038 \ln(3.8 / 3.0)}{2(401)} + \frac{1}{5908} \right)^{-1} \\
 &= \mathbf{2012 \text{ W/m}^2 \cdot \text{C}}
 \end{aligned}$$

(b) The rate of heat transfer is

$$\dot{Q} = \dot{m}_{\text{condensation}} h_{fg} = (900 / 3600 \text{ kg/s})(1113 \times 10^3 \text{ J/kg}) = 2.783 \times 10^5 \text{ W}$$

Then the tube length may be determined from

$$\begin{aligned}
 \dot{Q} &= U_o A_o \Delta T \\
 2.783 \times 10^5 \text{ W} &= (2012 \text{ W/m}^2 \cdot \text{C})(14) \pi (0.038 \text{ m}) L (37 - 20) \\
 L &= \mathbf{4.87 \text{ m}}
 \end{aligned}$$

Fundamentals of Engineering (FE) Exam Problems

10-99 Saturated water vapor at 40°C is to be condensed as it flows through a tube at a rate of 0.2 kg/s. The condensate leaves the tube as a saturated liquid at 40°C. The rate of heat transfer from the tube is

- (a) 34 kJ/s (b) 268 kJ/s (c) 453 kJ/s (d) 481 kJ/s (e) 515 kJ/s

Answer (d) 481 kJ/s

Solution Solved by EES Software. Solutions can be verified by copying-and-pasting the following lines on a blank EES screen.

```
T1=40 [C]
m_dot=0.2 [kg/s]
h_f=ENTHALPY(Steam_IAPWS,T=T1,x=0)
h_g=ENTHALPY(Steam_IAPWS,T=T1,x=1)
h_fg=h_g-h_f
Q_dot=m_dot*h_fg
```

"Wrong Solutions:"

```
W1_Q=m_dot*h_f "Using hf"
W2_Q=m_dot*h_g "Using hg"
W3_Q=h_fg "not using mass flow rate"
W4_Q=m_dot*(h_f+h_g) "Adding hf and hg"
```

10-100 Heat transfer coefficients for a vapor condensing on a surface can be increased by promoting _____ condensation with a surface treatment.

- (a) film condensation (b) dropwise condensation (c) rolling action (d) none of them

Answer (b) dropwise condensation

10-101 At a distance x down a vertical, isothermal flat plate on which a saturated vapor is condensing in a continuous film, the thickness of the liquid condensate layer is δ . The heat transfer coefficient at this location on the plate is given by

- (a) k_l / δ (b) δh_f (c) δh_{fg} (d) δh_g (e) none of them

Answer (a) k_l / δ

10-102 When a saturated vapor condenses on a vertical, isothermal flat plate in a continuous film, the rate of heat transfer is proportional to

- (a) $(T_s - T_{\text{sat}})^{1/4}$ (b) $(T_s - T_{\text{sat}})^{1/2}$ (c) $(T_s - T_{\text{sat}})^{3/4}$ (d) $(T_s - T_{\text{sat}})$ (e) $(T_s - T_{\text{sat}})^{2/3}$

Answer (c) $(T_s - T_{\text{sat}})^{3/4}$

10-103 Saturated water vapor is condensing on a 0.5 m^2 vertical flat plate in a continuous film with an average heat transfer coefficient of $7 \text{ kW/m}^2\cdot\text{K}$. The temperature of the water is 80°C ($h_{fg} = 2309 \text{ kJ/kg}$) and the temperature of the plate is 60°C . The rate at which condensate is being formed is

- (a) 0.03 kg/s (b) 0.07 kg/s (c) 0.15 kg/s (d) 0.24 kg/s (e) 0.28 kg/s

Answer (a) 0.03 kg/s

Solution Solved by EES Software. Solutions can be verified by copying-and-pasting the following lines on a blank EES screen.

```
hfg=2309 [kJ/kg]
dT=20 [C]
A=0.5 [m^2]
h=7 [kJ/m^2-K-s]
mdot=h*A*dT/hfg
```

10-104 An air conditioner condenser in an automobile consists of 2 m^2 of tubular heat exchange area whose surface temperature is 30°C . Saturated refrigerant 134a vapor at 50°C ($h_{fg} = 152 \text{ kJ/kg}$) condenses on these tubes. What heat transfer coefficient must exist between the tube surface and condensing vapor to produce 1.5 kg/min of condensate?

- (a) $95 \text{ W/m}^2\cdot\text{K}$ (b) $640 \text{ W/m}^2\cdot\text{K}$ (c) $727 \text{ W/m}^2\cdot\text{K}$ (d) $799 \text{ W/m}^2\cdot\text{K}$ (e) $960 \text{ W/m}^2\cdot\text{K}$

Answer (a) $95 \text{ W/m}^2\cdot\text{K}$

Solution Solved by EES Software. Solutions can be verified by copying-and-pasting the following lines on a blank EES screen.

```
hfg=152000 [J/kg]
dT=20 [C]
A=2 [m^2]
mdot=(1.5/60) [kg/s]
Q=mdot*hfg
Q=h*A*dT
```

10-105 When boiling a saturated liquid, one must be careful while increasing the heat flux to avoid “burnout.” Burnout occurs when the boiling transitions from _____ boiling.

- (a) convection to nucleate (b) convection to film (c) film to nucleate
(d) nucleate to film (e) none of them

Answer (d) nucleate to film

10-106 Steam condenses at 50°C on a 0.8-m-high and 2.4-m-wide vertical plate that is maintained at 30°C. The condensation heat transfer coefficient is

- (a) 3975 W/m²·°C (b) 5150 W/m²·°C (c) 8060 W/m²·°C (d) 11,300 W/m²·°C
(e) 14,810 W/m²·°C

(For water, use $\rho_l = 992.1 \text{ kg/m}^3$, $\mu_l = 0.653 \times 10^{-3} \text{ kg/m}\cdot\text{s}$, $k_l = 0.631 \text{ W/m}\cdot\text{°C}$, $c_{pl} = 4179 \text{ J/kg}\cdot\text{°C}$, $h_{fg @ T_{sat}} = 2383 \text{ kJ/kg}$)

Answer (b) 5150 W/m²·°C

Solution Solved by EES Software. Solutions can be verified by copying-and-pasting the following lines on a blank EES screen.

```
T_sat=50 [C]
T_s=30 [C]
L=0.8 [m]
w=2.4 [m]
```

```
h_fg=2383E3 [J/kg] "at 50 C from Table A-9"
"The properties of water at (50+30)/2=40 C are (Table A-9)"
rho_l=992.1 [kg/m^3]
mu_l=0.653E-3 [kg/m-s]
nu_l=mu_l/rho_l
c_p_l=4179 [J/kg-C]
k_l=0.631 [W/m-C]
g=9.81 [m/s^2]
```

```
h_fg_star=h_fg+0.68*c_p_l*(T_sat-T_s)
Re=(4.81+(3.70*L*k_l*(T_sat-T_s))/(mu_l*h_fg_star)*(g/nu_l^2)^(1/3))^0.820
"Re is between 30 and 1800, and therefore there is wavy laminar flow"
h=(Re*k_l)/(1.08*Re^1.22-5.2)*(g/nu_l^2)^(1/3)
```

10-107 Steam condenses at 50°C on the outer surface of a horizontal tube with an outer diameter of 6 cm. The outer surface of the tube is maintained at 30°C. The condensation heat transfer coefficient is

- (a) 5493 W/m²·°C (b) 5921 W/m²·°C (c) 6796 W/m²·°C (d) 7040 W/m²·°C (e) 7350 W/m²·°C

(For water, use $\rho_l = 992.1 \text{ kg/m}^3$, $\mu_l = 0.653 \times 10^{-3} \text{ kg/m}\cdot\text{s}$, $k_l = 0.631 \text{ W/m}\cdot\text{°C}$, $c_{pl} = 4179 \text{ J/kg}\cdot\text{°C}$, $h_{fg @ T_{sat}} = 2383 \text{ kJ/kg}$)

Answer (c) 6796 W/m²·°C

Solution Solved by EES Software. Solutions can be verified by copying-and-pasting the following lines on a blank EES screen.

T_sat=50 [C]

T_s=30 [C]

D=0.06 [m]

h_fg=2383E3 [J/kg] "at 50 C from Table A-9"

rho_v=0.0831 [kg/m^3]

"The properties of water at (50+30)/2=40 C are (Table A-9)"

rho_l=992.1 [kg/m^3]

mu_l=0.653E-3 [kg/m-s]

c_p_l=4179 [J/kg-C]

k_l=0.631 [W/m-C]

g=9.81 [m/s^2]

h_fg_star=h_fg+0.68*c_p_l*(T_sat-T_s)

h=0.729*((g*rho_l*(rho_l-rho_v)*h_fg_star*k_l^3)/(mu_l*(T_sat-T_s)*D))^0.25

10-108 Steam condenses at 50°C on a tube bank consisting of 20 tubes arranged in a rectangular array of 4 tubes high and 5 tubes wide. Each tube has a diameter of 6 cm and a length of 3 m and the outer surfaces of the tubes are maintained at 30°C. The rate of condensation of steam is

- (a) 0.054 kg/s (b) 0.076 kg/s (c) 0.115 kg/s (d) 0.284 kg/s (e) 0.446 kg/s

(For water, use $\rho_l = 992.1 \text{ kg/m}^3$, $\mu_l = 0.653 \times 10^{-3} \text{ kg/m}\cdot\text{s}$, $k_l = 0.631 \text{ W/m}\cdot\text{°C}$, $c_{pl} = 4179 \text{ J/kg}\cdot\text{°C}$, $h_{fg@T_{sat}} = 2383 \text{ kJ/kg}$)

Answer (e) 0.446 kg/s

Solution Solved by EES Software. Solutions can be verified by copying-and-pasting the following lines on a blank EES screen.

```
T_sat=50 [C]
T_s=30 [C]
D=0.06 [m]
L=3 [m]
N=4
N_total=5*N
```

```
h_fg=2383E3 [J/kg] "at 50 C from Table A-9"
rho_v=0.0831 [kg/m^3] "at 50 C from Table A-9"
"The properties of water at (50+30)/2=40 C are (Table A-9)"
rho_l=992.1 [kg/m^3]
mu_l=0.653E-3 [kg/m-s]
c_p_l=4179 [J/kg-C]
k_l=0.631 [W/m-C]
g=9.81 [m/s^2]
```

```
h_fg_star=h_fg+0.68*c_p_l*(T_sat-T_s)
h_1tube=0.729*((g*rho_l*(rho_l-rho_v)*h_fg_star*k_l^3)/(mu_l*(T_sat-T_s)*D*N))^0.25
h_Ntubes=1/N^0.25*h_1tube
A_s=N_total*pi*D*L
Q_dot=h_Ntubes*A_s*(T_sat-T_s)
m_dot_cond=Q_dot/h_fg_star
```

10-109 ... 10-116 Design and Essay Problems



Chapter 11

HEAT EXCHANGERS

Types of Heat Exchangers

11-1C Heat exchangers are classified according to the flow type as parallel flow, counter flow, and cross-flow arrangement. In parallel flow, both the hot and cold fluids enter the heat exchanger at the same end and move in the same direction. In counter-flow, the hot and cold fluids enter the heat exchanger at opposite ends and flow in opposite direction. In cross-flow, the hot and cold fluid streams move perpendicular to each other.

11-2C In terms of construction type, heat exchangers are classified as compact, shell and tube and regenerative heat exchangers. Compact heat exchangers are specifically designed to obtain large heat transfer surface areas per unit volume. The large surface area in compact heat exchangers is obtained by attaching closely spaced thin plate or corrugated fins to the walls separating the two fluids. Shell and tube heat exchangers contain a large number of tubes packed in a shell with their axes parallel to that of the shell. Regenerative heat exchangers involve the alternate passage of the hot and cold fluid streams through the same flow area. In compact heat exchangers, the two fluids usually move perpendicular to each other.

11-3C A heat exchanger is classified as being compact if $\beta > 700 \text{ m}^2/\text{m}^3$ or $(200 \text{ ft}^2/\text{ft}^3)$ where β is the ratio of the heat transfer surface area to its volume which is called the area density. The area density for double-pipe heat exchanger can not be in the order of 700. Therefore, it can not be classified as a compact heat exchanger.

11-4C In counter-flow heat exchangers, the hot and the cold fluids move parallel to each other but both enter the heat exchanger at opposite ends and flow in opposite direction. In cross-flow heat exchangers, the two fluids usually move perpendicular to each other. The cross-flow is said to be unmixed when the plate fins force the fluid to flow through a particular interfin spacing and prevent it from moving in the transverse direction. When the fluid is free to move in the transverse direction, the cross-flow is said to be mixed.

11-5C In the shell and tube exchangers, baffles are commonly placed in the shell to force the shell side fluid to flow across the shell to enhance heat transfer and to maintain uniform spacing between the tubes. Baffles disrupt the flow of fluid, and an increased pumping power will be needed to maintain flow. On the other hand, baffles eliminate dead spots and increase heat transfer rate.

11-6C Using six-tube passes in a shell and tube heat exchanger increases the heat transfer surface area, and the rate of heat transfer increases. But it also increases the manufacturing costs.

11-7C Using so many tubes increases the heat transfer surface area which in turn increases the rate of heat transfer.

11-8C Regenerative heat exchanger involves the alternate passage of the hot and cold fluid streams through the same flow area. The static type regenerative heat exchanger is basically a porous mass which has a large heat storage capacity, such as a ceramic wire mesh. Hot and cold fluids flow through this porous mass alternately. Heat is transferred from the hot fluid to the matrix of the regenerator during the flow of the hot fluid and from the matrix to the cold fluid. Thus the matrix serves as a temporary heat storage medium. The dynamic type regenerator involves a rotating drum and continuous flow of the hot and cold fluid through different portions of the drum so that any portion of the drum passes periodically through the hot stream, storing heat and then through the cold stream, rejecting this stored heat. Again the drum serves as the medium to transport the heat from the hot to the cold fluid stream.

The Overall Heat Transfer Coefficient

11-9C Heat is first transferred from the hot fluid to the wall by convection, through the wall by conduction and from the wall to the cold fluid again by convection.

11-10C When the wall thickness of the tube is small and the thermal conductivity of the tube material is high, which is usually the case, the thermal resistance of the tube is negligible.

11-11C The heat transfer surface areas are $A_i = \pi D_1 L$ and $A_o = \pi D_2 L$. When the thickness of inner tube is small, it is reasonable to assume $A_i \cong A_o \cong A_s$.

11-12C No, it is not reasonable to say $h_i \approx h_o \approx h$

11-13C When the wall thickness of the tube is small and the thermal conductivity of the tube material is high, the thermal resistance of the tube is negligible and the inner and the outer surfaces of the tube are almost identical ($A_i \cong A_o \cong A_s$). Then the overall heat transfer coefficient of a heat exchanger can be determined to from $U = (1/h_i + 1/h_o)^{-1}$

11-14C None.

11-15C When one of the convection coefficients is much smaller than the other $h_i \ll h_o$, and $A_i \approx A_o \approx A_s$. Then we have $(1/h_i \gg 1/h_o)$ and thus $U_i = U_o = U \cong h_i$.

11-16C The most common type of fouling is the precipitation of solid deposits in a fluid on the heat transfer surfaces. Another form of fouling is corrosion and other chemical fouling. Heat exchangers may also be fouled by the growth of algae in warm fluids. This type of fouling is called the biological fouling. Fouling represents additional resistance to heat transfer and causes the rate of heat transfer in a heat exchanger to decrease, and the pressure drop to increase.

11-17C The effect of fouling on a heat transfer is represented by a fouling factor R_f . Its effect on the heat transfer coefficient is accounted for by introducing a thermal resistance R_f/A_s . The fouling increases with increasing temperature and decreasing velocity.

11-18 The heat transfer coefficients and the fouling factors on tube and shell side of a heat exchanger are given. The thermal resistance and the overall heat transfer coefficients based on the inner and outer areas are to be determined.

Assumptions 1 The heat transfer coefficients and the fouling factors are constant and uniform.

Analysis (a) The total thermal resistance of the heat exchanger per unit length is

$$R = \frac{1}{h_i A_i} + \frac{R_{fi}}{A_i} + \frac{\ln(D_o / D_i)}{2\pi k L} + \frac{R_{fo}}{A_o} + \frac{1}{h_o A_o}$$

$$R = \frac{1}{(700 \text{ W/m}^2 \cdot \text{C})[\pi(0.012 \text{ m})(1 \text{ m})]} + \frac{(0.0005 \text{ m}^2 \cdot \text{C/W})}{[\pi(0.012 \text{ m})(1 \text{ m})]}$$

$$+ \frac{\ln(1.6 / 1.2)}{2\pi(380 \text{ W/m} \cdot \text{C})(1 \text{ m})} + \frac{(0.0002 \text{ m}^2 \cdot \text{C/W})}{[\pi(0.016 \text{ m})(1 \text{ m})]}$$

$$+ \frac{1}{(700 \text{ W/m}^2 \cdot \text{C})[\pi(0.016 \text{ m})(1 \text{ m})]}$$

$$= \mathbf{0.0837 \text{ C/W}}$$

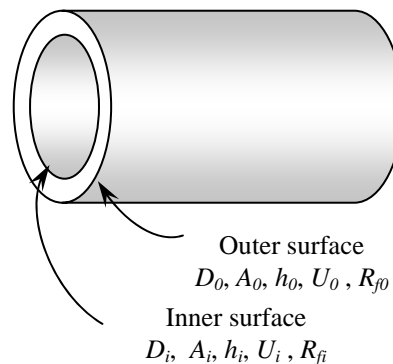

(b) The overall heat transfer coefficient based on the inner and the outer surface areas of the tube per length are

$$R = \frac{1}{UA} = \frac{1}{U_i A_i} = \frac{1}{U_o A_o}$$

$$U_i = \frac{1}{RA_i} = \frac{1}{(0.0837 \text{ C/W})[\pi(0.012 \text{ m})(1 \text{ m})]} = \mathbf{317 \text{ W/m}^2 \cdot \text{C}}$$

$$U_o = \frac{1}{RA_o} = \frac{1}{(0.0837 \text{ C/W})[\pi(0.016 \text{ m})(1 \text{ m})]} = \mathbf{238 \text{ W/m}^2 \cdot \text{C}}$$

11-19 EES Prob. 11-18 is reconsidered. The effects of pipe conductivity and heat transfer coefficients on the thermal resistance of the heat exchanger are to be investigated.

Analysis The problem is solved using EES, and the solution is given below.

"GIVEN"

k=380 [W/m-C]
 D_i=0.012 [m]
 D_o=0.016 [m]
 D_2=0.03 [m]
 h_i=700 [W/m^2-C]
 h_o=1400 [W/m^2-C]
 R_f_i=0.0005 [m^2-C/W]
 R_f_o=0.0002 [m^2-C/W]

"ANALYSIS"

$R = 1/(h_i \cdot A_i) + R_{f_i}/A_i + \ln(D_o/D_i)/(2 \cdot \pi \cdot k \cdot L) + R_{f_o}/A_o + 1/(h_o \cdot A_o)$
 L=1 [m] "a unit length of the heat exchanger is considered"
 A_i=pi*D_i*L
 A_o=pi*D_o*L

k [W/m-C]	R [C/W]
10	0.07392
30.53	0.07085
51.05	0.07024
71.58	0.06999
92.11	0.06984
112.6	0.06975
133.2	0.06969
153.7	0.06964
174.2	0.06961
194.7	0.06958
215.3	0.06956
235.8	0.06954
256.3	0.06952
276.8	0.06951
297.4	0.0695
317.9	0.06949
338.4	0.06948
358.9	0.06947
379.5	0.06947
400	0.06946

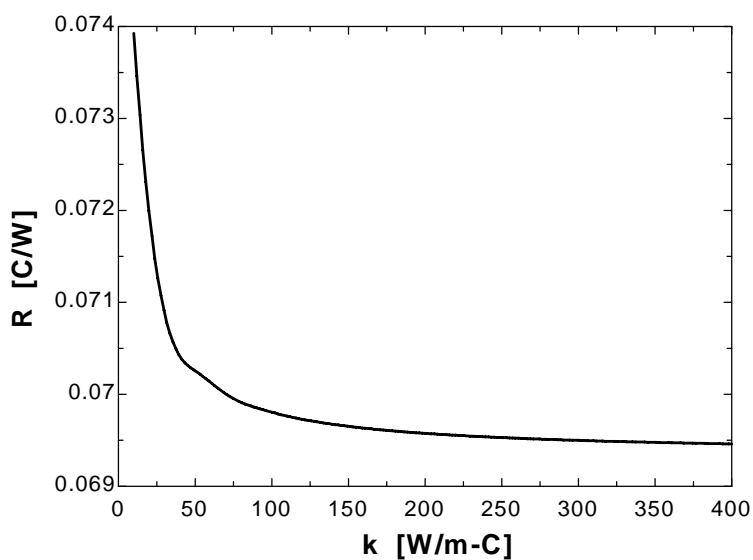

h_i [W/m ² -C]	R [C/W]
500	0.08462
550	0.0798
600	0.07578
650	0.07238
700	0.06947
750	0.06694
800	0.06473
850	0.06278
900	0.06105
950	0.05949
1000	0.0581
1050	0.05684
1100	0.05569
1150	0.05464
1200	0.05368
1250	0.05279
1300	0.05198
1350	0.05122
1400	0.05052
1450	0.04987
1500	0.04926

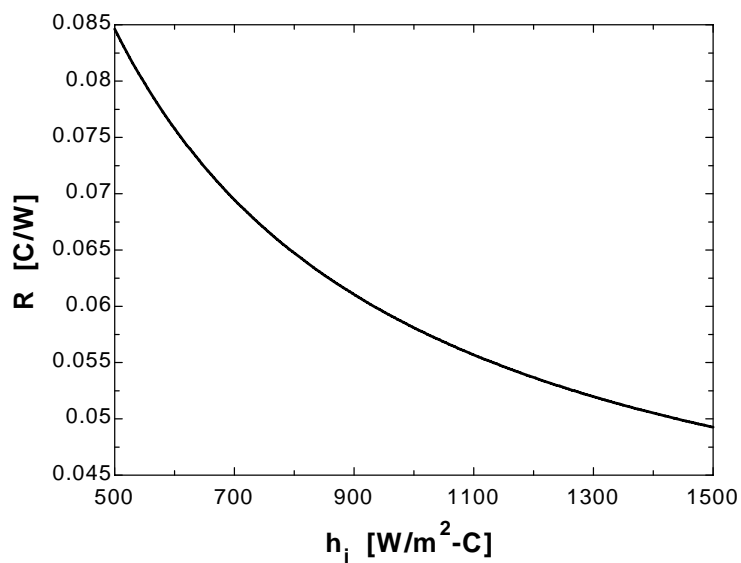

h_o [W/m ² -C]	R [C/W]
1000	0.07515
1050	0.0742
1100	0.07334
1150	0.07256
1200	0.07183
1250	0.07117
1300	0.07056
1350	0.06999
1400	0.06947
1450	0.06898
1500	0.06852
1550	0.06809
1600	0.06769
1650	0.06731
1700	0.06696
1750	0.06662
1800	0.06631
1850	0.06601
1900	0.06573
1950	0.06546
2000	0.0652

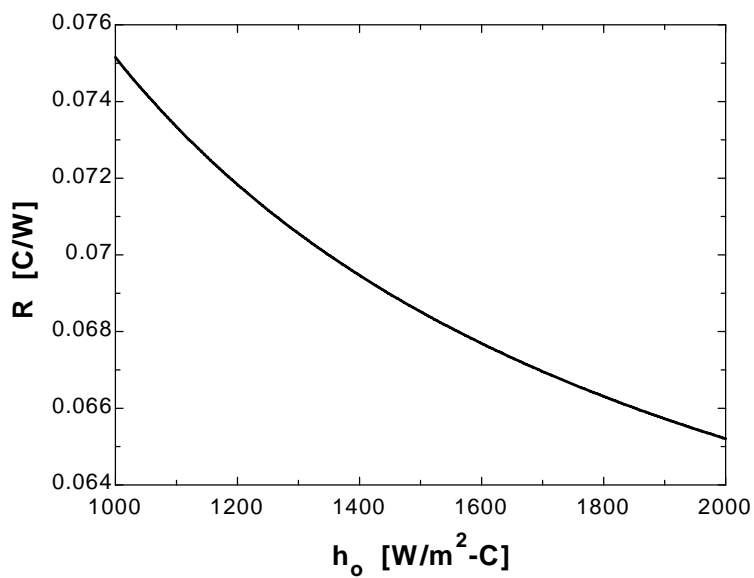

11-20 A water stream is heated by a jacketed-agitated vessel, fitted with a turbine agitator. The mass flow rate of water is to be determined.

Assumptions 1 Steady operating conditions exist. 2 The heat exchanger is well-insulated so that heat loss to the surroundings is negligible and thus heat transfer from the hot fluid is equal to the heat transfer to the cold fluid. 3 Changes in the kinetic and potential energies of fluid streams are negligible. 4 There is no fouling. 5 Fluid properties are constant.

Properties The properties of water at 54°C are (Table A-9)

$$k = 0.648 \text{ W/m}\cdot\text{°C}$$

$$\rho = 985.8 \text{ kg/m}^3$$

$$\mu = 0.513 \times 10^{-3} \text{ kg/m}\cdot\text{s}$$

$$\text{Pr} = 3.31$$

The specific heat of water at the average temperature of $(10+54)/2=32\text{°C}$ is $4178 \text{ J/kg}\cdot\text{°C}$ (Table A-9)

Analysis We first determine the heat transfer coefficient on the inner wall of the vessel

$$\text{Re} = \frac{\dot{n}D_a^2\rho}{\mu} = \frac{(60/60 \text{ s}^{-1})(0.2 \text{ m})^2(985.8 \text{ kg/m}^3)}{0.513 \times 10^{-3} \text{ kg/m}\cdot\text{s}} = 76,865$$

$$\text{Nu} = 0.76\text{Re}^{2/3} \text{Pr}^{1/3} = 0.76(76,865)^{2/3}(3.31)^{1/3} = 2048$$

$$h_j = \frac{k}{D_t} \text{Nu} = \frac{0.648 \text{ W/m}\cdot\text{°C}}{0.6 \text{ m}}(2048) = 2211 \text{ W/m}^2\cdot\text{°C}$$

The heat transfer coefficient on the outer side is determined as follows

$$h_o = 13,100(T_g - T_w)^{-0.25} = 13,100(100 - T_w)^{-0.25}$$

$$h_o(T_g - T_w) = h_j(T_w - 54)$$

$$13,100(100 - T_w)^{-0.25}(100 - T_w) = 2211(T_w - 54)$$

$$13,100(100 - T_w)^{0.75} = 2211(T_w - 54)$$

$$\rightarrow T_w = 89.2\text{°C}$$

$$h_o = 13,100(100 - T_w)^{-0.25} = 13,100(100 - 89.2)^{-0.25} = 7226 \text{ W/m}^2\cdot\text{°C}$$

Neglecting the wall resistance and the thickness of the wall, the overall heat transfer coefficient can be written as

$$U = \left(\frac{1}{h_j} + \frac{1}{h_o} \right)^{-1} = \left(\frac{1}{2211} + \frac{1}{7226} \right)^{-1} = 1694 \text{ W/m}^2\cdot\text{°C}$$

From an energy balance

$$[\dot{m}c(T_{out} - T_{in})]_{\text{water}} = UA\Delta T$$

$$\dot{m}_w(4178)(54 - 10) = (1694)(\pi \times 0.6 \times 0.6)(100 - 54)$$

$$\dot{m}_w = 0.479 \text{ kg/s} = \mathbf{1725 \text{ kg/h}}$$

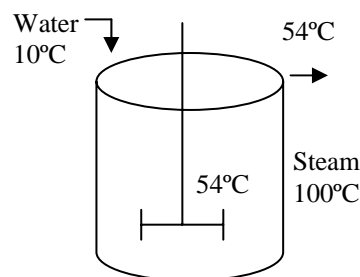

11-21 Water flows through the tubes in a boiler. The overall heat transfer coefficient of this boiler based on the inner surface area is to be determined.

Assumptions 1 Water flow is fully developed. **2** Properties of the water are constant.

Properties The properties of water at 110°C are (Table A-9)

$$\nu = \mu / \rho = 0.268 \times 10^{-6} \text{ m}^2/\text{s}$$

$$k = 0.682 \text{ W/m}^2 \cdot \text{K}$$

$$\text{Pr} = 1.58$$

Analysis The Reynolds number is

$$\text{Re} = \frac{V_{\text{avg}} D_h}{\nu} = \frac{(3.5 \text{ m/s})(0.01 \text{ m})}{0.268 \times 10^{-6} \text{ m}^2/\text{s}} = 130,600$$

which is greater than 10,000. Therefore, the flow is turbulent.

Assuming fully developed flow,

$$\text{Nu} = \frac{h D_h}{k} = 0.023 \text{Re}^{0.8} \text{Pr}^{0.4} = 0.023(130,600)^{0.8} (1.58)^{0.4} = 342$$

$$\text{and } h = \frac{k}{D_h} \text{Nu} = \frac{0.682 \text{ W/m} \cdot \text{°C}}{0.01 \text{ m}} (342) = 23,324 \text{ W/m}^2 \cdot \text{°C}$$

The total resistance of this heat exchanger is then determined from

$$\begin{aligned} R = R_{\text{total}} &= R_i + R_{\text{wall}} + R_o = \frac{1}{h_i A_i} + \frac{\ln(D_o / D_i)}{2\pi k L} + \frac{1}{h_o A_o} \\ &= \frac{1}{(23,324 \text{ W/m}^2 \cdot \text{°C})[\pi(0.01 \text{ m})(5 \text{ m})]} + \frac{\ln(1.4 / 1)}{[2\pi(14.2 \text{ W/m} \cdot \text{°C})(5 \text{ m})]} \\ &\quad + \frac{1}{(8400 \text{ W/m}^2 \cdot \text{°C})[\pi(0.014 \text{ m})(5 \text{ m})]} \\ &= 0.00157 \text{ °C/W} \end{aligned}$$

$$\text{and } R = \frac{1}{U_i A_i} \longrightarrow U_i = \frac{1}{R A_i} = \frac{1}{(0.00157 \text{ °C/W})[\pi(0.01 \text{ m})(5 \text{ m})]} = \mathbf{4055 \text{ W/m}^2 \cdot \text{°C}}$$

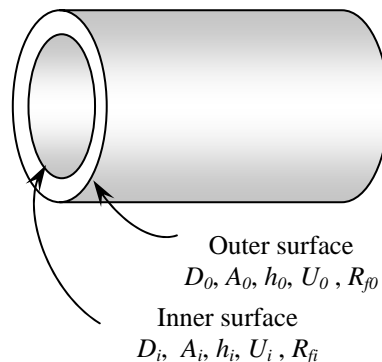

11-22 Water is flowing through the tubes in a boiler. The overall heat transfer coefficient of this boiler based on the inner surface area is to be determined.

Assumptions 1 Water flow is fully developed. 2 Properties of water are constant. 3 The heat transfer coefficient and the fouling factor are constant and uniform.

Properties The properties of water at 110°C are (Table A-9)

$$\nu = \mu / \rho = 0.268 \times 10^{-6} \text{ m}^2/\text{s}$$

$$k = 0.682 \text{ W/m}^2 \cdot \text{K}$$

$$\text{Pr} = 1.58$$

Analysis The Reynolds number is

$$\text{Re} = \frac{V_{\text{avg}} D_h}{\nu} = \frac{(3.5 \text{ m/s})(0.01 \text{ m})}{0.268 \times 10^{-6} \text{ m}^2/\text{s}} = 130,600$$

which is greater than 10,000. Therefore, the flow is turbulent. Assuming fully developed flow,

$$\text{Nu} = \frac{hD_h}{k} = 0.023 \text{Re}^{0.8} \text{Pr}^{0.4} = 0.023(130,600)^{0.8} (1.58)^{0.4} = 342$$

$$\text{and } h = \frac{k}{D_h} \text{Nu} = \frac{0.682 \text{ W/m} \cdot \text{°C}}{0.01 \text{ m}} (342) = 23,324 \text{ W/m}^2 \cdot \text{°C}$$

The thermal resistance of heat exchanger with a fouling factor of $R_{f,i} = 0.0005 \text{ m}^2 \cdot \text{°C/W}$ is determined from

$$\begin{aligned} R &= \frac{1}{h_i A_i} + \frac{R_{f,i}}{A_i} + \frac{\ln(D_o / D_i)}{2\pi k L} + \frac{1}{h_o A_o} \\ R &= \frac{1}{(23,324 \text{ W/m}^2 \cdot \text{°C})[\pi(0.01 \text{ m})(5 \text{ m})]} + \frac{0.0005 \text{ m}^2 \cdot \text{°C/W}}{[\pi(0.01 \text{ m})(5 \text{ m})]} \\ &\quad + \frac{\ln(1.4/1)}{2\pi(14.2 \text{ W/m} \cdot \text{°C})(5 \text{ m})} + \frac{1}{(8400 \text{ W/m}^2 \cdot \text{°C})[\pi(0.014 \text{ m})(5 \text{ m})]} \\ &= 0.00475 \text{ °C/W} \end{aligned}$$

Then,

$$R = \frac{1}{U_i A_i} \rightarrow U_i = \frac{1}{R A_i} = \frac{1}{(0.00475 \text{ °C/W})[\pi(0.01 \text{ m})(5 \text{ m})]} = \mathbf{1340 \text{ W/m}^2 \cdot \text{°C}}$$

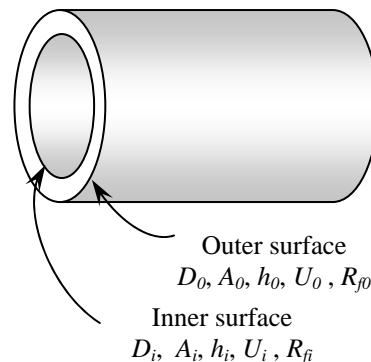

11-23 EES Prob. 11-21 is reconsidered. The overall heat transfer coefficient based on the inner surface as a function of fouling factor is to be plotted.

Analysis The problem is solved using EES, and the solution is given below.

"GIVEN"

T_w=110 [C]
 Vel=3.5 [m/s]
 L=5 [m]
 k_pipe=14.2 [W/m-C]
 D_i=0.010 [m]
 D_o=0.014 [m]
 h_o=8400 [W/m^2-C]
 R_f_i=0.0005 [m^2-C/W]

"PROPERTIES"

k=conductivity(Water, T=T_w, P=300)
 Pr=Prandtl(Water, T=T_w, P=300)
 rho=density(Water, T=T_w, P=300)
 mu=viscosity(Water, T=T_w, P=300)
 nu=mu/rho

"ANALYSIS"

Re=(Vel*D_i)/nu "Re is calculated to be greater than 10,000. Therefore, the flow is turbulent."

Nusselt=0.023*Re^0.8*Pr^0.4

h_i=k/D_i*Nusselt

A_i=pi*D_i*L

A_o=pi*D_o*L

R=1/(h_i*A_i)+R_f_i/A_i+ln(D_o/D_i)/(2*pi*k_pipe*L)+1/(h_o*A_o)

U_i=1/(R*A_i)

R _{f,i} [m ² -C/W]	U _i [W/m ² -C]
0.0001	2883
0.00015	2520
0.0002	2238
0.00025	2013
0.0003	1829
0.00035	1675
0.0004	1546
0.00045	1435
0.0005	1339
0.00055	1255
0.0006	1181
0.00065	1115
0.0007	1056
0.00075	1003
0.0008	955.2

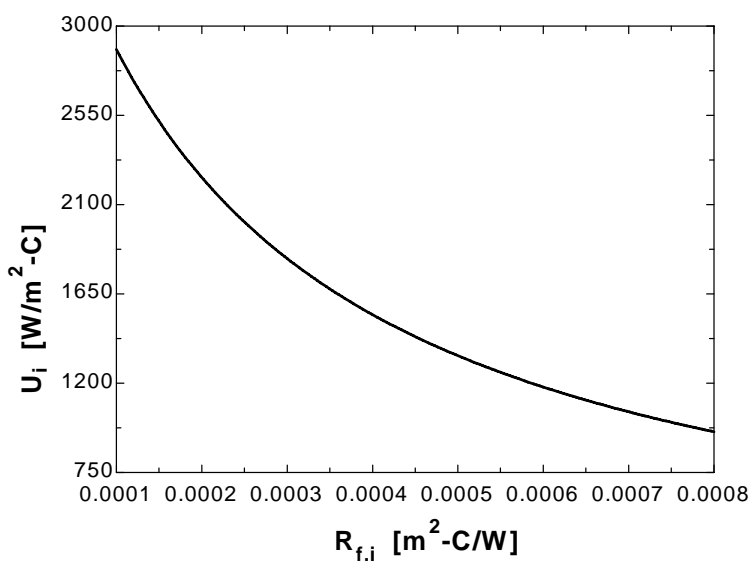

11-24 Refrigerant-134a is cooled by water in a double-pipe heat exchanger. The overall heat transfer coefficient is to be determined.

Assumptions 1 The thermal resistance of the inner tube is negligible since the tube material is highly conductive and its thickness is negligible. **2** Both the water and refrigerant-134a flow are fully developed. **3** Properties of the water and refrigerant-134a are constant.

Properties The properties of water at 20°C are (Table A-9)

$$\begin{aligned}\rho &= 998 \text{ kg/m}^3 \\ \nu &= \mu / \rho = 1.004 \times 10^{-6} \text{ m}^2/\text{s} \\ k &= 0.598 \text{ W/m}\cdot^\circ\text{C} \\ \text{Pr} &= 7.01\end{aligned}$$

Analysis The hydraulic diameter for annular space is

$$D_h = D_o - D_i = 0.025 - 0.01 = 0.015 \text{ m}$$

The average velocity of water in the tube and the Reynolds number are

$$V_{avg} = \frac{\dot{m}}{\rho A_c} = \frac{\dot{m}}{\rho \left(\pi \frac{D_o^2 - D_i^2}{4} \right)} = \frac{0.3 \text{ kg/s}}{(998 \text{ kg/m}^3) \left(\pi \frac{(0.025 \text{ m})^2 - (0.01 \text{ m})^2}{4} \right)} = 0.729 \text{ m/s}$$

$$\text{Re} = \frac{V_{avg} D_h}{\nu} = \frac{(0.729 \text{ m/s})(0.015 \text{ m})}{1.004 \times 10^{-6} \text{ m}^2/\text{s}} = 10,890$$

which is greater than 4000. Therefore flow is turbulent. Assuming fully developed flow,

$$\text{Nu} = \frac{h D_h}{k} = 0.023 \text{Re}^{0.8} \text{Pr}^{0.4} = 0.023(10,890)^{0.8} (7.01)^{0.4} = 85.0$$

and

$$h_o = \frac{k}{D_h} \text{Nu} = \frac{0.598 \text{ W/m}\cdot^\circ\text{C}}{0.015 \text{ m}} (85.0) = 3390 \text{ W/m}^2\cdot^\circ\text{C}$$

Then the overall heat transfer coefficient becomes

$$U = \frac{1}{\frac{1}{h_i} + \frac{1}{h_o}} = \frac{1}{\frac{1}{5000 \text{ W/m}^2\cdot^\circ\text{C}} + \frac{1}{3390 \text{ W/m}^2\cdot^\circ\text{C}}} = \mathbf{2020 \text{ W/m}^2\cdot^\circ\text{C}}$$

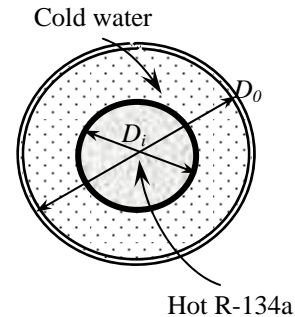

11-25 Refrigerant-134a is cooled by water in a double-pipe heat exchanger. The overall heat transfer coefficient is to be determined.

Assumptions 1 The thermal resistance of the inner tube is negligible since the tube material is highly conductive and its thickness is negligible. **2** Both the water and refrigerant-134a flows are fully developed. **3** Properties of the water and refrigerant-134a are constant. **4** The limestone layer can be treated as a plain layer since its thickness is very small relative to its diameter.

Properties The properties of water at 20°C are (Table A-9)

$$\begin{aligned}\rho &= 998 \text{ kg/m}^3 \\ \nu &= \mu / \rho = 1.004 \times 10^{-6} \text{ m}^2/\text{s} \\ k &= 0.598 \text{ W/m}\cdot\text{°C} \\ \text{Pr} &= 7.01\end{aligned}$$

Analysis The hydraulic diameter for annular space is

$$D_h = D_o - D_i = 0.025 - 0.01 = 0.015 \text{ m}$$

The average velocity of water in the tube and the Reynolds number are

$$V_{\text{avg}} = \frac{\dot{m}}{\rho A_c} = \frac{\dot{m}}{\rho \left(\pi \frac{D_o^2 - D_i^2}{4} \right)} = \frac{0.3 \text{ kg/s}}{(998 \text{ kg/m}^3) \left(\pi \frac{(0.025 \text{ m})^2 - (0.01 \text{ m})^2}{4} \right)} = 0.729 \text{ m/s}$$

$$\text{Re} = \frac{V_{\text{avg}} D_h}{\nu} = \frac{(0.729 \text{ m/s})(0.015 \text{ m})}{1.004 \times 10^{-6} \text{ m}^2/\text{s}} = 10,890$$

which is greater than 10,000. Therefore flow is turbulent. Assuming fully developed flow,

$$\text{Nu} = \frac{h D_h}{k} = 0.023 \text{Re}^{0.8} \text{Pr}^{0.4} = 0.023(10,890)^{0.8} (7.01)^{0.4} = 85.0$$

and

$$h_o = \frac{k}{D_h} \text{Nu} = \frac{0.598 \text{ W/m}\cdot\text{°C}}{0.015 \text{ m}} (85.0) = 3390 \text{ W/m}^2\cdot\text{°C}$$

Disregarding the curvature effects, the overall heat transfer coefficient is determined to be

$$U = \frac{1}{\frac{1}{h_i} + \left(\frac{L}{k} \right)_{\text{limestone}} + \frac{1}{h_o}} = \frac{1}{\frac{1}{5000 \text{ W/m}^2\cdot\text{°C}} + \frac{0.002 \text{ m}}{1.3 \text{ W/m}\cdot\text{°C}} + \frac{1}{3390 \text{ W/m}^2\cdot\text{°C}}} = 493 \text{ W/m}^2\cdot\text{°C}$$

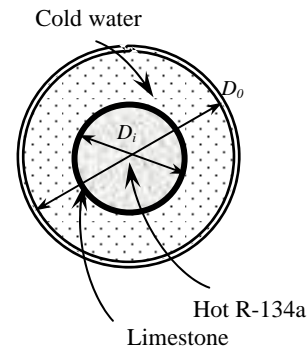

11-26 EES Prob. 11-25 is reconsidered. The overall heat transfer coefficient as a function of the limestone thickness is to be plotted.

Analysis The problem is solved using EES, and the solution is given below.

"GIVEN"

D_i=0.010 [m]
 D_o=0.025 [m]
 T_w=20 [C]
 h_i=5000 [W/m²-C]
 m_{dot}=0.3 [kg/s]
 L_{limestone}=2 [mm]
 k_{limestone}=1.3 [W/m-C]

"PROPERTIES"

k=conductivity(Water, T=T_w, P=100)
 Pr=Prandtl(Water, T=T_w, P=100)
 rho=density(Water, T=T_w, P=100)
 mu=viscosity(Water, T=T_w, P=100)
 nu=mu/rho

"ANALYSIS"

D_h=D_o-D_i
 Vel=m_{dot}/(rho*A_c)
 A_c=pi*(D_o²-D_i²)/4
 Re=(Vel*D_h)/nu
 "Re is calculated to be greater than 10,000. Therefore, the flow is turbulent."
 Nusselt=0.023*Re^{0.8}*Pr^{0.4}
 h_o=k/D_h*Nusselt
 U=1/(1/h_i+(L_{limestone}*Convert(mm, m))/k_{limestone}+1/h_o)

L _{limestone} [mm]	U [W/m ² -C]
1	791.4
1.1	746
1.2	705.5
1.3	669.2
1.4	636.4
1.5	606.7
1.6	579.7
1.7	554.9
1.8	532.2
1.9	511.3
2	491.9
2.1	474
2.2	457.3
2.3	441.8
2.4	427.3
2.5	413.7
2.6	400.9
2.7	388.9
2.8	377.6
2.9	367
3	356.9

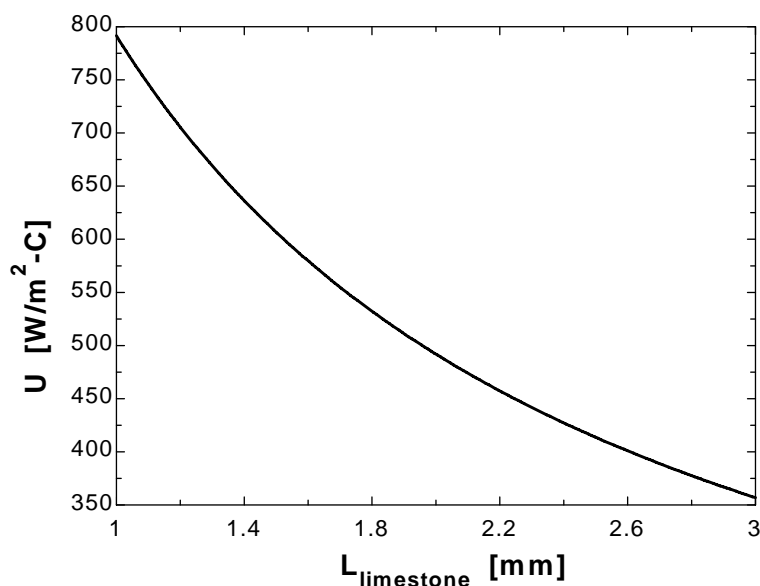

11-27E Water is cooled by air in a cross-flow heat exchanger. The overall heat transfer coefficient is to be determined.

Assumptions 1 The thermal resistance of the inner tube is negligible since the tube material is highly conductive and its thickness is negligible. **2** Both the water and air flow are fully developed. **3** Properties of the water and air are constant.

Properties The properties of water at 180°F are (Table A-9E)

$$k = 0.388 \text{ Btu/h}\cdot\text{ft}\cdot^\circ\text{F}$$

$$\nu = 3.825 \times 10^{-6} \text{ ft}^2/\text{s}$$

$$\text{Pr} = 2.15$$

The properties of air at 80°F are (Table A-15E)

$$k = 0.01481 \text{ Btu/h}\cdot\text{ft}\cdot^\circ\text{F}$$

$$\nu = 1.697 \times 10^{-4} \text{ ft}^2/\text{s}$$

$$\text{Pr} = 0.7290$$

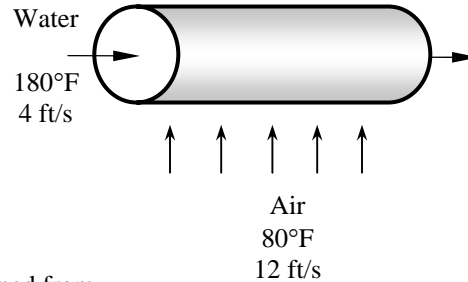

Analysis The overall heat transfer coefficient can be determined from

$$\frac{1}{U} = \frac{1}{h_i} + \frac{1}{h_o}$$

The Reynolds number of water is

$$\text{Re} = \frac{V_{\text{avg}} D_h}{\nu} = \frac{(4 \text{ ft/s})(0.75/12 \text{ ft})}{3.825 \times 10^{-6} \text{ ft}^2/\text{s}} = 65,360$$

which is greater than 10,000. Therefore the flow of water is turbulent. Assuming the flow to be fully developed, the Nusselt number is determined from

$$\text{Nu} = \frac{hD_h}{k} = 0.023 \text{Re}^{0.8} \text{Pr}^{0.4} = 0.023(65,360)^{0.8} (2.15)^{0.4} = 222$$

and
$$h_i = \frac{k}{D_h} \text{Nu} = \frac{0.388 \text{ Btu/h}\cdot\text{ft}\cdot^\circ\text{F}}{0.75/12 \text{ ft}} (222) = 1378 \text{ Btu/h}\cdot\text{ft}^2\cdot^\circ\text{F}$$

The Reynolds number of air is

$$\text{Re} = \frac{VD}{\nu} = \frac{(12 \text{ ft/s})[3/(4 \times 12) \text{ ft}]}{1.697 \times 10^{-4} \text{ ft}^2/\text{s}} = 4420$$

The flow of air is across the cylinder. The proper relation for Nusselt number in this case is

$$\begin{aligned} \text{Nu} = \frac{hD}{k} &= 0.3 + \frac{0.62 \text{Re}^{0.5} \text{Pr}^{1/3}}{\left[1 + (0.4/\text{Pr})^{2/3}\right]^{1/4}} \left[1 + \left(\frac{\text{Re}}{282,000}\right)^{5/8}\right]^{4/5} \\ &= 0.3 + \frac{0.62(4420)^{0.5} (0.7290)^{1/3}}{\left[1 + (0.4/0.7290)^{2/3}\right]^{1/4}} \left[1 + \left(\frac{4420}{282,000}\right)^{5/8}\right]^{4/5} = 34.86 \end{aligned}$$

and
$$h_o = \frac{k}{D} \text{Nu} = \frac{0.01481 \text{ Btu/h}\cdot\text{ft}\cdot^\circ\text{F}}{0.75/12 \text{ ft}} (34.86) = 8.26 \text{ Btu/h}\cdot\text{ft}^2\cdot^\circ\text{F}$$

Then the overall heat transfer coefficient becomes

$$U = \frac{1}{\frac{1}{h_i} + \frac{1}{h_o}} = \frac{1}{\frac{1}{1378 \text{ Btu/h}\cdot\text{ft}^2\cdot^\circ\text{F}} + \frac{1}{8.26 \text{ Btu/h}\cdot\text{ft}^2\cdot^\circ\text{F}}} = \mathbf{8.21 \text{ Btu/h}\cdot\text{ft}^2\cdot^\circ\text{F}}$$

Analysis of Heat Exchangers

11-28C The heat exchangers usually operate for long periods of time with no change in their operating conditions, and then they can be modeled as steady-flow devices. As such, the mass flow rate of each fluid remains constant and the fluid properties such as temperature and velocity at any inlet and outlet remain constant. The kinetic and potential energy changes are negligible. The specific heat of a fluid can be treated as constant in a specified temperature range. Axial heat conduction along the tube is negligible. Finally, the outer surface of the heat exchanger is assumed to be perfectly insulated so that there is no heat loss to the surrounding medium and any heat transfer thus occurs is between the two fluids only.

11-29C That relation is valid under steady operating conditions, constant specific heats, and negligible heat loss from the heat exchanger.

11-30C The product of the mass flow rate and the specific heat of a fluid is called the heat capacity rate and is expressed as $C = \dot{m}c_p$. When the heat capacity rates of the cold and hot fluids are equal, the temperature change is the same for the two fluids in a heat exchanger. That is, the temperature rise of the cold fluid is equal to the temperature drop of the hot fluid. A heat capacity of infinity for a fluid in a heat exchanger is experienced during a phase-change process in a condenser or boiler.

11-31C The mass flow rate of the cooling water can be determined from $\dot{Q} = (\dot{m}c_p\Delta T)_{\text{cooling water}}$. The rate of condensation of the steam is determined from $\dot{Q} = (\dot{m}h_{fg})_{\text{steam}}$, and the total thermal resistance of the condenser is determined from $R = \dot{Q} / \Delta T$.

11-32C When the heat capacity rates of the cold and hot fluids are identical, the temperature rise of the cold fluid will be equal to the temperature drop of the hot fluid.

The Log Mean Temperature Difference Method

11-33C ΔT_{lm} is called the log mean temperature difference, and is expressed as

$$\Delta T_{lm} = \frac{\Delta T_1 - \Delta T_2}{\ln(\Delta T_1 / \Delta T_2)}$$

where

$$\Delta T_1 = T_{h,in} - T_{c,in} \quad \Delta T_2 = T_{h,out} - T_{c,out} \quad \text{for parallel-flow heat exchangers and}$$

$$\Delta T_1 = T_{h,in} - T_{c,out} \quad \Delta T_2 = T_{h,out} - T_{c,in} \quad \text{for counter-flow heat exchangers}$$

11-34C The temperature difference between the two fluids decreases from ΔT_1 at the inlet to ΔT_2 at the outlet, and arithmetic mean temperature difference is defined as $\Delta T_{am} = \frac{\Delta T_1 + \Delta T_2}{2}$. The logarithmic mean temperature difference ΔT_{lm} is obtained by tracing the actual temperature profile of the fluids along the heat exchanger, and is an exact representation of the average temperature difference between the hot and cold fluids. It truly reflects the exponential decay of the local temperature difference. The logarithmic mean temperature difference is always less than the arithmetic mean temperature.

11-35C ΔT_{lm} cannot be greater than both ΔT_1 and ΔT_2 because ΔT_{ln} is always less than or equal to ΔT_m (arithmetic mean) which can not be greater than both ΔT_1 and ΔT_2 .

11-36C No, it cannot. When ΔT_1 is less than ΔT_2 the ratio of them must be less than one and the natural logarithms of the numbers which are less than 1 are negative. But the numerator is also negative in this case. When ΔT_1 is greater than ΔT_2 , we obtain positive numbers at the both numerator and denominator.

11-37C In the parallel-flow heat exchangers the hot and cold fluids enter the heat exchanger at the same end, and the temperature of the hot fluid decreases and the temperature of the cold fluid increases along the heat exchanger. But the temperature of the cold fluid can never exceed that of the hot fluid. In case of the counter-flow heat exchangers the hot and cold fluids enter the heat exchanger from the opposite ends and the outlet temperature of the cold fluid may exceed the outlet temperature of the hot fluid.

11-38C The ΔT_{lm} will be greatest for double-pipe counter-flow heat exchangers.

11-39C The factor F is called as correction factor which depends on the geometry of the heat exchanger and the inlet and the outlet temperatures of the hot and cold fluid streams. It represents how closely a heat exchanger approximates a counter-flow heat exchanger in terms of its logarithmic mean temperature difference. F cannot be greater than unity.

11-40C In this case it is not practical to use the LMTD method because it requires tedious iterations. Instead, the effectiveness-NTU method should be used.

11-41C First heat transfer rate is determined from $\dot{Q} = \dot{m}c_p [T_{in} - T_{out}]$, ΔT_{ln} from $\Delta T_{lm} = \frac{\Delta T_1 - \Delta T_2}{\ln(\Delta T_1 / \Delta T_2)}$, correction factor from the figures, and finally the surface area of the heat exchanger from $\dot{Q} = UAFDT_{lm,CF}$

11-42 Ethylene glycol is heated in a tube while steam condenses on the outside tube surface. The tube length is to be determined.

Assumptions 1 Steady flow conditions exist. **2** The inner surfaces of the tubes are smooth. **3** Heat transfer to the surroundings is negligible.

Properties The properties of ethylene glycol are given to be $\rho = 1109 \text{ kg/m}^3$, $c_p = 2428 \text{ J/kg}\cdot\text{K}$, $k = 0.253 \text{ W/m}\cdot\text{K}$, $\mu = 0.01545 \text{ kg/m}\cdot\text{s}$, $\text{Pr} = 148.5$. The thermal conductivity of copper is given to be $386 \text{ W/m}\cdot\text{K}$.

Analysis The rate of heat transfer is

$$\dot{Q} = \dot{m}c_p(T_e - T_i) = (1 \text{ kg/s})(2428 \text{ J/kg}\cdot^\circ\text{C})(40 - 20)^\circ\text{C} = 48,560 \text{ W}$$

The fluid velocity is

$$V = \frac{\dot{m}}{\rho A_c} = \frac{1 \text{ kg/s}}{(1109 \text{ kg/m}^3)[\pi(0.02 \text{ m})^2 / 4]} = 2.870 \text{ m/s}$$

The Reynolds number is

$$\text{Re} = \frac{\rho V D}{\mu} = \frac{(1109 \text{ kg/m}^3)(2.870 \text{ m/s})(0.02 \text{ m})}{0.01545 \text{ kg/m}\cdot\text{s}} = 4121$$

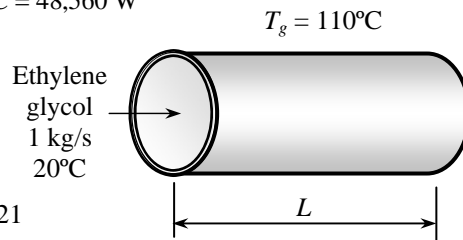

which is greater than 2300 and smaller than 10,000. Therefore, we have transitional flow. We assume fully developed flow and evaluate the Nusselt number from turbulent flow relation:

$$\text{Nu} = \frac{hD}{k} = 0.023 \text{Re}^{0.8} \text{Pr}^{0.4} = 0.023(4121)^{0.8} (148.5)^{0.4} = 132.5$$

Heat transfer coefficient on the inner surface is

$$h_i = \frac{k}{D} \text{Nu} = \frac{0.253 \text{ W/m}\cdot^\circ\text{C}}{0.02 \text{ m}} (132.5) = 1677 \text{ W/m}^2\cdot^\circ\text{C}$$

Assuming a wall temperature of 100°C , the heat transfer coefficient on the outer surface is determined to be

$$h_o = 9200(T_g - T_w)^{-0.25} = 9200(110 - 100)^{-0.25} = 5174 \text{ W/m}^2\cdot^\circ\text{C}$$

Let us check if the assumption for the wall temperature holds:

$$h_i A_i (T_w - T_{b,\text{avg}}) = h_o A_o (T_g - T_w)$$

$$h_i \pi D_i L (T_w - T_{b,\text{avg}}) = h_o \pi D_o L (T_g - T_w)$$

$$1677 \times 0.02 (T_w - 30) = 5174 \times 0.025 (110 - T_w) \longrightarrow T_w = 93.5^\circ\text{C}$$

Now we assume a wall temperature of 90°C :

$$h_o = 9200(T_g - T_w)^{-0.25} = 9200(110 - 90)^{-0.25} = 4350 \text{ W/m}^2\cdot^\circ\text{C}$$

Again checking, $1677 \times 0.02 (T_w - 30) = 4350 \times 0.025 (110 - T_w) \longrightarrow T_w = 91.1^\circ\text{C}$

which is sufficiently close to the assumed value of 90°C . Now that both heat transfer coefficients are available, we use thermal resistance concept to find overall heat transfer coefficient based on the outer surface area as follows:

$$U_o = \frac{1}{\frac{D_o}{h_i D_i} + \frac{D_o \ln(D_2 / D_1)}{2k_{\text{copper}}} + \frac{1}{h_o}} = \frac{1}{\frac{0.025}{(1677)(0.02)} + \frac{(0.025) \ln(2.5 / 2)}{2(386)} + \frac{1}{4350}} = 1018 \text{ W/m}^2\cdot^\circ\text{C}$$

The rate of heat transfer can be expressed as

$$\dot{Q} = U_o A_o \Delta T_{\text{lm}}$$

where the logarithmic mean temperature difference is

$$\Delta T_{\text{lm}} = \frac{(T_g - T_e) - (T_g - T_i)}{\ln\left(\frac{T_g - T_e}{T_g - T_i}\right)} = \frac{(110 - 40) - (110 - 20)}{\ln\left(\frac{110 - 40}{110 - 20}\right)} = 79.58^\circ\text{C}$$

Substituting, the tube length is determined to be

$$\dot{Q} = U_o A_o \Delta T_{\text{lm}} \longrightarrow 48,560 = (1018)\pi(0.025)L(79.58) \longrightarrow L = \mathbf{7.63 \text{ m}}$$

11-43 Water is heated in a double-pipe, parallel-flow uninsulated heat exchanger by geothermal water. The rate of heat transfer to the cold water and the log mean temperature difference for this heat exchanger are to be determined.

Assumptions 1 Steady operating conditions exist. 2 Changes in the kinetic and potential energies of fluid streams are negligible. 4 There is no fouling. 5 Fluid properties are constant.

Properties The specific heat of hot water is given to be 4.25 kJ/kg·°C.

Analysis The rate of heat given up by the hot water is

$$\begin{aligned}\dot{Q}_h &= [\dot{m}c_p(T_{in} - T_{out})]_{\text{hot water}} \\ &= (1.4 \text{ kg/s})(4.25 \text{ kJ/kg}\cdot\text{°C})(85\text{°C} - 50\text{°C}) = 208.3 \text{ kW}\end{aligned}$$

The rate of heat picked up by the cold water is

$$\dot{Q}_c = (1 - 0.03)\dot{Q}_h = (1 - 0.03)(208.3 \text{ kW}) = \mathbf{202.0 \text{ kW}}$$

The log mean temperature difference is

$$\dot{Q} = UA\Delta T_{lm} \longrightarrow \Delta T_{lm} = \frac{\dot{Q}}{UA} = \frac{202.0 \text{ kW}}{(1.15 \text{ kW/m}^2\cdot\text{°C})(4 \text{ m}^2)} = \mathbf{43.9\text{°C}}$$

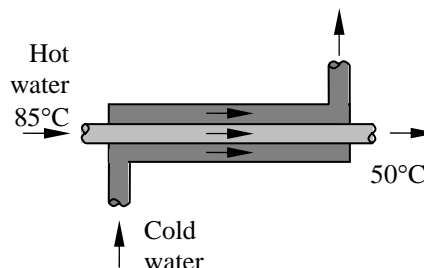

11-44 A stream of hydrocarbon is cooled by water in a double-pipe counterflow heat exchanger. The overall heat transfer coefficient is to be determined.

Assumptions 1 Steady operating conditions exist. 2 The heat exchanger is well-insulated so that heat loss to the surroundings is negligible and thus heat transfer from the hot fluid is equal to the heat transfer to the cold fluid. 3 Changes in the kinetic and potential energies of fluid streams are negligible. 4 There is no fouling. 5 Fluid properties are constant.

Properties The specific heats of hydrocarbon and water are given to be 2.2 and 4.18 kJ/kg·°C, respectively.

Analysis The rate of heat transfer is

$$\dot{Q} = [\dot{m}c_p(T_{out} - T_{in})]_{\text{HC}} = (720 / 3600 \text{ kg/s})(2.2 \text{ kJ/kg}\cdot\text{°C})(150\text{°C} - 40\text{°C}) = 48.4 \text{ kW}$$

The outlet temperature of water is

$$\begin{aligned}\dot{Q} &= [\dot{m}c_p(T_{out} - T_{in})]_w \\ 48.4 \text{ kW} &= (540 / 3600 \text{ kg/s})(4.18 \text{ kJ/kg}\cdot\text{°C})(T_{w,\text{out}} - 10\text{°C}) \\ T_{w,\text{out}} &= 87.2\text{°C}\end{aligned}$$

The logarithmic mean temperature difference is

$$\begin{aligned}\Delta T_1 &= T_{h,\text{in}} - T_{c,\text{out}} = 150\text{°C} - 87.2\text{°C} = 62.8\text{°C} \\ \Delta T_2 &= T_{h,\text{out}} - T_{c,\text{in}} = 40\text{°C} - 10\text{°C} = 30\text{°C}\end{aligned}$$

$$\text{and } \Delta T_{lm} = \frac{\Delta T_1 - \Delta T_2}{\ln(\Delta T_1 / \Delta T_2)} = \frac{62.8 - 30}{\ln(62.8 / 30)} = 44.4\text{°C}$$

The overall heat transfer coefficient is determined from

$$\begin{aligned}\dot{Q} &= UA\Delta T_{lm} \\ 48.4 \text{ kW} &= U(\pi \times 0.025 \times 6.0)(44.4\text{°C}) \\ U &= \mathbf{2.31 \text{ kW/m}^2\cdot\text{K}}\end{aligned}$$

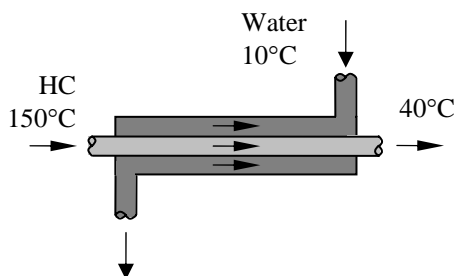

11-45 Oil is heated by water in a 1-shell pass and 6-tube passes heat exchanger. The rate of heat transfer and the heat transfer surface area are to be determined.

Assumptions 1 Steady operating conditions exist. 2 The heat exchanger is well-insulated so that heat loss to the surroundings is negligible and thus heat transfer from the hot fluid is equal to the heat transfer to the cold fluid. 3 Changes in the kinetic and potential energies of fluid streams are negligible. 4 There is no fouling. 5 Fluid properties are constant.

Properties The specific heat of oil is given to be 2.0 kJ/kg·°C.

Analysis The rate of heat transfer in this heat exchanger is

$$\dot{Q} = [\dot{m}c_p(T_{out} - T_{in})]_{oil} = (10 \text{ kg/s})(2.0 \text{ kJ/kg}\cdot\text{°C})(46\text{°C} - 25\text{°C}) = \mathbf{420 \text{ kW}}$$

The logarithmic mean temperature difference for counter-flow arrangement and the correction factor F are

$$\Delta T_1 = T_{h,in} - T_{c,out} = 80\text{°C} - 46\text{°C} = 34\text{°C}$$

$$\Delta T_2 = T_{h,out} - T_{c,in} = 60\text{°C} - 25\text{°C} = 35\text{°C}$$

$$\Delta T_{lm,CF} = \frac{\Delta T_1 - \Delta T_2}{\ln(\Delta T_1 / \Delta T_2)} = \frac{34 - 35}{\ln(34 / 35)} = 34.5\text{°C}$$

$$\left. \begin{aligned} P &= \frac{t_2 - t_1}{T_1 - t_1} = \frac{46 - 25}{80 - 25} = 0.38 \\ R &= \frac{T_1 - T_2}{t_2 - t_1} = \frac{80 - 60}{46 - 25} = 0.95 \end{aligned} \right\} F = 0.94$$

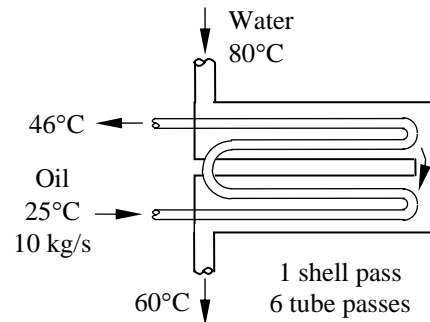

Then the heat transfer surface area on the tube side becomes

$$\dot{Q} = UA_s F \Delta T_{lm,CF} \longrightarrow A_s = \frac{\dot{Q}}{UF \Delta T_{lm,CF}} = \frac{420 \text{ kW}}{(1.0 \text{ kW/m}^2\cdot\text{°C})(0.94)(34.5\text{°C})} = \mathbf{13.0 \text{ m}^2}$$

11-46 Steam is condensed by cooling water in the condenser of a power plant. The mass flow rate of the cooling water and the rate of condensation are to be determined.

Assumptions 1 Steady operating conditions exist. 2 The heat exchanger is well-insulated so that heat loss to the surroundings is negligible and thus heat transfer from the hot fluid is equal to the heat transfer to the cold fluid. 3 Changes in the kinetic and potential energies of fluid streams are negligible. 4 There is no fouling. 5 Fluid properties are constant.

Properties The heat of vaporization of water at 50°C is given to be $h_{fg} = 2383 \text{ kJ/kg}$ and specific heat of cold water at the average temperature of 22.5°C is given to be $c_p = 4180 \text{ J/kg}\cdot^\circ\text{C}$.

Analysis The temperature differences between the steam and the cooling water at the two ends of the condenser are

$$\Delta T_1 = T_{h,in} - T_{c,out} = 50^\circ\text{C} - 27^\circ\text{C} = 23^\circ\text{C}$$

$$\Delta T_2 = T_{h,out} - T_{c,in} = 50^\circ\text{C} - 18^\circ\text{C} = 32^\circ\text{C}$$

and

$$\Delta T_{lm} = \frac{\Delta T_1 - \Delta T_2}{\ln(\Delta T_1 / \Delta T_2)} = \frac{23 - 32}{\ln(23 / 32)} = 27.3^\circ\text{C}$$

Then the heat transfer rate in the condenser becomes

$$\dot{Q} = UA_s \Delta T_{lm} = (2400 \text{ W/m}^2 \cdot ^\circ\text{C})(42 \text{ m}^2)(27.3^\circ\text{C}) = 2752 \text{ kW}$$

The mass flow rate of the cooling water and the rate of condensation of steam are determined from

$$\dot{Q} = [\dot{m}c_p(T_{out} - T_{in})]_{\text{cooling water}}$$

$$\dot{m}_{\text{cooling water}} = \frac{\dot{Q}}{c_p(T_{out} - T_{in})} = \frac{2752 \text{ kJ/s}}{(4.18 \text{ kJ/kg}\cdot^\circ\text{C})(27^\circ\text{C} - 18^\circ\text{C})} = \mathbf{73.1 \text{ kg/s}}$$

$$\dot{Q} = (\dot{m}h_{fg})_{\text{steam}} \longrightarrow \dot{m}_{\text{steam}} = \frac{\dot{Q}}{h_{fg}} = \frac{2752 \text{ kJ/s}}{2383 \text{ kJ/kg}} = \mathbf{1.15 \text{ kg/s}}$$

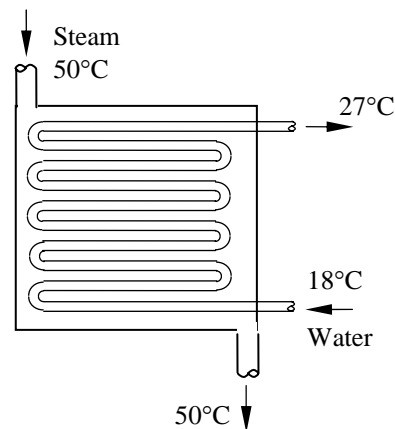

11-47 Water is heated in a double-pipe parallel-flow heat exchanger by geothermal water. The required length of tube is to be determined.

Assumptions 1 Steady operating conditions exist. 2 The heat exchanger is well-insulated so that heat loss to the surroundings is negligible and thus heat transfer from the hot fluid is equal to the heat transfer to the cold fluid. 3 Changes in the kinetic and potential energies of fluid streams are negligible. 4 There is no fouling. 5 Fluid properties are constant.

Properties The specific heats of water and geothermal fluid are given to be 4.18 and 4.31 kJ/kg·°C, respectively.

Analysis The rate of heat transfer in the heat exchanger is

$$\dot{Q} = [\dot{m}c_p(T_{out} - T_{in})]_{\text{water}} = (0.2 \text{ kg/s})(4.18 \text{ kJ/kg}\cdot\text{°C})(60\text{°C} - 25\text{°C}) = 29.26 \text{ kW}$$

Then the outlet temperature of the geothermal water is determined from

$$\dot{Q} = [\dot{m}c_p(T_{in} - T_{out})]_{\text{geot. water}} \longrightarrow T_{out} = T_{in} - \frac{\dot{Q}}{\dot{m}c_p} = 140\text{°C} - \frac{29.26 \text{ kW}}{(0.3 \text{ kg/s})(4.31 \text{ kJ/kg}\cdot\text{°C})} = 117.4\text{°C}$$

The logarithmic mean temperature difference is

$$\Delta T_1 = T_{h,in} - T_{c,in} = 140\text{°C} - 25\text{°C} = 115\text{°C}$$

$$\Delta T_2 = T_{h,out} - T_{c,out} = 117.4\text{°C} - 60\text{°C} = 57.4\text{°C}$$

and

$$\Delta T_{lm} = \frac{\Delta T_1 - \Delta T_2}{\ln(\Delta T_1 / \Delta T_2)} = \frac{115 - 57.4}{\ln(115 / 57.4)} = 82.9\text{°C}$$

The surface area of the heat exchanger is determined from

$$\dot{Q} = UA_s \Delta T_{lm} \longrightarrow A_s = \frac{\dot{Q}}{U \Delta T_{lm}} = \frac{29.26 \text{ kW}}{(0.55 \text{ kW/m}^2)(82.9\text{°C})} = 0.642 \text{ m}^2$$

Then the length of the tube required becomes

$$A_s = \pi DL \longrightarrow L = \frac{A_s}{\pi D} = \frac{0.642 \text{ m}^2}{\pi(0.008 \text{ m})} = \mathbf{25.5 \text{ m}}$$

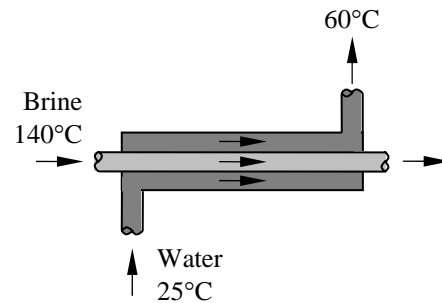

11-48 EES Prob. 11-47 is reconsidered. The effects of temperature and mass flow rate of geothermal water on the length of the tube are to be investigated.

Analysis The problem is solved using EES, and the solution is given below.

"GIVEN"

T_w_in=25 [C]
 T_w_out=60 [C]
 m_dot_w=0.2 [kg/s]
 C_p_w=4.18 [kJ/kg-C]
 T_geo_in=140 [C]
 m_dot_geo=0.3 [kg/s]
 C_p_geo=4.31 [kJ/kg-C]
 D=0.008 [m]
 U=0.55 [kW/m^2-C]

"ANALYSIS"

Q_dot=m_dot_w*C_p_w*(T_w_out-T_w_in)
 Q_dot=m_dot_geo*C_p_geo*(T_geo_in-T_geo_out)
 DELTAT_1=T_geo_in-T_w_in
 DELTAT_2=T_geo_out-T_w_out
 DELTAT_lm=(DELTAT_1-DELTAT_2)/ln(DELTAT_1/DELTAT_2)
 Q_dot=U*A*DELTAT_lm
 A=pi*D*L

T _{geo,in} [C]	L [m]
100	53.73
105	46.81
110	41.62
115	37.56
120	34.27
125	31.54
130	29.24
135	27.26
140	25.54
145	24.04
150	22.7
155	21.51
160	20.45
165	19.48
170	18.61
175	17.81
180	17.08
185	16.4
190	15.78
195	15.21
200	14.67

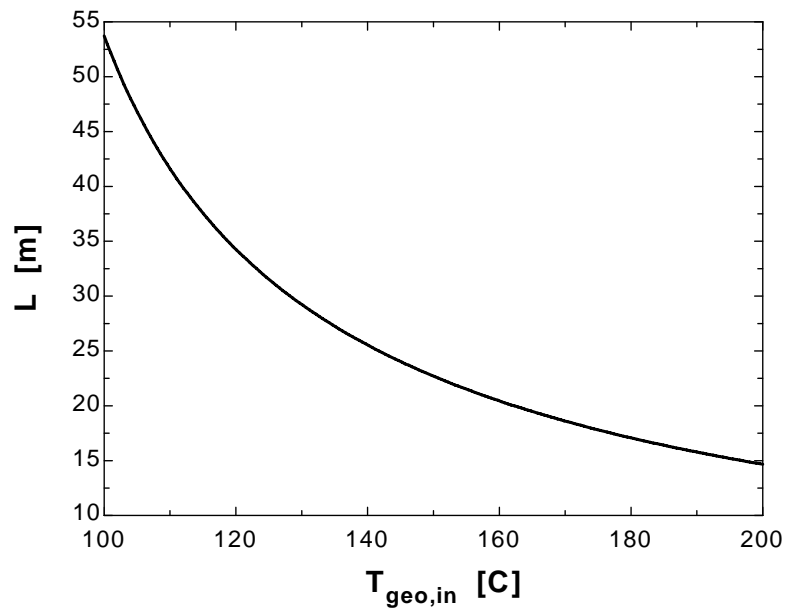

\dot{m}_{geo} [kg/s]	L [m]
0.1	46.31
0.125	35.52
0.15	31.57
0.175	29.44
0.2	28.1
0.225	27.16
0.25	26.48
0.275	25.96
0.3	25.54
0.325	25.21
0.35	24.93
0.375	24.69
0.4	24.49
0.425	24.32
0.45	24.17
0.475	24.04
0.5	23.92

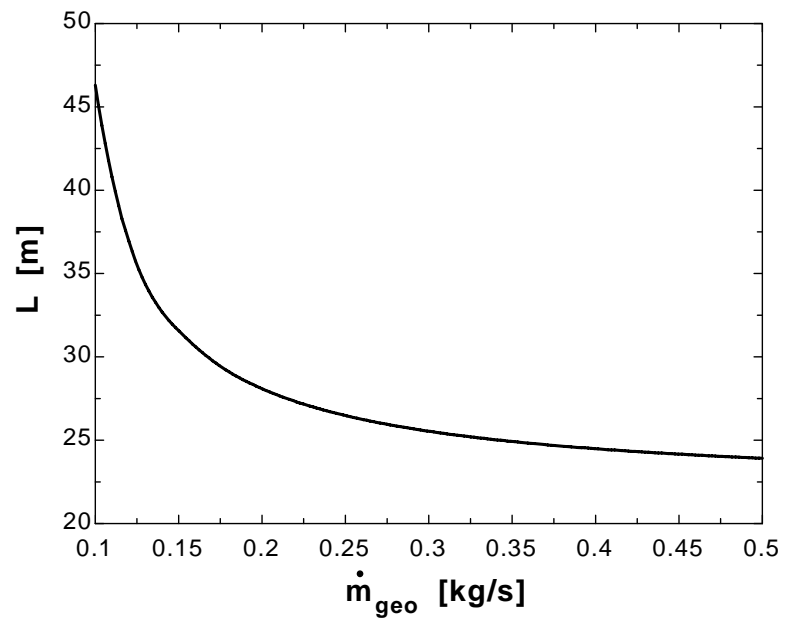

11-49E Glycerin is heated by hot water in a 1-shell pass and 8-tube passes heat exchanger. The rate of heat transfer for the cases of fouling and no fouling are to be determined.

Assumptions 1 Steady operating conditions exist. 2 The heat exchanger is well-insulated so that heat loss to the surroundings is negligible and thus heat transfer from the hot fluid is equal to the heat transfer to the cold fluid. 3 Changes in the kinetic and potential energies of fluid streams are negligible. 4 Heat transfer coefficients and fouling factors are constant and uniform. 5 The thermal resistance of the inner tube is negligible since the tube is thin-walled and highly conductive.

Properties The specific heats of glycerin and water are given to be 0.60 and 1.0 Btu/lbm·°F, respectively.

Analysis (a) The tubes are thin walled and thus we assume the inner surface area of the tube to be equal to the outer surface area. Then the heat transfer surface area of this heat exchanger becomes

$$A_s = n\pi DL = 8\pi(0.5/12 \text{ ft})(500 \text{ ft}) = 523.6 \text{ ft}^2$$

The temperature differences at the two ends of the heat exchanger are

$$\Delta T_1 = T_{h,in} - T_{c,out} = 175^\circ\text{F} - 140^\circ\text{F} = 35^\circ\text{F}$$

$$\Delta T_2 = T_{h,out} - T_{c,in} = 120^\circ\text{F} - 65^\circ\text{F} = 55^\circ\text{F}$$

and $\Delta T_{lm,CF} = \frac{\Delta T_1 - \Delta T_2}{\ln(\Delta T_1 / \Delta T_2)} = \frac{35 - 55}{\ln(35 / 55)} = 44.25^\circ\text{F}$

The correction factor is

$$\left. \begin{aligned} P &= \frac{t_2 - t_1}{T_1 - t_1} = \frac{120 - 175}{65 - 175} = 0.5 \\ R &= \frac{T_1 - T_2}{t_2 - t_1} = \frac{65 - 140}{120 - 175} = 1.36 \end{aligned} \right\} F = 0.70$$

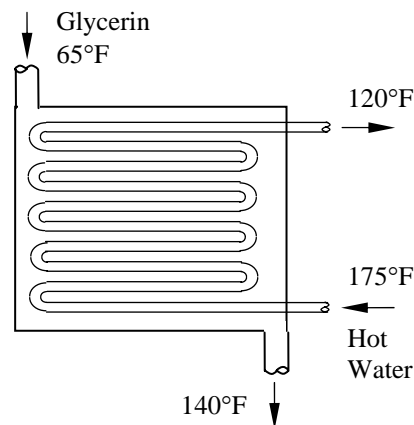

In case of no fouling, the overall heat transfer coefficient is determined from

$$U = \frac{1}{\frac{1}{h_i} + \frac{1}{h_o}} = \frac{1}{\frac{1}{50 \text{ Btu/h}\cdot\text{ft}^2\cdot^\circ\text{F}} + \frac{1}{4 \text{ Btu/h}\cdot\text{ft}^2\cdot^\circ\text{F}}} = 3.7 \text{ Btu/h}\cdot\text{ft}^2\cdot^\circ\text{F}$$

Then the rate of heat transfer becomes

$$\dot{Q} = UA_s F \Delta T_{lm,CF} = (3.7 \text{ Btu/h}\cdot\text{ft}^2\cdot^\circ\text{F})(523.6 \text{ ft}^2)(0.70)(44.25^\circ\text{F}) = \mathbf{60,000 \text{ Btu/h}}$$

(b) The thermal resistance of the heat exchanger with a fouling factor is

$$\begin{aligned} R &= \frac{1}{h_i A_i} + \frac{R_{fi}}{A_i} + \frac{1}{h_o A_o} \\ &= \frac{1}{(50 \text{ Btu/h}\cdot\text{ft}^2\cdot^\circ\text{F})(523.6 \text{ ft}^2)} + \frac{0.002 \text{ h}\cdot\text{ft}^2\cdot^\circ\text{F/Btu}}{523.6 \text{ ft}^2} + \frac{1}{(4 \text{ Btu/h}\cdot\text{ft}^2\cdot^\circ\text{F})(523.6 \text{ ft}^2)} \\ &= 0.0005195 \text{ h}\cdot^\circ\text{F/Btu} \end{aligned}$$

The overall heat transfer coefficient in this case is

$$R = \frac{1}{UA_s} \rightarrow U = \frac{1}{RA_s} = \frac{1}{(0.0005195 \text{ h}\cdot^\circ\text{F/Btu})(523.6 \text{ ft}^2)} = 3.68 \text{ Btu/h}\cdot\text{ft}^2\cdot^\circ\text{F}$$

Then rate of heat transfer becomes

$$\dot{Q} = UA_s F \Delta T_{lm,CF} = (3.68 \text{ Btu/h}\cdot\text{ft}^2\cdot^\circ\text{F})(523.6 \text{ ft}^2)(0.70)(44.25^\circ\text{F}) = \mathbf{59,680 \text{ Btu/h}}$$

11-50 During an experiment, the inlet and exit temperatures of water and oil and the mass flow rate of water are measured. The overall heat transfer coefficient based on the inner surface area is to be determined.

Assumptions 1 Steady operating conditions exist. 2 The heat exchanger is well-insulated so that heat loss to the surroundings is negligible and thus heat transfer from the hot fluid is equal to the heat transfer to the cold fluid. 3 Changes in the kinetic and potential energies of fluid streams are negligible. 4 Fluid properties are constant.

Properties The specific heats of water and oil are given to be 4180 and 2150 J/kg·°C, respectively.

Analysis The rate of heat transfer from the oil to the water is

$$\dot{Q} = [\dot{m}c_p(T_{out} - T_{in})]_{\text{water}} = (3 \text{ kg/s})(4.18 \text{ kJ/kg}\cdot\text{°C})(55\text{°C} - 20\text{°C}) = 438.9 \text{ kW}$$

The heat transfer area on the tube side is

$$A_i = n\pi D_i L = 24\pi(0.012 \text{ m})(2 \text{ m}) = 1.8 \text{ m}^2$$

The logarithmic mean temperature difference for counter-flow arrangement and the correction factor F are

$$\Delta T_1 = T_{h,in} - T_{c,out} = 120\text{°C} - 55\text{°C} = 65\text{°C}$$

$$\Delta T_2 = T_{h,out} - T_{c,in} = 45\text{°C} - 20\text{°C} = 25\text{°C}$$

$$\Delta T_{lm,CF} = \frac{\Delta T_1 - \Delta T_2}{\ln(\Delta T_1 / \Delta T_2)} = \frac{65 - 25}{\ln(65 / 25)} = 41.9\text{°C}$$

$$\left. \begin{aligned} P &= \frac{t_2 - t_1}{T_1 - t_1} = \frac{55 - 20}{120 - 20} = 0.35 \\ R &= \frac{T_1 - T_2}{t_2 - t_1} = \frac{120 - 45}{55 - 20} = 2.14 \end{aligned} \right\} F = 0.70$$

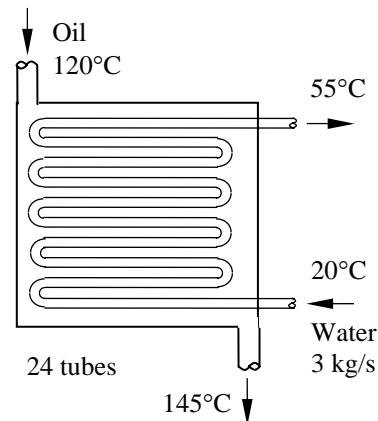

Then the overall heat transfer coefficient becomes

$$\dot{Q} = U_i A_i F \Delta T_{lm,CF} \longrightarrow U_i = \frac{\dot{Q}}{A_i F \Delta T_{lm,CF}} = \frac{438.9 \text{ kW}}{(1.8 \text{ m}^2)(0.70)(41.9\text{°C})} = \mathbf{8.31 \text{ kW/m}^2 \cdot \text{°C}}$$

11-51 Ethylene glycol is cooled by water in a double-pipe counter-flow heat exchanger. The rate of heat transfer, the mass flow rate of water, and the heat transfer surface area on the inner side of the tubes are to be determined.

Assumptions 1 Steady operating conditions exist. 2 The heat exchanger is well-insulated so that heat loss to the surroundings is negligible and thus heat transfer from the hot fluid is equal to the heat transfer to the cold fluid. 3 Changes in the kinetic and potential energies of fluid streams are negligible. 4 There is no fouling. 5 Fluid properties are constant.

Properties The specific heats of water and ethylene glycol are given to be 4.18 and 2.56 kJ/kg·°C, respectively.

Analysis (a) The rate of heat transfer is

$$\begin{aligned}\dot{Q} &= [\dot{m}c_p(T_{in} - T_{out})]_{\text{glycol}} \\ &= (3.5 \text{ kg/s})(2.56 \text{ kJ/kg}\cdot\text{°C})(80\text{°C} - 40\text{°C}) \\ &= \mathbf{358.4 \text{ kW}}\end{aligned}$$

(b) The rate of heat transfer from water must be equal to the rate of heat transfer to the glycol. Then,

$$\begin{aligned}\dot{Q} &= [\dot{m}c_p(T_{out} - T_{in})]_{\text{water}} \longrightarrow \dot{m}_{\text{water}} = \frac{\dot{Q}}{c_p(T_{out} - T_{in})} \\ &= \frac{358.4 \text{ kJ/s}}{(4.18 \text{ kJ/kg}\cdot\text{°C})(55\text{°C} - 20\text{°C})} = \mathbf{2.45 \text{ kg/s}}\end{aligned}$$

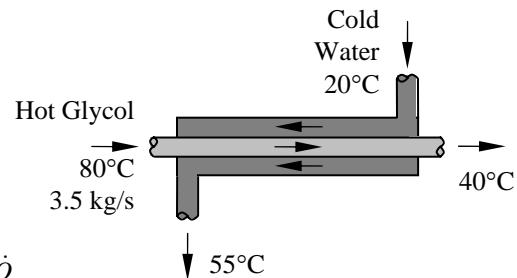

(c) The temperature differences at the two ends of the heat exchanger are

$$\Delta T_1 = T_{h,in} - T_{c,out} = 80\text{°C} - 55\text{°C} = 25\text{°C}$$

$$\Delta T_2 = T_{h,out} - T_{c,in} = 40\text{°C} - 20\text{°C} = 20\text{°C}$$

and

$$\Delta T_{lm} = \frac{\Delta T_1 - \Delta T_2}{\ln(\Delta T_1 / \Delta T_2)} = \frac{25 - 20}{\ln(25 / 20)} = 22.4\text{°C}$$

Then the heat transfer surface area becomes

$$\dot{Q} = U_i A_i \Delta T_{lm} \longrightarrow A_i = \frac{\dot{Q}}{U_i \Delta T_{lm}} = \frac{358.4 \text{ kW}}{(0.25 \text{ kW/m}^2\cdot\text{°C})(22.4\text{°C})} = \mathbf{64.0 \text{ m}^2}$$

11-52 Water is heated by steam in a double-pipe counter-flow heat exchanger. The required length of the tubes is to be determined.

Assumptions 1 Steady operating conditions exist. 2 The heat exchanger is well-insulated so that heat loss to the surroundings is negligible and thus heat transfer from the hot fluid is equal to the heat transfer to the cold fluid. 3 Changes in the kinetic and potential energies of fluid streams are negligible. 4 There is no fouling. 5 Fluid properties are constant.

Properties The specific heat of water is given to be 4.18 kJ/kg·°C. The heat of condensation of steam at 120°C is given to be 2203 kJ/kg.

Analysis The rate of heat transfer is

$$\begin{aligned}\dot{Q} &= [\dot{m}c_p(T_{out} - T_{in})]_{\text{water}} \\ &= (3 \text{ kg/s})(4.18 \text{ kJ/kg}\cdot\text{°C})(80^\circ\text{C} - 17^\circ\text{C}) \\ &= 790.02 \text{ kW}\end{aligned}$$

The logarithmic mean temperature difference is

$$\begin{aligned}\Delta T_1 &= T_{h,in} - T_{c,out} = 120^\circ\text{C} - 80^\circ\text{C} = 40^\circ\text{C} \\ \Delta T_2 &= T_{h,in} - T_{c,in} = 120^\circ\text{C} - 17^\circ\text{C} = 103^\circ\text{C} \\ \Delta T_{lm} &= \frac{\Delta T_1 - \Delta T_2}{\ln(\Delta T_1 / \Delta T_2)} = \frac{40 - 103}{\ln(40 / 103)} = 66.6^\circ\text{C}\end{aligned}$$

The heat transfer surface area is

$$\dot{Q} = U_i A_i \Delta T_{lm} \longrightarrow A_i = \frac{\dot{Q}}{U_i \Delta T_{lm}} = \frac{790.02 \text{ kW}}{(1.5 \text{ kW/m}^2\cdot\text{°C})(66.6^\circ\text{C})} = 7.9 \text{ m}^2$$

Then the length of tube required becomes

$$A_i = \pi D_i L \longrightarrow L = \frac{A_i}{\pi D_i} = \frac{7.9 \text{ m}^2}{\pi(0.025 \text{ m})} = \mathbf{100.6 \text{ m}}$$

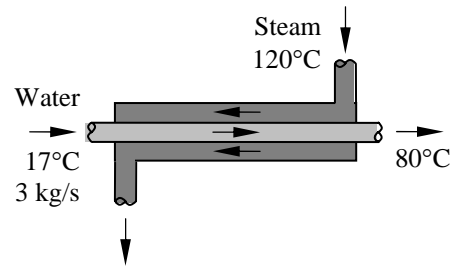

11-53 Oil is cooled by water in a thin-walled double-pipe counter-flow heat exchanger. The overall heat transfer coefficient of the heat exchanger is to be determined.

Assumptions 1 Steady operating conditions exist. 2 The heat exchanger is well-insulated so that heat loss to the surroundings is negligible and thus heat transfer from the hot fluid is equal to the heat transfer to the cold fluid. 3 Changes in the kinetic and potential energies of fluid streams are negligible. 4 There is no fouling. 5 Fluid properties are constant. 6 The thermal resistance of the inner tube is negligible since the tube is thin-walled and highly conductive.

Properties The specific heats of water and oil are given to be 4.18 and 2.20 kJ/kg·°C, respectively.

Analysis The rate of heat transfer from the water to the oil is

$$\begin{aligned}\dot{Q} &= [\dot{m}c_p(T_{in} - T_{out})]_{oil} \\ &= (2 \text{ kg/s})(2.2 \text{ kJ/kg}\cdot\text{°C})(150\text{°C} - 40\text{°C}) \\ &= 484 \text{ kW}\end{aligned}$$

The outlet temperature of the water is determined from

$$\begin{aligned}\dot{Q} &= [\dot{m}c_p(T_{out} - T_{in})]_{water} \longrightarrow T_{out} = T_{in} + \frac{\dot{Q}}{\dot{m}c_p} \\ &= 22\text{°C} + \frac{484 \text{ kW}}{(1.5 \text{ kg/s})(4.18 \text{ kJ/kg}\cdot\text{°C})} = 99.2\text{°C}\end{aligned}$$

The logarithmic mean temperature difference is

$$\begin{aligned}\Delta T_1 &= T_{h,in} - T_{c,out} = 150\text{°C} - 99.2\text{°C} = 50.8\text{°C} \\ \Delta T_2 &= T_{h,out} - T_{c,in} = 40\text{°C} - 22\text{°C} = 18\text{°C} \\ \Delta T_{lm} &= \frac{\Delta T_1 - \Delta T_2}{\ln(\Delta T_1 / \Delta T_2)} = \frac{50.8 - 18}{\ln(50.8 / 18)} = 31.6\text{°C}\end{aligned}$$

Then the overall heat transfer coefficient becomes

$$U = \frac{\dot{Q}}{A_s \Delta T_{lm}} = \frac{484 \text{ kW}}{\pi(0.025 \text{ m})(6 \text{ m})(31.6\text{°C})} = \mathbf{32.5 \text{ kW/m}^2 \cdot \text{°C}}$$

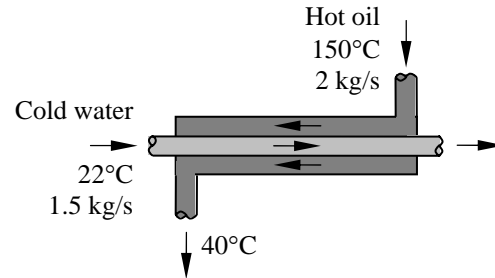

11-54 EES Prob. 11-53 is reconsidered. The effects of oil exit temperature and water inlet temperature on the overall heat transfer coefficient of the heat exchanger are to be investigated.

Analysis The problem is solved using EES, and the solution is given below.

"GIVEN"

T_oil_in=150 [C]
 T_oil_out=40 [C]
 m_dot_oil=2 [kg/s]
 C_p_oil=2.20 [kJ/kg-C]
 T_w_in=22 [C]
 m_dot_w=1.5 [kg/s]
 C_p_w=4.18 [kJ/kg-C]
 D=0.025 [m]
 L=6 [m]

"ANALYSIS"

Q_dot=m_dot_oil*C_p_oil*(T_oil_in-T_oil_out)
 Q_dot=m_dot_w*C_p_w*(T_w_out-T_w_in)
 DELTAT_1=T_oil_in-T_w_out
 DELTAT_2=T_oil_out-T_w_in
 DELTAT_lm=(DELTAT_1-DELTAT_2)/ln(DELTAT_1/DELTAT_2)
 Q_dot=U*A*DELTAT_lm
 A=pi*D*L

T _{oil,out} [C]	U [kW/m ² -C]
30	53.22
32.5	45.94
35	40.43
37.5	36.07
40	32.49
42.5	29.48
45	26.9
47.5	24.67
50	22.7
52.5	20.96
55	19.4
57.5	18
60	16.73
62.5	15.57
65	14.51
67.5	13.53
70	12.63

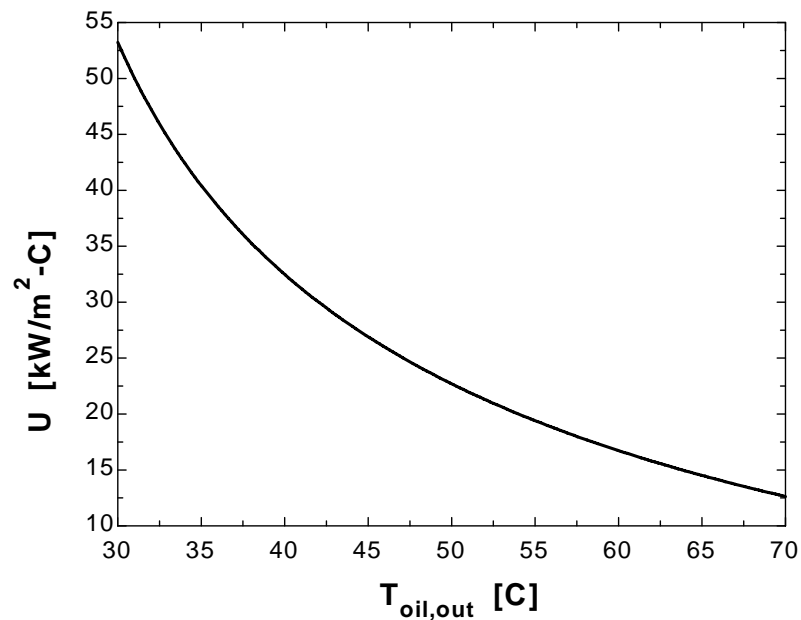

$T_{w,in}$ [C]	U [kW/m ² - C]
5	20.7
6	21.15
7	21.61
8	22.09
9	22.6
10	23.13
11	23.69
12	24.28
13	24.9
14	25.55
15	26.24
16	26.97
17	27.75
18	28.58
19	29.46
20	30.4
21	31.4
22	32.49
23	33.65
24	34.92
25	36.29

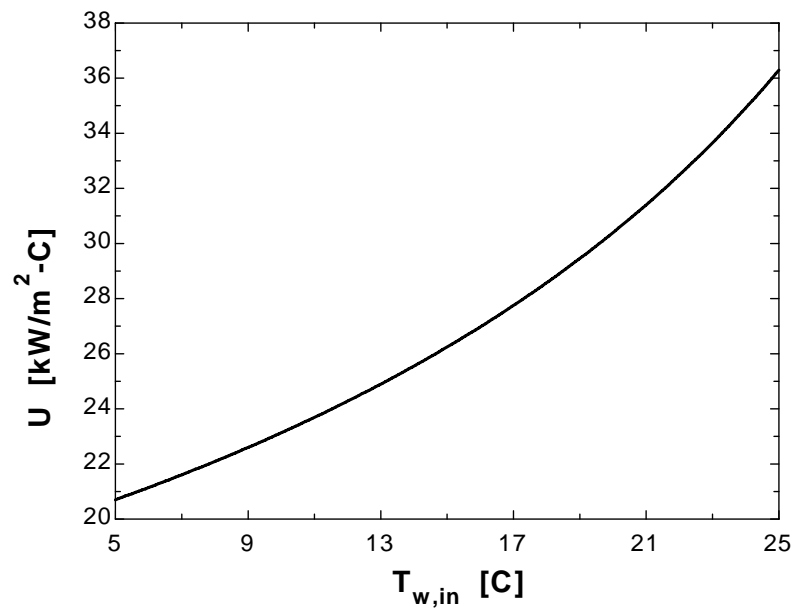

11-55 The inlet and outlet temperatures of the cold and hot fluids in a double-pipe heat exchanger are given. It is to be determined whether this is a parallel-flow or counter-flow heat exchanger.

Analysis In parallel-flow heat exchangers, the temperature of the cold water can never exceed that of the hot fluid. In this case $T_{\text{cold out}} = 50^\circ\text{C}$ which is greater than $T_{\text{hot out}} = 45^\circ\text{C}$. Therefore this must be a counter-flow heat exchanger.

11-56 Cold water is heated by hot water in a double-pipe counter-flow heat exchanger. The rate of heat transfer and the heat transfer surface area of the heat exchanger are to be determined.

Assumptions 1 Steady operating conditions exist. 2 The heat exchanger is well-insulated so that heat loss to the surroundings is negligible and thus heat transfer from the hot fluid is equal to the heat transfer to the cold fluid. 3 Changes in the kinetic and potential energies of fluid streams are negligible. 4 There is no fouling. 5 Fluid properties are constant. 6 The thermal resistance of the inner tube is negligible since the tube is thin-walled and highly conductive.

Properties The specific heats of cold and hot water are given to be 4.18 and 4.19 kJ/kg·°C, respectively.

Analysis The rate of heat transfer in this heat exchanger is

$$\begin{aligned}\dot{Q} &= [\dot{m}c_p(T_{\text{out}} - T_{\text{in}})]_{\text{cold water}} \\ &= (1.25 \text{ kg/s})(4.18 \text{ kJ/kg}\cdot^\circ\text{C})(45^\circ\text{C} - 15^\circ\text{C}) \\ &= \mathbf{156.8 \text{ kW}}\end{aligned}$$

The outlet temperature of the hot water is determined from

$$\dot{Q} = [\dot{m}c_p(T_{\text{in}} - T_{\text{out}})]_{\text{hot water}} \longrightarrow T_{\text{out}} = T_{\text{in}} - \frac{\dot{Q}}{\dot{m}c_p} = 100^\circ\text{C} - \frac{156.8 \text{ kW}}{(3 \text{ kg/s})(4.19 \text{ kJ/kg}\cdot^\circ\text{C})} = 87.5^\circ\text{C}$$

The temperature differences at the two ends of the heat exchanger are

$$\begin{aligned}\Delta T_1 &= T_{h,\text{in}} - T_{c,\text{out}} = 100^\circ\text{C} - 45^\circ\text{C} = 55^\circ\text{C} \\ \Delta T_2 &= T_{h,\text{out}} - T_{c,\text{in}} = 87.5^\circ\text{C} - 15^\circ\text{C} = 72.5^\circ\text{C}\end{aligned}$$

and

$$\Delta T_{\text{lm}} = \frac{\Delta T_1 - \Delta T_2}{\ln(\Delta T_1 / \Delta T_2)} = \frac{55 - 72.5}{\ln(55 / 72.5)} = 63.3^\circ\text{C}$$

Then the surface area of this heat exchanger becomes

$$\dot{Q} = UA_s\Delta T_{\text{lm}} \longrightarrow A_s = \frac{\dot{Q}}{U\Delta T_{\text{lm}}} = \frac{156.8 \text{ kW}}{(0.880 \text{ kW/m}^2\cdot^\circ\text{C})(63.3^\circ\text{C})} = \mathbf{2.81 \text{ m}^2}$$

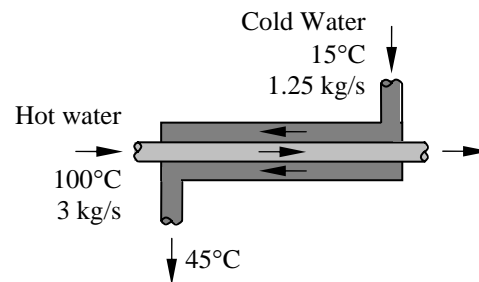

11-57 Engine oil is heated by condensing steam in a condenser. The rate of heat transfer and the length of the tube required are to be determined.

Assumptions 1 Steady operating conditions exist. 2 The heat exchanger is well-insulated so that heat loss to the surroundings is negligible and thus heat transfer from the hot fluid is equal to the heat transfer to the cold fluid. 3 Changes in the kinetic and potential energies of fluid streams are negligible. 4 There is no fouling. 5 Fluid properties are constant. 6 The thermal resistance of the inner tube is negligible since the tube is thin-walled and highly conductive.

Properties The specific heat of engine oil is given to be 2.1 kJ/kg·°C. The heat of condensation of steam at 130°C is given to be 2174 kJ/kg.

Analysis The rate of heat transfer in this heat exchanger is

$$\dot{Q} = [\dot{m}c_p(T_{out} - T_{in})]_{oil} = (0.3 \text{ kg/s})(2.1 \text{ kJ/kg}\cdot\text{°C})(60\text{°C} - 20\text{°C}) = \mathbf{25.2 \text{ kW}}$$

The temperature differences at the two ends of the heat exchanger are

$$\Delta T_1 = T_{h,in} - T_{c,out} = 130\text{°C} - 60\text{°C} = 70\text{°C}$$

$$\Delta T_2 = T_{h,out} - T_{c,in} = 130\text{°C} - 20\text{°C} = 110\text{°C}$$

and

$$\Delta T_{lm} = \frac{\Delta T_1 - \Delta T_2}{\ln(\Delta T_1 / \Delta T_2)} = \frac{70 - 110}{\ln(70 / 110)} = 88.5\text{°C}$$

The surface area is

$$A_s = \frac{\dot{Q}}{U\Delta T_{lm}} = \frac{25.2 \text{ kW}}{(0.65 \text{ kW/m}^2\cdot\text{°C})(88.5\text{°C})} = 0.44 \text{ m}^2$$

Then the length of the tube required becomes

$$A_s = \pi DL \longrightarrow L = \frac{A_s}{\pi D} = \frac{0.44 \text{ m}^2}{\pi(0.02 \text{ m})} = \mathbf{7.0 \text{ m}}$$

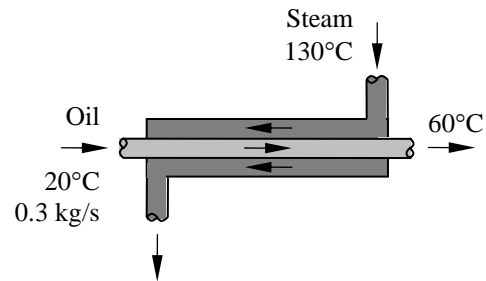

11-58E Water is heated by geothermal water in a double-pipe counter-flow heat exchanger. The mass flow rate of each fluid and the total thermal resistance of the heat exchanger are to be determined.

Assumptions 1 Steady operating conditions exist. 2 The heat exchanger is well-insulated so that heat loss to the surroundings is negligible and thus heat transfer from the hot fluid is equal to the heat transfer to the cold fluid. 3 Changes in the kinetic and potential energies of fluid streams are negligible. 4 There is no fouling. 5 Fluid properties are constant.

Properties The specific heats of water and geothermal fluid are given to be 1.0 and 1.03 Btu/lbm.°F, respectively.

Analysis The mass flow rate of each fluid is determined from

$$\dot{Q} = [\dot{m}c_p(T_{out} - T_{in})]_{\text{water}}$$

$$\dot{m}_{\text{water}} = \frac{\dot{Q}}{c_p(T_{out} - T_{in})} = \frac{40 \text{ Btu/s}}{(1.0 \text{ Btu/lbm.}^\circ\text{F})(200^\circ\text{F} - 140^\circ\text{F})} = \mathbf{0.667 \text{ lbm/s}}$$

$$\dot{Q} = [\dot{m}c_p(T_{out} - T_{in})]_{\text{geo. water}}$$

$$\dot{m}_{\text{geo. water}} = \frac{\dot{Q}}{c_p(T_{out} - T_{in})} = \frac{40 \text{ Btu/s}}{(1.03 \text{ Btu/lbm.}^\circ\text{F})(270^\circ\text{F} - 180^\circ\text{F})} = \mathbf{0.431 \text{ lbm/s}}$$

The temperature differences at the two ends of the heat exchanger are

$$\Delta T_1 = T_{h,in} - T_{c,out} = 270^\circ\text{F} - 200^\circ\text{F} = 70^\circ\text{F}$$

$$\Delta T_2 = T_{h,out} - T_{c,in} = 180^\circ\text{F} - 140^\circ\text{F} = 40^\circ\text{F}$$

and

$$\Delta T_{lm} = \frac{\Delta T_1 - \Delta T_2}{\ln(\Delta T_1 / \Delta T_2)} = \frac{70 - 40}{\ln(70 / 40)} = 53.61^\circ\text{F}$$

Then

$$\dot{Q} = UA_s \Delta T_{lm} \longrightarrow UA_s = \frac{\dot{Q}}{\Delta T_{lm}} = \frac{40 \text{ Btu/s}}{53.61^\circ\text{F}} = 0.7462 \text{ Btu/s.}^\circ\text{F}$$

$$U = \frac{1}{RA_s} \longrightarrow R = \frac{1}{UA_s} = \frac{1}{0.7462 \text{ Btu/s.}^\circ\text{F}} = \mathbf{1.34 \text{ s.}^\circ\text{F/Btu}}$$

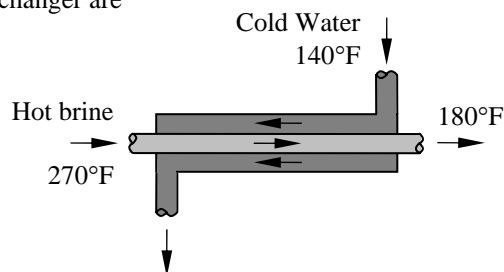

11-59 Glycerin is heated by ethylene glycol in a thin-walled double-pipe parallel-flow heat exchanger. The rate of heat transfer, the outlet temperature of the glycerin, and the mass flow rate of the ethylene glycol are to be determined.

Assumptions 1 Steady operating conditions exist. 2 The heat exchanger is well-insulated so that heat loss to the surroundings is negligible and thus heat transfer from the hot fluid is equal to the heat transfer to the cold fluid. 3 Changes in the kinetic and potential energies of fluid streams are negligible. 4 There is no fouling. 5 Fluid properties are constant. 6 The thermal resistance of the inner tube is negligible since the tube is thin-walled and highly conductive.

Properties The specific heats of glycerin and ethylene glycol are given to be 2.4 and 2.5 kJ/kg·°C, respectively.

Analysis (a) The temperature differences at the two ends are

$$\Delta T_1 = T_{h,in} - T_{c,in} = 60^\circ\text{C} - 20^\circ\text{C} = 40^\circ\text{C}$$

$$\Delta T_2 = T_{h,out} - T_{c,out} = T_{h,out} - (T_{h,out} - 15^\circ\text{C}) = 15^\circ\text{C}$$

$$\text{and } \Delta T_{lm} = \frac{\Delta T_1 - \Delta T_2}{\ln(\Delta T_1 / \Delta T_2)} = \frac{40 - 15}{\ln(40/15)} = 25.5^\circ\text{C}$$

Then the rate of heat transfer becomes

$$\dot{Q} = UA_s \Delta T_{lm} = (240 \text{ W/m}^2 \cdot ^\circ\text{C})(3.2 \text{ m}^2)(25.5^\circ\text{C}) = 19,584 \text{ W} = \mathbf{19.58 \text{ kW}}$$

(b) The outlet temperature of the glycerin is determined from

$$\dot{Q} = [\dot{m}c_p(T_{out} - T_{in})]_{\text{glycerin}} \longrightarrow T_{out} = T_{in} + \frac{\dot{Q}}{\dot{m}c_p} = 20^\circ\text{C} + \frac{19.584 \text{ kW}}{(0.3 \text{ kg/s})(2.4 \text{ kJ/kg} \cdot ^\circ\text{C})} = \mathbf{47.2^\circ\text{C}}$$

(c) Then the mass flow rate of ethylene glycol becomes

$$\dot{Q} = [\dot{m}c_p(T_{in} - T_{out})]_{\text{ethylene glycol}}$$

$$\dot{m}_{\text{ethylene glycol}} = \frac{\dot{Q}}{c_p(T_{in} - T_{out})} = \frac{19.584 \text{ kJ/s}}{(2.5 \text{ kJ/kg} \cdot ^\circ\text{C})[(47.2 + 15)^\circ\text{C} - 60^\circ\text{C}]} = \mathbf{3.56 \text{ kg/s}}$$

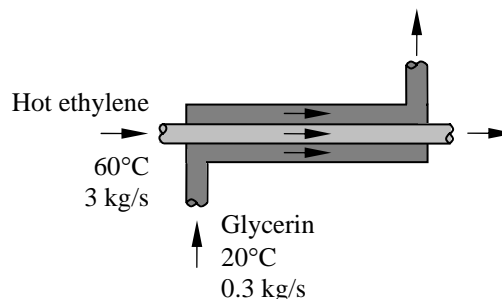

11-60 Air is preheated by hot exhaust gases in a cross-flow heat exchanger. The rate of heat transfer and the outlet temperature of the air are to be determined.

Assumptions 1 Steady operating conditions exist. 2 The heat exchanger is well-insulated so that heat loss to the surroundings is negligible and thus heat transfer from the hot fluid is equal to the heat transfer to the cold fluid. 3 Changes in the kinetic and potential energies of fluid streams are negligible. 4 There is no fouling. 5 Fluid properties are constant.

Properties The specific heats of air and combustion gases are given to be 1005 and 1100 J/kg·°C, respectively.

Analysis The rate of heat transfer is

$$\dot{Q} = [\dot{m}c_p(T_{in} - T_{out})]_{\text{gas}}$$

$$= (1.1 \text{ kg/s})(1.1 \text{ kJ/kg} \cdot ^\circ\text{C})(180^\circ\text{C} - 95^\circ\text{C})$$

$$= \mathbf{103 \text{ kW}}$$

The mass flow rate of air is

$$\dot{m} = \frac{P\dot{V}}{RT} = \frac{(95 \text{ kPa})(0.8 \text{ m}^3/\text{s})}{(0.287 \text{ kPa} \cdot \text{m}^3/\text{kg} \cdot \text{K}) \times 293 \text{ K}} = 0.904 \text{ kg/s}$$

Then the outlet temperature of the air becomes

$$\dot{Q} = \dot{m}c_p(T_{c,out} - T_{c,in}) \longrightarrow T_{c,out} = T_{c,in} + \frac{\dot{Q}}{\dot{m}c_p} = 20^\circ\text{C} + \frac{103 \times 10^3 \text{ W}}{(0.904 \text{ kg/s})(1005 \text{ J/kg} \cdot ^\circ\text{C})} = \mathbf{133^\circ\text{C}}$$

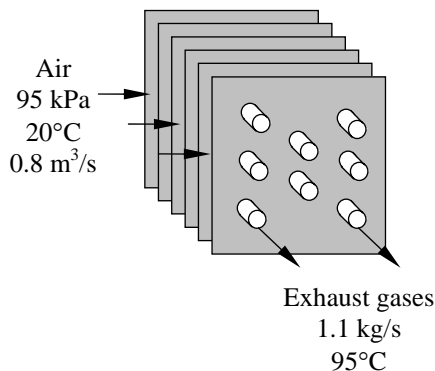

11-61 Water is heated by hot oil in a 2-shell passes and 12-tube passes heat exchanger. The heat transfer surface area on the tube side is to be determined.

Assumptions 1 Steady operating conditions exist. 2 The heat exchanger is well-insulated so that heat loss to the surroundings is negligible and thus heat transfer from the hot fluid is equal to the heat transfer to the cold fluid. 3 Changes in the kinetic and potential energies of fluid streams are negligible. 4 There is no fouling. 5 Fluid properties are constant.

Properties The specific heats of water and oil are given to be 4.18 and 2.3 kJ/kg·°C, respectively.

Analysis The rate of heat transfer in this heat exchanger is

$$\dot{Q} = [\dot{m}c_p(T_{out} - T_{in})]_{\text{water}} = (4.5 \text{ kg/s})(4.18 \text{ kJ/kg}\cdot^{\circ}\text{C})(70^{\circ}\text{C} - 20^{\circ}\text{C}) = 940.5 \text{ kW}$$

The outlet temperature of the oil is determined from

$$\dot{Q} = [\dot{m}c_p(T_{in} - T_{out})]_{\text{oil}} \longrightarrow T_{out} = T_{in} - \frac{\dot{Q}}{\dot{m}c_p} = 170^{\circ}\text{C} - \frac{940.5 \text{ kW}}{(10 \text{ kg/s})(2.3 \text{ kJ/kg}\cdot^{\circ}\text{C})} = 129^{\circ}\text{C}$$

The logarithmic mean temperature difference for counter-flow arrangement and the correction factor F are

$$\Delta T_1 = T_{h,in} - T_{c,out} = 170^{\circ}\text{C} - 70^{\circ}\text{C} = 100^{\circ}\text{C}$$

$$\Delta T_2 = T_{h,out} - T_{c,in} = 129^{\circ}\text{C} - 20^{\circ}\text{C} = 109^{\circ}\text{C}$$

$$\Delta T_{lm,CF} = \frac{\Delta T_1 - \Delta T_2}{\ln(\Delta T_1 / \Delta T_2)} = \frac{100 - 109}{\ln(100 / 109)} = 104.4^{\circ}\text{C}$$

$$\left. \begin{aligned} P &= \frac{t_2 - t_1}{T_1 - t_1} = \frac{70 - 20}{170 - 20} = 0.33 \\ R &= \frac{T_1 - T_2}{t_2 - t_1} = \frac{170 - 129}{70 - 20} = 0.82 \end{aligned} \right\} F = 1.0$$

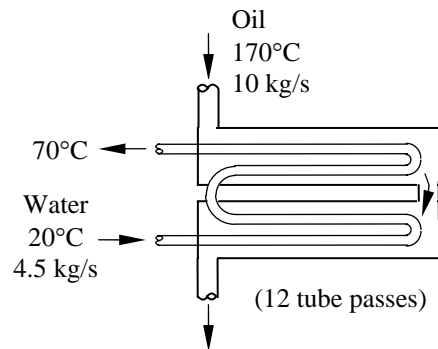

Then the heat transfer surface area on the tube side becomes

$$\dot{Q} = UA_s F \Delta T_{lm,CF} \longrightarrow A_s = \frac{\dot{Q}}{UF \Delta T_{lm,CF}} = \frac{940.5 \text{ kW}}{(0.350 \text{ kW/m}^2\cdot^{\circ}\text{C})(1.0)(104.4^{\circ}\text{C})} = \mathbf{25.7 \text{ m}^2}$$

11-62 Water is heated by hot oil in a 2-shell passes and 12-tube passes heat exchanger. The heat transfer surface area on the tube side is to be determined.

Assumptions **1** Steady operating conditions exist. **2** The heat exchanger is well-insulated so that heat loss to the surroundings is negligible and thus heat transfer from the hot fluid is equal to the heat transfer to the cold fluid. **3** Changes in the kinetic and potential energies of fluid streams are negligible. **4** There is no fouling. **5** Fluid properties are constant.

Properties The specific heats of water and oil are given to be 4.18 and 2.3 kJ/kg·°C, respectively.

Analysis The rate of heat transfer in this heat exchanger is

$$\dot{Q} = [\dot{m}c_p(T_{out} - T_{in})]_{\text{water}} = (2 \text{ kg/s})(4.18 \text{ kJ/kg}\cdot\text{°C})(70\text{°C} - 20\text{°C}) = 418 \text{ kW}$$

The outlet temperature of the oil is determined from

$$\dot{Q} = [\dot{m}c_p(T_{in} - T_{out})]_{\text{oil}} \longrightarrow T_{out} = T_{in} - \frac{\dot{Q}}{\dot{m}c_p} = 170\text{°C} - \frac{418 \text{ kW}}{(10 \text{ kg/s})(2.3 \text{ kJ/kg}\cdot\text{°C})} = 151.8\text{°C}$$

The logarithmic mean temperature difference for counter-flow arrangement and the correction factor F are

$$\Delta T_1 = T_{h,in} - T_{c,out} = 170\text{°C} - 70\text{°C} = 100\text{°C}$$

$$\Delta T_2 = T_{h,out} - T_{c,in} = 151.8\text{°C} - 20\text{°C} = 131.8\text{°C}$$

$$\Delta T_{lm,CF} = \frac{\Delta T_1 - \Delta T_2}{\ln(\Delta T_1 / \Delta T_2)} = \frac{100 - 131.8}{\ln(100 / 131.8)} = 115.2\text{°C}$$

$$\left. \begin{aligned} P &= \frac{t_2 - t_1}{T_1 - t_1} = \frac{70 - 20}{170 - 20} = 0.33 \\ R &= \frac{T_1 - T_2}{t_2 - t_1} = \frac{170 - 151.8}{70 - 20} = 0.36 \end{aligned} \right\} F = 1.0$$

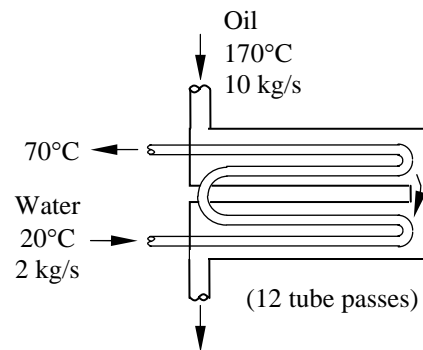

Then the heat transfer surface area on the tube side becomes

$$\dot{Q} = U_i A_i F \Delta T_{lm,CF} \longrightarrow A_i = \frac{\dot{Q}}{U_i F \Delta T_{lm,CF}} = \frac{418 \text{ kW}}{(0.350 \text{ kW/m}^2\cdot\text{°C})(1.0)(115.2\text{°C})} = \mathbf{10.4 \text{ m}^2}$$

11-63 Ethyl alcohol is heated by water in a 2-shell passes and 8-tube passes heat exchanger. The heat transfer surface area of the heat exchanger is to be determined.

Assumptions **1** Steady operating conditions exist. **2** The heat exchanger is well-insulated so that heat loss to the surroundings is negligible and thus heat transfer from the hot fluid is equal to the heat transfer to the cold fluid. **3** Changes in the kinetic and potential energies of fluid streams are negligible. **4** There is no fouling. **5** Fluid properties are constant.

Properties The specific heats of water and ethyl alcohol are given to be 4.19 and 2.67 kJ/kg.°C, respectively.

Analysis The rate of heat transfer in this heat exchanger is

$$\dot{Q} = [\dot{m}c_p(T_{out} - T_{in})]_{\text{ethyl alcohol}} = (2.1 \text{ kg/s})(2.67 \text{ kJ/kg}\cdot\text{°C})(70\text{°C} - 25\text{°C}) = 252.3 \text{ kW}$$

The logarithmic mean temperature difference for counter-flow arrangement and the correction factor F are

$$\Delta T_1 = T_{h,in} - T_{c,out} = 95\text{°C} - 70\text{°C} = 25\text{°C}$$

$$\Delta T_2 = T_{h,out} - T_{c,in} = 45\text{°C} - 25\text{°C} = 20\text{°C}$$

$$\Delta T_{lm,CF} = \frac{\Delta T_1 - \Delta T_2}{\ln(\Delta T_1 / \Delta T_2)} = \frac{25 - 20}{\ln(25 / 20)} = 22.4\text{°C}$$

$$\left. \begin{aligned} P &= \frac{t_2 - t_1}{T_1 - t_1} = \frac{70 - 25}{95 - 25} = 0.64 \\ R &= \frac{T_1 - T_2}{t_2 - t_1} = \frac{95 - 45}{70 - 25} = 1.1 \end{aligned} \right\} F = 0.82$$

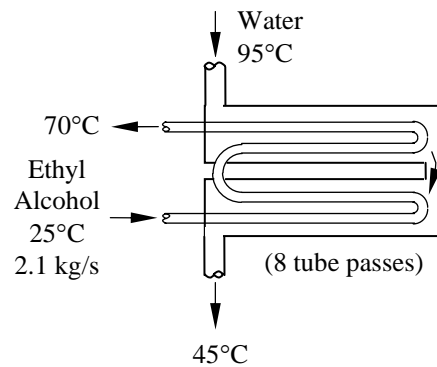

Then the heat transfer surface area on the tube side becomes

$$\dot{Q} = U_i A_i F \Delta T_{lm,CF} \longrightarrow A_i = \frac{\dot{Q}}{U_i F \Delta T_{lm,CF}} = \frac{252.3 \text{ kW}}{(0.950 \text{ kW/m}^2\cdot\text{°C})(0.82)(22.4\text{°C})} = 14.5 \text{ m}^2$$

11-64 Water is heated by ethylene glycol in a 2-shell passes and 12-tube passes heat exchanger. The rate of heat transfer and the heat transfer surface area on the tube side are to be determined.

Assumptions **1** Steady operating conditions exist. **2** The heat exchanger is well-insulated so that heat loss to the surroundings is negligible and thus heat transfer from the hot fluid is equal to the heat transfer to the cold fluid. **3** Changes in the kinetic and potential energies of fluid streams are negligible. **4** There is no fouling. **5** Fluid properties are constant.

Properties The specific heats of water and ethylene glycol are given to be 4.18 and 2.68 kJ/kg·°C, respectively.

Analysis The rate of heat transfer in this heat exchanger is :

$$\dot{Q} = [\dot{m}c_p(T_{out} - T_{in})]_{\text{water}} = (0.8 \text{ kg/s})(4.18 \text{ kJ/kg}\cdot\text{°C})(70\text{°C} - 22\text{°C}) = \mathbf{160.5 \text{ kW}}$$

The logarithmic mean temperature difference for counter-flow arrangement and the correction factor F are

$$\Delta T_1 = T_{h,in} - T_{c,out} = 110\text{°C} - 70\text{°C} = 40\text{°C}$$

$$\Delta T_2 = T_{h,out} - T_{c,in} = 60\text{°C} - 22\text{°C} = 38\text{°C}$$

$$\Delta T_{lm,CF} = \frac{\Delta T_1 - \Delta T_2}{\ln(\Delta T_1 / \Delta T_2)} = \frac{40 - 38}{\ln(40 / 38)} = 39\text{°C}$$

$$\left. \begin{aligned} P &= \frac{t_2 - t_1}{T_1 - t_1} = \frac{70 - 22}{110 - 22} = 0.55 \\ R &= \frac{T_1 - T_2}{t_2 - t_1} = \frac{110 - 60}{70 - 22} = 1.04 \end{aligned} \right\} F = 0.92$$

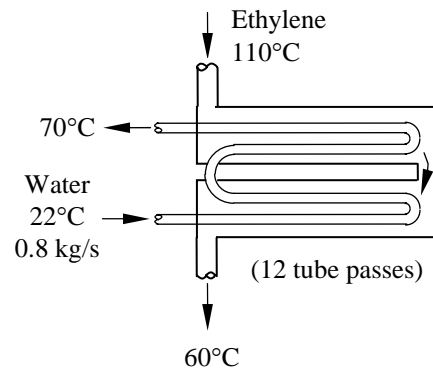

Then the heat transfer surface area on the tube side becomes

$$\dot{Q} = U_i A_i F \Delta T_{lm,CF} \longrightarrow A_i = \frac{\dot{Q}}{U_i F \Delta T_{lm,CF}} = \frac{160.5 \text{ kW}}{(0.28 \text{ kW/m}^2\cdot\text{°C})(0.92)(39\text{°C})} = \mathbf{16.0 \text{ m}^2}$$

11-65 EES Prob. 11-64 is reconsidered. The effect of the mass flow rate of water on the rate of heat transfer and the tube-side surface area is to be investigated.

Analysis The problem is solved using EES, and the solution is given below.

"GIVEN"

T_w_in=22 [C]
 T_w_out=70 [C]
 m_dot_w=0.8 [kg/s]
 C_p_w=4.18 [kJ/kg-C]
 T_glycol_in=110 [C]
 T_glycol_out=60 [C]
 C_p_glycol=2.68 [kJ/kg-C]
 U=0.28 [kW/m^2-C]

"ANALYSIS"

Q_dot=m_dot_w*C_p_w*(T_w_out-T_w_in)
 Q_dot=m_dot_glycol*C_p_glycol*(T_glycol_in-T_glycol_out)
 DELTAT_1=T_glycol_in-T_w_out
 DELTAT_2=T_glycol_out-T_w_in
 DELTAT_lm_CF=(DELTAT_1-DELTAT_2)/ln(DELTAT_1/DELTAT_2)
 P=(T_w_out-T_w_in)/(T_glycol_in-T_w_in)
 R=(T_glycol_in-T_glycol_out)/(T_w_out-T_w_in)
 F=0.92 "from Fig. 11-18b of the text at the calculated P and R"
 Q_dot=U*A*F*DELTAT_lm_CF

m _w [kg/s]	Q [kW]	A [m ²]
0.4	80.26	7.99
0.5	100.3	9.988
0.6	120.4	11.99
0.7	140.4	13.98
0.8	160.5	15.98
0.9	180.6	17.98
1	200.6	19.98
1.1	220.7	21.97
1.2	240.8	23.97
1.3	260.8	25.97
1.4	280.9	27.97
1.5	301	29.96
1.6	321	31.96
1.7	341.1	33.96
1.8	361.2	35.96
1.9	381.2	37.95
2	401.3	39.95
2.1	421.3	41.95
2.2	441.4	43.95

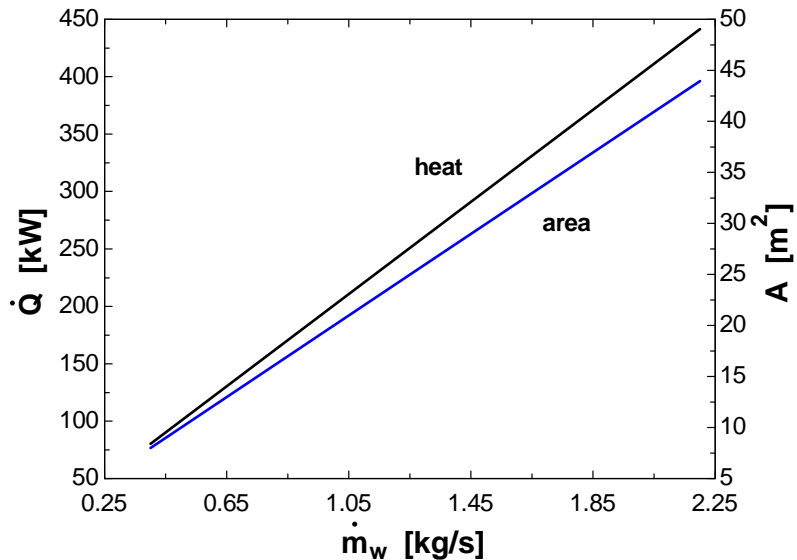

11-66E Steam is condensed by cooling water in a condenser. The rate of heat transfer, the rate of condensation of steam, and the mass flow rate of cold water are to be determined.

Assumptions **1** Steady operating conditions exist. **2** The heat exchanger is well-insulated so that heat loss to the surroundings is negligible and thus heat transfer from the hot fluid is equal to the heat transfer to the cold fluid. **3** Changes in the kinetic and potential energies of fluid streams are negligible. **4** There is no fouling. **5** Fluid properties are constant. **6** The thermal resistance of the inner tube is negligible since the tube is thin-walled and highly conductive.

Properties We take specific heat of water are given to be 1.0 Btu/lbm.°F. The heat of condensation of steam at 90°F is 1043 Btu/lbm.

Analysis (a) The log mean temperature difference is determined from

$$\Delta T_1 = T_{h,in} - T_{c,out} = 90^\circ\text{F} - 73^\circ\text{F} = 17^\circ\text{F}$$

$$\Delta T_2 = T_{h,out} - T_{c,in} = 90^\circ\text{F} - 60^\circ\text{F} = 30^\circ\text{F}$$

$$\Delta T_{lm,CF} = \frac{\Delta T_1 - \Delta T_2}{\ln(\Delta T_1 / \Delta T_2)} = \frac{17 - 30}{\ln(17 / 30)} = 22.9^\circ\text{F}$$

The heat transfer surface area is

$$A_s = 8n\pi DL = 8 \times 50 \times \pi(3/48 \text{ ft})(5 \text{ ft}) = 392.7 \text{ ft}^2$$

and

$$\dot{Q} = UA_s \Delta T_{lm} = (600 \text{ Btu/h.ft}^2 \cdot ^\circ\text{F})(392.7 \text{ ft}^2)(22.9^\circ\text{F}) = \mathbf{5.396 \times 10^6 \text{ Btu/h}}$$

(b) The rate of condensation of the steam is

$$\dot{Q} = (\dot{m}h_{fg})_{steam} \longrightarrow \dot{m}_{steam} = \frac{\dot{Q}}{h_{fg}} = \frac{5.396 \times 10^6 \text{ Btu/h}}{1043 \text{ Btu/lbm}} = \mathbf{5173 \text{ lbm/h} = 1.44 \text{ lbm/s}}$$

(c) Then the mass flow rate of cold water becomes

$$\dot{Q} = [\dot{m}c_p(T_{out} - T_{in})]_{cold \text{ water}}$$

$$\dot{m}_{cold \text{ water}} = \frac{\dot{Q}}{c_p(T_{out} - T_{in})} = \frac{5.396 \times 10^6 \text{ Btu/h}}{(1.0 \text{ Btu/lbm.}^\circ\text{F})(73^\circ\text{F} - 60^\circ\text{F})} = \mathbf{4.15 \times 10^5 \text{ lbm/h} = 115 \text{ lbm/s}}$$

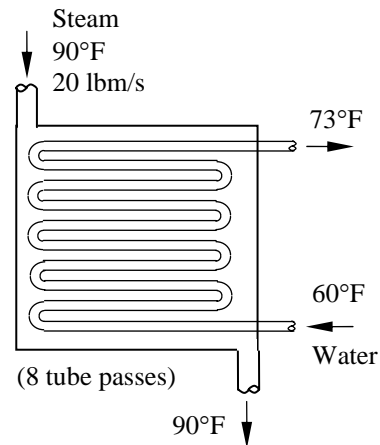

11-67E EES Prob. 11-66E is reconsidered. The effect of the condensing steam temperature on the rate of heat transfer, the rate of condensation of steam, and the mass flow rate of cold water is to be investigated.

Analysis The problem is solved using EES, and the solution is given below.

"GIVEN"

N_pass=8
 N_tube=50
 T_steam=90 [F]
 h_fg_steam=1043 [Btu/lbm]
 T_w_in=60 [F]
 T_w_out=73 [F]
 C_p_w=1.0 [Btu/lbm-F]
 D=3/4*1/12 [ft]
 L=5 [ft]
 U=600 [Btu/h-ft^2-F]

"ANALYSIS"

"(a)"

DELTA_T_1=T_steam-T_w_out
 DELTA_T_2=T_steam-T_w_in
 DELTA_T_lm=(DELTA_T_1-DELTA_T_2)/ln(DELTA_T_1/DELTA_T_2)
 A=N_pass*N_tube*pi*D*L
 Q_dot=U*A*DELTA_T_lm*Convert(Btu/h, Btu/s)

"(b)"

Q_dot=m_dot_steam*h_fg_steam

"(c)"

Q_dot=m_dot_w*C_p_w*(T_w_out-T_w_in)

T _{steam} [F]	Q [Btu/s]	m _{steam} [lbm/s]	m _w [lbm/s]
80	810.5	0.7771	62.34
82	951.9	0.9127	73.23
84	1091	1.046	83.89
86	1228	1.177	94.42
88	1363	1.307	104.9
90	1498	1.436	115.2
92	1632	1.565	125.6
94	1766	1.693	135.8
96	1899	1.821	146.1
98	2032	1.948	156.3
100	2165	2.076	166.5
102	2297	2.203	176.7
104	2430	2.329	186.9
106	2562	2.456	197.1
108	2694	2.583	207.2
110	2826	2.709	217.4
112	2958	2.836	227.5
114	3089	2.962	237.6
116	3221	3.088	247.8
118	3353	3.214	257.9
120	3484	3.341	268

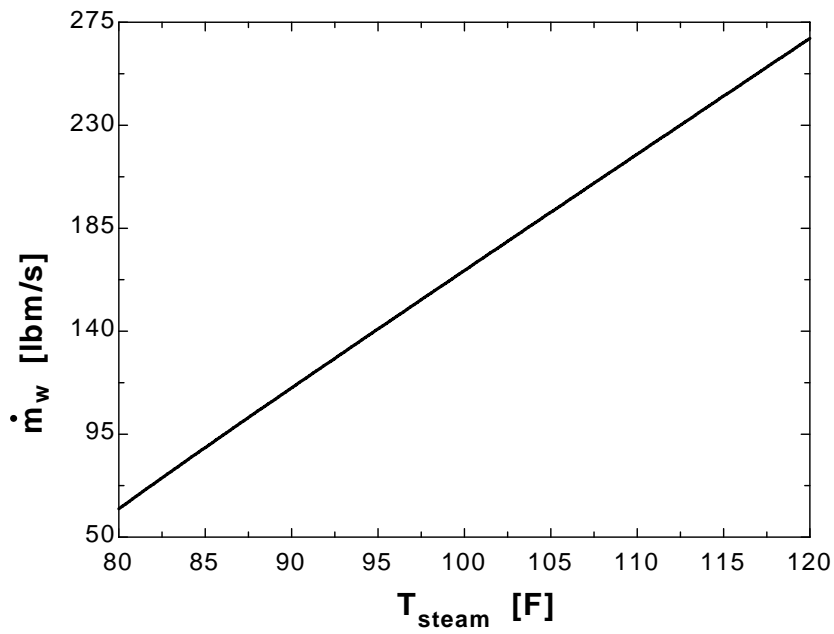
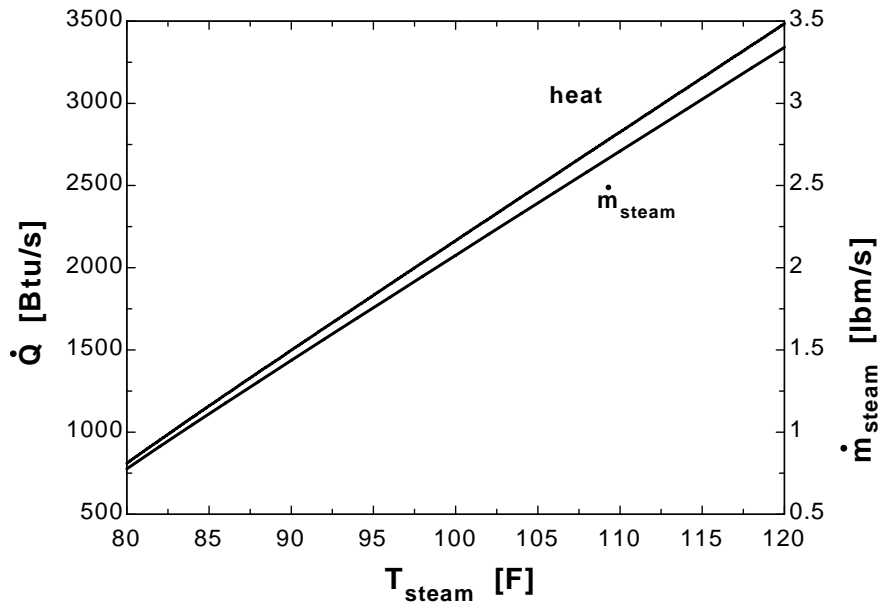

11-68 Glycerin is heated by hot water in a 1-shell pass and 20-tube passes heat exchanger. The mass flow rate of glycerin and the overall heat transfer coefficient of the heat exchanger are to be determined.

Assumptions **1** Steady operating conditions exist. **2** The heat exchanger is well-insulated so that heat loss to the surroundings is negligible and thus heat transfer from the hot fluid is equal to the heat transfer to the cold fluid. **3** Changes in the kinetic and potential energies of fluid streams are negligible. **4** There is no fouling. **5** Fluid properties are constant.

Properties The specific heat of glycerin is given to be $2.48 \text{ kJ/kg}\cdot^\circ\text{C}$ and that of water is taken to be $4.18 \text{ kJ/kg}\cdot^\circ\text{C}$.

Analysis The rate of heat transfer in this heat exchanger is

$$\dot{Q} = [\dot{m}c_p(T_{in} - T_{out})]_{\text{water}} = (0.5 \text{ kg/s})(4.18 \text{ kJ/kg}\cdot^\circ\text{C})(100^\circ\text{C} - 55^\circ\text{C}) = 94.05 \text{ kW}$$

The mass flow rate of the glycerin is determined from

$$\dot{Q} = [\dot{m}c_p(T_{out} - T_{in})]_{\text{glycerin}}$$

$$\dot{m}_{\text{glycerin}} = \frac{\dot{Q}}{c_p(T_{out} - T_{in})} = \frac{94.05 \text{ kJ/s}}{(2.48 \text{ kJ/kg}\cdot^\circ\text{C})[(55^\circ\text{C} - 15^\circ\text{C})]} = \mathbf{0.95 \text{ kg/s}}$$

The logarithmic mean temperature difference for counter-flow arrangement and the correction factor F are

$$\Delta T_1 = T_{h,in} - T_{c,out} = 100^\circ\text{C} - 55^\circ\text{C} = 45^\circ\text{C}$$

$$\Delta T_2 = T_{h,out} - T_{c,in} = 55^\circ\text{C} - 15^\circ\text{C} = 40^\circ\text{C}$$

$$\Delta T_{lm,CF} = \frac{\Delta T_1 - \Delta T_2}{\ln(\Delta T_1 / \Delta T_2)} = \frac{45 - 40}{\ln(45 / 40)} = 42.5^\circ\text{C}$$

$$\left. \begin{aligned} P &= \frac{t_2 - t_1}{T_1 - t_1} = \frac{55 - 100}{15 - 100} = 0.53 \\ R &= \frac{T_1 - T_2}{t_2 - t_1} = \frac{15 - 55}{55 - 100} = 0.89 \end{aligned} \right\} F = 0.77$$

The heat transfer surface area is

$$A_s = n\pi DL = 20\pi(0.04 \text{ m})(2 \text{ m}) = 5.027 \text{ m}^2$$

Then the overall heat transfer coefficient of the heat exchanger is determined to be

$$\dot{Q} = UA_s F \Delta T_{lm,CF} \longrightarrow U = \frac{\dot{Q}}{A_s F \Delta T_{lm,CF}} = \frac{94.05 \text{ kW}}{(5.027 \text{ m}^2)(0.77)(42.5^\circ\text{C})} = \mathbf{0.572 \text{ kW/m}^2 \cdot ^\circ\text{C}}$$

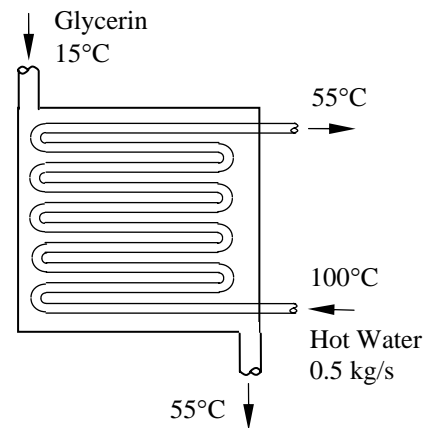

11-69 Isobutane is condensed by cooling air in the condenser of a power plant. The mass flow rate of air and the overall heat transfer coefficient are to be determined.

Assumptions 1 Steady operating conditions exist. 2 The heat exchanger is well-insulated so that heat loss to the surroundings is negligible and thus heat transfer from the hot fluid is equal to the heat transfer to the cold fluid. 3 Changes in the kinetic and potential energies of fluid streams are negligible. 4 There is no fouling. 5 Fluid properties are constant.

Properties The heat of vaporization of isobutane at 75°C is given to be $h_{fg} = 255.7$ kJ/kg and specific heat of air is taken to be $c_p = 1005$ J/kg·°C.

Analysis First, the rate of heat transfer is determined from

$$\begin{aligned}\dot{Q} &= (\dot{m}h_{fg})_{\text{isobutane}} \\ &= (2.7 \text{ kg/s})(255.7 \text{ kJ/kg}) = 690.4 \text{ kW}\end{aligned}$$

The mass flow rate of air is determined from

$$\dot{Q} = [\dot{m}c_p(T_{\text{out}} - T_{\text{in}})]_{\text{air}} \longrightarrow \dot{m}_{\text{air}} = \frac{\dot{Q}}{c_p(T_{\text{out}} - T_{\text{in}})} = \frac{690.4 \text{ kJ/s}}{(1.005 \text{ kJ/kg}\cdot\text{°C})(28\text{°C} - 21\text{°C})} = \mathbf{98.1 \text{ kg/s}}$$

The temperature differences between the isobutane and the air at the two ends of the condenser are

$$\Delta T_1 = T_{\text{h,in}} - T_{\text{c,out}} = 75\text{°C} - 21\text{°C} = 54\text{°C}$$

$$\Delta T_2 = T_{\text{h,out}} - T_{\text{c,in}} = 75\text{°C} - 28\text{°C} = 47\text{°C}$$

and

$$\Delta T_{\text{lm}} = \frac{\Delta T_1 - \Delta T_2}{\ln(\Delta T_1 / \Delta T_2)} = \frac{54 - 47}{\ln(54 / 47)} = 50.4\text{°C}$$

Then the overall heat transfer coefficient is determined from

$$\dot{Q} = UA_s \Delta T_{\text{lm}} \longrightarrow 690,400 \text{ W} = U(24 \text{ m}^2)(50.4\text{°C}) \longrightarrow U = \mathbf{571 \text{ W/m}^2\cdot\text{°C}}$$

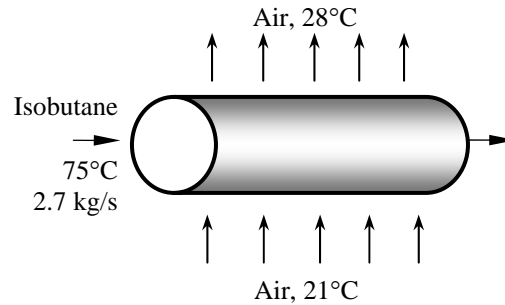

11-70 Water is evaporated by hot exhaust gases in an evaporator. The rate of heat transfer, the exit temperature of the exhaust gases, and the rate of evaporation of water are to be determined.

Assumptions **1** Steady operating conditions exist. **2** The heat exchanger is well-insulated so that heat loss to the surroundings is negligible and thus heat transfer from the hot fluid is equal to the heat transfer to the cold fluid. **3** Changes in the kinetic and potential energies of fluid streams are negligible. **4** There is no fouling. **5** Fluid properties are constant.

Properties The heat of vaporization of water at 200°C is given to be $h_{fg} = 1941 \text{ kJ/kg}$ and specific heat of exhaust gases is given to be $c_p = 1051 \text{ J/kg}\cdot\text{°C}$.

Analysis The temperature differences between the water and the exhaust gases at the two ends of the evaporator are

$$\Delta T_1 = T_{h,\text{in}} - T_{c,\text{out}} = 550^\circ\text{C} - 200^\circ\text{C} = 350^\circ\text{C}$$

$$\Delta T_2 = T_{h,\text{out}} - T_{c,\text{in}} = (T_{h,\text{out}} - 200)^\circ\text{C}$$

and

$$\Delta T_{\text{lm}} = \frac{\Delta T_1 - \Delta T_2}{\ln(\Delta T_1 / \Delta T_2)} = \frac{350 - (T_{h,\text{out}} - 200)}{\ln[350 / (T_{h,\text{out}} - 200)]}$$

Then the rate of heat transfer can be expressed as

$$\dot{Q} = UA_s \Delta T_{\text{lm}} = (1.780 \text{ kW/m}^2 \cdot \text{°C})(0.5 \text{ m}^2) \frac{350 - (T_{h,\text{out}} - 200)}{\ln[350 / (T_{h,\text{out}} - 200)]} \quad (\text{Eq. 1})$$

The rate of heat transfer can also be expressed as in the following forms

$$\dot{Q} = [\dot{m}c_p (T_{h,\text{in}} - T_{h,\text{out}})]_{\text{exhaust gases}} = (0.25 \text{ kg/s})(1.051 \text{ kJ/kg}\cdot\text{°C})(550^\circ\text{C} - T_{h,\text{out}}) \quad (\text{Eq. 2})$$

$$\dot{Q} = (\dot{m}h_{fg})_{\text{water}} = \dot{m}_{\text{water}} (1941 \text{ kJ/kg}) \quad (\text{Eq. 3})$$

We have three equations with three unknowns. Using an equation solver such as EES, the unknowns are determined to be

$$\dot{Q} = \mathbf{88.85 \text{ kW}}$$

$$T_{h,\text{out}} = \mathbf{211.8^\circ\text{C}}$$

$$\dot{m}_{\text{water}} = \mathbf{0.0458 \text{ kg/s}}$$

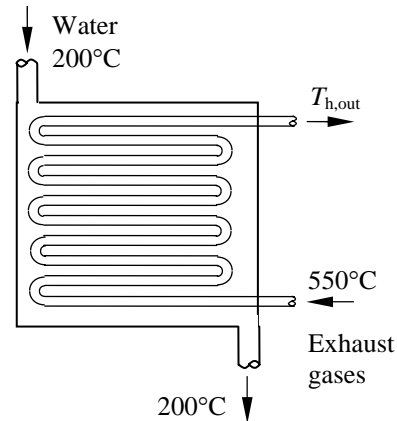

11-71 EES Prob. 11-70 is reconsidered. The effect of the exhaust gas inlet temperature on the rate of heat transfer, the exit temperature of exhaust gases, and the rate of evaporation of water is to be investigated.

Analysis The problem is solved using EES, and the solution is given below.

"GIVEN"

T_exhaust_in=550 [C]
 C_p_exhaust=1.051 [kJ/kg-C]
 m_dot_exhaust=0.25 [kg/s]
 T_w=200 [C]
 h_fg_w=1941 [kJ/kg]
 A=0.5 [m^2]
 U=1.780 [kW/m^2-C]

"ANALYSIS"

DELTA_T_1=T_exhaust_in-T_w
 DELTA_T_2=T_exhaust_out-T_w
 DELTA_T_lm=(DELTA_T_1-DELTA_T_2)/ln(DELTA_T_1/DELTA_T_2)
 Q_dot=U*A*DELTA_T_lm
 Q_dot=m_dot_exhaust*C_p_exhaust*(T_exhaust_in-T_exhaust_out)
 Q_dot=m_dot_w*h_fg_w

T _{exhaust,in} [C]	Q [kW]	T _{exhaust,out} [C]	m _w [kg/s]
300	25.39	203.4	0.01308
320	30.46	204.1	0.0157
340	35.54	204.7	0.01831
360	40.62	205.4	0.02093
380	45.7	206.1	0.02354
400	50.77	206.8	0.02616
420	55.85	207.4	0.02877
440	60.93	208.1	0.03139
460	66.01	208.8	0.03401
480	71.08	209.5	0.03662
500	76.16	210.1	0.03924
520	81.24	210.8	0.04185
540	86.32	211.5	0.04447
560	91.39	212.2	0.04709
580	96.47	212.8	0.0497
600	101.5	213.5	0.05232

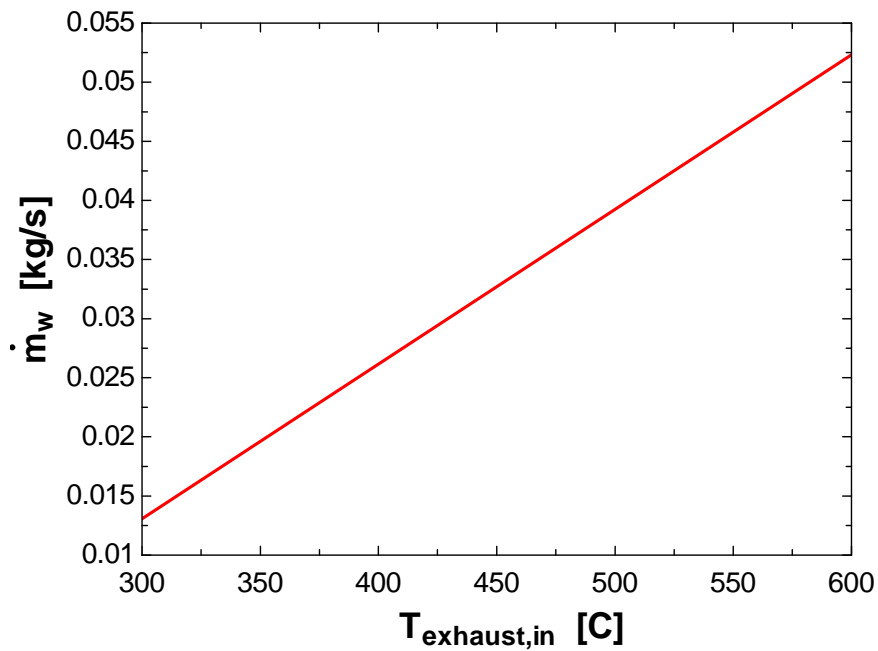
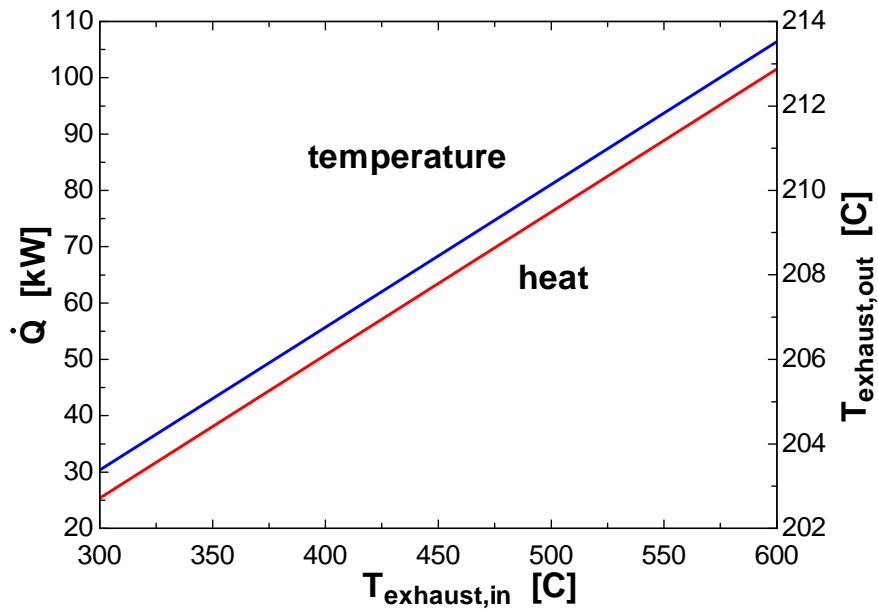

11-72 The waste dyeing water is to be used to preheat fresh water. The outlet temperatures of each fluid and the mass flow rate are to be determined.

Assumptions **1** Steady operating conditions exist. **2** The heat exchanger is well-insulated so that heat loss to the surroundings is negligible and thus heat transfer from the hot fluid is equal to the heat transfer to the cold fluid. **3** Changes in the kinetic and potential energies of fluid streams are negligible. **4** There is no fouling. **5** Fluid properties are constant.

Properties The specific heats of waste dyeing water and the fresh water are given to be $c_p = 4295 \text{ J/kg}\cdot^\circ\text{C}$ and $c_p = 4180 \text{ J/kg}\cdot^\circ\text{C}$, respectively.

Analysis The temperature differences between the dyeing water and the fresh water at the two ends of the heat exchanger are

$$\Delta T_1 = T_{h,\text{in}} - T_{c,\text{out}} = 75 - T_{c,\text{out}}$$

$$\Delta T_2 = T_{h,\text{out}} - T_{c,\text{in}} = T_{h,\text{out}} - 15$$

and

$$\Delta T_{\text{lm}} = \frac{\Delta T_1 - \Delta T_2}{\ln(\Delta T_1 / \Delta T_2)} = \frac{(75 - T_{c,\text{out}}) - (T_{h,\text{out}} - 15)}{\ln[(75 - T_{c,\text{out}}) / (T_{h,\text{out}} - 15)]}$$

Then the rate of heat transfer can be expressed as

$$\begin{aligned} \dot{Q} &= UA_s \Delta T_{\text{lm}} \\ 35 \text{ kW} &= (0.625 \text{ kW/m}^2 \cdot ^\circ\text{C})(1.65 \text{ m}^2) \frac{(75 - T_{c,\text{out}}) - (T_{h,\text{out}} - 15)}{\ln[(75 - T_{c,\text{out}}) / (T_{h,\text{out}} - 15)]} \end{aligned} \quad (\text{Eq. 1})$$

The rate of heat transfer can also be expressed as

$$\dot{Q} = [\dot{m} c_p (T_{h,\text{in}} - T_{h,\text{out}})]_{\text{dyeing water}} \longrightarrow 35 \text{ kW} = \dot{m}(4.295 \text{ kJ/kg}\cdot^\circ\text{C})(75^\circ\text{C} - T_{h,\text{out}}) \quad (\text{Eq. 2})$$

$$\dot{Q} = [\dot{m} c_p (T_{h,\text{in}} - T_{h,\text{out}})]_{\text{water}} \longrightarrow 35 \text{ kW} = \dot{m}(4.18 \text{ kJ/kg}\cdot^\circ\text{C})(T_{c,\text{out}} - 15^\circ\text{C}) \quad (\text{Eq. 3})$$

We have three equations with three unknowns. Using an equation solver such as EES, the unknowns are determined to be

$$T_{c,\text{out}} = \mathbf{41.4^\circ\text{C}}$$

$$T_{h,\text{out}} = \mathbf{49.3^\circ\text{C}}$$

$$\dot{m} = \mathbf{0.317 \text{ kg/s}}$$

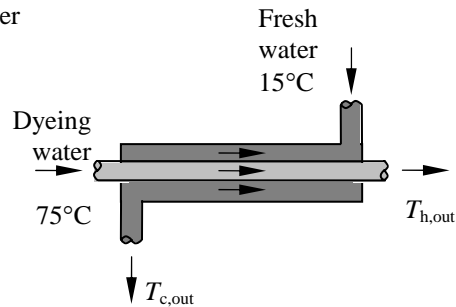

The Effectiveness-NTU Method

11-73C When the heat transfer surface area A of the heat exchanger is known, but the outlet temperatures are not, the effectiveness-NTU method is definitely preferred.

11-74C The effectiveness of a heat exchanger is defined as the ratio of the actual heat transfer rate to the maximum possible heat transfer rate and represents how closely the heat transfer in the heat exchanger approaches to maximum possible heat transfer. Since the actual heat transfer rate can not be greater than maximum possible heat transfer rate, the effectiveness can not be greater than one. The effectiveness of a heat exchanger depends on the geometry of the heat exchanger as well as the flow arrangement.

11-75C For a specified fluid pair, inlet temperatures and mass flow rates, the counter-flow heat exchanger will have the highest effectiveness.

11-76C Once the effectiveness ε is known, the rate of heat transfer and the outlet temperatures of cold and hot fluids in a heat exchanger are determined from

$$\begin{aligned}\dot{Q} &= \varepsilon \dot{Q}_{\max} = \varepsilon C_{\min} (T_{h,in} - T_{c,in}) \\ \dot{Q} &= \dot{m}_c c_{p,c} (T_{c,out} - T_{c,in}) \\ \dot{Q} &= \dot{m}_h c_{p,h} (T_{h,in} - T_{h,out})\end{aligned}$$

11-77C The heat transfer in a heat exchanger will reach its maximum value when the hot fluid is cooled to the inlet temperature of the cold fluid. Therefore, the temperature of the hot fluid cannot drop below the inlet temperature of the cold fluid at any location in a heat exchanger.

11-78C The heat transfer in a heat exchanger will reach its maximum value when the cold fluid is heated to the inlet temperature of the hot fluid. Therefore, the temperature of the cold fluid cannot rise above the inlet temperature of the hot fluid at any location in a heat exchanger.

11-79C The fluid with the lower mass flow rate will experience a larger temperature change. This is clear from the relation

$$\dot{Q} = \dot{m}_c c_p \Delta T_{cold} = \dot{m}_h c_p \Delta T_{hot}$$

11-80C The maximum possible heat transfer rate in a heat exchanger is determined from

$$\dot{Q}_{\max} = C_{\min} (T_{h,in} - T_{c,in})$$

where C_{\min} is the smaller heat capacity rate. The value of \dot{Q}_{\max} does not depend on the type of heat exchanger.

11-81C The longer heat exchanger is more likely to have a higher effectiveness.

11-82C The increase of effectiveness with NTU is not linear. The effectiveness increases rapidly with NTU for small values (up to about NTU = 1.5), but rather slowly for larger values. Therefore, the effectiveness will not double when the length of heat exchanger is doubled.

11-83C A heat exchanger has the smallest effectiveness value when the heat capacity rates of two fluids are identical. Therefore, reducing the mass flow rate of cold fluid by half will increase its effectiveness.

11-84C When the capacity ratio is equal to zero and the number of transfer units value is greater than 5, a counter-flow heat exchanger has an effectiveness of one. In this case the exit temperature of the fluid with smaller capacity rate will equal to inlet temperature of the other fluid. For a parallel-flow heat exchanger the answer would be the same.

11-85C The NTU of a heat exchanger is defined as $NTU = \frac{UA_s}{C_{\min}} = \frac{UA_s}{(\dot{m}c_p)_{\min}}$ where U is the overall heat transfer coefficient and A_s is the heat transfer surface area of the heat exchanger. For specified values of U and C_{\min} , the value of NTU is a measure of the heat exchanger surface area A_s . Because the effectiveness increases slowly for larger values of NTU, a large heat exchanger cannot be justified economically. Therefore, a heat exchanger with a very large NTU is not necessarily a good one to buy.

11-86C The value of effectiveness increases slowly with a large values of NTU (usually larger than 3). Therefore, doubling the size of the heat exchanger will not save much energy in this case since the increase in the effectiveness will be very small.

11-87C The value of effectiveness increases rapidly with small values of NTU (up to about 1.5). Therefore, tripling the NTU will cause a rapid increase in the effectiveness of the heat exchanger, and thus saves energy. I would support this proposal.

11-88 Hot water coming from the engine of an automobile is cooled by air in the radiator. The outlet temperature of the air and the rate of heat transfer are to be determined.

Assumptions 1 Steady operating conditions exist. 2 The heat exchanger is well-insulated so that heat loss to the surroundings is negligible and thus heat transfer from the hot fluid is equal to the heat transfer to the cold fluid. 3 Changes in the kinetic and potential energies of fluid streams are negligible. 4 Fluid properties are constant.

Properties The specific heats of water and air are given to be 4.00 and 1.00 kJ/kg·°C, respectively.

Analysis (a) The heat capacity rates of the hot and cold fluids are

$$C_h = \dot{m}_h c_{ph} = (5 \text{ kg/s})(4.00 \text{ kJ/kg}\cdot\text{°C}) = 20 \text{ kW/°C}$$

$$C_c = \dot{m}_c c_{pc} = (10 \text{ kg/s})(1.00 \text{ kJ/kg}\cdot\text{°C}) = 10 \text{ kW/°C}$$

Therefore

$$C_{\min} = C_c = 10 \text{ kW/°C}$$

which is the smaller of the two heat capacity rates. Noting that the heat capacity rate of the air is the smaller one, the outlet temperature of the air is determined from the effectiveness relation to be

$$\varepsilon = \frac{\dot{Q}}{\dot{Q}_{\max}} = \frac{C_{\min}(T_{a,\text{out}} - T_{c,\text{in}})}{C_{\min}(T_{h,\text{in}} - T_{c,\text{in}})} \rightarrow 0.4 = \frac{(T_{a,\text{out}} - 30)\text{°C}}{(80 - 30)\text{°C}} \rightarrow T_{a,\text{out}} = 50\text{°C}$$

(b) The rate of heat transfer is determined from

$$\dot{Q} = C_{\text{air}}(T_{a,\text{out}} - T_{a,\text{in}}) = (10 \text{ kW/°C})(50\text{°C} - 30\text{°C}) = \mathbf{200 \text{ kW}}$$

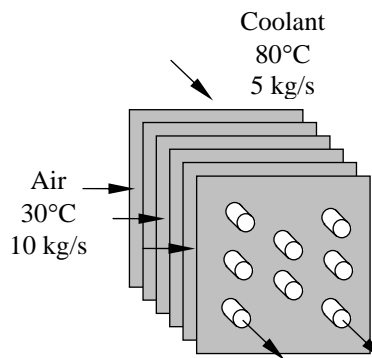

11-89 The inlet and exit temperatures and the volume flow rates of hot and cold fluids in a heat exchanger are given. The rate of heat transfer to the cold water, the overall heat transfer coefficient, the fraction of heat loss, the heat transfer efficiency, the effectiveness, and the NTU of the heat exchanger are to be determined.

Assumptions 1 Steady operating conditions exist. 2 Changes in the kinetic and potential energies of fluid streams are negligible. 3 Fluid properties are constant.

Properties The densities of hot water and cold water at the average temperatures of $(71.5+58.2)/2 = 64.9^\circ\text{C}$ and $(19.7+27.8)/2 = 23.8^\circ\text{C}$ are 980.5 and 997.3 kg/m^3 , respectively. The specific heat at the average temperature is 4187 $\text{J}/\text{kg}\cdot^\circ\text{C}$ for hot water and 4180 $\text{J}/\text{kg}\cdot^\circ\text{C}$ for cold water (Table A-9).

Analysis (a) The mass flow rates are

$$\dot{m}_h = \rho_h \dot{V}_h = (980.5 \text{ kg}/\text{m}^3)(0.00105/60 \text{ m}^3/\text{s}) = 0.0172 \text{ kg}/\text{s}$$

$$\dot{m}_c = \rho_c \dot{V}_c = (997.3 \text{ kg}/\text{m}^3)(0.00155/60 \text{ m}^3/\text{s}) = 0.0258 \text{ kg}/\text{s}$$

The rates of heat transfer from the hot water and to the cold water are

$$\dot{Q}_h = [\dot{m}c_p(T_{in} - T_{out})]_h = (0.0172 \text{ kg}/\text{s})(4187 \text{ kJ}/\text{kg}\cdot^\circ\text{C})(71.5^\circ\text{C} - 58.2^\circ\text{C}) = 957.8 \text{ W}$$

$$\dot{Q}_c = [\dot{m}c_p(T_{out} - T_{in})]_c = (0.0258 \text{ kg}/\text{s})(4180 \text{ kJ}/\text{kg}\cdot^\circ\text{C})(27.8^\circ\text{C} - 19.2^\circ\text{C}) = \mathbf{873.5 \text{ W}}$$

(b) The number of shell and tubes are not specified in the problem. Therefore, we take the correction factor to be unity in the following calculations. The logarithmic mean temperature difference and the overall heat transfer coefficient are

$$\Delta T_1 = T_{h,in} - T_{c,out} = 71.5^\circ\text{C} - 27.8^\circ\text{C} = 43.7^\circ\text{C}$$

$$\Delta T_2 = T_{h,out} - T_{c,in} = 58.2^\circ\text{C} - 19.7^\circ\text{C} = 38.5^\circ\text{C}$$

$$\Delta T_{lm} = \frac{\Delta T_1 - \Delta T_2}{\ln\left(\frac{\Delta T_1}{\Delta T_2}\right)} = \frac{43.7 - 38.5}{\ln\left(\frac{43.7}{38.5}\right)} = 41.0^\circ\text{C}$$

$$U = \frac{\dot{Q}_{hc,m}}{A\Delta T_{lm}} = \frac{(957.8 + 873.5) / 2 \text{ W}}{(0.02 \text{ m}^2)(41.0^\circ\text{C})} = \mathbf{1117 \text{ W}/\text{m}^2 \cdot ^\circ\text{C}}$$

Note that we used the average of two heat transfer rates in calculations.

(c) The fraction of heat loss and the heat transfer efficiency are

$$f_{loss} = \frac{\dot{Q}_h - \dot{Q}_c}{\dot{Q}_h} = \frac{957.8 - 873.5}{957.8} = 0.088 = \mathbf{8.8\%}$$

$$\eta = \frac{\dot{Q}_c}{\dot{Q}_h} = \frac{873.5}{957.8} = 0.912 = \mathbf{91.2\%}$$

(d) The heat capacity rates of the hot and cold fluids are

$$C_h = \dot{m}_h c_{ph} = (0.0172 \text{ kg}/\text{s})(4187 \text{ kJ}/\text{kg}\cdot^\circ\text{C}) = 72.02 \text{ W}/^\circ\text{C}$$

$$C_c = \dot{m}_c c_{pc} = (0.0258 \text{ kg}/\text{s})(4180 \text{ kJ}/\text{kg}\cdot^\circ\text{C}) = 107.8 \text{ W}/^\circ\text{C}$$

Therefore

$$C_{min} = C_h = 72.02 \text{ W}/^\circ\text{C}$$

which is the smaller of the two heat capacity rates. Then the maximum heat transfer rate becomes

$$\dot{Q}_{max} = C_{min}(T_{h,in} - T_{c,in}) = (72.02 \text{ W}/^\circ\text{C})(71.5^\circ\text{C} - 19.7^\circ\text{C}) = 3731 \text{ W}$$

The effectiveness of the heat exchanger is

$$\varepsilon = \frac{\dot{Q}}{\dot{Q}_{max}} = \frac{(957.8 + 873.5) / 2 \text{ kW}}{3731 \text{ kW}} = 0.245 = \mathbf{24.5\%}$$

One again we used the average heat transfer rate. We could have used the smaller or greater heat transfer rates in calculations. The NTU of the heat exchanger is determined from

$$NTU = \frac{UA}{C_{min}} = \frac{(1117 \text{ W}/\text{m}^2 \cdot ^\circ\text{C})(0.02 \text{ m}^2)}{72.02 \text{ W}/^\circ\text{C}} = \mathbf{0.310}$$

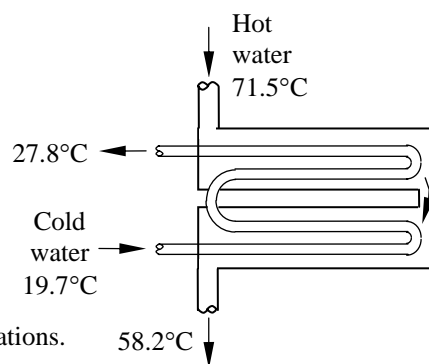

11-90 Water is heated by a hot water stream in a heat exchanger. The maximum outlet temperature of the cold water and the effectiveness of the heat exchanger are to be determined.

Assumptions 1 Steady operating conditions exist. 2 The heat exchanger is well-insulated so that heat loss to the surroundings is negligible and thus heat transfer from the hot fluid is equal to the heat transfer to the cold fluid. 3 Changes in the kinetic and potential energies of fluid streams are negligible. 4 Fluid properties are constant.

Properties The specific heats of water and air are given to be 4.18 and 1.0 kJ/kg·°C.

Analysis The heat capacity rates of the hot and cold fluids are

$$C_h = \dot{m}_h c_{ph} = (0.8 \text{ kg/s})(1.0 \text{ kJ/kg}\cdot\text{°C}) = 0.8 \text{ kW/°C}$$

$$C_c = \dot{m}_c c_{pc} = (0.35 \text{ kg/s})(4.18 \text{ kJ/kg}\cdot\text{°C}) = 1.463 \text{ kW/°C}$$

Therefore

$$C_{\min} = C_h = 0.8 \text{ kW/°C}$$

which is the smaller of the two heat capacity rates. Then the maximum heat transfer rate becomes

$$\dot{Q}_{\max} = C_{\min} (T_{h,in} - T_{c,in}) = (0.8 \text{ kW/°C})(65\text{°C} - 14\text{°C}) = 40.80 \text{ kW}$$

The maximum outlet temperature of the cold fluid is determined to be

$$\dot{Q}_{\max} = C_c (T_{c,out,max} - T_{c,in}) \longrightarrow T_{c,out,max} = T_{c,in} + \frac{\dot{Q}_{\max}}{C_c} = 14\text{°C} + \frac{40.80 \text{ kW}}{1.463 \text{ kW/°C}} = \mathbf{41.9\text{°C}}$$

The actual rate of heat transfer and the effectiveness of the heat exchanger are

$$\dot{Q} = C_h (T_{h,in} - T_{h,out}) = (0.8 \text{ kW/°C})(65\text{°C} - 25\text{°C}) = 32 \text{ kW}$$

$$\varepsilon = \frac{\dot{Q}}{\dot{Q}_{\max}} = \frac{32 \text{ kW}}{40.8 \text{ kW}} = \mathbf{0.784}$$

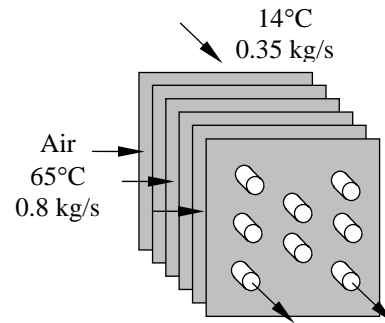

11-91 Lake water is used to condense steam in a shell and tube heat exchanger. The outlet temperature of the water and the required tube length are to be determined.

Assumptions 1 Steady operating conditions exist. 2 The heat exchanger is well-insulated so that heat loss to the surroundings is negligible and thus heat transfer from the hot fluid is equal to the heat transfer to the cold fluid. 3 Changes in the kinetic and potential energies of fluid streams are negligible. 4 Fluid properties are constant.

Properties The properties of water are given in problem statement. The enthalpy of vaporization of water at 60°C is 2359 kJ/kg (Table A-9).

Analysis (a) The rate of heat transfer is

$$\dot{Q} = \dot{m}h_{fg} = (2.5 \text{ kg/s})(2359 \text{ kJ/kg}) = 5898 \text{ kW}$$

The outlet temperature of water is determined from

$$\dot{Q} = \dot{m}_c c_c (T_{c,out} - T_{c,in}) \longrightarrow T_{c,out} = T_{c,in} + \frac{\dot{Q}}{\dot{m}_c c_c} = 20^\circ\text{C} + \frac{5898 \text{ kW}}{(200 \text{ kg/s})(4.18 \text{ kJ/kg} \cdot ^\circ\text{C})} = \mathbf{27.1^\circ\text{C}}$$

(b) The Reynold number is

$$\text{Re} = \frac{4\dot{m}}{N_{tube} \pi D \mu} = \frac{4(200 \text{ kg/s})}{(300)\pi(0.025 \text{ m})(8 \times 10^{-4} \text{ kg/m} \cdot \text{s})} = 42,440$$

which is greater than 10,000. Therefore, we have turbulent flow. We assume fully developed flow and evaluate the Nusselt number from

$$Nu = \frac{hD}{k} = 0.023 \text{Re}^{0.8} \text{Pr}^{0.4} = 0.023(42,440)^{0.8} (6)^{0.4} = 237.2$$

Heat transfer coefficient on the inner surface of the tubes is

$$h_i = \frac{k}{D} Nu = \frac{0.6 \text{ W/m} \cdot ^\circ\text{C}}{0.025 \text{ m}} (237.2) = 5694 \text{ W/m}^2 \cdot ^\circ\text{C}$$

Disregarding the thermal resistance of the tube wall the overall heat transfer coefficient is determined from

$$U = \frac{1}{\frac{1}{h_i} + \frac{1}{h_o}} = \frac{1}{\frac{1}{5694} + \frac{1}{8500}} = 3410 \text{ W/m}^2 \cdot ^\circ\text{C}$$

The logarithmic mean temperature difference is

$$\Delta T_1 = T_{h,in} - T_{c,out} = 60^\circ\text{C} - 27.1^\circ\text{C} = 32.9^\circ\text{C}$$

$$\Delta T_2 = T_{h,out} - T_{c,in} = 60^\circ\text{C} - 20^\circ\text{C} = 40^\circ\text{C}$$

$$\Delta T_{lm} = \frac{\Delta T_1 - \Delta T_2}{\ln\left(\frac{\Delta T_1}{\Delta T_2}\right)} = \frac{32.9 - 40}{\ln\left(\frac{32.9}{40}\right)} = 36.3^\circ\text{C}$$

Noting that each tube makes two passes and taking the correction factor to be unity, the tube length per pass is determined to be

$$\dot{Q} = UAF\Delta T_{lm} \longrightarrow L = \frac{\dot{Q}}{U(\pi D)F\Delta T_{lm}} = \frac{5898 \text{ kW}}{(3.410 \text{ kW/m}^2 \cdot ^\circ\text{C})[2 \times 300 \times \pi \times 0.025 \text{ m}^2](1)(36.3^\circ\text{C})} = \mathbf{1.01 \text{ m}}$$

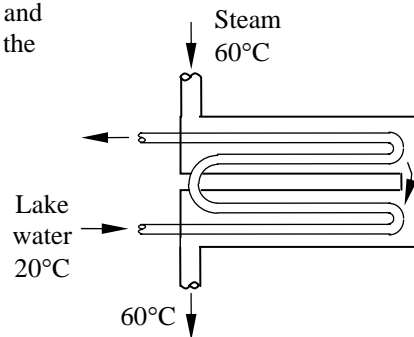

11-92 Air is heated by a hot water stream in a cross-flow heat exchanger. The maximum heat transfer rate and the outlet temperatures of the cold and hot fluid streams are to be determined.

Assumptions **1** Steady operating conditions exist. **2** The heat exchanger is well-insulated so that heat loss to the surroundings is negligible and thus heat transfer from the hot fluid is equal to the heat transfer to the cold fluid. **3** Changes in the kinetic and potential energies of fluid streams are negligible. **4** Fluid properties are constant.

Properties The specific heats of water and air are given to be 4.19 and 1.005 kJ/kg·°C.

Analysis The heat capacity rates of the hot and cold fluids are

$$C_h = \dot{m}_h c_{ph} = (1 \text{ kg/s})(4190 \text{ J/kg} \cdot ^\circ\text{C}) = 4190 \text{ W}/^\circ\text{C}$$

$$C_c = \dot{m}_c c_{pc} = (3 \text{ kg/s})(1005 \text{ J/kg} \cdot ^\circ\text{C}) = 3015 \text{ W}/^\circ\text{C}$$

Therefore

$$C_{\min} = C_c = 3015 \text{ W}/^\circ\text{C}$$

which is the smaller of the two heat capacity rates. Then the maximum heat transfer rate becomes

$$\dot{Q}_{\max} = C_{\min} (T_{h,in} - T_{c,in}) = (3015 \text{ W}/^\circ\text{C})(70^\circ\text{C} - 20^\circ\text{C}) = 150,750 \text{ W} = \mathbf{150.8 \text{ kW}}$$

The outlet temperatures of the cold and the hot streams in this limiting case are determined to be

$$\dot{Q} = C_c (T_{c,out} - T_{c,in}) \longrightarrow T_{c,out} = T_{c,in} + \frac{\dot{Q}}{C_c} = 20^\circ\text{C} + \frac{150.75 \text{ kW}}{3.015 \text{ kW}/^\circ\text{C}} = \mathbf{70^\circ\text{C}}$$

$$\dot{Q} = C_h (T_{h,in} - T_{h,out}) \longrightarrow T_{h,out} = T_{h,in} - \frac{\dot{Q}}{C_h} = 70^\circ\text{C} - \frac{150.75 \text{ kW}}{4.19 \text{ kW}/^\circ\text{C}} = \mathbf{34.0^\circ\text{C}}$$

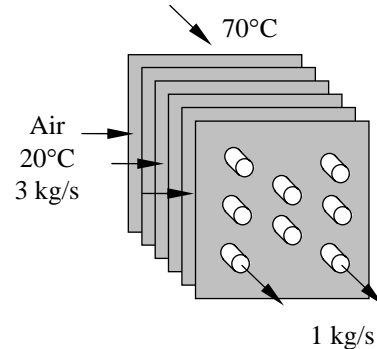

11-93 Hot oil is to be cooled by water in a heat exchanger. The mass flow rates and the inlet temperatures are given. The rate of heat transfer and the outlet temperatures are to be determined. \checkmark

Assumptions 1 Steady operating conditions exist. 2 The heat exchanger is well-insulated so that heat loss to the surroundings is negligible and thus heat transfer from the hot fluid is equal to the heat transfer to the cold fluid. 3 Changes in the kinetic and potential energies of fluid streams are negligible. 4 The thickness of the tube is negligible since it is thin-walled. 5 The overall heat transfer coefficient is constant and uniform.

Properties The specific heats of the water and oil are given to be 4.18 and 2.2 kJ/kg·°C, respectively.

Analysis The heat capacity rates of the hot and cold fluids are

$$C_h = \dot{m}_h c_{ph} = (0.2 \text{ kg/s})(2200 \text{ J/kg}\cdot\text{°C}) = 440 \text{ W/°C}$$

$$C_c = \dot{m}_c c_{pc} = (0.1 \text{ kg/s})(4180 \text{ J/kg}\cdot\text{°C}) = 418 \text{ W/°C}$$

Therefore, $C_{\min} = C_c = 418 \text{ W/°C}$

$$\text{and } c = \frac{C_{\min}}{C_{\max}} = \frac{418}{440} = 0.95$$

Then the maximum heat transfer rate becomes

$$\dot{Q}_{\max} = C_{\min} (T_{h,in} - T_{c,in}) = (418 \text{ W/°C})(160\text{°C} - 18\text{°C}) = 59.36 \text{ kW}$$

The heat transfer surface area is

$$A_s = n(\pi DL) = (12)(\pi)(0.018 \text{ m})(3 \text{ m}) = 2.04 \text{ m}^2$$

The NTU of this heat exchanger is

$$NTU = \frac{UA_s}{C_{\min}} = \frac{(340 \text{ W/m}^2\cdot\text{°C})(2.04 \text{ m}^2)}{418 \text{ W/°C}} = 1.659$$

Then the effectiveness of this heat exchanger corresponding to $c = 0.95$ and $NTU = 1.659$ is determined from Fig. 11-26d to be

$$\varepsilon = 0.61$$

Then the actual rate of heat transfer becomes

$$\dot{Q} = \varepsilon \dot{Q}_{\max} = (0.61)(59.36 \text{ kW}) = \mathbf{36.2 \text{ kW}}$$

Finally, the outlet temperatures of the cold and hot fluid streams are determined to be

$$\dot{Q} = C_c (T_{c,out} - T_{c,in}) \longrightarrow T_{c,out} = T_{c,in} + \frac{\dot{Q}}{C_c} = 18\text{°C} + \frac{36.2 \text{ kW}}{0.418 \text{ kW/°C}} = \mathbf{104.6\text{°C}}$$

$$\dot{Q} = C_h (T_{h,in} - T_{h,out}) \longrightarrow T_{h,out} = T_{h,in} - \frac{\dot{Q}}{C_h} = 160\text{°C} - \frac{36.2 \text{ kW}}{0.44 \text{ kW/°C}} = \mathbf{77.7\text{°C}}$$

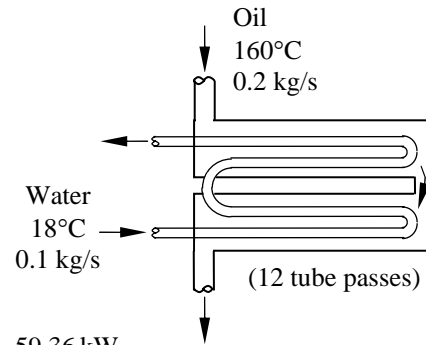

11-94 Inlet and outlet temperatures of the hot and cold fluids in a double-pipe heat exchanger are given. It is to be determined whether this is a parallel-flow or counter-flow heat exchanger and the effectiveness of it.

Analysis This is a counter-flow heat exchanger because in the parallel-flow heat exchangers the outlet temperature of the cold fluid (55°C in this case) cannot exceed the outlet temperature of the hot fluid, which is (45°C in this case). Noting that the mass flow rates of both hot and cold oil streams are the same, we have $C_{\min} = C_{\max}$. Then the effectiveness of this heat exchanger is determined from

$$\varepsilon = \frac{\dot{Q}}{\dot{Q}_{\max}} = \frac{C_h (T_{h,in} - T_{h,out})}{C_{\min} (T_{h,in} - T_{c,in})} = \frac{C_h (T_{h,in} - T_{h,out})}{C_h (T_{h,in} - T_{c,in})} = \frac{80\text{°C} - 45\text{°C}}{80\text{°C} - 20\text{°C}} = \mathbf{0.583}$$

11-95E Inlet and outlet temperatures of the hot and cold fluids in a double-pipe heat exchanger are given. It is to be determined the fluid, which has the smaller heat capacity rate and the effectiveness of the heat exchanger.

Analysis Hot water has the smaller heat capacity rate since it experiences a greater temperature change. The effectiveness of this heat exchanger is determined from

$$\varepsilon = \frac{\dot{Q}}{\dot{Q}_{\max}} = \frac{C_h(T_{h,in} - T_{h,out})}{C_{\min}(T_{h,in} - T_{c,in})} = \frac{C_h(T_{h,in} - T_{h,out})}{C_h(T_{h,in} - T_{c,in})} = \frac{190^\circ\text{F} - 100^\circ\text{F}}{190^\circ\text{F} - 70^\circ\text{F}} = \mathbf{0.75}$$

11-96 A chemical is heated by water in a heat exchanger. The mass flow rates and the inlet temperatures are given. The outlet temperatures of both fluids are to be determined.

Assumptions 1 Steady operating conditions exist. 2 The heat exchanger is well-insulated so that heat loss to the surroundings is negligible and thus heat transfer from the hot fluid is equal to the heat transfer to the cold fluid. 3 Changes in the kinetic and potential energies of fluid streams are negligible. 4 The thickness of the tube is negligible since tube is thin-walled. 5 The overall heat transfer coefficient is constant and uniform.

Properties The specific heats of the water and chemical are given to be 4.18 and 1.8 kJ/kg·°C, respectively.

Analysis The heat capacity rates of the hot and cold fluids are

$$C_h = \dot{m}_h c_{ph} = (2 \text{ kg/s})(4.18 \text{ kJ/kg}\cdot^\circ\text{C}) = 8.36 \text{ kW}/^\circ\text{C}$$

$$C_c = \dot{m}_c c_{pc} = (3 \text{ kg/s})(1.8 \text{ kJ/kg}\cdot^\circ\text{C}) = 5.40 \text{ kW}/^\circ\text{C}$$

Therefore, $C_{\min} = C_c = 5.4 \text{ kW}/^\circ\text{C}$

$$\text{and } c = \frac{C_{\min}}{C_{\max}} = \frac{5.40}{8.36} = 0.646$$

Then the maximum heat transfer rate becomes

$$\dot{Q}_{\max} = C_{\min}(T_{h,in} - T_{c,in}) = (5.4 \text{ kW}/^\circ\text{C})(110^\circ\text{C} - 20^\circ\text{C}) = 486 \text{ kW}$$

The NTU of this heat exchanger is

$$NTU = \frac{UA_s}{C_{\min}} = \frac{(1.2 \text{ kW/m}^2\cdot^\circ\text{C})(7 \text{ m}^2)}{5.4 \text{ kW}/^\circ\text{C}} = 1.556$$

Then the effectiveness of this parallel-flow heat exchanger corresponding to $c = 0.646$ and $NTU = 1.556$ is determined from

$$\varepsilon = \frac{1 - \exp[-NTU(1+c)]}{1+c} = \frac{1 - \exp[-1.556(1+0.646)]}{1+0.646} = 0.56$$

Then the actual rate of heat transfer rate becomes

$$\dot{Q} = \varepsilon \dot{Q}_{\max} = (0.56)(486 \text{ kW}) = 272.2 \text{ kW}$$

Finally, the outlet temperatures of the cold and hot fluid streams are determined to be

$$\dot{Q} = C_c(T_{c,out} - T_{c,in}) \longrightarrow T_{c,out} = T_{c,in} + \frac{\dot{Q}}{C_c} = 20^\circ\text{C} + \frac{272.2 \text{ kW}}{5.4 \text{ kW}/^\circ\text{C}} = \mathbf{70.4^\circ\text{C}}$$

$$\dot{Q} = C_h(T_{h,in} - T_{h,out}) \longrightarrow T_{h,out} = T_{h,in} - \frac{\dot{Q}}{C_h} = 110^\circ\text{C} - \frac{272.2 \text{ kW}}{8.36 \text{ kW}/^\circ\text{C}} = \mathbf{77.4^\circ\text{C}}$$

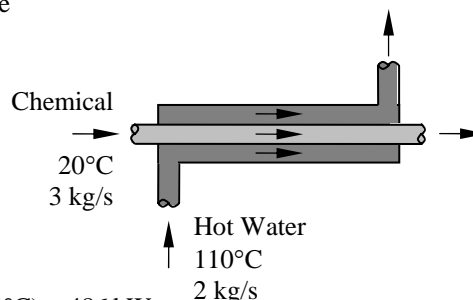

11-97 EES Prob. 11-96 is reconsidered. The effects of the inlet temperatures of the chemical and the water on their outlet temperatures are to be investigated.

Analysis The problem is solved using EES, and the solution is given below.

"GIVEN"

T_chemical_in=20 [C]
 C_p_chemical=1.8 [kJ/kg-C]
 m_dot_chemical=3 [kg/s]
 T_w_in=110 [C]
 m_dot_w=2 [kg/s]
 C_p_w=4.18 [kJ/kg-C]
 A=7 [m^2]
 U=1.2 [kW/m^2-C]

"ANALYSIS"

"With EES, it is easier to solve this problem using LMTD method than NTU method. Below, we use LMTD method. Both methods give the same results."

DELTA_T_1=T_w_in-T_chemical_in
 DELTA_T_2=T_w_out-T_chemical_out
 DELTA_T_lm=(DELTA_T_1-DELTA_T_2)/ln(DELTA_T_1/DELTA_T_2)
 Q_dot=U*A*DELTA_T_lm
 Q_dot=m_dot_chemical*C_p_chemical*(T_chemical_out-T_chemical_in)
 Q_dot=m_dot_w*C_p_w*(T_w_in-T_w_out)

T _{chemical,in} [C]	T _{chemical,out} [C]
10	66.06
12	66.94
14	67.82
16	68.7
18	69.58
20	70.45
22	71.33
24	72.21
26	73.09
28	73.97
30	74.85
32	75.73
34	76.61
36	77.48
38	78.36
40	79.24
42	80.12
44	81
46	81.88
48	82.76
50	83.64

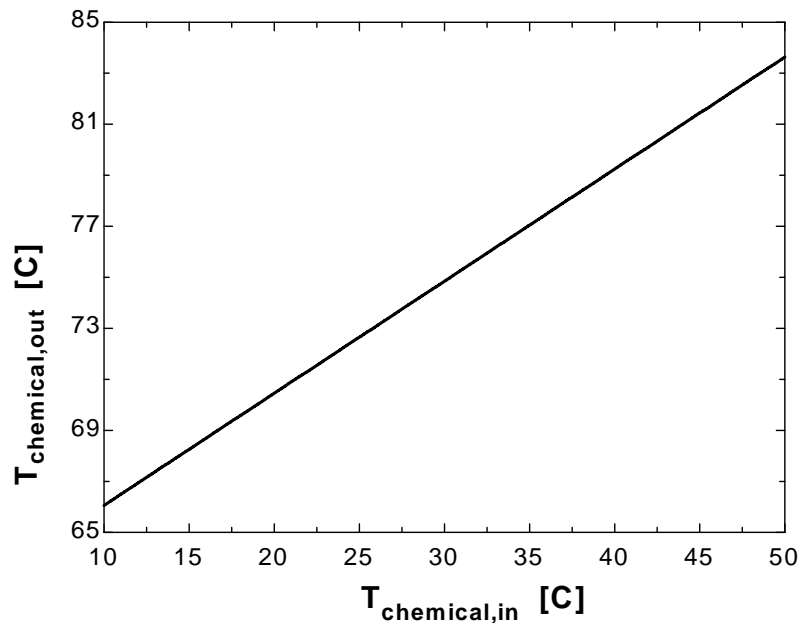

$T_{w,in}$ [C]	$T_{w,out}$ [C]
80	58.27
85	61.46
90	64.65
95	67.84
100	71.03
105	74.22
110	77.41
115	80.6
120	83.79
125	86.98
130	90.17
135	93.36
140	96.55
145	99.74
150	102.9

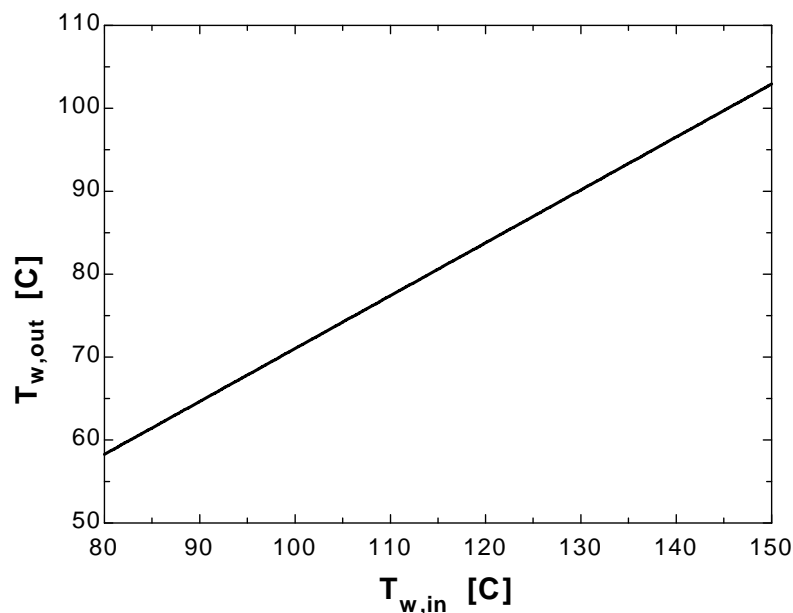

11-98 Water is heated by hot air in a heat exchanger. The mass flow rates and the inlet temperatures are given. The heat transfer surface area of the heat exchanger on the water side is to be determined.

Assumptions 1 Steady operating conditions exist. 2 The heat exchanger is well-insulated so that heat loss to the surroundings is negligible and thus heat transfer from the hot fluid is equal to the heat transfer to the cold fluid. 3 Changes in the kinetic and potential energies of fluid streams are negligible. 4 The overall heat transfer coefficient is constant and uniform.

Properties The specific heats of the water and air are given to be 4.18 and 1.01 kJ/kg·°C, respectively.

Analysis The heat capacity rates of the hot and cold fluids are

$$C_h = \dot{m}_h c_{ph} = (4 \text{ kg/s})(4.18 \text{ kJ/kg}\cdot\text{°C}) = 16.72 \text{ kW/°C}$$

$$C_c = \dot{m}_c c_{pc} = (9 \text{ kg/s})(1.01 \text{ kJ/kg}\cdot\text{°C}) = 9.09 \text{ kW/°C}$$

Therefore, $C_{\min} = C_c = 9.09 \text{ kW/°C}$

and
$$C = \frac{C_{\min}}{C_{\max}} = \frac{9.09}{16.72} = 0.544$$

Then the NTU of this heat exchanger corresponding to $c = 0.544$ and $\varepsilon = 0.65$ is determined from Fig. 11-26 to be

$$\text{NTU} = 1.5$$

Then the surface area of this heat exchanger becomes

$$\text{NTU} = \frac{UA_s}{C_{\min}} \longrightarrow A_s = \frac{\text{NTU } C_{\min}}{U} = \frac{(1.5)(9.09 \text{ kW/°C})}{0.260 \text{ kW/m}^2\cdot\text{°C}} = \mathbf{52.4 \text{ m}^2}$$

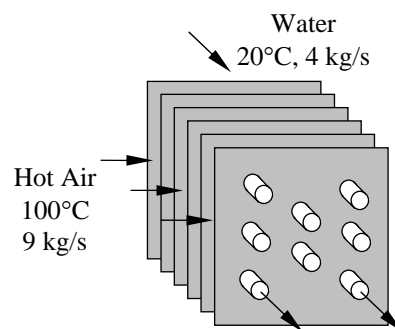

11-99 Water is heated by steam condensing in a condenser. The required length of the tube is to be determined.

Assumptions 1 Steady operating conditions exist. 2 The heat exchanger is well-insulated so that heat loss to the surroundings is negligible and thus heat transfer from the hot fluid is equal to the heat transfer to the cold fluid. 3 Changes in the kinetic and potential energies of fluid streams are negligible. 4 The overall heat transfer coefficient is constant and uniform.

Properties The specific heat of the water is given to be 4.18 kJ/kg·°C. The heat of vaporization of water at 120°C is given to be 2203 kJ/kg.

Analysis (a) The temperature differences between the steam and the water at the two ends of the condenser are

$$\Delta T_1 = T_{h,in} - T_{c,out} = 120^\circ\text{C} - 80^\circ\text{C} = 40^\circ\text{C}$$

$$\Delta T_2 = T_{h,out} - T_{c,in} = 120^\circ\text{C} - 17^\circ\text{C} = 103^\circ\text{C}$$

The logarithmic mean temperature difference is

$$\Delta T_{lm} = \frac{\Delta T_1 - \Delta T_2}{\ln(\Delta T_1 / \Delta T_2)} = \frac{40 - 103}{\ln(40/103)} = 66.6^\circ\text{C}$$

The rate of heat transfer is determined from

$$\dot{Q} = \dot{m}_c c_{pc} (T_{c,out} - T_{c,in}) = (1.8 \text{ kg/s})(4.18 \text{ kJ/kg}\cdot^\circ\text{C})(80^\circ\text{C} - 17^\circ\text{C}) = 474.0 \text{ kW}$$

The surface area of heat transfer is

$$\dot{Q} = UA_s \Delta T_{lm} \longrightarrow A_s = \frac{\dot{Q}}{U \Delta T_{lm}} = \frac{474.0 \text{ kW}}{0.7 \text{ kW/m}^2\cdot^\circ\text{C}(66.6^\circ\text{C})} = 10.17 \text{ m}^2$$

The length of tube required then becomes

$$A_s = \pi DL \longrightarrow L = \frac{A_s}{\pi D} = \frac{10.17 \text{ m}^2}{\pi(0.025 \text{ m})} = \mathbf{129.5 \text{ m}}$$

(b) The maximum rate of heat transfer rate is

$$\dot{Q}_{\max} = C_{\min} (T_{h,in} - T_{c,in}) = (1.8 \text{ kg/s})(4.18 \text{ kJ/kg}\cdot^\circ\text{C})(120^\circ\text{C} - 17^\circ\text{C}) = 775.0 \text{ kW}$$

Then the effectiveness of this heat exchanger becomes

$$\varepsilon = \frac{\dot{Q}}{\dot{Q}_{\max}} = \frac{474 \text{ kW}}{775 \text{ kW}} = 0.612$$

The NTU of this heat exchanger is determined using the relation in Table 11-5 to be

$$\text{NTU} = -\ln(1 - \varepsilon) = -\ln(1 - 0.612) = 0.947$$

The surface area is

$$\text{NTU} = \frac{UA_s}{C_{\min}} \longrightarrow A_s = \frac{\text{NTU} C_{\min}}{U} = \frac{(0.947)(1.8 \text{ kg/s})(4.18 \text{ kJ/kg}\cdot^\circ\text{C})}{0.7 \text{ kW/m}^2\cdot^\circ\text{C}} = 10.18 \text{ m}^2$$

Finally, the length of tube required is

$$A_s = \pi DL \longrightarrow L = \frac{A_s}{\pi D} = \frac{10.18 \text{ m}^2}{\pi(0.025 \text{ m})} = \mathbf{129.6 \text{ m}}$$

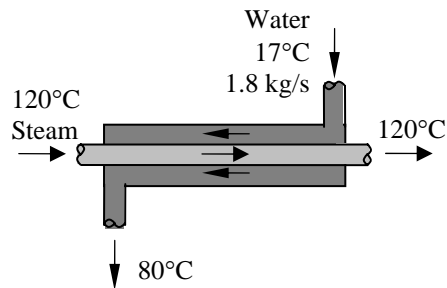

11-100 Ethanol is vaporized by hot oil in a double-pipe parallel-flow heat exchanger. The outlet temperature and the mass flow rate of oil are to be determined using the LMTD and NTU methods.

Assumptions **1** Steady operating conditions exist. **2** The heat exchanger is well-insulated so that heat loss to the surroundings is negligible and thus heat transfer from the hot fluid is equal to the heat transfer to the cold fluid. **3** Changes in the kinetic and potential energies of fluid streams are negligible. **4** The overall heat transfer coefficient is constant and uniform.

Properties The specific heat of oil is given to be 2.2 kJ/kg·°C. The heat of vaporization of ethanol at 78°C is given to be 846 kJ/kg.

Analysis (a) The rate of heat transfer is

$$\dot{Q} = \dot{m}h_{fg} = (0.03 \text{ kg/s})(846 \text{ kJ/kg}) = 25.38 \text{ kW}$$

The log mean temperature difference is

$$\dot{Q} = UA_s \Delta T_{lm} \longrightarrow \Delta T_{lm} = \frac{\dot{Q}}{UA_s} = \frac{25,380 \text{ W}}{(320 \text{ W/m}^2 \cdot \text{°C})(6.2 \text{ m}^2)} = 12.8 \text{ °C}$$

The outlet temperature of the hot fluid can be determined as follows

$$\Delta T_1 = T_{h,in} - T_{c,in} = 120 \text{ °C} - 78 \text{ °C} = 42 \text{ °C}$$

$$\Delta T_2 = T_{h,out} - T_{c,out} = T_{h,out} - 78 \text{ °C}$$

$$\text{and } \Delta T_{lm} = \frac{\Delta T_1 - \Delta T_2}{\ln(\Delta T_1 / \Delta T_2)} = \frac{42 - (T_{h,out} - 78)}{\ln[42 / (T_{h,out} - 78)]} = 12.8 \text{ °C}$$

whose solution is $T_{h,out} = \mathbf{79.8 \text{ °C}}$

Then the mass flow rate of the hot oil becomes

$$\dot{Q} = \dot{m}c_p(T_{h,in} - T_{h,out}) \longrightarrow \dot{m} = \frac{\dot{Q}}{c_p(T_{h,in} - T_{h,out})} = \frac{25,380 \text{ W}}{(2200 \text{ J/kg} \cdot \text{°C})(120 \text{ °C} - 79.8 \text{ °C})} = \mathbf{0.287 \text{ kg/s}}$$

(b) The heat capacity rate $C = \dot{m}c_p$ of a fluid condensing or evaporating in a heat exchanger is infinity, and thus $C = C_{\min} / C_{\max} = 0$.

The effectiveness in this case is determined from $\varepsilon = 1 - e^{-NTU}$

$$\text{where } NTU = \frac{UA_s}{C_{\min}} = \frac{(320 \text{ W/m}^2 \cdot \text{°C})(6.2 \text{ m}^2)}{(\dot{m}, \text{ kg/s})(2200 \text{ J/kg} \cdot \text{°C})}$$

$$\text{and } \dot{Q}_{\max} = C_{\min}(T_{h,in} - T_{c,in})$$

$$\varepsilon = \frac{\dot{Q}}{\dot{Q}_{\max}} = \frac{C_{\min}(T_{h,in} - T_{c,in})}{C_{\min}(T_{h,in} - T_{c,in})} = \frac{120 - T_{h,out}}{120 - 78}$$

$$\dot{Q} = C_h(T_{h,in} - T_{h,out}) = 25,380 \text{ W} \quad (1)$$

$$\dot{Q} = \dot{m} \times 2200(120 - T_{h,out}) = 25,380 \text{ W}$$

$$\text{Also } \frac{120 - T_{h,out}}{120 - 78} = 1 - e^{-\frac{6.2 \times 320}{\dot{m} \times 2200}} \quad (2)$$

Solving (1) and (2) simultaneously gives

$$\dot{m}_h = \mathbf{0.287 \text{ kg/s}} \text{ and } T_{h,out} = \mathbf{79.8 \text{ °C}}$$

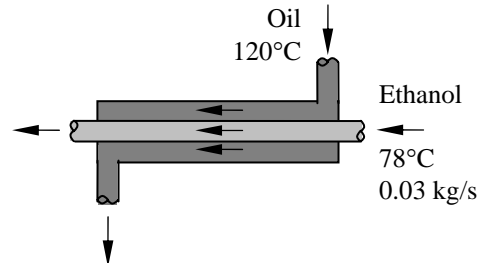

11-101 Water is heated by solar-heated hot air in a heat exchanger. The mass flow rates and the inlet temperatures are given. The outlet temperatures of the water and the air are to be determined.

Assumptions **1** Steady operating conditions exist. **2** The heat exchanger is well-insulated so that heat loss to the surroundings is negligible and thus heat transfer from the hot fluid is equal to the heat transfer to the cold fluid. **3** Changes in the kinetic and potential energies of fluid streams are negligible. **4** The overall heat transfer coefficient is constant and uniform.

Properties The specific heats of the water and air are given to be 4.18 and 1.01 kJ/kg·°C, respectively.

Analysis The heat capacity rates of the hot and cold fluids are

$$C_h = \dot{m}_h c_{ph} = (0.3 \text{ kg/s})(1010 \text{ J/kg}\cdot\text{°C}) = 303 \text{ W/°C}$$

$$C_c = \dot{m}_c c_{pc} = (0.1 \text{ kg/s})(4180 \text{ J/kg}\cdot\text{°C}) = 418 \text{ W/°C}$$

Therefore, $C_{\min} = C_c = 303 \text{ W/°C}$

and $c = \frac{C_{\min}}{C_{\max}} = \frac{303}{418} = 0.725$

Then the maximum heat transfer rate becomes

$$\dot{Q}_{\max} = C_{\min} (T_{h,in} - T_{c,in}) = (303 \text{ W/°C})(90\text{°C} - 22\text{°C}) = 20,604 \text{ kW}$$

The heat transfer surface area is

$$A_s = \pi DL = (\pi)(0.012 \text{ m})(12 \text{ m}) = 0.45 \text{ m}^2$$

Then the NTU of this heat exchanger becomes

$$NTU = \frac{UA_s}{C_{\min}} = \frac{(80 \text{ W/m}^2\cdot\text{°C})(0.45 \text{ m}^2)}{303 \text{ W/°C}} = 0.119$$

The effectiveness of this counter-flow heat exchanger corresponding to $c = 0.725$ and $NTU = 0.119$ is determined using the relation in Table 11-4 to be

$$\varepsilon = \frac{1 - \exp[-NTU(1-c)]}{1 - c \exp[-NTU(1-c)]} = \frac{1 - \exp[-0.119(1-0.725)]}{1 - 0.725 \exp[-0.119(1-0.725)]} = 0.108$$

Then the actual rate of heat transfer becomes

$$\dot{Q} = \varepsilon \dot{Q}_{\max} = (0.108)(20,604 \text{ W}) = 2225.2 \text{ W}$$

Finally, the outlet temperatures of the cold and hot fluid streams are determined to be

$$\dot{Q} = C_c (T_{c,out} - T_{c,in}) \longrightarrow T_{c,out} = T_{c,in} + \frac{\dot{Q}}{C_c} = 22\text{°C} + \frac{2225.2 \text{ W}}{418 \text{ W/°C}} = \mathbf{27.3\text{°C}}$$

$$\dot{Q} = C_h (T_{h,in} - T_{h,out}) \longrightarrow T_{h,out} = T_{h,in} - \frac{\dot{Q}}{C_h} = 90\text{°C} - \frac{2225.2 \text{ W}}{303 \text{ W/°C}} = \mathbf{82.7\text{°C}}$$

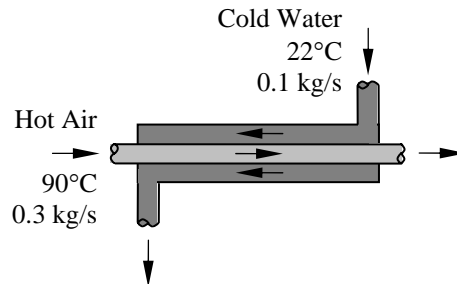

11-102 EES Prob. 11-101 is reconsidered. The effects of the mass flow rate of water and the tube length on the outlet temperatures of water and air are to be investigated.

Analysis The problem is solved using EES, and the solution is given below.

"GIVEN"

T_{air,in}=90 [C]
 m_{dot}_air=0.3 [kg/s]
 C_p_air=1.01 [kJ/kg-C]
 T_{w,in}=22 [C]
 m_{dot}_w=0.1 [kg/s]
 C_p_w=4.18 [kJ/kg-C]
 U=0.080 [kW/m²-C]
 L=12 [m]
 D=0.012 [m]

"ANALYSIS"

"With EES, it is easier to solve this problem using LMTD method than NTU method. Below, we use LMTD method. Both methods give the same results."

DELTA_T_1=T_{air,in}-T_{w,out}

DELTA_T_2=T_{air,out}-T_{w,in}

DELTA_T_lm=(DELTA_T_1-DELTA_T_2)/ln(DELTA_T_1/DELTA_T_2)

A=pi*D*L

Q_{dot}=U*A*DELTA_T_lm

Q_{dot}=m_{dot}_air*C_p_air*(T_{air,in}-T_{air,out})

Q_{dot}=m_{dot}_w*C_p_w*(T_{w,out}-T_{w,in})

m _w [kg/s]	T _{w,out} [C]	T _{air,out} [C]
0.05	32.27	82.92
0.1	27.34	82.64
0.15	25.6	82.54
0.2	24.72	82.49
0.25	24.19	82.46
0.3	23.83	82.44
0.35	23.57	82.43
0.4	23.37	82.42
0.45	23.22	82.41
0.5	23.1	82.4
0.55	23	82.4
0.6	22.92	82.39
0.65	22.85	82.39
0.7	22.79	82.39
0.75	22.74	82.38
0.8	22.69	82.38
0.85	22.65	82.38
0.9	22.61	82.38
0.95	22.58	82.38
1	22.55	82.37

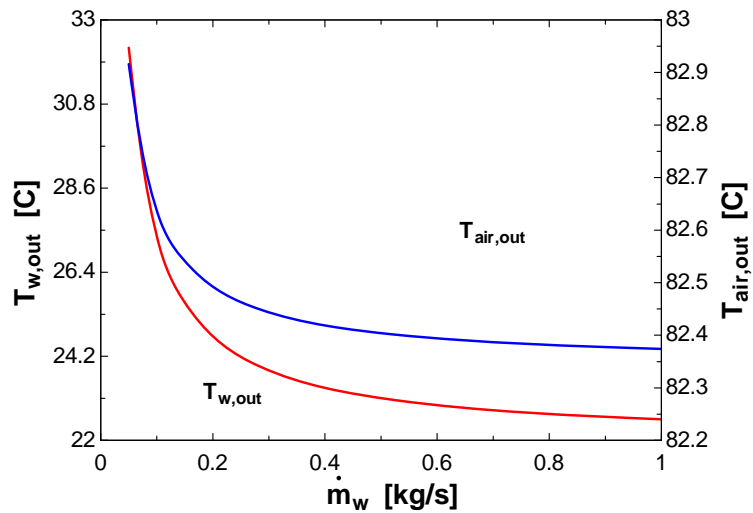

L [m]	T _{w,out} [C]	T _{air,out} [C]
5	24.35	86.76
6	24.8	86.14
7	25.24	85.53
8	25.67	84.93
9	26.1	84.35
10	26.52	83.77
11	26.93	83.2
12	27.34	82.64
13	27.74	82.09
14	28.13	81.54
15	28.52	81.01
16	28.9	80.48
17	29.28	79.96
18	29.65	79.45
19	30.01	78.95
20	30.37	78.45
21	30.73	77.96
22	31.08	77.48
23	31.42	77
24	31.76	76.53
25	32.1	76.07

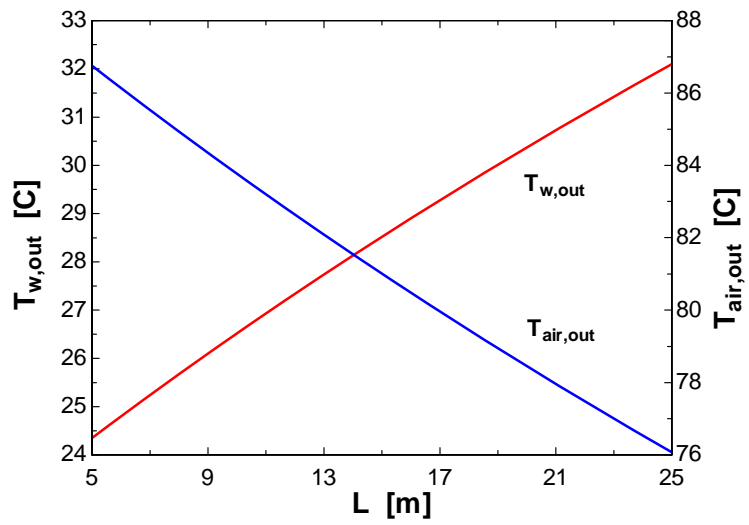

11-103E Oil is cooled by water in a double-pipe heat exchanger. The overall heat transfer coefficient of this heat exchanger is to be determined using both the LMTD and NTU methods.

Assumptions 1 Steady operating conditions exist. 2 The heat exchanger is well-insulated so that heat loss to the surroundings is negligible and thus heat transfer from the hot fluid is equal to the heat transfer to the cold fluid. 3 Changes in the kinetic and potential energies of fluid streams are negligible. 4 The thickness of the tube is negligible since it is thin-walled.

Properties The specific heats of the water and oil are given to be 1.0 and 0.525 Btu/lbm.°F, respectively.

Analysis (a) The rate of heat transfer is

$$\dot{Q} = \dot{m}_h c_{ph} (T_{h,in} - T_{h,out}) = (5 \text{ lbm/s})(0.525 \text{ Btu/lbm.}^\circ\text{F})(300 - 105^\circ\text{F}) = 511.9 \text{ Btu/s}$$

The outlet temperature of the cold fluid is

$$\dot{Q} = \dot{m}_c c_{pc} (T_{c,out} - T_{c,in}) \longrightarrow T_{c,out} = T_{c,in} + \frac{\dot{Q}}{\dot{m}_c c_{pc}} = 70^\circ\text{F} + \frac{511.9 \text{ Btu/s}}{(3 \text{ lbm/s})(1.0 \text{ Btu/lbm.}^\circ\text{F})} = 240.6^\circ\text{F}$$

The temperature differences between the two fluids at the two ends of the heat exchanger are

$$\Delta T_1 = T_{h,in} - T_{c,out} = 300^\circ\text{F} - 240.6^\circ\text{F} = 59.4^\circ\text{F}$$

$$\Delta T_2 = T_{h,out} - T_{c,in} = 105^\circ\text{F} - 70^\circ\text{F} = 35^\circ\text{F}$$

The logarithmic mean temperature difference is

$$\Delta T_{lm} = \frac{\Delta T_1 - \Delta T_2}{\ln(\Delta T_1 / \Delta T_2)} = \frac{59.4 - 35}{\ln(59.4/35)} = 46.1^\circ\text{F}$$

Then the overall heat transfer coefficient becomes

$$\dot{Q} = UA_s \Delta T_{lm} \longrightarrow U = \frac{\dot{Q}}{A_s \Delta T_{lm}} = \frac{511.9 \text{ Btu/s}}{\pi(5/12 \text{ m})(200 \text{ ft})(46.1^\circ\text{F})} = \mathbf{0.0424 \text{ Btu/s.ft}^2 \cdot ^\circ\text{F}}$$

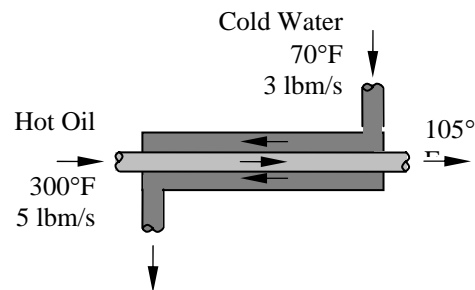

(b) The heat capacity rates of the hot and cold fluids are

$$C_h = \dot{m}_h c_{ph} = (5 \text{ lbm/s})(0.525 \text{ Btu/lbm.}^\circ\text{F}) = 2.625 \text{ Btu/s.}^\circ\text{F}$$

$$C_c = \dot{m}_c c_{pc} = (3 \text{ lbm/s})(1.0 \text{ Btu/lbm.}^\circ\text{F}) = 3.0 \text{ Btu/s.}^\circ\text{F}$$

Therefore, $C_{\min} = C_h = 2.625 \text{ Btu/s.}^\circ\text{F}$ and $c = \frac{C_{\min}}{C_{\max}} = \frac{2.625}{3.0} = 0.875$

Then the maximum heat transfer rate becomes

$$\dot{Q}_{\max} = C_{\min} (T_{h,in} - T_{c,in}) = (2.625 \text{ Btu/s.}^\circ\text{F})(300^\circ\text{F} - 70^\circ\text{F}) = 603.75 \text{ Btu/s}$$

The actual rate of heat transfer and the effectiveness are

$$\dot{Q} = C_h (T_{h,in} - T_{h,out}) = (2.625 \text{ Btu/s.}^\circ\text{F})(300^\circ\text{F} - 105^\circ\text{F}) = 511.9 \text{ Btu/s}$$

$$\varepsilon = \frac{\dot{Q}}{\dot{Q}_{\max}} = \frac{511.9}{603.75} = 0.85$$

The NTU of this heat exchanger is determined using the relation in Table 11-5 to be

$$NTU = \frac{1}{c-1} \ln\left(\frac{\varepsilon-1}{\varepsilon c-1}\right) = \frac{1}{0.875-1} \ln\left(\frac{0.85-1}{0.85 \times 0.875-1}\right) = 4.28$$

The heat transfer surface area of the heat exchanger is

$$A_s = \pi DL = \pi(5/12 \text{ ft})(200 \text{ ft}) = 261.8 \text{ ft}^2$$

and $NTU = \frac{UA_s}{C_{\min}} \longrightarrow U = \frac{NTU C_{\min}}{A_s} = \frac{(4.28)(2.625 \text{ Btu/s.}^\circ\text{F})}{261.8 \text{ ft}^2} = \mathbf{0.0429 \text{ Btu/s.ft}^2 \cdot ^\circ\text{F}}$

11-104 Cold water is heated by hot water in a heat exchanger. The net rate of heat transfer and the heat transfer surface area of the heat exchanger are to be determined.

Assumptions **1** Steady operating conditions exist. **2** The heat exchanger is well-insulated so that heat loss to the surroundings is negligible and thus heat transfer from the hot fluid is equal to the heat transfer to the cold fluid. **3** Changes in the kinetic and potential energies of fluid streams are negligible. **4** The overall heat transfer coefficient is constant and uniform. **5** The thickness of the tube is negligible.

Properties The specific heats of the cold and hot water are given to be 4.18 and 4.19 kJ/kg·°C, respectively.

Analysis The heat capacity rates of the hot and cold fluids are

$$C_h = \dot{m}_h c_{ph} = (0.25 \text{ kg/s})(4180 \text{ J/kg}\cdot^\circ\text{C}) = 1045 \text{ W/}^\circ\text{C}$$

$$C_c = \dot{m}_c c_{pc} = (3 \text{ kg/s})(4190 \text{ J/kg}\cdot^\circ\text{C}) = 12,570 \text{ W/}^\circ\text{C}$$

Therefore, $C_{\min} = C_c = 1045 \text{ W/}^\circ\text{C}$

and
$$c = \frac{C_{\min}}{C_{\max}} = \frac{1045}{12,570} = 0.083$$

Then the maximum heat transfer rate becomes

$$\dot{Q}_{\max} = C_{\min} (T_{h,in} - T_{c,in}) = (1045 \text{ W/}^\circ\text{C})(100^\circ\text{C} - 15^\circ\text{C}) = 88,825 \text{ W}$$

The actual rate of heat transfer is

$$\dot{Q} = C_h (T_{h,in} - T_{h,out}) = (1045 \text{ W/}^\circ\text{C})(45^\circ\text{C} - 15^\circ\text{C}) = \mathbf{31,350 \text{ W}}$$

Then the effectiveness of this heat exchanger becomes

$$\varepsilon = \frac{\dot{Q}}{\dot{Q}_{\max}} = \frac{31,350}{88,825} = 0.35$$

The NTU of this heat exchanger is determined using the relation in Table 11-5 to be

$$NTU = \frac{1}{c-1} \ln\left(\frac{\varepsilon-1}{\varepsilon c-1}\right) = \frac{1}{0.083-1} \ln\left(\frac{0.35-1}{0.35 \times 0.083-1}\right) = 0.438$$

Then the surface area of the heat exchanger is determined from

$$NTU = \frac{UA}{C_{\min}} \longrightarrow A = \frac{NTU C_{\min}}{U} = \frac{(0.438)(1045 \text{ W/}^\circ\text{C})}{950 \text{ W/m}^2\cdot^\circ\text{C}} = \mathbf{0.482 \text{ m}^2}$$

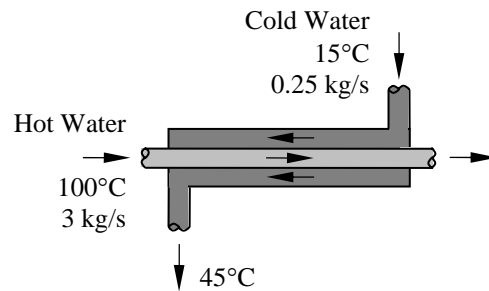

11-105 EES Prob. 11-104 is reconsidered. The effects of the inlet temperature of hot water and the heat transfer coefficient on the rate of heat transfer and the surface area are to be investigated.

Analysis The problem is solved using EES, and the solution is given below.

"GIVEN"

T_cw_in=15 [C]
 T_cw_out=45 [C]
 m_dot_cw=0.25 [kg/s]
 C_p_cw=4.18 [kJ/kg-C]
 T_hw_in=100 [C]
 m_dot_hw=3 [kg/s]
 C_p_hw=4.19 [kJ/kg-C]
 U=0.95 [kW/m²-C]

"ANALYSIS"

"With EES, it is easier to solve this problem using LMTD method than NTU method. Below, we use LMTD method. Both methods give the same results."

DELTA_T_1=T_hw_in-T_cw_out
 DELTA_T_2=T_hw_out-T_cw_in
 DELTA_T_lm=(DELTA_T_1-DELTA_T_2)/ln(DELTA_T_1/DELTA_T_2)
 Q_dot=U*A*DELTA_T_lm
 Q_dot=m_dot_hw*C_p_hw*(T_hw_in-T_hw_out)
 Q_dot=m_dot_cw*C_p_cw*(T_cw_out-T_cw_in)

T _{hw,in} [C]	Q [kW]	A [m ²]
60	31.35	1.25
65	31.35	1.038
70	31.35	0.8903
75	31.35	0.7807
80	31.35	0.6957
85	31.35	0.6279
90	31.35	0.5723
95	31.35	0.5259
100	31.35	0.4865
105	31.35	0.4527
110	31.35	0.4234
115	31.35	0.3976
120	31.35	0.3748

U [kW/m ² -C]	Q [kW]	A [m ²]
0.75	31.35	0.6163
0.8	31.35	0.5778
0.85	31.35	0.5438
0.9	31.35	0.5136
0.95	31.35	0.4865
1	31.35	0.4622
1.05	31.35	0.4402
1.1	31.35	0.4202
1.15	31.35	0.4019
1.2	31.35	0.3852
1.25	31.35	0.3698

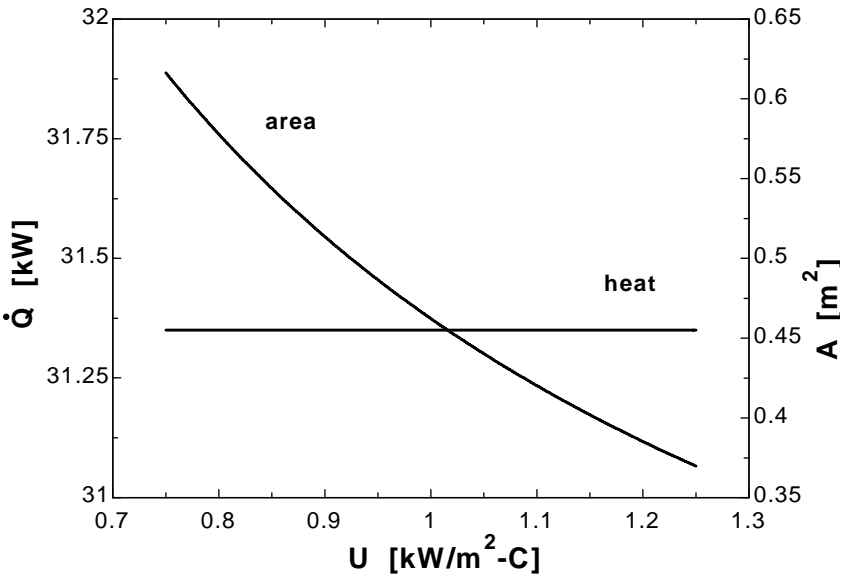
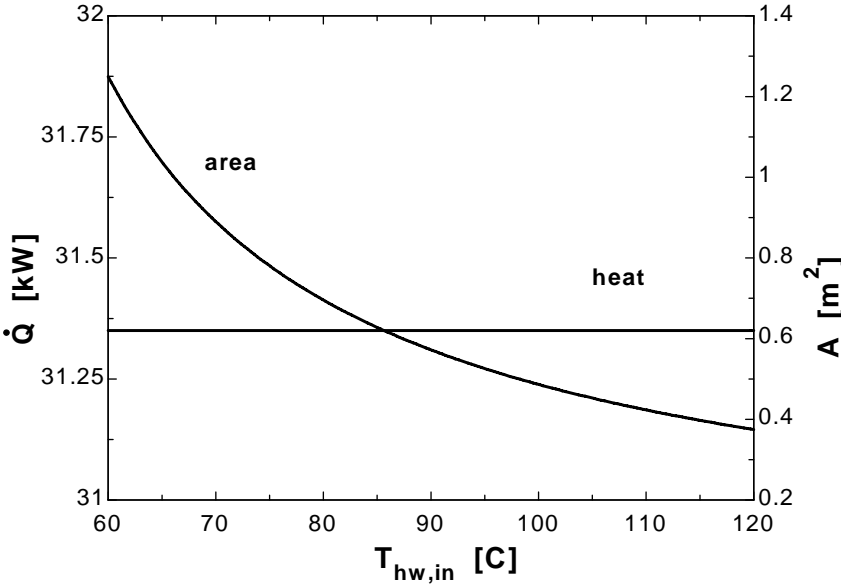

11-106 Glycerin is heated by ethylene glycol in a heat exchanger. Mass flow rates and inlet temperatures are given. The rate of heat transfer and the outlet temperatures are to be determined.

Assumptions 1 Steady operating conditions exist. 2 The heat exchanger is well-insulated so that heat loss to the surroundings is negligible and thus heat transfer from the hot fluid is equal to the heat transfer to the cold fluid. 3 Changes in the kinetic and potential energies of fluid streams are negligible. 4 The overall heat transfer coefficient is constant and uniform. 5 The thickness of the tube is negligible.

Properties The specific heats of the glycerin and ethylene glycol are given to be 2.4 and 2.5 kJ/kg.°C, respectively.

Analysis (a) The heat capacity rates of the hot and cold fluids are

$$C_h = \dot{m}_h c_{ph} = (0.3 \text{ kg/s})(2400 \text{ J/kg}\cdot^\circ\text{C}) = 720 \text{ W}/^\circ\text{C}$$

$$C_c = \dot{m}_c c_{pc} = (0.3 \text{ kg/s})(2500 \text{ J/kg}\cdot^\circ\text{C}) = 750 \text{ W}/^\circ\text{C}$$

Therefore, $C_{\min} = C_h = 720 \text{ W}/^\circ\text{C}$

and $c = \frac{C_{\min}}{C_{\max}} = \frac{720}{750} = 0.96$

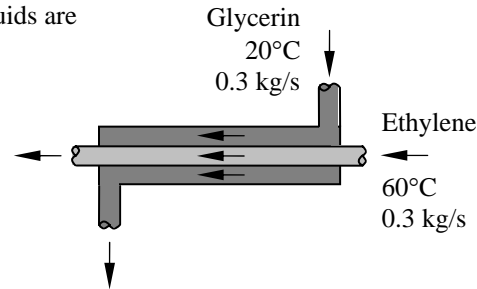

Then the maximum heat transfer rate becomes

$$\dot{Q}_{\max} = C_{\min}(T_{h,in} - T_{c,in}) = (720 \text{ W}/^\circ\text{C})(60^\circ\text{C} - 20^\circ\text{C}) = 28.8 \text{ kW}$$

The NTU of this heat exchanger is

$$NTU = \frac{UA_s}{C_{\min}} = \frac{(380 \text{ W/m}^2\cdot^\circ\text{C})(5.3 \text{ m}^2)}{720 \text{ W}/^\circ\text{C}} = 2.797$$

Effectiveness of this heat exchanger corresponding to $c = 0.96$ and $NTU = 2.797$ is determined using the proper relation in Table 11-4

$$\varepsilon = \frac{1 - \exp[-NTU(1+c)]}{1+c} = \frac{1 - \exp[-2.797(1+0.96)]}{1+0.96} = 0.508$$

Then the actual rate of heat transfer becomes

$$\dot{Q} = \varepsilon \dot{Q}_{\max} = (0.508)(28.8 \text{ kW}) = \mathbf{14.63 \text{ kW}}$$

(b) Finally, the outlet temperatures of the cold and the hot fluid streams are determined from

$$\dot{Q} = C_c(T_{c,out} - T_{c,in}) \longrightarrow T_{c,out} = T_{c,in} + \frac{\dot{Q}}{C_c} = 20^\circ\text{C} + \frac{14.63 \text{ kW}}{0.72 \text{ kW}/^\circ\text{C}} = \mathbf{40.3^\circ\text{C}}$$

$$\dot{Q} = C_h(T_{h,in} - T_{h,out}) \longrightarrow T_{h,out} = T_{h,in} - \frac{\dot{Q}}{C_h} = 60^\circ\text{C} - \frac{14.63 \text{ kW}}{0.75 \text{ kW}/^\circ\text{C}} = \mathbf{40.5^\circ\text{C}}$$

11-107 Water is heated by hot air in a cross-flow heat exchanger. Mass flow rates and inlet temperatures are given. The rate of heat transfer and the outlet temperatures are to be determined.

Assumptions 1 Steady operating conditions exist. 2 The heat exchanger is well-insulated so that heat loss to the surroundings is negligible and thus heat transfer from the hot fluid is equal to the heat transfer to the cold fluid. 3 Changes in the kinetic and potential energies of fluid streams are negligible. 4 The overall heat transfer coefficient is constant and uniform. 5 The thickness of the tube is negligible.

Properties The specific heats of the water and air are given to be 4.18 and 1.01 kJ/kg·°C, respectively.

Analysis The mass flow rates of the hot and the cold fluids are

$$\dot{m}_c = \rho V A_c = (1000 \text{ kg/m}^3)(3 \text{ m/s})[80\pi(0.03 \text{ m})^2/4] = 169.6 \text{ kg/s}$$

$$\rho_{air} = \frac{P}{RT} = \frac{105 \text{ kPa}}{(0.287 \text{ kPa}\cdot\text{m}^3/\text{kg}\cdot\text{K}) \times (130 + 273 \text{ K})} = 0.908 \text{ kg/m}^3$$

$$\dot{m}_h = \rho V A_c = (0.908 \text{ kg/m}^3)(12 \text{ m/s})(1 \text{ m})^2 = 10.90 \text{ kg/s}$$

The heat transfer surface area and the heat capacity rates are

$$A_s = n\pi DL = 80\pi(0.03 \text{ m})(1 \text{ m}) = 7.540 \text{ m}^2$$

$$C_c = \dot{m}_c c_{pc} = (169.6 \text{ kg/s})(4.18 \text{ kJ/kg}\cdot\text{°C}) = 708.9 \text{ kW/°C}$$

$$C_h = \dot{m}_h c_{ph} = (10.9 \text{ kg/s})(1.010 \text{ kJ/kg}\cdot\text{°C}) = 11.01 \text{ kW/°C}$$

$$\text{Therefore, } C_{\min} = C_c = 11.01 \text{ kW/°C} \quad \text{and} \quad c = \frac{C_{\min}}{C_{\max}} = \frac{11.01}{708.9} = 0.01553$$

$$\dot{Q}_{\max} = C_{\min}(T_{h,in} - T_{c,in}) = (11.01 \text{ kW/°C})(130^\circ\text{C} - 18^\circ\text{C}) = 1233 \text{ kW}$$

The NTU of this heat exchanger is

$$NTU = \frac{UA_s}{C_{\min}} = \frac{(130 \text{ W/m}^2\cdot\text{°C})(7.540 \text{ m}^2)}{11,010 \text{ W/°C}} = 0.08903$$

Noting that this heat exchanger involves mixed cross-flow, the fluid with C_{\min} is mixed, C_{\max} unmixed, effectiveness of this heat exchanger corresponding to $c = 0.01553$ and $NTU = 0.08903$ is determined using the proper relation in Table 11-4 to be

$$\varepsilon = 1 - \exp\left[-\frac{1}{c}(1 - e^{-cNTU})\right] = 1 - \exp\left[-\frac{1}{0.01553}(1 - e^{-0.01553 \times 0.08903})\right] = 0.08513$$

Then the actual rate of heat transfer becomes

$$\dot{Q} = \varepsilon \dot{Q}_{\max} = (0.08513)(1233 \text{ kW}) = \mathbf{105.0 \text{ kW}}$$

Finally, the outlet temperatures of the cold and the hot fluid streams are determined from

$$\dot{Q} = C_c(T_{c,out} - T_{c,in}) \longrightarrow T_{c,out} = T_{c,in} + \frac{\dot{Q}}{C_c} = 18^\circ\text{C} + \frac{105.0 \text{ kW}}{708.9 \text{ kW/°C}} = \mathbf{18.15^\circ\text{C}}$$

$$\dot{Q} = C_h(T_{h,in} - T_{h,out}) \longrightarrow T_{h,out} = T_{h,in} - \frac{\dot{Q}}{C_h} = 130^\circ\text{C} - \frac{105.0 \text{ kW}}{11.01 \text{ kW/°C}} = \mathbf{120.5^\circ\text{C}}$$

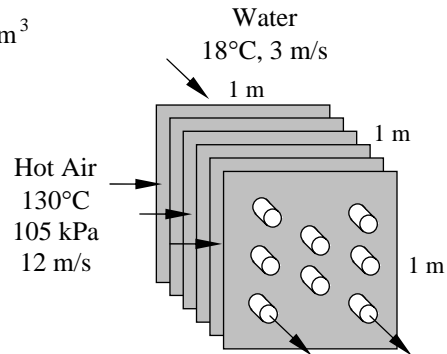

11-108 Ethyl alcohol is heated by water in a shell-and-tube heat exchanger. The heat transfer surface area of the heat exchanger is to be determined using both the LMTD and NTU methods.

Assumptions 1 Steady operating conditions exist. **2** The heat exchanger is well-insulated so that heat loss to the surroundings is negligible and thus heat transfer from the hot fluid is equal to the heat transfer to the cold fluid. **3** Changes in the kinetic and potential energies of fluid streams are negligible. **4** The overall heat transfer coefficient is constant and uniform.

Properties The specific heats of the ethyl alcohol and water are given to be 2.67 and 4.19 kJ/kg·°C, respectively.

Analysis (a) The temperature differences between the two fluids at the two ends of the heat exchanger are

$$\Delta T_1 = T_{h,in} - T_{c,out} = 95^\circ\text{C} - 70^\circ\text{C} = 25^\circ\text{C}$$

$$\Delta T_2 = T_{h,out} - T_{c,in} = 60^\circ\text{C} - 25^\circ\text{C} = 35^\circ\text{C}$$

The logarithmic mean temperature difference and the correction factor are

$$\Delta T_{lm,CF} = \frac{\Delta T_1 - \Delta T_2}{\ln(\Delta T_1 / \Delta T_2)} = \frac{25 - 35}{\ln(25/35)} = 29.7^\circ\text{C}$$

$$\left. \begin{aligned} P &= \frac{t_2 - t_1}{T_1 - t_1} = \frac{70 - 25}{95 - 25} = 0.64 \\ R &= \frac{T_2 - T_1}{t_1 - t_1} = \frac{95 - 60}{70 - 25} = 0.78 \end{aligned} \right\} F = 0.93$$

The rate of heat transfer is determined from

$$\dot{Q} = \dot{m}_c c_{pc} (T_{c,out} - T_{c,in}) = (2.1 \text{ kg/s})(2.67 \text{ kJ/kg}\cdot^\circ\text{C})(70^\circ\text{C} - 25^\circ\text{C}) = 252.3 \text{ kW}$$

The surface area of heat transfer is

$$\dot{Q} = UA_s \Delta T_{lm} \longrightarrow A_s = \frac{\dot{Q}}{UF \Delta T_{lm}} = \frac{252.3 \text{ kW}}{0.8 \text{ kW/m}^2 \cdot ^\circ\text{C}(0.93)(29.7^\circ\text{C})} = \mathbf{11.4 \text{ m}^2}$$

(b) The rate of heat transfer is

$$\dot{Q} = \dot{m}_c c_{pc} (T_{c,out} - T_{c,in}) = (2.1 \text{ kg/s})(2.67 \text{ kJ/kg}\cdot^\circ\text{C})(70^\circ\text{C} - 25^\circ\text{C}) = 252.3 \text{ kW}$$

The mass flow rate of the hot fluid is

$$\dot{Q} = \dot{m}_h c_{ph} (T_{h,in} - T_{h,out}) \longrightarrow \dot{m}_h = \frac{\dot{Q}}{c_{ph} (T_{h,in} - T_{h,out})} = \frac{252.3 \text{ kW}}{(4.19 \text{ kJ/kg}\cdot^\circ\text{C})(95^\circ\text{C} - 60^\circ\text{C})} = 1.72 \text{ kg/s}$$

The heat capacity rates of the hot and the cold fluids are

$$C_h = \dot{m}_h c_{ph} = (1.72 \text{ kg/s})(4.19 \text{ kJ/kg}\cdot^\circ\text{C}) = 7.21 \text{ kW}/^\circ\text{C}$$

$$C_c = \dot{m}_c c_{pc} = (2.1 \text{ kg/s})(2.67 \text{ kJ/kg}\cdot^\circ\text{C}) = 5.61 \text{ kW}/^\circ\text{C}$$

Therefore, $C_{\min} = C_c = 5.61 \text{ W}/^\circ\text{C}$ and $c = \frac{C_{\min}}{C_{\max}} = \frac{5.61}{7.21} = 0.78$

Then the maximum heat transfer rate becomes

$$\dot{Q}_{\max} = C_{\min} (T_{h,in} - T_{c,in}) = (5.61 \text{ W}/^\circ\text{C})(95^\circ\text{C} - 25^\circ\text{C}) = 392.7 \text{ kW}$$

The effectiveness of this heat exchanger is $\varepsilon = \frac{\dot{Q}}{\dot{Q}_{\max}} = \frac{252.3}{392.7} = 0.64$

The NTU of this heat exchanger corresponding to this emissivity and $c = 0.78$ is determined from Fig. 11-26d to be $NTU = 1.7$. Then the surface area of heat exchanger is determined to be

$$NTU = \frac{UA_s}{C_{\min}} \longrightarrow A_s = \frac{NTU C_{\min}}{U} = \frac{(1.7)(5.61 \text{ kW}/^\circ\text{C})}{0.8 \text{ kW/m}^2 \cdot ^\circ\text{C}} = \mathbf{11.9 \text{ m}^2}$$

The small difference between the two results is due to the reading error of the chart.

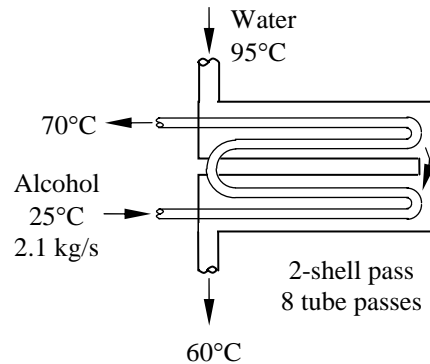

11-109 Steam is condensed by cooling water in a shell-and-tube heat exchanger. The rate of heat transfer and the rate of condensation of steam are to be determined.

Assumptions 1 Steady operating conditions exist. 2 The heat exchanger is well-insulated so that heat loss to the surroundings is negligible and thus heat transfer from the hot fluid is equal to the heat transfer to the cold fluid. 3 Changes in the kinetic and potential energies of fluid streams are negligible. 4 The overall heat transfer coefficient is constant and uniform. 5 The thickness of the tube is negligible.

Properties The specific heat of the water is given to be $4.18 \text{ kJ/kg}\cdot^\circ\text{C}$. The heat of condensation of steam at 30°C is given to be 2430 kJ/kg .

Analysis (a) The heat capacity rate of a fluid condensing in a heat exchanger is infinity. Therefore,

$$C_{\min} = C_c = \dot{m}_c c_{pc} = (0.5 \text{ kg/s})(4.18 \text{ kJ/kg}\cdot^\circ\text{C}) = 2.09 \text{ kW}/^\circ\text{C}$$

and $c = 0$

Then the maximum heat transfer rate becomes

$$\dot{Q}_{\max} = C_{\min} (T_{h,in} - T_{c,in}) = (2.09 \text{ kW}/^\circ\text{C})(30^\circ\text{C} - 15^\circ\text{C}) = 31.35 \text{ kW}$$

and

$$A_s = 8n\pi DL = 8 \times 50\pi(0.015 \text{ m})(2 \text{ m}) = 37.7 \text{ m}^2$$

The NTU of this heat exchanger

$$NTU = \frac{UA_s}{C_{\min}} = \frac{(3 \text{ kW}/\text{m}^2\cdot^\circ\text{C})(37.7 \text{ m}^2)}{2.09 \text{ kW}/^\circ\text{C}} = 54.11$$

Then the effectiveness of this heat exchanger corresponding to $c = 0$ and $NTU = 54.11$ is determined using the proper relation in Table 11-5

$$\varepsilon = 1 - \exp(-NTU) = 1 - \exp(-54.11) = 1$$

Then the actual heat transfer rate becomes

$$\dot{Q} = \varepsilon \dot{Q}_{\max} = (1)(31.35 \text{ kW}) = \mathbf{31.35 \text{ kW}}$$

(b) Finally, the rate of condensation of the steam is determined from

$$\dot{Q} = \dot{m} h_{fg} \longrightarrow \dot{m} = \frac{\dot{Q}}{h_{fg}} = \frac{31.35 \text{ kJ/s}}{2430 \text{ kJ/kg}} = \mathbf{0.0129 \text{ kg/s}}$$

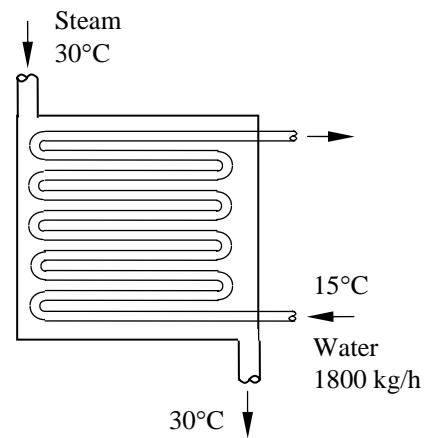

11-110 EES Prob. 11-109 is reconsidered. The effects of the condensing steam temperature and the tube diameter on the rate of heat transfer and the rate of condensation of steam are to be investigated.

Analysis The problem is solved using EES, and the solution is given below.

"GIVEN"

N_pass=8
 N_tube=50
 T_steam=30 [C]
 h_fg_steam=2430 [kJ/kg]
 T_w_in=15 [C]
 m_dot_w=1800/Convert(kg/s, kg/h) [kg/s]
 C_p_w=4.18 [kJ/kg-C]
 D=1.5 [cm]
 L=2 [m]
 U=3 [kW/m^2-C]

"ANALYSIS"

"With EES, it is easier to solve this problem using LMTD method than NTU method. Below, we use NTU method. Both methods give the same results."

C_min=m_dot_w*C_p_w
 c=0 "since the heat capacity rate of a fluid condensing is infinity"
 Q_dot_max=C_min*(T_steam-T_w_in)
 A=N_pass*N_tube*pi*D*L*Convert(cm, m)
 NTU=(U*A)/C_min
 epsilon=1-exp(-NTU) "from Table 11-4 of the text with c=0"
 Q_dot=epsilon*Q_dot_max
 Q_dot=m_dot_cond*h_fg_steam

T _{steam} [C]	Q [kW]	m _{cond} [kg/s]
20	10.45	0.0043
22.5	15.68	0.006451
25	20.9	0.008601
27.5	26.12	0.01075
30	31.35	0.0129
32.5	36.58	0.01505
35	41.8	0.0172
37.5	47.03	0.01935
40	52.25	0.0215
42.5	57.47	0.02365
45	62.7	0.0258
47.5	67.93	0.02795
50	73.15	0.0301
52.5	78.38	0.03225
55	83.6	0.0344
57.5	88.82	0.03655
60	94.05	0.0387
62.5	99.27	0.04085
65	104.5	0.043
67.5	109.7	0.04515
70	114.9	0.0473

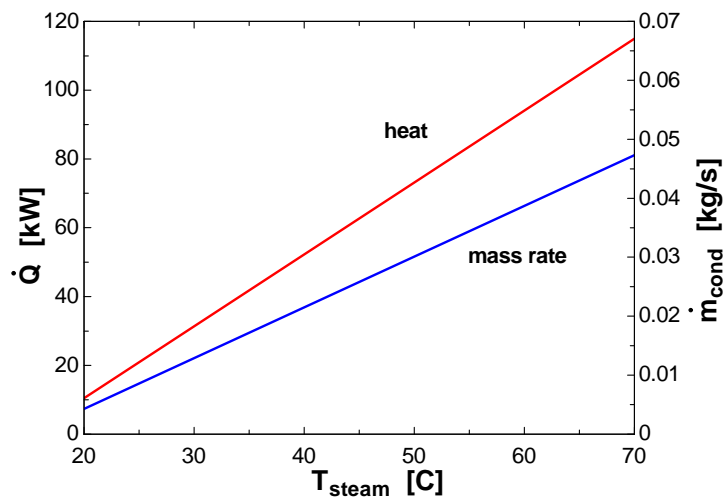

D [cm]	Q [kW]	\dot{m}_{cond} [kg/s]
1	31.35	0.0129
1.05	31.35	0.0129
1.1	31.35	0.0129
1.15	31.35	0.0129
1.2	31.35	0.0129
1.25	31.35	0.0129
1.3	31.35	0.0129
1.35	31.35	0.0129
1.4	31.35	0.0129
1.45	31.35	0.0129
1.5	31.35	0.0129
1.55	31.35	0.0129
1.6	31.35	0.0129
1.65	31.35	0.0129
1.7	31.35	0.0129
1.75	31.35	0.0129
1.8	31.35	0.0129
1.85	31.35	0.0129
1.9	31.35	0.0129
1.95	31.35	0.0129
2	31.35	0.0129

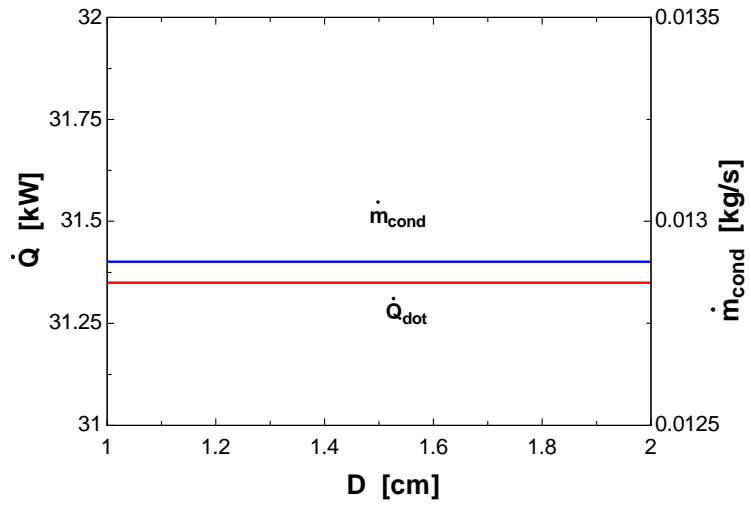

11-111 Cold water is heated by hot oil in a shell-and-tube heat exchanger. The rate of heat transfer is to be determined using both the LMTD and NTU methods.

Assumptions 1 Steady operating conditions exist. 2 The heat exchanger is well-insulated so that heat loss to the surroundings is negligible and thus heat transfer from the hot fluid is equal to the heat transfer to the cold fluid. 3 Changes in the kinetic and potential energies of fluid streams are negligible. 4 The overall heat transfer coefficient is constant and uniform.

Properties The specific heats of the water and oil are given to be 4.18 and 2.2 kJ/kg·°C, respectively.

Analysis (a) The LMTD method in this case involves iterations, which involves the following steps:

- 1) Choose $T_{h,out}$
- 2) Calculate \dot{Q} from $\dot{Q} = \dot{m}_h c_p (T_{h,out} - T_{h,in})$
- 3) Calculate $T_{h,out}$ from $\dot{Q} = \dot{m}_c c_p (T_{h,out} - T_{h,in})$
- 4) Calculate $\Delta T_{lm,CF}$
- 5) Calculate \dot{Q} from $\dot{Q} = UA_s F \Delta T_{lm,CF}$
- 6) Compare to the \dot{Q} calculated at step 2, and repeat until reaching the same result

Result: **651 kW**

(b) The heat capacity rates of the hot and the cold fluids are

$$C_h = \dot{m}_h c_{ph} = (3 \text{ kg/s})(2.2 \text{ kJ/kg} \cdot ^\circ\text{C}) = 6.6 \text{ kW}/^\circ\text{C}$$

$$C_c = \dot{m}_c c_{pc} = (3 \text{ kg/s})(4.18 \text{ kJ/kg} \cdot ^\circ\text{C}) = 12.54 \text{ kW}/^\circ\text{C}$$

$$\text{Therefore, } C_{\min} = C_h = 6.6 \text{ kW}/^\circ\text{C} \quad \text{and} \quad c = \frac{C_{\min}}{C_{\max}} = \frac{6.6}{12.54} = 0.53$$

Then the maximum heat transfer rate becomes

$$\dot{Q}_{\max} = C_{\min} (T_{h,in} - T_{c,in}) = (6.6 \text{ kW}/^\circ\text{C})(200^\circ\text{C} - 14^\circ\text{C}) = 1228 \text{ kW}$$

The NTU of this heat exchanger is

$$NTU = \frac{UA_s}{C_{\min}} = \frac{(0.3 \text{ kW}/\text{m}^2 \cdot ^\circ\text{C})(20 \text{ m}^2)}{6.6 \text{ kW}/^\circ\text{C}} = 0.91$$

Then the effectiveness of this heat exchanger corresponding to $c = 0.53$ and $NTU = 0.91$ is determined from Fig. 11-26d to be

$$\varepsilon = 0.53$$

The actual rate of heat transfer then becomes

$$\dot{Q} = \varepsilon \dot{Q}_{\max} = (0.53)(1228 \text{ kW}) = \mathbf{651 \text{ kW}}$$

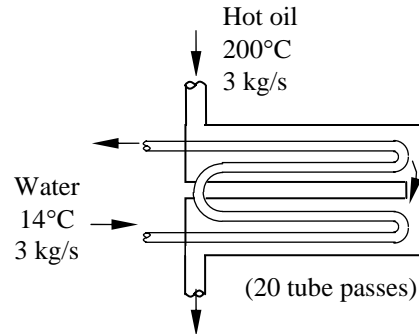

Selection of the Heat Exchangers

11-112C 1) Calculate heat transfer rate, 2) select a suitable type of heat exchanger, 3) select a suitable type of cooling fluid, and its temperature range, 4) calculate or select U , and 5) calculate the size (surface area) of heat exchanger

11-113C The first thing we need to do is determine the life expectancy of the system. Then we need to evaluate how much the larger will save in pumping cost, and compare it to the initial cost difference of the two units. If the larger system saves more than the cost difference in its lifetime, it should be preferred.

11-114C In the case of automotive and aerospace industry, where weight and size considerations are important, and in situations where the space availability is limited, we choose the smaller heat exchanger.

11-115 Oil is to be cooled by water in a heat exchanger. The heat transfer rating of the heat exchanger is to be determined and a suitable type is to be proposed.

Assumptions **1** Steady operating conditions exist. **2** The heat exchanger is well-insulated so that heat loss to the surroundings is negligible and thus heat transfer from the hot fluid is equal to the heat transfer to the cold fluid. **3** Changes in the kinetic and potential energies of fluid streams are negligible.

Properties The specific heat of the oil is given to be $2.2 \text{ kJ/kg}\cdot^\circ\text{C}$.

Analysis The heat transfer rate of this heat exchanger is

$$\dot{Q} = \dot{m}_c c_{pc} (T_{c,out} - T_{c,in}) = (13 \text{ kg/s})(2.2 \text{ kJ/kg}\cdot^\circ\text{C})(120^\circ\text{C} - 50^\circ\text{C}) = \mathbf{2002 \text{ kW}}$$

We propose a compact heat exchanger (like the car radiator) if air cooling is to be used, or a tube-and-shell or plate heat exchanger if water cooling is to be used.

3-116 Water is to be heated by steam in a shell-and-tube process heater. The number of tube passes need to be used is to be determined.

Assumptions 1 Steady operating conditions exist. 2 The heat exchanger is well-insulated so that heat loss to the surroundings is negligible and thus heat transfer from the hot fluid is equal to the heat transfer to the cold fluid. 3 Changes in the kinetic and potential energies of fluid streams are negligible.

Properties The specific heat of the water is given to be 4.19 kJ/kg·°C.

Analysis The mass flow rate of the water is

$$\begin{aligned}\dot{Q} &= \dot{m}_c c_{pc} (T_{c,out} - T_{c,in}) \\ \dot{m} &= \frac{\dot{Q}}{c_{pc} (T_{c,out} - T_{c,in})} \\ &= \frac{600 \text{ kW}}{(4.19 \text{ kJ/kg}\cdot\text{°C})(90\text{°C} - 20\text{°C})} \\ &= 2.046 \text{ kg/s}\end{aligned}$$

The total cross-section area of the tubes corresponding to this mass flow rate is

$$\dot{m} = \rho V A_c \rightarrow A_c = \frac{\dot{m}}{\rho V} = \frac{2.046 \text{ kg/s}}{(1000 \text{ kg/m}^3)(3 \text{ m/s})} = 6.82 \times 10^{-4} \text{ m}^2$$

Then the number of tubes that need to be used becomes

$$A_s = n \frac{\pi D^2}{4} \rightarrow n = \frac{4A_s}{\pi D^2} = \frac{4(6.82 \times 10^{-4} \text{ m}^2)}{\pi(0.01 \text{ m})^2} = 8.68 \cong \mathbf{9}$$

Therefore, we need to use at least 9 tubes entering the heat exchanger.

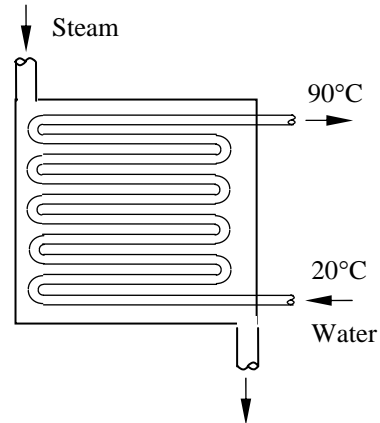

11-117 EES Prob. 11-116 is reconsidered. The number of tube passes as a function of water velocity is to be plotted.

Analysis The problem is solved using EES, and the solution is given below.

"GIVEN"

c_p_w=4.19 [kJ/kg-C]
 T_w_in=20 [C]
 T_w_out=90 [C]
 Q_dot=600 [kW]
 D=0.01 [m]
 Vel=3 [m/s]

"PROPERTIES"

rho=density(water, T=T_ave, P=100)
 T_ave=1/2*(T_w_in+T_w_out)

"ANALYSIS"

Q_dot=m_dot_w*c_p_w*(T_w_out-T_w_in)
 m_dot_w=rho*A_c*Vel
 A_c=N_pass*pi*D^2/4

Vel [m/s]	N _{pass}
1	26.42
1.5	17.62
2	13.21
2.5	10.57
3	8.808
3.5	7.55
4	6.606
4.5	5.872
5	5.285
5.5	4.804
6	4.404
6.5	4.065
7	3.775
7.5	3.523
8	3.303

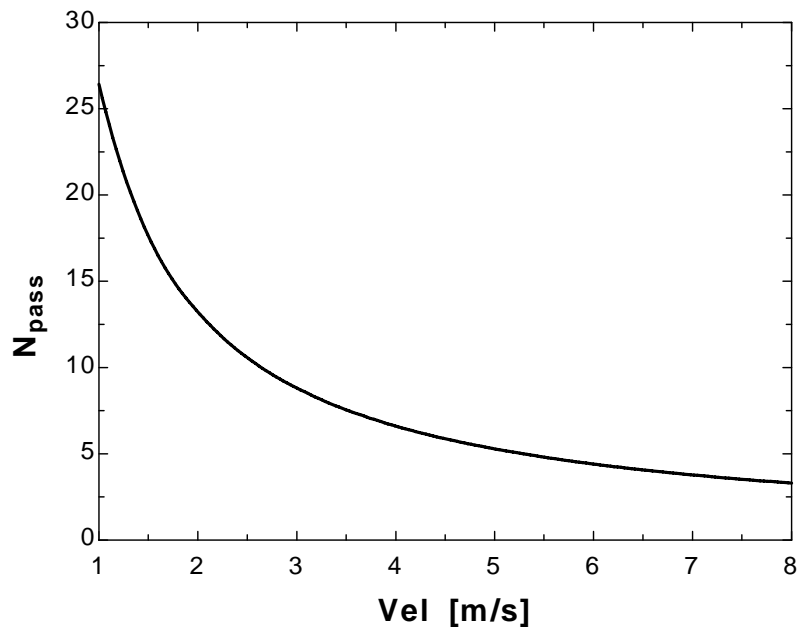

11-118 Cooling water is used to condense the steam in a power plant. The total length of the tubes required in the condenser is to be determined and a suitable HX type is to be proposed.

Assumptions 1 Steady operating conditions exist. 2 The heat exchanger is well-insulated so that heat loss to the surroundings is negligible and thus heat transfer from the hot fluid is equal to the heat transfer to the cold fluid. 3 Changes in the kinetic and potential energies of fluid streams are negligible. 4 The overall heat transfer coefficient is constant and uniform.

Properties The specific heat of the water is given to be 4.18 kJ/kg·°C. The heat of condensation of steam at 30°C is given to be 2431 kJ/kg.

Analysis The temperature differences between the steam and the water at the two ends of condenser are

$$\Delta T_1 = T_{h,in} - T_{c,out} = 30^\circ\text{C} - 26^\circ\text{C} = 4^\circ\text{C}$$

$$\Delta T_2 = T_{h,out} - T_{c,in} = 30^\circ\text{C} - 18^\circ\text{C} = 12^\circ\text{C}$$

and the logarithmic mean temperature difference is

$$\Delta T_{lm} = \frac{\Delta T_1 - \Delta T_2}{\ln(\Delta T_1 / \Delta T_2)} = \frac{4 - 12}{\ln(4/12)} = 7.28^\circ\text{C}$$

The heat transfer surface area is

$$\dot{Q} = UA_s \Delta T_{lm} \longrightarrow A_s = \frac{\dot{Q}}{U \Delta T_{lm}} = \frac{500 \times 10^6 \text{ W}}{(3500 \text{ W/m}^2 \cdot ^\circ\text{C})(7.28^\circ\text{C})} = 1.96 \times 10^4 \text{ m}^2$$

The total length of the tubes required in this condenser then becomes

$$A_s = \pi D L \longrightarrow L = \frac{A_s}{\pi D} = \frac{1.96 \times 10^4 \text{ m}^2}{\pi(0.02 \text{ m})} = 3.123 \times 10^5 \text{ m} = \mathbf{312.3 \text{ km}}$$

A multi-pass shell-and-tube heat exchanger is suitable in this case.

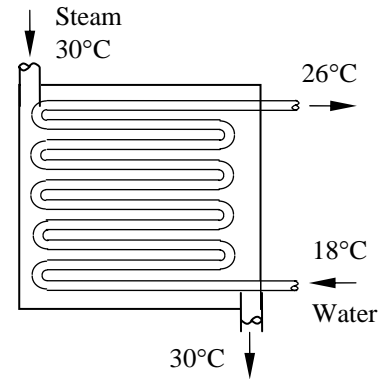

11-119 Cold water is heated by hot water in a heat exchanger. The net rate of heat transfer and the heat transfer surface area of the heat exchanger are to be determined.

Assumptions 1 Steady operating conditions exist. 2 The heat exchanger is well-insulated so that heat loss to the surroundings is negligible and thus heat transfer from the hot fluid is equal to the heat transfer to the cold fluid. 3 Changes in the kinetic and potential energies of fluid streams are negligible. 4 The overall heat transfer coefficient is constant and uniform.

Properties The specific heats of the cold and hot water are given to be 4.18 and 4.19 kJ/kg·°C, respectively.

Analysis The temperature differences between the steam and the water at the two ends of condenser are

$$\Delta T_1 = T_{h,in} - T_{c,out} = 30^\circ\text{C} - 26^\circ\text{C} = 4^\circ\text{C}$$

$$\Delta T_2 = T_{h,out} - T_{c,in} = 30^\circ\text{C} - 18^\circ\text{C} = 12^\circ\text{C}$$

and the logarithmic mean temperature difference is

$$\Delta T_{lm} = \frac{\Delta T_1 - \Delta T_2}{\ln(\Delta T_1 / \Delta T_2)} = \frac{4 - 12}{\ln(4/12)} = 7.28^\circ\text{C}$$

The heat transfer surface area is

$$\dot{Q} = UA_s \Delta T_{lm} \longrightarrow A_s = \frac{\dot{Q}}{U \Delta T_{lm}} = \frac{50 \times 10^6 \text{ W}}{(3500 \text{ W/m}^2 \cdot ^\circ\text{C})(7.28^\circ\text{C})} = 1962 \text{ m}^2$$

The total length of the tubes required in this condenser then becomes

$$A_s = \pi D L \longrightarrow L = \frac{A_s}{\pi D} = \frac{1962 \text{ m}^2}{\pi(0.02 \text{ m})} = 31,231 \text{ m} = \mathbf{31.23 \text{ km}}$$

A multi-pass shell-and-tube heat exchanger is suitable in this case.

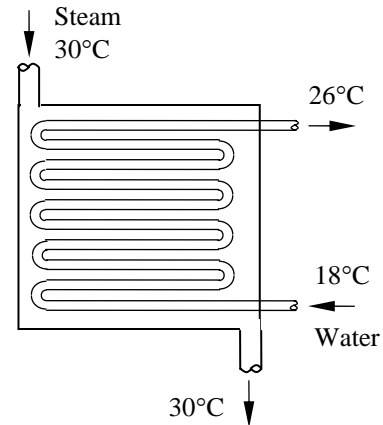

Review Problems

11-120 The inlet conditions of hot and cold fluid streams in a heat exchanger are given. The outlet temperatures of both streams are to be determined using LMTD and the effectiveness-NTU methods.

Assumptions 1 Steady operating conditions exist. **2** The heat exchanger is well-insulated so that heat loss to the surroundings is negligible and thus heat transfer from the hot fluid is equal to the heat transfer to the cold fluid. **3** Changes in the kinetic and potential energies of fluid streams are negligible. **4** Fluid properties are constant.

Properties The specific heats of hot and cold fluid streams are given to be 2.0 and 4.2 kJ/kg·°C, respectively.

Analysis (a) The rate of heat transfer can be expressed as

$$\dot{Q} = \dot{m}c_p(T_{h,in} - T_{h,out}) = (2700 / 3600 \text{ kg/s})(2.0 \text{ kJ/kg}\cdot^\circ\text{C})(120 - T_{h,out}) = 1.5(120 - T_{h,out}) \quad (1)$$

$$\dot{Q} = \dot{m}c_p(T_{c,out} - T_{c,in}) = (1800 / 3600 \text{ kg/s})(4.2 \text{ kJ/kg}\cdot^\circ\text{C})(T_{c,out} - 20) = 2.1(T_{c,out} - 20) \quad (2)$$

The heat transfer can also be expressed using the logarithmic mean temperature difference as

$$\Delta T_1 = T_{h,in} - T_{c,in} = 120^\circ\text{C} - 20^\circ\text{C} = 100^\circ\text{C}$$

$$\Delta T_2 = T_{h,out} - T_{c,out}$$

$$\Delta T_{lm} = \frac{\Delta T_1 - \Delta T_2}{\ln\left(\frac{\Delta T_1}{\Delta T_2}\right)} = \frac{100 - (T_{h,out} - T_{c,out})}{\ln\left(\frac{100}{T_{h,out} - T_{c,out}}\right)}$$

$$\dot{Q} = UA\Delta T_{lm} = \frac{\dot{Q}_{hc,m}}{A\Delta T_{lm}}$$

$$= (2.0 \text{ kW/m}^2 \cdot ^\circ\text{C})(0.50 \text{ m}^2) \frac{100 - (T_{h,out} - T_{c,out})}{\ln\left(\frac{100}{T_{h,out} - T_{c,out}}\right)} = \frac{100 - (T_{h,out} - T_{c,out})}{\ln\left(\frac{100}{T_{h,out} - T_{c,out}}\right)} \quad (3)$$

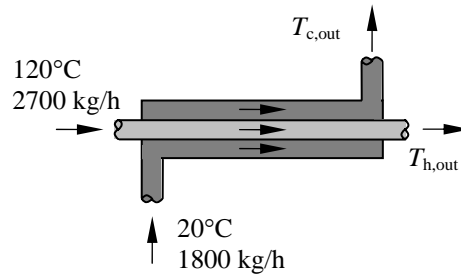

Now we have three expressions for heat transfer with three unknowns: \dot{Q} , $T_{h,out}$, $T_{c,out}$. Solving them using an equation solver such as EES, we obtain

$$\dot{Q} = 59.6 \text{ kW}$$

$$T_{h,out} = 80.3^\circ\text{C}$$

$$T_{c,out} = 48.4^\circ\text{C}$$

(b) The heat capacity rates of the hot and cold fluids are

$$C_h = \dot{m}_h c_{ph} = (2700/3600 \text{ kg/s})(2.0 \text{ kJ/kg}\cdot^\circ\text{C}) = 1.5 \text{ kW}/^\circ\text{C}$$

$$C_c = \dot{m}_c c_{pc} = (1800/3600 \text{ kg/s})(4.2 \text{ kJ/kg}\cdot^\circ\text{C}) = 2.1 \text{ kW}/^\circ\text{C}$$

Therefore

$$C_{\min} = C_h = 1.5 \text{ kW}/^\circ\text{C}$$

which is the smaller of the two heat capacity rates. The heat capacity ratio and the NTU are

$$c = \frac{C_{\min}}{C_{\max}} = \frac{1.5}{2.1} = 0.714$$

$$NTU = \frac{UA}{C_{\min}} = \frac{(2.0 \text{ kW/m}^2 \cdot \text{C})(0.50 \text{ m}^2)}{1.5 \text{ kW/}^\circ\text{C}} = 0.667$$

The effectiveness of this parallel-flow heat exchanger is

$$\varepsilon = \frac{1 - \exp[-NTU(1+c)]}{1+c} = \frac{1 - \exp[-(0.667)(1+0.714)]}{1+0.714} = 0.397$$

The maximum heat transfer rate is

$$\dot{Q}_{\max} = C_{\min}(T_{h,in} - T_{c,in}) = (1.5 \text{ kW/}^\circ\text{C})(120^\circ\text{C} - 20^\circ\text{C}) = 150 \text{ kW}$$

The actual heat transfer rate is

$$\dot{Q} = \varepsilon \dot{Q}_{\max} = (0.397)(150) = 59.6 \text{ kW}$$

Then the outlet temperatures are determined to be

$$\dot{Q} = C_c(T_{c,out} - T_{c,in}) \longrightarrow T_{c,out} = T_{c,in} + \frac{\dot{Q}}{C_c} = 20^\circ\text{C} + \frac{59.6 \text{ kW}}{2.1 \text{ kW/}^\circ\text{C}} = \mathbf{48.4^\circ\text{C}}$$

$$\dot{Q} = C_h(T_{h,in} - T_{h,out}) \longrightarrow T_{h,out} = T_{h,in} - \frac{\dot{Q}}{C_h} = 120^\circ\text{C} - \frac{59.6 \text{ kW}}{1.5 \text{ kW/}^\circ\text{C}} = \mathbf{80.3^\circ\text{C}}$$

Discussion The results obtained by two methods are same as expected. However, the effectiveness-NTU method is easier for this type of problems.

11-121 Water is used to cool a process stream in a shell and tube heat exchanger. The tube length is to be determined for one tube pass and four tube pass cases.

Assumptions 1 Steady operating conditions exist. **2** The heat exchanger is well-insulated so that heat loss to the surroundings is negligible and thus heat transfer from the hot fluid is equal to the heat transfer to the cold fluid. **3** Changes in the kinetic and potential energies of fluid streams are negligible. **4** Fluid properties are constant.

Properties The properties of process stream and water are given in problem statement.

Analysis (a) The rate of heat transfer is

$$\dot{Q} = \dot{m}_h c_h (T_{h,in} - T_{h,out}) = (47 \text{ kg/s})(3.5 \text{ kJ/kg} \cdot ^\circ\text{C})(160 - 100)^\circ\text{C} = 9870 \text{ kW}$$

The outlet temperature of water is determined from

$$\dot{Q} = \dot{m}_c c_c (T_{c,out} - T_{c,in})$$

$$T_{c,out} = T_{c,in} + \frac{\dot{Q}}{\dot{m}_c c_c} = 10^\circ\text{C} + \frac{9870 \text{ kW}}{(66 \text{ kg/s})(4.18 \text{ kJ/kg} \cdot ^\circ\text{C})} = 45.8^\circ\text{C}$$

The logarithmic mean temperature difference is

$$\Delta T_1 = T_{h,in} - T_{c,out} = 160^\circ\text{C} - 45.8^\circ\text{C} = 114.2^\circ\text{C}$$

$$\Delta T_2 = T_{h,out} - T_{c,in} = 100^\circ\text{C} - 10^\circ\text{C} = 90^\circ\text{C}$$

$$\Delta T_{lm} = \frac{\Delta T_1 - \Delta T_2}{\ln\left(\frac{\Delta T_1}{\Delta T_2}\right)} = \frac{114.2 - 90}{\ln\left(\frac{114.2}{90}\right)} = 101.6^\circ\text{C}$$

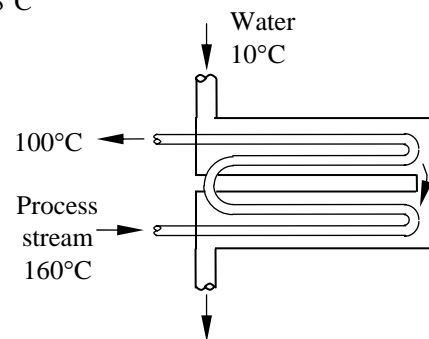

The Reynolds number is

$$V = \frac{\dot{m}}{\rho A} = \frac{\dot{m}}{N_{tube} \rho \pi D^2 / 4} = \frac{(47 \text{ kg/s})}{(100)(950 \text{ kg/m}^3) \pi (0.025 \text{ m})^2 / 4} = 1.008 \text{ m/s}$$

$$\text{Re} = \frac{VD\rho}{\mu} = \frac{(1.008 \text{ m/s})(0.025 \text{ m})(950 \text{ kg/m}^3)}{0.002 \text{ kg/m} \cdot \text{s}} = 11,968$$

which is greater than 10,000. Therefore, we have turbulent flow. We assume fully developed flow and evaluate the Nusselt number from

$$\text{Pr} = \frac{\mu c_p}{k} = \frac{(0.002 \text{ kg/m} \cdot \text{s})(3500 \text{ J/kg} \cdot ^\circ\text{C})}{0.50 \text{ W/m} \cdot ^\circ\text{C}} = 14$$

$$\text{Nu} = \frac{hD}{k} = 0.023 \text{ Re}^{0.8} \text{ Pr}^{0.3} = 0.023(11,968)^{0.8} (14)^{0.3} = 92.9$$

Heat transfer coefficient on the inner surface of the tubes is

$$h_i = \frac{k}{D} \text{Nu} = \frac{0.50 \text{ W/m} \cdot ^\circ\text{C}}{0.025 \text{ m}} (92.9) = 1858 \text{ W/m}^2 \cdot ^\circ\text{C}$$

Disregarding the thermal resistance of the tube wall the overall heat transfer coefficient is determined from

$$U = \frac{1}{\frac{1}{h_i} + \frac{1}{h_o}} = \frac{1}{\frac{1}{1858} + \frac{1}{4000}} = 1269 \text{ W/m}^2 \cdot ^\circ\text{C}$$

The correction factor for one shell pass and one tube pass heat exchanger is $F = 1$. The tube length is determined to be

$$\dot{Q} = UAF\Delta T_{lm}$$

$$9870 \text{ kW} = (1.269 \text{ kW/m}^2 \cdot \text{C})[100\pi(0.025 \text{ m})L](1)(101.6^\circ\text{C})$$

$$L = \mathbf{9.75 \text{ m}}$$

(b) For 1 shell pass and 4 tube passes, there are $100/4=25$ tubes per pass and this will increase the velocity fourfold. We repeat the calculations for this case as follows:

$$V = 4 \times 1.008 = 4.032 \text{ m/s}$$

$$\text{Re} = 4 \times 11,968 = 47,872$$

$$Nu = \frac{hD}{k} = 0.023 \text{ Re}^{0.8} \text{ Pr}^{0.3} = 0.023(47,872)^{0.8} (14)^{0.3} = 281.6$$

$$h_i = \frac{k}{D} Nu = \frac{0.50 \text{ W/m} \cdot ^\circ\text{C}}{0.025 \text{ m}} (281.6) = 5632 \text{ W/m}^2 \cdot ^\circ\text{C}$$

$$U = \frac{1}{\frac{1}{h_i} + \frac{1}{h_o}} = \frac{1}{\frac{1}{5632} + \frac{1}{4000}} = 2339 \text{ W/m}^2 \cdot ^\circ\text{C}$$

The correction factor is determined from Fig. 11-18:

$$\left. \begin{aligned} P &= \frac{t_2 - t_1}{T_1 - t_1} = \frac{100 - 160}{10 - 160} = 0.4 \\ R &= \frac{T_1 - T_2}{t_2 - t_1} = \frac{10 - 45.8}{100 - 160} = 0.60 \end{aligned} \right\} F = 0.96$$

The tube length is determined to be

$$\dot{Q} = UAF\Delta T_{lm}$$

$$9870 \text{ kW} = (2.339 \text{ kW/m}^2 \cdot \text{C})[100\pi(0.025 \text{ m})L](0.96)(101.6^\circ\text{C})$$

$$L = \mathbf{5.51 \text{ m}}$$

11-122 A hydrocarbon stream is heated by a water stream in a 2-shell passes and 4-tube passes heat exchanger. The rate of heat transfer and the mass flow rates of both fluid streams and the fouling factor after usage are to be determined.

Assumptions 1 Steady operating conditions exist. **2** The heat exchanger is well-insulated so that heat loss to the surroundings is negligible and thus heat transfer from the hot fluid is equal to the heat transfer to the cold fluid. **3** Changes in the kinetic and potential energies of fluid streams are negligible. **4** Fluid properties are constant.

Properties The specific heat of HC is given to be 2 kJ/kg·°C. The specific heat of water is taken to be 4.18 kJ/kg·°C.

Analysis (a) The logarithmic mean temperature difference for counter-flow arrangement and the correction factor F are

$$\Delta T_1 = T_{h,in} - T_{c,out} = 80^\circ\text{C} - 50^\circ\text{C} = 30^\circ\text{C}$$

$$\Delta T_2 = T_{h,out} - T_{c,in} = 40^\circ\text{C} - 20^\circ\text{C} = 20^\circ\text{C}$$

$$\Delta T_{lm,CF} = \frac{\Delta T_1 - \Delta T_2}{\ln(\Delta T_1 / \Delta T_2)} = \frac{30 - 20}{\ln(30/20)} = 24.66^\circ\text{C}$$

$$\left. \begin{aligned} P &= \frac{t_2 - t_1}{T_1 - t_1} = \frac{50 - 20}{80 - 20} = 0.5 \\ R &= \frac{T_1 - T_2}{t_2 - t_1} = \frac{80 - 40}{50 - 20} = 1.33 \end{aligned} \right\} F = 0.90 \text{ (Fig. 11-18)}$$

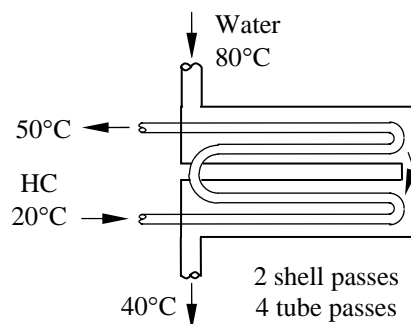

The overall heat transfer coefficient of the heat exchanger is

$$U = \frac{1}{\frac{1}{h_i} + \frac{1}{h_o}} = \frac{1}{\frac{1}{1600} + \frac{1}{2500}} = 975.6 \text{ W/m}^2 \cdot ^\circ\text{C}$$

The rate of heat transfer in this heat exchanger is

$$\dot{Q} = UA_s F \Delta T_{lm,CF} = (975.6 \text{ W/m}^2 \cdot ^\circ\text{C}) [160\pi(0.02 \text{ m})(1.5 \text{ m})] (0.90)(24.66^\circ\text{C}) = 3.265 \times 10^5 \text{ W} = \mathbf{326.5 \text{ kW}}$$

The mass flow rates of fluid streams are

$$\dot{m}_c = \frac{\dot{Q}}{c_p (T_{out} - T_{in})} = \frac{326.5 \text{ kW}}{(2.0 \text{ kJ/kg} \cdot ^\circ\text{C})(50^\circ\text{C} - 20^\circ\text{C})} = \mathbf{5.44 \text{ kg/s}}$$

$$\dot{m}_h = \frac{\dot{Q}}{c_p (T_{in} - T_{out})} = \frac{326.5 \text{ kW}}{(4.18 \text{ kJ/kg} \cdot ^\circ\text{C})(80^\circ\text{C} - 40^\circ\text{C})} = \mathbf{1.95 \text{ kg/s}}$$

(b) The rate of heat transfer in this case is

$$\dot{Q} = [\dot{m} c_p (T_{out} - T_{in})]_c = (5.44 \text{ kg/s})(2.0 \text{ kJ/kg} \cdot ^\circ\text{C})(45^\circ\text{C} - 20^\circ\text{C}) = 272 \text{ kW}$$

This corresponds to a 17% decrease in heat transfer. The outlet temperature of the hot fluid is

$$\begin{aligned} \dot{Q} &= [\dot{m} c_p (T_{in} - T_{out})]_h \\ 272 \text{ kW} &= (1.95 \text{ kg/s})(4.18 \text{ kJ/kg} \cdot ^\circ\text{C})(80^\circ\text{C} - T_{h,out}) \\ T_{h,out} &= 46.6^\circ\text{C} \end{aligned}$$

The logarithmic temperature difference is

$$\Delta T_1 = T_{h,in} - T_{c,out} = 80^\circ\text{C} - 45^\circ\text{C} = 35^\circ\text{C}$$

$$\Delta T_2 = T_{h,out} - T_{c,in} = 46.6^\circ\text{C} - 20^\circ\text{C} = 26.6^\circ\text{C}$$

$$\Delta T_{lm,CF} = \frac{\Delta T_1 - \Delta T_2}{\ln(\Delta T_1 / \Delta T_2)} = \frac{35 - 26.6}{\ln(35 / 26.6)} = 30.61^\circ\text{C}$$

$$\left. \begin{aligned} P &= \frac{t_2 - t_1}{T_1 - t_1} = \frac{45 - 20}{80 - 20} = 0.42 \\ R &= \frac{T_1 - T_2}{t_2 - t_1} = \frac{80 - 46.6}{45 - 20} = 1.34 \end{aligned} \right\} F = 0.97 \text{ (Fig. 11-18)}$$

The overall heat transfer coefficient is

$$\begin{aligned} \dot{Q} &= UA_s F \Delta T_{lm,CF} \\ 272,000 \text{ W} &= U [160\pi(0.02 \text{ m})(1.5 \text{ m})] (0.97)(30.61^\circ\text{C}) \\ U &= 607.5 \text{ W/m}^2 \cdot ^\circ\text{C} \end{aligned}$$

The fouling factor is determined from

$$R_f = \frac{1}{U_{dirty}} - \frac{1}{U_{clean}} = \frac{1}{607.5} - \frac{1}{975.6} = 6.21 \times 10^{-4} \text{ m}^2 \cdot ^\circ\text{C/W}$$

11-123 Hot water is cooled by cold water in a 1-shell pass and 2-tube passes heat exchanger. The mass flow rates of both fluid streams are to be determined.

Assumptions 1 Steady operating conditions exist. 2 The heat exchanger is well-insulated so that heat loss to the surroundings is negligible and thus heat transfer from the hot fluid is equal to the heat transfer to the cold fluid. 3 Changes in the kinetic and potential energies of fluid streams are negligible. 4 Fluid properties are constant. 5 There is no fouling.

Properties The specific heats of both cold and hot water streams are taken to be 4.18 kJ/kg·°C.

Analysis The logarithmic mean temperature difference for counter-flow arrangement and the correction factor F are

$$\Delta T_1 = T_{h,in} - T_{c,out} = 60^\circ\text{C} - 31^\circ\text{C} = 29^\circ\text{C}$$

$$\Delta T_2 = T_{h,out} - T_{c,in} = 36^\circ\text{C} - 7^\circ\text{C} = 29^\circ\text{C}$$

Since $\Delta T_1 = \Delta T_2$, we have $\Delta T_{lm,CF} = 29^\circ\text{C}$

$$\left. \begin{aligned} P &= \frac{t_2 - t_1}{T_1 - t_1} = \frac{31 - 60}{7 - 60} = 0.45 \\ R &= \frac{T_1 - T_2}{t_2 - t_1} = \frac{7 - 31}{36 - 60} = 1.0 \end{aligned} \right\} F = 0.88 \text{ (Fig. 11-18)}$$

The rate of heat transfer in this heat exchanger is

$$\dot{Q} = UA_s F \Delta T_{lm,CF} = (950 \text{ W/m}^2 \cdot ^\circ\text{C})(15 \text{ m}^2)(0.88)(29^\circ\text{C}) = 3.64 \times 10^5 \text{ W} = 364 \text{ kW}$$

The mass flow rates of fluid streams are

$$\dot{m}_c = \frac{\dot{Q}}{c_p(T_{out} - T_{in})} = \frac{364 \text{ kW}}{(4.18 \text{ kJ/kg} \cdot ^\circ\text{C})(60^\circ\text{C} - 36^\circ\text{C})} = 3.63 \text{ kg/s}$$

$$\dot{m}_h = \frac{\dot{Q}}{c_p(T_{in} - T_{out})} = \frac{364 \text{ kW}}{(4.18 \text{ kJ/kg} \cdot ^\circ\text{C})(31^\circ\text{C} - 7^\circ\text{C})} = 3.63 \text{ kg/s}$$

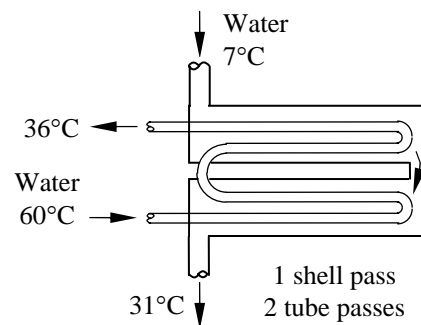

11-124 Hot oil is cooled by water in a multi-pass shell-and-tube heat exchanger. The overall heat transfer coefficient based on the inner surface is to be determined.

Assumptions 1 Water flow is fully developed. **2** Properties of the water are constant.

Properties The properties of water at 25°C are (Table A-9)

$$k = 0.607 \text{ W/m}\cdot\text{°C}$$

$$\nu = \mu / \rho = 0.894 \times 10^{-6} \text{ m}^2/\text{s}$$

$$\text{Pr} = 6.14$$

Analysis The Reynolds number is

$$\text{Re} = \frac{V_{\text{avg}} D}{\nu} = \frac{(3 \text{ m/s})(0.013 \text{ m})}{0.894 \times 10^{-6} \text{ m}^2/\text{s}} = 43,624$$

which is greater than 10,000. Therefore, we assume fully developed turbulent flow, and determine Nusselt number from

$$\text{Nu} = 0.023 \text{Re}^{0.8} \text{Pr}^{0.4} = 0.023(43,624)^{0.8} (6.14)^{0.4} = 245$$

and

$$h_i = \frac{k}{D} \text{Nu} = \frac{0.607 \text{ W/m}\cdot\text{°C}}{0.013 \text{ m}} (245) = 11,440 \text{ W/m}^2\cdot\text{°C}$$

The inner and the outer surface areas of the tube are

$$A_i = \pi D_i L = \pi(0.013 \text{ m})(1 \text{ m}) = 0.04084 \text{ m}^2$$

$$A_o = \pi D_o L = \pi(0.015 \text{ m})(1 \text{ m}) = 0.04712 \text{ m}^2$$

The total thermal resistance of this heat exchanger per unit length is

$$\begin{aligned} R &= \frac{1}{h_i A_i} + \frac{\ln(D_o / D_i)}{2\pi k L} + \frac{1}{h_o A_o} \\ &= \frac{1}{(11,440 \text{ W/m}^2\cdot\text{°C})(0.04084 \text{ m}^2)} + \frac{\ln(1.5/1.3)}{2\pi(110 \text{ W/m}\cdot\text{°C})(1 \text{ m})} + \frac{1}{(35 \text{ W/m}^2\cdot\text{°C})(0.04712 \text{ m}^2)} \\ &= 0.609\text{°C/W} \end{aligned}$$

Then the overall heat transfer coefficient of this heat exchanger based on the inner surface becomes

$$R = \frac{1}{U_i A_i} \rightarrow U_i = \frac{1}{R A_i} = \frac{1}{(0.609\text{°C/W})(0.04084 \text{ m}^2)} = \mathbf{40.2 \text{ W/m}^2\cdot\text{°C}}$$

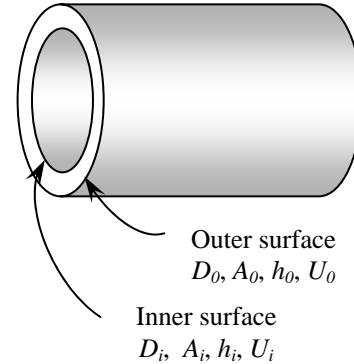

11-125 Hot oil is cooled by water in a multi-pass shell-and-tube heat exchanger. The overall heat transfer coefficient based on the inner surface is to be determined.

Assumptions 1 Water flow is fully developed. **2** Properties of the water are constant.

Properties The properties of water at 25°C are (Table A-9)

$$k = 0.607 \text{ W/m}\cdot\text{°C}$$

$$\nu = \mu / \rho = 0.894 \times 10^{-6} \text{ m}^2/\text{s}$$

$$\text{Pr} = 6.14$$

Analysis The Reynolds number is

$$\text{Re} = \frac{V_{\text{avg}} D}{\nu} = \frac{(3 \text{ m/s})(0.013 \text{ m})}{0.894 \times 10^{-6} \text{ m}^2/\text{s}} = 43,624$$

which is greater than 10,000. Therefore, we assume fully developed turbulent flow, and determine Nusselt number from

$$\text{Nu} = 0.023 \text{Re}^{0.8} \text{Pr}^{0.4} = 0.023(43,624)^{0.8} (6.14)^{0.4} = 245$$

and

$$h_i = \frac{k}{D} \text{Nu} = \frac{0.607 \text{ W/m}\cdot\text{°C}}{0.013 \text{ m}} (245) = 11,440 \text{ W/m}^2\cdot\text{°C}$$

The inner and the outer surface areas of the tube are

$$A_i = \pi D_i L = \pi(0.013 \text{ m})(1 \text{ m}) = 0.04084 \text{ m}^2$$

$$A_o = \pi D_o L = \pi(0.015 \text{ m})(1 \text{ m}) = 0.04712 \text{ m}^2$$

The total thermal resistance of this heat exchanger per unit length of it with a fouling factor is

$$\begin{aligned} R &= \frac{1}{h_i A_i} + \frac{\ln(D_o / D_i)}{2\pi k L} + \frac{R_{f,o}}{A_o} + \frac{1}{h_o A_o} \\ &= \frac{1}{(11,440 \text{ W/m}^2\cdot\text{°C})(0.04084 \text{ m}^2)} + \frac{\ln(1.5/1.3)}{2\pi(110 \text{ W/m}\cdot\text{°C})(1 \text{ m})} \\ &\quad + \frac{0.0004 \text{ m}^2\cdot\text{°C/W}}{0.04712 \text{ m}^2} + \frac{1}{(35 \text{ W/m}^2\cdot\text{°C})(0.04712 \text{ m}^2)} \\ &= 0.617\text{°C/W} \end{aligned}$$

Then the overall heat transfer coefficient of this heat exchanger based on the inner surface becomes

$$R = \frac{1}{U_i A_i} \rightarrow U_i = \frac{1}{R A_i} = \frac{1}{(0.617\text{°C/W})(0.04084 \text{ m}^2)} = 39.7 \text{ W/m}^2\cdot\text{°C}$$

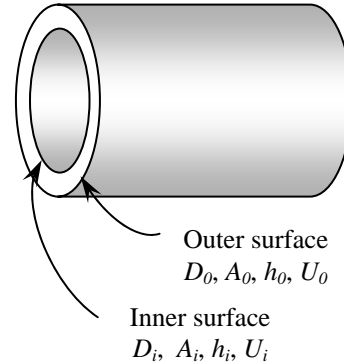

11-126 Water is heated by hot oil in a multi-pass shell-and-tube heat exchanger. The rate of heat transfer and the heat transfer surface area on the outer side of the tube are to be determined.

Assumptions 1 Steady operating conditions exist. 2 The heat exchanger is well-insulated so that heat loss to the surroundings is negligible and thus heat transfer from the hot fluid is equal to the heat transfer to the cold fluid. 3 Changes in the kinetic and potential energies of fluid streams are negligible. 4 The overall heat transfer coefficient is constant and uniform.

Properties The specific heats of the water and oil are given to be 4.18 and 2.2 kJ/kg·°C, respectively.

Analysis (a) The rate of heat transfer in this heat exchanger is

$$\dot{Q} = \dot{m}_h c_{ph} (T_{h,in} - T_{h,out}) = (3 \text{ kg/s})(2.2 \text{ kJ/kg}\cdot^\circ\text{C})(130^\circ\text{C} - 60^\circ\text{C}) = \mathbf{462 \text{ kW}}$$

(b) The outlet temperature of the cold water is

$$\dot{Q} = \dot{m}_c c_{pc} (T_{c,out} - T_{c,in}) \longrightarrow T_{c,out} = T_{c,in} + \frac{\dot{Q}}{\dot{m}_c c_{pc}} = 20^\circ\text{C} + \frac{462 \text{ kW}}{(3 \text{ kg/s})(4.18 \text{ kJ/kg}\cdot^\circ\text{C})} = 56.8^\circ\text{C}$$

The temperature differences at the two ends are

$$\Delta T_1 = T_{h,in} - T_{c,out} = 130^\circ\text{C} - 56.8^\circ\text{C} = 73.2^\circ\text{C}$$

$$\Delta T_2 = T_{h,out} - T_{c,in} = 60^\circ\text{C} - 20^\circ\text{C} = 40^\circ\text{C}$$

The logarithmic mean temperature difference is

$$\Delta T_{lm,CF} = \frac{\Delta T_1 - \Delta T_2}{\ln(\Delta T_1 / \Delta T_2)} = \frac{73.2 - 40}{\ln(73.2 / 40)} = 54.9^\circ\text{C}$$

and

$$\left. \begin{aligned} P &= \frac{t_2 - t_1}{T_1 - t_1} = \frac{56.8 - 20}{130 - 20} = 0.335 \\ R &= \frac{T_2 - T_1}{t_2 - t_1} = \frac{130 - 60}{56.8 - 20} = 1.90 \end{aligned} \right\} F = 0.96$$

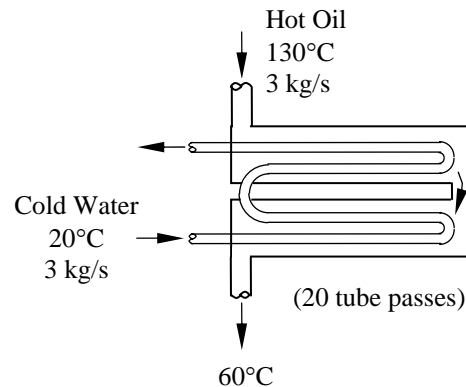

The heat transfer surface area on the outer side of the tube is then determined from

$$\dot{Q} = UA_s F \Delta T_{lm} \longrightarrow A_s = \frac{\dot{Q}}{UF \Delta T_{lm}} = \frac{462 \text{ kW}}{(0.22 \text{ kW/m}^2\cdot^\circ\text{C})(0.96)(54.9^\circ\text{C})} = \mathbf{39.8 \text{ m}^2}$$

11-127E Water is heated by solar-heated hot air in a double-pipe counter-flow heat exchanger. The required length of the tube is to be determined.

Assumptions 1 Steady operating conditions exist. **2** The heat exchanger is well-insulated so that heat loss to the surroundings is negligible and thus heat transfer from the hot fluid is equal to the heat transfer to the cold fluid. **3** Changes in the kinetic and potential energies of fluid streams are negligible. **4** The overall heat transfer coefficient is constant and uniform.

Properties The specific heats of the water and air are given to be 1.0 and 0.24 Btu/lbm.°F, respectively.

Analysis The rate of heat transfer in this heat exchanger is

$$\dot{Q} = \dot{m}_h c_{ph} (T_{h,in} - T_{h,out}) = (0.7 \text{ lbm/s})(0.24 \text{ Btu/lbm.°F})(190^\circ\text{F} - 135^\circ\text{F}) = 9.24 \text{ Btu/s}$$

The outlet temperature of the cold water is

$$\dot{Q} = \dot{m}_c c_{pc} (T_{c,out} - T_{c,in}) \longrightarrow T_{c,out} = T_{c,in} + \frac{\dot{Q}}{\dot{m}_c c_{pc}} = 70^\circ\text{F} + \frac{9.24 \text{ Btu/s}}{(0.35 \text{ lbm/s})(1.0 \text{ Btu/lbm.°F})} = 96.4^\circ\text{F}$$

The temperature differences at the two ends are

$$\Delta T_1 = T_{h,in} - T_{c,out} = 190^\circ\text{F} - 96.4^\circ\text{F} = 93.6^\circ\text{F}$$

$$\Delta T_2 = T_{h,out} - T_{c,in} = 135^\circ\text{F} - 70^\circ\text{F} = 65^\circ\text{F}$$

The logarithmic mean temperature difference is

$$\Delta T_{lm} = \frac{\Delta T_1 - \Delta T_2}{\ln(\Delta T_1 / \Delta T_2)} = \frac{93.6 - 65}{\ln(93.6 / 65)} = 78.43^\circ\text{F}$$

The heat transfer surface area on the outer side of the tube is determined from

$$\dot{Q} = UA_s \Delta T_{lm} \longrightarrow A_s = \frac{\dot{Q}}{U \Delta T_{lm}} = \frac{9.24 \text{ Btu/s}}{(20 / 3600 \text{ Btu/s.ft}^2 \cdot ^\circ\text{F})(78.43^\circ\text{F})} = 21.21 \text{ ft}^2$$

Then the length of the tube required becomes

$$A_s = \pi DL \longrightarrow L = \frac{A_s}{\pi D} = \frac{21.21 \text{ ft}^2}{\pi(0.5 / 12 \text{ ft})} = \mathbf{162.0 \text{ ft}}$$

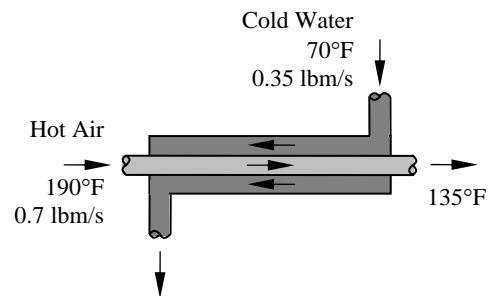

11-128 It is to be shown that when $\Delta T_1 = \Delta T_2$ for a heat exchanger, the ΔT_{lm} relation reduces to $\Delta T_{lm} = \Delta T_1 = \Delta T_2$.

Analysis When $\Delta T_1 = \Delta T_2$, we obtain

$$\Delta T_{lm} = \frac{\Delta T_1 - \Delta T_2}{\ln(\Delta T_1 / \Delta T_2)} = \frac{0}{0}$$

This case can be handled by applying L'Hospital's rule (taking derivatives of nominator and denominator separately with respect to ΔT_1 or ΔT_2). That is,

$$\Delta T_{lm} = \frac{d(\Delta T_1 - \Delta T_2) / d\Delta T_1}{d[\ln(\Delta T_1 / \Delta T_2)] / d\Delta T_1} = \frac{1}{1 / \Delta T_1} = \Delta T_1 = \Delta T_2$$

11-129 Refrigerant-134a is condensed by air in the condenser of a room air conditioner. The heat transfer area on the refrigerant side is to be determined.

Assumptions 1 Steady operating conditions exist. 2 The heat exchanger is well-insulated so that heat loss to the surroundings is negligible and thus heat transfer from the hot fluid is equal to the heat transfer to the cold fluid. 3 Changes in the kinetic and potential energies of fluid streams are negligible. 4 The overall heat transfer coefficient is constant and uniform.

Properties The specific heat of air is given to be 1.005 kJ/kg·°C.

Analysis The temperature differences at the two ends are

$$\Delta T_1 = T_{h,in} - T_{c,out} = 40^\circ\text{C} - 35^\circ\text{C} = 5^\circ\text{C}$$

$$\Delta T_2 = T_{h,out} - T_{c,in} = 40^\circ\text{C} - 25^\circ\text{C} = 15^\circ\text{C}$$

The logarithmic mean temperature difference is

$$\Delta T_{lm} = \frac{\Delta T_1 - \Delta T_2}{\ln(\Delta T_1 / \Delta T_2)} = \frac{5 - 15}{\ln(5 / 15)} = 9.1^\circ\text{C}$$

The heat transfer surface area on the outer side of the tube is determined from

$$\dot{Q} = UA_s \Delta T_{lm} \longrightarrow A_s = \frac{\dot{Q}}{U \Delta T_{lm}} = \frac{(15,000 / 3600) \text{ kW}}{(0.150 \text{ kW/m}^2 \cdot ^\circ\text{C})(9.1^\circ\text{C})} = \mathbf{3.05 \text{ m}^2}$$

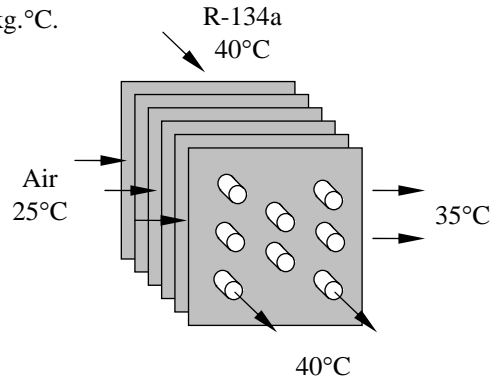

11-130 Air is preheated by hot exhaust gases in a cross-flow heat exchanger. The rate of heat transfer is to be determined.

Assumptions 1 Steady operating conditions exist. 2 The heat exchanger is well-insulated so that heat loss to the surroundings is negligible and thus heat transfer from the hot fluid is equal to the heat transfer to the cold fluid. 3 Changes in the kinetic and potential energies of fluid streams are negligible. 4 The overall heat transfer coefficient is constant and uniform.

Properties The specific heats of air and combustion gases are given to be 1.005 and 1.1 kJ/kg·°C, respectively.

Analysis The rate of heat transfer is simply

$$\dot{Q} = [\dot{m} c_p (T_{in} - T_{out})]_{\text{gas}} = (0.65 \text{ kg/s})(1.1 \text{ kJ/kg} \cdot ^\circ\text{C})(180^\circ\text{C} - 95^\circ\text{C}) = \mathbf{60.8 \text{ kW}}$$

11-131 A water-to-water heat exchanger is proposed to preheat the incoming cold water by the drained hot water in a plant to save energy. The heat transfer rating of the heat exchanger and the amount of money this heat exchanger will save are to be determined.

Assumptions 1 Steady operating conditions exist. 2 The heat exchanger is well-insulated so that heat loss to the surroundings is negligible and thus heat transfer from the hot fluid is equal to the heat transfer to the cold fluid. 3 Changes in the kinetic and potential energies of fluid streams are negligible.

Properties The specific heat of the hot water is given to be $4.18 \text{ kJ/kg}\cdot^\circ\text{C}$.

Analysis The maximum rate of heat transfer is

$$\begin{aligned}\dot{Q}_{\max} &= \dot{m}_h c_{ph} (T_{h,in} - T_{c,in}) \\ &= (8 / 60 \text{ kg/s})(4.18 \text{ kJ/kg}\cdot^\circ\text{C})(60^\circ\text{C} - 14^\circ\text{C}) \\ &= 25.6 \text{ kW}\end{aligned}$$

Noting that the heat exchanger will recover 72% of it, the actual heat transfer rate becomes

$$\dot{Q} = \varepsilon \dot{Q}_{\max} = (0.72)(25.6 \text{ kJ/s}) = 18.43 \text{ kW}$$

which is the heat transfer rating. The operating hours per year are

$$\text{The annual operating hours} = (8 \text{ h/day})(5 \text{ days/week})(52 \text{ week/year}) = 2080 \text{ h/year}$$

The energy saved during the entire year will be

$$\begin{aligned}\text{Energy saved} &= (\text{heat transfer rate})(\text{operating time}) \\ &= (18.43 \text{ kJ/s})(2080 \text{ h/year})(3600 \text{ s/h}) \\ &= 1.38 \times 10^8 \text{ kJ/year}\end{aligned}$$

Then amount of fuel and money saved will be

$$\begin{aligned}\text{Fuel saved} &= \frac{\text{Energy saved}}{\text{Furnace efficiency}} = \frac{1.38 \times 10^8 \text{ kJ/year}}{0.78} \left(\frac{1 \text{ therm}}{105,500 \text{ kJ}} \right) \\ &= 1677 \text{ therms/year}\end{aligned}$$

$$\begin{aligned}\text{Money saved} &= (\text{fuel saved})(\text{the price of fuel}) \\ &= (1677 \text{ therms/year})(\$1.00/\text{therm}) = \mathbf{\$1677/\text{year}}\end{aligned}$$

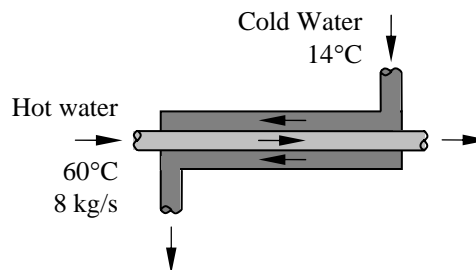

11-132 A shell-and-tube heat exchanger is used to heat water with geothermal steam condensing. The rate of heat transfer, the rate of condensation of steam, and the overall heat transfer coefficient are to be determined.

Assumptions 1 Steady operating conditions exist. 2 The heat exchanger is well-insulated so that heat loss to the surroundings is negligible and thus heat transfer from the hot fluid is equal to the heat transfer to the cold fluid. 3 Changes in the kinetic and potential energies of fluid streams are negligible. 4 Fluid properties are constant.

Properties The heat of vaporization of geothermal water at 120°C is given to be $h_{fg} = 2203 \text{ kJ/kg}$ and specific heat of water is given to be $c_p = 4180 \text{ J/kg}\cdot^\circ\text{C}$.

Analysis (a) The outlet temperature of the water is

$$T_{c,\text{out}} = T_{h,\text{out}} - 46 = 120^\circ\text{C} - 46^\circ\text{C} = 74^\circ\text{C}$$

Then the rate of heat transfer becomes

$$\begin{aligned}\dot{Q} &= [\dot{m}c_p(T_{\text{out}} - T_{\text{in}})]_{\text{water}} \\ &= (3.9 \text{ kg/s})(4.18 \text{ kJ/kg}\cdot^\circ\text{C})(74^\circ\text{C} - 22^\circ\text{C}) \\ &= \mathbf{847.7 \text{ kW}}\end{aligned}$$

(b) The rate of condensation of steam is determined from

$$\begin{aligned}\dot{Q} &= (\dot{m}h_{fg})_{\text{geothermal steam}} \\ 847.7 \text{ kW} &= \dot{m}(2203 \text{ kJ/kg}) \longrightarrow \dot{m} = \mathbf{0.385 \text{ kg/s}}\end{aligned}$$

(c) The heat transfer area is

$$A_i = n\pi D_i L = 14\pi(0.024 \text{ m})(3.2 \text{ m}) = 3.378 \text{ m}^2$$

The logarithmic mean temperature difference for counter-flow arrangement and the correction factor F are

$$\begin{aligned}\Delta T_1 &= T_{h,\text{in}} - T_{c,\text{out}} = 120^\circ\text{C} - 74^\circ\text{C} = 46^\circ\text{C} \\ \Delta T_2 &= T_{h,\text{out}} - T_{c,\text{in}} = 120^\circ\text{C} - 22^\circ\text{C} = 98^\circ\text{C} \\ \Delta T_{\text{lm,CF}} &= \frac{\Delta T_1 - \Delta T_2}{\ln(\Delta T_1 / \Delta T_2)} = \frac{46 - 98}{\ln(46/98)} = 68.8^\circ\text{C}\end{aligned}$$

$$\left. \begin{aligned}P &= \frac{t_2 - t_1}{T_1 - t_1} = \frac{74 - 22}{120 - 22} = 0.53 \\ R &= \frac{T_1 - T_2}{t_2 - t_1} = \frac{120 - 120}{74 - 22} = 0\end{aligned} \right\} F = 1$$

Then the overall heat transfer coefficient is determined to be

$$\dot{Q} = U_i A_i F \Delta T_{\text{lm,CF}} \longrightarrow U_i = \frac{\dot{Q}}{A_i F \Delta T_{\text{lm,CF}}} = \frac{847,700 \text{ W}}{(3.378 \text{ m}^2)(1)(68.8^\circ\text{C})} = \mathbf{3650 \text{ W/m}^2\cdot^\circ\text{C}}$$

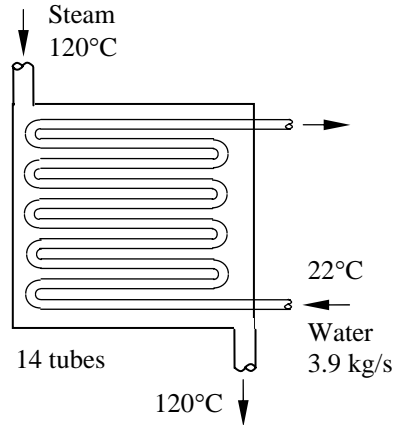

11-133 Water is heated by geothermal water in a double-pipe counter-flow heat exchanger. The mass flow rate of the geothermal water and the outlet temperatures of both fluids are to be determined.

Assumptions 1 Steady operating conditions exist. 2 The heat exchanger is well-insulated so that heat loss to the surroundings is negligible and thus heat transfer from the hot fluid is equal to the heat transfer to the cold fluid. 3 Changes in the kinetic and potential energies of fluid streams are negligible. 4 The overall heat transfer coefficient is constant and uniform.

Properties The specific heats of the geothermal water and the cold water are given to be 4.25 and 4.18 kJ/kg·°C, respectively.

Analysis The heat capacity rates of the hot and cold fluids are

$$C_h = \dot{m}_h c_{ph} = \dot{m}_h (4.25 \text{ kJ/kg} \cdot ^\circ\text{C}) = 4.25 \dot{m}_h$$

$$C_c = \dot{m}_c c_{pc} = (1.2 \text{ kg/s})(4.18 \text{ kJ/kg} \cdot ^\circ\text{C}) = 5.016 \text{ kW}/^\circ\text{C}$$

$$C_{\min} = C_c = 5.016 \text{ kW}/^\circ\text{C}$$

$$\text{and } c = \frac{C_{\min}}{C_{\max}} = \frac{5.016}{4.25 \dot{m}_h} = \frac{1.1802}{\dot{m}_h}$$

The NTU of this heat exchanger is

$$NTU = \frac{UA_s}{C_{\min}} = \frac{(0.480 \text{ kW/m}^2 \cdot ^\circ\text{C})(25 \text{ m}^2)}{5.016 \text{ kW}/^\circ\text{C}} = 2.392$$

Using the effectiveness relation, we find the capacity ratio

$$\varepsilon = \frac{1 - \exp[-NTU(1-c)]}{1 - c \exp[-NTU(1-c)]} \longrightarrow 0.823 = \frac{1 - \exp[-2.392(1-c)]}{1 - c \exp[-2.392(1-c)]} \longrightarrow c = 0.494$$

Then the mass flow rate of geothermal water is determined from

$$c = \frac{1.1802}{\dot{m}_h} \longrightarrow 0.494 = \frac{1.1802}{\dot{m}_h} \longrightarrow \dot{m}_h = \mathbf{2.39 \text{ kg/s}}$$

The maximum heat transfer rate is

$$\dot{Q}_{\max} = C_{\min} (T_{h,\text{in}} - T_{c,\text{in}}) = (5.016 \text{ kW}/^\circ\text{C})(75^\circ\text{C} - 17^\circ\text{C}) = 290.9 \text{ kW}$$

Then the actual rate of heat transfer rate becomes

$$\dot{Q} = \varepsilon \dot{Q}_{\max} = (0.823)(290.9 \text{ kW}) = 239.4 \text{ kW}$$

The outlet temperatures of the geothermal and cold waters are determined to be

$$\dot{Q} = C_c (T_{c,\text{out}} - T_{c,\text{in}}) \longrightarrow 239.4 \text{ kW} = (5.016 \text{ kW}/^\circ\text{C})(T_{c,\text{out}} - 17) \longrightarrow T_{c,\text{out}} = \mathbf{64.7^\circ\text{C}}$$

$$\dot{Q} = \dot{m}_h c_{ph} (T_{h,\text{in}} - T_{h,\text{out}})$$

$$239.4 \text{ kW} = (2.39 \text{ kg/s})(4.25 \text{ kJ/kg} \cdot ^\circ\text{C})(75 - T_{h,\text{out}}) \longrightarrow T_{h,\text{out}} = \mathbf{51.4^\circ\text{C}}$$

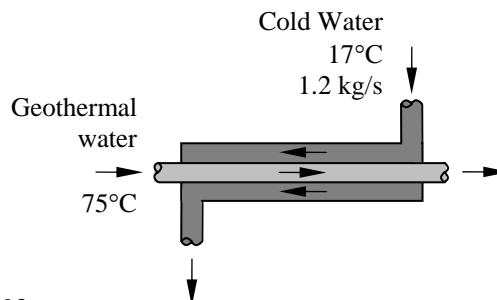

11-134 Air is to be heated by hot oil in a cross-flow heat exchanger with both fluids unmixed. The effectiveness of the heat exchanger, the mass flow rate of the cold fluid, and the rate of heat transfer are to be determined.

Assumptions 1 Steady operating conditions exist. 2 The heat exchanger is well-insulated so that heat loss to the surroundings is negligible and thus heat transfer from the hot fluid is equal to the heat transfer to the cold fluid. 3 Changes in the kinetic and potential energies of fluid streams are negligible. 4 The overall heat transfer coefficient is constant and uniform.

Properties The specific heats of the air and the oil are given to be 1.006 and 2.15 kJ/kg·°C, respectively.

Analysis (a) The heat capacity rates of the hot and cold fluids are

$$C_h = \dot{m}_h c_{ph} = 0.5 \dot{m}_c (2.15 \text{ kJ/kg}\cdot^\circ\text{C}) = 1.075 \dot{m}_c$$

$$C_c = \dot{m}_c c_{pc} = \dot{m}_c (1.006 \text{ kJ/kg}\cdot^\circ\text{C}) = 1.006 \dot{m}_c$$

Therefore, $C_{\min} = C_c = 1.006 \dot{m}_c$

$$\text{and } c = \frac{C_{\min}}{C_{\max}} = \frac{1.006 \dot{m}_c}{1.075 \dot{m}_c} = 0.936$$

The effectiveness of the heat exchanger is determined from

$$\varepsilon = \frac{\dot{Q}}{\dot{Q}_{\max}} = \frac{C_c (T_{c,\text{out}} - T_{c,\text{in}})}{C_c (T_{h,\text{in}} - T_{c,\text{in}})} = \frac{58 - 18}{80 - 18} = \mathbf{0.645}$$

(b) The NTU of this heat exchanger is expressed as

$$NTU = \frac{UA_s}{C_{\min}} = \frac{(0.750 \text{ kW}/^\circ\text{C})}{1.006 \dot{m}_c} = \frac{0.7455}{\dot{m}_c}$$

The NTU of this heat exchanger can also be determined from

$$NTU = -\frac{\ln[c \ln(1 - \varepsilon) + 1]}{c} = -\frac{\ln[0.936 \times \ln(1 - 0.645) + 1]}{0.936} = 3.724$$

Then the mass flow rate of the air is determined to be

$$NTU = \frac{UA_s}{C_{\min}} \longrightarrow 3.724 = \frac{(0.750 \text{ kW}/^\circ\text{C})}{1.006 \dot{m}_c} \longrightarrow \dot{m}_c = \mathbf{0.20 \text{ kg/s}}$$

(c) The rate of heat transfer is determined from

$$\dot{Q} = \dot{m}_c c_{pc} (T_{c,\text{out}} - T_{c,\text{in}}) = (0.20 \text{ kg/s})(1.006 \text{ kJ/kg}\cdot^\circ\text{C})(58 - 18)^\circ\text{C} = \mathbf{8.05 \text{ kW}}$$

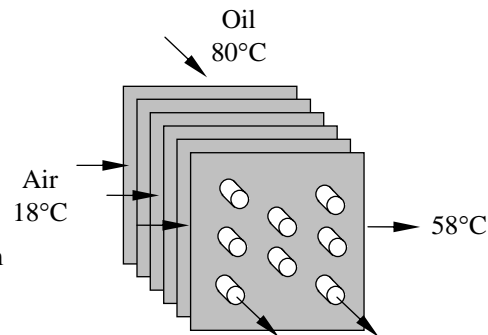

11-135 A water-to-water counter-flow heat exchanger is considered. The outlet temperature of the cold water, the effectiveness of the heat exchanger, the mass flow rate of the cold water, and the heat transfer rate are to be determined.

Assumptions 1 Steady operating conditions exist. 2 The heat exchanger is well-insulated so that heat loss to the surroundings is negligible and thus heat transfer from the hot fluid is equal to the heat transfer to the cold fluid. 3 Changes in the kinetic and potential energies of fluid streams are negligible. 4 The overall heat transfer coefficient is constant and uniform.

Properties The specific heats of both the cold and the hot water are given to be 4.18 kJ/kg·°C.

Analysis (a) The heat capacity rates of the hot and cold fluids are

$$C_h = \dot{m}_h c_{ph} = 1.5 \dot{m}_c (4.18 \text{ kJ/kg}\cdot\text{°C}) = 6.27 \dot{m}_c$$

$$C_c = \dot{m}_c c_{pc} = \dot{m}_c (4.18 \text{ kJ/kg}\cdot\text{°C}) = 4.18 \dot{m}_c$$

Therefore, $C_{\min} = C_c = 4.18 \dot{m}_c$

$$\text{and } C = \frac{C_{\min}}{C_{\max}} = \frac{4.18 \dot{m}_c}{6.27 \dot{m}_c} = 0.667$$

The rate of heat transfer can be expressed as

$$\dot{Q} = C_c (T_{c,\text{out}} - T_{c,\text{in}}) = (4.18 \dot{m}_c) (T_{c,\text{out}} - 20)$$

$$\dot{Q} = C_h (T_{h,\text{in}} - T_{h,\text{out}}) = (6.27 \dot{m}_c) [95 - (T_{c,\text{out}} + 15)] = (6.27 \dot{m}_c) (80 - T_{c,\text{out}})$$

Setting the above two equations equal to each other we obtain the outlet temperature of the cold water

$$\dot{Q} = 4.18 \dot{m}_c (T_{c,\text{out}} - 20) = 6.27 \dot{m}_c (80 - T_{c,\text{out}}) \longrightarrow T_{c,\text{out}} = \mathbf{56^\circ\text{C}}$$

(b) The effectiveness of the heat exchanger is determined from

$$\varepsilon = \frac{\dot{Q}}{\dot{Q}_{\max}} = \frac{C_c (T_{c,\text{out}} - T_{c,\text{in}})}{C_c (T_{h,\text{in}} - T_{c,\text{in}})} = \frac{4.18 \dot{m}_c (56 - 20)}{4.18 \dot{m}_c (95 - 20)} = \mathbf{0.48}$$

(c) The NTU of this heat exchanger is determined from

$$NTU = \frac{1}{c-1} \ln\left(\frac{\varepsilon-1}{\varepsilon c-1}\right) = \frac{1}{0.667-1} \ln\left(\frac{0.48-1}{0.48 \times 0.667-1}\right) = 0.805$$

Then, from the definition of NTU, we obtain the mass flow rate of the cold fluid:

$$NTU = \frac{UA_s}{C_{\min}} \longrightarrow 0.805 = \frac{1.400 \text{ kW}/\text{°C}}{4.18 \dot{m}_c} \longrightarrow \dot{m}_c = \mathbf{0.416 \text{ kg/s}}$$

(d) The rate of heat transfer is determined from

$$\dot{Q} = \dot{m}_c c_{pc} (T_{c,\text{out}} - T_{c,\text{in}}) = (0.416 \text{ kg/s})(4.18 \text{ kJ/kg}\cdot\text{°C})(56 - 20)^\circ\text{C} = \mathbf{62.6 \text{ kW}}$$

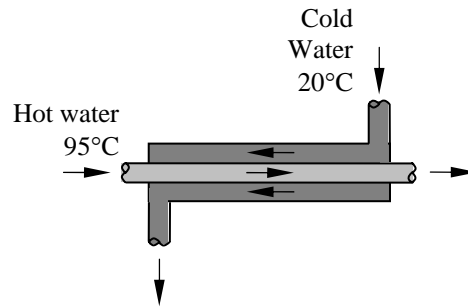

11-136 Oil is cooled by water in a 2-shell passes and 4-tube passes heat exchanger. The mass flow rate of water and the surface area are to be determined.

Assumptions 1 Steady operating conditions exist. 2 The heat exchanger is well-insulated so that heat loss to the surroundings is negligible and thus heat transfer from the hot fluid is equal to the heat transfer to the cold fluid. 3 Changes in the kinetic and potential energies of fluid streams are negligible. 4 Fluid properties are constant. 5 There is no fouling.

Properties The specific heat of oil is given to be $2 \text{ kJ/kg}\cdot^\circ\text{C}$. The specific heat of water is taken to be $4.18 \text{ kJ/kg}\cdot^\circ\text{C}$.

Analysis The logarithmic mean temperature difference for counter-flow arrangement and the correction factor F are

$$\Delta T_1 = T_{h,in} - T_{c,out} = 125^\circ\text{C} - 46^\circ\text{C} = 79^\circ\text{C}$$

$$\Delta T_2 = T_{h,out} - T_{c,in} = 55^\circ\text{C} - 25^\circ\text{C} = 30^\circ\text{C}$$

$$\Delta T_{lm,CF} = \frac{\Delta T_1 - \Delta T_2}{\ln(\Delta T_1 / \Delta T_2)} = \frac{79 - 30}{\ln(79/30)} = 50.61^\circ\text{C}$$

$$\left. \begin{aligned} P &= \frac{t_2 - t_1}{T_1 - t_1} = \frac{55 - 125}{25 - 125} = 0.7 \\ R &= \frac{T_1 - T_2}{t_2 - t_1} = \frac{25 - 46}{55 - 125} = 0.3 \end{aligned} \right\} F = 0.97 \text{ (Fig. 11-18)}$$

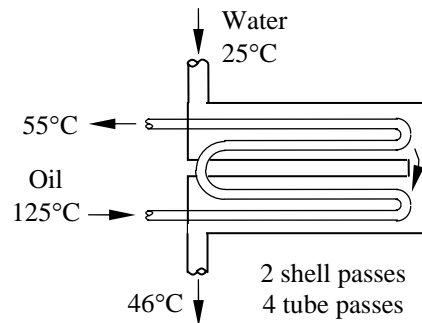

The rate of heat transfer is

$$\dot{Q} = \dot{m}_h c_h (T_{h,in} - T_{h,out}) = (10 \text{ kg/s})(2.0 \text{ kJ/kg}\cdot^\circ\text{C})(125 - 55)^\circ\text{C} = 1400 \text{ kW}$$

The mass flow rate of water is

$$\dot{m}_w = \frac{\dot{Q}}{c_p (T_{out} - T_{in})} = \frac{1400 \text{ kW}}{(4.18 \text{ kJ/kg}\cdot^\circ\text{C})(46^\circ\text{C} - 25^\circ\text{C})} = \mathbf{15.9 \text{ kg/s}}$$

The surface area of the heat exchanger is determined to be

$$\begin{aligned} \dot{Q} &= UAF\Delta T_{lm} \\ 1400 \text{ kW} &= (0.9 \text{ kW/m}^2 \cdot \text{C}) A_s (0.97)(50.61^\circ\text{C}) \\ A_s &= \mathbf{31.7 \text{ m}^2} \end{aligned}$$

11-137 A polymer solution is heated by ethylene glycol in a parallel-flow heat exchanger. The rate of heat transfer, the outlet temperature of polymer solution, and the mass flow rate of ethylene glycol are to be determined.

Assumptions 1 Steady operating conditions exist. 2 The heat exchanger is well-insulated so that heat loss to the surroundings is negligible and thus heat transfer from the hot fluid is equal to the heat transfer to the cold fluid. 3 Changes in the kinetic and potential energies of fluid streams are negligible. 4 Fluid properties are constant. 5 There is no fouling.

Properties The specific heats of polymer and ethylene glycol are given to be 2.0 and 2.5 kJ/kg·°C, respectively.

Analysis (a) The logarithmic mean temperature difference is

$$\Delta T_1 = T_{h,in} - T_{c,in} = 60^\circ\text{C} - 20^\circ\text{C} = 40^\circ\text{C}$$

$$\Delta T_2 = T_{h,out} - T_{c,out} = 15^\circ\text{C}$$

$$\Delta T_{lm,PF} = \frac{\Delta T_1 - \Delta T_2}{\ln(\Delta T_1 / \Delta T_2)} = \frac{40 - 15}{\ln(40/15)} = 25.49^\circ\text{C}$$

The rate of heat transfer in this heat exchanger is

$$\dot{Q} = UA_s \Delta T_{lm} = (240 \text{ W/m}^2 \cdot ^\circ\text{C})(0.8 \text{ m}^2)(25.49^\circ\text{C}) = \mathbf{4894 \text{ W}}$$

(b) The outlet temperatures of both fluids are

$$\dot{Q} = \dot{m}_c c_c (T_{c,out} - T_{c,in}) \rightarrow T_{c,out} = T_{c,in} + \frac{\dot{Q}}{\dot{m}_c c_c} = 20^\circ\text{C} + \frac{4894 \text{ W}}{(0.3 \text{ kg/s})(2000 \text{ J/kg} \cdot ^\circ\text{C})} = 28.2^\circ\text{C}$$

$$T_{h,out} = \Delta T_{out} + T_{c,out} = 15^\circ\text{C} + 28.2^\circ\text{C} = \mathbf{43.2^\circ\text{C}}$$

(c) The mass flow rate of ethylene glycol is determined from

$$\dot{m}_{ethylene} = \frac{\dot{Q}}{c_p (T_{out} - T_{in})} = \frac{4894 \text{ W}}{(2500 \text{ kJ/kg} \cdot ^\circ\text{C})(60^\circ\text{C} - 43.2^\circ\text{C})} = \mathbf{0.117 \text{ kg/s}}$$

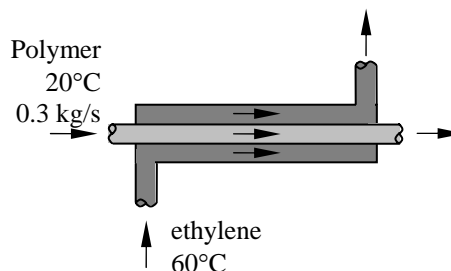

11-138 The inlet and exit temperatures and the volume flow rates of hot and cold fluids in a heat exchanger are given. The rate of heat transfer to the cold water, the overall heat transfer coefficient, the fraction of heat loss, the heat transfer efficiency, the effectiveness, and the NTU of the heat exchanger are to be determined.

Assumptions 1 Steady operating conditions exist. **2** Changes in the kinetic and potential energies of fluid streams are negligible. **3** Fluid properties are constant.

Properties The densities of hot water and cold water at the average temperatures of $(38.9+27.0)/2 = 33.0^\circ\text{C}$ and $(14.3+19.8)/2 = 17.1^\circ\text{C}$ are 994.8 and 998.6 kg/m^3 , respectively. The specific heat at the average temperature is 4178 $\text{J}/\text{kg}\cdot^\circ\text{C}$ for hot water and 4184 $\text{J}/\text{kg}\cdot^\circ\text{C}$ for cold water (Table A-9).

Analysis (a) The mass flow rates are

$$\dot{m}_h = \rho_h \dot{V}_h = (994.8 \text{ kg}/\text{m}^3)(0.0025/60 \text{ m}^3/\text{s}) = 0.04145 \text{ kg}/\text{s}$$

$$\dot{m}_c = \rho_c \dot{V}_c = (998.6 \text{ kg}/\text{m}^3)(0.0045/60 \text{ m}^3/\text{s}) = 0.07490 \text{ kg}/\text{s}$$

The rates of heat transfer from the hot water and to the cold water are

$$\dot{Q}_h = [\dot{m}c_p(T_{in} - T_{out})]_h = (0.04145 \text{ kg}/\text{s})(4178 \text{ kJ}/\text{kg}\cdot^\circ\text{C})(38.9^\circ\text{C} - 27.0^\circ\text{C}) = 2061 \text{ W}$$

$$\dot{Q}_c = [\dot{m}c_p(T_{out} - T_{in})]_c = (0.07490 \text{ kg}/\text{s})(4184 \text{ kJ}/\text{kg}\cdot^\circ\text{C})(19.8^\circ\text{C} - 14.3^\circ\text{C}) = \mathbf{1724 \text{ W}}$$

(b) The logarithmic mean temperature difference and the overall heat transfer coefficient are

$$\Delta T_1 = T_{h,in} - T_{c,out} = 38.9^\circ\text{C} - 19.8^\circ\text{C} = 19.1^\circ\text{C}$$

$$\Delta T_2 = T_{h,out} - T_{c,in} = 27.0^\circ\text{C} - 14.3^\circ\text{C} = 12.7^\circ\text{C}$$

$$\Delta T_{lm} = \frac{\Delta T_1 - \Delta T_2}{\ln\left(\frac{\Delta T_1}{\Delta T_2}\right)} = \frac{19.1 - 12.7}{\ln\left(\frac{19.1}{12.7}\right)} = 15.68^\circ\text{C}$$

$$U = \frac{\dot{Q}_{hc,m}}{A\Delta T_{lm}} = \frac{(1724 + 2061) / 2 \text{ W}}{(0.04 \text{ m}^2)(15.68^\circ\text{C})} = \mathbf{3017 \text{ W}/\text{m}^2 \cdot \text{C}}$$

Note that we used the average of two heat transfer rates in calculations.

(c) The fraction of heat loss and the heat transfer efficiency are

$$f_{loss} = \frac{\dot{Q}_h - \dot{Q}_c}{\dot{Q}_h} = \frac{2061 - 1724}{2061} = 0.164 = \mathbf{16.4\%}$$

$$\eta = \frac{\dot{Q}_c}{\dot{Q}_h} = \frac{1724}{2061} = 0.836 = \mathbf{83.6\%}$$

(d) The heat capacity rates of the hot and cold fluids are

$$C_h = \dot{m}_h c_{ph} = (0.04145 \text{ kg}/\text{s})(4178 \text{ kJ}/\text{kg}\cdot^\circ\text{C}) = 173.2 \text{ W}/^\circ\text{C}$$

$$C_c = \dot{m}_c c_{pc} = (0.07490 \text{ kg}/\text{s})(4184 \text{ kJ}/\text{kg}\cdot^\circ\text{C}) = 313.4 \text{ W}/^\circ\text{C}$$

Therefore

$$C_{min} = C_h = 173.2 \text{ W}/^\circ\text{C}$$

which is the smaller of the two heat capacity rates. Then the maximum heat transfer rate becomes

$$\dot{Q}_{max} = C_{min}(T_{h,in} - T_{c,in}) = (173.2 \text{ W}/^\circ\text{C})(38.9^\circ\text{C} - 14.3^\circ\text{C}) = 4261 \text{ W}$$

The effectiveness of the heat exchanger is

$$\varepsilon = \frac{\dot{Q}}{\dot{Q}_{max}} = \frac{(1724 + 2061) / 2 \text{ kW}}{4261 \text{ kW}} = 0.444 = \mathbf{44.4\%}$$

One again we used the average heat transfer rate. We could have used the smaller or greater heat transfer rates in calculations. The NTU of the heat exchanger is determined from

$$NTU = \frac{UA}{C_{min}} = \frac{(3017 \text{ W}/\text{m}^2 \cdot \text{C})(0.04 \text{ m}^2)}{173.2 \text{ W}/^\circ\text{C}} = \mathbf{0.697}$$

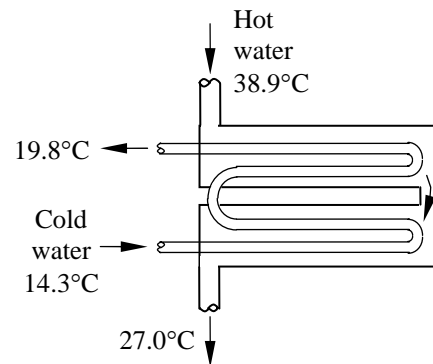

Fundamentals of Engineering (FE) Exam Problems

11-139 Hot water coming from the engine is to be cooled by ambient air in a car radiator. The aluminum tubes in which the water flows have a diameter of 4 cm and negligible thickness. Fins are attached on the outer surface of the tubes in order to increase the heat transfer surface area on the air side. The heat transfer coefficients on the inner and outer surfaces are 2000 and 150 W/m²·°C, respectively. If the effective surface area on the finned side is 10 times the inner surface area, the overall heat transfer coefficient of this heat exchanger based on the inner surface area is

- (a) 150 W/m²·°C (b) 857 W/m²·°C (c) 1075 W/m²·°C (d) 2000 W/m²·°C (e) 2150 W/m²·°C

Answer (b) 857 W/m²·°C

Solution Solved by EES Software. Solutions can be verified by copying-and-pasting the following lines on a blank EES screen.

```
D=0.04 [m]
h_i=2000 [W/m^2-C]
h_o=150 [W/m^2-C]
A_i=1 [m^2]
A_o=10 [m^2]
1/(U_i*A_i)=1/(h_i*A_i)+1/(h_o*A_o) "Wall resistance is negligible"
"Some Wrong Solutions with Common Mistakes"
W1_U_i=h_i "Using h_i as the answer"
W2_U_o=h_o "Using h_o as the answer"
W3_U_o=1/2*(h_i+h_o) "Using the average of h_i and h_o as the answer"
```

11-140 A double-pipe heat exchanger is used to heat cold tap water with hot geothermal brine. Hot geothermal brine ($c_p = 4.25$ kJ/kg·°C) enters the tube at 95°C at a rate of 2.8 kg/s and leaves at 60°C. The heat exchanger is not well insulated and it is estimated that 5 percent of the heat given up by the hot fluid is lost from the heat exchanger. If the total thermal resistance of the heat exchanger is calculated to be 0.12°C/kW, the temperature difference between the hot and cold fluid is

- (a) 32.5°C (b) 35.0°C (c) 45.0°C (d) 47.5°C (e) 50.0°C

Answer (d) 47.5°C

Solution Solved by EES Software. Solutions can be verified by copying-and-pasting the following lines on a blank EES screen.

```
T_h_in=95 [C]
T_h_out=60 [C]
m_dot_h=2.8 [kg/s]
c_p_h=4.25 [kJ/kg-C]
f=0.05
R=0.12 [C/kW]
Q_dot_h=m_dot_h*c_p_h*(T_h_in-T_h_out) "Heat given up by the hot fluid"
Q_dot_c=(1-f)*Q_dot_h "Heat picked up by the cold fluid"
Q_dot_c=DELTA_T/R
"Some Wrong Solutions with Common Mistakes"
Q_dot_h=W1_DELTAT/R "Using heat given up by the hot fluid in the equation"
W2_DELTAT=T_h_in-T_h_out "Finding temperature decrease of the hot fluid"
```

11-141 Consider a double-pipe heat exchanger with a tube diameter of 10 cm and negligible tube thickness. The total thermal resistance of the heat exchanger was calculated to be $0.025 \text{ }^\circ\text{C/W}$ when it was first constructed. After some prolonged use, fouling occurs at both the inner and outer surfaces with the fouling factors $0.00045 \text{ m}^2\cdot^\circ\text{C/W}$ and $0.00015 \text{ m}^2\cdot^\circ\text{C/W}$, respectively. The percentage decrease in the rate of heat transfer in this heat exchanger due to fouling is

- (a) 2.3% (b) 6.8% (c) 7.1% (d) 7.6% (e) 8.5%

Answer (c) 7.1%

Solution Solved by EES Software. Solutions can be verified by copying-and-pasting the following lines on a blank EES screen.

```
D=0.10 [m]
R_old=0.025 [C/W]
R_f_i=0.00045 [m^2-C/W]
R_f_o=0.00015 [m^2-C/W]
L=1 [m] "Consider a unit length"
A=pi*D*L
R_fouling=R_f_i/A+R_f_o/A
R_new=R_old+R_fouling
U_old=1/(R_old*A)
U_new=1/(R_new*A)
PercentDecrease=(U_old-U_new)/U_old*Convert(, %)
"Some Wrong Solutions with Common Mistakes"
W1_PercentDecrease=R_fouling/R_old*Convert(, %) "Comparing fouling resistance to old
resistance"
W2_R_fouling=R_f_i+R_f_o "Treating fouling factors as fouling resistances"
W2_R_new=R_old+W2_R_fouling
W2_U_new=1/(W2_R_new*A)
W2_PercentDecrease=(U_old-W2_U_new)/U_old*Convert(, %)
```

11-142 Saturated water vapor at 40°C is to be condensed as it flows through the tubes of an air-cooled condenser at a rate of 0.2 kg/s . The condensate leaves the tubes as a saturated liquid at 40°C . The rate of heat transfer to air is

- (a) 34 kJ/s (b) 268 kJ/s (c) 453 kJ/s (d) 481 kJ/s (e) 515 kJ/s

Answer (d) 481 kJ/s

Solution Solved by EES Software. Solutions can be verified by copying-and-pasting the following lines on a blank EES screen.

```
T1=40 [C]
m_dot=0.2 [kg/s]
h_f=ENTHALPY(Steam_IAPWS,T=T1,x=0)
h_g=ENTHALPY(Steam_IAPWS,T=T1,x=1)
h_fg=h_g-h_f
Q_dot=m_dot*h_fg
"Wrong Solutions:"
W1_Q=m_dot*h_f "Using hf"
W2_Q=m_dot*h_g "Using hg"
W3_Q=h_fg "not using mass flow rate"
W4_Q=m_dot*(h_f+h_g) "Adding hf and hg"
```

11-143 A heat exchanger is used to condense steam coming off the turbine of a steam power plant by cold water from a nearby lake. The cold water ($c_p = 4.18 \text{ kJ/kg}\cdot^\circ\text{C}$) enters the condenser at 16°C at a rate of 20 kg/s and leaves at 25°C while the steam condenses at 45°C . The condenser is not insulated and it is estimated that heat at a rate of 8 kW is lost from the condenser to the surrounding air. The rate at which the steam condenses is

- (a) 0.282 kg/s (b) 0.290 kg/s (c) 0.305 kg/s (d) 0.314 kg/s (e) 0.318 kg/s

Answer (e) 0.318 kg/s

Solution Solved by EES Software. Solutions can be verified by copying-and-pasting the following lines on a blank EES screen.

```
T_c_in=16 [C]
T_c_out=25 [C]
m_dot_c=20 [kg/s]
c_p_c=4.18 [kJ/kg-C]
T_h=45 [C]
Q_dot_lost=8 [kW]
Q_dot_c=m_dot_c*c_p_c*(T_c_out-T_c_in) "Heat picked up by the cold fluid"
Q_dot_h=Q_dot_c+Q_dot_lost "Heat given up by the hot fluid"
h_fg=2395 [kJ/kg] "Table A-9"
m_dot_cond=Q_dot_h/h_fg
```

"Some Wrong Solutions with Common Mistakes"

```
W1_m_dot_cond=Q_dot_c/h_fg "Ignoring heat loss from the heat exchanger"
```

11-144 A counter-flow heat exchanger is used to cool oil ($c_p = 2.20 \text{ kJ/kg}\cdot^\circ\text{C}$) from 110°C to 85°C at a rate of 0.75 kg/s by cold water ($c_p = 4.18 \text{ kJ/kg}\cdot^\circ\text{C}$) that enters the heat exchanger at 20°C at a rate of 0.6 kg/s . If the overall heat transfer coefficient is $800 \text{ W/m}^2\cdot^\circ\text{C}$, the heat transfer area of the heat exchanger is

- (a) 0.745 m^2 (b) 0.760 m^2 (c) 0.775 m^2 (d) 0.790 m^2 (e) 0.805 m^2

Answer (a) 0.745 m^2

Solution Solved by EES Software. Solutions can be verified by copying-and-pasting the following lines on a blank EES screen.

```
T_h_in=110 [C]
T_h_out=85 [C]
m_dot_h=0.75 [kg/s]
c_p_h=2.20 [kJ/kg-C]
T_c_in=20 [C]
m_dot_c=0.6 [kg/s]
c_p_c=4.18 [kJ/kg-C]
U=0.800 [kW/m^2-C]
Q_dot=m_dot_h*c_p_h*(T_h_in-T_h_out)
Q_dot=m_dot_c*c_p_c*(T_c_out-T_c_in)
DELTAT_1=T_h_in-T_c_out
DELTAT_2=T_h_out-T_c_in
DELTAT_lm=(DELTAT_1-DELTAT_2)/ln(DELTAT_1/DELTAT_2)
Q_dot=U*A_s*DELTAT_lm
```

11-145 In a parallel-flow, liquid-to-liquid heat exchanger, the inlet and outlet temperatures of the hot fluid are 150°C and 90°C while that of the cold fluid are 30°C and 70°C, respectively. For the same overall heat transfer coefficient, the percentage decrease in the surface area of the heat exchanger if counter-flow arrangement is used is

- (a) 3.9% (b) 9.7% (c) 14.5% (d) 19.7% (e) 24.6%

Answer (e) 24.6%

Solution Solved by EES Software. Solutions can be verified by copying-and-pasting the following lines on a blank EES screen.

```
T_h_in=150 [C]
T_h_out=90 [C]
T_c_in=30 [C]
T_c_out=70 [C]
"Parallel flow arrangement"
DELTAT_1_p=T_h_in-T_c_in
DELTAT_2_p=T_h_out-T_c_out
DELTAT_lm_p=(DELTAT_1_p-DELTAT_2_p)/ln(DELTAT_1_p/DELTAT_2_p)
"Counter flow arrangement"
DELTAT_1_c=T_h_in-T_c_out
DELTAT_2_c=T_h_out-T_c_in
DELTAT_lm_c=(DELTAT_1_c-DELTAT_2_c)/ln(DELTAT_1_c/DELTAT_2_c)
PercentDecrease=(DELTAT_lm_c-DELTAT_lm_p)/DELTAT_lm_p*Convert(, %)
"From Q_dot = U*A_s *DELTAT_lm, for the same Q_dot and U, DELTAT_lm and A_s are inversely
proportional."

"Some Wrong Solutions with Common Mistakes"
W_PercentDecrease=(DELTAT_lm_c-DELTAT_lm_p)/DELTAT_lm_c*Convert(, %) "Dividing the difference
by DELTAT_lm_c"
```

11-146 A heat exchanger is used to heat cold water entering at 8°C at a rate of 1.2 kg/s by hot air entering at 90°C at rate of 2.5 kg/s. The highest rate of heat transfer in the heat exchanger is

- (a) 205 kW (b) 411 kW (c) 311 kW (d) 114 kW (e) 78 kW

Answer (d) 205 kW

Solution Solved by EES Software. Solutions can be verified by copying-and-pasting the following lines on a blank EES screen.

```
cp_c=4.18 [kJ/kg-C]
cp_h=1.0 [kJ/kg-C]
Tc_in=8 [C]
Th_in=90 [C]
m_c=1.2 [kg/s]
m_h=2.5 [kg/s]
"From Q_max relation, Q_max=C_min(Th,in-Tc,in)"
Cc=m_c*cp_c
Ch=m_h*cp_h
C_min=min(Cc, Ch)
Q_max=C_min*(Th_in-Tc_in)
"Some Wrong Solutions with Common Mistakes:"
C_max=max(Cc, Ch)
W1Q_max=C_max*(Th_in-Tc_in) "Using Cmax"
```

11-147 Cold water ($c_p = 4.18 \text{ kJ/kg}\cdot^\circ\text{C}$) enters a heat exchanger at 15°C at a rate of 0.5 kg/s where it is heated by hot air ($c_p = 1.0 \text{ kJ/kg}\cdot^\circ\text{C}$) that enters the heat exchanger at 50°C at a rate of 1.8 kg/s . The maximum possible heat transfer rate in this heat exchanger is

- (a) 51.1 kW (b) 63.0 kW (c) 66.8 kW (d) 73.2 kW (e) 80.0 kW

Answer (b) 63.0 W

Solution Solved by EES Software. Solutions can be verified by copying-and-pasting the following lines on a blank EES screen.

```
T_c_in=15 [C]
m_dot_c=0.5 [kg/s]
c_p_c=4.18 [kJ/kg-C]
T_h_in=50 [C]
m_dot_h=1.8 [kg/s]
c_p_h=1.0 [kJ/kg-C]
C_c=m_dot_c*c_p_c
C_h=m_dot_h*c_p_h
C_min=min(C_c, C_h)
Q_dot_max=C_min*(T_h_in-T_c_in)
"Some Wrong Solutions with Common Mistakes"
W1_C_min=C_c "Using the greater heat capacity in the equation"
W1_Q_dot_max=W1_C_min*(T_h_in-T_c_in)
```

11-148 Cold water ($c_p = 4.18 \text{ kJ/kg}\cdot^\circ\text{C}$) enters a counter-flow heat exchanger at 10°C at a rate of 0.35 kg/s where it is heated by hot air ($c_p = 1.0 \text{ kJ/kg}\cdot^\circ\text{C}$) that enters the heat exchanger at 50°C at a rate of 1.9 kg/s and leaves at 25°C . The effectiveness of this heat exchanger is

- (a) 0.50 (b) 0.63 (c) 0.72 (d) 0.81 (e) 0.89

Answer (d) 0.81

Solution Solved by EES Software. Solutions can be verified by copying-and-pasting the following lines on a blank EES screen.

```
T_c_in=10 [C]
m_dot_c=0.35 [kg/s]
c_p_c=4.18 [kJ/kg-C]
T_h_in=50 [C]
T_h_out=25 [C]
m_dot_h=1.9 [kg/s]
c_p_h=1.0 [kJ/kg-C]
C_c=m_dot_c*c_p_c
C_h=m_dot_h*c_p_h
C_min=min(C_c, C_h)
Q_dot_max=C_min*(T_h_in-T_c_in)
Q_dot=m_dot_h*c_p_h*(T_h_in-T_h_out)
epsilon=Q_dot/Q_dot_max
```

```
"Some Wrong Solutions with Common Mistakes"
W1_C_min=C_h "Using the greater heat capacity in the equation"
W1_Q_dot_max=W1_C_min*(T_h_in-T_c_in)
W1_epsilon=Q_dot/W1_Q_dot_max
```

11-149 Hot oil ($c_p = 2.1 \text{ kJ/kg}\cdot^\circ\text{C}$) at 110°C and 8 kg/s is to be cooled in a heat exchanger by cold water ($c_p = 4.18 \text{ kJ/kg}\cdot^\circ\text{C}$) entering at 10°C and at a rate of 2 kg/s . The lowest temperature that oil can be cooled in this heat exchanger is

- (a) 10.0°C (b) 33.5°C (c) 46.1°C (d) 60.2°C (e) 71.4°C

Answer (d) 60.2°C

Solution Solved by EES Software. Solutions can be verified by copying-and-pasting the following lines on a blank EES screen.

```
cp_c=4.18 [kJ/kg-C]
cp_h=2.1 [kJ/kg-C]
Tc_in=10 [C]
Th_in=110 [C]
m_c=2 [kg/s]
m_h=8 [kg/s]
"From Q_max relation, Q_max=C_min(Th,in-Tc,in)"
Cc=m_c*cp_c
Ch=m_h*cp_h
C_min=min(Cc, Ch)
Q_max=C_min*(Th_in-Tc_in)
Q_max=Ch*(Th_in-Th_out)
```

"Some Wrong Solutions with Common Mistakes:"

```
C_max=max(Cc, Ch)
W1Q_max=C_max*(Th_in-Tc_in) "Using Cmax"
W1Q_max=Ch*(Th_in-W1Th_out)
```

11-150 Cold water ($c_p = 4.18 \text{ kJ/kg}\cdot^\circ\text{C}$) enters a counter-flow heat exchanger at 18°C at a rate of 0.7 kg/s where it is heated by hot air ($c_p = 1.0 \text{ kJ/kg}\cdot^\circ\text{C}$) that enters the heat exchanger at 50°C at a rate of 1.6 kg/s and leaves at 25°C . The maximum possible outlet temperature of the cold water is

- (a) 25.0°C (b) 32.0°C (c) 35.5°C (d) 39.7°C (e) 50.0°C

Answer (c) 35.5°C

Solution Solved by EES Software. Solutions can be verified by copying-and-pasting the following lines on a blank EES screen.

```
T_c_in=18 [C]
m_dot_c=0.7 [kg/s]
c_p_c=4.18 [kJ/kg-C]
T_h_in=50 [C]
T_h_out=25 [C]
m_dot_h=1.6 [kg/s]
c_p_h=1.0 [kJ/kg-C]
C_c=m_dot_c*c_p_c
C_h=m_dot_h*c_p_h
C_min=min(C_c, C_h)
Q_dot_max=C_min*(T_h_in-T_c_in)
Q_dot_max=C_c*(T_c_out_max-T_c_in)
"Some Wrong Solutions with Common Mistakes"
W1_C_min=C_c "Using the greater heat capacity in the equation"
W1_Q_dot_max=W1_C_min*(T_h_in-T_c_in)
W1_Q_dot_max=C_c*(W1_T_c_out_max-T_c_in)
W2_T_c_out_max=T_h_in "Using T_h_in as the answer"
W3_T_c_out_max=T_h_out "Using T_h_in as the answer"
```

11-151 Steam is to be condensed on the shell side of a 2-shell-passes and 8-tube-passes condenser, with 20 tubes in each pass. Cooling water enters the tubes at a rate of 2 kg/s. If the heat transfer area is 14 m² and the overall heat transfer coefficient is 1800 W/m²·°C, the effectiveness of this condenser is

- (a) 0.70 (b) 0.80 (c) 0.90 (d) 0.95 (e) 1.0

Answer (d) 0.95

Solution Solved by EES Software. Solutions can be verified by copying-and-pasting the following lines on a blank EES screen.

```
cp_c=4.18 [kJ/kg-C]
m_c=2 [kg/s]
A=14
U=1.8 [kW/m^2-K]
"From NTU and Effectiveness relations for counterflow HX:"
C_min=m_c*cp_c
NTU=U*A/C_min
Eff=1-Exp(-NTU)
```

11-152 Water is boiled at 150°C in a boiler by hot exhaust gases ($c_p = 1.05$ kJ/kg·°C) that enter the boiler at 400°C at a rate of 0.4 kg/s and leaves at 200°C. The surface area of the heat exchanger is 0.64 m². The overall heat transfer coefficient of this heat exchanger is

- (a) 940 W/m²·°C (b) 1056 W/m²·°C (c) 1145 W/m²·°C (d) 1230 W/m²·°C (e) 1393 W/m²·°C

Answer (b) 1056 W/m²·°C

Solution Solved by EES Software. Solutions can be verified by copying-and-pasting the following lines on a blank EES screen.

```
T_w=150 [C]
T_h_in=400 [C]
T_h_out=200 [C]
m_dot_h=0.4 [kg/s]
c_p_h=1.05 [kJ/kg-C]
A_s=0.64 [m^2]
C_h=m_dot_h*c_p_h
C_min=C_h
Q_dot_max=C_min*(T_h_in-T_w)
Q_dot=C_h*(T_h_in-T_h_out)
epsilon=Q_dot/Q_dot_max
NTU=-ln(1-epsilon)
U=(NTU*C_min)/A_s
```

11-153 In a parallel-flow, water-to-water heat exchanger, the hot water enters at 75°C at a rate of 1.2 kg/s and cold water enters at 20°C at a rate of 0.9 kg/s. The overall heat transfer coefficient and the surface area for this heat exchanger are 750 W/m²·°C and 6.4 m², respectively. The specific heat for both the hot and cold fluid may be taken to be 4.18 kJ/kg·°C. For the same overall heat transfer coefficient and the surface area, the increase in the effectiveness of this heat exchanger if counter-flow arrangement is used is

- (a) 0.09 (b) 0.11 (c) 0.14 (d) 0.17 (e) 0.19

Answer (a) 0.09

Solution Solved by EES Software. Solutions can be verified by copying-and-pasting the following lines on a blank EES screen.

```
T_h_in=75 [C]
m_dot_h=1.2 [kg/s]
T_c_in=20 [C]
m_dot_c=0.9 [kg/s]
c_p=4.18 [kJ/kg-C]
U=0.750 [kW/m^2-C]
A_s=6.4 [m^2]
C_h=m_dot_h*c_p
C_c=m_dot_c*c_p
C_min=min(C_c, C_h)
C_max=max(C_c, C_h)
c=C_min/C_max
NTU=(U*A_s)/C_min
epsilon_p=(1-exp((-NTU)*(1+c)))/(1+c)
epsilon_c=(1-exp((-NTU)*(1-c)))/(1-c*exp((-NTU)*(1-c)))
Increase_epsilon=epsilon_c-epsilon_p
```

11-154 In a parallel-flow heat exchanger, the NTU is calculated to be 2.5. The lowest possible effectiveness for this heat exchanger is

- (a) 10% (b) 27% (c) 41% (d) 50% (e) 92%

Answer (d) 50%

Solution Solved by EES Software. Solutions can be verified by copying-and-pasting the following lines on a blank EES screen.

```
NTU=2.5
c=1 "The effectiveness is lowest when c = 1"
epsilon=(1-exp((-NTU)*(1+c)))/(1+c)
```

"Some Wrong Solutions with Common Mistakes"

```
W_epsilon=1-exp(-NTU) "Finding maximum effectiveness when c=0"
```

11-155 In a parallel-flow, air-to-air heat exchanger, hot air ($c_p = 1.05 \text{ kJ/kg}\cdot^\circ\text{C}$) enters at 400°C at a rate of 0.06 kg/s and cold air ($c_p = 1.0 \text{ kJ/kg}\cdot^\circ\text{C}$) enters at 25°C . The overall heat transfer coefficient and the surface area for this heat exchanger are $500 \text{ W/m}^2\cdot^\circ\text{C}$ and 0.12 m^2 , respectively. The lowest possible heat transfer rate in this heat exchanger is

- (a) 3.8 kW (b) 7.9 kW (c) 10.1 kW (d) 14.5 kW (e) 23.6 kW

Answer (c) 10.1 kW

Solution Solved by EES Software. Solutions can be verified by copying-and-pasting the following lines on a blank EES screen.

```
T_h_in=400 [C]
c_p_h=1.05 [kJ/kg-C]
m_dot_h=0.06 [kg/s]
T_c_in=25 [C]
c_p_c=1.0 [kJ/kg-C]
U=0.500 [kW/m^2-C]
A_s=0.12 [m^2]
c=1 "c=1 for the lowest effectiveness (i.e., the lowest heat transfer rate)"
C_h=m_dot_h*c_p_h
NTU=(U*A_s)/C_h
epsilon=(1-exp((-NTU)*(1+c)))/(1+c)
Q_dot_max=C_h*(T_h_in-T_c_in)
Q_dot=epsilon*Q_dot_max
"Some Wrong Solutions with Common Mistakes"
W_Q_dot=Q_dot_max "Finding maximum heat transfer rate"
```

11-156 Steam is to be condensed on the shell side of a 1-shell-pass and 4-tube-passes condenser, with 30 tubes in each pass, at 30°C . Cooling water ($c_p = 4.18 \text{ kJ/kg}\cdot^\circ\text{C}$) enters the tubes at 12°C at a rate of 2 kg/s . If the heat transfer area is 14 m^2 and the overall heat transfer coefficient is $1800 \text{ W/m}^2\cdot^\circ\text{C}$, the rate of heat transfer in this condenser is

- (a) 112 kW (b) 94 kW (c) 166 kW (d) 151 kW (e) 143 kW

Answer (e) 143 kW

Solution Solved by EES Software. Solutions can be verified by copying-and-pasting the following lines on a blank EES screen.

```
cp_c=4.18 [kJ/kg-C]
h_fg=2431 [kJ/kg-C]
Tc_in=12 [C]
Th_in=30 [C]
Th_out=30 [C]
m_c=2 [kg/s]
A=14
U=1.8 [kW/m^2-K]
"From NTU and Effectiveness relations for counterflow HX:"
C_min=m_c*cp_c
NTU=U*A/C_min
Eff=1-Exp(-NTU)
Q_max=C_min*(Th_in-Tc_in)
Q=Eff*Q_max
```

11-157 An air-cooled condenser is used to condense isobutane in a binary geothermal power plant. The isobutane is condensed at 85°C by air ($c_p = 1.0 \text{ kJ/kg}\cdot^\circ\text{C}$) that enters at 22°C at a rate of 18 kg/s. The overall heat transfer coefficient and the surface area for this heat exchanger are $2.4 \text{ kW/m}^2\cdot^\circ\text{C}$ and 1.25 m^2 , respectively. The outlet temperature of the air is

- (a) 45.4°C (b) 40.9°C (c) 37.5°C (d) 34.2°C (e) 31.7°C

Answer (e) 31.7°C

Solution Solved by EES Software. Solutions can be verified by copying-and-pasting the following lines on a blank EES screen.

```
T_h=85 [C]
T_c_in=22 [C]
m_dot_c=18 [kg/s]
c_p_c=1.0 [kJ/kg-C]
U=2.4 [kW/m^2-C]
A_s=1.25 [m^2]
C_c=m_dot_c*c_p_c
C_min =C_c
NTU=(U*A_s)/C_min
epsilon=1-exp(-NTU)
Q_dot_max=C_min*(T_h-T_c_in)
Q_dot=epsilon*Q_dot_max
Q_dot=m_dot_c*c_p_c*(T_c_out-T_c_in)
```

11-158 An air handler is a large unmixed heat exchanger used for comfort control in large buildings. In one such application, chilled water ($c_p = 4.2 \text{ kJ/kg}\cdot\text{K}$) enters an air handler at 5°C and leaves at 12°C with a flow rate of 1000 kg/h. This cold water cools 5000 kg/h of air ($c_p = 1.0 \text{ kJ/kg}\cdot\text{K}$) which enters the air handler at 25°C. If these streams are in counter-flow and the water stream conditions remain fixed, the minimum temperature at the air outlet is

- (a) 5°C (b) 12°C (c) 19°C (d) 22°C (e) 25°C

Answer (d) 19°C

Solution Solved by EES Software. Solutions can be verified by copying-and-pasting the following lines on a blank EES screen.

```
cp_c=4.2 [kJ/kg-K]
T_c_in=5 [C]
T_c_out=12 [C]
m_dot_c=1000/3600 "[kg/s]"
m_dot_h=5000/3600 "[kg/s]"
cp_h=1.0 [kJ/kg-K]
T_h_in=25 [C]

Q_dot=m_dot_c*cp_c*(T_c_out-T_c_in)
Q_dot=m_dot_h*cp_h*(T_h_in-T_h_out)
```

11-159 An air handler is a large unmixed heat exchanger used for comfort control in large buildings. In one such application, chilled water ($c_p = 4.2 \text{ kJ/kg}\cdot\text{K}$) enters an air handler at 5°C and leaves at 12°C with a flow rate of 1000 kg/hr . This cold water cools air ($c_p = 1.0 \text{ kJ/kg}\cdot\text{K}$) from 25°C to 15°C . The rate of heat transfer between the two streams is

- (a) 8.2 kW (b) 23.7 kW (c) 33.8 kW (d) 44.8 kW (e) 52.8 kW

Answer (d) 8.2 kW

Solution Solved by EES Software. Solutions can be verified by copying-and-pasting the following lines on a blank EES screen.

```
cp_c=4.2 [kJ/kg-K]
T_c_in=5 [C]
T_c_out=12 [C]
m_dot_c=1000/3600 "[kg/s]"
cp_h=1.0 [kJ/kg-K]
T_h_in=25 [C]
T_h_out=15 [C]
Q_dot=m_dot_c*cp_c*(T_c_out-T_c_in)
```

11-160 The radiator in an automobile is a cross-flow heat exchanger ($UA_s = 10 \text{ kW/K}$) that uses air ($c_p = 1.00 \text{ kJ/kg}\cdot\text{K}$) to cool the engine coolant fluid ($c_p = 4.00 \text{ kJ/kg}\cdot\text{K}$). The engine fan draws 30°C air through this radiator at a rate of 10 kg/s while the coolant pump circulates the engine coolant at a rate of 5 kg/s . The coolant enters this radiator at 80°C . Under these conditions, what is the number of transfer units (NTU) of this radiator?

- (a) 1 (b) 2 (c) 3 (d) 4 (e) 5

Answer (c) 3

Solution Solved by EES Software. Solutions can be verified by copying-and-pasting the following lines on a blank EES screen.

```
UA=30 [kW/K]
m_dot_a=10 [kg/s]
c_p_a=1.0 [kJ/kg-K]
m_dot_c=5 [kg/s]
c_p_c=4.0 [kJ/kg-K]
C_a=m_dot_a*c_p_a
C_c=m_dot_c*c_p_c
C_min=C_a
NTU=UA/C_min
```

11-161 . . . 11-168 Design and Essay Problems

11-168 A counter flow double-pipe heat exchanger is used for cooling a liquid stream by a coolant. The rate of heat transfer and the outlet temperatures of both fluids are to be determined. Also, a replacement proposal is to be analyzed.

Assumptions 1 Steady operating conditions exist. 2 The heat exchanger is well-insulated so that heat loss to the surroundings is negligible and thus heat transfer from the hot fluid is equal to the heat transfer to the cold fluid. 3 Changes in the kinetic and potential energies of fluid streams are negligible. 4 Fluid properties are constant. 5 There is no fouling.

Properties The specific heats of hot and cold fluids are given to be 3.15 and 4.2 kJ/kg·°C, respectively.

Analysis (a) The overall heat transfer coefficient is

$$U = \frac{600}{\frac{1}{\dot{m}_c^{0.8}} + \frac{2}{\dot{m}_h^{0.8}}} = \frac{600}{\frac{1}{8^{0.8}} + \frac{2}{10^{0.8}}} = 1185 \text{ W/m}^2 \cdot \text{K}$$

The rate of heat transfer may be expressed as

$$\dot{Q} = \dot{m}_c c_c (T_{c,out} - T_{c,in}) = (8)(4200)(T_{c,out} - 10) \quad (1)$$

$$\dot{Q} = \dot{m}_h c_h (T_{h,in} - T_{h,out}) = (10)(3150)(90 - T_{h,out}) \quad (2)$$

It may also be expressed using the logarithmic mean temperature difference as

$$\dot{Q} = UA\Delta T_{lm} = UA \frac{\Delta T_1 - \Delta T_2}{\ln(\Delta T_1 / \Delta T_2)} = (1185)(9) \frac{(90 - T_c) - (T_h - 10)}{\ln\left(\frac{90 - T_c}{T_h - 10}\right)} \quad (3)$$

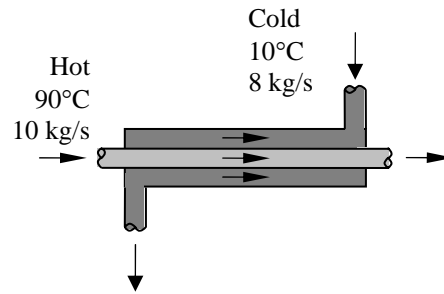

We have three equations with three unknowns, solving an equation solver such as EES, we obtain

$$\dot{Q} = 6.42 \times 10^5 \text{ W}, \quad T_{c,out} = 29.1^\circ\text{C}, \quad T_{h,out} = 69.6^\circ\text{C}$$

(b) The overall heat transfer coefficient for each unit is

$$U = \frac{600}{\frac{1}{\dot{m}_c^{0.8}} + \frac{2}{\dot{m}_h^{0.8}}} = \frac{600}{\frac{1}{4^{0.8}} + \frac{2}{5^{0.8}}} = 680.5 \text{ W/m}^2 \cdot \text{K}$$

Then

$$\dot{Q} = \dot{m}_c c_c (T_{c,out} - T_{c,in}) = (2 \times 4)(4200)(T_{c,out} - 10) \quad (1)$$

$$\dot{Q} = \dot{m}_h c_h (T_{h,in} - T_{h,out}) = (2 \times 5)(3150)(90 - T_{h,out}) \quad (2)$$

$$\dot{Q} = UA\Delta T_{lm} = UA \frac{\Delta T_1 - \Delta T_2}{\ln(\Delta T_1 / \Delta T_2)} = (680.5)(2 \times 5) \frac{(90 - T_c) - (T_h - 10)}{\ln\left(\frac{90 - T_c}{T_h - 10}\right)} \quad (3)$$

One again, we have three equations with three unknowns, solving an equation solver such as EES, we obtain

$$\dot{Q} = 4.5 \times 10^5 \text{ W}, \quad T_{c,out} = 23.4^\circ\text{C}, \quad T_{h,out} = 75.7^\circ\text{C}$$

Discussion Despite a higher heat transfer area, the new heat transfer is about 30% lower. This is due to much lower U , because of the halved flow rates. So, the vendor's recommendation is not acceptable. The vendor's unit will do the job provided that they are connected in series. Then the two units will have the same U as in the existing unit.



Chapter 12

FUNDAMENTALS OF THERMAL RADIATION

Electromagnetic and Thermal Radiation

12-1C Electromagnetic waves are caused by accelerated charges or changing electric currents giving rise to electric and magnetic fields. Sound waves are caused by disturbances. Electromagnetic waves can travel in vacuum, sound waves cannot.

12-2C Electromagnetic waves are characterized by their frequency ν and wavelength λ . These two properties in a medium are related by $\lambda = c/\nu$ where c is the speed of light in that medium.

12-3C Visible light is a kind of electromagnetic wave whose wavelength is between 0.40 and 0.76 μm . It differs from the other forms of electromagnetic radiation in that it triggers the sensation of seeing in the human eye.

12-4C Infrared radiation lies between 0.76 and 100 μm whereas ultraviolet radiation lies between the wavelengths 0.01 and 0.40 μm . The human body does not emit any radiation in the ultraviolet region since bodies at room temperature emit radiation in the infrared region only.

12-5C Thermal radiation is the radiation emitted as a result of vibrational and rotational motions of molecules, atoms and electrons of a substance, and it extends from about 0.1 to 100 μm in wavelength. Unlike the other forms of electromagnetic radiation, thermal radiation is emitted by bodies because of their temperature.

12-6C Light (or visible) radiation consists of narrow bands of colors from violet to red. The color of a surface depends on its ability to reflect certain wavelength. For example, a surface that reflects radiation in the wavelength range 0.63-0.76 μm while absorbing the rest appears red to the eye. A surface that reflects all the light appears white while a surface that absorbs the entire light incident on it appears black. The color of a surface at room temperature is not related to the radiation it emits.

12-7C Radiation in opaque solids is considered surface phenomena since only radiation emitted by the molecules in a very thin layer of a body at the surface can escape the solid.

12-8C Because the snow reflects almost all of the visible and ultraviolet radiation, and the skin is exposed to radiation both from the sun and from the snow.

12-9C Microwaves in the range of 10^2 to 10^5 μm are very suitable for use in cooking as they are reflected by metals, transmitted by glass and plastics and absorbed by food (especially water) molecules. Thus the electric energy converted to radiation in a microwave oven eventually becomes part of the internal energy of the food with no conduction and convection thermal resistances involved. In conventional cooking, on the other hand, conduction and convection thermal resistances slow down the heat transfer, and thus the heating process.

12-10 The speeds of light in air, water, and glass are to be determined.

Analysis The speeds of light in air, water and glass are

$$\text{Air: } c = \frac{c_0}{n} = \frac{3.0 \times 10^8 \text{ m/s}}{1} = \mathbf{3.0 \times 10^8 \text{ m/s}}$$

$$\text{Water: } c = \frac{c_0}{n} = \frac{3.0 \times 10^8 \text{ m/s}}{1.33} = \mathbf{2.26 \times 10^8 \text{ m/s}}$$

$$\text{Glass: } c = \frac{c_0}{n} = \frac{3.0 \times 10^8 \text{ m/s}}{1.5} = \mathbf{2.0 \times 10^8 \text{ m/s}}$$

12-11 Electricity is generated and transmitted in power lines at a frequency of 60 Hz. The wavelength of the electromagnetic waves is to be determined.

Analysis The wavelength of the electromagnetic waves is

$$\lambda = \frac{c}{\nu} = \frac{2.998 \times 10^8 \text{ m/s}}{60 \text{ Hz}(1/\text{s})} = \mathbf{4.997 \times 10^6 \text{ m}}$$

Power lines



12-12 A microwave oven operates at a frequency of 2.2×10^9 Hz. The wavelength of these microwaves and the energy of each microwave are to be determined.

Analysis The wavelength of these microwaves is

$$\lambda = \frac{c}{\nu} = \frac{2.998 \times 10^8 \text{ m/s}}{2.2 \times 10^9 \text{ Hz}(1/\text{s})} = 0.136 \text{ m} = \mathbf{136 \text{ mm}}$$

Then the energy of each microwave becomes

$$e = h\nu = \frac{hc}{\lambda} = \frac{(6.625 \times 10^{-34} \text{ Js})(2.998 \times 10^8 \text{ m/s})}{0.136 \text{ m}} = \mathbf{1.46 \times 10^{-24} \text{ J}}$$

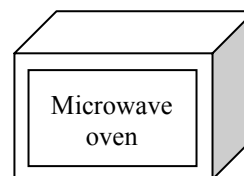

12-13 A radio station is broadcasting radiowaves at a wavelength of 200 m. The frequency of these waves is to be determined.

Analysis The frequency of the waves is determined from

$$\lambda = \frac{c}{\nu} \rightarrow \nu = \frac{c}{\lambda} = \frac{2.998 \times 10^8 \text{ m/s}}{200 \text{ m}} = \mathbf{1.5 \times 10^6 \text{ Hz}}$$



12-14 A cordless telephone operates at a frequency of 8.5×10^8 Hz. The wavelength of these telephone waves is to be determined.

Analysis The wavelength of the telephone waves is

$$\lambda = \frac{c}{\nu} = \frac{2.998 \times 10^8 \text{ m/s}}{8.5 \times 10^8 \text{ Hz(1/s)}} = 0.353 \text{ m} = \mathbf{353 \text{ mm}}$$



Blackbody Radiation

12-15C A blackbody is a perfect emitter and absorber of radiation. A blackbody does not actually exist. It is an idealized body that emits the maximum amount of radiation that can be emitted by a surface at a given temperature.

12-16C *Spectral blackbody emissive power* is the amount of radiation energy emitted by a blackbody at an absolute temperature T per unit time, per unit surface area and per unit wavelength about wavelength λ . The integration of the spectral blackbody emissive power over the entire wavelength spectrum gives the *total blackbody emissive power*,

$$E_b(T) = \int_0^{\infty} E_{b\lambda}(T) d\lambda = \sigma T^4$$

The spectral blackbody emissive power varies with wavelength, the total blackbody emissive power does not.

12-17C We defined the blackbody radiation function f_λ because the integration $\int_0^{\infty} E_{b\lambda}(T) d\lambda$ cannot be performed. The blackbody radiation function f_λ represents the fraction of radiation emitted from a blackbody at temperature T in the wavelength range from $\lambda = 0$ to λ . This function is used to determine the fraction of radiation in a wavelength range between λ_1 and λ_2 .

12-18C The larger the temperature of a body, the larger the fraction of the radiation emitted in shorter wavelengths. Therefore, the body at 1500 K will emit more radiation in the shorter wavelength region. The body at 1000 K emits more radiation at $20 \mu\text{m}$ than the body at 1500 K since $\lambda T = \text{constant}$.

12-19 The maximum thermal radiation that can be emitted by a surface is to be determined.

Analysis The maximum thermal radiation that can be emitted by a surface is determined from Stefan-Boltzman law to be

$$E_b(T) = \sigma T^4 = (5.67 \times 10^{-8} \text{ W/m}^2 \cdot \text{K}^4)(800 \text{ K})^4 = \mathbf{2.32 \times 10^4 \text{ W/m}^2}$$

12-20 An isothermal cubical body is suspended in the air. The rate at which the cube emits radiation energy and the spectral blackbody emissive power are to be determined.

Assumptions The body behaves as a black body.

Analysis (a) The total blackbody emissive power is determined from Stefan-Boltzman Law to be

$$A_s = 6a^2 = 6(0.2^2) = 0.24 \text{ m}^2$$

$$E_b(T) = \sigma T^4 A_s = (5.67 \times 10^{-8} \text{ W/m}^2 \cdot \text{K}^4)(750 \text{ K})^4 (0.24 \text{ m}^2) = \mathbf{4306 \text{ W}}$$

(b) The spectral blackbody emissive power at a wavelength of $4 \mu\text{m}$ is determined from Plank's distribution law,

$$E_{b\lambda} = \frac{C_1}{\lambda^5 \left[\exp\left(\frac{C_2}{\lambda T}\right) - 1 \right]} = \frac{3.74177 \times 10^8 \text{ W} \cdot \mu\text{m}^4/\text{m}^2}{(4 \mu\text{m})^5 \left[\exp\left(\frac{1.43878 \times 10^4 \mu\text{m} \cdot \text{K}}{(4 \mu\text{m})(750 \text{ K})}\right) - 1 \right]}$$

$$= 3045 \text{ W/m}^2 \cdot \mu\text{m} = \mathbf{3.05 \text{ kW/m}^2 \cdot \mu\text{m}}$$

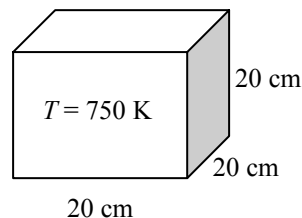

12-21E The sun is at an effective surface temperature of 10,400 R. The rate of infrared radiation energy emitted by the sun is to be determined.

Assumptions The sun behaves as a black body.

Analysis Noting that $T = 10,400 \text{ R} = 5778 \text{ K}$, the blackbody radiation functions corresponding to $\lambda_1 T$ and $\lambda_2 T$ are determined from Table 12-2 to be

$$\lambda_1 T = (0.76 \mu\text{m})(5778 \text{ K}) = 4391.3 \mu\text{mK} \longrightarrow f_{\lambda_1} = 0.547370$$

$$\lambda_2 T = (100 \mu\text{m})(5778 \text{ K}) = 577,800 \mu\text{mK} \longrightarrow f_{\lambda_2} = 1.0$$

Then the fraction of radiation emitted between these two wavelengths becomes

$$f_{\lambda_2} - f_{\lambda_1} = 1.0 - 0.547 = 0.453 \quad (\text{or } 45.3\%)$$

The total blackbody emissive power of the sun is determined from Stefan-Boltzman Law to be

$$E_b = \sigma T^4 = (0.1714 \times 10^{-8} \text{ Btu/h} \cdot \text{ft}^2 \cdot \text{R}^4)(10,400 \text{ R})^4 = 2.005 \times 10^7 \text{ Btu/h} \cdot \text{ft}^2$$

Then,

$$E_{\text{infrared}} = (0.453)E_b = (0.453)(2.005 \times 10^7 \text{ Btu/h} \cdot \text{ft}^2) = \mathbf{9.08 \times 10^6 \text{ Btu/h} \cdot \text{ft}^2}$$

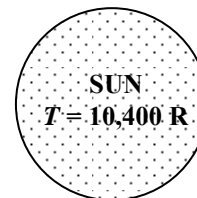

12-22 EES The spectral blackbody emissive power of the sun versus wavelength in the range of 0.01 μm to 1000 μm is to be plotted.

Analysis The problem is solved using EES, and the solution is given below.

"GIVEN"

T=5780 [K]

lambda=0.01[micrometer]

"ANALYSIS"

$E_{b,\lambda} = C_1 / (\lambda^5 * (\exp(C_2 / (\lambda * T)) - 1))$

C_1=3.742E8 [W-micrometer⁴/m²]

C_2=1.439E4 [micrometer-K]

λ [μm]	$E_{b,\lambda}$ [W/m ² - μm]
0.01	2.820E-90
10.11	12684
20.21	846.3
30.31	170.8
40.41	54.63
50.51	22.52
60.62	10.91
70.72	5.905
80.82	3.469
90.92	2.17
...	...
...	...
909.1	0.0002198
919.2	0.0002103
929.3	0.0002013
939.4	0.0001928
949.5	0.0001847
959.6	0.000177
969.7	0.0001698
979.8	0.0001629
989.9	0.0001563
1000	0.0001501

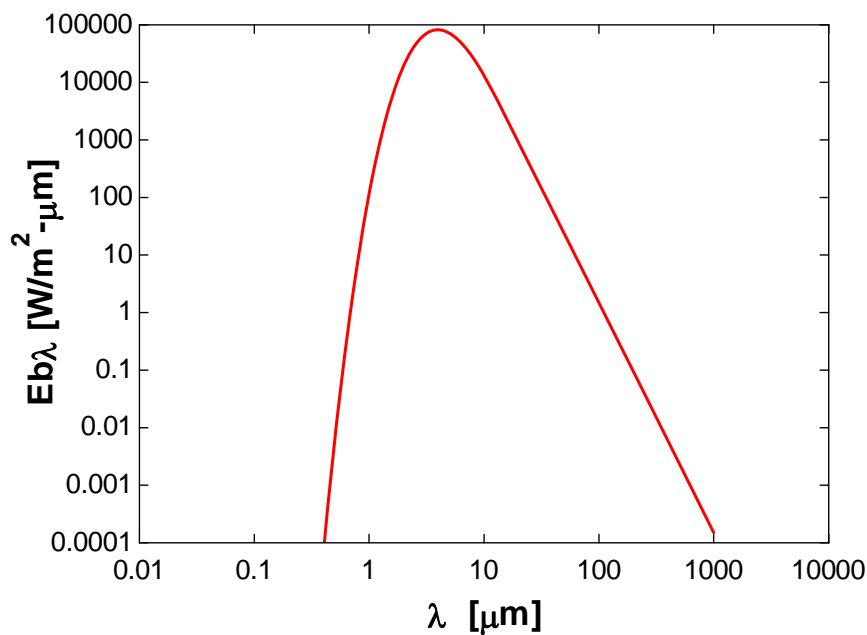

12-23 The temperature of the filament of an incandescent light bulb is given. The fraction of visible radiation emitted by the filament and the wavelength at which the emission peaks are to be determined.

Assumptions The filament behaves as a black body.

Analysis The visible range of the electromagnetic spectrum extends from $\lambda_1 = 0.40 \mu\text{m}$ to $\lambda_2 = 0.76 \mu\text{m}$. Noting that $T = 3200 \text{ K}$, the blackbody radiation functions corresponding to $\lambda_1 T$ and $\lambda_2 T$ are determined from Table 12-2 to be

$$\lambda_1 T = (0.40 \mu\text{m})(3200 \text{ K}) = 1280 \mu\text{mK} \longrightarrow f_{\lambda_1} = 0.0043964$$

$$\lambda_2 T = (0.76 \mu\text{m})(3200 \text{ K}) = 2432 \mu\text{mK} \longrightarrow f_{\lambda_2} = 0.147114$$

Then the fraction of radiation emitted between these two wavelengths becomes

$$f_{\lambda_2} - f_{\lambda_1} = 0.147114 - 0.004396 = \mathbf{0.142718} \quad (\text{or } 14.3\%)$$

The wavelength at which the emission of radiation from the filament is maximum is

$$(\lambda T)_{\text{max power}} = 2897.8 \mu\text{m} \cdot \text{K} \longrightarrow \lambda_{\text{max power}} = \frac{2897.8 \mu\text{m} \cdot \text{K}}{3200 \text{ K}} = \mathbf{0.906 \text{ mm}}$$

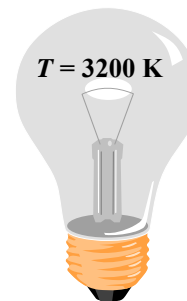

12-24 EES Prob. 12-23 is reconsidered. The effect of temperature on the fraction of radiation emitted in the visible range is to be investigated.

Analysis The problem is solved using EES, and the solution is given below.

"GIVEN"

$$T=3200 \text{ [K]}$$

$$\lambda_{1}=0.40 \text{ [micrometer]}$$

$$\lambda_{2}=0.76 \text{ [micrometer]}$$

"ANALYSIS"

$$E_{b,\lambda} = C_1 / (\lambda^5 \cdot (\exp(C_2 / (\lambda \cdot T)) - 1))$$

$$C_1 = 3.742 \times 10^8 \text{ [W-micrometer}^4\text{/m}^2\text{]}$$

$$C_2 = 1.439 \times 10^4 \text{ [micrometer-K]}$$

$$f_{\lambda} = \text{integral}(E_{b,\lambda}, \lambda, \lambda_1, \lambda_2) / E_b$$

$$E_b = \sigma \cdot T^4$$

$$\sigma = 5.67 \times 10^{-8} \text{ [W/m}^2\text{-K}^4\text{]} \text{ "Stefan-Boltzmann constant"}$$

T [K]	f_{λ}
1000	0.000007353
1200	0.0001032
1400	0.0006403
1600	0.002405
1800	0.006505
2000	0.01404
2200	0.02576
2400	0.04198
2600	0.06248
2800	0.08671
3000	0.1139
3200	0.143
3400	0.1732
3600	0.2036
3800	0.2336
4000	0.2623

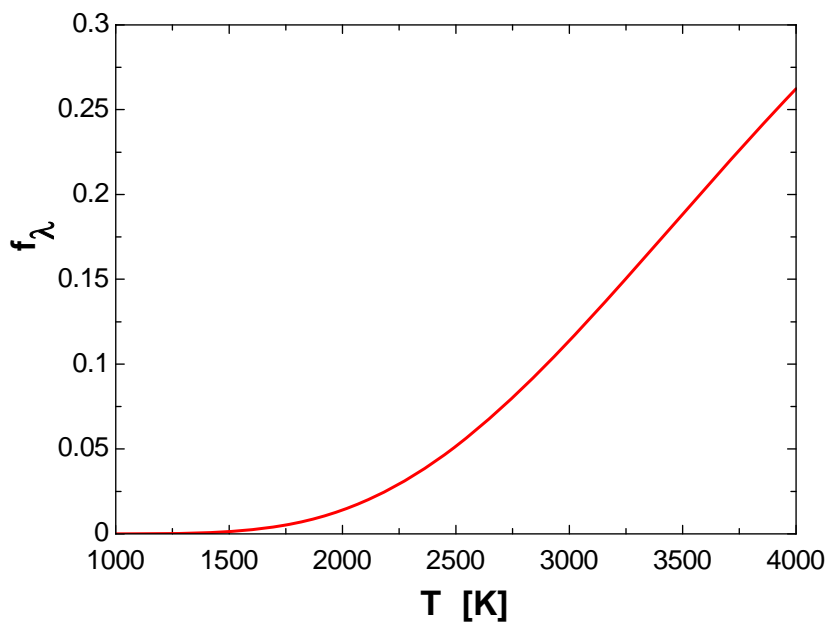

12-25 An incandescent light bulb emits 15% of its energy at wavelengths shorter than $0.8 \mu\text{m}$. The temperature of the filament is to be determined.

Assumptions The filament behaves as a black body.

Analysis From the Table 12-2 for the fraction of the radiation, we read

$$f_{\lambda} = 0.15 \longrightarrow \lambda T = 2445 \mu\text{mK}$$

For the wavelength range of $\lambda_1 = 0.0 \mu\text{m}$ to $\lambda_2 = 0.8 \mu\text{m}$

$$\lambda = 0.8 \mu\text{m} \longrightarrow \lambda T = 2445 \mu\text{mK} \longrightarrow T = \mathbf{3056 \text{ K}}$$

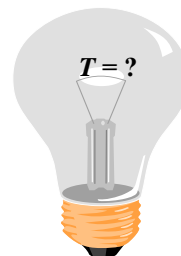

12-26 Radiation emitted by a light source is maximum in the blue range. The temperature of this light source and the fraction of radiation it emits in the visible range are to be determined.

Assumptions The light source behaves as a black body.

Analysis The temperature of this light source is

$$(\lambda T)_{\text{max power}} = 2897.8 \mu\text{m} \cdot \text{K} \longrightarrow T = \frac{2897.8 \mu\text{m} \cdot \text{K}}{0.47 \mu\text{m}} = \mathbf{6166 \text{ K}}$$

The visible range of the electromagnetic spectrum extends from $\lambda_1 = 0.40 \mu\text{m}$ to $\lambda_2 = 0.76 \mu\text{m}$. Noting that $T = 6166 \text{ K}$, the blackbody radiation functions corresponding to $\lambda_1 T$ and $\lambda_2 T$ are determined from Table 12-2 to be

$$\lambda_1 T = (0.40 \mu\text{m})(6166 \text{ K}) = 2466 \mu\text{mK} \longrightarrow f_{\lambda_1} = 0.15440$$

$$\lambda_2 T = (0.76 \mu\text{m})(6166 \text{ K}) = 4686 \mu\text{mK} \longrightarrow f_{\lambda_2} = 0.59144$$

Then the fraction of radiation emitted between these two wavelengths becomes

$$f_{\lambda_2} - f_{\lambda_1} = 0.59144 - 0.15440 \cong \mathbf{0.437} \quad (\text{or } 43.7\%)$$

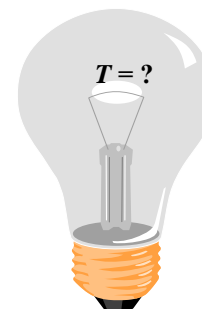

12-27 A glass window transmits 90% of the radiation in a specified wavelength range and is opaque for radiation at other wavelengths. The rate of radiation transmitted through this window is to be determined for two cases.

Assumptions The sources behave as a black body.

Analysis The surface area of the glass window is

$$A_s = 4 \text{ m}^2$$

(a) For a blackbody source at 5800 K, the total blackbody radiation emission is

$$E_b(T) = \sigma T^4 A_s = (5.67 \times 10^{-8} \text{ kW/m}^2 \cdot \text{K}^4)(5800 \text{ K})^4 (4 \text{ m}^2) = 2.567 \times 10^5 \text{ kW}$$

The fraction of radiation in the range of 0.3 to 3.0 μm is

$$\lambda_1 T = (0.30 \mu\text{m})(5800 \text{ K}) = 1740 \mu\text{mK} \longrightarrow f_{\lambda_1} = 0.03345$$

$$\lambda_2 T = (3.0 \mu\text{m})(5800 \text{ K}) = 17,400 \mu\text{mK} \longrightarrow f_{\lambda_2} = 0.97875$$

$$\Delta f = f_{\lambda_2} - f_{\lambda_1} = 0.97875 - 0.03345 = 0.9453$$

Noting that 90% of the total radiation is transmitted through the window,

$$\begin{aligned} E_{\text{transmit}} &= 0.90 \Delta f E_b(T) \\ &= (0.90)(0.9453)(2.567 \times 10^5 \text{ kW}) = \mathbf{2.184 \times 10^5 \text{ kW}} \end{aligned}$$

(b) For a blackbody source at 1000 K, the total blackbody emissive power is

$$E_b(T) = \sigma T^4 A_s = (5.67 \times 10^{-8} \text{ W/m}^2 \cdot \text{K}^4)(1000 \text{ K})^4 (4 \text{ m}^2) = 226.8 \text{ kW}$$

The fraction of radiation in the visible range of 0.3 to 3.0 μm is

$$\lambda_1 T = (0.30 \mu\text{m})(1000 \text{ K}) = 300 \mu\text{mK} \longrightarrow f_{\lambda_1} = 0.0000$$

$$\lambda_2 T = (3.0 \mu\text{m})(1000 \text{ K}) = 3000 \mu\text{mK} \longrightarrow f_{\lambda_2} = 0.273232$$

$$\Delta f = f_{\lambda_2} - f_{\lambda_1} = 0.273232 - 0$$

and

$$E_{\text{transmit}} = 0.90 \Delta f E_b(T) = (0.90)(0.273232)(226.8 \text{ kW}) = \mathbf{55.8 \text{ kW}}$$

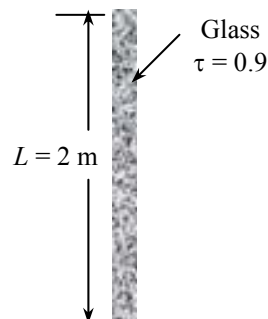
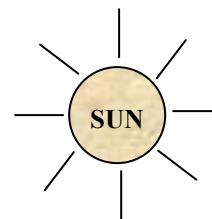

Radiation Intensity

12-28C A solid angle represents an opening in space, whereas a plain angle represents an opening in a plane. For a sphere of unit radius, the solid angle about the origin subtended by a given surface on the sphere is equal to the area of the surface. For a circle of unit radius, the plain angle about the origin subtended by a given arc is equal to the length of the arc. The value of a solid angle associated with a sphere is 4π .

12-29C The intensity of emitted radiation $I_e(\theta, \phi)$ is defined as the rate at which radiation energy $d\dot{Q}_e$ is emitted in the (θ, ϕ) direction per unit area normal to this direction and per unit solid angle about this direction. For a diffusely emitting surface, the emissive power is related to the intensity of emitted radiation by $E = \pi I_e$ (or $E_\lambda = \pi I_{\lambda,e}$ for spectral quantities).

12-30C Irradiation G is the radiation flux incident on a surface from all directions. For diffusely incident radiation, irradiation on a surface is related to the intensity of incident radiation by $G = \pi I_i$ (or $G_\lambda = \pi I_{\lambda,i}$ for spectral quantities).

12-31C Radiosity J is the rate at which radiation energy leaves a unit area of a surface by emission and reflection in all directions. For a diffusely emitting and reflecting surface, radiosity is related to the intensity of emitted and reflected radiation by $J = \pi I_{e+r}$ (or $J_\lambda = \pi I_{\lambda,e+r}$ for spectral quantities).

12-32C When the variation of a spectral radiation quantity with wavelength is known, the corresponding total quantity is determined by integrating that quantity with respect to wavelength from $\lambda = 0$ to $\lambda = \infty$.

12-33 A surface is subjected to radiation emitted by another surface. The solid angle subtended and the rate at which emitted radiation is received are to be determined.

Assumptions 1 Surface A_1 emits diffusely as a blackbody. **2** Both A_1 and A_2 can be approximated as differential surfaces since both are very small compared to the square of the distance between them.

Analysis Approximating both A_1 and A_2 as differential surfaces, the solid angle subtended by A_2 when viewed from A_1 can be determined from

$$\omega_{2-1} \cong \frac{A_{n,2}}{r^2} = \frac{A_2 \cos \theta_2}{r^2} = \frac{(8 \text{ cm}^2) \cos 60^\circ}{(80 \text{ cm})^2} = \mathbf{6.25 \times 10^{-4} \text{ sr}}$$

since the normal of A_2 makes 60° with the direction of viewing. Note that solid angle subtended by A_2 would be maximum if A_2 were positioned normal to the direction of viewing. Also, the point of viewing on A_1 is taken to be a point in the middle, but it can be any point since A_1 is assumed to be very small.

The radiation emitted by A_1 that strikes A_2 is equivalent to the radiation emitted by A_1 through the solid angle ω_{2-1} . The intensity of the radiation emitted by A_1 is

$$I_1 = \frac{E_b(T_1)}{\pi} = \frac{\sigma T_1^4}{\pi} = \frac{(5.67 \times 10^{-8} \text{ W/m}^2 \cdot \text{K}^4)(800 \text{ K})^4}{\pi} = 7393 \text{ W/m}^2 \cdot \text{sr}$$

This value of intensity is the same in all directions since a blackbody is a diffuse emitter. Intensity represents the rate of radiation emission per unit area normal to the direction of emission per unit solid angle. Therefore, the rate of radiation energy emitted by A_1 in the direction of θ_1 through the solid angle ω_{2-1} is determined by multiplying I_1 by the area of A_1 normal to θ_1 and the solid angle ω_{2-1} . That is,

$$\begin{aligned} \dot{Q}_{1-2} &= I_1 (A_1 \cos \theta_1) \omega_{2-1} \\ &= (7393 \text{ W/m}^2 \cdot \text{sr})(8 \times 10^{-4} \cos 45^\circ \text{ m}^2)(6.25 \times 10^{-4} \text{ sr}) \\ &= \mathbf{2.614 \times 10^{-3} \text{ W}} \end{aligned}$$

Therefore, the radiation emitted from surface A_1 will strike surface A_2 at a rate of $2.614 \times 10^{-3} \text{ W}$.

If A_2 were directly above A_1 at a distance 80 cm, $\theta_1 = 0^\circ$ and the rate of radiation energy emitted by A_1 becomes zero.

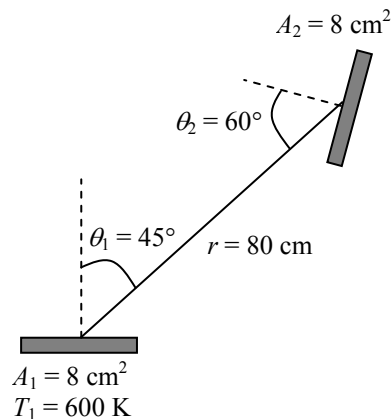

12-34 Radiation is emitted from a small circular surface located at the center of a sphere. Radiation energy streaming through a hole located on top of the sphere and the side of sphere are to be determined.

Assumptions 1 Surface A_1 emits diffusely as a blackbody. **2** Both A_1 and A_2 can be approximated as differential surfaces since both are very small compared to the square of the distance between them.

Analysis (a) Approximating both A_1 and A_2 as differential surfaces, the solid angle subtended by A_2 when viewed from A_1 can be determined from

$$\omega_{2-1} \cong \frac{A_{n,2}}{r^2} = \frac{A_2}{r^2} = \frac{\pi(0.005 \text{ m})^2}{(1 \text{ m})^2} = 7.854 \times 10^{-5} \text{ sr}$$

since A_2 were positioned normal to the direction of viewing.

The radiation emitted by A_1 that strikes A_2 is equivalent to the radiation emitted by A_1 through the solid angle ω_{2-1} . The intensity of the radiation emitted by A_1 is

$$I_1 = \frac{E_b(T_1)}{\pi} = \frac{\sigma T_1^4}{\pi} = \frac{(5.67 \times 10^{-8} \text{ W/m}^2 \cdot \text{K}^4)(1000 \text{ K})^4}{\pi} = 18,048 \text{ W/m}^2 \cdot \text{sr}$$

This value of intensity is the same in all directions since a blackbody is a diffuse emitter. Intensity represents the rate of radiation emission per unit area normal to the direction of emission per unit solid angle. Therefore, the rate of radiation energy emitted by A_1 in the direction of θ_1 through the solid angle ω_{2-1} is determined by multiplying I_1 by the area of A_1 normal to θ_1 and the solid angle ω_{2-1} . That is,

$$\begin{aligned} \dot{Q}_{1-2} &= I_1 (A_1 \cos \theta_1) \omega_{2-1} \\ &= (18,048 \text{ W/m}^2 \cdot \text{sr})(2 \times 10^{-4} \cos 0^\circ \text{ m}^2)(7.854 \times 10^{-5} \text{ sr}) \\ &= \mathbf{2.835 \times 10^{-4} \text{ W}} \end{aligned}$$

where $\theta_1 = 0^\circ$. Therefore, the radiation emitted from surface A_1 will strike surface A_2 at a rate of $2.835 \times 10^{-4} \text{ W}$.

(b) In this orientation, $\theta_1 = 45^\circ$ and $\theta_2 = 0^\circ$. Repeating the calculation we obtain the rate of radiation to be

$$\begin{aligned} \dot{Q}_{1-2} &= I_1 (A_1 \cos \theta_1) \omega_{2-1} \\ &= (18,048 \text{ W/m}^2 \cdot \text{sr})(2 \times 10^{-4} \cos 45^\circ \text{ m}^2)(7.854 \times 10^{-5} \text{ sr}) \\ &= \mathbf{2.005 \times 10^{-4} \text{ W}} \end{aligned}$$

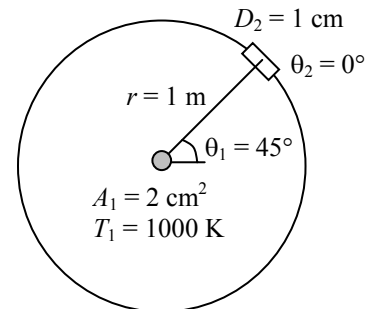
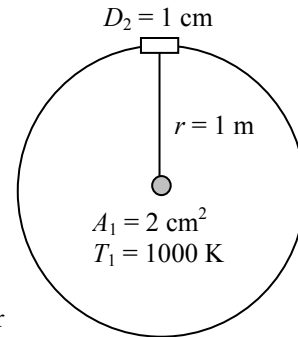

12-35 Radiation is emitted from a small circular surface located at the center of a sphere. Radiation energy streaming through a hole located on top of the sphere and the side of sphere are to be determined.

Assumptions 1 Surface A_1 emits diffusely as a blackbody. **2** Both A_1 and A_2 can be approximated as differential surfaces since both are very small compared to the square of the distance between them.

Analysis (a) Approximating both A_1 and A_2 as differential surfaces, the solid angle subtended by A_2 when viewed from A_1 can be determined from to be

$$\omega_{2-1} \cong \frac{A_{n,2}}{r^2} = \frac{A_2}{r^2} = \frac{\pi(0.005 \text{ m})^2}{(2 \text{ m})^2} = 1.963 \times 10^{-5} \text{ sr}$$

since A_2 were positioned normal to the direction of viewing.

The radiation emitted by A_1 that strikes A_2 is equivalent to the radiation emitted by A_1 through the solid angle ω_{2-1} . The intensity of the radiation emitted by A_1 is

$$I_1 = \frac{E_b(T_1)}{\pi} = \frac{\sigma T_1^4}{\pi} = \frac{(5.67 \times 10^{-8} \text{ W/m}^2 \cdot \text{K}^4)(1000 \text{ K})^4}{\pi} = 18,048 \text{ W/m}^2 \cdot \text{sr}$$

This value of intensity is the same in all directions since a blackbody is a diffuse emitter. Intensity represents the rate of radiation emission per unit area normal to the direction of emission per unit solid angle. Therefore, the rate of radiation energy emitted by A_1 in the direction of θ_1 through the solid angle ω_{2-1} is determined by multiplying I_1 by the area of A_1 normal to θ_1 and the solid angle ω_{2-1} . That is,

$$\begin{aligned} \dot{Q}_{1-2} &= I_1 (A_1 \cos \theta_1) \omega_{2-1} \\ &= (18,048 \text{ W/m}^2 \cdot \text{sr})(2 \times 10^{-4} \cos 0^\circ \text{ m}^2)(1.963 \times 10^{-5} \text{ sr}) \\ &= \mathbf{7.086 \times 10^{-5} \text{ W}} \end{aligned}$$

where $\theta_1 = 0^\circ$. Therefore, the radiation emitted from surface A_1 will strike surface A_2 at a rate of $2.835 \times 10^{-4} \text{ W}$.

(b) In this orientation, $\theta_1 = 45^\circ$ and $\theta_2 = 0^\circ$. Repeating the calculation we obtain the rate of radiation as

$$\begin{aligned} \dot{Q}_{1-2} &= I_1 (A_1 \cos \theta_1) \omega_{2-1} \\ &= (18,048 \text{ W/m}^2 \cdot \text{sr})(2 \times 10^{-4} \cos 45^\circ \text{ m}^2)(1.963 \times 10^{-5} \text{ sr}) \\ &= \mathbf{5.010 \times 10^{-5} \text{ W}} \end{aligned}$$

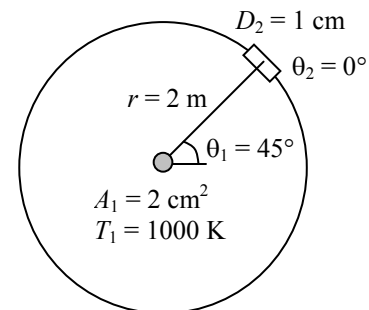
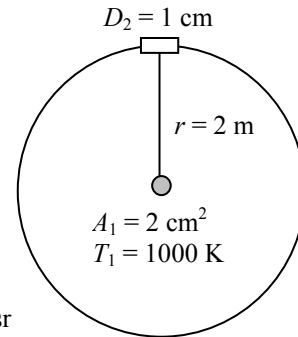

12-36 A small surface emits radiation. The rate of radiation energy emitted through a band is to be determined.

Assumptions Surface A emits diffusely as a blackbody.

Analysis The rate of radiation emission from a surface per unit surface area in the direction (θ, ϕ) is given as

$$dE = \frac{d\dot{Q}_e}{dA} = I_e(\theta, \phi) \cos \theta \sin \theta d\theta d\phi$$

The total rate of radiation emission through the band between 60° and 45° can be expressed as

$$E = \int_{\phi=0}^{2\pi} \int_{\theta=45}^{60} I_e(\theta, \phi) \cos \theta \sin \theta d\theta d\phi = I_b \frac{\pi}{4} = \frac{\sigma T^4}{\pi} \frac{\pi}{4} = \frac{\sigma T^4}{4}$$

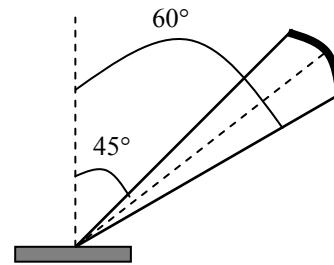

$$A = 1 \text{ cm}^2 \\ T = 1800 \text{ K}$$

since the blackbody radiation intensity is constant ($I_b = \text{constant}$), and

$$\int_{\phi=0}^{2\pi} \int_{\theta=45}^{60} \cos \theta \sin \theta d\theta d\phi = 2\pi \int_{\theta=45}^{60} \cos \theta \sin \theta d\theta = \pi(\sin^2 60 - \sin^2 45) = \pi / 4$$

Approximating a small area as a differential area, the rate of radiation energy emitted from an area of 1 cm^2 in the specified band becomes

$$\dot{Q}_e = E dA = \frac{\sigma T^4}{4} dA = \frac{(5.67 \times 10^{-8} \text{ W/m}^2 \cdot \text{K}^4)(1800 \text{ K})^4}{4} (1 \times 10^{-4} \text{ m}^2) = \mathbf{14.9 \text{ W}}$$

12-37 A small surface is subjected to uniform incident radiation. The rates of radiation emission through two specified bands are to be determined.

Assumptions The intensity of incident radiation is constant.

Analysis (a) The rate at which radiation is incident on a surface per unit surface area in the direction (θ, ϕ) is given as

$$dG = \frac{d\dot{Q}_i}{dA} = I_i(\theta, \phi) \cos \theta \sin \theta d\theta d\phi$$

The total rate of radiation emission through the band between 0° and 45° can be expressed as

$$G_1 = \int_{\phi=0}^{2\pi} \int_{\theta=0}^{45} I_i(\theta, \phi) \cos \theta \sin \theta d\theta d\phi = I_i \frac{\pi}{2}$$

since the incident radiation is constant ($I_i = \text{constant}$), and

$$\int_{\phi=0}^{2\pi} \int_{\theta=0}^{45} \cos \theta \sin \theta d\theta d\phi = 2\pi \int_{\theta=0}^{45} \cos \theta \sin \theta d\theta = \pi(\sin^2 45 - \sin^2 0) = \pi/2$$

Approximating a small area as a differential area, the rate of radiation energy emitted from an area of 1 cm^2 in the specified band becomes

$$\dot{Q}_{i,1} = G_1 dA = 0.5\pi I_i dA = 0.5\pi(2.2 \times 10^4 \text{ W/m}^2 \cdot \text{sr})(1 \times 10^{-4} \text{ m}^2) = \mathbf{3.46 \text{ W}}$$

(b) Similarly, the total rate of radiation emission through the band between 45° and 90° can be expressed as

$$G_1 = \int_{\phi=0}^{2\pi} \int_{\theta=45}^{90} I_i(\theta, \phi) \cos \theta \sin \theta d\theta d\phi = I_i \frac{\pi}{2}$$

since

$$\begin{aligned} \int_{\phi=0}^{2\pi} \int_{\theta=45}^{90} \cos \theta \sin \theta d\theta d\phi &= 2\pi \int_{\theta=45}^{90} \cos \theta \sin \theta d\theta \\ &= \pi(\sin^2 90 - \sin^2 45) = \pi/2 \end{aligned}$$

and

$$\dot{Q}_{i,2} = G_2 dA = 0.5\pi I_i dA = 0.5\pi(2.2 \times 10^4 \text{ W/m}^2 \cdot \text{sr})(1 \times 10^{-4} \text{ m}^2) = \mathbf{3.46 \text{ W}}$$

Discussion Note that the viewing area for the band $0^\circ - 45^\circ$ is much smaller, but the radiation energy incident through it is equal to the energy streaming through the remaining area.

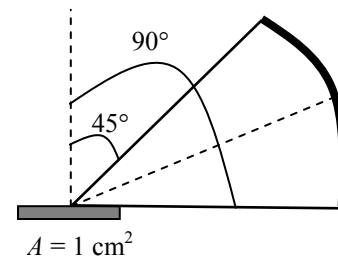
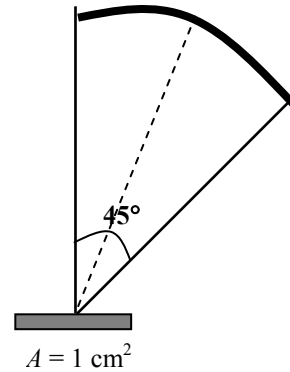

Radiation Properties

12-38C The emissivity ε is the ratio of the radiation emitted by the surface to the radiation emitted by a blackbody at the same temperature. The fraction of radiation absorbed by the surface is called the absorptivity α ,

$$\varepsilon(T) = \frac{E(T)}{E_b(T)} \quad \text{and} \quad \alpha = \frac{\text{absorbed radiation}}{\text{incident radiation}} = \frac{G_{abs}}{G}$$

When the surface temperature is equal to the temperature of the source of radiation, the total hemispherical emissivity of a surface at temperature T is equal to its total hemispherical absorptivity for radiation coming from a blackbody at the same temperature $\varepsilon_\lambda(T) = \alpha_\lambda(T)$.

12-39C The fraction of irradiation reflected by the surface is called reflectivity ρ and the fraction transmitted is called the transmissivity τ

$$\rho = \frac{G_{ref}}{G} \quad \text{and} \quad \tau = \frac{G_{tr}}{G}$$

Surfaces are assumed to reflect in a perfectly spectral or diffuse manner for simplicity. In spectral (or mirror like) reflection, the angle of reflection equals the angle of incidence of the radiation beam. In diffuse reflection, radiation is reflected equally in all directions.

12-40C A body whose surface properties are independent of wavelength is said to be a graybody. The emissivity of a blackbody is one for all wavelengths, the emissivity of a graybody is between zero and one.

12-41C The heating effect which is due to the non-gray characteristic of glass, clear plastic, or atmospheric gases is known as the greenhouse effect since this effect is utilized primarily in greenhouses. The combustion gases such as CO_2 and water vapor in the atmosphere transmit the bulk of the solar radiation but absorb the infrared radiation emitted by the surface of the earth, acting like a heat trap. There is a concern that the energy trapped on earth will eventually cause global warming and thus drastic changes in weather patterns.

12-42C Glass has a transparent window in the wavelength range 0.3 to $3 \mu\text{m}$ and it is not transparent to the radiation which has wavelength range greater than $3 \mu\text{m}$. Therefore, because the microwaves are in the range of 10^2 to $10^5 \mu\text{m}$, the harmful microwave radiation cannot escape from the glass door.

12-43 The variation of emissivity of a surface at a specified temperature with wavelength is given. The average emissivity of the surface and its emissive power are to be determined.

Analysis The average emissivity of the surface can be determined from

$$\begin{aligned}\varepsilon(T) &= \frac{\varepsilon_1 \int_0^{\lambda_1} E_{b_\lambda}(T) d\lambda}{\sigma T^4} + \frac{\varepsilon_2 \int_{\lambda_1}^{\lambda_2} E_{b_\lambda}(T) d\lambda}{\sigma T^4} + \frac{\varepsilon_3 \int_{\lambda_2}^{\infty} E_{b_\lambda}(T) d\lambda}{\sigma T^4} \\ &= \varepsilon_1 f_{0-\lambda_1} + \varepsilon_2 f_{\lambda_1-\lambda_2} + \varepsilon_3 f_{\lambda_2-\infty} \\ &= \varepsilon_1 f_{\lambda_1} + \varepsilon_2 (f_{\lambda_2} - f_{\lambda_1}) + \varepsilon_3 (1 - f_{\lambda_2})\end{aligned}$$

where f_{λ_1} and f_{λ_2} are blackbody radiation functions corresponding to $\lambda_1 T$ and $\lambda_2 T$, determined from

$$\lambda_1 T = (2 \mu\text{m})(1000 \text{ K}) = 2000 \mu\text{mK} \longrightarrow f_{\lambda_1} = 0.066728$$

$$\lambda_2 T = (6 \mu\text{m})(1000 \text{ K}) = 6000 \mu\text{mK} \longrightarrow f_{\lambda_2} = 0.737818$$

$$f_{0-\lambda_1} = f_{\lambda_1} - f_0 = f_{\lambda_1} \text{ since } f_0 = 0 \text{ and } f_{\lambda_2-\infty} = f_\infty - f_{\lambda_2} \text{ since } f_\infty = 1.$$

and,

$$\varepsilon = (0.4)0.066728 + (0.7)(0.737818 - 0.066728) + (0.3)(1 - 0.737818) = \mathbf{0.575}$$

Then the emissive power of the surface becomes

$$E = \varepsilon \sigma T^4 = 0.575(5.67 \times 10^{-8} \text{ W/m}^2 \cdot \text{K}^4)(1000 \text{ K})^4 = \mathbf{32.6 \text{ kW/m}^2}$$

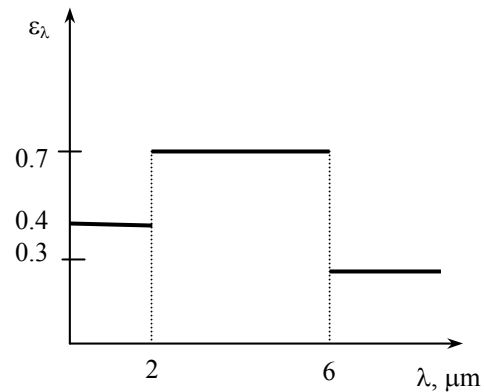

12-44 The variation of reflectivity of a surface with wavelength is given. The average reflectivity, emissivity, and absorptivity of the surface are to be determined for two source temperatures.

Analysis The average reflectivity of this surface for solar radiation ($T = 5800$ K) is determined to be

$$\lambda T = (3 \mu\text{m})(5800 \text{ K}) = 17400 \mu\text{mK} \rightarrow f_{\lambda} = 0.978746$$

$$\begin{aligned} \rho(T) &= \rho_1 f_{0-\lambda_1}(T) + \rho_2 f_{\lambda_1-\infty}(T) \\ &= \rho_1 f_{\lambda_1} + \rho_2 (1 - f_{\lambda_1}) \\ &= (0.35)(0.978746) + (0.95)(1 - 0.978746) \\ &= \mathbf{0.362} \end{aligned}$$

Noting that this is an opaque surface, $\tau = 0$

$$\text{At } T = 5800 \text{ K: } \alpha + \rho = 1 \rightarrow \alpha = 1 - \rho = 1 - 0.362 = \mathbf{0.638}$$

Repeating calculations for radiation coming from surfaces at $T = 300$ K,

$$\lambda T = (3 \mu\text{m})(300 \text{ K}) = 900 \mu\text{mK} \rightarrow f_{\lambda_1} = 0.0001685$$

$$\rho(T) = (0.35)(0.0001685) + (0.95)(1 - 0.0001685) = \mathbf{0.95}$$

$$\text{At } T = 300 \text{ K: } \alpha + \rho = 1 \rightarrow \alpha = 1 - \rho = 1 - 0.95 = \mathbf{0.05}$$

and $\varepsilon = \alpha = \mathbf{0.05}$

The temperature of the aluminum plate is close to room temperature, and thus emissivity of the plate will be equal to its absorptivity at room temperature. That is,

$$\varepsilon = \varepsilon_{\text{room}} = 0.05$$

$$\alpha = \alpha_s = 0.638$$

which makes it suitable as a solar collector. ($\alpha_s = 1$ and $\varepsilon_{\text{room}} = 0$ for an ideal solar collector)

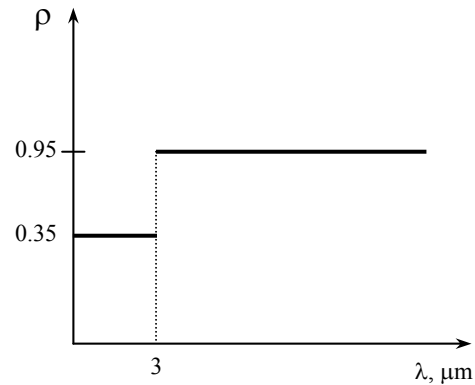

12-45 The variation of transmissivity of the glass window of a furnace at a specified temperature with wavelength is given. The fraction and the rate of radiation coming from the furnace and transmitted through the window are to be determined.

Assumptions The window glass behaves as a black body.

Analysis The fraction of radiation at wavelengths smaller than $3 \mu\text{m}$ is

$$\lambda T = (3 \mu\text{m})(1200 \text{ K}) = 3600 \mu\text{mK} \rightarrow f_{\lambda} = 0.403607$$

The fraction of radiation coming from the furnace and transmitted through the window is

$$\begin{aligned} \tau(T) &= \tau_1 f_{\lambda} + \tau_2 (1 - f_{\lambda}) \\ &= (0.7)(0.403607) + (0)(1 - 0.403607) \\ &= \mathbf{0.2825} \end{aligned}$$

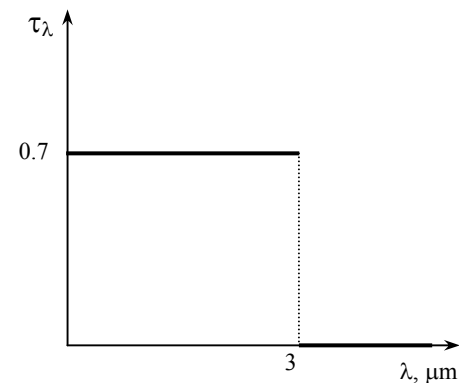

Then the rate of radiation coming from the furnace and transmitted through the window becomes

$$G_{tr} = \tau A \sigma T^4 = 0.2825(0.40 \times 0.40 \text{ m}^2)(5.67 \times 10^{-8} \text{ W/m}^2 \cdot \text{K}^4)(1200 \text{ K})^4 = \mathbf{5315 \text{ W}}$$

12-46 The variation of emissivity of a tungsten filament with wavelength is given. The average emissivity, absorptivity, and reflectivity of the filament are to be determined for two temperatures.

Analysis (a) $T = 2000$ K

$$\lambda_1 T = (1 \mu\text{m})(2000 \text{ K}) = 2000 \mu\text{mK} \longrightarrow f_{\lambda_1} = 0.066728$$

The average emissivity of this surface is

$$\begin{aligned} \varepsilon(T) &= \varepsilon_1 f_{\lambda_1} + \varepsilon_2 (1 - f_{\lambda_1}) \\ &= (0.5)(0.066728) + (0.15)(1 - 0.066728) \\ &= \mathbf{0.173} \end{aligned}$$

From Kirchhoff's law,

$$\varepsilon = \alpha = \mathbf{0.173} \quad (\text{at } 2000 \text{ K})$$

and $\alpha + \rho = 1 \longrightarrow \rho = 1 - \alpha = 1 - 0.173 = \mathbf{0.827}$

(b) $T = 3000$ K

$$\lambda_1 T = (1 \mu\text{m})(3000 \text{ K}) = 3000 \mu\text{mK} \longrightarrow f_{\lambda_1} = 0.273232$$

Then

$$\varepsilon(T) = \varepsilon_1 f_{\lambda_1} + \varepsilon_2 (1 - f_{\lambda_1}) = (0.5)(0.273232) + (0.15)(1 - 0.273232) = \mathbf{0.246}$$

From Kirchhoff's law,

$$\varepsilon = \alpha = \mathbf{0.246} \quad (\text{at } 3000 \text{ K})$$

and $\alpha + \rho = 1 \longrightarrow \rho = 1 - \alpha = 1 - 0.246 = \mathbf{0.754}$

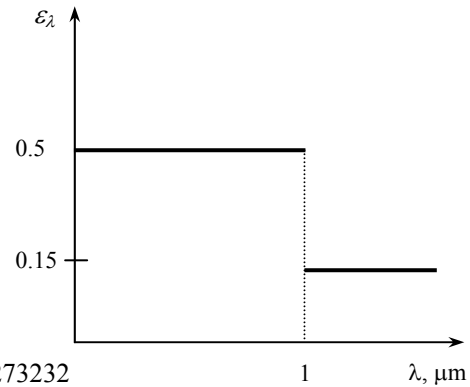

12-47 The variations of emissivity of two surfaces are given. The average emissivity, absorptivity, and reflectivity of each surface are to be determined at the given temperature.

Analysis For the first surface:

$$\lambda_1 T = (3 \mu\text{m})(3000 \text{ K}) = 9000 \mu\text{mK} \longrightarrow f_{\lambda_1} = 0.890029$$

The average emissivity of this surface is

$$\begin{aligned} \varepsilon(T) &= \varepsilon_1 f_{\lambda_1} + \varepsilon_2 (1 - f_{\lambda_1}) \\ &= (0.2)(0.890029) + (0.9)(1 - 0.890029) \\ &= \mathbf{0.28} \end{aligned}$$

The absorptivity and reflectivity are determined from Kirchhoff's law

$$\begin{aligned} \varepsilon &= \alpha = \mathbf{0.28} \quad (\text{at } 3000 \text{ K}) \\ \alpha + \rho &= 1 \longrightarrow \rho = 1 - \alpha = 1 - 0.28 = \mathbf{0.72} \end{aligned}$$

For the second surface:

$$\lambda_1 T = (3 \mu\text{m})(3000 \text{ K}) = 9000 \mu\text{mK} \longrightarrow f_{\lambda_1} = 0.890029$$

The average emissivity of this surface is

$$\begin{aligned} \varepsilon(T) &= \varepsilon_1 f_{\lambda_1} + \varepsilon_2 (1 - f_{\lambda_1}) \\ &= (0.8)(0.890029) + (0.1)(1 - 0.890029) \\ &= \mathbf{0.72} \end{aligned}$$

Then,

$$\begin{aligned} \varepsilon &= \alpha = \mathbf{0.72} \quad (\text{at } 3000 \text{ K}) \\ \alpha + \rho &= 1 \rightarrow \rho = 1 - \alpha = 1 - 0.72 = \mathbf{0.28} \end{aligned}$$

Discussion The second surface is more suitable to serve as a solar absorber since its absorptivity for short wavelength radiation (typical of radiation emitted by a high-temperature source such as the sun) is high, and its emissivity for long wavelength radiation (typical of emitted radiation from the absorber plate) is low.

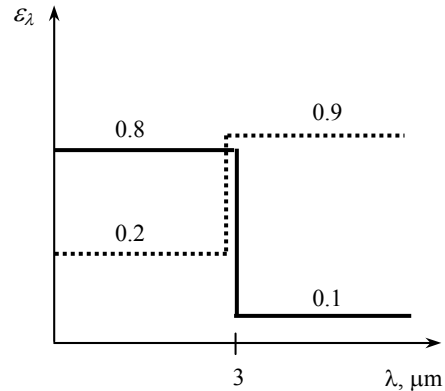

12-48 The variation of emissivity of a surface with wavelength is given. The average emissivity and absorptivity of the surface are to be determined for two temperatures.

Analysis (a) For $T = 5800 \text{ K}$:

$$\lambda_1 T = (5 \mu\text{m})(5800 \text{ K}) = 29,000 \mu\text{mK} \longrightarrow f_{\lambda_1} = 0.994715$$

The average emissivity of this surface is

$$\begin{aligned} \varepsilon(T) &= \varepsilon_1 f_{\lambda_1} + \varepsilon_2 (1 - f_{\lambda_1}) \\ &= (0.15)(0.994715) + (0.9)(1 - 0.994715) \\ &= \mathbf{0.154} \end{aligned}$$

(b) For $T = 300 \text{ K}$:

$$\lambda_1 T = (5 \mu\text{m})(300 \text{ K}) = 1500 \mu\text{mK} \longrightarrow f_{\lambda_1} = 0.013754$$

and

$$\begin{aligned} \varepsilon(T) &= \varepsilon_1 f_{\lambda_1} + \varepsilon_2 (1 - f_{\lambda_1}) \\ &= (0.15)(0.013754) + (0.9)(1 - 0.013754) \\ &= \mathbf{0.89} \end{aligned}$$

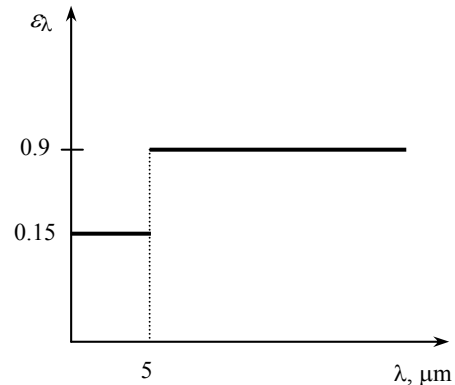

The absorptivities of this surface for radiation coming from sources at 5800 K and 300 K are, from Kirchhoff's law,

$$\alpha = \varepsilon = \mathbf{0.154} \quad (\text{at } 5800 \text{ K})$$

$$\alpha = \varepsilon = \mathbf{0.89} \quad (\text{at } 300 \text{ K})$$

12-49 The variation of absorptivity of a surface with wavelength is given. The average absorptivity, reflectivity, and emissivity of the surface are to be determined at given temperatures.

Analysis For $T = 2500 \text{ K}$:

$$\lambda_1 T = (2 \mu\text{m})(2500 \text{ K}) = 5000 \mu\text{mK} \longrightarrow f_{\lambda_1} = 0.633747$$

The average absorptivity of this surface is

$$\begin{aligned} \alpha(T) &= \alpha_1 f_{\lambda_1} + \alpha_2 (1 - f_{\lambda_1}) \\ &= (0.2)(0.633747) + (0.7)(1 - 0.633747) \\ &= \mathbf{0.38} \end{aligned}$$

Then the reflectivity of this surface becomes

$$\alpha + \rho = 1 \longrightarrow \rho = 1 - \alpha = 1 - 0.38 = \mathbf{0.62}$$

Using Kirchhoff's law, $\alpha = \varepsilon$, the average emissivity of this surface at $T = 3000 \text{ K}$ is determined to be

$$\lambda T = (2 \mu\text{m})(3000 \text{ K}) = 6000 \mu\text{mK} \longrightarrow f_{\lambda} = 0.737818$$

$$\begin{aligned} \varepsilon(T) &= \varepsilon_1 f_{\lambda} + \varepsilon_2 (1 - f_{\lambda}) \\ &= (0.2)(0.737818) + (0.7)(1 - 0.737818) \\ &= \mathbf{0.33} \end{aligned}$$

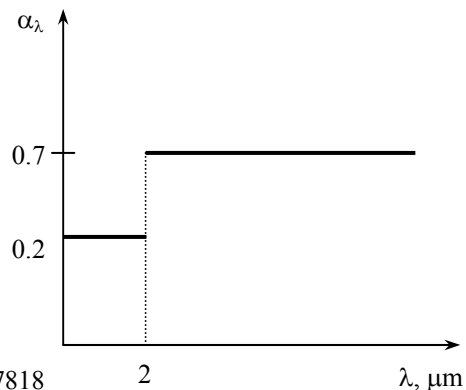

12-50E A spherical ball emits radiation at a certain rate. The average emissivity of the ball is to be determined at the given temperature.

Analysis The surface area of the ball is

$$A = \pi D^2 = \pi(5/12 \text{ ft})^2 = 0.5454 \text{ ft}^2$$

Then the average emissivity of the ball at this temperature is determined to be

$$E = \varepsilon A \sigma T^4 \longrightarrow \varepsilon = \frac{E}{A \sigma T^4} = \frac{550 \text{ Btu/h}}{(0.5454 \text{ ft}^2)(0.1714 \times 10^{-8} \text{ Btu/h} \cdot \text{ft}^2 \cdot \text{R}^4)(950 \text{ R})^4} = \mathbf{0.722}$$

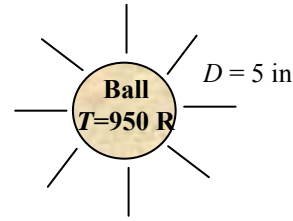

12-51 The variation of transmissivity of a glass is given. The average transmissivity of the pane at two temperatures and the amount of solar radiation transmitted through the pane are to be determined.

Analysis For $T=5800 \text{ K}$:

$$\lambda_1 T_1 = (0.3 \mu\text{m})(5800 \text{ K}) = 1740 \mu\text{mK}$$

$$\longrightarrow f_{\lambda_1} = 0.033454$$

$$\lambda_2 T_1 = (3 \mu\text{m})(5800 \text{ K}) = 17,400 \mu\text{mK}$$

$$\longrightarrow f_{\lambda_2} = 0.978746$$

The average transmissivity of this surface is

$$\begin{aligned} \tau(T) &= \tau_1 (f_{\lambda_2} - f_{\lambda_1}) \\ &= (0.92)(0.978746 - 0.033454) = \mathbf{0.870} \end{aligned}$$

For $T=300 \text{ K}$:

$$\lambda_1 T_2 = (0.3 \mu\text{m})(300 \text{ K}) = 90 \mu\text{mK} \longrightarrow f_{\lambda_1} = 0.0$$

$$\lambda_2 T_2 = (3 \mu\text{m})(300 \text{ K}) = 900 \mu\text{mK} \longrightarrow f_{\lambda_2} = 0.0001685$$

Then,

$$\tau(T) = \tau_1 (f_{\lambda_2} - f_{\lambda_1}) = (0.92)(0.0001685 - 0.0) = \mathbf{0.00016} \approx \mathbf{0}$$

The amount of solar radiation transmitted through this glass is

$$G_{\text{tr}} = \tau G_{\text{incident}} = 0.870(650 \text{ W/m}^2) = \mathbf{566 \text{ W/m}^2}$$

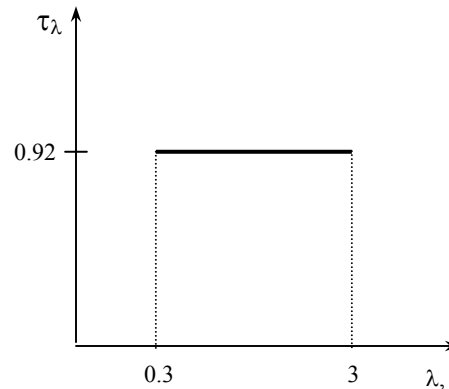

Atmospheric and Solar Radiation

12-52C The solar constant represents the rate at which solar energy is incident on a surface normal to sun's rays at the outer edge of the atmosphere when the earth is at its mean distance from the sun. Its value is $G_s = 1353 \text{ W/m}^2$. The solar constant is used to estimate the effective surface temperature of the sun from the requirement that

$$(4\pi L^2)G_{s1} = (4\pi r^2)\sigma T_{sun}^4$$

where L is the mean distance between the sun and the earth and r is the radius of the sun. If the distance between the earth and the sun doubled, the value of G_s drops to one-fourth since

$$4\pi(2L)^2 G_{s2} = (4\pi r^2)\sigma T_{sun}^4$$

$$16\pi L^2 G_{s2} = (4\pi r^2)\sigma T_{sun}^4$$

$$16\pi L^2 G_{s2} = 4\pi L^2 G_{s1} \longrightarrow G_{s2} = \frac{G_{s1}}{4}$$

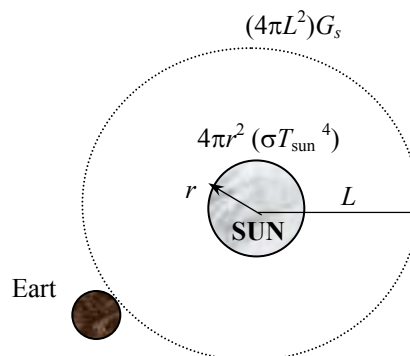

12-53C The amount of solar radiation incident on earth will decrease by a factor of

$$\text{Reduction factor} = \frac{\sigma T_{sun}^4}{\sigma T_{sun,new}^4} = \frac{5762^4}{2000^4} = 68.9$$

(or to 1.5% of what it was). Also, the fraction of radiation in the visible range would be much smaller.

12-54C Air molecules scatter blue light much more than they do red light. This molecular scattering in all directions is what gives the sky its bluish color. At sunset, the light travels through a thicker layer of atmosphere, which removes much of the blue from the natural light, letting the red dominate.

12-55C The reason for different seasons is the tilt of the earth which causes the solar radiation to travel through a longer path in the atmosphere in winter, and a shorter path in summer. Therefore, the solar radiation is attenuated much more strongly in winter.

12-56C The gas molecules and the suspended particles in the atmosphere emit radiation as well as absorbing it. Although this emission is far from resembling the distribution of radiation from a blackbody, it is found convenient in radiation calculations to treat the atmosphere as a blackbody at some lower fictitious temperature that emits an equivalent amount of radiation energy. This fictitious temperature is called the effective sky temperature T_{sky} .

12-57C There is heat loss from both sides of the bridge (top and bottom surfaces of the bridge) which reduces temperature of the bridge surface to very low values. The relatively warm earth under a highway supply heat to the surface continuously, making the water on it less likely to freeze.

12-58C Due to its nearly horizontal orientation, windshield exchanges heat with the sky that is at very low temperature. Side windows on the other hand exchange heat with surrounding surfaces that are at relatively high temperature.

12-59C Because of different wavelengths of solar radiation and radiation originating from surrounding bodies, the surfaces usually have quite different absorptivities. Solar radiation is concentrated in the short wavelength region and the surfaces in the infrared region.

12-60 A surface is exposed to solar and sky radiation. The net rate of radiation heat transfer is to be determined.

Properties The solar absorptivity and emissivity of the surface are given to $\alpha_s = 0.85$ and $\varepsilon = 0.5$.

Analysis The total solar energy incident on the surface is

$$\begin{aligned} G_{solar} &= G_D \cos \theta + G_d \\ &= (350 \text{ W/m}^2) \cos 30^\circ + (400 \text{ W/m}^2) \\ &= 703.1 \text{ W/m}^2 \end{aligned}$$

Then the net rate of radiation heat transfer in this case becomes

$$\begin{aligned} \dot{q}_{net,rad} &= \alpha_s G_{solar} - \varepsilon \sigma (T_s^4 - T_{sky}^4) \\ &= 0.85(703.1 \text{ W/m}^2) - 0.5(5.67 \times 10^{-8} \text{ W/m}^2 \cdot \text{K}^4) [(350 \text{ K})^4 - (280 \text{ K})^4] \\ &= \mathbf{346 \text{ W/m}^2} \text{ (to the surface)} \end{aligned}$$

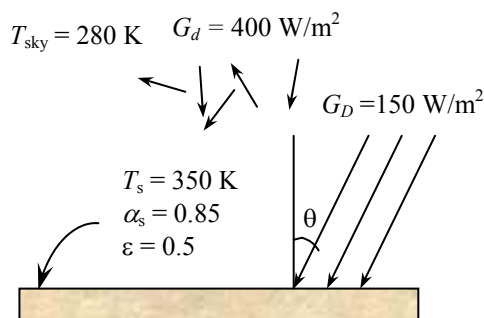

12-61E A surface is exposed to solar and sky radiation. The equilibrium temperature of the surface is to be determined.

Properties The solar absorptivity and emissivity of the surface are given to $\alpha_s = 0.10$ and $\varepsilon = 0.6$.

Analysis The equilibrium temperature of the surface in this case is

$$\begin{aligned} \dot{q}_{net,rad} &= \alpha_s G_{solar} - \varepsilon \sigma (T_s^4 - T_{sky}^4) = 0 \\ \alpha_s G_{solar} &= \varepsilon \sigma (T_s^4 - T_{sky}^4) \\ 0.10(400 \text{ Btu/h}\cdot\text{ft}^2) &= 0.6(0.1714 \times 10^{-8} \text{ Btu/h}\cdot\text{ft}^2 \cdot \text{R}^4) [T_s^4 - (0 \text{ R})^4] \\ T_s &= \mathbf{444 \text{ R}} \end{aligned}$$

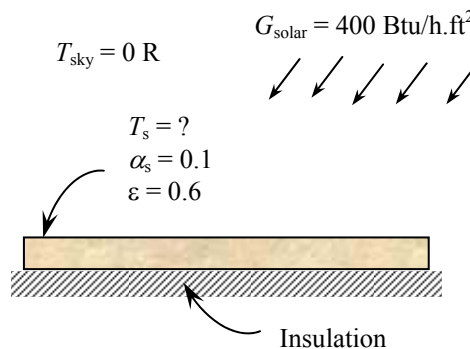

12-62 Water is observed to have frozen one night while the air temperature is above freezing temperature. The effective sky temperature is to be determined.

Properties The emissivity of water is $\varepsilon = 0.95$ (Table A-18).

Analysis Assuming the water temperature to be 0°C , the value of the effective sky temperature is determined from an energy balance on water to be

$$h(T_{\text{air}} - T_{\text{surface}}) = \varepsilon\sigma(T_s^4 - T_{\text{sky}}^4)$$

and

$$(18 \text{ W/m}^2 \cdot ^\circ\text{C})(4^\circ\text{C} - 0^\circ\text{C}) = 0.95(5.67 \times 10^{-8} \text{ W/m}^2 \cdot \text{K}^4) \left[(273 \text{ K})^4 - T_{\text{sky}}^4 \right]$$

$$\longrightarrow T_{\text{sky}} = \mathbf{254.8 \text{ K}}$$

Therefore, the effective sky temperature must have been below 255 K.

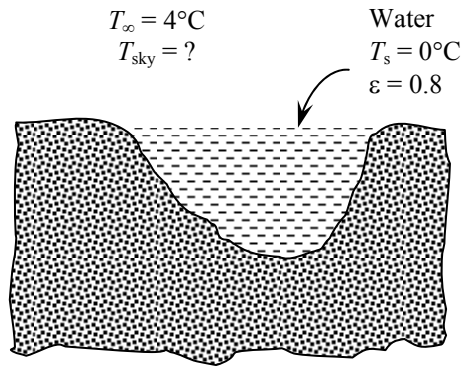

12-63 The absorber plate of a solar collector is exposed to solar and sky radiation. The net rate of solar energy absorbed by the absorber plate is to be determined.

Properties The solar absorptivity and emissivity of the surface are given to $\alpha_s = 0.87$ and $\varepsilon = 0.09$.

Analysis The net rate of solar energy delivered by the absorber plate to the water circulating behind it can be determined from an energy balance to be

$$\begin{aligned} \dot{q}_{\text{net}} &= \dot{q}_{\text{gain}} - \dot{q}_{\text{loss}} \\ \dot{q}_{\text{net}} &= \alpha_s G_{\text{solar}} - \left[\varepsilon\sigma(T_s^4 - T_{\text{sky}}^4) + h(T_s - T_{\text{air}}) \right] \end{aligned}$$

Then,

$$\begin{aligned} \dot{q}_{\text{net}} &= 0.87(600 \text{ W/m}^2) - 0.09(5.67 \times 10^{-8} \text{ W/m}^2 \cdot \text{K}^4) \left[(70 + 273 \text{ K})^4 - (15 + 273 \text{ K})^4 \right] \\ &\quad - (10 \text{ W/m}^2 \cdot \text{K})(70^\circ\text{C} - 25^\circ\text{C}) \\ &= \mathbf{36.5 \text{ W/m}^2} \end{aligned}$$

Therefore, heat is gained by the plate and transferred to water at a rate of 36.5 W per m^2 surface area.

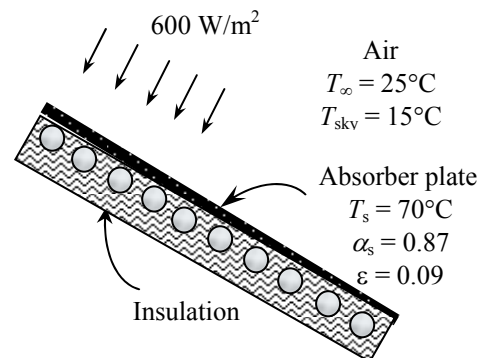

12-64 EES Prob. 12-63 is reconsidered. The net rate of solar energy transferred to water as a function of the absorptivity of the absorber plate is to be plotted.

Analysis The problem is solved using EES, and the solution is given below.

"GIVEN"

alpha_s=0.87

epsilon=0.09

G_solar=600 [W/m^2]

T_air=25+273 "[K]"

T_sky=15+273 "[K]"

T_s=70+273 "[K]"

h=10 [W/m^2-C]

sigma=5.67E-8 [W/m^2-K^4] "Stefan-Boltzmann constant"

"ANALYSIS"

q_dot_net=q_dot_gain-q_dot_loss "energy balance"

q_dot_gain=alpha_s*G_solar

q_dot_loss=epsilon*sigma*(T_s^4-T_sky^4)+h*(T_s-T_air)

α_s	\dot{q}_{net} [W/m ²]
0.5	-185.5
0.525	-170.5
0.55	-155.5
0.575	-140.5
0.6	-125.5
0.625	-110.5
0.65	-95.52
0.675	-80.52
0.7	-65.52
0.725	-50.52
0.75	-35.52
0.775	-20.52
0.8	-5.525
0.825	9.475
0.85	24.48
0.875	39.48
0.9	54.48
0.925	69.48
0.95	84.48
0.975	99.48
1	114.5

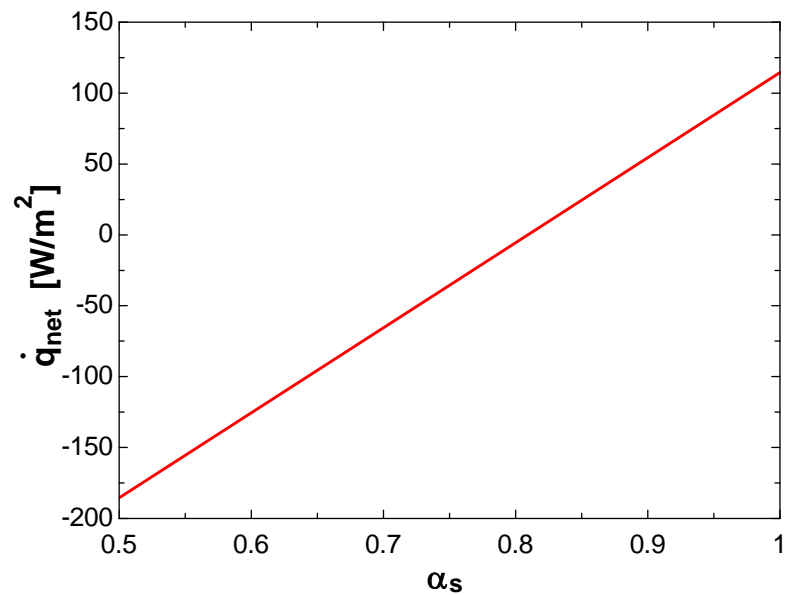

12-65 The absorber surface of a solar collector is exposed to solar and sky radiation. The equilibrium temperature of the absorber surface is to be determined if the backside of the plate is insulated.

Properties The solar absorptivity and emissivity of the surface are given to $\alpha_s = 0.87$ and $\varepsilon = 0.09$.

Analysis The backside of the absorbing plate is insulated (instead of being attached to water tubes), and thus

$$\dot{q}_{net} = 0$$

$$\alpha_s G_{solar} = \varepsilon \sigma (T_s^4 - T_{sky}^4) + h(T_s - T_{air})$$

$$(0.87)(600 \text{ W/m}^2) = (0.09)(5.67 \times 10^{-8} \text{ W/m}^2 \cdot \text{K}^4) [T_s^4 - (288 \text{ K})^4] + (10 \text{ W/m}^2 \cdot \text{K})(T_s - 298 \text{ K})$$

$$T_s = \mathbf{346 \text{ K}}$$

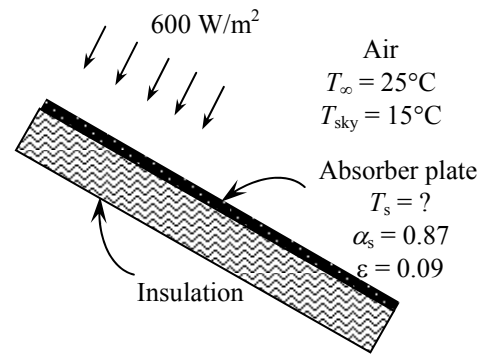

Special Topic: Solar Heat Gain through Windows

12-66C (a) The spectral distribution of solar radiation beyond the earth's atmosphere resembles the energy emitted by a black body at 5982°C, with about 39 percent in the visible region (0.4 to 0.7 μm), and the 52 percent in the near infrared region (0.7 to 3.5 μm). (b) At a solar altitude of 41.8°, the total energy of direct solar radiation incident at sea level on a clear day consists of about 3 percent ultraviolet, 38 percent visible, and 59 percent infrared radiation.

12-67C A window that transmits visible part of the spectrum while absorbing the infrared portion is ideally suited for minimizing the air-conditioning load since such windows provide maximum daylighting and minimum solar heat gain. The ordinary window glass approximates this behavior remarkably well.

12-68C The **solar heat gain coefficient (SHGC)** is defined as the fraction of incident solar radiation that enters through the glazing. The solar heat gain of a glazing relative to the solar heat gain of a reference glazing, typically that of a standard 3 mm (1/8 in) thick double-strength clear window glass sheet whose SHGC is 0.87, is called the **shading coefficient**. They are related to each other by

$$SC = \frac{\text{Solar heat gain of product}}{\text{Solar heat gain of reference glazing}} = \frac{SHGC}{SHGC_{ref}} = \frac{SHGC}{0.87} = 1.15 \times SHGC$$

For single pane clear glass window, SHGC = 0.87 and SC = 1.0.

12-69C The SC (shading coefficient) of a device represents the solar heat gain relative to the solar heat gain of a reference glazing, typically that of a standard 3 mm (1/8 in) thick double-strength clear window glass sheet whose SHGC is 0.87. The shading coefficient of a 3-mm thick *clear glass* is SC = 1.0 whereas SC = 0.88 for 3-mm thick *heat absorbing glass*.

12-70C A device that blocks solar radiation and thus reduces the solar heat gain is called a shading device. External shading devices are more effective in reducing the solar heat gain since they intercept sun's rays before they reach the glazing. The solar heat gain through a window can be reduced by as much as 80 percent by exterior shading. *Light colored* shading devices maximize the back reflection and thus minimize the solar gain. *Dark colored* shades, on the other hand, minimize the back reflection and thus maximize the solar heat gain.

12-71C A low-e coating on the inner surface of a window glass reduces both the (a) heat loss in winter and (b) heat gain in summer. This is because the radiation heat transfer to or from the window is proportional to the emissivity of the inner surface of the window. In winter, the window is colder and thus radiation heat loss from the room to the window is low. In summer, the window is hotter and the radiation transfer from the window to the room is low.

12-72C Glasses coated with reflective films on the outer surface of a window glass reduces solar heat both in summer and in winter.

12-73 The net annual cost savings due to installing reflective coating on the West windows of a building and the simple payback period are to be determined.

Assumptions 1 The calculations given below are for an average year. 2 The unit costs of electricity and natural gas remain constant.

Analysis Using the daily averages for each month and noting the number of days of each month, the total solar heat flux incident on the glazing during summer and winter months are determined to be

$$\begin{aligned} Q_{\text{solar, summer}} &= 4.24 \times 30 + 4.16 \times 31 + 3.93 \times 31 + 3.48 \times 30 \\ &= 482 \text{ kWh/year} \end{aligned}$$

$$\begin{aligned} Q_{\text{solar, winter}} &= 2.94 \times 31 + 2.33 \times 30 + 2.07 \times 31 + 2.35 \times 31 + 3.03 \times 28 + 3.62 \times 31 + 4.00 \times 30 \\ &= 615 \text{ kWh/year} \end{aligned}$$

Then the decrease in the annual cooling load and the increase in the annual heating load due to reflective film become

$$\begin{aligned} \text{Cooling load decrease} &= Q_{\text{solar, summer}} A_{\text{glazing}} (\text{SHGC}_{\text{without film}} - \text{SHGC}_{\text{with film}}) \\ &= (482 \text{ kWh/year})(60 \text{ m}^2)(0.766 - 0.261) \\ &= 14,605 \text{ kWh/year} \end{aligned}$$

$$\begin{aligned} \text{Heating load increase} &= Q_{\text{solar, winter}} A_{\text{glazing}} (\text{SHGC}_{\text{without film}} - \text{SHGC}_{\text{with film}}) \\ &= (615 \text{ kWh/year})(60 \text{ m}^2)(0.766 - 0.261) \\ &= 18,635 \text{ kWh/year} = 635.8 \text{ therms/year} \end{aligned}$$

since 1 therm = 29.31 kWh. The corresponding decrease in cooling costs and increase in heating costs are

$$\begin{aligned} \text{Decrease in cooling costs} &= (\text{Cooling load decrease})(\text{Unit cost of electricity})/\text{COP} \\ &= (14,605 \text{ kWh/year})(\$0.09/\text{kWh})/3.2 = \$411/\text{year} \end{aligned}$$

$$\begin{aligned} \text{Increase in heating costs} &= (\text{Heating load increase})(\text{Unit cost of fuel})/\text{Efficiency} \\ &= (635.8 \text{ therms/year})(\$0.45/\text{therm})/0.80 = \$358/\text{year} \end{aligned}$$

Then the net annual cost savings due to reflective films become

$$\text{Cost Savings} = \text{Decrease in cooling costs} - \text{Increase in heating costs} = \$411 - 358 = \mathbf{\$53/\text{year}}$$

The implementation cost of installing films is

$$\text{Implementation Cost} = (\$20/\text{m}^2)(60 \text{ m}^2) = \$1200$$

This gives a simple payback period of

$$\text{Simple payback period} = \frac{\text{Implementation cost}}{\text{Annual cost savings}} = \frac{\$1200}{\$53/\text{year}} = \mathbf{23 \text{ years}}$$

Discussion The reflective films will pay for themselves in this case in about 23 years, which is unacceptable to most manufacturers since they are not usually interested in any energy conservation measure which does not pay for itself within 3 years.

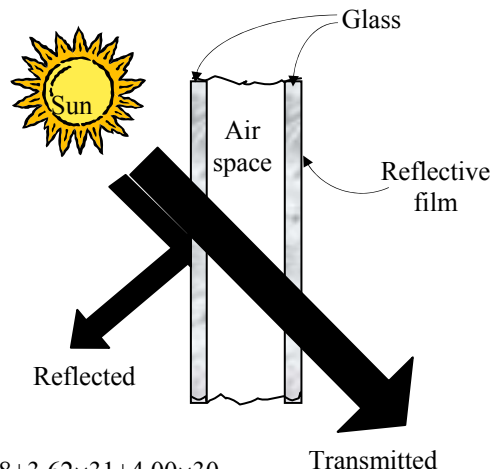

12-74 A house located at 40°N latitude has ordinary double pane windows. The total solar heat gain of the house at 9:00, 12:00, and 15:00 solar time in July and the total amount of solar heat gain per day for an average day in January are to be determined.

Assumptions The calculations are performed for an average day in a given month.

Properties The shading coefficient of a double pane window with 6-mm thick glasses is $SC = 0.82$ (Table 12-5). The incident radiation at different windows at different times are given as (Table 12-4)

Month	Time	Solar radiation incident on the surface, W/m^2			
		North	East	South	West
July	9:00	117	701	190	114
July	12:00	138	149	395	149
July	15:00	117	114	190	701
January	Daily total	446	1863	5897	1863

Analysis The solar heat gain coefficient (SHGC) of the windows is determined from Eq. 12-57 to be

$$SHGC = 0.87 \times SC = 0.87 \times 0.82 = 0.7134$$

The rate of solar heat gain is determined from

$$\dot{Q}_{\text{solar gain}} = SHGC \times A_{\text{glazing}} \times \dot{q}_{\text{solar, incident}} = 0.7134 \times A_{\text{glazing}} \times \dot{q}_{\text{solar, incident}}$$

Then the rates of heat gain at the 4 walls at 3 different times in July become

North wall:

$$\dot{Q}_{\text{solar gain, 9:00}} = 0.7134 \times (4 \text{ m}^2) \times (117 \text{ W/m}^2) = \mathbf{334 \text{ W}}$$

$$\dot{Q}_{\text{solar gain, 12:00}} = 0.7134 \times (4 \text{ m}^2) \times (138 \text{ W/m}^2) = \mathbf{394 \text{ W}}$$

$$\dot{Q}_{\text{solar gain, 15:00}} = 0.7134 \times (4 \text{ m}^2) \times (117 \text{ W/m}^2) = \mathbf{334 \text{ W}}$$

East wall:

$$\dot{Q}_{\text{solar gain, 9:00}} = 0.7134 \times (6 \text{ m}^2) \times (701 \text{ W/m}^2) = \mathbf{3001 \text{ W}}$$

$$\dot{Q}_{\text{solar gain, 12:00}} = 0.7134 \times (6 \text{ m}^2) \times (149 \text{ W/m}^2) = \mathbf{638 \text{ W}}$$

$$\dot{Q}_{\text{solar gain, 15:00}} = 0.7134 \times (6 \text{ m}^2) \times (114 \text{ W/m}^2) = \mathbf{488 \text{ W}}$$

South wall:

$$\dot{Q}_{\text{solar gain, 9:00}} = 0.7134 \times (8 \text{ m}^2) \times (190 \text{ W/m}^2) = \mathbf{1084 \text{ W}}$$

$$\dot{Q}_{\text{solar gain, 12:00}} = 0.7134 \times (8 \text{ m}^2) \times (395 \text{ W/m}^2) = \mathbf{2254 \text{ W}}$$

$$\dot{Q}_{\text{solar gain, 15:00}} = 0.7134 \times (8 \text{ m}^2) \times (190 \text{ W/m}^2) = \mathbf{1084 \text{ W}}$$

West wall:

$$\dot{Q}_{\text{solar gain, 9:00}} = 0.7134 \times (6 \text{ m}^2) \times (114 \text{ W/m}^2) = \mathbf{488 \text{ W}}$$

$$\dot{Q}_{\text{solar gain, 12:00}} = 0.7134 \times (6 \text{ m}^2) \times (149 \text{ W/m}^2) = \mathbf{638 \text{ W}}$$

$$\dot{Q}_{\text{solar gain, 15:00}} = 0.7134 \times (6 \text{ m}^2) \times (701 \text{ W/m}^2) = \mathbf{3001 \text{ W}}$$

Similarly, the solar heat gain of the house through all of the windows in January is determined to be

January:

$$\dot{Q}_{\text{solar gain, North}} = 0.7134 \times (4 \text{ m}^2) \times (446 \text{ Wh/m}^2 \cdot \text{day}) = 1273 \text{ Wh/day}$$

$$\dot{Q}_{\text{solar gain, East}} = 0.7134 \times (6 \text{ m}^2) \times (1863 \text{ Wh/m}^2 \cdot \text{day}) = 7974 \text{ Wh/day}$$

$$\dot{Q}_{\text{solar gain, South}} = 0.7134 \times (8 \text{ m}^2) \times (5897 \text{ Wh/m}^2 \cdot \text{day}) = 33,655 \text{ Wh/day}$$

$$\dot{Q}_{\text{solar gain, West}} = 0.7134 \times (6 \text{ m}^2) \times (1863 \text{ Wh/m}^2 \cdot \text{day}) = 7974 \text{ Wh/day}$$

Therefore, for an average day in January,

$$\dot{Q}_{\text{solar gain per day}} = 1273 + 7974 + 33,655 + 7974 = 58,876 \text{ Wh/day} \cong \mathbf{58.9 \text{ kWh/day}}$$

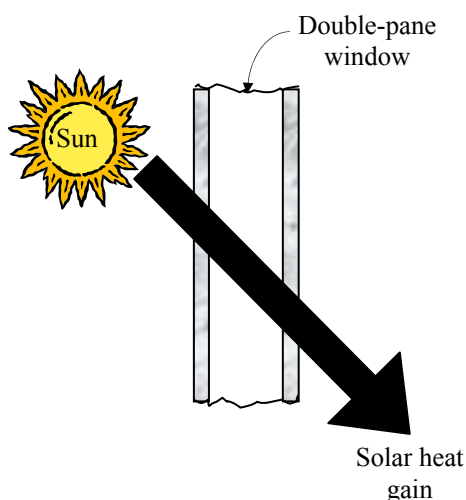

12-75 A house located at 40° N latitude has gray-tinted double pane windows. The total solar heat gain of the house at 9:00, 12:00, and 15:00 solar time in July and the total amount of solar heat gain per day for an average day in January are to be determined.

Assumptions The calculations are performed for an average day in a given month.

Properties The shading coefficient of a gray-tinted double pane window with 6-mm thick glasses is $SC = 0.58$ (Table 12-5). The incident radiation at different windows at different times are given as (Table 12-4)

Month	Time	Solar radiation incident on the surface, W/m^2			
		North	East	South	West
July	9:00	117	701	190	114
July	12:00	138	149	395	149
July	15:00	117	114	190	701
January	Daily total	446	1863	5897	1863

Analysis The solar heat gain coefficient (SHGC) of the windows is determined from Eq. 11-57 to be

$$SHGC = 0.87 \times SC = 0.87 \times 0.58 = 0.5046$$

The rate of solar heat gain is determined from

$$\dot{Q}_{\text{solar gain}} = SHGC \times A_{\text{glazing}} \times \dot{q}_{\text{solar, incident}} = 0.5046 \times A_{\text{glazing}} \times \dot{q}_{\text{solar, incident}}$$

Then the rates of heat gain at the 4 walls at 3 different times in July become

North wall:

$$\dot{Q}_{\text{solar gain, 9:00}} = 0.5046 \times (4 \text{ m}^2) \times (117 \text{ W/m}^2) = \mathbf{236 \text{ W}}$$

$$\dot{Q}_{\text{solar gain, 12:00}} = 0.5046 \times (4 \text{ m}^2) \times (138 \text{ W/m}^2) = \mathbf{279 \text{ W}}$$

$$\dot{Q}_{\text{solar gain, 15:00}} = 0.5046 \times (4 \text{ m}^2) \times (117 \text{ W/m}^2) = \mathbf{236 \text{ W}}$$

East wall:

$$\dot{Q}_{\text{solar gain, 9:00}} = 0.5046 \times (6 \text{ m}^2) \times (701 \text{ W/m}^2) = \mathbf{2122 \text{ W}}$$

$$\dot{Q}_{\text{solar gain, 12:00}} = 0.5046 \times (6 \text{ m}^2) \times (149 \text{ W/m}^2) = \mathbf{451 \text{ W}}$$

$$\dot{Q}_{\text{solar gain, 15:00}} = 0.5046 \times (6 \text{ m}^2) \times (114 \text{ W/m}^2) = \mathbf{345 \text{ W}}$$

South wall:

$$\dot{Q}_{\text{solar gain, 9:00}} = 0.5046 \times (8 \text{ m}^2) \times (190 \text{ W/m}^2) = \mathbf{767 \text{ W}}$$

$$\dot{Q}_{\text{solar gain, 12:00}} = 0.5046 \times (8 \text{ m}^2) \times (395 \text{ W/m}^2) = \mathbf{1595 \text{ W}}$$

$$\dot{Q}_{\text{solar gain, 15:00}} = 0.5046 \times (8 \text{ m}^2) \times (190 \text{ W/m}^2) = \mathbf{767 \text{ W}}$$

West wall:

$$\dot{Q}_{\text{solar gain, 9:00}} = 0.5046 \times (6 \text{ m}^2) \times (114 \text{ W/m}^2) = \mathbf{345 \text{ W}}$$

$$\dot{Q}_{\text{solar gain, 12:00}} = 0.5046 \times (6 \text{ m}^2) \times (149 \text{ W/m}^2) = \mathbf{451 \text{ W}}$$

$$\dot{Q}_{\text{solar gain, 15:00}} = 0.5046 \times (6 \text{ m}^2) \times (701 \text{ W/m}^2) = \mathbf{2122 \text{ W}}$$

Similarly, the solar heat gain of the house through all of the windows in January is determined to be

January:

$$\dot{Q}_{\text{solar gain, North}} = 0.5046 \times (4 \text{ m}^2) \times (446 \text{ Wh/m}^2 \cdot \text{day}) = 900 \text{ Wh/day}$$

$$\dot{Q}_{\text{solar gain, East}} = 0.5046 \times (6 \text{ m}^2) \times (1863 \text{ Wh/m}^2 \cdot \text{day}) = 5640 \text{ Wh/day}$$

$$\dot{Q}_{\text{solar gain, South}} = 0.5046 \times (8 \text{ m}^2) \times (5897 \text{ Wh/m}^2 \cdot \text{day}) = 23,805 \text{ Wh/day}$$

$$\dot{Q}_{\text{solar gain, West}} = 0.5046 \times (6 \text{ m}^2) \times (1863 \text{ Wh/m}^2 \cdot \text{day}) = 5640 \text{ Wh/day}$$

Therefore, for an average day in January,

$$\dot{Q}_{\text{solar gain per day}} = 900 + 5640 + 23,805 + 5640 = 35,985 \text{ Wh/day} = \mathbf{35.895 \text{ kWh/day}}$$

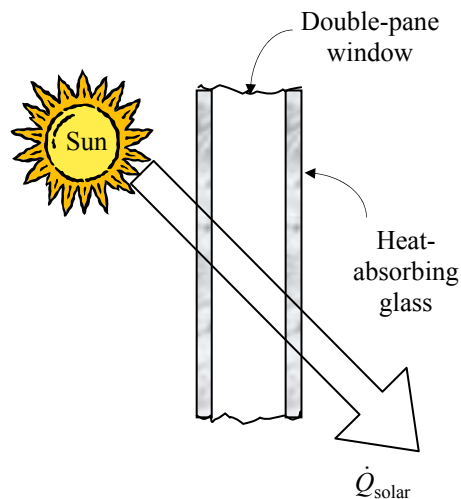

12-76 A building at 40° N latitude has double pane heat absorbing type windows that are equipped with light colored venetian blinds. The total solar heat gains of the building through the south windows at solar noon in April for the cases of with and without the blinds are to be determined.

Assumptions The calculations are performed for an “average” day in April, and may vary from location to location.

Properties The shading coefficient of a double pane heat absorbing type windows is $SC = 0.58$ (Table 12-5). It is given to be $SC = 0.30$ in the case of blinds. The solar radiation incident at a South-facing surface at 12:00 noon in April is 559 W/m^2 (Table 12-4).

Analysis The solar heat gain coefficient (SHGC) of the windows without the blinds is determined from Eq. 12-57 to be

$$SHGC = 0.87 \times SC = 0.87 \times 0.58 = 0.5046$$

Then the rate of solar heat gain through the window becomes

$$\begin{aligned} \dot{Q}_{\text{solar gain, no blinds}} &= SHGC \times A_{\text{glazing}} \times \dot{q}_{\text{solar, incident}} \\ &= 0.5046(130 \text{ m}^2)(559 \text{ W/m}^2) \\ &= \mathbf{36,670 \text{ W}} \end{aligned}$$

In the case of windows equipped with venetian blinds, the SHGC and the rate of solar heat gain become

$$SHGC = 0.87 \times SC = 0.87 \times 0.30 = 0.261$$

Then the rate of solar heat gain through the window becomes

$$\begin{aligned} \dot{Q}_{\text{solar gain, no blinds}} &= SHGC \times A_{\text{glazing}} \times \dot{q}_{\text{solar, incident}} \\ &= 0.261(130 \text{ m}^2)(559 \text{ W/m}^2) \\ &= \mathbf{18,970 \text{ W}} \end{aligned}$$

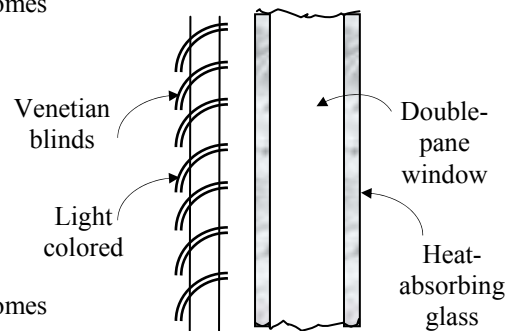

Discussion Note that light colored venetian blinds significantly reduce the solar heat, and thus air-conditioning load in summers.

12-77 A house has double door type windows that are double pane with 6.4 mm of air space and aluminum frames and spacers. It is to be determined if the house is losing more or less heat than it is gaining from the sun through an east window in a typical day in January.

Assumptions 1 The calculations are performed for an “average” day in January. 2 Solar data at 40° latitude can also be used for a location at 39° latitude.

Properties The shading coefficient of a double pane window with 3-mm thick clear glass is $SC = 0.88$ (Table 12-5). The overall heat transfer coefficient for double door type windows that are double pane with 6.4 mm of air space and aluminum frames and spacers is $4.55 \text{ W/m}^2 \cdot ^\circ\text{C}$. (Table 9-6). The total solar radiation incident at an East-facing surface in January during a typical day is 1863 Wh/m^2 (Table 12-4).

Analysis The solar heat gain coefficient (SHGC) of the windows is determined from Eq. 12-57 to be

$$SHGC = 0.87 \times SC = 0.87 \times 0.88 = 0.7656$$

Then the solar heat gain through the window per unit area becomes

$$\begin{aligned} Q_{\text{solar gain}} &= SHGC \times A_{\text{glazing}} \times q_{\text{solar, daily total}} \\ &= 0.7656(1 \text{ m}^2)(1863 \text{ Wh/m}^2) \\ &= \mathbf{1426 \text{ Wh} = 1.426 \text{ kWh}} \end{aligned}$$

The heat loss through a unit area of the window during a 24-h period is

$$\begin{aligned} Q_{\text{loss, window}} &= \dot{Q}_{\text{loss, window}} \Delta t = U_{\text{window}} A_{\text{window}} (T_i - T_{0, \text{ave}})(1 \text{ day}) \\ &= (4.55 \text{ W/m}^2 \cdot ^\circ\text{C})(1 \text{ m}^2)(22 - 10)^\circ\text{C}(24 \text{ h}) \\ &= \mathbf{1310 \text{ Wh} = 1.31 \text{ kWh}} \end{aligned}$$

Therefore, the house is losing **less** heat than it is gaining through the East windows during a typical day in January.

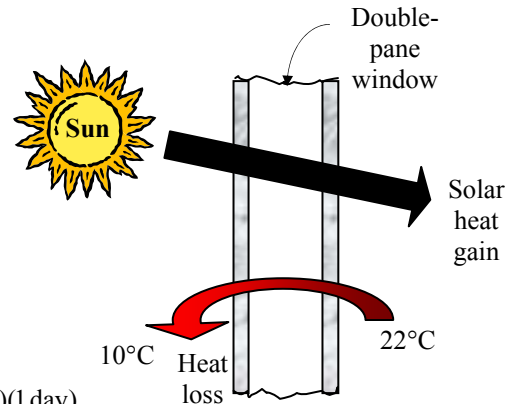

12-78 A house has double door type windows that are double pane with 6.4 mm of air space and aluminum frames and spacers. It is to be determined if the house is losing more or less heat than it is gaining from the sun through a South window in a typical day in January.

Assumptions 1 The calculations are performed for an “average” day in January. 2 Solar data at 40° latitude can also be used for a location at 39° latitude.

Properties The shading coefficient of a double pane window with 3-mm thick clear glass is $SC = 0.88$ (Table 12-5). The overall heat transfer coefficient for double door type windows that are double pane with 6.4 mm of air space and aluminum frames and spacers is $4.55 \text{ W/m}^2 \cdot ^\circ\text{C}$ (Table 9-6). The total solar radiation incident at a South-facing surface in January during a typical day is 5897 Wh/m^2 (Table 12-5).

Analysis The solar heat gain coefficient (SHGC) of the windows is determined from Eq. 12-57 to be

$$SHGC = 0.87 \times SC = 0.87 \times 0.88 = 0.7656$$

Then the solar heat gain through the window per unit area becomes

$$\begin{aligned} Q_{\text{solar gain}} &= SHGC \times A_{\text{glazing}} \times q_{\text{solar, daily total}} \\ &= 0.7656(1 \text{ m}^2)(5897 \text{ Wh/m}^2) \\ &= \mathbf{4515 \text{ Wh} = 4.515 \text{ kWh}} \end{aligned}$$

The heat loss through a unit area of the window during a 24-h period is

$$\begin{aligned} Q_{\text{loss, window}} &= \dot{Q}_{\text{loss, window}} \Delta t = U_{\text{window}} A_{\text{window}} (T_i - T_{0, \text{ave}})(1 \text{ day}) \\ &= (4.55 \text{ W/m}^2 \cdot ^\circ\text{C})(1 \text{ m}^2)(22 - 10)^\circ\text{C}(24 \text{ h}) \\ &= \mathbf{1310 \text{ Wh} = 1.31 \text{ kWh}} \end{aligned}$$

Therefore, the house is **losing** much less heat than it is gaining through the South windows during a typical day in January.

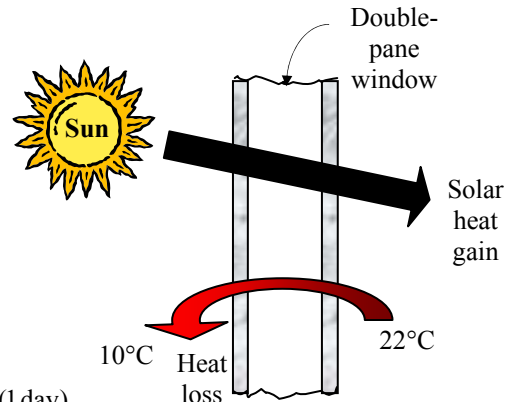

12-79E A house has 1/8-in thick single pane windows with aluminum frames on a West wall. The rate of net heat gain (or loss) through the window at 3 PM during a typical day in January is to be determined.

Assumptions **1** The calculations are performed for an “average” day in January. **2** The frame area relative to glazing area is small so that the glazing area can be taken to be the same as the window area.

Properties The shading coefficient of a 1/8-in thick single pane window is $SC = 1.0$ (Table 12-5). The overall heat transfer coefficient for 1/8-in thick single pane windows with aluminum frames is $6.63 \text{ W/m}^2 \cdot ^\circ\text{C} = 1.17 \text{ Btu/h} \cdot \text{ft}^2 \cdot ^\circ\text{F}$ (Table 9-6). The total solar radiation incident at a West-facing surface at 3 PM in January during a typical day is $557 \text{ W/m}^2 = 177 \text{ Btu/h} \cdot \text{ft}^2$ (Table 12-4).

Analysis The solar heat gain coefficient (SHGC) of the windows is determined from Eq. 12-57 to be

$$SHGC = 0.87 \times SC = 0.87 \times 1.0 = 0.87$$

The window area is: $A_{\text{window}} = (9 \text{ ft})(15 \text{ ft}) = 135 \text{ ft}^2$

Then the rate of solar heat gain through the window at 3 PM becomes

$$\begin{aligned} \dot{Q}_{\text{solar gain, 3 PM}} &= SHGC \times A_{\text{glazing}} \times \dot{q}_{\text{solar, 3 PM}} \\ &= 0.87(135 \text{ ft}^2)(177 \text{ Btu/h} \cdot \text{ft}^2) \\ &= 20,789 \text{ Btu/h} \end{aligned}$$

The rate of heat loss through the window at 3 PM is

$$\begin{aligned} \dot{Q}_{\text{loss, window}} &= U_{\text{window}} A_{\text{window}} (T_i - T_o) \\ &= (1.17 \text{ Btu/h} \cdot \text{ft}^2 \cdot ^\circ\text{F})(135 \text{ ft}^2)(70 - 20)^\circ\text{F} \\ &= 7898 \text{ Btu/h} \end{aligned}$$

The house will be gaining heat at 3 PM since the solar heat gain is larger than the heat loss. The rate of net heat gain through the window is

$$\dot{Q}_{\text{net}} = \dot{Q}_{\text{solar gain, 3 PM}} - \dot{Q}_{\text{loss, window}} = 20,789 - 7898 = \mathbf{12,890 \text{ Btu/h}}$$

Discussion The actual heat gain will be less because of the area occupied by the window frame.

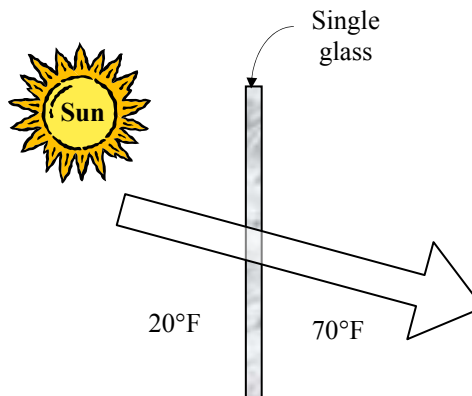

12-80 A building located near 40° N latitude has equal window areas on all four sides. The side of the building with the highest solar heat gain in summer is to be determined.

Assumptions The shading coefficients of windows on all sides of the building are identical.

Analysis The reflective films should be installed on the side that receives the most incident solar radiation in summer since the window areas and the shading coefficients on all four sides are identical. The incident solar radiation at different windows in July are given to be (Table 12-5)

Month	Time	The daily total solar radiation incident on the surface, Wh/m^2			
		North	East	South	West
July	Daily total	1621	4313	2552	4313

Therefore, the reflective film should be installed on the **East** or **West** windows (instead of the South windows) in order to minimize the solar heat gain and thus the cooling load of the building.

Review Problems

12-81 The variation of emissivity of an opaque surface at a specified temperature with wavelength is given. The average emissivity of the surface and its emissive power are to be determined.

Analysis The average emissivity of the surface can be determined from

$$\varepsilon(T) = \varepsilon_1 f_{\lambda_1} + \varepsilon_2 (f_{\lambda_2} - f_{\lambda_1}) + \varepsilon_3 (1 - f_{\lambda_2})$$

where f_{λ_1} and f_{λ_2} are blackbody radiation functions corresponding to $\lambda_1 T$ and $\lambda_2 T$. These functions are determined from Table 12-2 to be

$$\lambda_1 T = (2 \mu\text{m})(1500 \text{ K}) = 3000 \mu\text{mK} \longrightarrow f_{\lambda_1} = 0.273232$$

$$\lambda_2 T = (6 \mu\text{m})(1500 \text{ K}) = 9000 \mu\text{mK} \longrightarrow f_{\lambda_2} = 0.890029$$

and

$$\varepsilon = (0.0)(0.273232) + (0.85)(0.890029 - 0.273232) + (0.0)(1 - 0.890029) = \mathbf{0.5243}$$

Then the emissive flux of the surface becomes

$$E = \varepsilon \sigma T^4 = (0.5243)(5.67 \times 10^{-8} \text{ W/m}^2 \cdot \text{K}^4)(1500 \text{ K})^4 = \mathbf{150,500 \text{ W/m}^2}$$

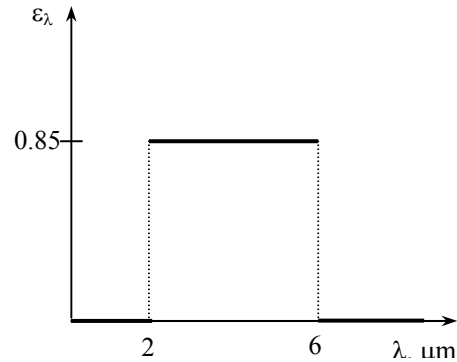

12-82 The variation of transmissivity of glass with wavelength is given. The transmissivity of the glass for solar radiation and for light are to be determined.

Analysis For solar radiation, $T = 5800 \text{ K}$. The average transmissivity of the surface can be determined from

$$\tau(T) = \tau_1 f_{\lambda_1} + \tau_2 (f_{\lambda_2} - f_{\lambda_1}) + \tau_3 (1 - f_{\lambda_2})$$

where f_{λ_1} and f_{λ_2} are blackbody radiation functions corresponding to $\lambda_1 T$ and $\lambda_2 T$. These functions are determined from Table 12-2 to be

$$\lambda_1 T = (0.35 \mu\text{m})(5800 \text{ K}) = 2030 \mu\text{mK} \longrightarrow f_{\lambda_1} = 0.071852$$

$$\lambda_2 T = (2.5 \mu\text{m})(5800 \text{ K}) = 14,500 \mu\text{mK} \longrightarrow f_{\lambda_2} = 0.966440$$

and

$$\tau = (0.0)(0.071852) + (0.85)(0.966440 - 0.071852) + (0.0)(1 - 0.966440) = \mathbf{0.760}$$

For light, we take $T = 300 \text{ K}$. Repeating the calculations at this temperature we obtain

$$\lambda_1 T = (0.35 \mu\text{m})(300 \text{ K}) = 105 \mu\text{mK} \longrightarrow f_{\lambda_1} = 0.00$$

$$\lambda_2 T = (2.5 \mu\text{m})(300 \text{ K}) = 750 \mu\text{mK} \longrightarrow f_{\lambda_2} = 0.000012$$

$$\tau = (0.0)(0.00) + (0.85)(0.000012 - 0.00) + (0.0)(1 - 0.000012) = \mathbf{0.00001}$$

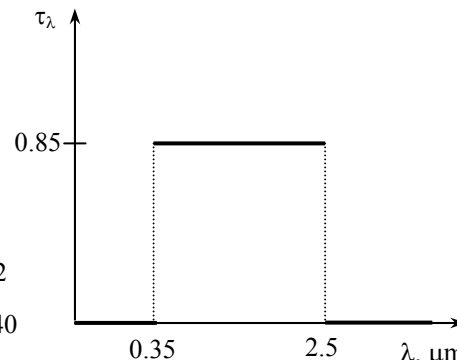

12-83 A hole is drilled in a spherical cavity. The maximum rate of radiation energy streaming through the hole is to be determined.

Analysis The maximum rate of radiation energy streaming through the hole is the blackbody radiation, and it can be determined from

$$E = A\sigma T^4 = \pi(0.0025 \text{ m})^2 (5.67 \times 10^{-8} \text{ W/m}^2 \cdot \text{K}^4)(600 \text{ K})^4 = \mathbf{0.144 \text{ W}}$$

The result would not change for a different diameter of the cavity.

12-84 The variation of absorptivity of a surface with wavelength is given. The average absorptivity of the surface is to be determined for two source temperatures.

Analysis (a) $T = 1000 \text{ K}$. The average absorptivity of the surface can be determined from

$$\begin{aligned} \alpha(T) &= \alpha_1 f_{0-\lambda_1} + \alpha_2 f_{\lambda_1-\lambda_2} + \alpha_3 f_{\lambda_2-\infty} \\ &= \alpha_1 f_{\lambda_1} + \alpha_2 (f_{\lambda_2} - f_{\lambda_1}) + \alpha_3 (1 - f_{\lambda_2}) \end{aligned}$$

where f_{λ_1} and f_{λ_2} are blackbody radiation functions corresponding to $\lambda_1 T$ and $\lambda_2 T$, determined from

$$\lambda_1 T = (0.3 \mu\text{m})(1000 \text{ K}) = 300 \mu\text{mK} \longrightarrow f_{\lambda_1} = 0.0$$

$$\lambda_2 T = (1.2 \mu\text{m})(1000 \text{ K}) = 1200 \mu\text{mK} \longrightarrow f_{\lambda_2} = 0.002134$$

$$f_{0-\lambda_1} = f_{\lambda_1} - f_0 = f_{\lambda_1} \text{ since } f_0 = 0 \text{ and } f_{\lambda_2-\infty} = f_{\infty} - f_{\lambda_2} \text{ since } f_{\infty} = 1.$$

and,

$$\alpha = (0.1)0.0 + (0.8)(0.002134 - 0.0) + (0.0)(1 - 0.002134) = \mathbf{0.0017}$$

(a) $T = 3000 \text{ K}$.

$$\lambda_1 T = (0.3 \mu\text{m})(3000 \text{ K}) = 900 \mu\text{mK} \longrightarrow f_{\lambda_1} = 0.000169$$

$$\lambda_2 T = (1.2 \mu\text{m})(3000 \text{ K}) = 3600 \mu\text{mK} \longrightarrow f_{\lambda_2} = 0.403607$$

$$\alpha = (0.1)0.000169 + (0.8)(0.403607 - 0.000169) + (0.0)(1 - 0.403607) = \mathbf{0.323}$$

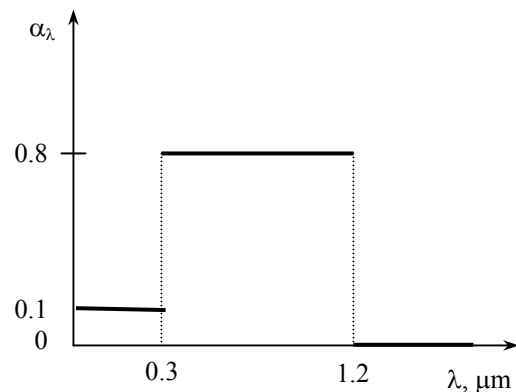

12-85 The variation of absorptivity of a surface with wavelength is given. The surface receives solar radiation at a specified rate. The solar absorptivity of the surface and the rate of absorption of solar radiation are to be determined.

Analysis For solar radiation, $T = 5800$ K. The solar absorptivity of the surface is

$$\lambda_1 T = (0.3 \mu\text{m})(5800 \text{ K}) = 1740 \mu\text{mK} \rightarrow f_{\lambda_1} = 0.033454$$

$$\lambda_2 T = (1.2 \mu\text{m})(5800 \text{ K}) = 6960 \mu\text{mK} \rightarrow f_{\lambda_2} = 0.805713$$

$$\begin{aligned} \alpha &= (0.1)0.033454 + (0.8)(0.805713 - 0.033454) \\ &\quad + (0.0)(1 - 0.805713) \\ &= \mathbf{0.621} \end{aligned}$$

The rate of absorption of solar radiation is determined from

$$E_{\text{absorbed}} = \alpha I = 0.621(470 \text{ W/m}^2) = \mathbf{292 \text{ W/m}^2}$$

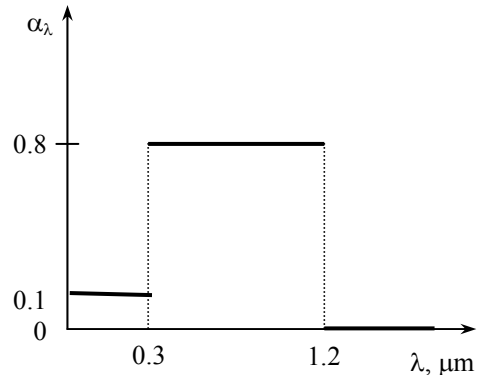

12-86 The spectral transmissivity of a glass cover used in a solar collector is given. Solar radiation is incident on the collector. The solar flux incident on the absorber plate, the transmissivity of the glass cover for radiation emitted by the absorber plate, and the rate of heat transfer to the cooling water are to be determined.

Analysis (a) For solar radiation, $T = 5800$ K. The average transmissivity of the surface can be determined from

$$\tau(T) = \tau_1 f_{\lambda_1} + \tau_2 (f_{\lambda_2} - f_{\lambda_1}) + \tau_3 (1 - f_{\lambda_2})$$

where f_{λ_1} and f_{λ_2} are blackbody radiation functions corresponding to $\lambda_1 T$ and $\lambda_2 T$. These functions are determined from Table 12-2 to be

$$\lambda_1 T = (0.3 \mu\text{m})(5800 \text{ K}) = 1740 \mu\text{mK} \longrightarrow f_{\lambda_1} = 0.033454$$

$$\lambda_2 T = (3 \mu\text{m})(5800 \text{ K}) = 17,400 \mu\text{mK} \longrightarrow f_{\lambda_2} = 0.978746$$

and

$$\tau = (0.0)(0.033454) + (0.9)(0.978746 - 0.033454) + (0.0)(1 - 0.978746) = 0.851$$

Since the absorber plate is black, all of the radiation transmitted through the glass cover will be absorbed by the absorber plate and therefore, the solar flux incident on the absorber plate is same as the radiation absorbed by the absorber plate:

$$E_{\text{abs. plate}} = \tau I = 0.851(950 \text{ W/m}^2) = \mathbf{808.5 \text{ W/m}^2}$$

(b) For radiation emitted by the absorber plate, we take $T = 300$ K, and calculate the transmissivity as follows:

$$\lambda_1 T = (0.3 \mu\text{m})(300 \text{ K}) = 90 \mu\text{mK} \longrightarrow f_{\lambda_1} = 0.0$$

$$\lambda_2 T = (3 \mu\text{m})(300 \text{ K}) = 900 \mu\text{mK} \longrightarrow f_{\lambda_2} = 0.000169$$

$$\tau = (0.0)(0.0) + (0.9)(0.000169 - 0.0) + (0.0)(1 - 0.000169) = \mathbf{0.00015}$$

(c) The rate of heat transfer to the cooling water is the difference between the radiation absorbed by the absorber plate and the radiation emitted by the absorber plate, and it is determined from

$$\dot{Q}_{\text{water}} = (\tau_{\text{solar}} - \tau_{\text{room}})I = (0.851 - 0.00015)(950 \text{ W/m}^2) = \mathbf{808.3 \text{ W/m}^2}$$

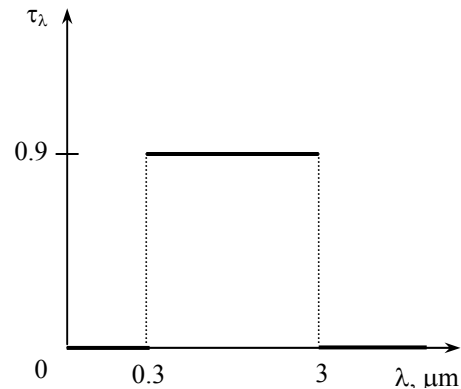

12-87 A small surface emits radiation. The rate of radiation energy emitted through a band is to be determined.

Assumptions Surface A emits diffusely as a blackbody.

Analysis The rate of radiation emission from a surface per unit surface area in the direction (θ, ϕ) is given as

$$dE = \frac{d\dot{Q}_e}{dA} = I_e(\theta, \phi) \cos \theta \sin \theta \, d\theta \, d\phi$$

The total rate of radiation emission through the band between 40° and 50° can be expressed as

$$\begin{aligned} E &= \int_{\phi=0}^{2\pi} \int_{\theta=40}^{50} I_e(\theta, \phi) \cos \theta \sin \theta \, d\theta \, d\phi = I_b(0.1736\pi) \\ &= \frac{\sigma T^4}{\pi} (0.1736\pi) = 0.1736\sigma T^4 \end{aligned}$$

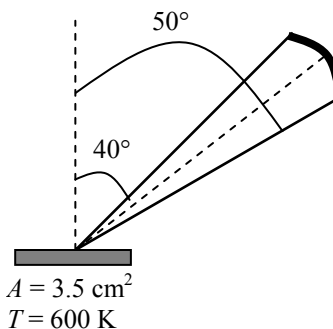

since the blackbody radiation intensity is constant ($I_b = \text{constant}$), and

$$\int_{\phi=0}^{2\pi} \int_{\theta=40}^{50} \cos \theta \sin \theta \, d\theta \, d\phi = 2\pi \int_{\theta=40}^{50} \cos \theta \sin \theta \, d\theta = \pi(\sin^2 50 - \sin^2 40) = 0.1736\pi$$

Approximating a small area as a differential area, the rate of radiation energy emitted from an area of 3.5 cm^2 in the specified band becomes

$$\dot{Q}_e = E dA = 0.1736\sigma T^4 dA = 0.1736 \times (5.67 \times 10^{-8} \text{ W/m}^2 \cdot \text{K}^4) (600 \text{ K})^4 (3.5 \times 10^{-4} \text{ m}^2) = \mathbf{0.446 \text{ W}}$$

12-88 Solar radiation is incident on front surface of a plate. The equilibrium temperature of the plate is to be determined.

Assumptions The plate temperature is uniform.

Properties The solar absorptivity and emissivity of the surface are given to $\alpha_s = 0.63$ and $\varepsilon = 0.93$.

Analysis The solar radiation is

$$\begin{aligned} G_{\text{solar}} &= G_{\text{direct}} \cos \alpha + G_{\text{diffuse}} \\ &= (300 \text{ W/m}^2) \cos(30^\circ) + 250 \text{ W/m}^2 = 509.8 \text{ W/m}^2 \end{aligned}$$

The front surface is exposed to solar and sky radiation and convection while the back surface is exposed to convection and radiation with the surrounding surfaces. An energy balance can be written as

$$\begin{aligned} \dot{q}_{\text{in}} &= \dot{q}_{\text{out}} \\ \alpha_s G_{\text{solar}} + \varepsilon \sigma T_{\text{sky}}^4 + \varepsilon \sigma T_{\text{surr}}^4 &= 2\varepsilon \sigma T_s^4 + 2h(T_s - T_{\text{air}}) \end{aligned}$$

Substituting,

$$\begin{aligned} (0.63)(509.8) + (0.93)(5.67 \times 10^{-8})(-33 + 273)^4 + (0.93)(5.67 \times 10^{-8})(5 + 273)^4 \\ = 2(0.93)(5.67 \times 10^{-8})T_s^4 + 2(20 \text{ W/m}^2 \cdot \text{K})(T_s - 278) \longrightarrow T_s = 281.7 \text{ K} = \mathbf{8.7^\circ \text{C}} \end{aligned}$$

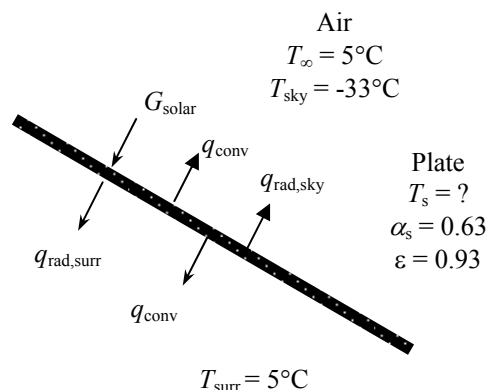

Fundamentals of Engineering (FE) Exam Problems

12-89 Consider a surface at -5°C in an environment at 25°C . The maximum rate of heat that can be emitted from this surface by radiation is

- (a) 0 W/m^2 (b) 155 W/m^2 (c) 293 W/m^2 (d) 354 W/m^2 (e) 567 W/m^2

Answer (c) 293 W/m^2

Solution Solved by EES Software. Solutions can be verified by copying-and-pasting the following lines on a blank EES screen.

```
T=-5 [C]
T_infinity=25 [C]
sigma=5.67E-8 [W/m^2-K^4]
E_b=sigma*(T+273)^4
```

"Some Wrong Solutions with Common Mistakes"

W1_E_b=sigma*T^4 "Using C unit for temperature"

W2_E_b=sigma*((T_infinity+273)^4-(T+273)^4) "Finding radiation exchange between the surface and the environment"

12-90 The wavelength at which the blackbody emissive power reaches its maximum value at 300 K is

- (a) $5.1\ \mu\text{m}$ (b) $9.7\ \mu\text{m}$ (c) $15.5\ \mu\text{m}$ (d) $38.0\ \mu\text{m}$ (e) $73.1\ \mu\text{m}$

Answer (b) $9.7\ \mu\text{m}$

Solution Solved by EES Software. Solutions can be verified by copying-and-pasting the following lines on a blank EES screen.

```
T=300 [K]
lambda*T=2897.8 [micrometer-K] "Wien's displacement law"
```

12-91 Consider a surface at 500 K. The spectral blackbody emissive power at a wavelength of 50 μm is
 (a) 1.54 $\text{W}/\text{m}^2\cdot\mu\text{m}$ (b) 26.3 $\text{W}/\text{m}^2\cdot\mu\text{m}$ (c) 108.4 $\text{W}/\text{m}^2\cdot\mu\text{m}$ (d) 2750 $\text{W}/\text{m}^2\cdot\mu\text{m}$ (e) 8392 $\text{W}/\text{m}^2\cdot\mu\text{m}$

Answer (a) 1.54 $\text{W}/\text{m}^2\cdot\mu\text{m}$

Solution Solved by EES Software. Solutions can be verified by copying-and-pasting the following lines on a blank EES screen.

```
T=500 [K]
lambda=50 [micrometer]
C1=3.742E8 [W-micrometer^4/m^2]
C2=1.439E4 [micrometer-K]
E_b_lambda=C1/(lambda^5*(exp(C2/(lambda*T))-1))
```

12-92 A surface absorbs 10% of radiation at wavelengths less than 3 μm and 50% of radiation at wavelengths greater than 3 μm . The average absorptivity of this surface for radiation emitted by a source at 3000 K is

(a) 0.14 (b) 0.22 (c) 0.30 (d) 0.38 (e) 0.42

Answer (a) 0.14

Solution Solved by EES Software. Solutions can be verified by copying-and-pasting the following lines on a blank EES screen.

```
Abs1=0.1
Abs2=0.5
T=3000
Wave= 3
LT=Wave*T
```

```
F1=0.890029 "The radiation fraction corresponding to lamda-T = 9000, from Table 12-2"
Abs =F1*Abs1+(1-F1)*Abs2
```

12-93 Consider a 4-cm-diameter and 6-cm-long cylindrical rod at 1000 K. If the emissivity of the rod surface is 0.75, the total amount of radiation emitted by all surfaces of the rod in 20 min is

- (a) 43 kJ (b) 385 kJ (c) 434 kJ (d) 513 kJ (e) 684 kJ

Answer (d) 513 kJ

Solution Solved by EES Software. Solutions can be verified by copying-and-pasting the following lines on a blank EES screen.

```
D=0.04 [m]
L=0.06 [m]
T=1000 [K]
epsilon=0.75
time=20*60 [s]
sigma=5.67E-8 [W/m^2-K^4]
A_s=2*pi*D^2/4+pi*D*L
q_dot_emission=epsilon*sigma*T^4
Q_emission=Q_dot_emission*A_s*time
```

"Some Wrong Solutions with Common Mistakes"

```
W1_Q_emission=q_dot_emission "Using rate of emission as the answer"
W2_A_s=pi*D*L "Ignoring bottom and top surfaces of the rod"
W2_Q_emission=q_dot_emission*W2_A_s*time
W3_q_dot_emission=sigma*T^4 "Assuming the surface to be a blackbody"
W3_Q_emission=W3_q_dot_emission*A_s*time
```

12-94 Solar radiation is incident on a semi-transparent body at a rate of 500 W/m². If 150 W/m² of this incident radiation is reflected back and 225 W/m² is transmitted across the body, the absorptivity of the body is

- (a) 0 (b) 0.25 (c) 0.30 (d) 0.45 (e) 1

Answer (b) 0.25

Solution Solved by EES Software. Solutions can be verified by copying-and-pasting the following lines on a blank EES screen.

```
G=500 [W/m^2]
G_ref=150 [W/m^2]
G_tr=225 [W/m^2]
G_abs=G-G_ref-G_tr
alpha=G_abs/G
```

"Some Wrong Solutions with Common Mistakes"

```
W1_alpha=G_ref/G "Definition for reflectivity"
W2_alpha=G_tr/G "Definition for transmissivity"
```

12-95 Solar radiation is incident on an opaque surface at a rate of 400 W/m^2 . The emissivity of the surface is 0.65 and the absorptivity to solar radiation is 0.85. The convection coefficient between the surface and the environment at 25°C is $6 \text{ W/m}^2\cdot^\circ\text{C}$. If the surface is exposed to atmosphere with an effective sky temperature of 250 K , the equilibrium temperature of the surface is

- (a) 281 K (b) 298 K (c) 303 K (d) 317 K (e) 339 K

Answer (d) 317 K

Solution Solved by EES Software. Solutions can be verified by copying-and-pasting the following lines on a blank EES screen.

```
G_solar=400 [W/m^2]
epsilon=0.65
alpha_s=0.85
h=6 [W/m^2-C]
T_infinity=25[C]+273 [K]
T_sky=250 [K]
sigma=5.67E-8 [W/m^2-K^4]
```

```
E_in=E_out
E_in=alpha_s*G_solar+epsilon*sigma*T_sky^4
E_out=epsilon*sigma*T_s^4+h*(T_s-T_infinity)
```

"Some Wrong Solutions with Common Mistakes"

```
W1_E_in=W1_E_out "Ignoring atmospheric radiation"
W1_E_in=alpha_s*G_solar
W1_E_out=epsilon*sigma*W1_T_s^4+h*(W1_T_s-T_infinity)
W2_E_in=W2_E_out "Ignoring convection heat transfer"
W2_E_in=alpha_s*G_solar+epsilon*sigma*T_sky^4
W2_E_out=epsilon*sigma*W2_T_s^4
```

12-96 A surface is exposed to solar radiation. The direct and diffuse components of solar radiation are 350 and 250 W/m², and the direct radiation makes a 35° angle with the normal of the surface. The solar absorptivity and the emissivity of the surface are 0.24 and 0.41, respectively. If the surface is observed to be at 315 K and the effective sky temperature is 256 K, the net rate of radiation heat transfer to the surface is

- (a) -129 W/m² (b) -44 W/m² (c) 0 W/m² (d) 129 W/m² (e) 537 W/m²

Answer (c) 0 W/m²

Solution Solved by EES Software. Solutions can be verified by copying-and-pasting the following lines on a blank EES screen.

```
G_direct=350 [W/m^2]
G_diffuse=250 [W/m^2]
theta=35 [degrees]
alpha_s=0.24
epsilon=0.41
T_s=315 [K]
T_sky=256 [K]
sigma=5.67E-8 [W/m^2-K^4]
G_solar=G_direct*cos(theta)+G_diffuse
q_dot_net=alpha_s*G_solar+epsilon*sigma*(T_sky^4-T_s^4)
```

"Some Wrong Solutions with Common Mistakes"

W1_q_dot_net=G_solar "Using solar radiation as the answer"

W2_q_dot_net=alpha_s*G_solar "Using absorbed solar radiation as the answer"

W3_q_dot_net=epsilon*sigma*(T_sky^4-T_s^4) "Ignoring solar radiation"

12-97 A surface at 300°C has an emissivity of 0.7 in the wavelength range of 0-4.4 μm and 0.3 over the rest of the wavelength range. At a temperature of 300°C, 19 percent of the blackbody emissive power is in wavelength range up to 4.4 μm. The total emissivity of this surface is

- (a) 0.300 (b) 0.376 (c) 0.624 (d) 0.70 (e) 0.50

Answer (b) 0.376

Solution Solved by EES Software. Solutions can be verified by copying-and-pasting the following lines on a blank EES screen.

```
f=0.19
e1=0.7
e2=0.3
e=f*e1+(1-f)*e2
```

12-98 12-99 Design and Essay Problems



Chapter 13

RADIATION HEAT TRANSFER

View Factors

13-1C The view factor $F_{i \rightarrow j}$ represents the fraction of the radiation leaving surface i that strikes surface j directly. The view factor from a surface to itself is non-zero for concave surfaces.

13-2C The pair of view factors $F_{i \rightarrow j}$ and $F_{j \rightarrow i}$ are related to each other by the reciprocity rule $A_i F_{ij} = A_j F_{ji}$ where A_i is the area of the surface i and A_j is the area of the surface j . Therefore,

$$A_1 F_{12} = A_2 F_{21} \longrightarrow F_{12} = \frac{A_2}{A_1} F_{21}$$

13-3C The summation rule for an enclosure and is expressed as $\sum_{j=1}^N F_{i \rightarrow j} = 1$ where N is the number of surfaces of the enclosure. It states that the sum of the view factors from surface i of an enclosure to all surfaces of the enclosure, including to itself must be equal to unity.

The superposition rule is stated as the view factor from a surface i to a surface j is equal to the sum of the view factors from surface i to the parts of surface j , $F_{1 \rightarrow (2,3)} = F_{1 \rightarrow 2} + F_{1 \rightarrow 3}$.

13-4C The cross-string method is applicable to geometries which are very long in one direction relative to the other directions. By attaching strings between corners the Crossed-Strings Method is expressed as

$$F_{i \rightarrow j} = \frac{\sum \text{Crossed strings} - \sum \text{Uncrossed strings}}{2 \times \text{string on surface } i}$$

13-5 An enclosure consisting of eight surfaces is considered. The number of view factors this geometry involves and the number of these view factors that can be determined by the application of the reciprocity and summation rules are to be determined.

Analysis An eight surface enclosure ($N = 8$) involves $N^2 = 8^2 = \mathbf{64}$ view factors and we need to determine $\frac{N(N-1)}{2} = \frac{8(8-1)}{2} = 28$ view factors directly. The remaining $64 - 28 = \mathbf{36}$ of the view factors can be determined by the application of the reciprocity and summation rules.

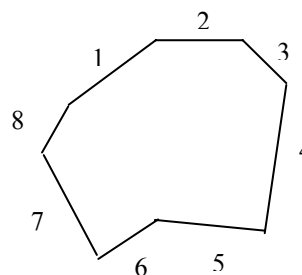

13-6 An enclosure consisting of five surfaces is considered. The number of view factors this geometry involves and the number of these view factors that can be determined by the application of the reciprocity and summation rules are to be determined.

Analysis A five surface enclosure ($N=5$) involves $N^2 = 5^2 = \mathbf{25}$

view factors and we need to determine $\frac{N(N-1)}{2} = \frac{5(5-1)}{2} = 10$

view factors directly. The remaining $25-10 = \mathbf{15}$ of the view factors can be determined by the application of the reciprocity and summation rules.

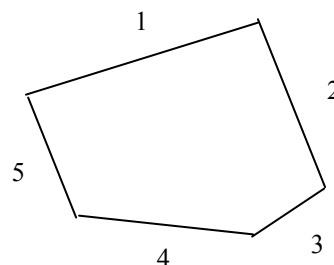

13-7 An enclosure consisting of twelve surfaces is considered. The number of view factors this geometry involves and the number of these view factors that can be determined by the application of the reciprocity and summation rules are to be determined.

Analysis A twelve surface enclosure ($N=12$)

involves $N^2 = 12^2 = \mathbf{144}$ view factors and we

need to determine $\frac{N(N-1)}{2} = \frac{12(12-1)}{2} = 66$

view factors directly. The remaining $144-66 = \mathbf{78}$ of the view factors can be determined by the application of the reciprocity and summation rules.

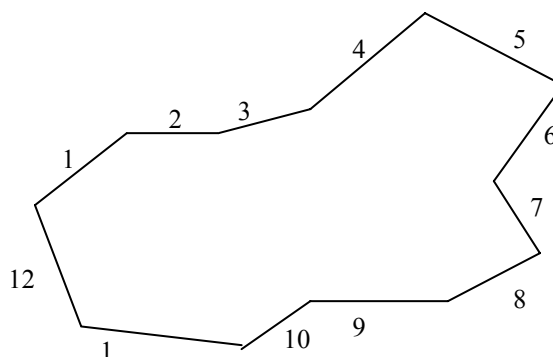

13-8 The view factors between the rectangular surfaces shown in the figure are to be determined.

Assumptions The surfaces are diffuse emitters and reflectors.

Analysis From Fig. 13-6,

$$\left. \begin{aligned} \frac{L_3}{W} = \frac{1}{3} = 0.33 \\ \frac{L_1}{W} = \frac{1}{3} = 0.33 \end{aligned} \right\} F_{31} = 0.27$$

and

$$\left. \begin{aligned} \frac{L_3}{W} = \frac{1}{3} = 0.33 \\ \frac{L_1 + L_2}{W} = \frac{2}{3} = 0.67 \end{aligned} \right\} F_{3 \rightarrow (1+2)} = 0.32$$

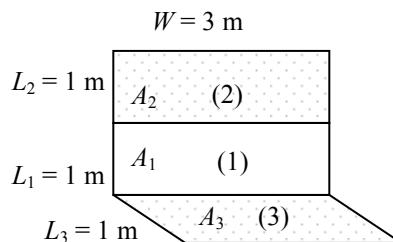

We note that $A_1 = A_3$. Then the reciprocity and superposition rules gives

$$A_1 F_{13} = A_3 F_{31} \longrightarrow F_{13} = F_{31} = \mathbf{0.27}$$

$$F_{3 \rightarrow (1+2)} = F_{31} + F_{32} \longrightarrow 0.32 = 0.27 + F_{32} \longrightarrow F_{32} = 0.05$$

Finally, $A_2 = A_3 \longrightarrow F_{23} = F_{32} = \mathbf{0.05}$

13-9 A cylindrical enclosure is considered. The view factor from the side surface of this cylindrical enclosure to its base surface is to be determined.

Assumptions The surfaces are diffuse emitters and reflectors.

Analysis We designate the surfaces as follows:

- Base surface by (1),
- top surface by (2), and
- side surface by (3).

Then from Fig. 13-7

$$\left. \begin{aligned} \frac{L}{r_1} = \frac{4r_1}{r_1} = 4 \\ \frac{r_2}{L} = \frac{r_2}{4r_2} = 0.25 \end{aligned} \right\} F_{12} = F_{21} = 0.05$$

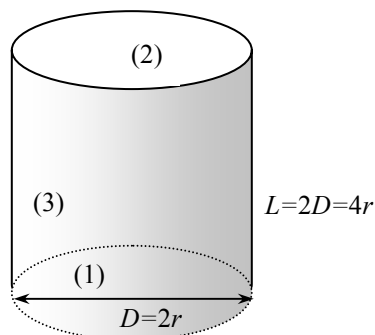

summation rule : $F_{11} + F_{12} + F_{13} = 1$

$$0 + 0.05 + F_{13} = 1 \longrightarrow F_{13} = 0.95$$

$$\text{reciprocity rule : } A_1 F_{13} = A_3 F_{31} \longrightarrow F_{31} = \frac{A_1}{A_3} F_{13} = \frac{\pi r_1^2}{2\pi r_1 L} F_{13} = \frac{\pi r_1^2}{8\pi r_1^2} F_{13} = \frac{1}{8} (0.95) = \mathbf{0.119}$$

Discussion This problem can be solved more accurately by using the view factor relation from Table 13-1 to be

$$R_1 = \frac{r_1}{L} = \frac{r_1}{4r_1} = 0.25$$

$$R_2 = \frac{r_2}{L} = \frac{r_2}{4r_2} = 0.25$$

$$S = 1 + \frac{1 + R_2^2}{R_1^2} = 1 + \frac{1 + 0.25^2}{0.25^2} = 18$$

$$F_{12} = \frac{1}{2} \left\{ S - \left[S^2 - 4 \left(\frac{R_2}{R_1} \right)^2 \right]^{0.5} \right\} = \frac{1}{2} \left\{ 18 - \left[18^2 - 4 \left(\frac{1}{1} \right)^2 \right]^{0.5} \right\} = 0.056$$

$$F_{13} = 1 - F_{12} = 1 - 0.056 = 0.944$$

$$\text{reciprocity rule : } A_1 F_{13} = A_3 F_{31} \longrightarrow F_{31} = \frac{A_1}{A_3} F_{13} = \frac{\pi r_1^2}{2\pi r_1 L} F_{13} = \frac{\pi r_1^2}{8\pi r_1^2} F_{13} = \frac{1}{8} (0.944) = \mathbf{0.118}$$

13-10 A semispherical furnace is considered. The view factor from the dome of this furnace to its flat base is to be determined.

Assumptions The surfaces are diffuse emitters and reflectors.

Analysis We number the surfaces as follows:

(1): circular base surface

(2): dome surface

Surface (1) is flat, and thus $F_{11} = 0$.

Summation rule: $F_{11} + F_{12} = 1 \rightarrow F_{12} = 1$

$$\text{reciprocity rule: } A_1 F_{12} = A_2 F_{21} \longrightarrow F_{21} = \frac{A_1}{A_2} F_{12} = \frac{A_1}{A_2} (1) = \frac{\frac{\pi D^2}{4}}{\frac{\pi D^2}{2}} = \frac{1}{2} = \mathbf{0.5}$$

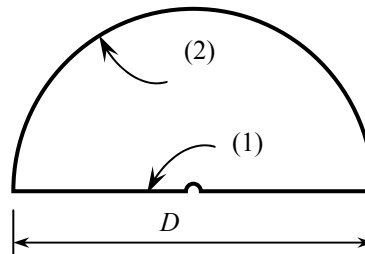

13-11 Two view factors associated with three very long ducts with different geometries are to be determined.

Assumptions 1 The surfaces are diffuse emitters and reflectors. **2** End effects are neglected.

Analysis (a) Surface (1) is flat, and thus $F_{11} = 0$.

summation rule: $F_{11} + F_{12} = 1 \rightarrow F_{12} = \mathbf{1}$

$$\text{reciprocity rule: } A_1 F_{12} = A_2 F_{21} \longrightarrow F_{21} = \frac{A_1}{A_2} F_{12} = \frac{Ds}{\left(\frac{\pi D}{2}\right)s} (1) = \frac{2}{\pi} = \mathbf{0.64}$$

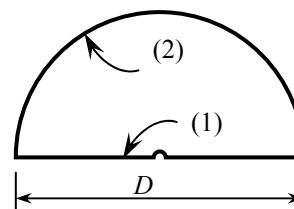

(b) Noting that surfaces 2 and 3 are symmetrical and thus $F_{12} = F_{13}$, the summation rule gives

$$F_{11} + F_{12} + F_{13} = 1 \longrightarrow 0 + F_{12} + F_{13} = 1 \longrightarrow F_{12} = \mathbf{0.5}$$

Also by using the equation obtained in Example 13-4,

$$F_{12} = \frac{L_1 + L_2 - L_3}{2L_1} = \frac{a + b - b}{2a} = \frac{a}{2a} = \frac{1}{2} = \mathbf{0.5}$$

$$\text{reciprocity rule: } A_1 F_{12} = A_2 F_{21} \longrightarrow F_{21} = \frac{A_1}{A_2} F_{12} = \frac{a}{b} \left(\frac{1}{2}\right) = \mathbf{\frac{a}{2b}}$$

(c) Applying the crossed-string method gives

$$\begin{aligned} F_{12} = F_{21} &= \frac{(L_5 + L_6) - (L_3 + L_4)}{2L_1} \\ &= \frac{2\sqrt{a^2 + b^2} - 2b}{2a} = \frac{\sqrt{a^2 + b^2} - b}{a} \end{aligned}$$

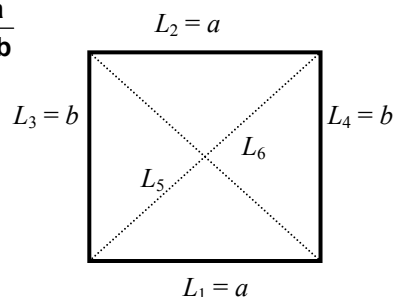
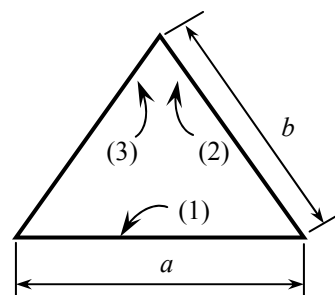

13-12 View factors from the very long grooves shown in the figure to the surroundings are to be determined.

Assumptions 1 The surfaces are diffuse emitters and reflectors. 2 End effects are neglected.

Analysis (a) We designate the circular dome surface by (1) and the imaginary flat top surface by (2). Noting that (2) is flat,

$$F_{22} = 0$$

$$\text{summation rule: } F_{21} + F_{22} = 1 \longrightarrow F_{21} = 1$$

$$\text{reciprocity rule: } A_1 F_{12} = A_2 F_{21} \longrightarrow F_{12} = \frac{A_2}{A_1} F_{21} = \frac{D}{\frac{\pi D}{2}} (1) = \frac{2}{\pi} = \mathbf{0.64}$$

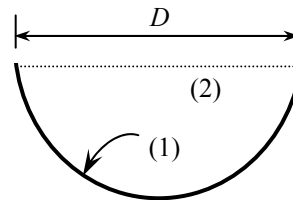

(b) We designate the two identical surfaces of length b by (1) and (3), and the imaginary flat top surface by (2). Noting that (2) is flat,

$$F_{22} = 0$$

$$\text{summation rule: } F_{21} + F_{22} + F_{23} = 1 \longrightarrow F_{21} = F_{23} = 0.5 \quad (\text{symmetry})$$

$$\text{summation rule: } F_{22} + F_{2 \rightarrow (1+3)} = 1 \longrightarrow F_{2 \rightarrow (1+3)} = 1$$

$$\text{reciprocity rule: } A_2 F_{2 \rightarrow (1+3)} = A_{(1+3)} F_{(1+3) \rightarrow 2}$$

$$\longrightarrow F_{(1+3) \rightarrow 2} = F_{(1+3) \rightarrow \text{surr}} = \frac{A_2}{A_{(1+3)}} (1) = \frac{\mathbf{a}}{\mathbf{2b}}$$

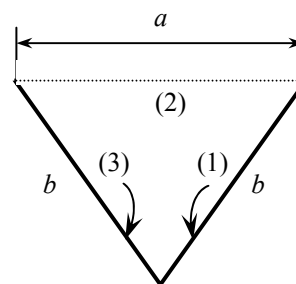

(c) We designate the bottom surface by (1), the side surfaces by (2) and (3), and the imaginary top surface by (4). Surface 4 is flat and is completely surrounded by other surfaces.

Therefore, $F_{44} = 0$ and $F_{4 \rightarrow (1+2+3)} = 1$.

$$\text{reciprocity rule: } A_4 F_{4 \rightarrow (1+2+3)} = A_{(1+2+3)} F_{(1+2+3) \rightarrow 4}$$

$$\longrightarrow F_{(1+2+3) \rightarrow 4} = F_{(1+2+3) \rightarrow \text{surr}} = \frac{A_4}{A_{(1+2+3)}} (1) = \frac{\mathbf{a}}{\mathbf{a + 2b}}$$

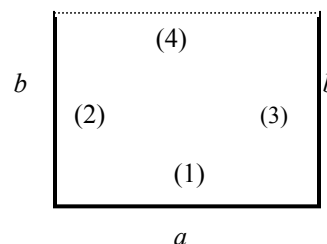

13-13 The view factors from the base of a cube to each of the other five surfaces are to be determined.

Assumptions The surfaces are diffuse emitters and reflectors.

Analysis Noting that $L_1 / D = L_2 / D = 1$, from Fig. 13-6 we read

$$F_{12} = 0.2$$

Because of symmetry, we have

$$F_{12} = F_{13} = F_{14} = F_{15} = F_{16} = \mathbf{0.2}$$

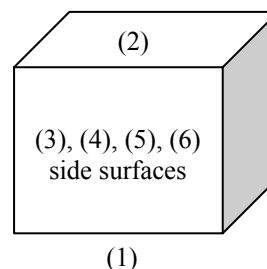

13-14 The view factor from the conical side surface to a hole located at the center of the base of a conical enclosure is to be determined.

Assumptions The conical side surface is diffuse emitter and reflector.

Analysis We number different surfaces as

the hole located at the center of the base (1)

the base of conical enclosure (2)

conical side surface (3)

Surfaces 1 and 2 are flat, and they have no direct view of each other. Therefore,

$$F_{11} = F_{22} = F_{12} = F_{21} = 0$$

summation rule: $F_{11} + F_{12} + F_{13} = 1 \longrightarrow F_{13} = 1$

reciprocity rule: $A_1 F_{13} = A_3 F_{31} \longrightarrow \frac{\pi d^2}{4} (1) = \frac{\pi D h}{2} F_{31} \longrightarrow F_{31} = \frac{d^2}{2 D h}$

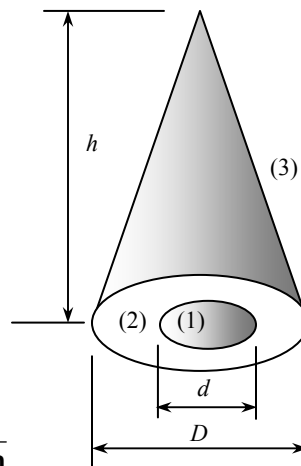

13-15 The four view factors associated with an enclosure formed by two very long concentric cylinders are to be determined.

Assumptions 1 The surfaces are diffuse emitters and reflectors. **2** End effects are neglected.

Analysis We number different surfaces as

the outer surface of the inner cylinder (1)

the inner surface of the outer cylinder (2)

No radiation leaving surface 1 strikes itself and thus $F_{11} = 0$

All radiation leaving surface 1 strikes surface 2 and thus $F_{12} = 1$

reciprocity rule: $A_1 F_{12} = A_2 F_{21} \longrightarrow F_{21} = \frac{A_1}{A_2} F_{12} = \frac{\pi D_1 h}{\pi D_2 h} (1) = \frac{D_1}{D_2}$

summation rule: $F_{21} + F_{22} = 1 \longrightarrow F_{22} = 1 - F_{21} = 1 - \frac{D_1}{D_2}$

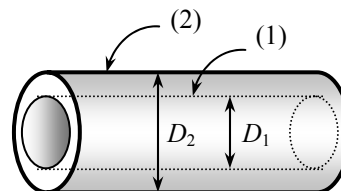

13-16 The view factors between the rectangular surfaces shown in the figure are to be determined.

Assumptions The surfaces are diffuse emitters and reflectors.

Analysis We designate the different surfaces as follows:

- shaded part of perpendicular surface by (1),
- bottom part of perpendicular surface by (3),
- shaded part of horizontal surface by (2), and
- front part of horizontal surface by (4).

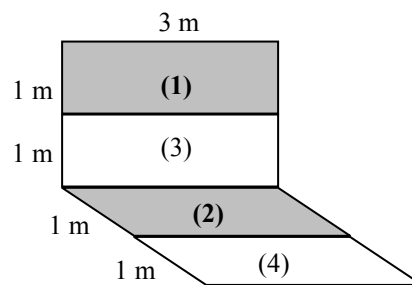

(a) From Fig.13-6

$$\left. \begin{array}{l} \frac{L_2}{W} = \frac{1}{3} \\ \frac{L_1}{W} = \frac{1}{3} \end{array} \right\} F_{23} = 0.25 \quad \text{and} \quad \left. \begin{array}{l} \frac{L_2}{W} = \frac{2}{3} \\ \frac{L_1}{W} = \frac{1}{3} \end{array} \right\} F_{2 \rightarrow (1+3)} = 0.32$$

superposition rule: $F_{2 \rightarrow (1+3)} = F_{21} + F_{23} \longrightarrow F_{21} = F_{2 \rightarrow (1+3)} - F_{23} = 0.32 - 0.25 = 0.07$

reciprocity rule: $A_1 = A_2 \longrightarrow A_1 F_{12} = A_2 F_{21} \longrightarrow F_{12} = F_{21} = \mathbf{0.07}$

(b) From Fig.13-6,

$$\frac{L_2}{W} = \frac{1}{3} \quad \text{and} \quad \frac{L_1}{W} = \frac{2}{3} \left\} F_{(4+2) \rightarrow 3} = 0.15 \quad \text{and} \quad \frac{L_2}{W} = \frac{2}{3} \quad \text{and} \quad \frac{L_1}{W} = \frac{2}{3} \left\} F_{(4+2) \rightarrow (1+3)} = 0.22$$

superposition rule: $F_{(4+2) \rightarrow (1+3)} = F_{(4+2) \rightarrow 1} + F_{(4+2) \rightarrow 3} \longrightarrow F_{(4+2) \rightarrow 1} = 0.22 - 0.15 = 0.07$

reciprocity rule: $A_{(4+2)} F_{(4+2) \rightarrow 1} = A_1 F_{1 \rightarrow (4+2)}$

$$\longrightarrow F_{1 \rightarrow (4+2)} = \frac{A_{(4+2)}}{A_1} F_{(4+2) \rightarrow 1} = \frac{6}{3} (0.07) = 0.14$$

superposition rule: $F_{1 \rightarrow (4+2)} = F_{14} + F_{12}$

$$\longrightarrow F_{14} = 0.14 - 0.07 = \mathbf{0.07}$$

since $F_{12} = 0.07$ (from part a). Note that F_{14} in part (b) is equivalent to F_{12} in part (a).

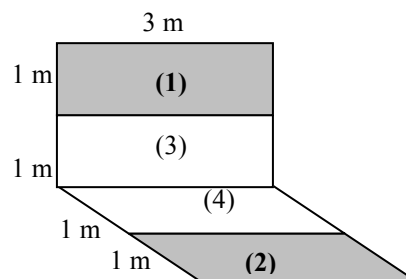

(c) We designate

- shaded part of top surface by (1),
- remaining part of top surface by (3),
- remaining part of bottom surface by (4), and
- shaded part of bottom surface by (2).

From Fig.13-5,

$$\left. \begin{array}{l} \frac{L_2}{D} = \frac{2}{2} \\ \frac{L_1}{D} = \frac{2}{2} \end{array} \right\} F_{(2+4) \rightarrow (1+3)} = 0.20 \quad \text{and} \quad \left. \begin{array}{l} \frac{L_2}{D} = \frac{2}{2} \\ \frac{L_1}{D} = \frac{1}{2} \end{array} \right\} F_{14} = 0.12$$

superposition rule: $F_{(2+4) \rightarrow (1+3)} = F_{(2+4) \rightarrow 1} + F_{(2+4) \rightarrow 3}$

symmetry rule: $F_{(2+4) \rightarrow 1} = F_{(2+4) \rightarrow 3}$

Substituting symmetry rule gives

$$F_{(2+4) \rightarrow 1} = F_{(2+4) \rightarrow 3} = \frac{F_{(2+4) \rightarrow (1+3)}}{2} = \frac{0.20}{2} = 0.10$$

reciprocity rule: $A_1 F_{1 \rightarrow (2+4)} = A_{(2+4)} F_{(2+4) \rightarrow 1} \longrightarrow (2) F_{1 \rightarrow (2+4)} = (4)(0.10) \longrightarrow F_{1 \rightarrow (2+4)} = 0.20$

superposition rule: $F_{1 \rightarrow (2+4)} = F_{12} + F_{14} \longrightarrow 0.20 = F_{12} + 0.12 \longrightarrow F_{12} = 0.20 - 0.12 = \mathbf{0.08}$

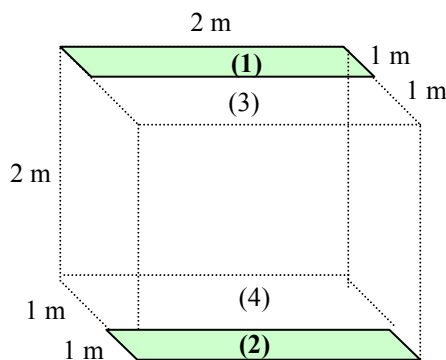

13-17 The view factor between the two infinitely long parallel cylinders located a distance s apart from each other is to be determined.

Assumptions The surfaces are diffuse emitters and reflectors.

Analysis Using the crossed-strings method, the view factor between two cylinders facing each other for $s/D > 3$ is determined to be

$$F_{1-2} = \frac{\sum \text{Crossed strings} - \sum \text{Uncrossed strings}}{2 \times \text{String on surface 1}}$$

$$= \frac{2\sqrt{s^2 + D^2} - 2s}{2(\pi D / 2)}$$

or

$$F_{1-2} = \frac{2\left(\sqrt{s^2 + D^2} - s\right)}{\pi D}$$

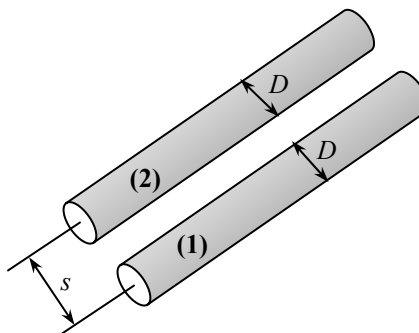

13-18 Three infinitely long cylinders are located parallel to each other. The view factor between the cylinder in the middle and the surroundings is to be determined.

Assumptions The cylinder surfaces are diffuse emitters and reflectors.

Analysis The view factor between two cylinders facing each other is, from Prob. 13-17,

$$F_{1-2} = \frac{2\left(\sqrt{s^2 + D^2} - s\right)}{\pi D}$$

Noting that the radiation leaving cylinder 1 that does not strike the cylinder will strike the surroundings, and this is also the case for the other half of the cylinder, the view factor between the cylinder in the middle and the surroundings becomes

$$F_{1-surr} = 1 - 2F_{1-2} = 1 - \frac{4\left(\sqrt{s^2 + D^2} - s\right)}{\pi D}$$

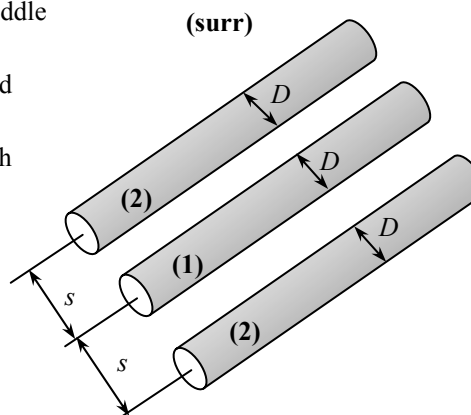

Radiation Heat Transfer between Surfaces

13-19C The analysis of radiation exchange between black surfaces is relatively easy because of the absence of reflection. The rate of radiation heat transfer between two surfaces in this case is expressed as $\dot{Q} = A_1 F_{12} \sigma (T_1^4 - T_2^4)$ where A_1 is the surface area, F_{12} is the view factor, and T_1 and T_2 are the temperatures of two surfaces.

13-20C Radiosity is the total radiation energy leaving a surface per unit time and per unit area. Radiosity includes the emitted radiation energy as well as reflected energy. Radiosity and emitted energy are equal for blackbodies since a blackbody does not reflect any radiation.

13-21C Radiation surface resistance is given as $R_i = \frac{1 - \varepsilon_i}{A_i \varepsilon_i}$ and it represents the resistance of a surface to the emission of radiation. It is zero for black surfaces. The space resistance is the radiation resistance between two surfaces and is expressed as $R_{ij} = \frac{1}{A_i F_{ij}}$

13-22C The two methods used in radiation analysis are the matrix and network methods. In matrix method, equations 13-34 and 13-35 give N linear algebraic equations for the determination of the N unknown radiosities for an N -surface enclosure. Once the radiosities are available, the unknown surface temperatures and heat transfer rates can be determined from these equations respectively. This method involves the use of matrices especially when there are a large number of surfaces. Therefore this method requires some knowledge of linear algebra.

The network method involves drawing a surface resistance associated with each surface of an enclosure and connecting them with space resistances. Then the radiation problem is solved by treating it as an electrical network problem where the radiation heat transfer replaces the current and the radiosity replaces the potential. The network method is not practical for enclosures with more than three or four surfaces due to the increased complexity of the network.

13-23C Some surfaces encountered in numerous practical heat transfer applications are modeled as being adiabatic as the back sides of these surfaces are well insulated and net heat transfer through these surfaces is zero. When the convection effects on the front (heat transfer) side of such a surface is negligible and steady-state conditions are reached, the surface must lose as much radiation energy as it receives. Such a surface is called reradiating surface. In radiation analysis, the surface resistance of a reradiating surface is taken to be zero since there is no heat transfer through it.

13-24 A solid sphere is placed in an evacuated equilateral triangular enclosure. The view factor from the enclosure to the sphere and the emissivity of the enclosure are to be determined.

Assumptions 1 Steady operating conditions exist 2 The surfaces are opaque, diffuse, and gray. 3 Convection heat transfer is not considered.

Properties The emissivity of sphere is given to be $\varepsilon_1 = 0.45$.

Analysis (a) We take the sphere to be surface 1 and the surrounding enclosure to be surface 2. The view factor from surface 2 to surface 1 is determined from reciprocity relation:

$$A_1 = \pi D^2 = \pi(1 \text{ m})^2 = 3.142 \text{ m}^2$$

$$A_2 = 3\sqrt{L^2 - D^2} \frac{L}{2} = 3\sqrt{(2 \text{ m})^2 - (1 \text{ m})^2} \frac{2 \text{ m}}{2} = 5.196 \text{ m}^2$$

$$A_1 F_{12} = A_2 F_{21}$$

$$(3.142)(1) = (5.196)F_{21}$$

$$F_{21} = \mathbf{0.605}$$

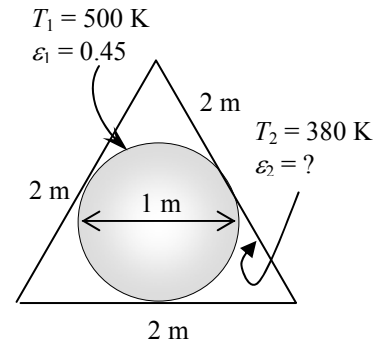

(b) The net rate of radiation heat transfer can be expressed for this two-surface enclosure to yield the emissivity of the enclosure:

$$\dot{Q} = \frac{\sigma(T_1^4 - T_2^4)}{\frac{1 - \varepsilon_1}{A_1 \varepsilon_1} + \frac{1}{A_1 F_{12}} + \frac{1 - \varepsilon_2}{A_2 \varepsilon_2}}$$

$$3100 \text{ W} = \frac{(5.67 \times 10^{-8} \text{ W/m}^2 \cdot \text{K}^4) [(500 \text{ K})^4 - (380 \text{ K})^4]}{\frac{1 - 0.45}{(3.142 \text{ m}^2)(0.45)} + \frac{1}{(3.142 \text{ m}^2)(1)} + \frac{1 - \varepsilon_2}{(5.196 \text{ m}^2)\varepsilon_2}}$$

$$\varepsilon_2 = \mathbf{0.78}$$

13-25 Radiation heat transfer occurs between a sphere and a circular disk. The view factors and the net rate of radiation heat transfer for the existing and modified cases are to be determined.

Assumptions 1 Steady operating conditions exist 2 The surfaces are opaque, diffuse, and gray. 3 Convection heat transfer is not considered.

Properties The emissivities of sphere and disk are given to be $\varepsilon_1 = 0.9$ and $\varepsilon_2 = 0.5$, respectively.

Analysis (a) We take the sphere to be surface 1 and the disk to be surface 2. The view factor from surface 1 to surface 2 is determined from

$$F_{12} = 0.5 \left\{ 1 - \left[1 + \left(\frac{r_2}{h} \right)^2 \right]^{-0.5} \right\} = 0.5 \left\{ 1 - \left[1 + \left(\frac{1.2 \text{ m}}{0.60 \text{ m}} \right)^2 \right]^{-0.5} \right\} = \mathbf{0.2764}$$

The view factor from surface 2 to surface 1 is determined from reciprocity relation:

$$A_1 = 4\pi r_1^2 = 4\pi(0.3 \text{ m})^2 = 1.131 \text{ m}^2$$

$$A_2 = \pi r_2^2 = \pi(1.2 \text{ m})^2 = 4.524 \text{ m}^2$$

$$A_1 F_{12} = A_2 F_{21}$$

$$(1.131)(0.2764) = (4.524)F_{21}$$

$$F_{21} = \mathbf{0.0691}$$

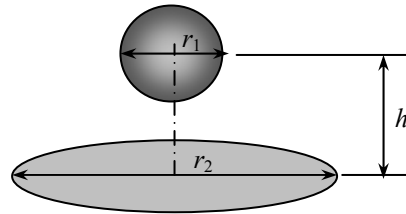

(b) The net rate of radiation heat transfer between the surfaces can be determined from

$$\dot{Q} = \frac{\sigma(T_1^4 - T_2^4)}{\frac{1-\varepsilon_1}{A_1\varepsilon_1} + \frac{1}{A_1F_{12}} + \frac{1-\varepsilon_2}{A_2\varepsilon_2}} = \frac{(5.67 \times 10^{-8} \text{ W/m}^2 \cdot \text{K}^4)[(873 \text{ K})^4 - (473 \text{ K})^4]}{\frac{1-0.9}{(1.131 \text{ m}^2)(0.9)} + \frac{1}{(1.131 \text{ m}^2)(0.2764)} + \frac{1-0.5}{(4.524 \text{ m}^2)(0.5)}} = \mathbf{8550 \text{ W}}$$

(c) The best values are $\varepsilon_1 = \varepsilon_2 = 1$ and $h = r_1 = 0.3 \text{ m}$. Then the view factor becomes

$$F_{12} = 0.5 \left\{ 1 - \left[1 + \left(\frac{r_2}{h} \right)^2 \right]^{-0.5} \right\} = 0.5 \left\{ 1 - \left[1 + \left(\frac{1.2 \text{ m}}{0.30 \text{ m}} \right)^2 \right]^{-0.5} \right\} = 0.3787$$

The net rate of radiation heat transfer in this case is

$$\dot{Q} = A_1 F_{12} \sigma (T_1^4 - T_2^4) = (1.131 \text{ m}^2)(0.3787)(5.67 \times 10^{-8} \text{ W/m}^2 \cdot \text{K}^4)[(873 \text{ K})^4 - (473 \text{ K})^4] = \mathbf{12,890 \text{ W}}$$

13-26E Top and side surfaces of a cubical furnace are black, and are maintained at uniform temperatures. Net radiation heat transfer rate to the base from the top and side surfaces are to be determined.

Assumptions 1 Steady operating conditions exist 2 The surfaces are opaque, diffuse, and gray. 3 Convection heat transfer is not considered.

Properties The emissivities are given to be $\varepsilon = 0.7$ for the bottom surface and 1 for other surfaces.

Analysis We consider the base surface to be surface 1, the top surface to be surface 2 and the side surfaces to be surface 3. The cubical furnace can be considered to be three-surface enclosure. The areas and blackbody emissive powers of surfaces are

$$A_1 = A_2 = (10 \text{ ft})^2 = 100 \text{ ft}^2 \quad A_3 = 4(10 \text{ ft})^2 = 400 \text{ ft}^2$$

$$E_{b1} = \sigma T_1^4 = (0.1714 \times 10^{-8} \text{ Btu/h.ft}^2 \cdot \text{R}^4)(800 \text{ R})^4 = 702 \text{ Btu/h.ft}^2$$

$$E_{b2} = \sigma T_2^4 = (0.1714 \times 10^{-8} \text{ Btu/h.ft}^2 \cdot \text{R}^4)(1600 \text{ R})^4 = 11,233 \text{ Btu/h.ft}^2$$

$$E_{b3} = \sigma T_3^4 = (0.1714 \times 10^{-8} \text{ Btu/h.ft}^2 \cdot \text{R}^4)(2400 \text{ R})^4 = 56,866 \text{ Btu/h.ft}^2$$

The view factor from the base to the top surface of the cube is $F_{12} = 0.2$. From the summation rule, the view factor from the base or top to the side surfaces is

$$F_{11} + F_{12} + F_{13} = 1 \longrightarrow F_{13} = 1 - F_{12} = 1 - 0.2 = 0.8$$

since the base surface is flat and thus $F_{11} = 0$. Then the radiation resistances become

$$R_1 = \frac{1 - \varepsilon_1}{A_1 \varepsilon_1} = \frac{1 - 0.7}{(100 \text{ ft}^2)(0.7)} = 0.0043 \text{ ft}^{-2} \quad R_{12} = \frac{1}{A_1 F_{12}} = \frac{1}{(100 \text{ ft}^2)(0.2)} = 0.0500 \text{ ft}^{-2}$$

$$R_{13} = \frac{1}{A_1 F_{13}} = \frac{1}{(100 \text{ ft}^2)(0.8)} = 0.0125 \text{ ft}^{-2}$$

Note that the side and the top surfaces are black, and thus their radiosities are equal to their emissive powers. The radiosity of the base surface is determined

$$\frac{E_{b1} - J_1}{R_1} + \frac{E_{b2} - J_1}{R_{12}} + \frac{E_{b3} - J_1}{R_{13}} = 0$$

$$\text{Substituting,} \quad \frac{702 - J_1}{0.0043} + \frac{11,233 - J_1}{0.05} + \frac{56,866 - J_1}{0.0125} = 0 \longrightarrow J_1 = 15,054 \text{ W/m}^2$$

(a) The net rate of radiation heat transfer between the base and the side surfaces is

$$\dot{Q}_{31} = \frac{E_{b3} - J_1}{R_{13}} = \frac{(56,866 - 15,054) \text{ Btu/h.ft}^2}{0.0125 \text{ ft}^{-2}} = \mathbf{3.345 \times 10^6 \text{ Btu/h}}$$

(b) The net rate of radiation heat transfer between the base and the top surfaces is

$$\dot{Q}_{12} = \frac{J_1 - E_{b2}}{R_{12}} = \frac{(15,054 - 11,233) \text{ Btu/h.ft}^2}{0.05 \text{ ft}^{-2}} = \mathbf{7.642 \times 10^4 \text{ Btu/h}}$$

The net rate of radiation heat transfer to the base surface is finally determined from

$$\dot{Q}_1 = \dot{Q}_{21} + \dot{Q}_{31} = -76,420 + 3,344,960 = \mathbf{3.269 \times 10^6 \text{ Btu/h}}$$

Discussion The same result can be found from

$$\dot{Q}_1 = \frac{J_1 - E_{b1}}{R_1} = \frac{(15,054 - 702) \text{ Btu/h.ft}^2}{0.0043 \text{ ft}^{-2}} = 3.338 \times 10^6 \text{ Btu/h}$$

The small difference is due to round-off error.

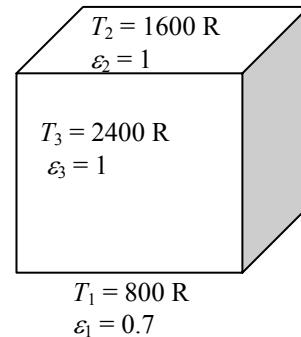

13-27E EES Prob. 13-26E is reconsidered. The effect of base surface emissivity on the net rates of radiation heat transfer between the base and the side surfaces, between the base and top surfaces, and to the base surface is to be investigated.

Analysis The problem is solved using EES, and the solution is given below.

"GIVEN"

a=10 [ft]
 epsilon_1=0.7
 T_1=800 [R]
 T_2=1600 [R]
 T_3=2400 [R]

"ANALYSIS"

sigma=0.1714E-8 [Btu/h-ft^2-R^4] "Stefan-Boltzmann constant"
 "Consider the base surface 1, the top surface 2, and the side surface 3"
 E_b1=sigma*T_1^4
 E_b2=sigma*T_2^4
 E_b3=sigma*T_3^4
 A_1=a^2
 A_2=A_1
 A_3=4*a^2
 F_12=0.2 "view factor from the base to the top of a cube"
 F_11+F_12+F_13=1 "summation rule"
 F_11=0 "since the base surface is flat"
 R_1=(1-epsilon_1)/(A_1*epsilon_1) "surface resistance"
 R_12=1/(A_1*F_12) "space resistance"
 R_13=1/(A_1*F_13) "space resistance"
 (E_b1-J_1)/R_1+(E_b2-J_1)/R_12+(E_b3-J_1)/R_13=0 "J_1 : radiosity of base surface"
 "(a)"
 Q_dot_31=(E_b3-J_1)/R_13
 "(b)"
 Q_dot_12=(J_1-E_b2)/R_12
 Q_dot_21=-Q_dot_12
 Q_dot_1=Q_dot_21+Q_dot_31

ϵ_1	Q_{31} [Btu/h]	Q_{12} [Btu/h]	Q_1 [Btu/h]
0.1	1.106E+06	636061	470376
0.15	1.295E+06	589024	705565
0.2	1.483E+06	541986	940753
0.25	1.671E+06	494948	1.176E+06
0.3	1.859E+06	447911	1.411E+06
0.35	2.047E+06	400873	1.646E+06
0.4	2.235E+06	353835	1.882E+06
0.45	2.423E+06	306798	2.117E+06
0.5	2.612E+06	259760	2.352E+06
0.55	2.800E+06	212722	2.587E+06
0.6	2.988E+06	165685	2.822E+06
0.65	3.176E+06	118647	3.057E+06
0.7	3.364E+06	71610	3.293E+06
0.75	3.552E+06	24572	3.528E+06
0.8	3.741E+06	-22466	3.763E+06
0.85	3.929E+06	-69503	3.998E+06
0.9	4.117E+06	-116541	4.233E+06

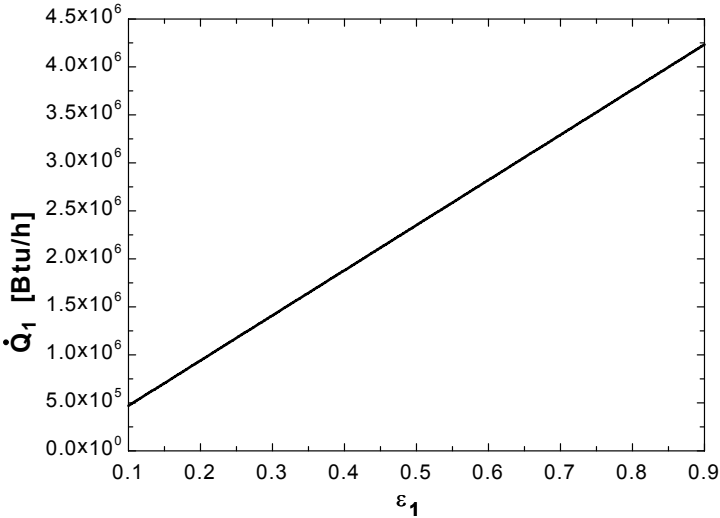
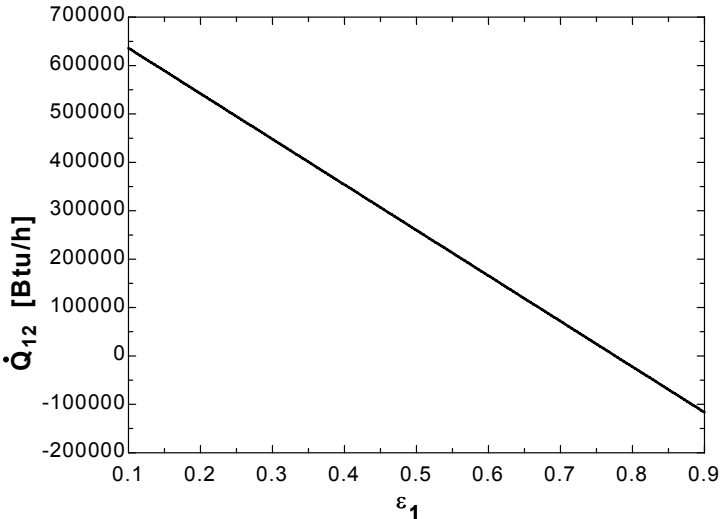
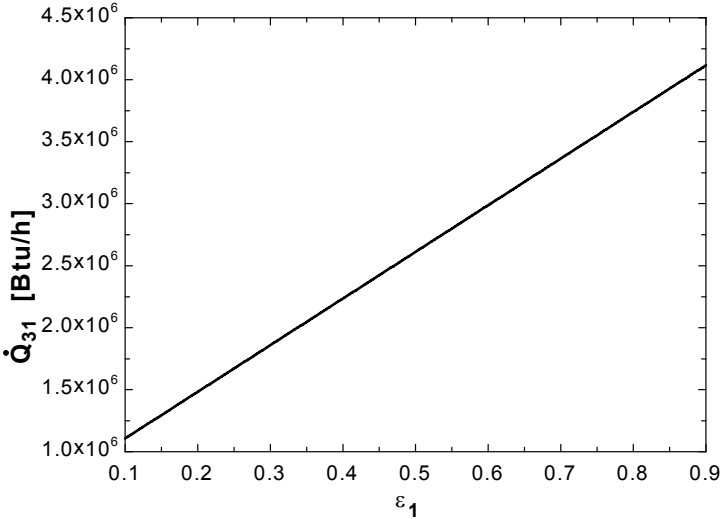

13-28 Two very large parallel plates are maintained at uniform temperatures. The net rate of radiation heat transfer between the two plates is to be determined.

Assumptions 1 Steady operating conditions exist 2 The surfaces are opaque, diffuse, and gray. 3 Convection heat transfer is not considered.

Properties The emissivities ε of the plates are given to be 0.5 and 0.9.

Analysis The net rate of radiation heat transfer between the two surfaces per unit area of the plates is determined directly from

$$\frac{\dot{Q}_{12}}{A_s} = \frac{\sigma(T_1^4 - T_2^4)}{\frac{1}{\varepsilon_1} + \frac{1}{\varepsilon_2} - 1} = \frac{(5.67 \times 10^{-8} \text{ W/m}^2 \cdot \text{K}^4)[(600 \text{ K})^4 - (400 \text{ K})^4]}{\frac{1}{0.5} + \frac{1}{0.9} - 1} = \mathbf{2793 \text{ W/m}^2}$$

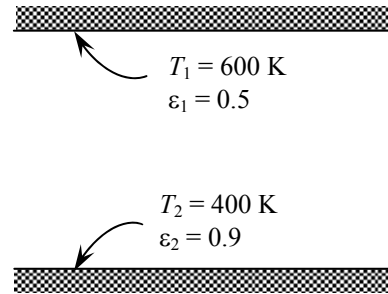

13-29 EES Prob. 13-28 is reconsidered. The effects of the temperature and the emissivity of the hot plate on the net rate of radiation heat transfer between the plates are to be investigated.

Analysis The problem is solved using EES, and the solution is given below.

"GIVEN"

$T_1=600$ [K]

$T_2=400$ [K]

$\epsilon_1=0.5$

$\epsilon_2=0.9$

$\sigma=5.67E-8$ [W/m²-K⁴] "Stefan-Boltzmann constant"

"ANALYSIS"

$\dot{q}_{12}=(\sigma*(T_1^4-T_2^4))/(1/\epsilon_1+1/\epsilon_2-1)$

T_1 [K]	\dot{q}_{12} [W/m ²]
500	991.1
525	1353
550	1770
575	2248
600	2793
625	3411
650	4107
675	4888
700	5761
725	6733
750	7810
775	9001
800	10313
825	11754
850	13332
875	15056
900	16934
925	18975
950	21188
975	23584
1000	26170

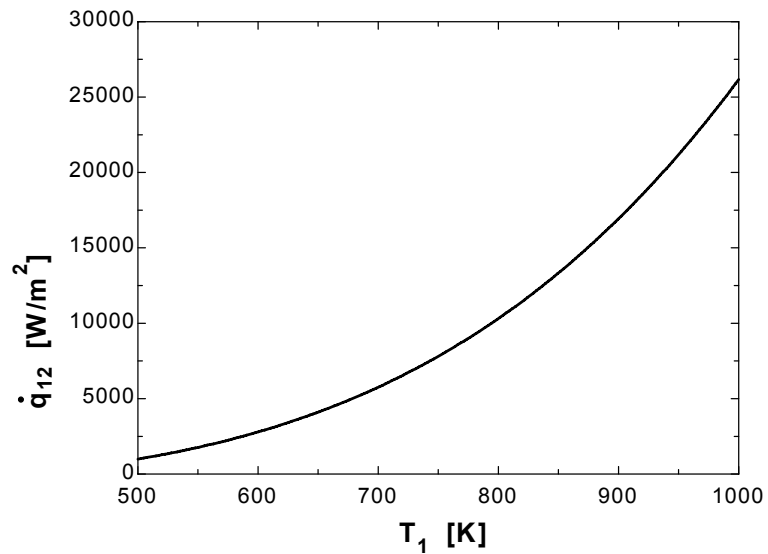

ϵ_1	\dot{q}_{12} [W/m ²]
0.1	583.2
0.15	870
0.2	1154
0.25	1434
0.3	1712
0.35	1987
0.4	2258
0.45	2527
0.5	2793
0.55	3056
0.6	3317
0.65	3575
0.7	3830
0.75	4082
0.8	4332
0.85	4580
0.9	4825

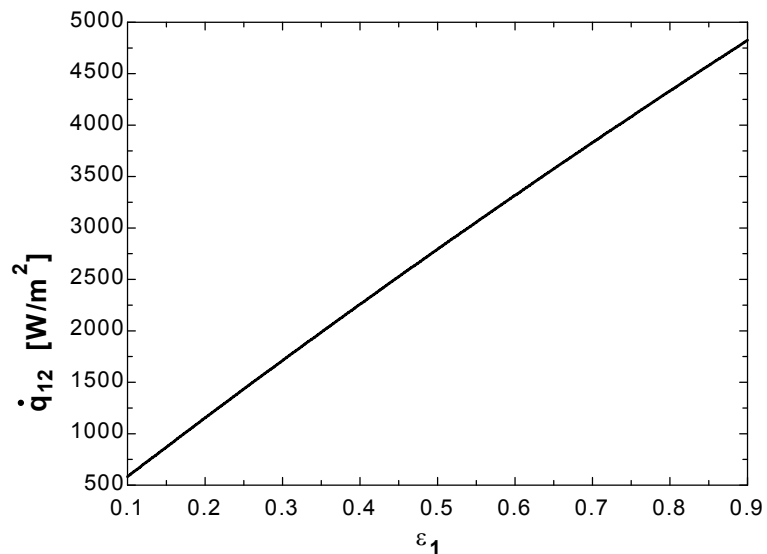

13-30 The base, top, and side surfaces of a furnace of cylindrical shape are black, and are maintained at uniform temperatures. The net rate of radiation heat transfer to or from the top surface is to be determined.

Assumptions 1 Steady operating conditions exist 2 The surfaces are black. 3 Convection heat transfer is not considered.

Properties The emissivity of all surfaces are $\varepsilon = 1$ since they are black.

Analysis We consider the top surface to be surface 1, the base surface to be surface 2 and the side surfaces to be surface 3. The cylindrical furnace can be considered to be three-surface enclosure. We assume that steady-state conditions exist. Since all surfaces are black, the radiosities are equal to the emissive power of surfaces, and the net rate of radiation heat transfer from the top surface can be determined from

$$\dot{Q} = A_1 F_{12} \sigma (T_1^4 - T_2^4) + A_1 F_{13} \sigma (T_1^4 - T_3^4)$$

and $A_1 = \pi r^2 = \pi (2 \text{ m})^2 = 12.57 \text{ m}^2$

The view factor from the base to the top surface of the cylinder is $F_{12} = 0.38$ (From Figure 13-7). The view factor from the base to the side surfaces is determined by applying the summation rule to be

$$F_{11} + F_{12} + F_{13} = 1 \longrightarrow F_{13} = 1 - F_{12} = 1 - 0.38 = 0.62$$

Substituting,

$$\begin{aligned} \dot{Q} &= A_1 F_{12} \sigma (T_1^4 - T_2^4) + A_1 F_{13} \sigma (T_1^4 - T_3^4) \\ &= (12.57 \text{ m}^2)(0.38)(5.67 \times 10^{-8} \text{ W/m}^2 \cdot \text{K}^4)(700 \text{ K}^4 - 500 \text{ K}^4) \\ &\quad + (12.57 \text{ m}^2)(0.62)(5.67 \times 10^{-8} \text{ W/m}^2 \cdot \text{K}^4)(700 \text{ K}^4 - 1400 \text{ K}^4) \\ &= -1.543 \times 10^6 \text{ W} = \mathbf{-1543 \text{ kW}} \end{aligned}$$

Discussion The negative sign indicates that net heat transfer is to the top surface.

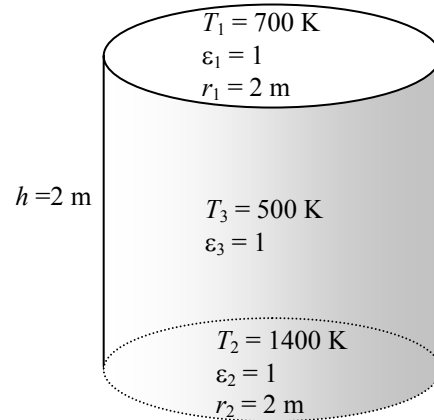

13-31 The base and the dome of a hemispherical furnace are maintained at uniform temperatures. The net rate of radiation heat transfer from the dome to the base surface is to be determined.

Assumptions 1 Steady operating conditions exist 2 The surfaces are opaque, diffuse, and gray. 3 Convection heat transfer is not considered.

Analysis The view factor is first determined from

$$F_{11} = 0 \text{ (flat surface)}$$

$$F_{11} + F_{12} = 1 \rightarrow F_{12} = 1 \text{ (summation rule)}$$

Noting that the dome is black, net rate of radiation heat transfer from dome to the base surface can be determined from

$$\begin{aligned} \dot{Q}_{21} &= -\dot{Q}_{12} = -\varepsilon A_1 F_{12} \sigma (T_1^4 - T_2^4) \\ &= -(0.7)[\pi (5 \text{ m})^2 / 4](1)(5.67 \times 10^{-8} \text{ W/m}^2 \cdot \text{K}^4)[(400 \text{ K})^4 - (1000 \text{ K})^4] \\ &= 7.594 \times 10^5 \text{ W} \\ &= \mathbf{759 \text{ kW}} \end{aligned}$$

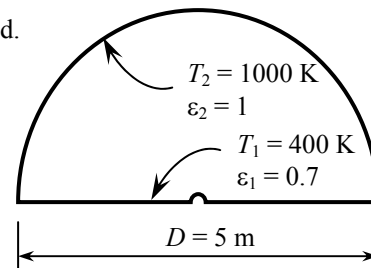

The positive sign indicates that the net heat transfer is from the dome to the base surface, as expected.

13-32 Two very long concentric cylinders are maintained at uniform temperatures. The net rate of radiation heat transfer between the two cylinders is to be determined.

Assumptions 1 Steady operating conditions exist 2 The surfaces are opaque, diffuse, and gray. 3 Convection heat transfer is not considered.

Properties The emissivities of surfaces are given to be $\varepsilon_1 = 1$ and $\varepsilon_2 = 0.55$.

Analysis The net rate of radiation heat transfer between the two cylinders per unit length of the cylinders is determined from

$$\begin{aligned}\dot{Q}_{12} &= \frac{A_1 \sigma (T_1^4 - T_2^4)}{\frac{1}{\varepsilon_1} + \frac{1 - \varepsilon_2}{\varepsilon_2} \left(\frac{r_1}{r_2} \right)} \\ &= \frac{[\pi(0.35 \text{ m})(1 \text{ m})](5.67 \times 10^{-8} \text{ W/m}^2 \cdot \text{K}^4)[(950 \text{ K})^4 - (500 \text{ K})^4]}{\frac{1}{1} + \frac{1 - 0.55}{0.55} \left(\frac{3.5}{5} \right)} \\ &= 29,810 \text{ W} = \mathbf{29.81 \text{ kW}}\end{aligned}$$

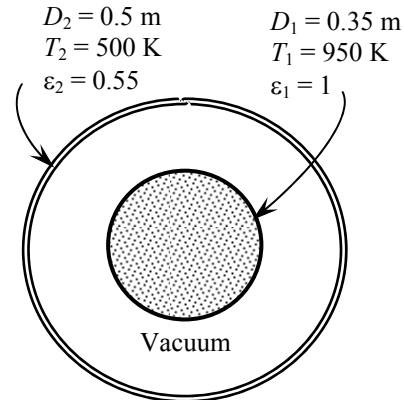

13-33 A long cylindrical rod coated with a new material is placed in an evacuated long cylindrical enclosure which is maintained at a uniform temperature. The emissivity of the coating on the rod is to be determined.

Assumptions 1 Steady operating conditions exist 2 The surfaces are opaque, diffuse, and gray.

Properties The emissivity of the enclosure is given to be $\varepsilon_2 = 0.95$.

Analysis The emissivity of the coating on the rod is determined from

$$\begin{aligned}\dot{Q}_{12} &= \frac{A_1 \sigma (T_1^4 - T_2^4)}{\frac{1}{\varepsilon_1} + \frac{1 - \varepsilon_2}{\varepsilon_2} \left(\frac{r_1}{r_2} \right)} \\ 8 \text{ W} &= \frac{[\pi(0.01 \text{ m})(1 \text{ m})](5.67 \times 10^{-8} \text{ W/m}^2 \cdot \text{K}^4)[(500 \text{ K})^4 - (200 \text{ K})^4]}{\frac{1}{\varepsilon_1} + \frac{1 - 0.95}{0.95} \left(\frac{1}{10} \right)}\end{aligned}$$

which gives

$$\varepsilon_1 = \mathbf{0.074}$$

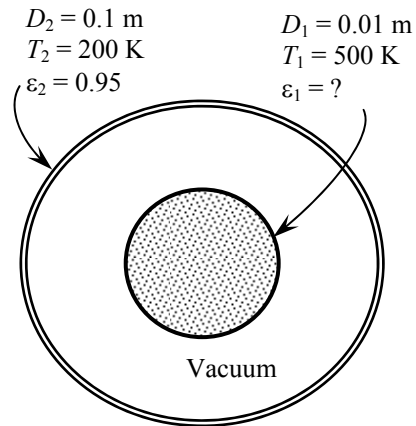

13-34E The base and the dome of a long semicylindrical duct are maintained at uniform temperatures. The net rate of radiation heat transfer from the dome to the base surface is to be determined.

Assumptions 1 Steady operating conditions exist 2 The surfaces are opaque, diffuse, and gray. 3 Convection heat transfer is not considered.

Properties The emissivities of surfaces are given to be $\varepsilon_1 = 0.5$ and $\varepsilon_2 = 0.9$.

Analysis The view factor from the base to the dome is first determined from

$$F_{11} = 0 \text{ (flat surface)}$$

$$F_{11} + F_{12} = 1 \rightarrow F_{12} = 1 \text{ (summation rule)}$$

The net rate of radiation heat transfer from dome to the base surface can be determined from

$$\dot{Q}_{21} = -\dot{Q}_{12} = -\frac{\sigma(T_1^4 - T_2^4)}{\frac{1-\varepsilon_1}{A_1\varepsilon_1} + \frac{1}{A_1F_{12}} + \frac{1-\varepsilon_2}{A_2\varepsilon_2}} = -\frac{(0.1714 \times 10^{-8} \text{ Btu/h}\cdot\text{ft}^2 \cdot \text{R}^4)[(550 \text{ R})^4 - (1800 \text{ R})^4]}{\frac{1-0.5}{(15 \text{ ft}^2)(0.5)} + \frac{1}{(15 \text{ ft}^2)(1)} + \frac{1-0.9}{\left[\frac{\pi(15 \text{ ft})(1 \text{ ft})}{2}\right](0.9)}}$$

$$= \mathbf{129,200 \text{ Btu/h}} \text{ per ft length}$$

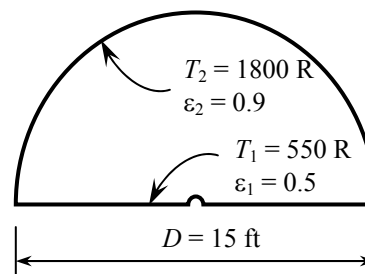

The positive sign indicates that the net heat transfer is from the dome to the base surface, as expected.

13-35 Two parallel disks whose back sides are insulated are black, and are maintained at a uniform temperature. The net rate of radiation heat transfer from the disks to the environment is to be determined.

Assumptions 1 Steady operating conditions exist 2 The surfaces are opaque, diffuse, and gray. 3 Convection heat transfer is not considered.

Properties The emissivities of all surfaces are $\varepsilon = 1$ since they are black.

Analysis Both disks possess same properties and they are black. Noting that environment can also be considered to be blackbody, we can treat this geometry as a three surface enclosure. We consider the two disks to be surfaces 1 and 2 and the environment to be surface 3. Then from Figure 13-7, we read

$$F_{12} = F_{21} = 0.26$$

$$F_{13} = 1 - 0.26 = 0.74 \quad \text{(summation rule)}$$

The net rate of radiation heat transfer from the disks into the environment then becomes

$$\dot{Q}_3 = \dot{Q}_{13} + \dot{Q}_{23} = 2\dot{Q}_{13}$$

$$\dot{Q}_3 = 2F_{13}A_1\sigma(T_1^4 - T_3^4)$$

$$= 2(0.74)[\pi(0.3 \text{ m})^2](5.67 \times 10^{-8} \text{ W/m}^2 \cdot \text{K}^4)[(450 \text{ K})^4 - (300 \text{ K})^4]$$

$$= \mathbf{781 \text{ W}}$$

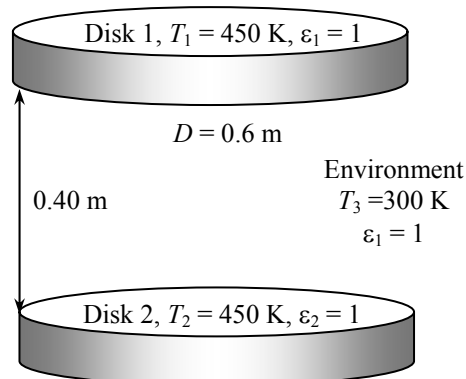

13-36 A furnace shaped like a long equilateral-triangular duct is considered. The temperature of the base surface is to be determined.

Assumptions 1 Steady operating conditions exist 2 The surfaces are opaque, diffuse, and gray. 3 Convection heat transfer is not considered. 4 End effects are neglected.

Properties The emissivities of surfaces are given to be $\varepsilon_1 = 0.8$ and $\varepsilon_2 = 0.5$.

Analysis This geometry can be treated as a two surface enclosure since two surfaces have identical properties. We consider base surface to be surface 1 and other two surface to be surface 2. Then the view factor between the two becomes $F_{12} = 1$. The temperature of the base surface is determined from

$$\dot{Q}_{12} = \frac{\sigma(T_1^4 - T_2^4)}{\frac{1-\varepsilon_1}{A_1\varepsilon_1} + \frac{1}{A_1F_{12}} + \frac{1-\varepsilon_2}{A_2\varepsilon_2}}$$

$$800 \text{ W} = \frac{(5.67 \times 10^{-8} \text{ W/m}^2 \cdot \text{K}^4)[(T_1)^4 - (500 \text{ K})^4]}{\frac{1-0.8}{(1 \text{ m}^2)(0.8)} + \frac{1}{(1 \text{ m}^2)(1)} + \frac{1-0.5}{(2 \text{ m}^2)(0.5)}}$$

$$T_1 = \mathbf{543 \text{ K}}$$

Note that $A_1 = 1 \text{ m}^2$ and $A_2 = 2 \text{ m}^2$.

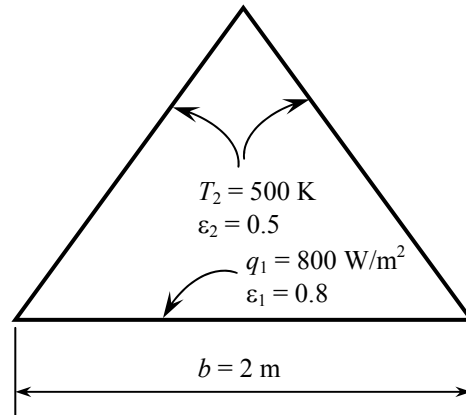

13-37 EES Prob. 13-36 is reconsidered. The effects of the rate of the heat transfer at the base surface and the temperature of the side surfaces on the temperature of the base surface are to be investigated.

Analysis The problem is solved using EES, and the solution is given below.

"GIVEN"

a=2 [m]
 epsilon_1=0.8
 epsilon_2=0.5
 Q_dot_12=800 [W]
 T_2=500 [K]
 sigma=5.67E-8 [W/m^2-K^4]

"ANALYSIS"

"Consider the base surface to be surface 1, the side surfaces to be surface 2"

$$Q_{dot_{12}} = \frac{\sigma(T_1^4 - T_2^4)}{\left(\frac{1 - \epsilon_1}{A_1 \epsilon_1} + \frac{1}{A_1 F_{12}} + \frac{1 - \epsilon_2}{A_2 \epsilon_2}\right)}$$

F_12=1

A_1=1 "[m^2], since rate of heat supply is given per meter square area"

A_2=2*A_1

Q ₁₂ [W]	T ₁ [K]
500	528.4
525	529.7
550	531
575	532.2
600	533.5
625	534.8
650	536
675	537.3
700	538.5
725	539.8
750	541
775	542.2
800	543.4
825	544.6
850	545.8
875	547
900	548.1
925	549.3
950	550.5
975	551.6
1000	552.8

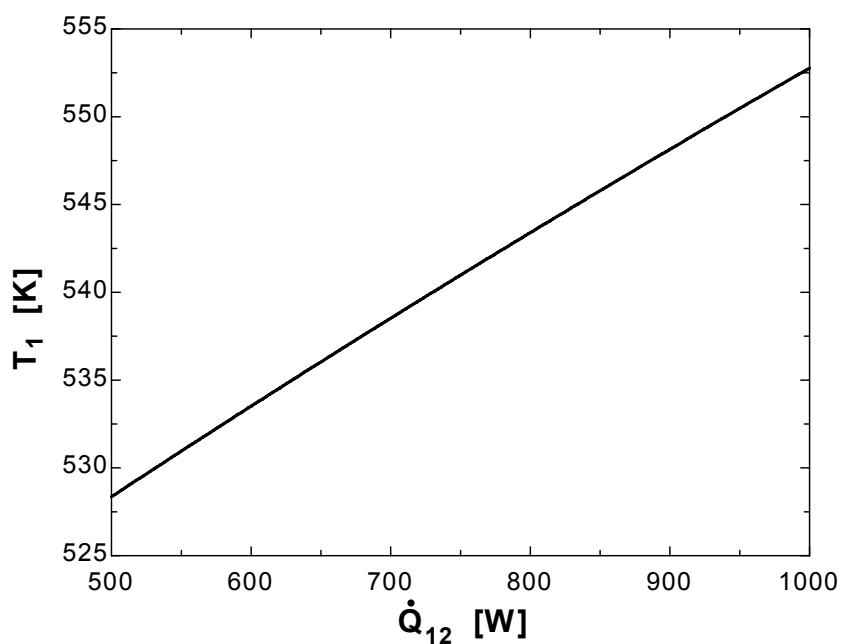

T_2 [K]	T_1 [K]
300	425.5
325	435.1
350	446.4
375	459.2
400	473.6
425	489.3
450	506.3
475	524.4
500	543.4
525	563.3
550	583.8
575	605
600	626.7
625	648.9
650	671.4
675	694.2
700	717.3

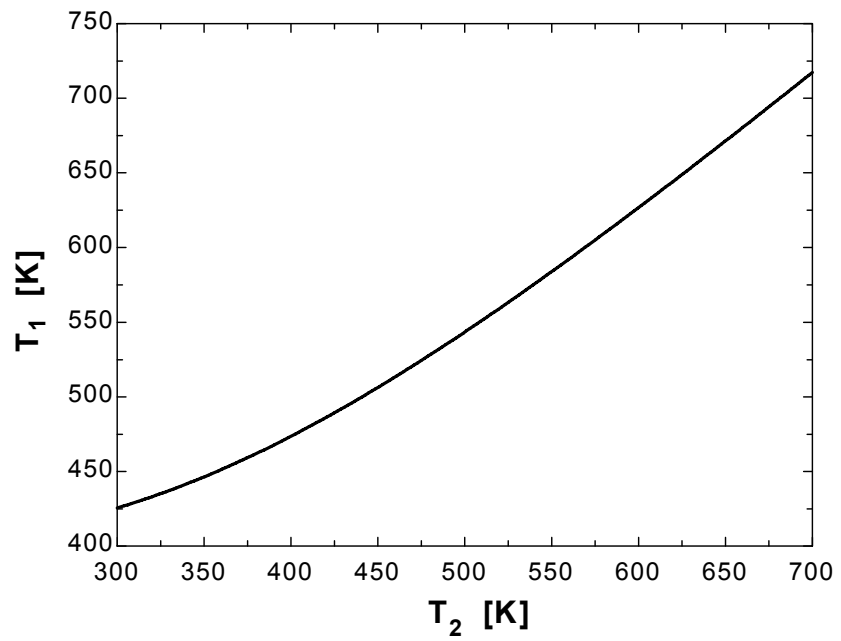

13-38 The floor and the ceiling of a cubical furnace are maintained at uniform temperatures. The net rate of radiation heat transfer between the floor and the ceiling is to be determined.

Assumptions 1 Steady operating conditions exist 2 The surfaces are opaque, diffuse, and gray. 3 Convection heat transfer is not considered.

Properties The emissivities of all surfaces are $\varepsilon = 1$ since they are black or reradiating.

Analysis We consider the ceiling to be surface 1, the floor to be surface 2 and the side surfaces to be surface 3. The furnace can be considered to be three-surface enclosure. We assume that steady-state conditions exist. Since the side surfaces are reradiating, there is no heat transfer through them, and the entire heat lost by the ceiling must be gained by the floor. The view factor from the ceiling to the floor of the furnace is $F_{12} = 0.2$. Then the rate of heat loss from the ceiling can be determined from

$$\dot{Q}_1 = \frac{E_{b1} - E_{b2}}{\left(\frac{1}{R_{12}} + \frac{1}{R_{13} + R_{23}} \right)^{-1}}$$

where

$$E_{b1} = \sigma T_1^4 = (5.67 \times 10^{-8} \text{ W/m}^2 \cdot \text{K}^4)(1100 \text{ K})^4 = 83,015 \text{ W/m}^2$$

$$E_{b2} = \sigma T_2^4 = (5.67 \times 10^{-8} \text{ W/m}^2 \cdot \text{K}^4)(550 \text{ K})^4 = 5188 \text{ W/m}^2$$

and

$$A_1 = A_2 = (4 \text{ m})^2 = 16 \text{ m}^2$$

$$R_{12} = \frac{1}{A_1 F_{12}} = \frac{1}{(16 \text{ m}^2)(0.2)} = 0.3125 \text{ m}^{-2}$$

$$R_{13} = R_{23} = \frac{1}{A_1 F_{13}} = \frac{1}{(16 \text{ m}^2)(0.8)} = 0.078125 \text{ m}^{-2}$$

Substituting,

$$\dot{Q}_{12} = \frac{(83,015 - 5188) \text{ W/m}^2}{\left(\frac{1}{0.3125 \text{ m}^{-2}} + \frac{1}{2(0.078125 \text{ m}^{-2})} \right)^{-1}} = 7.47 \times 10^5 \text{ W} = \mathbf{747 \text{ kW}}$$

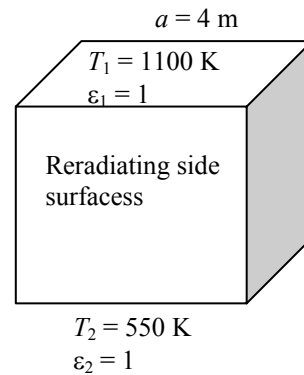

13-39 Two concentric spheres are maintained at uniform temperatures. The net rate of radiation heat transfer between the two spheres and the convection heat transfer coefficient at the outer surface are to be determined.

Assumptions 1 Steady operating conditions exist 2 The surfaces are opaque, diffuse, and gray.

Properties The emissivities of surfaces are given to be $\varepsilon_1 = 0.5$ and $\varepsilon_2 = 0.7$.

Analysis The net rate of radiation heat transfer between the two spheres is

$$\begin{aligned}\dot{Q}_{12} &= \frac{A_1 \sigma (T_1^4 - T_2^4)}{\frac{1}{\varepsilon_1} + \frac{1 - \varepsilon_2}{\varepsilon_2} \left(\frac{r_1^2}{r_2^2} \right)} \\ &= \frac{[\pi(0.3 \text{ m})^2] [5.67 \times 10^{-8} \text{ W/m}^2 \cdot \text{K}^4] [(700 \text{ K})^4 - (500 \text{ K})^4]}{\frac{1}{0.5} + \frac{1 - 0.7}{0.7} \left(\frac{0.15 \text{ m}}{0.2 \text{ m}} \right)^2} \\ &= \mathbf{1270 \text{ W}}\end{aligned}$$

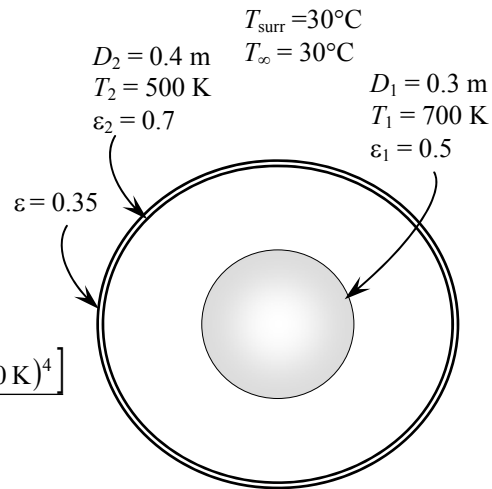

Radiation heat transfer rate from the outer sphere to the surrounding surfaces are

$$\begin{aligned}\dot{Q}_{rad} &= \varepsilon F A_2 \sigma (T_2^4 - T_{surr}^4) \\ &= (0.35)(1)[\pi(0.4 \text{ m})^2] (5.67 \times 10^{-8} \text{ W/m}^2 \cdot \text{K}^4) [(500 \text{ K})^4 - (30 + 273 \text{ K})^4] \\ &= 539 \text{ W}\end{aligned}$$

The convection heat transfer rate at the outer surface of the cylinder is determined from requirement that heat transferred from the inner sphere to the outer sphere must be equal to the heat transfer from the outer surface of the outer sphere to the environment by convection and radiation. That is,

$$\dot{Q}_{conv} = \dot{Q}_{12} - \dot{Q}_{rad} = 1270 - 539 = 731 \text{ W}$$

Then the convection heat transfer coefficient becomes

$$\begin{aligned}\dot{Q}_{conv} &= h A_2 (T_2 - T_\infty) \\ 731 \text{ W} &= h [\pi(0.4 \text{ m})^2] (500 \text{ K} - 303 \text{ K}) \\ h &= \mathbf{7.4 \text{ W/m}^2 \cdot ^\circ\text{C}}\end{aligned}$$

13-40 A spherical tank filled with liquid nitrogen is kept in an evacuated cubic enclosure. The net rate of radiation heat transfer to the liquid nitrogen is to be determined.

Assumptions 1 Steady operating conditions exist 2 The surfaces are opaque, diffuse, and gray. 3 Convection heat transfer is not considered. 4 The thermal resistance of the tank is negligible.

Properties The emissivities of surfaces are given to be $\varepsilon_1 = 0.1$ and $\varepsilon_2 = 0.8$.

Analysis We take the sphere to be surface 1 and the surrounding cubic enclosure to be surface 2. Noting that $F_{12} = 1$, for this two-surface enclosure, the net rate of radiation heat transfer to liquid nitrogen can be determined from

$$\begin{aligned}\dot{Q}_{21} = -\dot{Q}_{12} &= -\frac{A_1 \sigma (T_1^4 - T_2^4)}{\frac{1}{\varepsilon_1} + \frac{1 - \varepsilon_2}{\varepsilon_2} \left(\frac{A_1}{A_2} \right)} \\ &= -\frac{[\pi(2 \text{ m})^2] [5.67 \times 10^{-8} \text{ W/m}^2 \cdot \text{K}^4] [(100 \text{ K})^4 - (240 \text{ K})^4]}{\frac{1}{0.1} + \frac{1 - 0.8}{0.8} \left[\frac{\pi(2 \text{ m})^2}{6(3 \text{ m})^2} \right]} \\ &= \mathbf{228 \text{ W}}\end{aligned}$$

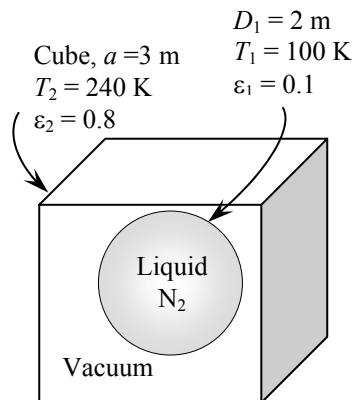

13-41 A spherical tank filled with liquid nitrogen is kept in an evacuated spherical enclosure. The net rate of radiation heat transfer to the liquid nitrogen is to be determined.

Assumptions 1 Steady operating conditions exist 2 The surfaces are opaque, diffuse, and gray. 3 Convection heat transfer is not considered. 4 The thermal resistance of the tank is negligible.

Properties The emissivities of surfaces are given to be $\varepsilon_1 = 0.1$ and $\varepsilon_2 = 0.8$.

Analysis The net rate of radiation heat transfer to liquid nitrogen can be determined from

$$\begin{aligned}\dot{Q}_{12} &= \frac{A_1 \sigma (T_1^4 - T_2^4)}{\frac{1}{\varepsilon_1} + \frac{1 - \varepsilon_2}{\varepsilon_2} \left(\frac{r_1^2}{r_2^2} \right)} \\ &= \frac{[\pi(2 \text{ m})^2] [5.67 \times 10^{-8} \text{ W/m}^2 \cdot \text{K}^4] [(240 \text{ K})^4 - (100 \text{ K})^4]}{\frac{1}{0.1} + \frac{1 - 0.8}{0.8} \left[\frac{(1 \text{ m})^2}{(1.5 \text{ m})^2} \right]} \\ &= \mathbf{227 \text{ W}}\end{aligned}$$

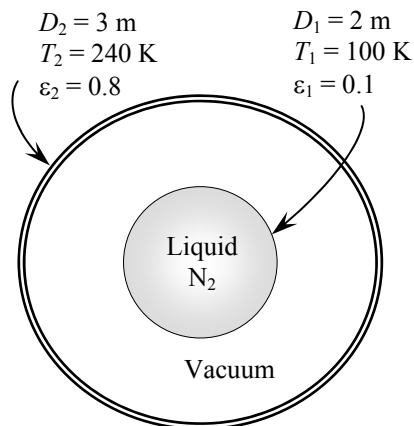

13-42 EES Prob. 13-40 is reconsidered. The effects of the side length and the emissivity of the cubic enclosure, and the emissivity of the spherical tank on the net rate of radiation heat transfer are to be investigated.

Analysis The problem is solved using EES, and the solution is given below.

"GIVEN"

D=2 [m]

a=3 [m]

T_1=100 [K]

T_2=240 [K]

epsilon_1=0.1

epsilon_2=0.8

sigma=5.67E-8 [W/m^2-K^4] "Stefan-Boltzmann constant"

"ANALYSIS"

"Consider the sphere to be surface 1, the surrounding cubic enclosure to be surface 2"

$Q_{dot_{12}}=(A_1 \cdot \sigma \cdot (T_1^4 - T_2^4)) / (1/\epsilon_1 + (1 - \epsilon_2)/\epsilon_2 \cdot (A_1/A_2))$

$Q_{dot_{21}} = -Q_{dot_{12}}$

$A_1 = \pi \cdot D^2$

$A_2 = 6 \cdot a^2$

a [m]	Q ₂₁ [W]
2.5	227.4
2.625	227.5
2.75	227.7
2.875	227.8
3	227.9
3.125	228
3.25	228.1
3.375	228.2
3.5	228.3
3.625	228.4
3.75	228.4
3.875	228.5
4	228.5
4.125	228.6
4.25	228.6
4.375	228.6
4.5	228.7
4.625	228.7
4.75	228.7
4.875	228.8
5	228.8

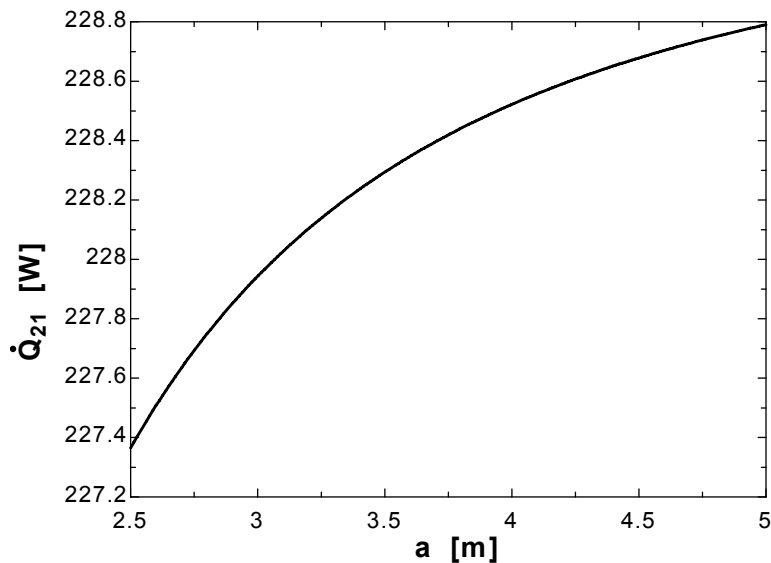

ε_1	Q_{21} [W]
0.1	227.9
0.15	340.9
0.2	453.3
0.25	565
0.3	676
0.35	786.4
0.4	896.2
0.45	1005
0.5	1114
0.55	1222
0.6	1329
0.65	1436
0.7	1542
0.75	1648
0.8	1753
0.85	1857
0.9	1961

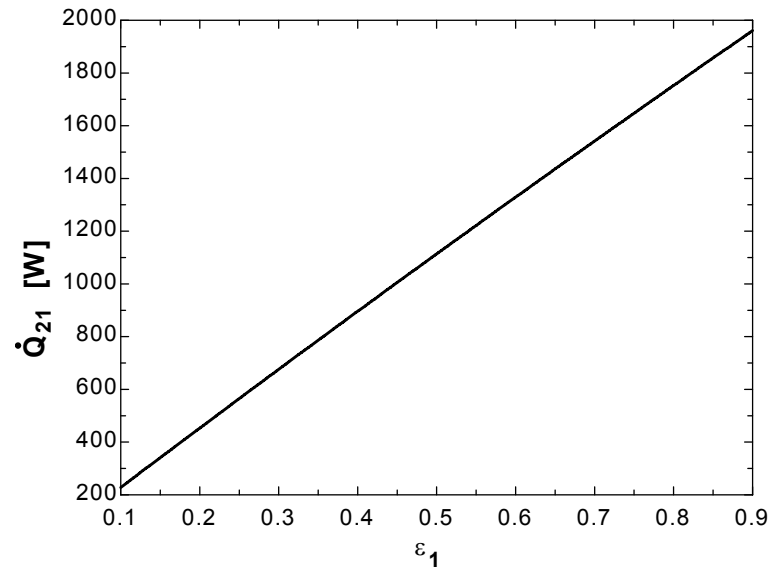

ε_2	Q_{21} [W]
0.1	189.6
0.15	202.6
0.2	209.7
0.25	214.3
0.3	217.5
0.35	219.8
0.4	221.5
0.45	222.9
0.5	224.1
0.55	225
0.6	225.8
0.65	226.4
0.7	227
0.75	227.5
0.8	227.9
0.85	228.3
0.9	228.7

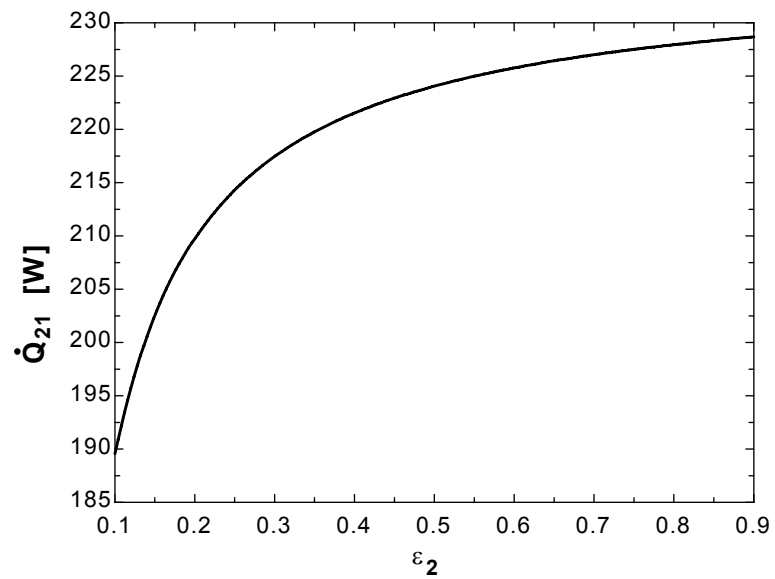

13-43 A circular grill is considered. The bottom of the grill is covered with hot coal bricks, while the wire mesh on top of the grill is covered with steaks. The initial rate of radiation heat transfer from coal bricks to the steaks is to be determined for two cases.

Assumptions 1 Steady operating conditions exist 2 The surfaces are opaque, diffuse, and gray. 3 Convection heat transfer is not considered.

Properties The emissivities are $\varepsilon = 1$ for all surfaces since they are black or reradiating.

Analysis We consider the coal bricks to be surface 1, the steaks to be surface 2 and the side surfaces to be surface 3. First we determine the view factor between the bricks and the steaks (Table 13-1),

$$R_i = R_j = \frac{r_i}{L} = \frac{0.15 \text{ m}}{0.20 \text{ m}} = 0.75$$

$$S = 1 + \frac{1 + R_j^2}{R_i^2} = \frac{1 + 0.75^2}{0.75^2} = 3.7778$$

$$F_{12} = F_{ij} = \frac{1}{2} \left\{ S - \left[S^2 - 4 \left(\frac{R_j}{R_i} \right)^2 \right]^{1/2} \right\} = \frac{1}{2} \left\{ 3.7778 - \left[3.7778^2 - 4 \left(\frac{0.75}{0.75} \right)^2 \right]^{1/2} \right\} = 0.2864$$

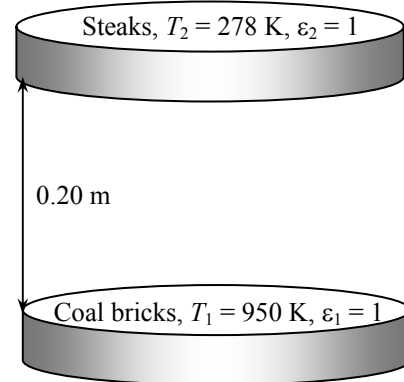

(It can also be determined from Fig. 13-7).

Then the initial rate of radiation heat transfer from the coal bricks to the steaks becomes

$$\begin{aligned} \dot{Q}_{12} &= F_{12} A_1 \sigma (T_1^4 - T_2^4) \\ &= (0.2864) [\pi (0.3 \text{ m})^2 / 4] (5.67 \times 10^{-8} \text{ W/m}^2 \cdot \text{K}^4) [(950 \text{ K})^4 - (278 \text{ K})^4] \\ &= \mathbf{928 \text{ W}} \end{aligned}$$

When the side opening is closed with aluminum foil, the entire heat lost by the coal bricks must be gained by the steaks since there will be no heat transfer through a reradiating surface. The grill can be considered to be three-surface enclosure. Then the rate of heat loss from the coal bricks can be determined from

$$\dot{Q}_1 = \frac{E_{b1} - E_{b2}}{\left(\frac{1}{R_{12}} + \frac{1}{R_{13} + R_{23}} \right)^{-1}}$$

where

$$E_{b1} = \sigma T_1^4 = (5.67 \times 10^{-8} \text{ W/m}^2 \cdot \text{K}^4) (950 \text{ K})^4 = 46,183 \text{ W/m}^2$$

$$E_{b2} = \sigma T_2^4 = (5.67 \times 10^{-8} \text{ W/m}^2 \cdot \text{K}^4) (5 + 273 \text{ K})^4 = 339 \text{ W/m}^2$$

and

$$A_1 = A_2 = \frac{\pi (0.3 \text{ m})^2}{4} = 0.07069 \text{ m}^2$$

$$R_{12} = \frac{1}{A_1 F_{12}} = \frac{1}{(0.07069 \text{ m}^2) (0.2864)} = 49.39 \text{ m}^{-2}$$

$$R_{13} = R_{23} = \frac{1}{A_1 F_{13}} = \frac{1}{(0.07069 \text{ m}^2) (1 - 0.2864)} = 19.82 \text{ m}^{-2}$$

Substituting,

$$\dot{Q}_{12} = \frac{(46,183 - 339) \text{ W/m}^2}{\left(\frac{1}{49.39 \text{ m}^{-2}} + \frac{1}{2(19.82 \text{ m}^{-2})} \right)^{-1}} = \mathbf{2085 \text{ W}}$$

13-44E A room is heated by electric resistance heaters placed on the ceiling which is maintained at a uniform temperature. The rate of heat loss from the room through the floor is to be determined.

Assumptions 1 Steady operating conditions exist 2 The surfaces are opaque, diffuse, and gray. 3 Convection heat transfer is not considered. 4 There is no heat loss through the side surfaces.

Properties The emissivities are $\varepsilon = 1$ for the ceiling and $\varepsilon = 0.8$ for the floor. The emissivity of insulated (or reradiating) surfaces is also 1.

Analysis The room can be considered to be three-surface enclosure with the ceiling surface 1, the floor surface 2 and the side surfaces surface 3. We assume steady-state conditions exist. Since the side surfaces are reradiating, there is no heat transfer through them, and the entire heat lost by the ceiling must be gained by the floor. Then the rate of heat loss from the room through its floor can be determined from

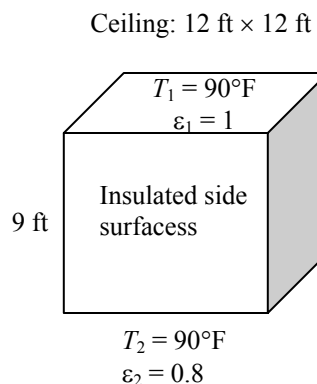

$$\dot{Q}_1 = \frac{E_{b1} - E_{b2}}{\left(\frac{1}{R_{12}} + \frac{1}{R_{13} + R_{23}} \right)^{-1} + R_2}$$

where

$$E_{b1} = \sigma T_1^4 = (0.1714 \times 10^{-8} \text{ Btu/h} \cdot \text{ft}^2 \cdot \text{R}^4)(90 + 460 \text{ R})^4 = 157 \text{ Btu/h} \cdot \text{ft}^2$$

$$E_{b2} = \sigma T_2^4 = (0.1714 \times 10^{-8} \text{ Btu/h} \cdot \text{ft}^2 \cdot \text{R}^4)(65 + 460 \text{ R})^4 = 130 \text{ Btu/h} \cdot \text{ft}^2$$

and

$$A_1 = A_2 = (12 \text{ ft})^2 = 144 \text{ ft}^2$$

The view factor from the floor to the ceiling of the room is $F_{12} = 0.27$ (From Figure 13-5). The view factor from the ceiling or the floor to the side surfaces is determined by applying the summation rule to be

$$F_{11} + F_{12} + F_{13} = 1 \longrightarrow F_{13} = 1 - F_{12} = 1 - 0.27 = 0.73$$

since the ceiling is flat and thus $F_{11} = 0$. Then the radiation resistances which appear in the equation above become

$$R_2 = \frac{1 - \varepsilon_2}{A_2 \varepsilon_2} = \frac{1 - 0.8}{(144 \text{ ft}^2)(0.8)} = 0.00174 \text{ ft}^{-2}$$

$$R_{12} = \frac{1}{A_1 F_{12}} = \frac{1}{(144 \text{ ft}^2)(0.27)} = 0.02572 \text{ ft}^{-2}$$

$$R_{13} = R_{23} = \frac{1}{A_1 F_{13}} = \frac{1}{(144 \text{ ft}^2)(0.73)} = 0.009513 \text{ ft}^{-2}$$

Substituting,

$$\dot{Q}_{12} = \frac{(157 - 130) \text{ Btu/h} \cdot \text{ft}^2}{\left(\frac{1}{0.02572 \text{ ft}^{-2}} + \frac{1}{2(0.009513 \text{ ft}^{-2})} \right)^{-1} + 0.00174 \text{ ft}^{-2}} = \mathbf{2130 \text{ Btu/h}}$$

13-45 Two perpendicular rectangular surfaces with a common edge are maintained at specified temperatures. The net rate of radiation heat transfers between the two surfaces and between the horizontal surface and the surroundings are to be determined.

Assumptions 1 Steady operating conditions exist **2** The surfaces are opaque, diffuse, and gray. **3** Convection heat transfer is not considered.

Properties The emissivities of the horizontal rectangle and the surroundings are $\varepsilon = 0.75$ and $\varepsilon = 0.85$, respectively.

Analysis We consider the horizontal rectangle to be surface 1, the vertical rectangle to be surface 2 and the surroundings to be surface 3. This system can be considered to be a three-surface enclosure. The view factor from surface 1 to surface 2 is determined from

$$\left. \begin{aligned} \frac{L_1}{W} = \frac{0.8}{1.6} = 0.5 \\ \frac{L_2}{W} = \frac{1.2}{1.6} = 0.75 \end{aligned} \right\} F_{12} = 0.27 \text{ (Fig. 13-6)}$$

The surface areas are

$$\begin{aligned} A_1 &= (0.8 \text{ m})(1.6 \text{ m}) = 1.28 \text{ m}^2 \\ A_2 &= (1.2 \text{ m})(1.6 \text{ m}) = 1.92 \text{ m}^2 \\ A_3 &= 2 \times \frac{1.2 \times 0.8}{2} + \sqrt{0.8^2 + 1.2^2} \times 1.6 = 3.268 \text{ m}^2 \end{aligned}$$

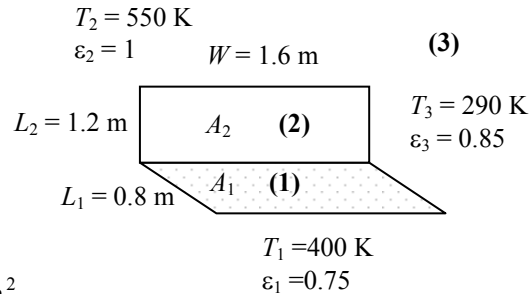

Note that the surface area of the surroundings is determined assuming that surroundings forms flat surfaces at all openings to form an enclosure. Then other view factors are determined to be

$$A_1 F_{12} = A_2 F_{21} \longrightarrow (1.28)(0.27) = (1.92)F_{21} \longrightarrow F_{21} = 0.18 \quad (\text{reciprocity rule})$$

$$F_{11} + F_{12} + F_{13} = 1 \longrightarrow 0 + 0.27 + F_{13} = 1 \longrightarrow F_{13} = 0.73 \quad (\text{summation rule})$$

$$F_{21} + F_{22} + F_{23} = 1 \longrightarrow 0.18 + 0 + F_{23} = 1 \longrightarrow F_{23} = 0.82 \quad (\text{summation rule})$$

$$A_1 F_{13} = A_3 F_{31} \longrightarrow (1.28)(0.73) = (3.268)F_{31} \longrightarrow F_{31} = 0.29 \quad (\text{reciprocity rule})$$

$$A_2 F_{23} = A_3 F_{32} \longrightarrow (1.92)(0.82) = (3.268)F_{32} \longrightarrow F_{32} = 0.48 \quad (\text{reciprocity rule})$$

We now apply Eq. 13-35b to each surface to determine the radiosities.

$$\begin{aligned} \text{Surface 1:} \quad \sigma T_1^4 &= J_1 + \frac{1 - \varepsilon_1}{\varepsilon_1} [F_{12}(J_1 - J_2) + F_{13}(J_1 - J_3)] \\ (5.67 \times 10^{-8} \text{ W/m}^2 \cdot \text{K}^4)(400 \text{ K})^4 &= J_1 + \frac{1 - 0.75}{0.75} [0.27(J_1 - J_2) + 0.73(J_1 - J_3)] \end{aligned}$$

$$\begin{aligned} \text{Surface 2:} \quad \sigma T_2^4 &= J_2 \longrightarrow (5.67 \times 10^{-8} \text{ W/m}^2 \cdot \text{K}^4)(550 \text{ K})^4 = J_2 \\ \sigma T_3^4 &= J_3 + \frac{1 - \varepsilon_3}{\varepsilon_3} [F_{31}(J_3 - J_1) + F_{32}(J_3 - J_2)] \end{aligned}$$

$$\text{Surface 3:} \quad (5.67 \times 10^{-8} \text{ W/m}^2 \cdot \text{K}^4)(290 \text{ K})^4 = J_3 + \frac{1 - 0.85}{0.85} [0.29(J_3 - J_1) + 0.48(J_3 - J_2)]$$

Solving the above equations, we find

$$J_1 = 1587 \text{ W/m}^2, \quad J_2 = 5188 \text{ W/m}^2, \quad J_3 = 811.5 \text{ W/m}^2$$

Then the net rate of radiation heat transfers between the two surfaces and between the horizontal surface and the surroundings are determined to be

$$\dot{Q}_{21} = -\dot{Q}_{12} = -A_1 F_{12} (J_1 - J_2) = -(1.28 \text{ m}^2)(0.27)(1587 - 5188) \text{ W/m}^2 = \mathbf{1245 \text{ W}}$$

$$\dot{Q}_{13} = A_1 F_{13} (J_1 - J_3) = (1.28 \text{ m}^2)(0.73)(1587 - 811.5) \text{ W/m}^2 = \mathbf{725 \text{ W}}$$

13-46 Two long parallel cylinders are maintained at specified temperatures. The rates of radiation heat transfer between the cylinders and between the hot cylinder and the surroundings are to be determined.

Assumptions 1 Steady operating conditions exist 2 The surfaces are black. 3 Convection heat transfer is not considered.

Analysis We consider the hot cylinder to be surface 1, cold cylinder to be surface 2, and the surroundings to be surface 3. Using the crossed-strings method, the view factor between two cylinders facing each other is determined to be

$$F_{1-2} = \frac{\sum \text{Crossed strings} - \sum \text{Uncrossed strings}}{2 \times \text{String on surface 1}}$$

$$= \frac{2\sqrt{s^2 + D^2} - 2s}{2(\pi D / 2)}$$

or

$$F_{1-2} = \frac{2\left(\sqrt{s^2 + D^2} - s\right)}{\pi D}$$

$$= \frac{2\left(\sqrt{0.3^2 + 0.20^2} - 0.5\right)}{\pi(0.20)}$$

$$= 0.444$$

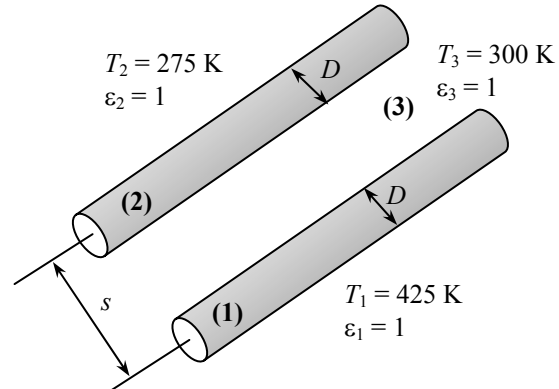

The view factor between the hot cylinder and the surroundings is

$$F_{13} = 1 - F_{12} = 1 - 0.444 = 0.556 \text{ (summation rule)}$$

The rate of radiation heat transfer between the cylinders per meter length is

$$A = \pi DL / 2 = \pi(0.20 \text{ m})(1 \text{ m}) / 2 = 0.3142 \text{ m}^2$$

$$\dot{Q}_{12} = AF_{12}\sigma(T_1^4 - T_2^4)$$

$$= (0.3142 \text{ m}^2)(0.444)(5.67 \times 10^{-8} \text{ W/m}^2 \cdot \text{°C})(425^4 - 275^4) \text{ K}^4$$

$$= \mathbf{212.8 \text{ W}}$$

Note that half of the surface area of the cylinder is used, which is the only area that faces the other cylinder. The rate of radiation heat transfer between the hot cylinder and the surroundings per meter length of the cylinder is

$$A_1 = \pi DL = \pi(0.20 \text{ m})(1 \text{ m}) = 0.6283 \text{ m}^2$$

$$\dot{Q}_{13} = A_1 F_{13} \sigma (T_1^4 - T_3^4)$$

$$= (0.6283 \text{ m}^2)(0.556)(5.67 \times 10^{-8} \text{ W/m}^2 \cdot \text{°C})(425^4 - 300^4) \text{ K}^4$$

$$= \mathbf{485.8 \text{ W}}$$

13-47 A long semi-cylindrical duct with specified temperature on the side surface is considered. The temperature of the base surface for a specified heat transfer rate is to be determined.

Assumptions 1 Steady operating conditions exist 2 The surfaces are opaque, diffuse, and gray. 3 Convection heat transfer is not considered.

Properties The emissivity of the side surface is $\varepsilon = 0.4$.

Analysis We consider the base surface to be surface 1, the side surface to be surface 2. This system is a two-surface enclosure, and we consider a unit length of the duct. The surface areas and the view factor are determined as

$$A_1 = (1.0 \text{ m})(1.0 \text{ m}) = 1.0 \text{ m}^2$$

$$A_2 = \pi DL / 2 = \pi(1.0 \text{ m})(1 \text{ m}) / 2 = 1.571 \text{ m}^2$$

$$F_{11} + F_{12} = 1 \longrightarrow 0 + F_{12} = 1 \longrightarrow F_{12} = 1 \quad (\text{summation rule})$$

The temperature of the base surface is determined from

$$\dot{Q}_{12} = \frac{\sigma(T_1^4 - T_2^4)}{\frac{1}{A_1 F_{12}} + \frac{1 - \varepsilon_2}{A_2 \varepsilon_2}}$$

$$1200 \text{ W} = \frac{(5.67 \times 10^{-8} \text{ W/m}^2 \cdot \text{K}^4)[T_1^4 - (650 \text{ K})^4]}{\frac{1}{(1.0 \text{ m}^2)(1)} + \frac{1 - 0.4}{(1.571 \text{ m}^2)(0.4)}}$$

$$T_1 = \mathbf{684.8 \text{ K}}$$

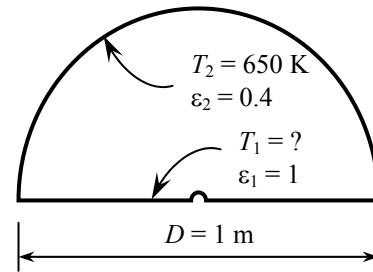

13-48 A hemisphere with specified base and dome temperatures and heat transfer rate is considered. The emissivity of the dome is to be determined.

Assumptions 1 Steady operating conditions exist 2 The surfaces are opaque, diffuse, and gray. 3 Convection heat transfer is not considered.

Properties The emissivity of the base surface is $\varepsilon = 0.55$.

Analysis We consider the base surface to be surface 1, the dome surface to be surface 2. This system is a two-surface enclosure. The surface areas and the view factor are determined as

$$A_1 = \pi D^2 / 4 = \pi(0.2 \text{ m})^2 / 4 = 0.0314 \text{ m}^2$$

$$A_2 = \pi D^2 / 2 = \pi(0.2 \text{ m})^2 / 2 = 0.0628 \text{ m}^2$$

$$F_{11} + F_{12} = 1 \longrightarrow 0 + F_{12} = 1 \longrightarrow F_{12} = 1 \quad (\text{summation rule})$$

The emissivity of the dome is determined from

$$\dot{Q}_{21} = -\dot{Q}_{12} = -\frac{\sigma(T_1^4 - T_2^4)}{\frac{1 - \varepsilon_1}{A_1 \varepsilon_1} + \frac{1}{A_1 F_{12}} + \frac{1 - \varepsilon_2}{A_2 \varepsilon_2}}$$

$$50 \text{ W} = -\frac{(5.67 \times 10^{-8} \text{ W/m}^2 \cdot \text{K}^4)[(400 \text{ K})^4 - (600 \text{ K})^4]}{\frac{1 - 0.55}{(0.0314 \text{ m}^2)(0.55)} + \frac{1}{(0.0314 \text{ m}^2)(1)} + \frac{1 - \varepsilon_2}{(0.0628 \text{ m}^2)\varepsilon_2}} \longrightarrow \varepsilon_2 = \mathbf{0.21}$$

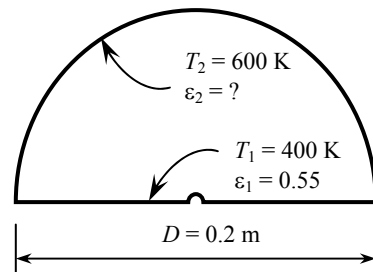

Radiation Shields and the Radiation Effect

13-49C Radiation heat transfer between two surfaces can be reduced greatly by inserting a thin, high reflectivity (low emissivity) sheet of material between the two surfaces. Such highly reflective thin plates or shells are known as radiation shields. Multilayer radiation shields constructed of about 20 shields per cm. thickness separated by evacuated space are commonly used in cryogenic and space applications to minimize heat transfer. Radiation shields are also used in temperature measurements of fluids to reduce the error caused by the radiation effect.

13-50C The influence of radiation on heat transfer or temperature of a surface is called the radiation effect. The radiation exchange between the sensor and the surroundings may cause the thermometer to indicate a different reading for the medium temperature. To minimize the radiation effect, the sensor should be coated with a material of high reflectivity (low emissivity).

13-51C A person who feels fine in a room at a specified temperature may feel chilly in another room at the same temperature as a result of radiation effect if the walls of second room are at a considerably lower temperature. For example most people feel comfortable in a room at 22°C if the walls of the room are also roughly at that temperature. When the wall temperature drops to 5°C for some reason, the interior temperature of the room must be raised to at least 27°C to maintain the same level of comfort. Also, people sitting near the windows of a room in winter will feel colder because of the radiation exchange between the person and the cold windows.

13-52 The rate of heat loss from a person by radiation in a large room whose walls are maintained at a uniform temperature is to be determined for two cases.

Assumptions 1 Steady operating conditions exist 2 The surfaces are opaque, diffuse, and gray. 3 Convection heat transfer is not considered.

Properties The emissivity of the person is given to be $\varepsilon_1 = 0.85$.

Analysis (a) Noting that the view factor from the person to the walls $F_{12} = 1$, the rate of heat loss from that person to the walls at a large room which are at a temperature of 300 K is

$$\begin{aligned}\dot{Q}_{12} &= \varepsilon_1 F_{12} A_1 \sigma (T_1^4 - T_2^4) \\ &= (0.85)(1)(1.9 \text{ m}^2)(5.67 \times 10^{-8} \text{ W/m}^2 \cdot \text{K}^4)[(303 \text{ K})^4 - (300 \text{ K})^4] \\ &= \mathbf{30.1 \text{ W}}\end{aligned}$$

(b) When the walls are at a temperature of 280 K,

$$\begin{aligned}\dot{Q}_{12} &= \varepsilon_1 F_{12} A_1 \sigma (T_1^4 - T_2^4) \\ &= (0.85)(1)(1.9 \text{ m}^2)(5.67 \times 10^{-8} \text{ W/m}^2 \cdot \text{K}^4)[(303 \text{ K})^4 - (280 \text{ K})^4] \\ &= \mathbf{209 \text{ W}}\end{aligned}$$

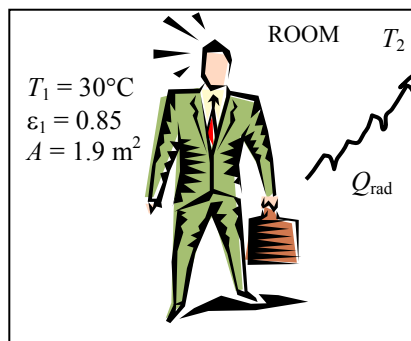

13-53 A thin aluminum sheet is placed between two very large parallel plates that are maintained at uniform temperatures. The net rate of radiation heat transfer between the two plates is to be determined for the cases of with and without the shield.

Assumptions 1 Steady operating conditions exist 2 The surfaces are opaque, diffuse, and gray. 3 Convection heat transfer is not considered.

Properties The emissivities of surfaces are given to be $\varepsilon_1 = 0.5$, $\varepsilon_2 = 0.8$, and $\varepsilon_3 = 0.15$.

Analysis The net rate of radiation heat transfer with a thin aluminum shield per unit area of the plates is

$$\begin{aligned}\dot{Q}_{12, \text{one shield}} &= \frac{\sigma(T_1^4 - T_2^4)}{\left(\frac{1}{\varepsilon_1} + \frac{1}{\varepsilon_2} - 1\right) + \left(\frac{1}{\varepsilon_{3,1}} + \frac{1}{\varepsilon_{3,2}} - 1\right)} \\ &= \frac{(5.67 \times 10^{-8} \text{ W/m}^2 \cdot \text{K}^4)[(900 \text{ K})^4 - (650 \text{ K})^4]}{\left(\frac{1}{0.5} + \frac{1}{0.8} - 1\right) + \left(\frac{1}{0.15} + \frac{1}{0.15} - 1\right)} \\ &= \mathbf{1857 \text{ W/m}^2}\end{aligned}$$

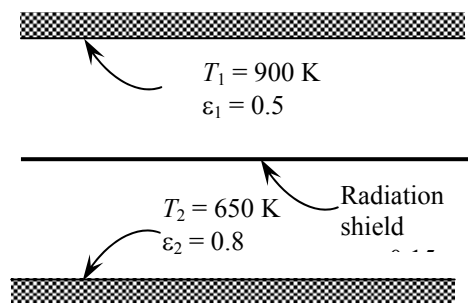

The net rate of radiation heat transfer between the plates in the case of no shield is

$$\dot{Q}_{12, \text{no shield}} = \frac{\sigma(T_1^4 - T_2^4)}{\left(\frac{1}{\varepsilon_1} + \frac{1}{\varepsilon_2} - 1\right)} = \frac{(5.67 \times 10^{-8} \text{ W/m}^2 \cdot \text{K}^4)[(900 \text{ K})^4 - (650 \text{ K})^4]}{\left(\frac{1}{0.5} + \frac{1}{0.8} - 1\right)} = 12,035 \text{ W/m}^2$$

Then the ratio of radiation heat transfer for the two cases becomes

$$\frac{\dot{Q}_{12, \text{one shield}}}{\dot{Q}_{12, \text{no shield}}} = \frac{1857 \text{ W}}{12,035 \text{ W}} \cong \frac{\mathbf{1}}{\mathbf{6}}$$

13-54 EES Prob. 13-53 is reconsidered. The net rate of radiation heat transfer between the two plates as a function of the emissivity of the aluminum sheet is to be plotted.

Analysis The problem is solved using EES, and the solution is given below.

"GIVEN"

epsilon_3=0.15

T_1=900 [K]

T_2=650 [K]

epsilon_1=0.5

epsilon_2=0.8

"ANALYSIS"

sigma=5.67E-8 [W/m^2-K^4]

$Q_{\dot{12},1\text{shield}} = (\sigma(T_1^4 - T_2^4)) / ((1/\epsilon_1 + 1/\epsilon_2 - 1) + (1/\epsilon_3 + 1/\epsilon_3 - 1))$

ϵ_3	$Q_{12,1\text{ shield}}$ [W/m ²]
0.05	656.5
0.06	783
0.07	908.1
0.08	1032
0.09	1154
0.1	1274
0.11	1394
0.12	1511
0.13	1628
0.14	1743
0.15	1857
0.16	1969
0.17	2081
0.18	2191
0.19	2299
0.2	2407
0.21	2513
0.22	2619
0.23	2723
0.24	2826
0.25	2928

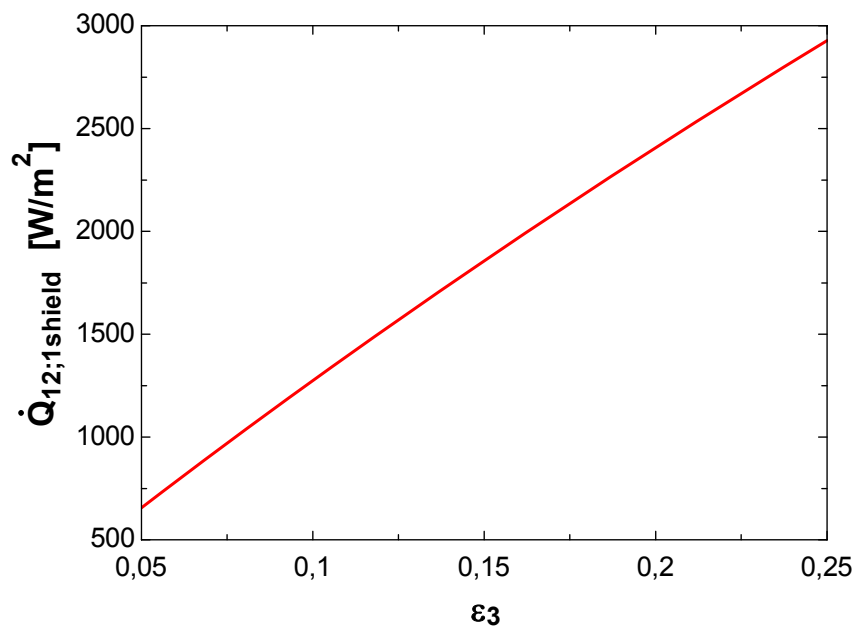

13-55 Two very large plates are maintained at uniform temperatures. The number of thin aluminum sheets that will reduce the net rate of radiation heat transfer between the two plates to one-fifth is to be determined.

Assumptions 1 Steady operating conditions exist 2 The surfaces are opaque, diffuse, and gray. 3 Convection heat transfer is not considered.

Properties The emissivities of surfaces are given to be $\varepsilon_1 = 0.5$, $\varepsilon_2 = 0.5$, and $\varepsilon_3 = 0.1$.

Analysis The net rate of radiation heat transfer between the plates in the case of no shield is

$$\begin{aligned}\dot{Q}_{12, \text{no shield}} &= \frac{\sigma(T_1^4 - T_2^4)}{\left(\frac{1}{\varepsilon_1} + \frac{1}{\varepsilon_2} - 1\right)} \\ &= \frac{(5.67 \times 10^{-8} \text{ W/m}^2 \cdot \text{K}^4)[(1000 \text{ K})^4 - (800 \text{ K})^4]}{\left(\frac{1}{0.5} + \frac{1}{0.5} - 1\right)} \\ &= 11,160 \text{ W/m}^2\end{aligned}$$

The number of sheets that need to be inserted in order to reduce the net rate of heat transfer between the two plates to one-fifth can be determined from

$$\begin{aligned}\dot{Q}_{12, \text{shields}} &= \frac{\sigma(T_1^4 - T_2^4)}{\left(\frac{1}{\varepsilon_1} + \frac{1}{\varepsilon_2} - 1\right) + N_{\text{shield}} \left(\frac{1}{\varepsilon_{3,1}} + \frac{1}{\varepsilon_{3,2}} - 1\right)} \\ \frac{1}{5}(11,160 \text{ W/m}^2) &= \frac{(5.67 \times 10^{-8} \text{ W/m}^2 \cdot \text{K}^4)[(1000 \text{ K})^4 - (800 \text{ K})^4]}{\left(\frac{1}{0.5} + \frac{1}{0.5} - 1\right) + N_{\text{shield}} \left(\frac{1}{0.1} + \frac{1}{0.1} - 1\right)} \\ N_{\text{shield}} &= 0.63 \cong 1\end{aligned}$$

That is, only one sheet is more than enough to reduce heat transfer to one-fifth.

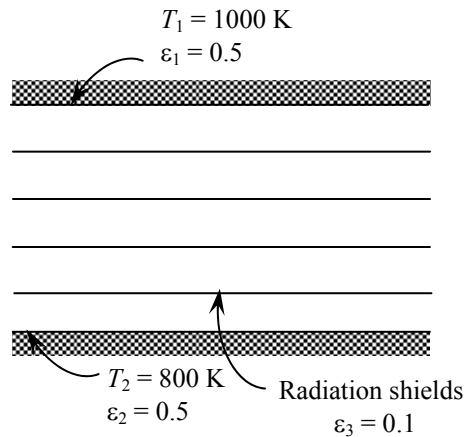

13-56 Five identical thin aluminum sheets are placed between two very large parallel plates which are maintained at uniform temperatures. The net rate of radiation heat transfer between the two plates is to be determined and compared with that without the shield.

Assumptions 1 Steady operating conditions exist 2 The surfaces are opaque, diffuse, and gray. 3 Convection heat transfer is not considered.

Properties The emissivities of surfaces are given to be $\varepsilon_1 = \varepsilon_2 = 0.1$ and $\varepsilon_3 = 0.1$.

Analysis Since the plates and the sheets have the same emissivity value, the net rate of radiation heat transfer with 5 thin aluminum shield can be determined from

$$\begin{aligned}\dot{Q}_{12,5 \text{ shield}} &= \frac{1}{N+1} \dot{Q}_{12, \text{ no shield}} = \frac{1}{N+1} \frac{\sigma(T_1^4 - T_2^4)}{\left(\frac{1}{\varepsilon_1} + \frac{1}{\varepsilon_2} - 1\right)} \\ &= \frac{1}{5+1} \frac{(5.67 \times 10^{-8} \text{ W/m}^2 \cdot \text{K}^4)[(800 \text{ K})^4 - (450 \text{ K})^4]}{\left(\frac{1}{0.1} + \frac{1}{0.1} - 1\right)} = \mathbf{183 \text{ W/m}^2}\end{aligned}$$

The net rate of radiation heat transfer without the shield is

$$\dot{Q}_{12,5 \text{ shield}} = \frac{1}{N+1} \dot{Q}_{12, \text{ no shield}} \longrightarrow \dot{Q}_{12, \text{ no shield}} = (N+1)\dot{Q}_{12,5 \text{ shield}} = 6 \times 183 \text{ W} = \mathbf{1098 \text{ W}}$$

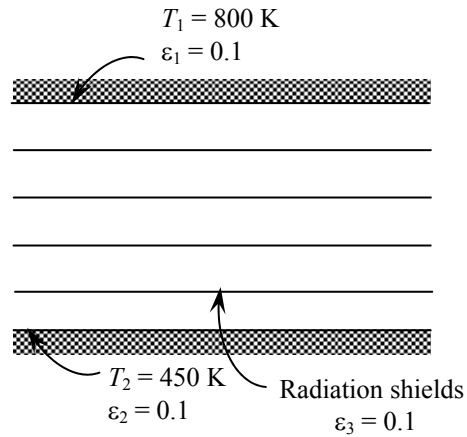

13-57 EES Prob. 13-56 is reconsidered. The effects of the number of the aluminum sheets and the emissivities of the plates on the net rate of radiation heat transfer between the two plates are to be investigated.

Analysis The problem is solved using EES, and the solution is given below.

"GIVEN"

N=5

epsilon_3=0.1

epsilon_1=0.1

epsilon_2=epsilon_1

T_1=800 [K]

T_2=450 [K]

"ANALYSIS"

sigma=5.67E-8 [W/m^2-K^4] "Stefan-Boltzmann constant"

Q_dot_12_shields=1/(N+1)*Q_dot_12_NoShield

Q_dot_12_NoShield=(sigma*(T_1^4-T_2^4))/(1/epsilon_1+1/epsilon_2-1)

N	Q _{12,shields} [W/m ²]
1	550
2	366.7
3	275
4	220
5	183.3
6	157.1
7	137.5
8	122.2
9	110
10	100

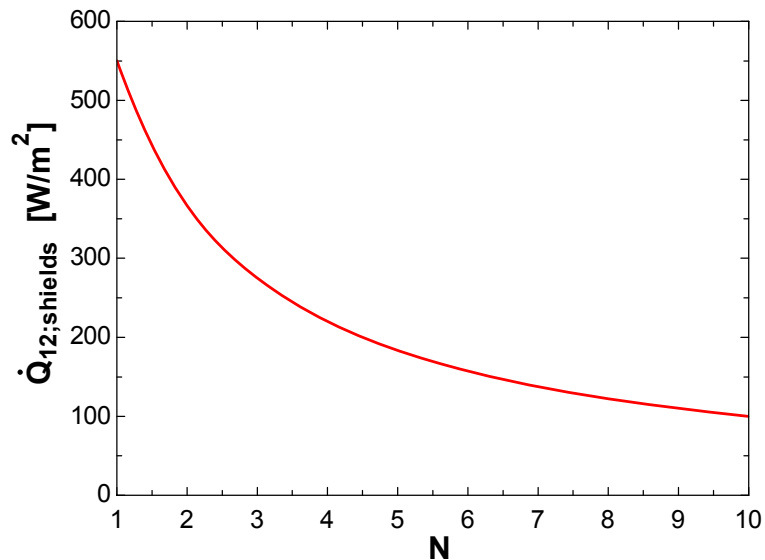

ε ₁	Q _{12,shields} [W/m ²]
0.1	183.3
0.15	282.4
0.2	387
0.25	497.6
0.3	614.7
0.35	738.9
0.4	870.8
0.45	1011
0.5	1161
0.55	1321
0.6	1493
0.65	1677
0.7	1876
0.75	2090
0.8	2322
0.85	2575
0.9	2850

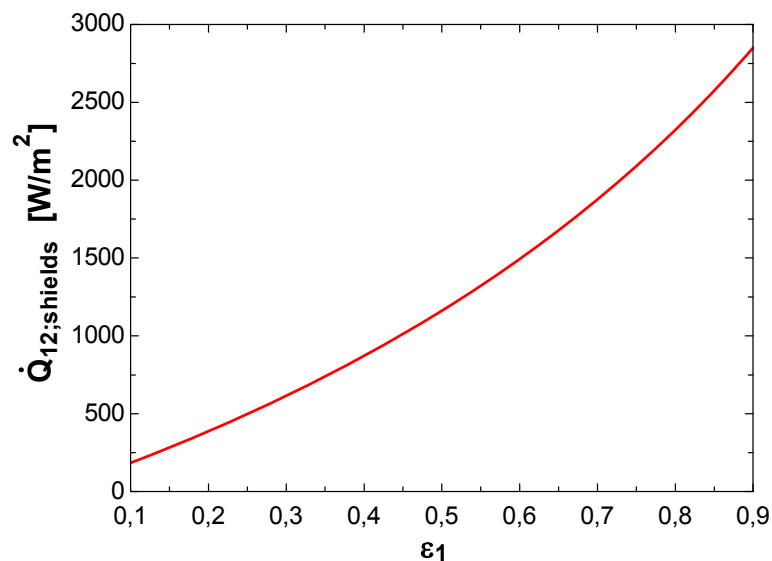

13-58E A radiation shield is placed between two parallel disks which are maintained at uniform temperatures. The net rate of radiation heat transfer through the shields is to be determined.

Assumptions 1 Steady operating conditions exist **2** The surfaces are black. **3** Convection heat transfer is not considered.

Properties The emissivities of surfaces are given to be $\varepsilon_1 = \varepsilon_2 = 1$ and $\varepsilon_3 = 0.15$.

Analysis From Fig. 13-7 we have $F_{32} = F_{13} = 0.52$. Then $F_{34} = 1 - 0.52 = 0.48$. The disk in the middle is surrounded by black surfaces on both sides. Therefore, heat transfer between the top surface of the middle disk and its black surroundings can be expressed as

$$\begin{aligned}\dot{Q}_3 &= \varepsilon A_3 \sigma [F_{31}(T_3^4 - T_1^4)] + \varepsilon A_3 \sigma [F_{32}(T_3^4 - T_2^4)] \\ &= 0.15(7.069 \text{ ft}^2)(0.1714 \times 10^{-8} \text{ Btu/h}\cdot\text{ft}^2 \cdot \text{R}^4) \{0.52[(T_3^4 - (1200 \text{ R})^4)] + 0.48[T_3^4 - (540 \text{ R})^4]\}\end{aligned}$$

where $A_3 = \pi(3 \text{ ft})^2 / 4 = 7.069 \text{ ft}^2$. Similarly, for the bottom surface of the middle disk, we have

$$\begin{aligned}-\dot{Q}_3 &= \varepsilon A_3 \sigma [F_{32}(T_2^4 - T_3^4)] + \varepsilon A_3 \sigma [F_{34}(T_3^4 - T_4^4)] \\ &= 0.15(7.069 \text{ ft}^2)(0.1714 \times 10^{-8} \text{ Btu/h}\cdot\text{ft}^2 \cdot \text{R}^4) \{0.48[T_3^4 - (700 \text{ R})^4] + 0.52[T_3^4 - (540 \text{ R})^4]\}\end{aligned}$$

Combining the equations above, the rate of heat transfer between the disks through the radiation shield (the middle disk) is determined to be

$$\dot{Q} = \mathbf{872 \text{ Btu/h}} \quad \text{and} \quad T_3 = 894 \text{ R}$$

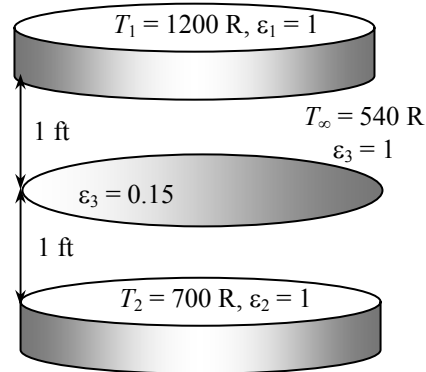

13-59 A radiation shield is placed between two large parallel plates which are maintained at uniform temperatures. The emissivity of the radiation shield is to be determined if the radiation heat transfer between the plates is reduced to 15% of that without the radiation shield.

Assumptions 1 Steady operating conditions exist **2** The surfaces are opaque, diffuse, and gray. **3** Convection heat transfer is not considered.

Properties The emissivities of surfaces are given to be $\varepsilon_1 = 0.6$ and $\varepsilon_2 = 0.9$.

Analysis First, the net rate of radiation heat transfer between the two large parallel plates per unit area without a shield is

$$\dot{Q}_{12, \text{no shield}} = \frac{\sigma(T_1^4 - T_2^4)}{\frac{1}{\varepsilon_1} + \frac{1}{\varepsilon_2} - 1} = \frac{(5.67 \times 10^{-8} \text{ W/m}^2 \cdot \text{K}^4)[(650 \text{ K})^4 - (400 \text{ K})^4]}{\frac{1}{0.6} + \frac{1}{0.9} - 1} = 4877 \text{ W/m}^2$$

The radiation heat transfer in the case of one shield is

$$\begin{aligned}\dot{Q}_{12, \text{one shield}} &= 0.15 \times \dot{Q}_{12, \text{no shield}} \\ &= 0.15 \times 4877 \text{ W/m}^2 = 731.6 \text{ W/m}^2\end{aligned}$$

Then the emissivity of the radiation shield becomes

$$\begin{aligned}\dot{Q}_{12, \text{one shield}} &= \frac{\sigma(T_1^4 - T_2^4)}{\left(\frac{1}{\varepsilon_1} + \frac{1}{\varepsilon_2} - 1\right) + \left(\frac{1}{\varepsilon_{3,1}} + \frac{1}{\varepsilon_{3,2}} - 1\right)} \\ 731.6 \text{ W/m}^2 &= \frac{(5.67 \times 10^{-8} \text{ W/m}^2 \cdot \text{K}^4)[(650 \text{ K})^4 - (400 \text{ K})^4]}{\left(\frac{1}{0.6} + \frac{1}{0.9} - 1\right) + \left(\frac{2}{\varepsilon_3} - 1\right)}\end{aligned}$$

which gives $\varepsilon_3 = \mathbf{0.18}$

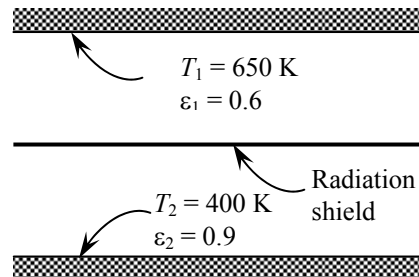

13-60 EES Prob. 13-59 is reconsidered. The effect of the percent reduction in the net rate of radiation heat transfer between the plates on the emissivity of the radiation shields is to be investigated.

Analysis The problem is solved using EES, and the solution is given below.

"GIVEN"

$$T_1=650 \text{ [K]}$$

$$T_2=400 \text{ [K]}$$

$$\epsilon_{1}=0.6$$

$$\epsilon_{2}=0.9$$

$$\text{PercentReduction}=85 \text{ ["\%"]}$$

"ANALYSIS"

$$\sigma=5.67\text{E-}8 \text{ [W/m}^2\text{-K}^4\text{]} \text{ "Stefan-Boltzmann constant"}$$

$$Q_{\text{dot}}_{12_NoShield}=(\sigma*(T_1^4-T_2^4))/(1/\epsilon_1+1/\epsilon_2-1)$$

$$Q_{\text{dot}}_{12_1shield}=(\sigma*(T_1^4-T_2^4))/((1/\epsilon_1+1/\epsilon_2-1)+(1/\epsilon_3+1/\epsilon_3-1))$$

$$Q_{\text{dot}}_{12_1shield}=(1-\text{PercentReduction}/100)*Q_{\text{dot}}_{12_NoShield}$$

Percent Reduction [%]	ϵ_3
40	0.9153
45	0.8148
50	0.72
55	0.6304
60	0.5455
65	0.4649
70	0.3885
75	0.3158
80	0.2466
85	0.1806
90	0.1176
95	0.05751

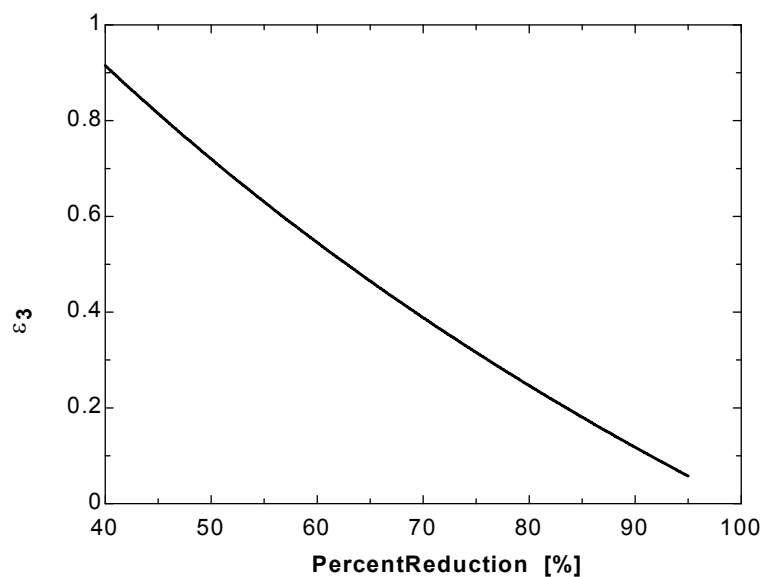

13-61 A coaxial radiation shield is placed between two coaxial cylinders which are maintained at uniform temperatures. The net rate of radiation heat transfer between the two cylinders is to be determined and compared with that without the shield.

Assumptions 1 Steady operating conditions exist 2 The surfaces are opaque, diffuse, and gray. 3 Convection heat transfer is not considered.

Properties The emissivities of surfaces are given to be $\varepsilon_1 = 0.7$, $\varepsilon_2 = 0.4$, and $\varepsilon_3 = 0.2$.

Analysis The surface areas of the cylinders and the shield per unit length are

$$A_{\text{pipe,inner}} = A_1 = \pi D_1 L = \pi(0.2 \text{ m})(1 \text{ m}) = 0.628 \text{ m}^2$$

$$A_{\text{pipe,outer}} = A_2 = \pi D_2 L = \pi(0.1 \text{ m})(1 \text{ m}) = 0.314 \text{ m}^2$$

$$A_{\text{shield}} = A_3 = \pi D_3 L = \pi(0.3 \text{ m})(1 \text{ m}) = 0.942 \text{ m}^2$$

The net rate of radiation heat transfer between the two cylinders with a shield per unit length is

$$\begin{aligned} \dot{Q}_{12,\text{one shield}} &= \frac{\sigma(T_1^4 - T_2^4)}{\frac{1-\varepsilon_1}{A_1\varepsilon_1} + \frac{1}{A_1F_{13}} + \frac{1-\varepsilon_{3,1}}{A_3\varepsilon_{3,1}} + \frac{1-\varepsilon_{3,2}}{A_3\varepsilon_{3,2}} + \frac{1}{A_3F_{3,2}} + \frac{1-\varepsilon_2}{A_2\varepsilon_2}} \\ &= \frac{(5.67 \times 10^{-8} \text{ W/m}^2 \cdot \text{K}^4)[(750 \text{ K})^4 - (500 \text{ K})^4]}{\frac{1-0.7}{(0.314)(0.7)} + \frac{1}{(0.314)(1)} + 2\frac{1-0.2}{(0.628)(0.2)} + \frac{1}{(0.628)(1)} + \frac{1-0.4}{(0.942)(0.4)}} \\ &= \mathbf{703 \text{ W}} \end{aligned}$$

If there was no shield,

$$\dot{Q}_{12,\text{no shield}} = \frac{\sigma(T_1^4 - T_2^4)}{\frac{1}{\varepsilon_1} + \frac{1-\varepsilon_2}{\varepsilon_2} \left(\frac{D_1}{D_2}\right)} = \frac{(5.67 \times 10^{-8} \text{ W/m}^2 \cdot \text{K}^4)[(750 \text{ K})^4 - (500 \text{ K})^4]}{\frac{1}{0.7} + \frac{1-0.4}{0.4} \left(\frac{0.1}{0.3}\right)} = \mathbf{7465 \text{ W}}$$

Then their ratio becomes

$$\frac{\dot{Q}_{12,\text{one shield}}}{\dot{Q}_{12,\text{no shield}}} = \frac{703 \text{ W}}{7465 \text{ W}} = \mathbf{0.094}$$

$$\begin{array}{ll} D_2 = 0.3 \text{ m} & D_1 = 0.1 \text{ m} \\ T_2 = 500 \text{ K} & T_1 = 750 \text{ K} \\ \varepsilon_2 = 0.4 & \varepsilon_1 = 0.7 \end{array}$$

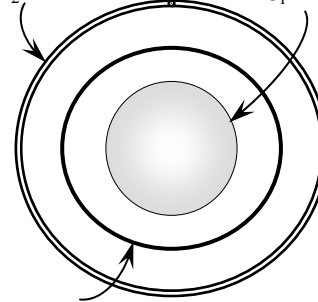

Radiation shield
 $D_3 = 0.2 \text{ m}$
 $\varepsilon_3 = 0.2$

13-62 EES Prob. 13-61 is reconsidered. The effects of the diameter of the outer cylinder and the emissivity of the radiation shield on the net rate of radiation heat transfer between the two cylinders are to be investigated.

Analysis The problem is solved using EES, and the solution is given below.

"GIVEN"

D_1=0.10 [m]; D_2=0.30 [m]
 D_3=0.20 [m]; epsilon_1=0.7
 epsilon_2=0.4; epsilon_3=0.2
 T_1=750 [K]; T_2=500 [K]

"ANALYSIS"

sigma=5.67E-8 [W/m^2-K^4] "Stefan-Boltzmann constant"

L=1 [m] "a unit length of the cylinders is considered"

A_1=pi*D_1*L

A_2=pi*D_2*L

A_3=pi*D_3*L

F_13=1

F_32=1

Q_dot_12_1shield=(sigma*(T_1^4-T_2^4))/((1-epsilon_1)/(A_1*epsilon_1)+1/(A_1*F_13)+(1-epsilon_3)/(A_3*epsilon_3)+(1-epsilon_3)/(A_3*epsilon_3)+1/(A_3*F_32)+(1-epsilon_2)/(A_2*epsilon_2))

D ₂ [m]	Q _{12,1 shield} [W]
0.25	692.8
0.275	698.6
0.3	703.5
0.325	707.8
0.35	711.4
0.375	714.7
0.4	717.5
0.425	720
0.45	722.3
0.475	724.3
0.5	726.1

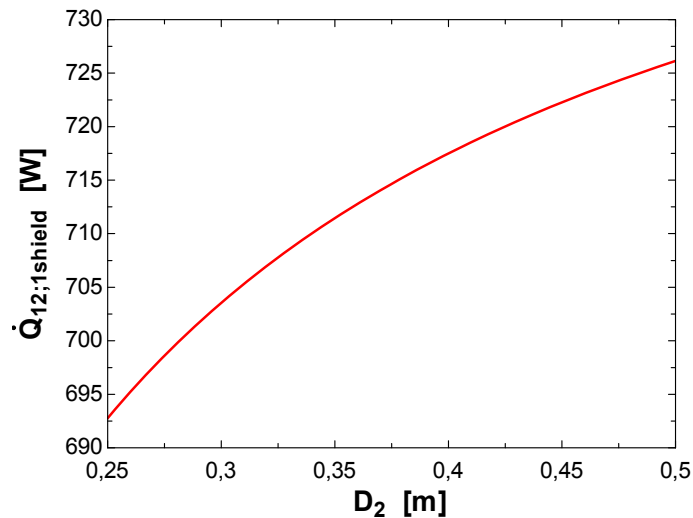

ε ₃	Q _{12,1 shield} [W]
0.05	211.1
0.07	287.8
0.09	360.7
0.11	429.9
0.13	495.9
0.15	558.7
0.17	618.6
0.19	675.9
0.21	730.6
0.23	783
0.25	833.1
0.27	881.2
0.29	927.4
0.31	971.7
0.33	1014
0.35	1055

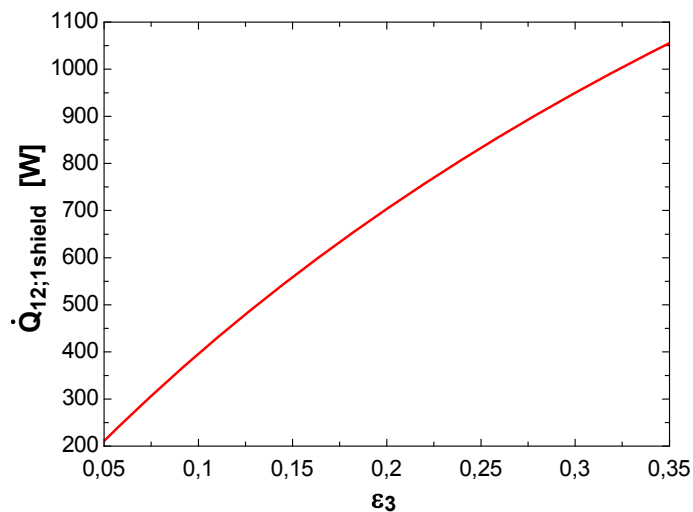

Radiation Exchange with Absorbing and Emitting Gases

13-63C A nonparticipating medium is completely transparent to thermal radiation, and thus it does not emit, absorb, or scatter radiation. A participating medium, on the other hand, emits and absorbs radiation throughout its entire volume.

13-64C Spectral transmissivity of a medium of thickness L is the ratio of the intensity of radiation leaving the medium to that entering the medium, and is expressed as $\tau_\lambda = \frac{I_{\lambda,L}}{I_{\lambda,0}} = e^{-\kappa_\lambda L}$ and $\tau_\lambda = 1 - \alpha_\lambda$.

13-65C Using Kirchhoff's law, the spectral emissivity of a medium of thickness L in terms of the spectral absorption coefficient is expressed as $\varepsilon_\lambda = \alpha_\lambda = 1 - e^{-\kappa_\lambda L}$.

13-66C Gases emit and absorb radiation at a number of narrow wavelength bands. The emissivity-wavelength charts of gases typically involve various peaks and dips together with discontinuities, and show clearly the band nature of absorption and the strong nongray characteristics. This is in contrast to solids, which emit and absorb radiation over the entire spectrum.

13-67 An equimolar mixture of CO_2 and O_2 gases at 800 K and a total pressure of 0.5 atm is considered. The emissivity of the gas is to be determined.

Assumptions All the gases in the mixture are ideal gases.

Analysis Volumetric fractions are equal to pressure fractions. Therefore, the partial pressure of CO_2 is

$$P_c = y_{\text{CO}_2} P = 0.5(0.5 \text{ atm}) = 0.25 \text{ atm}$$

Then,

$$P_c L = (0.25 \text{ atm})(1.2 \text{ m}) = 0.30 \text{ m} \cdot \text{atm} = 0.98 \text{ ft} \cdot \text{atm}$$

The emissivity of CO_2 corresponding to this value at the gas temperature of $T_g = 800 \text{ K}$ and 1 atm is, from Fig. 13-36,

$$\varepsilon_{c,1 \text{ atm}} = 0.15$$

This is the base emissivity value at 1 atm, and it needs to be corrected for the 0.5 atm total pressure. The pressure correction factor is, from Fig. 13-37,

$$C_c = 0.90$$

Then the effective emissivity of the gas becomes

$$\varepsilon_g = C_c \varepsilon_{c,1 \text{ atm}} = 0.90 \times 0.15 = \mathbf{0.135}$$

13-68 The temperature, pressure, and composition of a gas mixture is given. The emissivity of the mixture is to be determined.

Assumptions 1 All the gases in the mixture are ideal gases. **2** The emissivity determined is the mean emissivity for radiation emitted to all surfaces of the cubical enclosure.

Analysis The volumetric analysis of a gas mixture gives the mole fractions y_i of the components, which are equivalent to pressure fractions for an ideal gas mixture. Therefore, the partial pressures of CO_2 and H_2O are

$$P_c = y_{\text{CO}_2} P = 0.10(1 \text{ atm}) = 0.10 \text{ atm}$$

$$P_w = y_{\text{H}_2\text{O}} P = 0.09(1 \text{ atm}) = 0.09 \text{ atm}$$

The mean beam length for a cube of side length 6 m for radiation emitted to all surfaces is, from Table 13-4,

$$L = 0.66(6 \text{ m}) = 3.96 \text{ m}$$

Then,

$$P_c L = (0.10 \text{ atm})(3.96 \text{ m}) = 0.396 \text{ m} \cdot \text{atm} = 1.30 \text{ ft} \cdot \text{atm}$$

$$P_w L = (0.09 \text{ atm})(3.96 \text{ m}) = 0.36 \text{ m} \cdot \text{atm} = 1.18 \text{ ft} \cdot \text{atm}$$

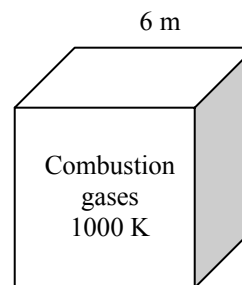

The emissivities of CO_2 and H_2O corresponding to these values at the gas temperature of $T_g = 1000 \text{ K}$ and 1 atm are, from Fig. 13-36,

$$\varepsilon_{c,1 \text{ atm}} = 0.17 \quad \text{and} \quad \varepsilon_{w,1 \text{ atm}} = 0.16$$

Both CO_2 and H_2O are present in the same mixture, and we need to correct for the overlap of emission bands. The emissivity correction factor at $T = T_g = 1000 \text{ K}$ is, from Fig. 13-38,

$$\left. \begin{aligned} P_c L + P_w L &= 1.30 + 1.18 = 2.48 \\ \frac{P_w}{P_w + P_c} &= \frac{0.09}{0.09 + 0.10} = 0.474 \end{aligned} \right\} \Delta\varepsilon = 0.038$$

Note that we obtained the average of the emissivity correction factors from the two figures for 800 K and 1200 K. Then the effective emissivity of the combustion gases becomes

$$\varepsilon_g = C_c \varepsilon_{c,1 \text{ atm}} + C_w \varepsilon_{w,1 \text{ atm}} - \Delta\varepsilon = 1 \times 0.17 + 1 \times 0.16 - 0.038 = \mathbf{0.292}$$

Note that the pressure correction factor is 1 for both gases since the total pressure is 1 atm.

13-69 A mixture of CO₂ and N₂ gases at 600 K and a total pressure of 1 atm are contained in a cylindrical container. The rate of radiation heat transfer between the gas and the container walls is to be determined.

Assumptions All the gases in the mixture are ideal gases.

Analysis The mean beam length is, from Table 13-4

$$L = 0.60D = 0.60(8 \text{ m}) = 4.8 \text{ m}$$

Then,

$$P_c L = (0.15 \text{ atm})(4.8 \text{ m}) = 0.72 \text{ m} \cdot \text{atm} = 2.36 \text{ ft} \cdot \text{atm}$$

The emissivity of CO₂ corresponding to this value at the gas temperature of $T_g = 600 \text{ K}$ and 1 atm is, from Fig. 13-36,

$$\varepsilon_{c,1\text{atm}} = 0.16$$

For a source temperature of $T_s = 450 \text{ K}$, the absorptivity of the gas is again determined using the emissivity charts as follows:

$$P_c L \frac{T_s}{T_g} = (0.15 \text{ atm})(4.8 \text{ m}) \frac{450 \text{ K}}{600 \text{ K}} = 0.54 \text{ m} \cdot \text{atm} = 1.77 \text{ ft} \cdot \text{atm}$$

The emissivity of CO₂ corresponding to this value at a temperature of $T_s = 450 \text{ K}$ and 1 atm are, from Fig. 13-36,

$$\varepsilon_{c,1\text{atm}} = 0.14$$

The absorptivity of CO₂ is determined from

$$\alpha_c = C_c \left(\frac{T_g}{T_s} \right)^{0.65} \varepsilon_{c,1\text{atm}} = (1) \left(\frac{600 \text{ K}}{450 \text{ K}} \right)^{0.65} (0.14) = 0.17$$

The surface area of the cylindrical surface is

$$A_s = \pi DH + 2 \frac{\pi D^2}{4} = \pi(8 \text{ m})(8 \text{ m}) + 2 \frac{\pi(8 \text{ m})^2}{4} = 301.6 \text{ m}^2$$

Then the net rate of radiation heat transfer from the gas mixture to the walls of the furnace becomes

$$\begin{aligned} \dot{Q}_{\text{net}} &= A_s \sigma (\varepsilon_g T_g^4 - \alpha_g T_s^4) \\ &= (301.6 \text{ m}^2) (5.67 \times 10^{-8} \text{ W/m}^2 \cdot \text{K}^4) [0.16(600 \text{ K})^4 - 0.17(450 \text{ K})^4] \\ &= \mathbf{2.35 \times 10^5 \text{ W}} \end{aligned}$$

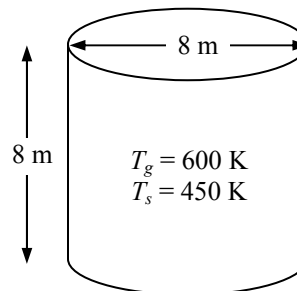

13-70 A mixture of H₂O and N₂ gases at 600 K and a total pressure of 1 atm are contained in a cylindrical container. The rate of radiation heat transfer between the gas and the container walls is to be determined.

Assumptions All the gases in the mixture are ideal gases.

Analysis The mean beam length is, from Table 13-4

$$L = 0.60D = 0.60(8 \text{ m}) = 4.8 \text{ m}$$

Then,

$$P_w L = (0.15 \text{ atm})(4.8 \text{ m}) = 0.72 \text{ m} \cdot \text{atm} = 2.36 \text{ ft} \cdot \text{atm}$$

The emissivity of H₂O corresponding to this value at the gas temperature of $T_g = 600 \text{ K}$ and 1 atm is, from Fig. 13-36,

$$\varepsilon_{w,1 \text{ atm}} = 0.36$$

For a source temperature of $T_s = 450 \text{ K}$, the absorptivity of the gas is again determined using the emissivity charts as follows:

$$P_w L \frac{T_s}{T_g} = (0.15 \text{ atm})(4.8 \text{ m}) \frac{450 \text{ K}}{600 \text{ K}} = 0.54 \text{ m} \cdot \text{atm} = 1.77 \text{ ft} \cdot \text{atm}$$

The emissivity of H₂O corresponding to this value at a temperature of $T_s = 450 \text{ K}$ and 1 atm are, from Fig. 13-36,

$$\varepsilon_{w,1 \text{ atm}} = 0.34$$

The absorptivity of H₂O is determined from

$$\alpha_w = C_w \left(\frac{T_g}{T_s} \right)^{0.65} \varepsilon_{w,1 \text{ atm}} = (1) \left(\frac{600 \text{ K}}{450 \text{ K}} \right)^{0.45} (0.34) = 0.39$$

The surface area of the cylindrical surface is

$$A_s = \pi DH + 2 \frac{\pi D^2}{4} = \pi(8 \text{ m})(8 \text{ m}) + 2 \frac{\pi(8 \text{ m})^2}{4} = 301.6 \text{ m}^2$$

Then the net rate of radiation heat transfer from the gas mixture to the walls of the furnace becomes

$$\begin{aligned} \dot{Q}_{\text{net}} &= A_s \sigma (\varepsilon_g T_g^4 - \alpha_g T_s^4) \\ &= (301.6 \text{ m}^2) (5.67 \times 10^{-8} \text{ W/m}^2 \cdot \text{K}^4) [0.36(600 \text{ K})^4 - 0.39(450 \text{ K})^4] \\ &= \mathbf{5.244 \times 10^5 \text{ W}} \end{aligned}$$

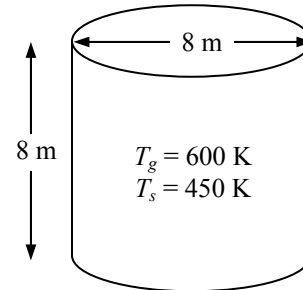

13-71 A mixture of CO₂ and N₂ gases at 1200 K and a total pressure of 1 atm are contained in a spherical furnace. The net rate of radiation heat transfer between the gas mixture and furnace walls is to be determined.

Assumptions All the gases in the mixture are ideal gases.

Analysis The mean beam length is, from Table 13-4

$$L = 0.65D = 0.65(3 \text{ m}) = 1.95 \text{ m}$$

The mole fraction is equal to pressure fraction. Then,

$$P_c L = (0.15 \text{ atm})(1.95 \text{ m}) = 0.2925 \text{ m} \cdot \text{atm} = 0.96 \text{ ft} \cdot \text{atm}$$

The emissivity of CO₂ corresponding to this value at the gas temperature of $T_g = 1200 \text{ K}$ and 1 atm is, from Fig. 13-36,

$$\varepsilon_{c,1\text{atm}} = 0.16$$

For a source temperature of $T_s = 600 \text{ K}$, the absorptivity of the gas is again determined using the emissivity charts as follows:

$$P_c L \frac{T_s}{T_g} = (0.15 \text{ atm})(1.95 \text{ m}) \frac{600 \text{ K}}{1200 \text{ K}} = 0.146 \text{ m} \cdot \text{atm} = 0.48 \text{ ft} \cdot \text{atm}$$

The emissivity of CO₂ corresponding to this value at a temperature of $T_s = 600 \text{ K}$ and 1 atm are, from Fig. 13-36,

$$\varepsilon_{c,1\text{atm}} = 0.11$$

The absorptivity of CO₂ is determined from

$$\alpha_c = C_c \left(\frac{T_g}{T_s} \right)^{0.65} \varepsilon_{c,1\text{atm}} = (1) \left(\frac{1200 \text{ K}}{600 \text{ K}} \right)^{0.65} (0.11) = 0.173$$

The surface area of the sphere is

$$A_s = \pi D^2 = \pi(3 \text{ m})^2 = 28.27 \text{ m}^2$$

Then the net rate of radiation heat transfer from the gas mixture to the walls of the furnace becomes

$$\begin{aligned} \dot{Q}_{\text{net}} &= A_s \sigma (\varepsilon_g T_g^4 - \alpha_g T_s^4) \\ &= (28.27 \text{ m}^2) (5.67 \times 10^{-8} \text{ W/m}^2 \cdot \text{K}^4) [0.16(1200 \text{ K})^4 - 0.173(600 \text{ K})^4] \\ &= \mathbf{4.959 \times 10^5 \text{ W}} \end{aligned}$$

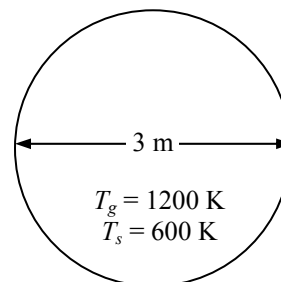

13-72 The temperature, pressure, and composition of combustion gases flowing inside long tubes are given. The rate of heat transfer from combustion gases to tube wall is to be determined.

Assumptions All the gases in the mixture are ideal gases.

Analysis The volumetric analysis of a gas mixture gives the mole fractions y_i of the components, which are equivalent to pressure fractions for an ideal gas mixture. Therefore, the partial pressures of CO_2 and H_2O are

$$P_c = y_{\text{CO}_2} P = 0.06(1 \text{ atm}) = 0.06 \text{ atm}$$

$$P_w = y_{\text{H}_2\text{O}} P = 0.09(1 \text{ atm}) = 0.09 \text{ atm}$$

The mean beam length for an infinite circular cylinder is, from Table 13-4,

$$L = 0.95(0.15 \text{ m}) = 0.1425 \text{ m}$$

Then,

$$P_c L = (0.06 \text{ atm})(0.1425 \text{ m}) = 0.00855 \text{ m} \cdot \text{atm} = 0.028 \text{ ft} \cdot \text{atm}$$

$$P_w L = (0.09 \text{ atm})(0.1425 \text{ m}) = 0.0128 \text{ m} \cdot \text{atm} = 0.042 \text{ ft} \cdot \text{atm}$$

The emissivities of CO_2 and H_2O corresponding to these values at the gas temperature of $T_g = 1500 \text{ K}$ and 1 atm are, from Fig. 13-36,

$$\varepsilon_{c,1\text{atm}} = 0.034 \quad \text{and} \quad \varepsilon_{w,1\text{atm}} = 0.016$$

Both CO_2 and H_2O are present in the same mixture, and we need to correct for the overlap of emission bands. The emissivity correction factor at $T = T_g = 1500 \text{ K}$ is, from Fig. 13-38,

$$\left. \begin{aligned} P_c L + P_w L &= 0.028 + 0.042 = 0.07 \\ \frac{P_w}{P_w + P_c} &= \frac{0.09}{0.09 + 0.06} = 0.6 \end{aligned} \right\} \Delta\varepsilon = 0.0$$

Then the effective emissivity of the combustion gases becomes

$$\varepsilon_g = C_c \varepsilon_{c,1\text{atm}} + C_w \varepsilon_{w,1\text{atm}} - \Delta\varepsilon = 1 \times 0.034 + 1 \times 0.016 - 0.0 = 0.05$$

Note that the pressure correction factor is 1 for both gases since the total pressure is 1 atm. For a source temperature of $T_s = 600 \text{ K}$, the absorptivity of the gas is again determined using the emissivity charts as follows:

$$P_c L \frac{T_s}{T_g} = (0.06 \text{ atm})(0.1425 \text{ m}) \frac{600 \text{ K}}{1500 \text{ K}} = 0.00342 \text{ m} \cdot \text{atm} = 0.011 \text{ ft} \cdot \text{atm}$$

$$P_w L \frac{T_s}{T_g} = (0.09 \text{ atm})(0.1425 \text{ m}) \frac{600 \text{ K}}{1500 \text{ K}} = 0.00513 \text{ m} \cdot \text{atm} = 0.017 \text{ ft} \cdot \text{atm}$$

The emissivities of CO_2 and H_2O corresponding to these values at a temperature of $T_s = 600 \text{ K}$ and 1 atm are, from Fig. 13-36,

$$\varepsilon_{c,1\text{atm}} = 0.031 \quad \text{and} \quad \varepsilon_{w,1\text{atm}} = 0.027$$

Then the absorptivities of CO_2 and H_2O become

$$\alpha_c = C_c \left(\frac{T_g}{T_s} \right)^{0.65} \varepsilon_{c,1\text{atm}} = (1) \left(\frac{1500 \text{ K}}{600 \text{ K}} \right)^{0.65} (0.031) = 0.056$$

$$\alpha_w = C_w \left(\frac{T_g}{T_s} \right)^{0.45} \varepsilon_{w,1\text{atm}} = (1) \left(\frac{1500 \text{ K}}{600 \text{ K}} \right)^{0.45} (0.027) = 0.041$$

Also $\Delta\alpha = \Delta\varepsilon$, but the emissivity correction factor is to be evaluated from Fig. 13-38 at $T = T_s = 600 \text{ K}$ instead of $T_g = 1500 \text{ K}$. There is no chart for 600 K in the figure, but we can read $\Delta\varepsilon$ values at 400 K and

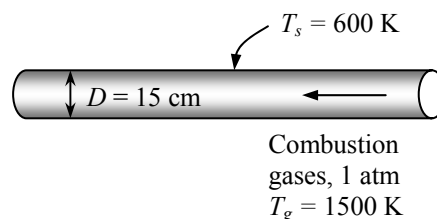

800 K, and take their average. At $P_w/(P_w + P_c) = 0.6$ and $P_cL + P_wL = 0.07$ we read $\Delta\epsilon = 0.0$. Then the absorptivity of the combustion gases becomes

$$\alpha_g = \alpha_c + \alpha_w - \Delta\alpha = 0.056 + 0.041 - 0.0 = 0.097$$

The surface area of the pipe per m length of tube is

$$A_s = \pi DL = \pi(0.15 \text{ m})(1 \text{ m}) = 0.4712 \text{ m}^2$$

Then the net rate of radiation heat transfer from the combustion gases to the walls of the furnace becomes

$$\begin{aligned} \dot{Q}_{\text{net}} &= A_s \sigma (\epsilon_g T_g^4 - \alpha_g T_s^4) \\ &= (0.4712 \text{ m}^2)(5.67 \times 10^{-8} \text{ W/m}^2 \cdot \text{K}^4)[0.05(1500 \text{ K})^4 - 0.097(600 \text{ K})^4] \\ &= \mathbf{6427 \text{ W}} \end{aligned}$$

13-73 The temperature, pressure, and composition of combustion gases flowing inside long tubes are given. The rate of heat transfer from combustion gases to tube wall is to be determined.

Assumptions All the gases in the mixture are ideal gases.

Analysis The volumetric analysis of a gas mixture gives the mole fractions y_i of the components, which are equivalent to pressure fractions for an ideal gas mixture. Therefore, the partial pressures of CO_2 and H_2O are

$$P_c = y_{\text{CO}_2} P = 0.06(1 \text{ atm}) = 0.06 \text{ atm}$$

$$P_w = y_{\text{H}_2\text{O}} P = 0.09(1 \text{ atm}) = 0.09 \text{ atm}$$

The mean beam length for an infinite circular cylinder is, from Table 13-4,

$$L = 0.95(0.15 \text{ m}) = 0.1425 \text{ m}$$

Then,

$$P_c L = (0.06 \text{ atm})(0.1425 \text{ m}) = 0.00855 \text{ m} \cdot \text{atm} = 0.028 \text{ ft} \cdot \text{atm}$$

$$P_w L = (0.09 \text{ atm})(0.1425 \text{ m}) = 0.0128 \text{ m} \cdot \text{atm} = 0.042 \text{ ft} \cdot \text{atm}$$

The emissivities of CO_2 and H_2O corresponding to these values at the gas temperature of $T_g = 1500 \text{ K}$ and 1 atm are, from Fig. 13-36,

$$\varepsilon_{c,1 \text{ atm}} = 0.034 \quad \text{and} \quad \varepsilon_{w,1 \text{ atm}} = 0.016$$

These are base emissivity values at 1 atm, and they need to be corrected for the 3 atm total pressure. Noting that $(P_w + P)/2 = (0.09 + 3)/2 = 1.545 \text{ atm}$, the pressure correction factors are, from Fig. 13-37,

$$C_c = 1.5 \quad \text{and} \quad C_w = 1.8$$

Both CO_2 and H_2O are present in the same mixture, and we need to correct for the overlap of emission bands. The emissivity correction factor at $T = T_g = 1500 \text{ K}$ is, from Fig. 13-38,

$$\left. \begin{aligned} P_c L + P_w L &= 0.028 + 0.042 = 0.07 \\ \frac{P_w}{P_w + P_c} &= \frac{0.09}{0.09 + 0.06} = 0.6 \end{aligned} \right\} \Delta \varepsilon = 0.0$$

Then the effective emissivity of the combustion gases becomes

$$\varepsilon_g = C_c \varepsilon_{c,1 \text{ atm}} + C_w \varepsilon_{w,1 \text{ atm}} - \Delta \varepsilon = 1.5 \times 0.034 + 1.8 \times 0.016 - 0.0 = 0.080$$

For a source temperature of $T_s = 600 \text{ K}$, the absorptivity of the gas is again determined using the emissivity charts as follows:

$$P_c L \frac{T_s}{T_g} = (0.06 \text{ atm})(0.1425 \text{ m}) \frac{600 \text{ K}}{1500 \text{ K}} = 0.00342 \text{ m} \cdot \text{atm} = 0.011 \text{ ft} \cdot \text{atm}$$

$$P_w L \frac{T_s}{T_g} = (0.09 \text{ atm})(0.1425 \text{ m}) \frac{600 \text{ K}}{1500 \text{ K}} = 0.00513 \text{ m} \cdot \text{atm} = 0.017 \text{ ft} \cdot \text{atm}$$

The emissivities of CO_2 and H_2O corresponding to these values at a temperature of $T_s = 600 \text{ K}$ and 1 atm are, from Fig. 13-36,

$$\varepsilon_{c,1 \text{ atm}} = 0.031 \quad \text{and} \quad \varepsilon_{w,1 \text{ atm}} = 0.027$$

Then the absorptivities of CO_2 and H_2O become

$$\alpha_c = C_c \left(\frac{T_g}{T_s} \right)^{0.65} \varepsilon_{c,1 \text{ atm}} = (1.5) \left(\frac{1500 \text{ K}}{600 \text{ K}} \right)^{0.65} (0.031) = 0.084$$

$$\alpha_w = C_w \left(\frac{T_g}{T_s} \right)^{0.45} \varepsilon_{w,1 \text{ atm}} = (1.8) \left(\frac{1500 \text{ K}}{600 \text{ K}} \right)^{0.45} (0.027) = 0.073$$

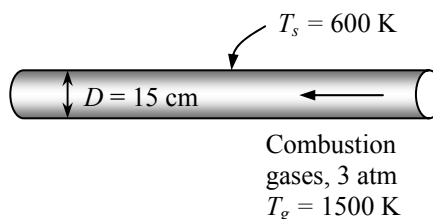

Also $\Delta\alpha = \Delta\varepsilon$, but the emissivity correction factor is to be evaluated from Fig. 13-38 at $T = T_s = 600$ K instead of $T_g = 1500$ K. There is no chart for 600 K in the figure, but we can read $\Delta\varepsilon$ values at 400 K and 800 K, and take their average. At $P_w/(P_w + P_c) = 0.6$ and $P_cL + P_wL = 0.07$ we read $\Delta\varepsilon = 0.0$. Then the absorptivity of the combustion gases becomes

$$\alpha_g = \alpha_c + \alpha_w - \Delta\alpha = 0.084 + 0.073 - 0.0 = 0.157$$

The surface area of the pipe per m length of tube is

$$A_s = \pi DL = \pi(0.15 \text{ m})(1 \text{ m}) = 0.4712 \text{ m}^2$$

Then the net rate of radiation heat transfer from the combustion gases to the walls of the furnace becomes

$$\begin{aligned} \dot{Q}_{\text{net}} &= A_s \sigma (\varepsilon_g T_g^4 - \alpha_g T_s^4) \\ &= (0.4712 \text{ m}^2)(5.67 \times 10^{-8} \text{ W/m}^2 \cdot \text{K}^4)[0.08(1500 \text{ K})^4 - 0.157(600 \text{ K})^4] \\ &= \mathbf{10,280 \text{ W}} \end{aligned}$$

13-74 The temperature, pressure, and composition of combustion gases flowing inside long tubes are given. The rate of heat transfer from combustion gases to tube wall is to be determined.

Assumptions All the gases in the mixture are ideal gases.

Analysis The mean beam length for an infinite circular cylinder is, from Table 13-4,

$$L = 0.95(0.10 \text{ m}) = 0.095 \text{ m}$$

Then,

$$P_c L = (0.12 \text{ atm})(0.095 \text{ m}) = 0.0114 \text{ m} \cdot \text{atm} = 0.037 \text{ ft} \cdot \text{atm}$$

$$P_w L = (0.18 \text{ atm})(0.095 \text{ m}) = 0.0171 \text{ m} \cdot \text{atm} = 0.056 \text{ ft} \cdot \text{atm}$$

The emissivities of CO_2 and H_2O corresponding to these values at the gas temperature of $T_g = 800 \text{ K}$ and 1 atm are, from Fig. 13-36,

$$\varepsilon_{c,1\text{atm}} = 0.055 \quad \text{and} \quad \varepsilon_{w,1\text{atm}} = 0.050$$

Both CO_2 and H_2O are present in the same mixture, and we need to correct for the overlap of emission bands. The emissivity correction factor at $T = T_g = 800 \text{ K}$ is, from Fig. 13-38,

$$\left. \begin{aligned} P_c L + P_w L &= 0.037 + 0.056 = 0.093 \\ \frac{P_w}{P_w + P_c} &= \frac{0.18}{0.18 + 0.12} = 0.6 \end{aligned} \right\} \Delta\varepsilon = 0.0$$

Then the effective emissivity of the combustion gases becomes

$$\varepsilon_g = C_c \varepsilon_{c,1\text{atm}} + C_w \varepsilon_{w,1\text{atm}} - \Delta\varepsilon = 1 \times 0.055 + 1 \times 0.050 - 0.0 = 0.105$$

Note that the pressure correction factor is 1 for both gases since the total pressure is 1 atm. For a source temperature of $T_s = 500 \text{ K}$, the absorptivity of the gas is again determined using the emissivity charts as follows:

$$P_c L \frac{T_s}{T_g} = (0.12 \text{ atm})(0.095 \text{ m}) \frac{500 \text{ K}}{800 \text{ K}} = 0.007125 \text{ m} \cdot \text{atm} = 0.023 \text{ ft} \cdot \text{atm}$$

$$P_w L \frac{T_s}{T_g} = (0.18 \text{ atm})(0.095 \text{ m}) \frac{500 \text{ K}}{800 \text{ K}} = 0.01069 \text{ m} \cdot \text{atm} = 0.035 \text{ ft} \cdot \text{atm}$$

The emissivities of CO_2 and H_2O corresponding to these values at a temperature of $T_s = 500 \text{ K}$ and 1 atm are, from Fig. 13-36,

$$\varepsilon_{c,1\text{atm}} = 0.042 \quad \text{and} \quad \varepsilon_{w,1\text{atm}} = 0.050$$

Then the absorptivities of CO_2 and H_2O become

$$\alpha_c = C_c \left(\frac{T_g}{T_s} \right)^{0.65} \varepsilon_{c,1\text{atm}} = (1) \left(\frac{800 \text{ K}}{500 \text{ K}} \right)^{0.65} (0.042) = 0.057$$

$$\alpha_w = C_w \left(\frac{T_g}{T_s} \right)^{0.45} \varepsilon_{w,1\text{atm}} = (1) \left(\frac{800 \text{ K}}{500 \text{ K}} \right)^{0.45} (0.050) = 0.062$$

Also $\Delta\alpha = \Delta\varepsilon$, but the emissivity correction factor is to be evaluated from Fig. 13-38 at $T = T_s = 500 \text{ K}$ instead of $T_g = 800 \text{ K}$. There is no chart for 500 K in the figure, but we can read $\Delta\varepsilon$ values at 400 K and 800 K, and interpolate. At $P_w/(P_w + P_c) = 0.6$ and $P_c L + P_w L = 0.093$ we read $\Delta\varepsilon = 0.0$. Then the absorptivity of the combustion gases becomes

$$\alpha_g = \alpha_c + \alpha_w - \Delta\alpha = 0.057 + 0.062 - 0.0 = 0.119$$

The surface area of the pipe is

$$A_s = \pi DL = \pi(0.10 \text{ m})(6 \text{ m}) = 1.885 \text{ m}^2$$

Then the net rate of radiation heat transfer from the combustion gases to the walls of the tube becomes

$$\begin{aligned} \dot{Q}_{\text{net}} &= A_s \sigma (\varepsilon_g T_g^4 - \alpha_g T_s^4) \\ &= (1.885 \text{ m}^2) (5.67 \times 10^{-8} \text{ W/m}^2 \cdot \text{K}^4) [0.105(800 \text{ K})^4 - 0.119(500 \text{ K})^4] \\ &= \mathbf{3802 \text{ W}} \end{aligned}$$

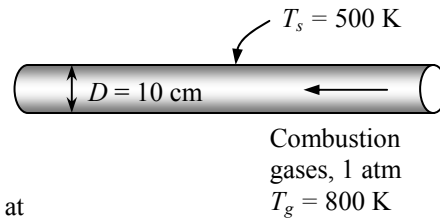

13-75 The temperature, pressure, and composition of combustion gases flowing inside long tubes are given. The rate of heat transfer from combustion gases to tube wall is to be determined.

Assumptions All the gases in the mixture are ideal gases.

Analysis The volumetric analysis of a gas mixture gives the mole fractions y_i of the components, which are equivalent to pressure fractions for an ideal gas mixture. Therefore, the partial pressures of CO_2 and H_2O are

$$P_c = y_{\text{CO}_2} P = 0.10(1 \text{ atm}) = 0.10 \text{ atm}$$

$$P_w = y_{\text{H}_2\text{O}} P = 0.10(1 \text{ atm}) = 0.10 \text{ atm}$$

The mean beam length for this geometry is, from Table 13-4,

$$L = 3.6 \mathcal{V} A_s = 1.8D = 1.8(0.20 \text{ m}) = 0.36 \text{ m}$$

where D is the distance between the plates. Then,

$$P_c L = P_w L = (0.10 \text{ atm})(0.36 \text{ m}) = 0.036 \text{ m} \cdot \text{atm} = 0.118 \text{ ft} \cdot \text{atm}$$

The emissivities of CO_2 and H_2O corresponding to these values at the gas temperature of $T_g = 1200 \text{ K}$ and 1 atm are, from Fig. 13-36,

$$\varepsilon_{c,1 \text{ atm}} = 0.080 \quad \text{and} \quad \varepsilon_{w,1 \text{ atm}} = 0.055$$

Both CO_2 and H_2O are present in the same mixture, and we need to correct for the overlap of emission bands. The emissivity correction factor at $T = T_g = 1200 \text{ K}$ is, from Fig. 13-38,

$$\left. \begin{aligned} P_c L + P_w L &= 0.118 + 0.118 = 0.236 \\ \frac{P_w}{P_w + P_c} &= \frac{0.10}{0.10 + 0.10} = 0.5 \end{aligned} \right\} \Delta \varepsilon = 0.0025$$

Then the effective emissivity of the combustion gases becomes

$$\varepsilon_g = C_c \varepsilon_{c,1 \text{ atm}} + C_w \varepsilon_{w,1 \text{ atm}} - \Delta \varepsilon = 1 \times 0.080 + 1 \times 0.055 - 0.0025 = 0.1325$$

Note that the pressure correction factor is 1 for both gases since the total pressure is 1 atm. For a source temperature of $T_s = 600 \text{ K}$, the absorptivity of the gas is again determined using the emissivity charts as follows:

$$P_c L \frac{T_s}{T_g} = P_w L \frac{T_s}{T_g} = (0.10 \text{ atm})(0.36 \text{ m}) \frac{600 \text{ K}}{1200 \text{ K}} = 0.018 \text{ m} \cdot \text{atm} = 0.059 \text{ ft} \cdot \text{atm}$$

The emissivities of CO_2 and H_2O corresponding to these values at a temperature of $T_s = 600 \text{ K}$ and 1 atm are, from Fig. 13-36,

$$\varepsilon_{c,1 \text{ atm}} = 0.060 \quad \text{and} \quad \varepsilon_{w,1 \text{ atm}} = 0.067$$

Then the absorptivities of CO_2 and H_2O become

$$\alpha_c = C_c \left(\frac{T_g}{T_s} \right)^{0.65} \quad \varepsilon_{c,1 \text{ atm}} = (1) \left(\frac{1200 \text{ K}}{600 \text{ K}} \right)^{0.65} (0.060) = 0.090$$

$$\alpha_w = C_w \left(\frac{T_g}{T_s} \right)^{0.45} \quad \varepsilon_{w,1 \text{ atm}} = (1) \left(\frac{1200 \text{ K}}{600 \text{ K}} \right)^{0.45} (0.067) = 0.092$$

Also $\Delta \alpha = \Delta \varepsilon$, but the emissivity correction factor is to be evaluated from Fig. 13-38 at $T = T_s = 600 \text{ K}$ instead of $T_g = 1200 \text{ K}$. There is no chart for 600 K in the figure, but we can read $\Delta \varepsilon$ values at 400 K and 800 K, and take their average. At $P_w/(P_w + P_c) = 0.5$ and $P_c L + P_w L = 0.236$ we read $\Delta \varepsilon = 0.00125$. Then the absorptivity of the combustion gases becomes

$$\alpha_g = \alpha_c + \alpha_w - \Delta \alpha = 0.090 + 0.092 - 0.00125 = 0.1808$$

Then the net rate of radiation heat transfer from the gas to each plate per unit surface area becomes

$$\begin{aligned} \dot{Q}_{\text{net}} &= A_s \sigma (\varepsilon_g T_g^4 - \alpha_g T_s^4) \\ &= (1 \text{ m}^2) (5.67 \times 10^{-8} \text{ W/m}^2 \cdot \text{K}^4) [0.1325(1200 \text{ K})^4 - 0.1808(600 \text{ K})^4] \\ &= \mathbf{1.42 \times 10^4 \text{ W}} \end{aligned}$$

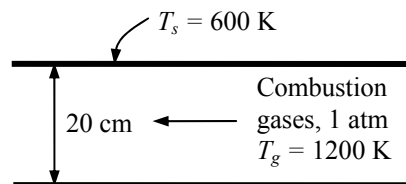

Special Topic: Heat Transfer from the Human Body

13-76C Yes, roughly one-third of the metabolic heat generated by a person who is resting or doing light work is dissipated to the environment by convection, one-third by evaporation, and the remaining one-third by radiation.

13-77C Sensible heat is the energy associated with a temperature change. The sensible heat loss from a human body increases as (a) the skin temperature increases, (b) the environment temperature decreases, and (c) the air motion (and thus the convection heat transfer coefficient) increases.

13-78C Latent heat is the energy released as water vapor condenses on cold surfaces, or the energy absorbed from a warm surface as liquid water evaporates. The latent heat loss from a human body increases as (a) the skin wettedness increases and (b) the relative humidity of the environment decreases. The rate of evaporation from the body is related to the rate of latent heat loss by $\dot{Q}_{\text{latent}} = \dot{m}_{\text{vapor}} h_{fg}$ where h_{fg} is the latent heat of vaporization of water at the skin temperature.

13-79C The insulating effect of clothing is expressed in the unit **clo** with $1 \text{ clo} = 0.155 \text{ m}^2 \cdot \text{C}/\text{W} = 0.880 \text{ ft}^2 \cdot \text{F} \cdot \text{h}/\text{Btu}$. Clothing serves as insulation, and thus reduces heat loss from the body by convection, radiation, and evaporation by serving as a resistance against heat flow and vapor flow. Clothing decreases heat gain from the sun by serving as a radiation shield.

13-80C (a) Heat is lost through the skin by convection, radiation, and evaporation. (b) The body loses both sensible heat by convection and latent heat by evaporation from the lungs, but there is no heat transfer in the lungs by radiation.

13-81C The *operative temperature* $T_{\text{operative}}$ is the average of the mean radiant and ambient temperatures weighed by their respective convection and radiation heat transfer coefficients, and is expressed as

$$T_{\text{operative}} = \frac{h_{\text{conv}} T_{\text{ambient}} + h_{\text{rad}} T_{\text{surr}}}{h_{\text{conv}} + h_{\text{rad}}} \cong \frac{T_{\text{ambient}} + T_{\text{surr}}}{2}$$

When the convection and radiation heat transfer coefficients are equal to each other, the operative temperature becomes the arithmetic average of the ambient and surrounding surface temperatures. Another environmental index used in thermal comfort analysis is the effective temperature, which combines the effects of temperature and humidity.

13-82 The convection heat transfer coefficient for a clothed person while walking in still air at a velocity of 0.5 to 2 m/s is given by $h = 8.6V^{0.53}$ where V is in m/s and h is in $\text{W/m}^2\cdot\text{C}$. The convection coefficients in that range vary from $5.96 \text{ W/m}^2\cdot\text{C}$ at 0.5 m/s to $12.42 \text{ W/m}^2\cdot\text{C}$ at 2 m/s. Therefore, at low velocities, the radiation and convection heat transfer coefficients are comparable in magnitude. But at high velocities, the convection coefficient is much larger than the radiation heat transfer coefficient.

Velocity, m/s	$h = 8.6V^{0.53}$ $\text{W/m}^2\cdot\text{C}$
0.50	5.96
0.75	7.38
1.00	8.60
1.25	9.68
1.50	10.66
1.75	11.57
2.00	12.42

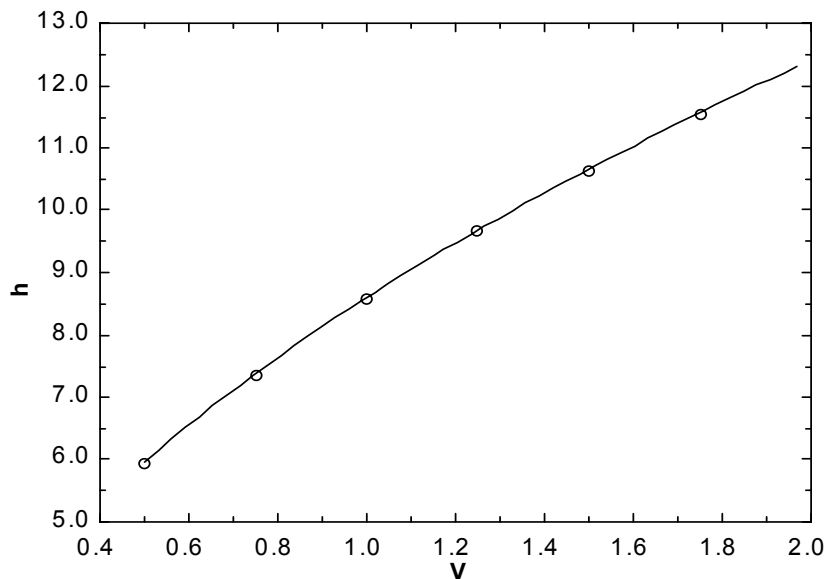

13-83 A man wearing summer clothes feels comfortable in a room at 20°C. The room temperature at which this man would feel thermally comfortable when unclothed is to be determined.

Assumptions 1 Steady conditions exist. 2 The latent heat loss from the person remains the same. 3 The heat transfer coefficients remain the same. 4 The air in the room is still (there are no winds or running fans). 5 The surface areas of the clothed and unclothed person are the same.

Analysis At low air velocities, the convection heat transfer coefficient for a standing man is given in Table 13-5 to be 4.0 W/m²·°C. The radiation heat transfer coefficient at typical indoor conditions is 4.7 W/m²·°C. Therefore, the heat transfer coefficient for a standing person for combined convection and radiation is

$$h_{\text{combined}} = h_{\text{conv}} + h_{\text{rad}} = 4.0 + 4.7 = 8.7 \text{ W/m}^2 \cdot \text{°C}$$

The thermal resistance of the clothing is given to be

$$R_{\text{cloth}} = 1.1 \text{ clo} = 1.1 \times 0.155 \text{ m}^2 \cdot \text{°C/W} = 0.171 \text{ m}^2 \cdot \text{°C/W}$$

Noting that the surface area of an average man is 1.8 m², the sensible heat loss from this person when clothed is determined to be

$$\dot{Q}_{\text{sensible, clothed}} = \frac{A_s (T_{\text{skin}} - T_{\text{ambient}})}{R_{\text{cloth}} + \frac{1}{h_{\text{combined}}}} = \frac{(1.8 \text{ m}^2)(33 - 20) \text{°C}}{0.171 \text{ m}^2 \cdot \text{°C/W} + \frac{1}{8.7 \text{ W/m}^2 \cdot \text{°C}}} = 82 \text{ W}$$

From heat transfer point of view, taking the clothes off is equivalent to removing the clothing insulation or setting $R_{\text{cloth}} = 0$. The heat transfer in this case can be expressed as

$$\dot{Q}_{\text{sensible, unclothed}} = \frac{A_s (T_{\text{skin}} - T_{\text{ambient}})}{\frac{1}{h_{\text{combined}}}} = \frac{(1.8 \text{ m}^2)(33 - T_{\text{ambient}}) \text{°C}}{\frac{1}{8.7 \text{ W/m}^2 \cdot \text{°C}}}$$

To maintain thermal comfort after taking the clothes off, the skin temperature of the person and the rate of heat transfer from him must remain the same. Then setting the equation above equal to 82 W gives

$$T_{\text{ambient}} = 27.8 \text{°C}$$

Therefore, the air temperature needs to be raised from 22 to 27.8°C to ensure that the person will feel comfortable in the room after he takes his clothes off. Note that the effect of clothing on latent heat is assumed to be negligible in the solution above. We also assumed the surface area of the clothed and unclothed person to be the same for simplicity, and these two effects should counteract each other.

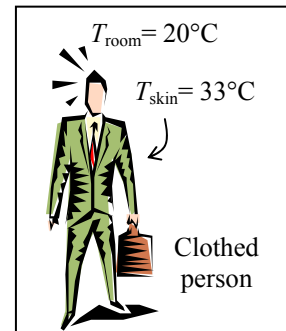

13-84E An average person produces 0.50 lbm of moisture while taking a shower. The contribution of showers of a family of four to the latent heat load of the air-conditioner per day is to be determined.

Assumptions All the water vapor from the shower is condensed by the air-conditioning system.

Properties The latent heat of vaporization of water is given to be 1050 Btu/lbm.

Analysis The amount of moisture produced per day is

$$\begin{aligned} m_{\text{vapor}} &= (\text{Moisture produced per person})(\text{No. of persons}) \\ &= (0.5 \text{ lbm/person})(4 \text{ persons/day}) = 2 \text{ lbm/day} \end{aligned}$$

Then the latent heat load due to showers becomes

$$Q_{\text{latent}} = m_{\text{vapor}} h_{\text{fg}} = (2 \text{ lbm/day})(1050 \text{ Btu/lbm}) = \mathbf{2100 \text{ Btu/day}}$$

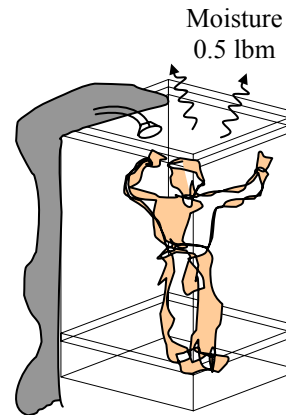

13-85 There are 100 chickens in a breeding room. The rate of total heat generation and the rate of moisture production in the room are to be determined.

Assumptions All the moisture from the chickens is condensed by the air-conditioning system.

Properties The latent heat of vaporization of water is given to be 2430 kJ/kg. The average metabolic rate of chicken during normal activity is 10.2 W (3.78 W sensible and 6.42 W latent).

Analysis The total rate of heat generation of the chickens in the breeding room is

$$\begin{aligned} \dot{Q}_{\text{gen, total}} &= \dot{q}_{\text{gen, total}} (\text{No. of chickens}) \\ &= (10.2 \text{ W/chicken})(100 \text{ chickens}) = \mathbf{1020 \text{ W}} \end{aligned}$$

The latent heat generated by the chicken and the rate of moisture production are

$$\begin{aligned} \dot{Q}_{\text{gen, latent}} &= \dot{q}_{\text{gen, latent}} (\text{No. of chickens}) \\ &= (6.42 \text{ W/chicken})(100 \text{ chickens}) = 642 \text{ W} \\ &= 0.642 \text{ kW} \end{aligned}$$

$$\dot{m}_{\text{moisture}} = \frac{\dot{Q}_{\text{gen, latent}}}{h_{\text{fg}}} = \frac{0.642 \text{ kJ/s}}{2430 \text{ kJ/kg}} = 0.000264 \text{ kg/s} = \mathbf{0.264 \text{ g/s}}$$

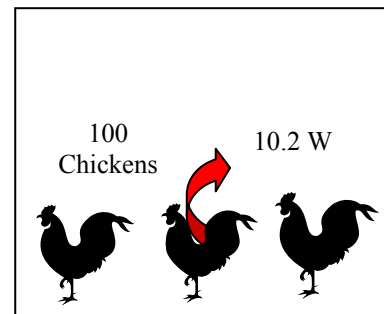

13-86 Chilled air is to cool a room by removing the heat generated in a large insulated classroom by lights and students. The required flow rate of air that needs to be supplied to the room is to be determined.

Assumptions 1 The moisture produced by the bodies leave the room as vapor without any condensing, and thus the classroom has no latent heat load. **2** Heat gain through the walls and the roof is negligible.

Properties The specific heat of air at room temperature is $1.00 \text{ kJ/kg}\cdot^\circ\text{C}$ (Table A-15). The average rate of metabolic heat generation by a person sitting or doing light work is 115 W (70 W sensible, and 45 W latent).

Analysis The rate of sensible heat generation by the people in the room and the total rate of sensible internal heat generation are

$$\begin{aligned}\dot{Q}_{\text{gen, sensible}} &= \dot{q}_{\text{gen, sensible}} (\text{No. of people}) \\ &= (70 \text{ W/person})(90 \text{ persons}) = 6300 \text{ W}\end{aligned}$$

$$\begin{aligned}\dot{Q}_{\text{total, sensible}} &= \dot{Q}_{\text{gen, sensible}} + \dot{Q}_{\text{lighting}} \\ &= 6300 + 2000 = 8300 \text{ W}\end{aligned}$$

Then the required mass flow rate of chilled air becomes

$$\begin{aligned}\dot{m}_{\text{air}} &= \frac{\dot{Q}_{\text{total, sensible}}}{c_p \Delta T} \\ &= \frac{8.3 \text{ kJ/s}}{(1.0 \text{ kJ/kg}\cdot^\circ\text{C})(25 - 15)^\circ\text{C}} = \mathbf{0.83 \text{ kg/s}}\end{aligned}$$

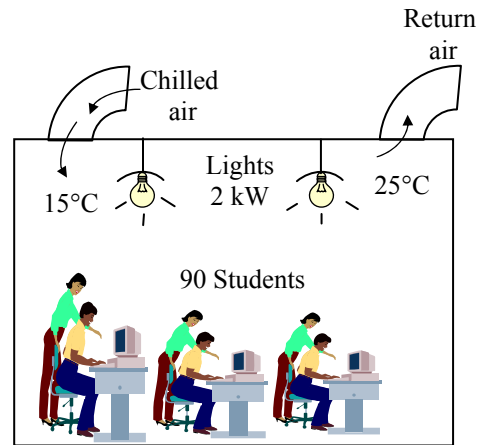

Discussion The latent heat will be removed by the air-conditioning system as the moisture condenses outside the cooling coils.

13-87 The average mean radiation temperature during a cold day drops to 18°C. The required rise in the indoor air temperature to maintain the same level of comfort in the same clothing is to be determined.

Assumptions 1 Air motion in the room is negligible. 2 The average clothing and exposed skin temperature remains the same. 3 The latent heat loss from the body remains constant. 4 Heat transfer through the lungs remain constant.

Properties The emissivity of the person is 0.95 (from Appendix tables). The convection heat transfer coefficient from the body in still air or air moving with a velocity under 0.2 m/s is $h_{\text{conv}} = 3.1 \text{ W/m}^2 \cdot \text{°C}$ (Table 13-5).

Analysis The total rate of heat transfer from the body is the sum of the rates of heat loss by convection, radiation, and evaporation,

$$\dot{Q}_{\text{body, total}} = \dot{Q}_{\text{sensible}} + \dot{Q}_{\text{latent}} + \dot{Q}_{\text{lungs}} = (\dot{Q}_{\text{conv}} + \dot{Q}_{\text{rad}}) + \dot{Q}_{\text{latent}} + \dot{Q}_{\text{lungs}}$$

Noting that heat transfer from the skin by evaporation and from the lungs remains constant, the sum of the convection and radiation heat transfer from the person must remain constant.

$$\begin{aligned} \dot{Q}_{\text{sensible, old}} &= hA_s(T_s - T_{\text{air, old}}) + \varepsilon A_s \sigma (T_s^4 - T_{\text{surr, old}}^4) \\ &= hA_s(T_s - 22) + 0.95A_s \sigma [(T_s + 273)^4 - (22 + 273)^4] \\ \dot{Q}_{\text{sensible, new}} &= hA_s(T_s - T_{\text{air, new}}) + \varepsilon A_s \sigma (T_s^4 - T_{\text{surr, new}}^4) \\ &= hA_s(T_s - T_{\text{air, new}}) + 0.95A_s \sigma [(T_s + 273)^4 - (18 + 273)^4] \end{aligned}$$

Setting the two relations above equal to each other, canceling the surface area A_s , and simplifying gives

$$\begin{aligned} -22h - 0.95\sigma(22 + 273)^4 &= -hT_{\text{air, new}} - 0.95\sigma(18 + 273)^4 \\ 3.1(T_{\text{air, new}} - 22) + 0.95 \times 5.67 \times 10^{-8}(291^4 - 295^4) &= 0 \end{aligned}$$

Solving for the new air temperature gives

$$T_{\text{air, new}} = \mathbf{29.0^\circ\text{C}}$$

Therefore, the air temperature must be raised to 29°C to counteract the increase in heat transfer by radiation.

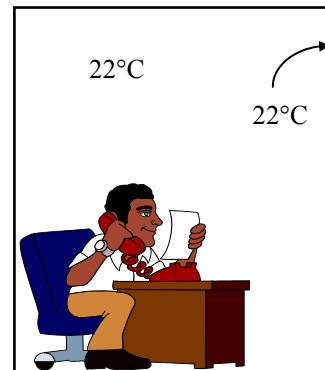

13-88 The average mean radiation temperature during a cold day drops to 12°C. The required rise in the indoor air temperature to maintain the same level of comfort in the same clothing is to be determined.

Assumptions 1 Air motion in the room is negligible. 2 The average clothing and exposed skin temperature remains the same. 3 The latent heat loss from the body remains constant. 4 Heat transfer through the lungs remain constant.

Properties The emissivity of the person is 0.95 (from Appendix tables). The convection heat transfer coefficient from the body in still air or air moving with a velocity under 0.2 m/s is $h_{\text{conv}} = 3.1 \text{ W/m}^2 \cdot \text{°C}$ (Table 13-5).

Analysis The total rate of heat transfer from the body is the sum of the rates of heat loss by convection, radiation, and evaporation,

$$\dot{Q}_{\text{body, total}} = \dot{Q}_{\text{sensible}} + \dot{Q}_{\text{latent}} + \dot{Q}_{\text{lungs}} = (\dot{Q}_{\text{conv}} + \dot{Q}_{\text{rad}}) + \dot{Q}_{\text{latent}} + \dot{Q}_{\text{lungs}}$$

Noting that heat transfer from the skin by evaporation and from the lungs remains constant, the sum of the convection and radiation heat transfer from the person must remain constant.

$$\begin{aligned} \dot{Q}_{\text{sensible, old}} &= hA_s(T_s - T_{\text{air, old}}) + \varepsilon A_s \sigma (T_s^4 - T_{\text{surr, old}}^4) \\ &= hA_s(T_s - 22) + 0.95A_s \sigma [(T_s + 273)^4 - (22 + 273)^4] \\ \dot{Q}_{\text{sensible, new}} &= hA_s(T_s - T_{\text{air, new}}) + \varepsilon A_s \sigma (T_s^4 - T_{\text{surr, new}}^4) \\ &= hA_s(T_s - T_{\text{air, new}}) + 0.95A_s \sigma [(T_s + 273)^4 - (12 + 273)^4] \end{aligned}$$

Setting the two relations above equal to each other, canceling the surface area A_s , and simplifying gives

$$\begin{aligned} -22h - 0.95\sigma(22 + 273)^4 &= -hT_{\text{air, new}} - 0.95\sigma(12 + 273)^4 \\ 3.1(T_{\text{air, new}} - 22) + 0.95 \times 5.67 \times 10^{-8}(285^4 - 295^4) &= 0 \end{aligned}$$

Solving for the new air temperature gives

$$T_{\text{air, new}} = \mathbf{39.0^\circ\text{C}}$$

Therefore, the air temperature must be raised to 39°C to counteract the increase in heat transfer by radiation.

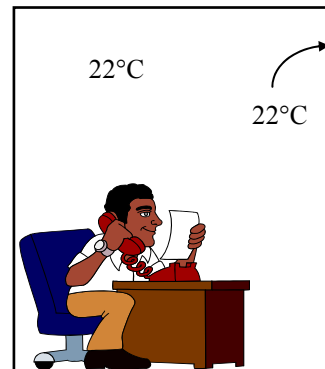

13-89 A car mechanic is working in a shop heated by radiant heaters in winter. The lowest ambient temperature the worker can work in comfortably is to be determined.

Assumptions 1 The air motion in the room is negligible, and the mechanic is standing. **2** The average clothing and exposed skin temperature of the mechanic is 33°C.

Properties The emissivity and absorptivity of the person is given to be 0.95. The convection heat transfer coefficient from a standing body in still air or air moving with a velocity under 0.2 m/s is $h_{\text{conv}} = 4.0 \text{ W/m}^2 \cdot ^\circ\text{C}$ (Table 13-5).

Analysis The equivalent thermal resistance of clothing is

$$R_{\text{cloth}} = 0.7 \text{ clo} = 0.7 \times 0.155 \text{ m}^2 \cdot ^\circ\text{C/W} = 0.1085 \text{ m}^2 \cdot ^\circ\text{C/W}$$

Radiation from the heaters incident on the person and the rate of sensible heat generation by the person are

$$\dot{Q}_{\text{rad, incident}} = 0.05 \times \dot{Q}_{\text{rad, total}} = 0.05(4 \text{ kW}) = 0.2 \text{ kW} = 200 \text{ W}$$

$$\dot{Q}_{\text{gen, sensible}} = 0.5 \times \dot{Q}_{\text{gen, total}} = 0.5(350 \text{ W}) = 175 \text{ W}$$

Under steady conditions, and energy balance on the body can be expressed as

$$\dot{E}_{\text{in}} - \dot{E}_{\text{out}} + \dot{E}_{\text{gen}} = 0$$

$$\dot{Q}_{\text{rad from heater}} - \dot{Q}_{\text{conv+rad from body}} + \dot{Q}_{\text{gen, sensible}} = 0$$

or

$$\alpha \dot{Q}_{\text{rad, incident}} - h_{\text{conv}} A_s (T_s - T_{\text{surr}}) - \varepsilon A_s \sigma (T_s^4 - T_{\text{surr}}^4) + \dot{Q}_{\text{gen, sensible}} = 0$$

$$0.95(200 \text{ W}) - (4.0 \text{ W/m}^2 \cdot \text{K})(1.8 \text{ m}^2)(306 - T_{\text{surr}})$$

$$- 0.95(1.8 \text{ m}^2)(5.67 \times 10^{-8} \text{ W/m}^2 \cdot \text{K}^4)[(306 \text{ K})^4 - T_{\text{surr}}^4] + 175 \text{ W} = 0$$

Solving the equation above gives

$$T_{\text{surr}} = 284.8 \text{ K} = \mathbf{11.8^\circ\text{C}}$$

Therefore, the mechanic can work comfortably at temperatures as low as 12°C.

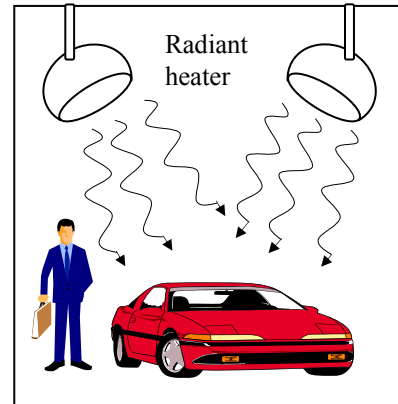

Review Problems

13-90 The temperature of air in a duct is measured by a thermocouple. The radiation effect on the temperature measurement is to be quantified, and the actual air temperature is to be determined.

Assumptions The surfaces are opaque, diffuse, and gray.

Properties The emissivity of thermocouple is given to be $\varepsilon=0.6$.

Analysis The actual temperature of the air can be determined from

$$\begin{aligned} T_f &= T_{th} + \frac{\varepsilon_{th} \sigma (T_{th}^4 - T_w^4)}{h} \\ &= 850 \text{ K} + \frac{(0.6)(5.67 \times 10^{-8} \text{ W/m}^2 \cdot \text{K}^4)[(850 \text{ K})^4 - (500 \text{ K})^4]}{60 \text{ W/m}^2 \cdot ^\circ\text{C}} \\ &= \mathbf{1111 \text{ K}} \end{aligned}$$

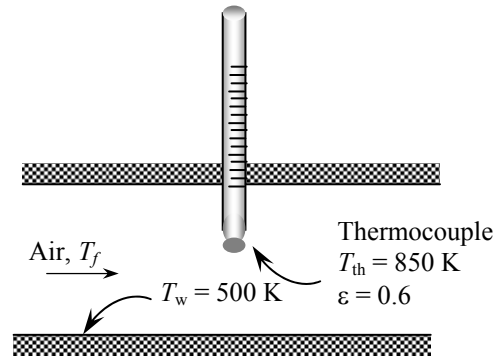

13-91 Radiation heat transfer occurs between two parallel coaxial disks. The view factors and the rate of radiation heat transfer for the existing and modified cases are to be determined.

Assumptions 1 Steady operating conditions exist 2 The surfaces are opaque, diffuse, and gray. 3 Convection heat transfer is not considered.

Properties The emissivities of disk a and b are given to be $\varepsilon_a = 0.60$ and $\varepsilon_b = 0.8$, respectively.

Analysis (a) The view factor from surface a to surface b is determined as follows

$$A = \frac{a}{2L} = \frac{0.20}{2(0.10)} = 1$$

$$B = \frac{b}{2L} = \frac{0.40}{2(0.10)} = 2$$

$$C = 1 + \frac{1 + A^2}{B^2} = 1 + \frac{1 + 1^2}{2^2} = 1.5$$

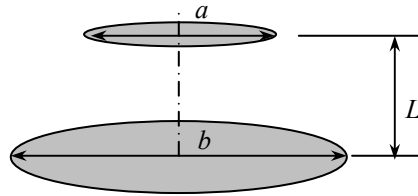

$$F_{ab} = 0.5 \left(\frac{B}{A} \right)^2 \left\{ C - \left[C^2 - 4 \left(\frac{A}{B} \right)^2 \right]^{0.5} \right\} = 0.5 \left(\frac{2}{1} \right)^2 \left\{ 1.5 - \left[1.5^2 - 4 \left(\frac{1}{2} \right)^2 \right]^{0.5} \right\} = \mathbf{0.764}$$

The view factor from surface b to surface a is determined from reciprocity relation:

$$A_a = \frac{\pi a^2}{4} = \frac{\pi(0.2 \text{ m})^2}{4} = 0.0314 \text{ m}^2$$

$$A_b = \frac{\pi b^2}{4} = \frac{\pi(0.4 \text{ m})^2}{4} = 0.1257 \text{ m}^2$$

$$A_a F_{ab} = A_b F_{ba}$$

$$(0.0314)(0.764) = (0.1257)F_{ba} \longrightarrow F_{ba} = \mathbf{0.191}$$

(b) The net rate of radiation heat transfer between the surfaces can be determined from

$$\dot{Q}_{ab} = \frac{\sigma(T_a^4 - T_b^4)}{\frac{1 - \varepsilon_a}{A_a \varepsilon_a} + \frac{1}{A_a F_{ab}} + \frac{1 - \varepsilon_b}{A_b \varepsilon_b}} = \frac{(5.67 \times 10^{-8} \text{ W/m}^2 \cdot \text{K}^4) [(873 \text{ K})^4 - (473 \text{ K})^4]}{\frac{1 - 0.6}{(0.0314 \text{ m}^2)(0.6)} + \frac{1}{(0.0314 \text{ m}^2)(0.764)} + \frac{1 - 0.8}{(0.1257 \text{ m}^2)(0.8)}} = \mathbf{464 \text{ W}}$$

(c) In this case we have $\varepsilon_c = 0.7$, $A_c \rightarrow \infty$, $F_{ac} = F_{bc} = 1$ and $\dot{Q}_{ac} = \dot{Q}_{cb} = \dot{Q}_{bc}$. An energy balance gives

$$\begin{aligned} \frac{\sigma(T_a^4 - T_c^4)}{\frac{1 - \varepsilon_a}{A_a \varepsilon_a} + \frac{1}{A_a F_{ac}} + \frac{1 - \varepsilon_c}{A_c \varepsilon_c}} &= \frac{\sigma(T_c^4 - T_b^4)}{\frac{1 - \varepsilon_c}{A_c \varepsilon_c} + \frac{1}{A_c F_{cb}} + \frac{1 - \varepsilon_b}{A_b \varepsilon_b}} \\ \frac{T_a^4 - T_c^4}{\frac{1 - \varepsilon_a}{A_a \varepsilon_a} + \frac{1}{A_a F_{ac}} + 0} &= \frac{T_c^4 - T_b^4}{0 + \frac{1}{A_b F_{bc}} + \frac{1 - \varepsilon_b}{A_b \varepsilon_b}} \\ \frac{(873)^4 - T_c^4}{\frac{1 - 0.6}{(0.0314 \text{ m}^2)(0.6)} + \frac{1}{(0.0314 \text{ m}^2)(1)}} &= \frac{T_c^4 - 473^4}{\frac{1}{(0.1257 \text{ m}^2)(1)} + \frac{1 - 0.8}{(0.1257 \text{ m}^2)(0.8)}} \\ &\longrightarrow T_c = 605 \text{ K} \end{aligned}$$

Then

$$\dot{Q}_{bc} = \dot{Q}_{ac} = \frac{\sigma(T_a^4 - T_c^4)}{\frac{1 - \varepsilon_a}{A_a \varepsilon_a} + \frac{1}{A_a F_{ac}} + \frac{1 - \varepsilon_c}{A_c \varepsilon_c}} = \frac{(5.67 \times 10^{-8} \text{ W/m}^2 \cdot \text{K}^4) [(873 \text{ K})^4 - (605 \text{ K})^4]}{\frac{1 - 0.6}{(0.0314 \text{ m}^2)(0.6)} + \frac{1}{(0.0314 \text{ m}^2)(1)} + 0} = \mathbf{477 \text{ W}}$$

Discussion The rate of heat transfer is higher in part (c) because the large disk c is able to collect all radiation emitted by disk a . It is not acting as a shield.

13-92 Radiation heat transfer occurs between a tube-bank and a wall. The view factors, the net rate of radiation heat transfer, and the temperature of tube surface are to be determined.

Assumptions 1 Steady operating conditions exist 2 The surfaces are opaque, diffuse, and gray. 3 The tube wall thickness and convection from the outer surface are negligible.

Properties The emissivities of the wall and tube bank are given to be $\epsilon_i = 0.8$ and $\epsilon_j = 0.9$, respectively.

Analysis (a) We take the wall to be surface i and the tube bank to be surface j . The view factor from surface i to surface j is determined from

$$F_{ij} = 1 - \left[1 - \left(\frac{D}{s} \right)^2 \right]^{0.5} + \left(\frac{D}{s} \right) \left\{ \tan^{-1} \left[\left(\frac{s}{D} \right)^2 - 1 \right]^{0.5} \right\}$$

$$= 1 - \left[1 - \left(\frac{1.5}{3} \right)^2 \right]^{0.5} + \left(\frac{1.5}{3} \right) \left\{ \tan^{-1} \left[\left(\frac{3}{1.5} \right)^2 - 1 \right]^{0.5} \right\} = \mathbf{0.658}$$

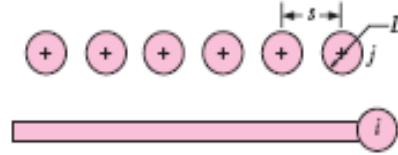

The view factor from surface j to surface i is determined from reciprocity relation. Taking s to be the width of the wall

$$A_i F_{ij} = A_j F_{ji} \longrightarrow F_{ji} = \frac{A_i}{A_j} F_{ij} = \frac{sL}{\pi DL} F_{ij} = \frac{s}{\pi D} F_{ij} = \frac{3}{\pi(1.5)} (0.658) = \mathbf{0.419}$$

(b) The net rate of radiation heat transfer between the surfaces can be determined from

$$\dot{q} = \frac{\sigma(T_i^4 - T_j^4)}{\left(\frac{1-\epsilon_i}{\epsilon_i} \right) \frac{1}{A_i} + \frac{1}{A_i F_{ij}} + \left(\frac{1-\epsilon_j}{\epsilon_j} \right) \frac{1}{A_j}} = \frac{\sigma(T_i^4 - T_j^4)}{\frac{1-\epsilon_i}{\epsilon_i} + \frac{1}{F_{ij}} + \left(\frac{1-\epsilon_j}{\epsilon_j} \right) \frac{A_i}{A_j}}$$

$$= \frac{(5.67 \times 10^{-8} \text{ W/m}^2 \cdot \text{K}^4) [(1173 \text{ K})^4 - (333 \text{ K})^4]}{\frac{1-0.8}{0.8} + \frac{1}{0.658} + \left(\frac{1-0.9}{0.9} \right) \frac{(0.03 \text{ m})}{\pi(0.015 \text{ m})}} = \mathbf{57,900 \text{ W/m}^2}$$

(c) Under steady conditions, the rate of radiation heat transfer from the wall to the tube surface is equal to the rate of convection heat transfer from the tube wall to the fluid. Denoting T_w to be the wall temperature,

$$\dot{q}_{rad} = \dot{q}_{conv}$$

$$\frac{\sigma(T_i^4 - T_w^4)}{\frac{1-\epsilon_i}{\epsilon_i} + \frac{1}{F_{ij}} + \left(\frac{1-\epsilon_j}{\epsilon_j} \right) \frac{A_i}{A_j}} = h A_j (T_w - T_j)$$

$$\frac{(5.67 \times 10^{-8} \text{ W/m}^2 \cdot \text{K}^4) [(1173 \text{ K})^4 - T_w^4]}{\frac{1-0.8}{0.8} + \frac{1}{0.658} + \left(\frac{1-0.9}{0.9} \right) \frac{(0.03 \text{ m})}{\pi(0.015 \text{ m})}} = (2000 \text{ W/m}^2 \cdot \text{K}) \left[\frac{\pi(0.015 \text{ m})}{0.03 \text{ m}} \right] [T_w - (40 + 273 \text{ K})]$$

Solving this equation by an equation solver such as EES, we obtain

$$T_w = 331.4 \text{ K} = \mathbf{58.4^\circ\text{C}}$$

13-93 The temperature of hot gases in a duct is measured by a thermocouple. The actual temperature of the gas is to be determined, and compared with that without a radiation shield.

Assumptions The surfaces are opaque, diffuse, and gray.

Properties The emissivity of the thermocouple is given to be $\varepsilon = 0.7$.

Analysis Assuming the area of the shield to be very close to the sensor of the thermometer, the radiation heat transfer from the sensor is determined from

$$\dot{Q}_{\text{rad, from sensor}} = \frac{\sigma(T_1^4 - T_2^4)}{\left(\frac{1}{\varepsilon_1} - 1\right) + \left(2\frac{1}{\varepsilon_2} - 1\right)} = \frac{(5.67 \times 10^{-8} \text{ W/m}^2 \cdot \text{K}^4)[(530 \text{ K})^4 - (380 \text{ K})^4]}{\left(\frac{1}{0.7} - 1\right) + \left(2\frac{1}{0.15} - 1\right)} = 257.9 \text{ W/m}^2$$

Then the actual temperature of the gas can be determined from a heat transfer balance to be

$$\begin{aligned} \dot{q}_{\text{conv, to sensor}} &= \dot{q}_{\text{conv, from sensor}} \\ h(T_f - T_{th}) &= 257.9 \text{ W/m}^2 \\ 120 \text{ W/m}^2 \cdot ^\circ\text{C}(T_f - 530) &= 257.9 \text{ W/m}^2 \\ \longrightarrow T_f &= \mathbf{532 \text{ K}} \end{aligned}$$

Without the shield the temperature of the gas would be

$$\begin{aligned} T_f &= T_{th} + \frac{\varepsilon_{th}\sigma(T_{th}^4 - T_w^4)}{h} \\ &= 530 \text{ K} + \frac{(0.7)(5.67 \times 10^{-8} \text{ W/m}^2 \cdot \text{K}^4)[(530 \text{ K})^4 - (380 \text{ K})^4]}{120 \text{ W/m}^2 \cdot ^\circ\text{C}} \\ &= \mathbf{549.2 \text{ K}} \end{aligned}$$

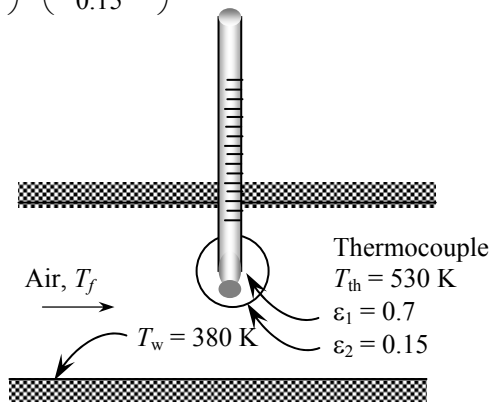

13-94E A sealed electronic box is placed in a vacuum chamber. The highest temperature at which the surrounding surfaces must be kept if this box is cooled by radiation alone is to be determined.

Assumptions 1 Steady operating conditions exist 2 The surfaces are opaque, diffuse, and gray. 3 Convection heat transfer is not considered. 4 Heat transfer from the bottom surface of the box is negligible.

Properties The emissivity of the outer surface of the box is $\varepsilon = 0.95$.

Analysis The total surface area is

$$A_s = 4 \times (8 \times 12) + (1 \times 1) = 3.67 \text{ ft}^2$$

Then the temperature of the surrounding surfaces is determined to be

$$\begin{aligned} \dot{Q}_{\text{rad}} &= \varepsilon A_s \sigma (T_s^4 - T_{\text{surr}}^4) \\ (90 \times 3.41214) \text{ Btu/h} &= (0.95)(3.67 \text{ m}^2)(0.1714 \times 10^{-8} \text{ Btu/h} \cdot \text{ft}^2 \cdot \text{R}^4)[(590 \text{ R})^4 - T_{\text{surr}}^4] \\ \longrightarrow T_{\text{surr}} &= 514 \text{ R} = \mathbf{54^\circ\text{F}} \end{aligned}$$

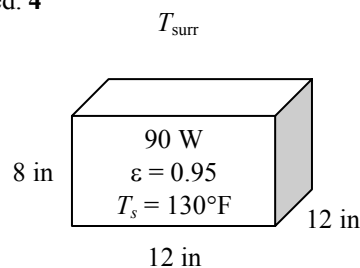

13-95 A double-walled spherical tank is used to store iced water. The air space between the two walls is evacuated. The rate of heat transfer to the iced water and the amount of ice that melts a 24-h period are to be determined.

Assumptions 1 Steady operating conditions exist 2 The surfaces are opaque, diffuse, and gray.

Properties The emissivities of both surfaces are given to be $\varepsilon_1 = \varepsilon_2 = 0.15$.

Analysis (a) Assuming the conduction resistance s of the walls to be negligible, the rate of heat transfer to the iced water in the tank is determined to be

$$A_1 = \pi D_1^2 = \pi(2.01 \text{ m})^2 = 12.69 \text{ m}^2$$

$$\dot{Q}_{12} = \frac{A_1 \sigma (T_2^4 - T_1^4)}{\frac{1}{\varepsilon_1} + \frac{1 - \varepsilon_2}{\varepsilon_2} \left(\frac{D_1}{D_2}\right)^2}$$

$$= \frac{(12.69 \text{ m}^2)(5.67 \times 10^{-8} \text{ W/m}^2 \cdot \text{K}^4)[(20 + 273 \text{ K})^4 - (0 + 273 \text{ K})^4]}{\frac{1}{0.15} + \frac{1 - 0.15}{0.15} \left(\frac{2.01}{2.04}\right)^2}$$

$$= \mathbf{107.4 \text{ W}}$$

(b) The amount of heat transfer during a 24-hour period is

$$Q = \dot{Q} \Delta t = (0.1074 \text{ kJ/s})(24 \times 3600 \text{ s}) = 9279 \text{ kJ}$$

The amount of ice that melts during this period then becomes

$$Q = m h_{if} \longrightarrow m = \frac{Q}{h_{if}} = \frac{9279 \text{ kJ}}{333.7 \text{ kJ/kg}} = \mathbf{27.8 \text{ kg}}$$

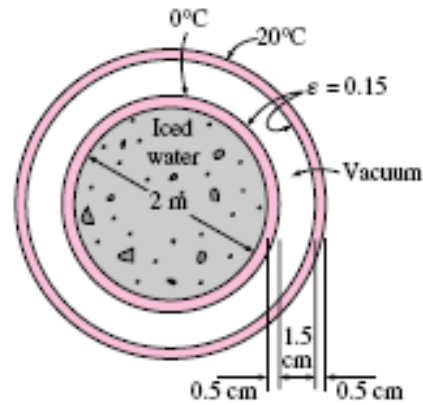

13-96 Two concentric spheres which are maintained at uniform temperatures are separated by air at 1 atm pressure. The rate of heat transfer between the two spheres by natural convection and radiation is to be determined.

Assumptions 1 Steady operating conditions exist 2 The surfaces are opaque, diffuse, and gray. 3 Air is an ideal gas with constant properties.

Properties The emissivities of the surfaces are given to be $\varepsilon_1 = \varepsilon_2 = 0.75$. The properties of air at 1 atm and the average temperature of $(T_1 + T_2)/2 = (350 + 275)/2 = 312.5$ K = 39.5°C are (Table A-15)

$$k = 0.02658 \text{ W/m}\cdot\text{°C}$$

$$\nu = 1.697 \times 10^{-5} \text{ m}^2/\text{s}$$

$$\text{Pr} = 0.7256$$

$$\beta = \frac{1}{312.5 \text{ K}} = 0.0032 \text{ K}^{-1}$$

Analysis (a) Noting that $D_i = D_1$ and $D_o = D_2$, the characteristic length is

$$L_c = \frac{1}{2}(D_o - D_i) = \frac{1}{2}(0.25 \text{ m} - 0.15 \text{ m}) = 0.05 \text{ m}$$

Then

$$Ra = \frac{g\beta(T_1 - T_2)L_c^3}{\nu^2} \text{Pr} = \frac{(9.81 \text{ m/s}^2)(0.003200 \text{ K}^{-1})(350 - 275 \text{ K})(0.05 \text{ m})^3}{(1.697 \times 10^{-5} \text{ m}^2/\text{s})^2} (0.7256) = 7.415 \times 10^5$$

The effective thermal conductivity is

$$F_{\text{sph}} = \frac{L_c}{(D_i D_o)^4 (D_i^{-7/5} + D_o^{-7/5})^5} = \frac{0.05 \text{ m}}{[(0.15 \text{ m})(0.25 \text{ m})]^4 [(0.15 \text{ m})^{-7/5} + (0.25 \text{ m})^{-7/5}]^5} = 0.005900$$

$$k_{\text{eff}} = 0.74k \left(\frac{\text{Pr}}{0.861 + \text{Pr}} \right)^{1/4} (F_{\text{sph}} Ra)^{1/4}$$

$$= 0.74(0.02658 \text{ W/m}\cdot\text{°C}) \left(\frac{0.7256}{0.861 + 0.7256} \right)^{1/4} [(0.00590)(7.415 \times 10^5)]^{1/4}$$

$$= 0.1315 \text{ W/m}\cdot\text{°C}$$

Then the rate of heat transfer between the spheres becomes

$$\dot{Q} = k_{\text{eff}} \pi \left(\frac{D_i D_o}{L_c} \right) (T_i - T_o) = (0.1315 \text{ W/m}\cdot\text{°C}) \pi \left[\frac{(0.15 \text{ m})(0.25 \text{ m})}{(0.05 \text{ m})} \right] (350 - 275) \text{ K} = \mathbf{23.2 \text{ W}}$$

(b) The rate of heat transfer by radiation is determined from

$$A_1 = \pi D_1^2 = \pi (0.15 \text{ m})^2 = 0.0707 \text{ m}^2$$

$$\dot{Q}_{12} = \frac{A_1 \sigma (T_2^4 - T_1^4)}{\frac{1}{\varepsilon_1} + \frac{1 - \varepsilon_2}{\varepsilon_2} \left(\frac{D_1}{D_2} \right)^2} = \frac{(0.0707 \text{ m}^2)(5.67 \times 10^{-8} \text{ W/m}^2 \cdot \text{K}^4)[(350 \text{ K})^4 - (275 \text{ K})^4]}{\frac{1}{0.75} + \frac{1 - 0.75}{0.75} \left(\frac{0.15}{0.25} \right)^2} = \mathbf{25.6 \text{ W}}$$

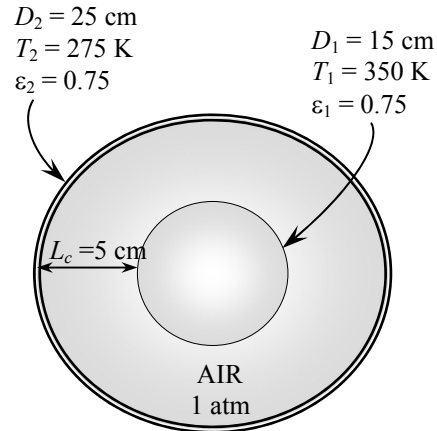

13-97 A solar collector is considered. The absorber plate and the glass cover are maintained at uniform temperatures, and are separated by air. The rate of heat loss from the absorber plate by natural convection and radiation is to be determined.

Assumptions 1 Steady operating conditions exist 2 The surfaces are opaque, diffuse, and gray. 3 Air is an ideal gas with constant properties.

Properties The emissivities of surfaces are given to be $\varepsilon_1 = 0.9$ for glass and $\varepsilon_2 = 0.8$ for the absorber plate. The properties of air at 1 atm and the average temperature of $(T_1 + T_2)/2 = (80 + 32)/2 = 56^\circ\text{C}$ are (Table A-15)

$$k = 0.02779 \text{ W/m}\cdot^\circ\text{C}$$

$$\nu = 1.857 \times 10^{-5} \text{ m}^2/\text{s}$$

$$\text{Pr} = 0.7212$$

$$\beta = \frac{1}{T_f} = \frac{1}{(56 + 273)\text{K}} = 0.003040 \text{ K}^{-1}$$

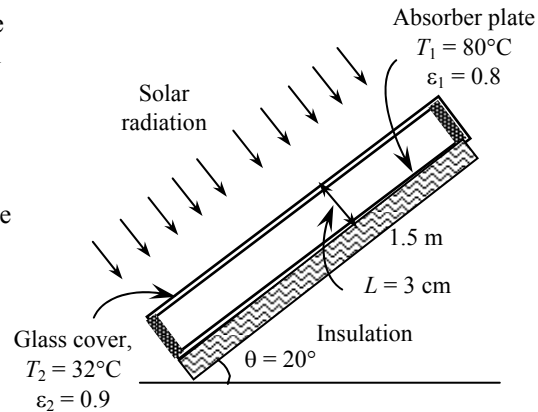

Analysis For $\theta = 0^\circ$, we have horizontal rectangular enclosure.

The characteristic length in this case is the distance between the two

glasses $L_c = L = 0.03 \text{ m}$ Then,

$$Ra = \frac{g\beta(T_1 - T_2)L^3}{\nu^2} \text{Pr} = \frac{(9.81 \text{ m/s}^2)(0.00304 \text{ K}^{-1})(80 - 32 \text{ K})(0.03 \text{ m})^3}{(1.857 \times 10^{-5} \text{ m}^2/\text{s})^2} (0.7212) = 8.083 \times 10^4$$

$$A_s = H \times W = (1.5 \text{ m})(3 \text{ m}) = 4.5 \text{ m}^2$$

$$\text{Nu} = 1 + 1.44 \left[1 - \frac{1708}{Ra \cos \theta} \right]^+ \left[1 - \frac{1708(\sin 1.8\theta)^{1.6}}{Ra \cos \theta} \right] + \left[\frac{(Ra \cos \theta)^{1/3}}{18} - 1 \right]^+$$

$$= 1 + 1.44 \left[1 - \frac{1708}{(8.083 \times 10^4) \cos(20^\circ)} \right]^+ \left[1 - \frac{1708[\sin(1.8 \times 20^\circ)]^{1.6}}{(8.083 \times 10^4) \cos(20^\circ)} \right] + \left[\frac{[(8.083 \times 10^4) \cos(20^\circ)]^{1/3}}{18} - 1 \right]^+$$

$$= 3.747$$

$$\dot{Q} = k\text{Nu}A_s \frac{T_1 - T_2}{L} = (0.02779 \text{ W/m}\cdot^\circ\text{C})(3.747)(4.5 \text{ m}^2) \frac{(80 - 32)^\circ\text{C}}{0.03 \text{ m}} = \mathbf{750 \text{ W}}$$

Neglecting the end effects, the rate of heat transfer by radiation is determined from

$$\dot{Q}_{\text{rad}} = \frac{A_s \sigma (T_1^4 - T_2^4)}{\frac{1}{\varepsilon_1} + \frac{1}{\varepsilon_2} - 1} = \frac{(4.5 \text{ m}^2)(5.67 \times 10^{-8} \text{ W/m}^2 \cdot \text{K}^4)[(80 + 273 \text{ K})^4 - (32 + 273 \text{ K})^4]}{\frac{1}{0.8} + \frac{1}{0.9} - 1} = \mathbf{1289 \text{ W}}$$

Discussion The rates of heat loss by natural convection for the horizontal and vertical cases would be as follows (Note that the Ra number remains the same):

Horizontal:

$$\text{Nu} = 1 + 1.44 \left[1 - \frac{1708}{Ra} \right]^+ + \left[\frac{Ra^{1/3}}{18} - 1 \right]^+ = 1 + 1.44 \left[1 - \frac{1708}{8.083 \times 10^4} \right]^+ + \left[\frac{(8.083 \times 10^4)^{1/3}}{18} - 1 \right]^+ = 3.812$$

$$\dot{Q} = k\text{Nu}A_s \frac{T_1 - T_2}{L} = (0.02779 \text{ W/m}\cdot^\circ\text{C})(3.812)(6 \text{ m}^2) \frac{(80 - 32)^\circ\text{C}}{0.03 \text{ m}} = \mathbf{1017 \text{ W}}$$

Vertical:

$$\text{Nu} = 0.42 Ra^{1/4} \text{Pr}^{0.012} \left(\frac{H}{L} \right)^{-0.3} = 0.42 (8.083 \times 10^4)^{1/4} (0.7212)^{0.012} \left(\frac{2 \text{ m}}{0.03 \text{ m}} \right)^{-0.3} = 2.001$$

$$\dot{Q} = k\text{Nu}A_s \frac{T_1 - T_2}{L} = (0.02779 \text{ W/m}\cdot^\circ\text{C})(2.001)(6 \text{ m}^2) \frac{(80 - 32)^\circ\text{C}}{0.03 \text{ m}} = \mathbf{534 \text{ W}}$$

13-98E The circulating pump of a solar collector that consists of a horizontal tube and its glass cover fails. The equilibrium temperature of the tube is to be determined.

Assumptions 1 Steady operating conditions exist. 2 The tube and its cover are isothermal. 3 Air is an ideal gas. 4 The surfaces are opaque, diffuse, and gray for infrared radiation. 5 The glass cover is transparent to solar radiation.

Properties The properties of air should be evaluated at the average temperature. But we do not know the exit temperature of the air in the duct, and thus we cannot determine the bulk fluid and glass cover temperatures at this point, and thus we cannot evaluate the average temperatures. Therefore, we will assume the glass temperature to be 85°F, and use properties at an anticipated average temperature of $(75+85)/2 = 80^\circ\text{F}$ (Table A-15E),

$$k = 0.01481 \text{ Btu/h} \cdot \text{ft} \cdot ^\circ\text{F}$$

$$\nu = 1.697 \times 10^{-4} \text{ ft}^2 / \text{s}$$

$$\text{Pr} = 0.7290$$

$$\beta = \frac{1}{T_{\text{ave}}} = \frac{1}{540 \text{ R}}$$

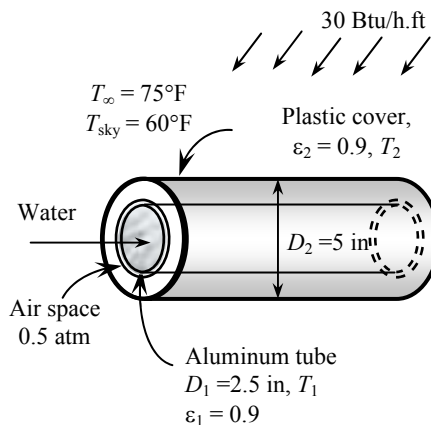

Analysis We have a horizontal cylindrical enclosure filled with air at 0.5 atm pressure. The problem involves heat transfer from the aluminum tube to the glass cover and from the outer surface of the glass cover to the surrounding ambient air. When steady operation is reached, these two heat transfer rates must equal the rate of heat gain. That is,

$$\dot{Q}_{\text{tube-glass}} = \dot{Q}_{\text{glass-ambient}} = \dot{Q}_{\text{solar gain}} = 30 \text{ Btu/h} \quad (\text{per foot of tube})$$

The heat transfer surface area of the glass cover is

$$A_o = A_{\text{glass}} = (\pi D_o W) = \pi(5/12 \text{ ft})(1 \text{ ft}) = 1.309 \text{ ft}^2 \quad (\text{per foot of tube})$$

To determine the Rayleigh number, we need to know the surface temperature of the glass, which is not available. Therefore, solution will require a trial-and-error approach. Assuming the glass cover temperature to be 85°F, the Rayleigh number, the Nusselt number, the convection heat transfer coefficient, and the rate of natural convection heat transfer from the glass cover to the ambient air are determined to be

$$\begin{aligned} \text{Ra}_{D_o} &= \frac{g\beta(T_o - T_\infty)D_o^3}{\nu^2} \text{Pr} \\ &= \frac{(32.2 \text{ ft/s}^2)[1/(540 \text{ R})](85 - 75 \text{ R})(5/12 \text{ ft})^3}{(1.697 \times 10^{-4} \text{ ft}^2/\text{s})^2} (0.7290) = 1.092 \times 10^6 \end{aligned}$$

$$\begin{aligned} \text{Nu} &= \left\{ 0.6 + \frac{0.387 \text{ Ra}_D^{1/6}}{\left[1 + (0.559 / \text{Pr})^{9/16} \right]^{8/27}} \right\}^2 = \left\{ 0.6 + \frac{0.387(1.092 \times 10^6)^{1/6}}{\left[1 + (0.559 / 0.7290)^{9/16} \right]^{8/27}} \right\}^2 \\ &= 14.95 \end{aligned}$$

$$h_o = \frac{k}{D_o} \text{Nu} = \frac{0.01481 \text{ Btu/h} \cdot \text{ft} \cdot ^\circ\text{F}}{5/12 \text{ ft}} (14.95) = 0.5315 \text{ Btu/h} \cdot \text{ft}^2 \cdot ^\circ\text{F}$$

$$\dot{Q}_{o,\text{conv}} = h_o A_o (T_o - T_\infty) = (0.5315 \text{ Btu/h} \cdot \text{ft}^2 \cdot ^\circ\text{F})(1.309 \text{ ft}^2)(85 - 75)^\circ\text{F} = 6.96 \text{ Btu/h}$$

Also,

$$\begin{aligned} \dot{Q}_{o,\text{rad}} &= \epsilon_o \sigma A_o (T_o^4 - T_{\text{sky}}^4) \\ &= (0.9)(0.1714 \times 10^{-8} \text{ Btu/h} \cdot \text{ft}^2 \cdot \text{R}^4)(1.309 \text{ ft}^2) \left[(545 \text{ R})^4 - (520 \text{ R})^4 \right] \\ &= 30.5 \text{ Btu/h} \end{aligned}$$

Then the total rate of heat loss from the glass cover becomes

$$\dot{Q}_{o,\text{total}} = \dot{Q}_{o,\text{conv}} + \dot{Q}_{o,\text{rad}} = 7.0 + 30.5 = 37.5 \text{ Btu/h}$$

which is more than 30 Btu/h. Therefore, the assumed temperature of 85°F for the glass cover is high. Repeating the calculations with lower temperatures (including the evaluation of properties), the glass cover temperature corresponding to 30 Btu/h is determined to be 81.5°F.

The temperature of the aluminum tube is determined in a similar manner using the natural convection and radiation relations for two horizontal concentric cylinders. The characteristic length in this case is the distance between the two cylinders, which is

$$L_c = (D_o - D_i) / 2 = (5 - 2.5) / 2 = 1.25 \text{ in} = 1.25/12 \text{ ft}$$

Also,

$$A_i = A_{\text{tube}} = (\pi D_i W) = \pi(2.5/12 \text{ ft})(1 \text{ ft}) = 0.6545 \text{ ft}^2 \text{ (per foot of tube)}$$

We start the calculations by assuming the tube temperature to be 118.5°F, and thus an average temperature of $(81.5 + 118.5)/2 = 100^\circ\text{F} = 560 \text{ R}$. Using properties at 100°F,

$$\text{Ra}_L = \frac{g\beta(T_i - T_o)L^3}{\nu^2} \text{Pr} = \frac{(32.2 \text{ ft/s}^2)[1/(560 \text{ R})](118.5 - 81.5 \text{ R})(1.25/12 \text{ ft})^3}{[(1.809 \times 10^{-4} \text{ ft}^2/\text{s})/0.5]^2} (0.726) = 1.334 \times 10^4$$

The effective thermal conductivity is

$$F_{\text{cyc}} = \frac{[\ln(D_o/D_i)]^4}{L_c^3 (D_i^{-3/5} + D_o^{-3/5})^5} = \frac{[\ln(5/2.5)]^4}{(1.25/12 \text{ ft})^3 [(2.5/12 \text{ ft})^{-3/5} + (5/12 \text{ ft})^{-3/5}]^5} = 0.1466$$

$$\begin{aligned} k_{\text{eff}} &= 0.386k \left(\frac{\text{Pr}}{0.861 + \text{Pr}} \right)^{1/4} (F_{\text{cyc}} \text{Ra}_L)^{1/4} \\ &= 0.386(0.01529 \text{ Btu/h} \cdot \text{ft} \cdot ^\circ\text{F}) \left(\frac{0.726}{0.861 + 0.726} \right) (0.1466 \times 1.334 \times 10^4)^{1/4} \\ &= 0.03227 \text{ Btu/h} \cdot \text{ft} \cdot ^\circ\text{F} \end{aligned}$$

Then the rate of heat transfer between the cylinders by convection becomes

$$\dot{Q}_{i,\text{conv}} = \frac{2\pi k_{\text{eff}}}{\ln(D_o/D_i)} (T_i - T_o) = \frac{2\pi(0.03227 \text{ Btu/h} \cdot \text{ft} \cdot ^\circ\text{F})}{\ln(5/2.5)} (118.5 - 81.5)^\circ\text{F} = 10.8 \text{ Btu/h}$$

Also,

$$\begin{aligned} \dot{Q}_{i,\text{rad}} &= \frac{\sigma A_i (T_i^4 - T_o^4)}{\frac{1}{\varepsilon_i} + \frac{1 - \varepsilon_o}{\varepsilon_o} \left(\frac{D_i}{D_o} \right)} \\ &= \frac{(0.1714 \times 10^{-8} \text{ Btu/h} \cdot \text{ft}^2 \cdot \text{R}^4)(0.6545 \text{ ft}^2) [(578.5 \text{ R})^4 - (541.5 \text{ R})^4]}{\frac{1}{0.9} + \frac{1 - 0.9}{0.9} \left(\frac{2.5 \text{ in}}{5 \text{ in}} \right)} = 25.0 \text{ Btu/h} \end{aligned}$$

Then the total rate of heat loss from the glass cover becomes

$$\dot{Q}_{i,\text{total}} = \dot{Q}_{i,\text{conv}} + \dot{Q}_{i,\text{rad}} = 10.8 + 25.0 = 35.8 \text{ Btu/h}$$

which is more than 30 Btu/h. Therefore, the assumed temperature of 118.5°F for the tube is high. By trying other values, the tube temperature corresponding to 30 Btu/h is determined to be **113°F**. Therefore, the tube will reach an equilibrium temperature of 113°F when the pump fails.

13-99 A double-pane window consists of two sheets of glass separated by an air space. The rates of heat transfer through the window by natural convection and radiation are to be determined.

Assumptions 1 Steady operating conditions exist 2 The surfaces are opaque, diffuse, and gray. 3 Air is an ideal gas with constant specific heats. 4 Heat transfer through the window is one-dimensional and the edge effects are negligible.

Properties The emissivities of glass surfaces are given to be $\varepsilon_1 = \varepsilon_2 = 0.9$. The properties of air at 0.3 atm and the average temperature of $(T_1 + T_2)/2 = (15 + 5)/2 = 10^\circ\text{C}$ are (Table A-15)

$$k = 0.02439 \text{ W/m}\cdot^\circ\text{C}$$

$$\nu = \nu_{1\text{atm}} / 0.3 = 1.426 \times 10^{-5} / 0.3 = 4.753 \times 10^{-5} \text{ m}^2/\text{s}$$

$$\text{Pr} = 0.7336$$

$$\beta = \frac{1}{(10 + 273) \text{ K}} = 0.003534 \text{ K}^{-1}$$

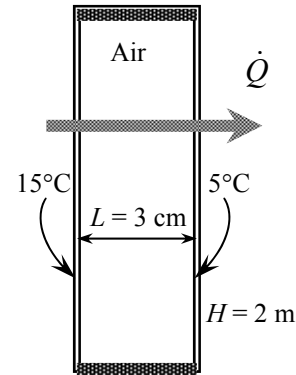

Analysis The characteristic length in this case is the distance between the glasses, $L_c = L = 0.03 \text{ m}$

$$Ra = \frac{g\beta(T_1 - T_2)L^3}{\nu^2} \text{Pr} = \frac{(9.81 \text{ m/s}^2)(0.003534 \text{ K}^{-1})(15 - 5)\text{K}(0.03 \text{ m})^3}{(4.753 \times 10^{-5} \text{ m}^2/\text{s})^2} (0.7336) = 3040$$

$$Nu = 0.197 Ra^{1/4} \left(\frac{H}{L}\right)^{-1/9} = 0.197(3040)^{1/4} \left(\frac{2}{0.05}\right)^{-1/9} = 0.971$$

Note that heat transfer through the air space is less than that by pure conduction as a result of partial evacuation of the space. Then the rate of heat transfer through the air space becomes

$$A_s = (2 \text{ m})(5 \text{ m}) = 10 \text{ m}^2$$

$$\dot{Q}_{conv} = kNuA_s \frac{T_1 - T_2}{L} = (0.02439 \text{ W/m}\cdot^\circ\text{C})(0.971)(10 \text{ m}^2) \frac{(15 - 5)^\circ\text{C}}{0.03 \text{ m}} = \mathbf{78.9 \text{ W}}$$

The rate of heat transfer by radiation is determined from

$$\dot{Q}_{rad} = \frac{A_s \sigma (T_1^4 - T_2^4)}{\frac{1}{\varepsilon_1} + \frac{1}{\varepsilon_2} - 1} = \frac{(10 \text{ m}^2)(5.67 \times 10^{-8} \text{ W/m}^2 \cdot \text{K}^4)[(15 + 273 \text{ K})^4 - (5 + 273 \text{ K})^4]}{\frac{1}{0.9} + \frac{1}{0.9} - 1} = \mathbf{421 \text{ W}}$$

Then the rate of total heat transfer becomes

$$\dot{Q}_{total} = \dot{Q}_{conv} + \dot{Q}_{rad} = 79 + 421 = \mathbf{500 \text{ W}}$$

Discussion Note that heat transfer through the window is mostly by radiation.

13-100 A simple solar collector is built by placing a clear plastic tube around a garden hose. The rate of heat loss from the water in the hose by natural convection and radiation is to be determined.

Assumptions 1 Steady operating conditions exist 2 The surfaces are opaque, diffuse, and gray. 3 Air is an ideal gas with constant specific heats.

Properties The emissivities of surfaces are given to be $\varepsilon_1 = \varepsilon_2 = 0.9$. The properties of air are at 1 atm and the film temperature of $(T_s + T_\infty)/2 = (40 + 25)/2 = 32.5^\circ\text{C}$ are (Table A-15)

$$k = 0.02607 \text{ W/m}\cdot^\circ\text{C}$$

$$\nu = 1.632 \times 10^{-5} \text{ m}^2/\text{s}$$

$$\text{Pr} = 0.7275$$

$$\beta = \frac{1}{(32.5 + 273) \text{ K}} = 0.003273 \text{ K}^{-1}$$

Analysis Under steady conditions, the heat transfer rate from the water in the hose equals to the rate of heat loss from the clear plastic tube to the surroundings by natural convection and radiation. The characteristic length in this case is the diameter of the plastic tube,

$$L_c = D_{\text{plastic}} = D_2 = 0.06 \text{ m.}$$

$$\text{Ra} = \frac{g\beta(T_s - T_\infty)D_2^3}{\nu^2} \text{Pr} = \frac{(9.81 \text{ m/s}^2)(0.003273 \text{ K}^{-1})(40 - 25)\text{K}(0.06 \text{ m})^3}{(1.632 \times 10^{-5} \text{ m}^2/\text{s})^2} (0.7275) = 2.842 \times 10^5$$

$$\text{Nu} = \left\{ 0.6 + \frac{0.387 \text{ Ra}_D^{1/6}}{\left[1 + (0.559 / \text{Pr})^{9/16} \right]^{8/27}} \right\}^2 = \left\{ 0.6 + \frac{0.387(2.842 \times 10^5)^{1/6}}{\left[1 + (0.559 / 0.7241)^{9/16} \right]^{8/27}} \right\}^2 = 10.30$$

$$h = \frac{k}{D_2} \text{Nu} = \frac{0.02607 \text{ W/m}\cdot^\circ\text{C}}{0.06 \text{ m}} (10.30) = 4.475 \text{ W/m}^2 \cdot ^\circ\text{C}$$

$$A_{\text{plastic}} = A_2 = \pi D_2 L = \pi(0.06 \text{ m})(1 \text{ m}) = 0.1885 \text{ m}^2$$

Then the rate of heat transfer from the outer surface by natural convection becomes

$$\dot{Q}_{\text{conv}} = hA_2(T_s - T_\infty) = (4.475 \text{ W/m}^2 \cdot ^\circ\text{C})(0.1885 \text{ m}^2)(40 - 25)^\circ\text{C} = \mathbf{12.7 \text{ W}}$$

The rate of heat transfer by radiation from the outer surface is determined from

$$\begin{aligned} \dot{Q}_{\text{rad}} &= \varepsilon A_2 \sigma (T_s^4 - T_{\text{sky}}^4) \\ &= (0.90)(0.1885 \text{ m}^2)(5.67 \times 10^{-8} \text{ W/m}^2 \cdot \text{K}^4)[(40 + 273 \text{ K})^4 - (15 + 273 \text{ K})^4] \\ &= \mathbf{26.1 \text{ W}} \end{aligned}$$

Finally,

$$\dot{Q}_{\text{total,loss}} = 12.7 + 26.1 = 38.8 \text{ W}$$

Discussion Note that heat transfer is mostly by radiation.

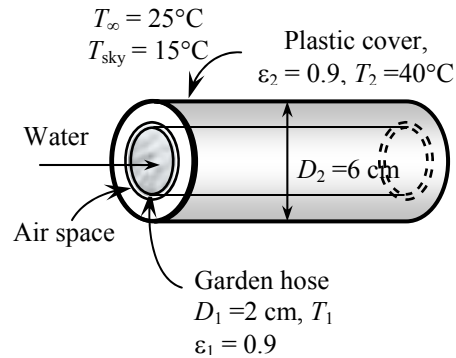

13-101 A solar collector consists of a horizontal copper tube enclosed in a concentric thin glass tube. The annular space between the copper and the glass tubes is filled with air at 1 atm. The rate of heat loss from the collector by natural convection and radiation is to be determined.

Assumptions 1 Steady operating conditions exist 2 The surfaces are opaque, diffuse, and gray. 3 Air is an ideal gas with constant specific heats.

Properties The emissivities of surfaces are given to be $\varepsilon_1 = 0.85$ for the tube surface and $\varepsilon_2 = 0.9$ for glass cover. The properties of air at 1 atm and the average temperature of $(T_1 + T_2)/2 = (60 + 40)/2 = 50^\circ\text{C}$ are (Table A-15)

$$k = 0.02735 \text{ W/m}\cdot^\circ\text{C}$$

$$\nu = 1.798 \times 10^{-5} \text{ m}^2/\text{s}$$

$$\text{Pr} = 0.7228$$

$$\beta = \frac{1}{(50 + 273) \text{ K}} = 0.003096 \text{ K}^{-1}$$

Analysis The characteristic length in this case is

$$L_c = \frac{1}{2}(D_2 - D_1) = \frac{1}{2}(0.12 \text{ m} - 0.05 \text{ m}) = 0.07 \text{ m}$$

$$\text{Ra} = \frac{g\beta(T_1 - T_2)L_c^3}{\nu^2} \text{Pr} = \frac{(9.81 \text{ m/s}^2)(0.003096 \text{ K}^{-1})(60 - 40)\text{K}(0.035 \text{ m})^3}{(1.798 \times 10^{-5} \text{ m}^2/\text{s})^2} (0.7228) = 5.823 \times 10^4$$

The effective thermal conductivity is

$$F_{\text{cyl}} = \frac{[\ln(D_o / D_i)]^4}{L_c^3 (D_i^{-3/5} + D_o^{-3/5})^5} = \frac{[\ln(0.12 / 0.05)]^4}{(0.035 \text{ m})^3 [(0.05 \text{ m})^{-3/5} + (0.12 \text{ m})^{-3/5}]^5} = 0.1678$$

$$k_{\text{eff}} = 0.386k \left(\frac{\text{Pr}}{0.861 + \text{Pr}} \right)^{1/4} (F_{\text{cyl}} \text{Ra})^{1/4}$$

$$= 0.386(0.02735 \text{ W/m}\cdot^\circ\text{C}) \left(\frac{0.7228}{0.861 + 0.7228} \right)^{1/4} [(0.1678)(5.823 \times 10^4)]^{1/4} = 0.08626 \text{ W/m}\cdot^\circ\text{C}$$

Then the rate of heat transfer between the cylinders becomes

$$\dot{Q}_{\text{conv}} = \frac{2\pi k_{\text{eff}}}{\ln(D_o / D_i)} (T_i - T_o) = \frac{2\pi(0.08626 \text{ W/m}\cdot^\circ\text{C})}{\ln(0.12 / 0.05)} (60 - 40)^\circ\text{C} = \mathbf{12.4 \text{ W}}$$

The rate of heat transfer by radiation is determined from

$$\dot{Q}_{\text{rad}} = \frac{A_1 \sigma (T_1^4 - T_2^4)}{\frac{1}{\varepsilon_1} + \frac{1 - \varepsilon_2}{\varepsilon_2} \left(\frac{D_1}{D_2} \right)} = \frac{[\pi(0.05 \text{ m})(1 \text{ m})](5.67 \times 10^{-8} \text{ W/m}^2 \cdot \text{K}^4)[(60 + 273 \text{ K})^4 - (40 + 273 \text{ K})^4]}{\frac{1}{0.85} + \frac{1 - 0.9}{0.9} \left(\frac{5}{12} \right)}$$

$$= \mathbf{19.7 \text{ W}}$$

Finally,

$$\dot{Q}_{\text{total,loss}} = 12.4 + 19.7 = 32.1 \text{ W} \quad (\text{per m length})$$

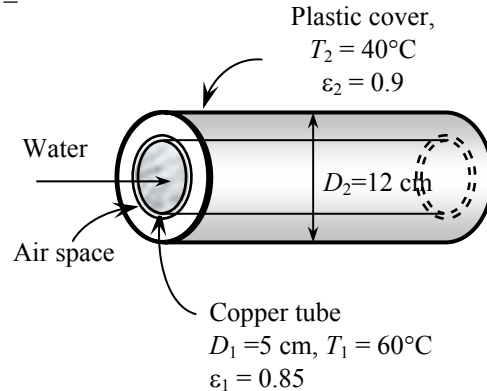

13-102 A cylindrical furnace with specified top and bottom surface temperatures and specified heat transfer rate at the bottom surface is considered. The temperature of the side surface and the net rates of heat transfer between the top and the bottom surfaces, and between the bottom and the side surfaces are to be determined.

Assumptions 1 Steady operating conditions exist 2 The surfaces are opaque, diffuse, and gray. 3 Convection heat transfer is not considered.

Properties The emissivities of the top, bottom, and side surfaces are 0.70, 0.50, and 0.40, respectively.

Analysis We consider the top surface to be surface 1, the bottom surface to be surface 2, and the side surface to be surface 3. This system is a three-surface enclosure. The view factor from surface 1 to surface 2 is determined from

$$\left. \begin{aligned} \frac{L}{r} = \frac{1.2}{0.6} = 2 \\ \frac{r}{L} = \frac{0.6}{1.2} = 0.5 \end{aligned} \right\} F_{12} = 0.17 \text{ (Fig. 13-7)} \quad h = 1.2 \text{ m}$$

The surface areas are

$$A_1 = A_2 = \pi D^2 / 4 = \pi(1.2 \text{ m})^2 / 4 = 1.131 \text{ m}^2$$

$$A_3 = \pi DL = \pi(1.2 \text{ m})(1.2 \text{ m}) = 4.524 \text{ m}^2$$

Then other view factors are determined to be

$$F_{12} = F_{21} = 0.17$$

$$F_{11} + F_{12} + F_{13} = 1 \longrightarrow 0 + 0.17 + F_{13} = 1 \longrightarrow F_{13} = 0.83 \text{ (summation rule), } F_{23} = F_{13} = 0.83$$

$$A_1 F_{13} = A_3 F_{31} \longrightarrow (1.131)(0.83) = (4.524)F_{31} \longrightarrow F_{31} = 0.21 \text{ (reciprocity rule), } F_{32} = F_{31} = 0.21$$

We now apply Eq. 13-35 to each surface

$$\sigma T_1^4 = J_1 + \frac{1 - \varepsilon_1}{\varepsilon_1} [F_{12}(J_1 - J_2) + F_{13}(J_1 - J_3)]$$

Surface 1:

$$(5.67 \times 10^{-8} \text{ W/m}^2 \cdot \text{K}^4)(500 \text{ K})^4 = J_1 + \frac{1 - 0.70}{0.70} [0.17(J_1 - J_2) + 0.83(J_1 - J_3)]$$

$$\sigma T_2^4 = J_2 + \frac{1 - \varepsilon_2}{\varepsilon_2} [F_{21}(J_2 - J_1) + F_{23}(J_2 - J_3)]$$

Surface 2:

$$(5.67 \times 10^{-8} \text{ W/m}^2 \cdot \text{K}^4)(500 \text{ K})^4 = J_2 + \frac{1 - 0.50}{0.50} [0.17(J_2 - J_1) + 0.83(J_2 - J_3)]$$

$$\sigma T_3^4 = J_3 + \frac{1 - \varepsilon_3}{\varepsilon_3} [F_{31}(J_3 - J_1) + F_{32}(J_3 - J_2)]$$

Surface 3:

$$(5.67 \times 10^{-8} \text{ W/m}^2 \cdot \text{K}^4)T_3^4 = J_3 + \frac{1 - 0.40}{0.40} [0.21(J_3 - J_1) + 0.21(J_3 - J_2)]$$

We now apply Eq. 13-34 to surface 2

$$\dot{Q}_2 = A_2 [F_{21}(J_2 - J_1) + F_{23}(J_2 - J_3)] = (1.131 \text{ m}^2)[0.17(J_2 - J_1) + 0.83(J_2 - J_3)]$$

Solving the above four equations, we find

$$T_3 = \mathbf{631 \text{ K}}, \quad J_1 = 4974 \text{ W/m}^2, \quad J_2 = 8883 \text{ W/m}^2, \quad J_3 = 8193 \text{ W/m}^2$$

The rate of heat transfer between the bottom and the top surface is

$$\dot{Q}_{21} = A_2 F_{21} (J_2 - J_1) = (1.131 \text{ m}^2)(0.17)(8883 - 4974) \text{ W/m}^2 = \mathbf{751.6 \text{ W}}$$

The rate of heat transfer between the bottom and the side surface is

$$\dot{Q}_{23} = A_2 F_{23} (J_2 - J_3) = (1.131 \text{ m}^2)(0.83)(8883 - 8193) \text{ W/m}^2 = \mathbf{648.0 \text{ W}}$$

Discussion The sum of these two heat transfer rates are $751.6 + 644 = 1395.6 \text{ W}$, which is practically equal to 1400 W heat supply rate from surface 2. This must be satisfied to maintain the surfaces at the specified temperatures under steady operation. Note that the difference is due to round-off error.

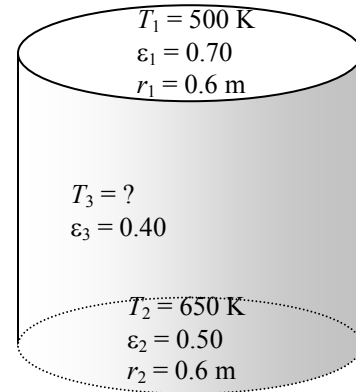

13-103 A cylindrical furnace with specified top and bottom surface temperatures and specified heat transfer rate at the bottom surface is considered. The emissivity of the top surface and the net rates of heat transfer between the top and the bottom surfaces, and between the bottom and the side surfaces are to be determined.

Assumptions 1 Steady operating conditions exist 2 The surfaces are opaque, diffuse, and gray. 3 Convection heat transfer is not considered.

Properties The emissivity of the bottom surface is 0.90.

Analysis We consider the top surface to be surface 1, the base surface to be surface 2, and the side surface to be surface 3. This system is a three-surface enclosure. The view factor from the base to the top surface of the cube is from Fig. 13-5 $F_{12} = 0.2$. The view factor from the base or the top to the side surfaces is determined by applying the summation rule to be

$$F_{11} + F_{12} + F_{13} = 1 \longrightarrow F_{13} = 1 - F_{12} = 1 - 0.2 = 0.8$$

since the base surface is flat and thus $F_{11} = 0$. Other view factors are

$$F_{21} = F_{12} = 0.20, \quad F_{23} = F_{13} = 0.80, \quad F_{31} = F_{32} = 0.20$$

We now apply Eq. 9-35 to each surface

$$\sigma T_1^4 = J_1 + \frac{1 - \varepsilon_1}{\varepsilon_1} [F_{12}(J_1 - J_2) + F_{13}(J_1 - J_3)]$$

Surface 1:

$$(5.67 \times 10^{-8} \text{ W/m}^2 \cdot \text{K}^4)(700 \text{ K})^4 = J_1 + \frac{1 - \varepsilon_1}{\varepsilon_1} [0.20(J_1 - J_2) + 0.80(J_1 - J_3)]$$

$$\sigma T_2^4 = J_2 + \frac{1 - \varepsilon_2}{\varepsilon_2} [F_{21}(J_2 - J_1) + F_{23}(J_2 - J_3)]$$

Surface 2:

$$(5.67 \times 10^{-8} \text{ W/m}^2 \cdot \text{K}^4)(950 \text{ K})^4 = J_2 + \frac{1 - 0.90}{0.90} [0.20(J_2 - J_1) + 0.80(J_2 - J_3)]$$

$$\sigma T_3^4 = J_3$$

Surface 3:

$$(5.67 \times 10^{-8} \text{ W/m}^2 \cdot \text{K}^4)(450 \text{ K})^4 = J_3$$

We now apply Eq. 9-34 to surface 2

$$\dot{Q}_2 = A_2 [F_{21}(J_2 - J_1) + F_{23}(J_2 - J_3)] = (9 \text{ m}^2) [0.20(J_2 - J_1) + 0.80(J_2 - J_3)]$$

Solving the above four equations, we find

$$\varepsilon_1 = \mathbf{0.44}, \quad J_1 = 11,736 \text{ W/m}^2, \quad J_2 = 41,985 \text{ W/m}^2, \quad J_3 = 2325 \text{ W/m}^2$$

The rate of heat transfer between the bottom and the top surface is

$$A_1 = A_2 = (3 \text{ m})^2 = 9 \text{ m}^2$$

$$\dot{Q}_{21} = A_2 F_{21} (J_2 - J_1) = (9 \text{ m}^2)(0.20)(41,985 - 11,736) \text{ W/m}^2 = \mathbf{54.4 \text{ kW}}$$

The rate of heat transfer between the bottom and the side surface is

$$A_3 = 4A_1 = 4(9 \text{ m}^2) = 36 \text{ m}^2$$

$$\dot{Q}_{23} = A_2 F_{23} (J_2 - J_3) = (9 \text{ m}^2)(0.8)(41,985 - 2325) \text{ W/m}^2 = \mathbf{285.6 \text{ kW}}$$

Discussion The sum of these two heat transfer rates are $54.4 + 285.6 = 340 \text{ kW}$, which is equal to 340 kW heat supply rate from surface 2.

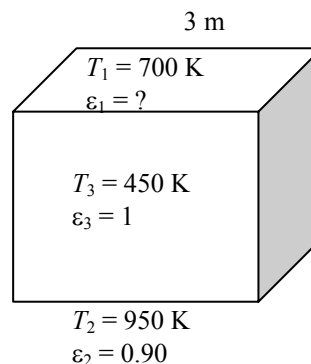

13-104 A thin aluminum sheet is placed between two very large parallel plates that are maintained at uniform temperatures. The net rate of radiation heat transfer between the plates and the temperature of the radiation shield are to be determined.

Assumptions 1 Steady operating conditions exist 2 The surfaces are opaque, diffuse, and gray. 3 Convection heat transfer is not considered.

Properties The emissivities of surfaces are given to be $\varepsilon_1 = 0.8$, $\varepsilon_2 = 0.7$, and $\varepsilon_3 = 0.12$.

Analysis The net rate of radiation heat transfer with a thin aluminum shield per unit area of the plates is

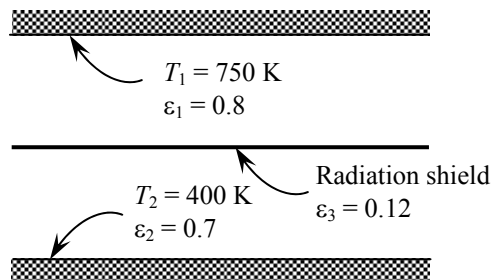

$$\begin{aligned}\dot{Q}_{12, \text{one shield}} &= \frac{\sigma(T_1^4 - T_2^4)}{\left(\frac{1}{\varepsilon_1} + \frac{1}{\varepsilon_2} - 1\right) + \left(\frac{1}{\varepsilon_{3,1}} + \frac{1}{\varepsilon_{3,2}} - 1\right)} \\ &= \frac{(5.67 \times 10^{-8} \text{ W/m}^2 \cdot \text{K}^4)[(750 \text{ K})^4 - (400 \text{ K})^4]}{\left(\frac{1}{0.8} + \frac{1}{0.7} - 1\right) + \left(\frac{1}{0.12} + \frac{1}{0.12} - 1\right)} \\ &= \mathbf{951 \text{ W/m}^2}\end{aligned}$$

The equilibrium temperature of the radiation shield is determined from

$$\dot{Q}_{13} = \frac{\sigma(T_1^4 - T_3^4)}{\left(\frac{1}{\varepsilon_1} + \frac{1}{\varepsilon_3} - 1\right)} \rightarrow 951 \text{ W/m}^2 = \frac{(5.67 \times 10^{-8} \text{ W/m}^2 \cdot \text{K}^4)[(750 \text{ K})^4 - T_3^4]}{\left(\frac{1}{0.8} + \frac{1}{0.12} - 1\right)} \rightarrow T_3 = \mathbf{644 \text{ K}}$$

13-105 Two thin radiation shields are placed between two large parallel plates that are maintained at uniform temperatures. The net rate of radiation heat transfer between the plates with and without the shields, and the temperatures of radiation shields are to be determined.

Assumptions 1 Steady operating conditions exist 2 The surfaces are opaque, diffuse, and gray. 3 Convection heat transfer is not considered.

Properties The emissivities of surfaces are given to be $\varepsilon_1 = 0.6$, $\varepsilon_2 = 0.7$, $\varepsilon_3 = 0.10$, and $\varepsilon_4 = 0.15$.

Analysis The net rate of radiation heat transfer without the shields per unit area of the plates is

$$\begin{aligned}\dot{Q}_{12,\text{no shield}} &= \frac{\sigma(T_1^4 - T_2^4)}{\frac{1}{\varepsilon_1} + \frac{1}{\varepsilon_2} - 1} \\ &= \frac{(5.67 \times 10^{-8} \text{ W/m}^2 \cdot \text{K}^4)[(600 \text{ K})^4 - (300 \text{ K})^4]}{\frac{1}{0.6} + \frac{1}{0.7} - 1} \\ &= \mathbf{3288 \text{ W/m}^2}\end{aligned}$$

The net rate of radiation heat transfer with two thin radiation shields per unit area of the plates is

$$\begin{aligned}\dot{Q}_{12,\text{two-shields}} &= \frac{\sigma(T_1^4 - T_2^4)}{\left(\frac{1}{\varepsilon_1} + \frac{1}{\varepsilon_2} - 1\right) + \left(\frac{1}{\varepsilon_3} + \frac{1}{\varepsilon_3} - 1\right) + \left(\frac{1}{\varepsilon_4} + \frac{1}{\varepsilon_4} - 1\right)} \\ &= \frac{(5.67 \times 10^{-8} \text{ W/m}^2 \cdot \text{K}^4)[(600 \text{ K})^4 - (300 \text{ K})^4]}{\left(\frac{1}{0.6} + \frac{1}{0.7} - 1\right) + \left(\frac{1}{0.10} + \frac{1}{0.10} - 1\right) + \left(\frac{1}{0.15} + \frac{1}{0.15} - 1\right)} \\ &= \mathbf{206 \text{ W/m}^2}\end{aligned}$$

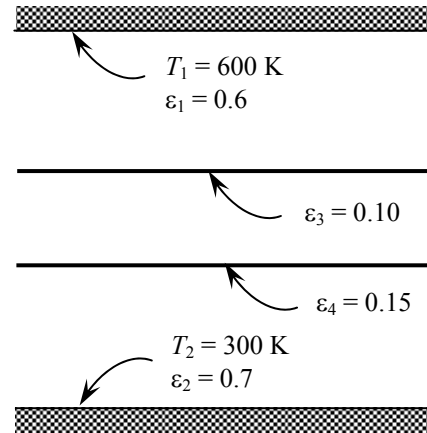

The equilibrium temperatures of the radiation shields are determined from

$$\begin{aligned}\dot{Q}_{13} &= \frac{\sigma(T_1^4 - T_3^4)}{\left(\frac{1}{\varepsilon_1} + \frac{1}{\varepsilon_3} - 1\right)} \rightarrow 206 \text{ W/m}^2 = \frac{(5.67 \times 10^{-8} \text{ W/m}^2 \cdot \text{K}^4)[(600 \text{ K})^4 - T_3^4]}{\left(\frac{1}{0.6} + \frac{1}{0.10} - 1\right)} \rightarrow T_3 = \mathbf{549 \text{ K}} \\ \dot{Q}_{42} &= \frac{\sigma(T_4^4 - T_2^4)}{\left(\frac{1}{\varepsilon_4} + \frac{1}{\varepsilon_2} - 1\right)} \rightarrow 206 \text{ W/m}^2 = \frac{(5.67 \times 10^{-8} \text{ W/m}^2 \cdot \text{K}^4)[T_4^4 - (300 \text{ K})^4]}{\left(\frac{1}{0.15} + \frac{1}{0.7} - 1\right)} \rightarrow T_4 = \mathbf{429 \text{ K}}\end{aligned}$$

13-106 Radiation heat transfer occurs between two square parallel plates. The view factors, the rate of radiation heat transfer and the temperature of a third plate to be inserted are to be determined.

Assumptions 1 Steady operating conditions exist 2 The surfaces are opaque, diffuse, and gray. 3 Convection heat transfer is not considered.

Properties The emissivities of plate a, b, and c are given to be $\varepsilon_a = 0.8$, $\varepsilon_b = 0.4$, and $\varepsilon_c = 0.1$, respectively.

Analysis (a) The view factor from surface a to surface b is determined as follows

$$A = \frac{a}{L} = \frac{20}{40} = 0.5, \quad B = \frac{b}{L} = \frac{60}{40} = 1.5$$

$$F_{ab} = \frac{1}{2A} \left\{ \left[(B+A)^2 + 4 \right]^{0.5} - \left[(B-A)^2 + 4 \right]^{0.5} \right\} = \frac{1}{2(0.5)} \left\{ \left[(1.5+0.5)^2 + 4 \right]^{0.5} - \left[(1.5-0.5)^2 + 4 \right]^{0.5} \right\} = \mathbf{0.592}$$

The view factor from surface b to surface a is determined from reciprocity relation:

$$A_a = (0.2 \text{ m})(0.2 \text{ m}) = 0.04 \text{ m}^2$$

$$A_b = (0.6 \text{ m})(0.6 \text{ m}) = 0.36 \text{ m}^2$$

$$A_a F_{ab} = A_b F_{ba}$$

$$(0.04)(0.592) = (0.36)F_{ba} \longrightarrow F_{ba} = \mathbf{0.0658}$$

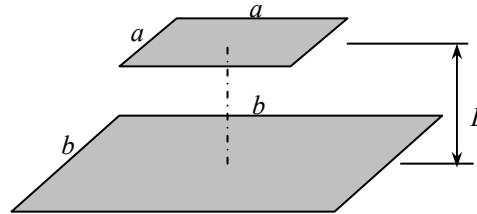

(b) The net rate of radiation heat transfer between the surfaces can be determined from

$$\dot{Q}_{ab} = \frac{\sigma(T_a^4 - T_b^4)}{\frac{1-\varepsilon_a}{A_a\varepsilon_a} + \frac{1}{A_a F_{ab}} + \frac{1-\varepsilon_b}{A_b\varepsilon_b}} = \frac{(5.67 \times 10^{-8} \text{ W/m}^2 \cdot \text{K}^4) [(1073 \text{ K})^4 - (473 \text{ K})^4]}{\frac{1-0.8}{(0.04 \text{ m}^2)(0.8)} + \frac{1}{(0.04 \text{ m}^2)(0.592)} + \frac{1-0.4}{(0.36 \text{ m}^2)(0.4)}} = \mathbf{1374 \text{ W}}$$

(c) In this case we have

$$A = \frac{a}{L} = \frac{0.2 \text{ m}}{0.2 \text{ m}} = 1, \quad C = \frac{c}{L} = \frac{2.0 \text{ m}}{0.2 \text{ m}} = 10$$

$$F_{ac} = \frac{1}{2A} \left\{ \left[(C+A)^2 + 4 \right]^{0.5} - \left[(C-A)^2 + 4 \right]^{0.5} \right\} = \frac{1}{2(0.5)} \left\{ \left[(10+0.5)^2 + 4 \right]^{0.5} - \left[(10-0.5)^2 + 4 \right]^{0.5} \right\} = 0.981$$

$$B = \frac{b}{L} = \frac{0.6 \text{ m}}{0.2 \text{ m}} = 3, \quad C = \frac{c}{L} = \frac{2.0 \text{ m}}{0.2 \text{ m}} = 10$$

$$F_{bc} = \frac{1}{2A} \left\{ \left[(C+B)^2 + 4 \right]^{0.5} - \left[(C-B)^2 + 4 \right]^{0.5} \right\}$$

$$= \frac{1}{2(3)} \left\{ \left[(10+3)^2 + 4 \right]^{0.5} - \left[(10-3)^2 + 4 \right]^{0.5} \right\} = 0.979$$

$$A_b F_{bc} = A_c F_{cb}$$

$$(0.36)(0.979) = (4.0)F_{cb} \longrightarrow F_{ba} = 0.0881$$

An energy balance gives

$$\dot{Q}_{ac} = \dot{Q}_{cb}$$

$$\frac{\sigma(T_a^4 - T_c^4)}{\frac{1-\varepsilon_a}{A_a\varepsilon_a} + \frac{1}{A_a F_{ac}} + \frac{1-\varepsilon_c}{A_c\varepsilon_c}} = \frac{\sigma(T_c^4 - T_b^4)}{\frac{1-\varepsilon_c}{A_c\varepsilon_c} + \frac{1}{A_c F_{cb}} + \frac{1-\varepsilon_b}{A_b\varepsilon_b}}$$

$$\frac{(1073 \text{ K})^4 - T_c^4}{\frac{1-0.8}{(0.04 \text{ m}^2)(0.8)} + \frac{1}{(0.04 \text{ m}^2)(0.981)} + \frac{1-0.1}{(4 \text{ m}^2)(0.1)}} = \frac{T_c^4 - (473 \text{ K})^4}{\frac{1-0.1}{(4 \text{ m}^2)(0.1)} + \frac{1}{(4 \text{ m}^2)(0.0881)} + \frac{1-0.4}{(0.36 \text{ m}^2)(0.4)}}$$

Solving the equation with an equation solver such as EES, we obtain $T_c = 754 \text{ K} = \mathbf{481^\circ\text{C}}$

13-107 Radiation heat transfer occurs between two concentric disks. The view factors and the net rate of radiation heat transfer for two cases are to be determined.

Assumptions 1 Steady operating conditions exist 2 The surfaces are opaque, diffuse, and gray. 3 Convection heat transfer is not considered.

Properties The emissivities of disk 1 and 2 are given to be $\varepsilon_a = 0.6$ and $\varepsilon_b = 0.8$, respectively.

Analysis (a) The view factor from surface 1 to surface 2 is determined using Fig. 13-7 as

$$\frac{L}{r_1} = \frac{0.10}{0.20} = 0.5, \quad \frac{r_2}{L} = \frac{0.10}{0.10} = 1 \longrightarrow F_{12} = \mathbf{0.19}$$

Using reciprocity rule,

$$A_1 = \pi(0.2 \text{ m})^2 = 0.1257 \text{ m}^2$$

$$A_2 = \pi(0.1 \text{ m})^2 = 0.0314 \text{ m}^2$$

$$F_{21} = \frac{A_1}{A_2} F_{12} = \frac{0.1257 \text{ m}^2}{0.0314 \text{ m}^2} (0.19) = \mathbf{0.76}$$

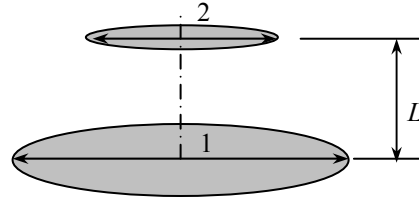

(b) The net rate of radiation heat transfer between the surfaces can be determined from

$$\dot{Q} = \frac{\sigma(T_1^4 - T_2^4)}{\frac{1-\varepsilon_1}{A_1\varepsilon_1} + \frac{1}{A_1F_{12}} + \frac{1-\varepsilon_2}{A_2\varepsilon_2}} = \frac{(5.67 \times 10^{-8} \text{ W/m}^2 \cdot \text{K}^4) [(1073 \text{ K})^4 - (573 \text{ K})^4]}{\frac{1-0.6}{(0.1257 \text{ m}^2)(0.6)} + \frac{1}{(0.1257 \text{ m}^2)(0.19)} + \frac{1-0.8}{(0.0314 \text{ m}^2)(0.8)}} = \mathbf{1250 \text{ W}}$$

(c) When the space between the disks is completely surrounded by a refractory surface, the net rate of radiation heat transfer can be determined from

$$\begin{aligned} \dot{Q} &= \frac{A_1 \sigma (T_1^4 - T_2^4)}{\frac{A_1 + A_2 - 2A_1F_{12}}{A_2 - A_1F_{12}^2} + \left(\frac{1}{\varepsilon_1} - 1\right) + \frac{A_1}{A_2} \left(\frac{1}{\varepsilon_2} - 1\right)} \\ &= \frac{(0.1257 \text{ m}^2)(5.67 \times 10^{-8} \text{ W/m}^2 \cdot \text{K}^4) [(1073 \text{ K})^4 - (573 \text{ K})^4]}{\frac{0.1257 + 0.0314 - 2(0.1257)(0.19)}{0.0314 - (0.1257)(0.19)^2} + \left(\frac{1}{0.6} - 1\right) + \frac{0.1257}{0.0314} \left(\frac{1}{0.8} - 1\right)} = \mathbf{1510 \text{ W}} \end{aligned}$$

Discussion The rate of heat transfer in part (c) is 21 percent higher than that in part (b).

13-108 Combustion gases flow inside a tube in a boiler. The rates of heat transfer by convection and radiation and the rate of evaporation of water are to be determined.

Assumptions 1 Steady operating conditions exist. 2 The inner surfaces of the duct are smooth. 3 Combustion gases are assumed to have the properties of air, which is an ideal gas with constant properties.

Properties The properties of air at 1200 K = 927°C and 1 atm are (Table A-15)

$$\rho = 0.2944 \text{ kg/m}^3$$

$$k = 0.07574 \text{ W/m}\cdot\text{°C}$$

$$\nu = 1.586 \times 10^{-4} \text{ m}^2/\text{s}$$

$$c_p = 1173 \text{ J/kg}\cdot\text{°C}$$

$$\text{Pr} = 0.7221$$

Analysis (a) The Reynolds number is

$$\text{Re} = \frac{V_{\text{avg}} D}{\nu} = \frac{(3 \text{ m/s})(0.15 \text{ m})}{1.586 \times 10^{-4} \text{ m}^2/\text{s}} = 2837$$

which is a little higher than 2300, and thus we assume laminar flow. The Nusselt number in this case is

$$\text{Nu} = \frac{hD_h}{k} = 3.66$$

Heat transfer coefficient is

$$h = \frac{k}{D} \text{Nu} = \frac{0.07574 \text{ W/m}\cdot\text{°C}}{0.15 \text{ m}} (3.66) = 1.848 \text{ W/m}^2\cdot\text{°C}$$

Next we determine the exit temperature of air

$$A = \pi DL = \pi(0.15 \text{ m})(6 \text{ m}) = 2.827 \text{ m}^2$$

$$A_c = \pi D^2 / 4 = \pi(0.15 \text{ m})^2 / 4 = 0.01767 \text{ m}^2$$

$$\dot{m} = \rho V A_c = (0.2944 \text{ kg/m}^3)(3 \text{ m/s})(0.01767 \text{ m}^2) = 0.01561 \text{ kg/s}$$

$$T_e = T_s - (T_s - T_i) e^{-hA/(\dot{m}c_p)} = 105 - (105 - 927) e^{-\frac{(1.848)(2.827)}{(0.01561)(1173)}} = 723.0^\circ\text{C}$$

Then the rate of heat transfer by convection becomes

$$\dot{Q}_{\text{conv}} = \dot{m} c_p (T_i - T_e) = (0.01561 \text{ kg/s})(1173 \text{ J/kg}\cdot\text{°C})(927 - 723)^\circ\text{C} = \mathbf{3735 \text{ W}}$$

Next, we determine the emissivity of combustion gases. First, the mean beam length for an infinite circular cylinder is, from Table 13-4,

$$L = 0.95(0.15 \text{ m}) = 0.1425 \text{ m}$$

Then,

$$P_c L = (0.08 \text{ atm})(0.1425 \text{ m}) = 0.0114 \text{ m}\cdot\text{atm} = 0.037 \text{ ft}\cdot\text{atm}$$

$$P_w L = (0.16 \text{ atm})(0.1425 \text{ m}) = 0.0228 \text{ m}\cdot\text{atm} = 0.075 \text{ ft}\cdot\text{atm}$$

The emissivities of CO₂ and H₂O corresponding to these values at the average gas temperature of $T_g = (T_s + T_e)/2 = (927 + 723)/2 = 825^\circ\text{C} = 1098 \text{ K}$ and 1 atm are, from Fig. 13-36,

$$\varepsilon_{c,1\text{atm}} = 0.055 \quad \text{and} \quad \varepsilon_{w,1\text{atm}} = 0.045$$

Both CO₂ and H₂O are present in the same mixture, and we need to correct for the overlap of emission bands. The emissivity correction factor at $T = T_g = 1100 \text{ K}$ is, from Fig. 13-38,

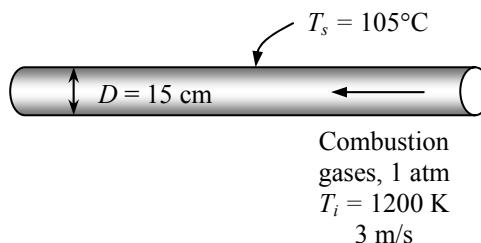

$$\left. \begin{aligned} P_c L + P_w L &= 0.037 + 0.075 = 0.112 \\ \frac{P_w}{P_w + P_c} &= \frac{0.16}{0.16 + 0.08} = 0.67 \end{aligned} \right\} \Delta \varepsilon = 0.0$$

Then the effective emissivity of the combustion gases becomes

$$\varepsilon_g = C_c \varepsilon_{c,1 \text{ atm}} + C_w \varepsilon_{w,1 \text{ atm}} - \Delta \varepsilon = 1 \times 0.055 + 1 \times 0.045 - 0.0 = 0.100$$

Note that the pressure correction factor is 1 for both gases since the total pressure is 1 atm. For a source temperature of $T_s = 105^\circ\text{C} = 378 \text{ K}$, the absorptivity of the gas is again determined using the emissivity charts as follows:

$$P_c L \frac{T_s}{T_g} = (0.08 \text{ atm})(0.1425 \text{ m}) \frac{378 \text{ K}}{1098 \text{ K}} = 0.00392 \text{ m} \cdot \text{atm} = 0.013 \text{ ft} \cdot \text{atm}$$

$$P_w L \frac{T_s}{T_g} = (0.16 \text{ atm})(0.1425 \text{ m}) \frac{378 \text{ K}}{1098 \text{ K}} = 0.00785 \text{ m} \cdot \text{atm} = 0.026 \text{ ft} \cdot \text{atm}$$

The emissivities of CO_2 and H_2O corresponding to these values at a temperature of $T_s = 378 \text{ K}$ and 1 atm are, from Fig. 13-36,

$$\varepsilon_{c,1 \text{ atm}} = 0.032 \quad \text{and} \quad \varepsilon_{w,1 \text{ atm}} = 0.049$$

Then the absorptivities of CO_2 and H_2O become

$$\alpha_c = C_c \left(\frac{T_g}{T_s} \right)^{0.65} \quad \varepsilon_{c,1 \text{ atm}} = (1) \left(\frac{1098 \text{ K}}{378 \text{ K}} \right)^{0.65} (0.032) = 0.0640$$

$$\alpha_w = C_w \left(\frac{T_g}{T_s} \right)^{0.45} \quad \varepsilon_{w,1 \text{ atm}} = (1) \left(\frac{1098 \text{ K}}{378 \text{ K}} \right)^{0.45} (0.049) = 0.0792$$

Also $\Delta \alpha = \Delta \varepsilon$, but the emissivity correction factor is to be evaluated from Fig. 13-38 at $T = T_s = 378 \text{ K}$ instead of $T_g = 1098 \text{ K}$. We use the chart for 400 K. At $P_w/(P_w + P_c) = 0.67$ and $P_c L + P_w L = 0.112$ we read $\Delta \varepsilon = 0.0$. Then the absorptivity of the combustion gases becomes

$$\alpha_g = \alpha_c + \alpha_w - \Delta \alpha = 0.0640 + 0.0792 - 0.0 = 0.143$$

The emissivity of the inner surfaces of the tubes is 0.9. Then the net rate of radiation heat transfer from the combustion gases to the walls of the tube becomes

$$\begin{aligned} \dot{Q}_{\text{rad}} &= \frac{\varepsilon_s + 1}{2} A_s \sigma (\varepsilon_g T_g^4 - \alpha_g T_s^4) \\ &= \frac{0.9 + 1}{2} (2.827 \text{ m}^2) (5.67 \times 10^{-8} \text{ W/m}^2 \cdot \text{K}^4) [0.100(1098 \text{ K})^4 - 0.143(378 \text{ K})^4] \\ &= \mathbf{21,690 \text{ W}} \end{aligned}$$

(b) The heat of vaporization of water at 1 atm is 2257 kJ/kg (Table A-9). Then rate of evaporation of water becomes

$$\dot{Q}_{\text{conv}} + \dot{Q}_{\text{rad}} = \dot{m}_{\text{evap}} h_{fg} \longrightarrow \dot{m}_{\text{evap}} = \frac{\dot{Q}_{\text{conv}} + \dot{Q}_{\text{rad}}}{h_{fg}} = \frac{(3735 + 21,690) \text{ W}}{2257 \times 10^3 \text{ J/kg}} = \mathbf{0.0113 \text{ kg/s}}$$

13-109 Combustion gases flow inside a tube in a boiler. The rates of heat transfer by convection and radiation and the rate of evaporation of water are to be determined.

Assumptions 1 Steady operating conditions exist. 2 The inner surfaces of the duct are smooth. 3 Combustion gases are assumed to have the properties of air, which is an ideal gas with constant properties.

Properties The properties of air at 1200 K = 927°C and 3 atm are (Table A-15)

$$\rho = 0.2944 \text{ kg/m}^3$$

$$k = 0.07574 \text{ W/m}\cdot\text{°C}$$

$$\nu = (1.586 \times 10^{-4} \text{ m}^2/\text{s})/3 = 0.5287 \times 10^{-4} \text{ m}^2/\text{s}$$

$$c_p = 1173 \text{ J/kg}\cdot\text{°C}$$

$$\text{Pr} = 0.7221$$

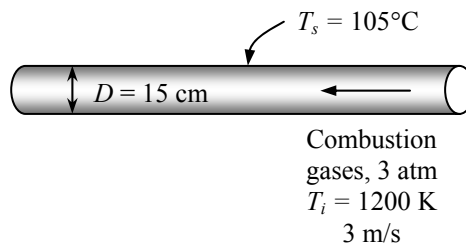

Analysis (a) The Reynolds number is

$$\text{Re} = \frac{V_{\text{avg}} D}{\nu} = \frac{(3 \text{ m/s})(0.15 \text{ m})}{0.5287 \times 10^{-4} \text{ m}^2/\text{s}} = 8511$$

which is greater than 2300 and close to 10,000. We assume the flow to be turbulent. The entry lengths in this case are roughly

$$L_h \approx L_t \approx 10D = 10(0.15 \text{ m}) = 1.5 \text{ m}$$

which is much shorter than the total length of the duct. Therefore, we can assume fully developed turbulent flow in the entire duct, and determine the Nusselt number from

$$\text{Nu} = \frac{hD_h}{k} = 0.023 \text{ Re}^{0.8} \text{ Pr}^{0.3} = 0.023(8511)^{0.8} (0.7221)^{0.3} = 29.06$$

Heat transfer coefficient is

$$h = \frac{k}{D} \text{Nu} = \frac{0.07574 \text{ W/m}\cdot\text{°C}}{0.15 \text{ m}} (29.06) = 14.67 \text{ W/m}^2\cdot\text{°C}$$

Next we determine the exit temperature of air

$$A = \pi DL = \pi(0.15 \text{ m})(6 \text{ m}) = 2.827 \text{ m}^2$$

$$A_c = \pi D^2 / 4 = \pi(0.15 \text{ m})^2 / 4 = 0.01767 \text{ m}^2$$

$$\dot{m} = \rho V A_c = (0.2944 \text{ kg/m}^3)(3 \text{ m/s})(0.01767 \text{ m}^2) = 0.01561 \text{ kg/s}$$

$$T_e = T_s - (T_s - T_i) e^{-hA/(\dot{m}c_p)} = 105 - (105 - 927) e^{-\frac{(14.67)(2.827)}{(0.01561)(1173)}} = 190.4^\circ\text{C}$$

Then the rate of heat transfer by convection becomes

$$\dot{Q}_{\text{conv}} = \dot{m} c_p (T_i - T_e) = (0.01561 \text{ kg/s})(1173 \text{ J/kg}\cdot\text{°C})(927 - 190.4)^\circ\text{C} = \mathbf{13,490 \text{ W}}$$

Next, we determine the emissivity of combustion gases. First, the mean beam length for an infinite circular cylinder is, from Table 13-4,

$$L = 0.95(0.15 \text{ m}) = 0.1425 \text{ m}$$

$$P_c L = (0.08 \text{ atm})(0.1425 \text{ m}) = 0.0114 \text{ m}\cdot\text{atm} = 0.037 \text{ ft}\cdot\text{atm}$$

Then,

$$P_w L = (0.16 \text{ atm})(0.1425 \text{ m}) = 0.0228 \text{ m}\cdot\text{atm} = 0.075 \text{ ft}\cdot\text{atm}$$

The emissivities of CO₂ and H₂O corresponding to these values at the average gas temperature of $T_g = (T_s + T_e)/2 = (927 + 190)/2 = 559^\circ\text{C} = 832 \text{ K}$ and 1 atm are, from Fig. 13-36,

$$\varepsilon_{c,1\text{atm}} = 0.055 \quad \text{and} \quad \varepsilon_{w,1\text{atm}} = 0.062$$

These are the base emissivity values at 1 atm, and they need to be corrected for the 3 atm total pressure. Noting that $(P_w+P)/2 = (0.16+3)/2 = 1.58$ atm, the pressure correction factors are, from Fig. 13-37,

$$C_c = 1.5 \quad \text{and} \quad C_w = 1.8$$

Both CO_2 and H_2O are present in the same mixture, and we need to correct for the overlap of emission bands. The emissivity correction factor at $T = T_g = 832$ K is, from Fig. 13-38,

$$\left. \begin{aligned} P_c L + P_w L &= 0.037 + 0.075 = 0.112 \\ \frac{P_w}{P_w + P_c} &= \frac{0.16}{0.16 + 0.08} = 0.67 \end{aligned} \right\} \Delta \varepsilon = 0.0$$

Then the effective emissivity of the combustion gases becomes

$$\varepsilon_g = C_c \varepsilon_{c,1\text{atm}} + C_w \varepsilon_{w,1\text{atm}} - \Delta \varepsilon = 1.5 \times 0.055 + 1.8 \times 0.062 - 0.0 = 0.194$$

For a source temperature of $T_s = 105^\circ\text{C} = 378$ K, the absorptivity of the gas is again determined using the emissivity charts as follows:

$$P_c L \frac{T_s}{T_g} = (0.08 \text{ atm})(0.1425 \text{ m}) \frac{378 \text{ K}}{832 \text{ K}} = 0.00518 \text{ m} \cdot \text{atm} = 0.017 \text{ ft} \cdot \text{atm}$$

$$P_w L \frac{T_s}{T_g} = (0.16 \text{ atm})(0.1425 \text{ m}) \frac{378 \text{ K}}{832 \text{ K}} = 0.0104 \text{ m} \cdot \text{atm} = 0.034 \text{ ft} \cdot \text{atm}$$

The emissivities of CO_2 and H_2O corresponding to these values at a temperature of $T_s = 378$ K and 1 atm are, from Fig. 13-36,

$$\varepsilon_{c,1\text{atm}} = 0.037 \quad \text{and} \quad \varepsilon_{w,1\text{atm}} = 0.062$$

Then the absorptivities of CO_2 and H_2O become

$$\alpha_c = C_c \left(\frac{T_g}{T_s} \right)^{0.65} \varepsilon_{c,1\text{atm}} = (1.5) \left(\frac{832 \text{ K}}{378 \text{ K}} \right)^{0.65} (0.037) = 0.0927$$

$$\alpha_w = C_w \left(\frac{T_g}{T_s} \right)^{0.45} \varepsilon_{w,1\text{atm}} = (1.8) \left(\frac{832 \text{ K}}{378 \text{ K}} \right)^{0.45} (0.062) = 0.1592$$

Also $\Delta \alpha = \Delta \varepsilon$, but the emissivity correction factor is to be evaluated from Fig. 13-38 at $T = T_s = 378$ K instead of $T_g = 832$ K. We use the chart for 400 K. At $P_w/(P_w + P_c) = 0.67$ and $P_c L + P_w L = 0.112$ we read $\Delta \varepsilon = 0.0$. Then the absorptivity of the combustion gases becomes

$$\alpha_g = \alpha_c + \alpha_w - \Delta \alpha = 0.0927 + 0.1592 - 0.0 = 0.252$$

The emissivity of the inner surfaces of the tubes is 0.9. Then the net rate of radiation heat transfer from the combustion gases to the walls of the tube becomes

$$\begin{aligned} \dot{Q}_{\text{rad}} &= \frac{\varepsilon_s + 1}{2} A_s \sigma (\varepsilon_g T_g^4 - \alpha_g T_s^4) \\ &= \frac{0.9 + 1}{2} (2.827 \text{ m}^2) (5.67 \times 10^{-8} \text{ W/m}^2 \cdot \text{K}^4) [0.194(832 \text{ K})^4 - 0.252(378 \text{ K})^4] \\ &= \mathbf{13,370 \text{ W}} \end{aligned}$$

(b) The heat of vaporization of water at 1 atm is 2257 kJ/kg (Table A-9). Then rate of evaporation of water becomes

$$\dot{Q}_{\text{conv}} + \dot{Q}_{\text{rad}} = \dot{m}_{\text{evap}} h_{fg} \longrightarrow \dot{m}_{\text{evap}} = \frac{\dot{Q}_{\text{conv}} + \dot{Q}_{\text{rad}}}{h_{fg}} = \frac{(13,490 + 13,370) \text{ W}}{2257 \times 10^3 \text{ J/kg}} = \mathbf{0.0119 \text{ kg/s}}$$

Fundamentals of Engineering (FE) Exam Problems

13-110 Consider two concentric spheres with diameters 12 cm and 18 cm, forming an enclosure. The view factor from the inner surface of the outer sphere to the inner sphere is

- (a) 0 (b) 0.18 (c) 0.44 (d) 0.56 (e) 0.67

Answer (c) 0.44

Solution Solved by EES Software. Solutions can be verified by copying-and-pasting the following lines on a blank EES screen.

```
D1=0.12 [m]
D2=0.18 [m]
A1=pi*D1^2
A2=pi*D2^2
F_12=1
A1*F_12=A2*F_21 "Reciprocity relation"
```

"Some Wrong Solutions with Common Mistakes"

```
W1_F_21=F_12 "Using F_12 as the answer"
D1*F_12=D2*W2_F_21 "Using diameters instead of areas"
W3_F_21=1-F_21 "Evaluation of F_22"
```

13-111 Consider an infinitely long three-sided enclosure with side lengths 2 cm, 3 cm, and 4 cm. The view factor from the 2 cm side to the 4 cm side is

- (a) 0.25 (b) 0.50 (c) 0.64 (d) 0.75 (e) 0.87

Answer (d) 0.75

Solution Solved by EES Software. Solutions can be verified by copying-and-pasting the following lines on a blank EES screen.

```
w1=2 [cm]
w2=3 [cm]
w3=4 [cm]
F_13=(w1+w3-w2)/(2*w1) "from Table 12-2"
```

"Some Wrong Solutions with Common Mistakes"

```
W_F_13=(w1+w2-w3)/(2*w1) "Using incorrect form of the equation"
```

13-112 Consider a 15-cm-diameter sphere placed within a cubical enclosure with a side length of 15 cm. The view factor from any of the square cube surface to the sphere is

- (a) 0.09 (b) 0.26 (c) 0.52 (d) 0.78 (e) 1

Answer (c) 0.52

Solution Solved by EES Software. Solutions can be verified by copying-and-pasting the following lines on a blank EES screen.

```
D=0.15 [m]
s=0.15 [m]
A1=pi*D^2
A2=6*s^2
F_12=1
A1*F_12=A2*F_21 "Reciprocity relation"
"Some Wrong Solutions with Common Mistakes"
W_F_21=F_21/6 "Dividing the result by 6"
```

13-113 The number of view factors that need to be evaluated directly for a 10-surface enclosure is

- (a) 1 (b) 10 (c) 22 (d) 34 (e) 45

Answer (e) 45

Solution Solved by EES Software. Solutions can be verified by copying-and-pasting the following lines on a blank EES screen.

```
N=10
n_viewfactors=1/2*N*(N-1)
```

13-114 A 70-cm-diameter flat black disk is placed in the center of the top surface of a 1 m × 1 m × 1 m black box. The view factor from the entire interior surface of the box to the interior surface of the disk is

- (a) 0.077 (b) 0.144 (c) 0.356 (d) 0.220 (e) 1.0

Answer (a) 0.077

Solution Solved by EES Software. Solutions can be verified by copying-and-pasting the following lines on a blank EES screen.

```
d=0.7 [m]
A1=pi*d^2/4 [m^2]
A2=5*1*1 [m^2]
F12=1
F21=A1*F12/A2
```

13-115 Consider two concentric spheres forming an enclosure with diameters 12 and 18 cm and surface temperatures 300 and 500 K, respectively. Assuming that the surfaces are black, the net radiation exchange between the two spheres is

- (a) 21 W (b) 140 W (c) 160 W (d) 1275 W (e) 3084 W

Answer (b) 140 W

Solution Solved by EES Software. Solutions can be verified by copying-and-pasting the following lines on a blank EES screen.

```
D1=0.12 [m]
D2=0.18 [m]
T1=300 [K]
T2=500 [K]
sigma=5.67E-8 [W/m^2-K^4]
A1=pi*D1^2
F_12=1
Q_dot=A1*F_12*sigma*(T2^4-T1^4)
```

"Some Wrong Solutions with Common Mistakes"

```
W1_Q_dot=F_12*sigma*(T2^4-T1^4) "Ignoring surface area"
W2_Q_dot=A1*F_12*sigma*T1^4 "Emissive power of inner surface"
W3_Q_dot=A1*F_12*sigma*T2^4 "Emissive power of outer surface"
```

13-116 The base surface of a cubical furnace with a side length of 3 m has an emissivity of 0.80 and is maintained at 500 K. If the top and side surfaces also have an emissivity of 0.80 and are maintained at 900 K, the net rate of radiation heat transfer from the top and side surfaces to the bottom surface is

- (a) 194 kW (b) 233 kW (c) 288 kW (d) 312 kW (e) 242 kW

Answer (b) 233 kW

Solution Solved by EES Software. Solutions can be verified by copying-and-pasting the following lines on a blank EES screen.

```
Sigma=5.67
T1=500
T2=900
A1=3*3
A2=5*A1
Eps1=0.8
Eps2=0.8
F12=1
Q=sigma*((T1/100)^4-(T2/100)^4)/(((1-Eps1)/(A1*Eps1)+1/(A1*F12)+(1-Eps2)/(A2*Eps2)))
```

"Some Wrong Solutions with Common Mistakes:"

```
W1_Q=A1*Eps1*sigma*((T1/100)^4-(T2/100)^4)
```

13-117 Consider a vertical 2-m-diameter cylindrical furnace whose surfaces closely approximate black surfaces. The base, top, and side surfaces of the furnace are maintained at 400 K, 600 K, and 900 K, respectively. If the view factor from the base surface to the top surface is 0.2, the net radiation heat transfer between the base and the side surfaces is

- (a) 22.5 kW (b) 38.6 kW (c) 60.7 kW (d) 89.8 kW (e) 151 kW

Answer (d) 89.8 kW

Solution Solved by EES Software. Solutions can be verified by copying-and-pasting the following lines on a blank EES screen.

```
D=2 [m]
T1=400 [K]
T2=600 [K]
T3=900 [K]
F_12=0.2
A1=pi*D^2/4
A2=A1
F_13=1-F_12
sigma=5.67E-8 [W/m^2-K^4]
Q_dot_13=A1*F_13*sigma*(T1^4-T3^4)
"Some Wrong Solutions with Common Mistakes"
W_Q_dot_13=A1*F_12*sigma*(T1^4-T3^4) "Using the view factor between the base and top surfaces"
```

13-118 Consider a vertical 2-m-diameter cylindrical furnace whose surfaces closely approximate black surfaces. The base, top, and side surfaces of the furnace are maintained at 400 K, 600 K, and 900 K, respectively. If the view factor from the base surface to the top surface is 0.2, the net radiation heat transfer from the bottom surface is

- (a) -93.6 kW (b) -86.1 kW (c) 0 kW (d) 86.1 kW (e) 93.6 kW

Answer (a) -93.6 kW

Solution Solved by EES Software. Solutions can be verified by copying-and-pasting the following lines on a blank EES screen.

```
D=2 [m]
T1=400 [K]
T2=600 [K]
T3=900 [K]
A1=pi*D^2/4
A2=A1
F_12=0.2
F_13=1-F_12
sigma=5.67E-8 [W/m^2-K^4]
Q_dot_12=A1*F_13*sigma*(T1^4-T2^4)
Q_dot_13=A1*F_13*sigma*(T1^4-T3^4)
Q_dot_1=Q_dot_12+Q_dot_13
"Some Wrong Solutions with Common Mistakes"
W1_Q_dot_1=-Q_dot_1 "Using wrong sign"
W2_Q_dot_1=Q_dot_12-Q_dot_13 "Subtracting heat transfer terms"
W3_Q_dot_1=Q_dot_13-Q_dot_12 "Subtracting heat transfer terms"
```

- 13-119** Consider a surface at 0°C that may be assumed to be a blackbody in an environment at 25°C. If 300 W/m² radiation is incident on the surface, the radiosity of this black surface is
 (a) 0 W/m² (b) 15 W/m² (c) 132 W/m² (d) 300 W/m² (e) 315 W/m²

Answer (e) 315 W/m²

Solution Solved by EES Software. Solutions can be verified by copying-and-pasting the following lines on a blank EES screen.

```
T=0 [C]
T_infinity=25 [C]
G=300 [W/m^2]
sigma=5.67E-8 [W/m^2-K^4]
J=sigma*(T+273)^4 "J=E_b for a blackbody"
```

"Some Wrong Solutions with Common Mistakes"

```
W1_J=sigma*T^4 "Using C unit for temperature"
W2_J=sigma*((T_infinity+273)^4-(T+273)^4) "Finding radiation exchange between the surface
and the environment"
W3_J=G "Using the incident radiation as the answer"
W4_J=J-G "Finding the difference between the emissive power and incident radiation"
```

- 13-120** Consider a gray and opaque surface at 0°C in an environment at 25°C. The surface has an emissivity of 0.8. If 300 W/m² radiation is incident on the surface, the radiosity of the surface is
 (a) 60 W/m² (b) 132 W/m² (c) 300 W/m² (d) 312 W/m² (e) 315 W/m²

Answer (d) 312 W/m²

Solution Solved by EES Software. Solutions can be verified by copying-and-pasting the following lines on a blank EES screen.

```
T=0 [C]
T_infinity=25 [C]
epsilon=0.80
G=300 [W/m^2]
sigma=5.67E-8 [W/m^2-K^4]
J=epsilon*sigma*(T+273)^4+(1-epsilon)*G
```

"Some Wrong Solutions with Common Mistakes"

```
W1_J=sigma*(T+273)^4 "Radiosity for a black surface"
W2_J=epsilon*sigma*T^4+(1-epsilon)*G "Using C unit for temperature"
W3_J=sigma*((T_infinity+273)^4-(T+273)^4) "Finding radiation exchange between the surface
and the environment"
W4_J=G "Using the incident radiation as the answer"
```

- 13-121** Consider a two-surface enclosure with $T_1 = 550$ K, $A_1 = 0.25$ m², $\epsilon_1 = 0.65$, $T_2 = 350$ K, $A_2 = 0.40$ m², $\epsilon_2 = 1$. If the view factor F_{21} is 0.55, the net rate of radiation heat transfer between the surfaces is
 (a) 460 W (b) 539 W (c) 648 W (d) 772 W (e) 828 W

Answer (c) 648 W

Solution Solved by EES Software. Solutions can be verified by copying-and-pasting the following lines on a blank EES screen.

```
T1=550 [K]
A1=0.25 [m^2]
epsilon_1=0.65
T2=350 [K]
A2=0.40 [m^2]
epsilon_2=1
F_21=0.55
sigma=5.67E-8 [W/m^2-K^4]
Q_dot_12=(sigma*(T1^4-T2^4))/((1-epsilon_1)/(A1*epsilon_1)+1/(A2*F_21))
"Some Wrong Solutions with Common Mistakes"
W1_Q_dot_12=(sigma*(T1^4-T2^4))/((1-epsilon_1)/(A1*epsilon_1)+1/(A1*F_21)) "Using A1*F_21
in the relation"
W2_Q_dot_12=(sigma*(T1^4-T2^4))/((1-epsilon_1)/(A1*epsilon_1)+1/(A2*F_21)+(1-
epsilon_1)/(A2*epsilon_1)) "Using surface resistance of surface 2"
```

- 13-122** Consider two infinitely long concentric cylinders with diameters 20 and 25 cm. The inner surface is maintained at 700 K and has an emissivity of 0.40 while the outer surface is black. If the rate of radiation heat transfer from the inner surface to the outer surface is 2400 W per unit area of the inner surface, the temperature of the outer surface is

- (a) 605 K (b) 538 K (c) 517 K (d) 451 K (e) 415 K

Answer (a) 605 K

Solution Solved by EES Software. Solutions can be verified by copying-and-pasting the following lines on a blank EES screen.

```
D1=0.20 [m]
D2=0.25 [m]
T1=700 [K]
epsilon_1=0.40
epsilon_2=1
Q_dot_12=2400 [W/m^2]
sigma=5.67E-8 [W/m^2-K^4]
Q_dot_12=epsilon_1*sigma*(T1^4-T2^4)
"Some Wrong Solutions with Common Mistakes"
Q_dot_12=(sigma*(T1^4-W1_T2^4))/((1/epsilon_1)+(1-epsilon_1)/epsilon_1*D1/D2) "Incorrect
equation"
A1=pi*D1*1[m] "Finding the area for a unit length of the inner cylinder"
Q_dot_12=A1*epsilon_1*sigma*(T1^4-W2_T2^4)
```

13-123 Two concentric spheres are maintained at uniform temperatures $T_1 = 45^\circ\text{C}$ and $T_2 = 280^\circ\text{C}$ and have emissivities $\varepsilon_1 = 0.25$ and $\varepsilon_2 = 0.7$, respectively. If the ratio of the diameters is $D_1/D_2 = 0.30$, the net rate of radiation heat transfer between the two spheres per unit surface area of the inner sphere is

- (a) 86 W/m² (b) 1169 W/m² (c) 1181 W/m² (d) 2510 W/m² (e) 3306 W/m²

Answer (b) 1169 W/m²

Solution Solved by EES Software. Solutions can be verified by copying-and-pasting the following lines on a blank EES screen.

```
T1=45 [C]
T2=280 [C]
epsilon_1=0.25
epsilon_2=0.70
D1\D2=0.30
sigma=5.67E-8 [W/m^2-K^4]
Q_dot=((sigma*(T2+273)^4-(T1+273)^4))/((1/epsilon_1)+(1-epsilon_2)/epsilon_2*D1\D2^2)
"Some Wrong Solutions with Common Mistakes"
W1_Q_dot=((sigma*(T2^4-T1^4))/((1/epsilon_1)+(1-epsilon_2)/epsilon_2*D1\D2^2)) "Using C
unit for temperature"
W2_Q_dot=epsilon_1*sigma*((T2+273)^4-(T1+273)^4) "The equation when the outer sphere is
black"
W3_Q_dot=epsilon_2*sigma*((T2+273)^4-(T1+273)^4) "The equation when the inner sphere is
black"
```

13-124 Consider a 3-m × 3-m × 3-m cubical furnace. The base surface of the furnace is black and has a temperature of 400 K. The radiosities for the top and side surfaces are calculated to be 7500 W/m² and 3200 W/m², respectively. The net rate of radiation heat transfer to the bottom surface is

- (a) 2.61 kW (b) 8.27 kW (c) 14.7 kW (d) 23.5 kW (e) 141 kW

Answer (d) 23.5 kW

Solution Solved by EES Software. Solutions can be verified by copying-and-pasting the following lines on a blank EES screen.

```
s=3 [m]
T1=400 [K]
epsilon_1=1
J2=7500 [W/m^2]
J3=3200 [W/m^2]
sigma=5.67E-8 [W/m^2-K^4]
A1=s^2
F_12=0.2
F_13=0.8
J1=sigma*T1^4
Q_dot_1=A1*(F_12*(J1-J2)+F_13*(J1-J3))
"Some Wrong Solutions with Common Mistakes"
W1_Q_dot_1=(F_12*(J1-J2)+F_13*(J1-J3)) "Not multiplying with area"
W2_A1=6*s^2 "Using total area"
W2_Q_dot_1=W2_A1*(F_12*(J1-J2)+F_13*(J1-J3))
```

13-125 Consider a 3-m \times 3-m \times 3-m cubical furnace. The base surface is black and has a temperature of 400 K. The radiosities for the top and side surfaces are calculated to be 7500 W/m² and 3200 W/m², respectively. If the temperature of the side surfaces is 485 K, the emissivity of the side surfaces is
 (a) 0.37 (b) 0.55 (c) 0.63 (d) 0.80 (e) 0.89

Answer (e) 0.89

Solution Solved by EES Software. Solutions can be verified by copying-and-pasting the following lines on a blank EES screen.

```
s=3 [m]
T1=400 [K]
epsilon_1=1
J2=7500 [W/m^2]
J3=3200 [W/m^2]
T3=485 [K]
sigma=5.67E-8 [W/m^2-K^4]
F_31=0.2
F_32=F_31
J1=sigma*T1^4
sigma*T3^4=J3+(1-epsilon_3)/epsilon_3*(F_31*(J3-J1)+F_32*(J3-J2))
```

13-126 Two very large parallel plates are maintained at uniform temperatures $T_1 = 750$ K and $T_2 = 500$ K and have emissivities $\epsilon_1 = 0.85$ and $\epsilon_2 = 0.7$, respectively. If a thin aluminum sheet with the same emissivity on both sides is to be placed between the plates in order to reduce the net rate of radiation heat transfer between the plates by 90 percent, the emissivity of the aluminum sheet must be

(a) 0.07 (b) 0.10 (c) 0.13 (d) 0.16 (e) 0.19

Answer (c) 0.13

Solution Solved by EES Software. Solutions can be verified by copying-and-pasting the following lines on a blank EES screen.

```
T1=750 [K]
T2=500 [K]
epsilon_1=0.85
epsilon_2=0.70
f=0.9
sigma=5.67E-8 [W/m^2-K^4]
Q_dot_noshield=(sigma*(T1^4-T2^4))/((1/epsilon_1)+(1/epsilon_2)-1)
Q_dot_1shield=(1-f)*Q_dot_noshield
Q_dot_1shield=(sigma*(T1^4-T2^4))/((1/epsilon_1)+(1/epsilon_2)-1+(1/epsilon_3)+(1/epsilon_3)-1)
```

13-127 A 70-cm-diameter flat black disk is placed in the center of the top surface of a $1\text{ m} \times 1\text{ m} \times 1\text{ m}$ black box. If the temperature of the box is 427°C and the temperature of the disk is 27°C , the rate of heat transfer by radiation between the interior of the box and the disk is

- (a) 2 kW (b) 3 kW (c) 4 kW (d) 5 kW (e) 6 kW

Answer (d) 5 kW

Solution Solved by EES Software. Solutions can be verified by copying-and-pasting the following lines on a blank EES screen.

```
d=0.7 [m]
A1=pi*d^2/4 [m^2]
A2=5*1*1 [m^2]
F12=1
T2=700 [K]
T1=300 [K]
F21=A1*F12/A2
Q=A2*F21*sigma#*(T2^4-T1^4)
```

13-128 A 70-cm-diameter flat disk is placed in the center of the top of a $1\text{ m} \times 1\text{ m} \times 1\text{ m}$ black box. If the temperature of the box is 427°C , the temperature of the disk is 27°C , and the emissivity of the interior surface of the disk is 0.3, the rate of heat transfer by radiation between the interior of the box and the disk is

- (a) 1.0 kW (b) 1.5 kW (c) 2.0 kW (d) 2.5 kW (e) 3.2 kW

Answer (b) 1.5 kW

Solution Solved by EES Software. Solutions can be verified by copying-and-pasting the following lines on a blank EES screen.

```
d=0.7 [m]
A1=pi*d^2/4 [m^2]
A2=5*1*1 [m^2]
F12=1
T2=700 [K]
T1=300 [K]
e1=0.3
F21=A1*F12/A2
Q=sigma#*(T2^4-T1^4)/((1/(A2*F21))+(1-e1)/(A1*e1))
```

13-129 Two grey surfaces that form an enclosure exchange heat with one another by thermal radiation. Surface 1 has a temperature of 400 K, an area of 0.2 m², and a total emissivity of 0.4. Surface 2 has a temperature of 600 K, an area of 0.3 m², and a total emissivity of 0.6. If the view factor F_{12} is 0.3, the rate of radiation heat transfer between the two surfaces is

- (a) 135 W (b) 223 W (c) 296 W (d) 342 W (e) 422 W

Answer (b) 223 W

Solution Solved by EES Software. Solutions can be verified by copying-and-pasting the following lines on a blank EES screen.

```
A1=0.2 [m^2]
T1=400 [K]
e1=0.4
A2=0.3 [m^2]
T2=600 [K]
e2=0.6
F12=0.3
R1=(1-e1)/(A1*e1)
R2=1/(A1*F12)
R3=(1-e2)/(A2*e2)
Q=sigma#*(T2^4-T1^4)/(R1+R2+R3)
```

13-130 The surfaces of a two-surface enclosure exchange heat with one another by thermal radiation. Surface 1 has a temperature of 400 K, an area of 0.2 m², and a total emissivity of 0.4. Surface 2 is black, has a temperature of 600 K, and an area of 0.3 m². If the view factor F_{12} is 0.3, the rate of radiation heat transfer between the two surfaces is

- (a) 87 W (b) 135 W (c) 244 W (d) 342 W (e) 386 W

Answer (c) 244 W

Solution Solved by EES Software. Solutions can be verified by copying-and-pasting the following lines on a blank EES screen.

```
A1=0.2 [m^2]
T1=400 [K]
e1=0.4
A2=0.3 [m^2]
T2=600 [K]
F12=0.3
R1=(1-e1)/(A1*e1)
R2=1/(A1*F12)
Q=sigma#*(T2^4-T1^4)/(R1+R2)
```

13-131 A solar flux of 1400 W/m^2 directly strikes a space vehicle surface which has a solar absorptivity of 0.4 and thermal emissivity of 0.6. The equilibrium temperature of this surface in space at 0 K is
(a) 300 K (b) 360 K (c) 410 K (d) 467 K (e) 510 K

Answer (b) 360 K

Solution Solved by EES Software. Solutions can be verified by copying-and-pasting the following lines on a blank EES screen.

```
a=0.4
e=0.6
Q=1400 [W/m^2]
a*Q=e*sigma#*T^4
```

13-132 13-134 Design and Essay Problems



Chapter 14

MASS TRANSFER

Mass Transfer and Analogy between Heat and Mass Transfer

14-1C *Bulk fluid flow* refers to the transportation of a fluid on a macroscopic level from one location to another in a flow section by a mover such as a fan or a pump. *Mass flow* requires the presence of two regions at different chemical compositions, and it refers to the movement of a chemical species from a high concentration region towards a lower concentration one relative to the other chemical species present in the medium. Mass transfer cannot occur in a homogeneous medium.

14-2C The *concentration* of a commodity is defined as the amount of that commodity per unit volume. The *concentration gradient* dC/dx is defined as the change in the concentration C of a commodity per unit length in the direction of flow x . The *diffusion rate* of the commodity is expressed as

$$\dot{Q} = -k_{\text{diff}} A \frac{dC}{dx}$$

where A is the area normal to the direction of flow and k_{diff} is the *diffusion coefficient* of the medium, which is a measure of how fast a commodity diffuses in the medium.

14-3C Examples of different kinds of diffusion processes:

- (a) *Liquid-to-gas*: A gallon of gasoline left in an open area will eventually evaporate and diffuse into air.
- (b) *Solid-to-liquid*: A spoon of sugar in a cup of tea will eventually dissolve and move up.
- (c) *Solid-to gas*: A moth ball left in a closet will sublime and diffuse into the air.
- (d) *Gas-to-liquid*: Air dissolves in water.

14-4C Although heat and mass can be converted to each other, there is no such a thing as “mass radiation”, and mass transfer cannot be studied using the laws of radiation transfer. Mass transfer is analogous to conduction, but it is not analogous to radiation.

14-5C (a) *Temperature difference* is the driving force for heat transfer, (b) *voltage difference* is the driving force for electric current flow, and (c) *concentration difference* is the driving force for mass transfer.

14-6C (a) *Homogenous reactions* in mass transfer represent the generation of a species within the medium. Such reactions are analogous to internal heat generation in heat transfer. (b) *Heterogeneous reactions* in mass transfer represent the generation of a species at the surface as a result of chemical reactions occurring at the surface. Such reactions are analogous to specified surface heat flux in heat transfer.

Mass Diffusion

14-7C In the relation $\dot{Q} = -kA(dT/dx)$, the quantities \dot{Q} , k , A , and T represent the following in heat conduction and mass diffusion:

\dot{Q} = Rate of heat transfer in heat conduction, and rate of mass transfer in mass diffusion.

k = Thermal conductivity in heat conduction, and mass diffusivity in mass diffusion.

A = Area normal to the direction of flow in both heat and mass transfer.

T = Temperature in heat conduction, and concentration in mass diffusion.

14-8C (a) T (b) F (c) F (d) T (e) F

14-9C (a) T (b) F (c) F (d) T (e) T

14-10C In the Fick's law of diffusion relations expressed as $\dot{m}_{\text{diff,A}} = -\rho AD_{AB} \frac{dw_A}{dx}$ and

$\dot{N}_{\text{diff,A}} = -CAD_{AB} \frac{dy_A}{dx}$, the diffusion coefficients D_{AB} are the same.

14-11C The mass diffusivity of a gas mixture (a) increases with increasing temperature and (a) decreases with increasing pressure.

14-12C In a binary ideal gas mixture of species A and B, the diffusion coefficient of A in B is equal to the diffusion coefficient of B in A. Therefore, the mass diffusivity of air in water vapor will be equal to the mass diffusivity of water vapor in air since the air and water vapor mixture can be treated as ideal gases.

14-13C Solids, in general, have different diffusivities in each other. At a given temperature and pressure, the mass diffusivity of copper in aluminum will not be the equal to the mass diffusivity of aluminum in copper.

14-14C We would carry out the hardening process of steel by carbon at high temperature since mass diffusivity increases with temperature, and thus the hardening process will be completed in a short time.

14-15C The molecular weights of CO_2 and N_2O gases are the same (both are 44). Therefore, the mass and mole fractions of each of these two gases in a gas mixture will be the same.

14-16 The maximum mass fraction of calcium bicarbonate in water at 350 K is to be determined.

Assumptions The small amounts of gases in air are ignored, and dry air is assumed to consist of N₂ and O₂ only.

Properties The solubility of [Ca(HCO₃)₂] in 100 kg of water at 350 K is 17.88 kg (Table 14-5).

Analysis The maximum mass fraction is determined from

$$w_{(\text{CaHCO}_3)_2} = \frac{m_{(\text{CaHCO}_3)_2}}{m_{\text{total}}} = \frac{m_{(\text{CaHCO}_3)_2}}{m_{(\text{CaHCO}_3)_2} + m_w} = \frac{17.88 \text{ kg}}{(17.88 + 100) \text{ kg}} = \mathbf{0.152}$$

14-17 The molar fractions of the constituents of moist air are given. The mass fractions of the constituents are to be determined.

Assumptions The small amounts of gases in air are ignored, and dry air is assumed to consist of N₂ and O₂ only.

Properties The molar masses of N₂, O₂, and H₂O are 28.0, 32.0, and 18.0 kg/kmol, respectively (Table A-1)

Analysis The molar mass of moist air is determined to be

$$M = \sum y_i M_i = 0.78 \times 28.0 + 0.20 \times 32.0 + 0.02 \times 18 = 28.6 \text{ kg/kmol}$$

Then the mass fractions of constituent gases are determined from Eq. 14-10 to be

$$\text{N}_2 : \quad w_{\text{N}_2} = y_{\text{N}_2} \frac{M_{\text{N}_2}}{M} = (0.78) \frac{28.0}{28.6} = \mathbf{0.764}$$

$$\text{O}_2 : \quad w_{\text{O}_2} = y_{\text{O}_2} \frac{M_{\text{O}_2}}{M} = (0.20) \frac{32.0}{28.6} = \mathbf{0.224}$$

$$\text{H}_2\text{O} : \quad w_{\text{H}_2\text{O}} = y_{\text{H}_2\text{O}} \frac{M_{\text{H}_2\text{O}}}{M} = (0.02) \frac{18.0}{28.6} = \mathbf{0.012}$$

<p>Moist air 78% N₂ 20% O₂ 2% H₂O (Mole fractions)</p>

Therefore, the mass fractions of N₂, O₂, and H₂O in dry air are 76.4%, 22.4%, and 1.2%, respectively.

14-18E The masses of the constituents of a gas mixture are given. The mass fractions, mole fractions, and the molar mass of the mixture are to be determined.

Assumptions None.

Properties The molar masses of N_2 , O_2 , and CO_2 are 28, 32, and 44 lbm/lbmol, respectively (Table A-1E)

Analysis (a) The total mass of the gas mixture is determined to be

$$m = \sum m_i = m_{O_2} + m_{N_2} + m_{CO_2} = 7 + 8 + 10 = 25 \text{ lbm}$$

Then the mass fractions of constituent gases are determined to be

$$N_2 : \quad w_{N_2} = \frac{m_{N_2}}{m} = \frac{8}{25} = \mathbf{0.32}$$

$$O_2 : \quad w_{O_2} = \frac{m_{O_2}}{m} = \frac{7}{25} = \mathbf{0.28}$$

$$CO_2 : \quad w_{CO_2} = \frac{m_{CO_2}}{m} = \frac{10}{25} = \mathbf{0.40}$$

<p>7 lbm O_2 8 lbm N_2 10 lbm CO_2</p>

(b) To find the mole fractions, we need to determine the mole numbers of each component first,

$$N_2 : \quad N_{N_2} = \frac{m_{N_2}}{M_{N_2}} = \frac{8 \text{ lbm}}{28 \text{ lbm/lbmol}} = \mathbf{0.286 \text{ lbmol}}$$

$$O_2 : \quad N_{O_2} = \frac{m_{O_2}}{M_{O_2}} = \frac{7 \text{ lbm}}{32 \text{ lbm/lbmol}} = \mathbf{0.219 \text{ lbmol}}$$

$$CO_2 : \quad N_{CO_2} = \frac{m_{CO_2}}{M_{CO_2}} = \frac{10 \text{ lbm}}{44 \text{ lbm/lbmol}} = \mathbf{0.227 \text{ lbmol}}$$

Thus,

$$N_m = \sum N_i = N_{N_2} + N_{O_2} + N_{CO_2} = 0.286 + 0.219 + 0.227 = 0.732 \text{ lbmol}$$

Then the mole fraction of gases are determined to be

$$N_2 : \quad y_{N_2} = \frac{N_{N_2}}{N_m} = \frac{0.286}{0.732} = \mathbf{0.391}$$

$$O_2 : \quad y_{O_2} = \frac{N_{O_2}}{N_m} = \frac{0.219}{0.732} = \mathbf{0.299}$$

$$CO_2 : \quad y_{CO_2} = \frac{N_{CO_2}}{N_m} = \frac{0.227}{0.732} = \mathbf{0.310}$$

(c) The molar mass of the mixture is determined from

$$M = \frac{m_m}{N_m} = \frac{25 \text{ lbm}}{0.732 \text{ lbmol}} = \mathbf{34.2 \text{ lbm/lbmol}}$$

14-19 The mole fractions of the constituents of a gas mixture are given. The mass of each gas and apparent gas constant of the mixture are to be determined.

Assumptions None.

Properties The molar masses of H_2 and N_2 are 2.0 and 28.0 kg/kmol, respectively (Table A-1)

Analysis The mass of each gas is

$$H_2 : m_{H_2} = N_{H_2} M_{H_2} = (8 \text{ kmol}) \times (2 \text{ kg/kmol}) = \mathbf{16 \text{ kg}}$$

$$N_2 : m_{N_2} = N_{N_2} M_{N_2} = 2 \text{ kmol} \times (28 \text{ kg/kmol}) = \mathbf{56 \text{ kg}}$$

The molar mass of the mixture and its apparent gas constant are determined to be

$$M = \frac{m_m}{N_m} = \frac{16 + 56 \text{ kg}}{8 + 2 \text{ kmol}} = 7.2 \text{ kg/kmol}$$

$$R = \frac{R_u}{M} = \frac{8.314 \text{ kJ/kmol} \cdot \text{K}}{7.2 \text{ kg/kmol}} = \mathbf{1.15 \text{ kJ/kg} \cdot \text{K}}$$

8 kmol H_2 2 kmol N_2

14-20 The mole numbers of the constituents of a gas mixture at a specified pressure and temperature are given. The mass fractions and the partial pressures of the constituents are to be determined.

Assumptions The gases behave as ideal gases.

Properties The molar masses of N_2 , O_2 and CO_2 are 28, 32, and 44 kg/kmol, respectively (Table A-1)

Analysis When the mole fractions of a gas mixture are known, the mass fractions can be determined from

$$w_i = \frac{m_i}{m_m} = \frac{N_i M_i}{N_m M_m} = y_i \frac{M_i}{M_m}$$

The apparent molar mass of the mixture is

$$M = \sum y_i M_i = 0.65 \times 28.0 + 0.20 \times 32.0 + 0.15 \times 44.0 = 31.2 \text{ kg/kmol}$$

Then the mass fractions of the gases are determined from

$$N_2 : w_{N_2} = y_{N_2} \frac{M_{N_2}}{M} = (0.65) \frac{28.0}{31.2} = \mathbf{0.583} \text{ (or 58.3\%)}$$

$$O_2 : w_{O_2} = y_{O_2} \frac{M_{O_2}}{M} = (0.20) \frac{32.0}{31.2} = \mathbf{0.205} \text{ (or 20.5\%)}$$

$$CO_2 : w_{CO_2} = y_{CO_2} \frac{M_{CO_2}}{M} = (0.15) \frac{44}{31.2} = \mathbf{0.212} \text{ (or 21.2\%)}$$

Noting that the total pressure of the mixture is 250 kPa and the pressure fractions in an ideal gas mixture are equal to the mole fractions, the partial pressures of the individual gases become

$$P_{N_2} = y_{N_2} P = (0.65)(250 \text{ kPa}) = 162.5 \text{ kPa}$$

$$P_{O_2} = y_{O_2} P = (0.20)(250 \text{ kPa}) = \mathbf{50 \text{ kPa}}$$

$$P_{CO_2} = y_{CO_2} P = (0.15)(250 \text{ kPa}) = \mathbf{37.5 \text{ kPa}}$$

65% N_2 20% O_2 15% CO_2 290 K 250 kPa
--

14-21 The binary diffusion coefficients of CO₂ in air at various temperatures and pressures are to be determined.

Assumptions The mixture is sufficiently dilute so that the diffusion coefficient is independent of mixture composition.

Properties The binary diffusion coefficients of CO₂ in air at 1 atm pressure are given in Table 14-1 to be 0.74×10^{-5} , 2.63×10^{-5} , and 5.37×10^{-5} m²/s at temperatures of 200 K, 400 K, and 600 K, respectively.

Analysis Noting that the binary diffusion coefficients of gases are inversely proportional to pressure, the diffusion coefficients at given pressures are determined from

$$D_{AB}(T, P) = D_{AB}(T, 1 \text{ atm}) / P$$

where P is in atm.

(a) At 200 K and 1 atm: $D_{AB}(200 \text{ K}, 1 \text{ atm}) = \mathbf{0.74 \times 10^{-5} \text{ m}^2/\text{s}}$ (since $P = 1 \text{ atm}$).

(b) At 400 K and 0.5 atm: $D_{AB}(400 \text{ K}, 0.5 \text{ atm}) = D_{AB}(400 \text{ K}, 1 \text{ atm})/0.5 = (2.63 \times 10^{-5})/0.5 = \mathbf{5.26 \times 10^{-5} \text{ m}^2/\text{s}}$

(c) At 600 K and 5 atm: $D_{AB}(600 \text{ K}, 5 \text{ atm}) = D_{AB}(600 \text{ K}, 1 \text{ atm})/5 = (5.37 \times 10^{-5})/5 = \mathbf{1.07 \times 10^{-5} \text{ m}^2/\text{s}}$

14-22 The binary diffusion coefficient of O₂ in N₂ at various temperature and pressures are to be determined.

Assumptions The mixture is sufficiently dilute so that the diffusion coefficient is independent of mixture composition.

Properties The binary diffusion coefficient of O₂ in N₂ at $T_1 = 273 \text{ K}$ and $P_1 = 1 \text{ atm}$ is given in Table 14-2 to be 1.8×10^{-5} m²/s.

Analysis Noting that the binary diffusion coefficient of gases is proportional to 3/2 power of temperature and inversely proportional to pressure, the diffusion coefficients at other pressures and temperatures can be determined from

$$\frac{D_{AB,1}}{D_{AB,2}} = \frac{P_2}{P_1} \left(\frac{T_1}{T_2} \right)^{3/2} \rightarrow D_{AB,2} = D_{AB,1} \frac{P_1}{P_2} \left(\frac{T_2}{T_1} \right)^{3/2}$$

(a) At 200 K and 1 atm: $D_{AB,2} = (1.8 \times 10^{-5} \text{ m}^2/\text{s}) \frac{1 \text{ atm}}{1 \text{ atm}} \left(\frac{200 \text{ K}}{273 \text{ K}} \right)^{3/2} = \mathbf{1.13 \times 10^{-5} \text{ m}^2/\text{s}}$

(b) At 400 K and 0.5 atm: $D_{AB,2} = (1.8 \times 10^{-5} \text{ m}^2/\text{s}) \frac{1 \text{ atm}}{0.5 \text{ atm}} \left(\frac{400 \text{ K}}{273 \text{ K}} \right)^{3/2} = \mathbf{6.38 \times 10^{-5} \text{ m}^2/\text{s}}$

(c) At 600 K and 5 atm: $D_{AB,2} = (1.8 \times 10^{-5} \text{ m}^2/\text{s}) \frac{1 \text{ atm}}{5 \text{ atm}} \left(\frac{600 \text{ K}}{273 \text{ K}} \right)^{3/2} = \mathbf{1.17 \times 10^{-5} \text{ m}^2/\text{s}}$

14-23E The error involved in assuming the density of air to remain constant during a humidification process is to be determined.

Properties The density of moist air before and after the humidification process is determined from the psychrometric chart to be

$$\left. \begin{array}{l} T_1 = 80^\circ \text{F} \\ \phi_1 = 30\% \end{array} \right\} \rho_{air,1} = 0.0727 \text{ lbm/ft}^3 \quad \text{and} \quad \left. \begin{array}{l} T_1 = 80^\circ \text{F} \\ \phi_1 = 90\% \end{array} \right\} \rho_{air,2} = 0.07117 \text{ lbm/ft}^3$$

Analysis The error involved as a result of assuming constant air density is then determined to be

$$\% \text{Error} = \frac{\Delta \rho_{air}}{\rho_{air,1}} \times 100 = \frac{0.0727 - 0.07117 \text{ lbm/ft}^3}{0.0727 \text{ lbm/ft}^3} \times 100 = \mathbf{2.1\%}$$

which is acceptable for most engineering purposes.

Air 80°F 14.7 psia RH ₁ =30% RH ₂ =90%
--

14-24 The diffusion coefficient of hydrogen in steel is given as a function of temperature. The diffusion coefficients at various temperatures are to be determined.

Analysis The diffusion coefficient of hydrogen in steel between 200 K and 1200 K is given as

$$D_{AB} = 1.65 \times 10^{-6} \exp(-4630/T) \quad \text{m}^2/\text{s}$$

Using this relation, the diffusion coefficients at various temperatures are determined to be

$$200 \text{ K: } D_{AB} = 1.65 \times 10^{-6} \exp(-4630/200) = 1.46 \times 10^{-16} \text{ m}^2/\text{s}$$

$$500 \text{ K: } D_{AB} = 1.65 \times 10^{-6} \exp(-4630/500) = 1.57 \times 10^{-10} \text{ m}^2/\text{s}$$

$$1000 \text{ K: } D_{AB} = 1.65 \times 10^{-6} \exp(-4630/1000) = 1.61 \times 10^{-8} \text{ m}^2/\text{s}$$

$$1500 \text{ K: } D_{AB} = 1.65 \times 10^{-6} \exp(-4630/1500) = 7.53 \times 10^{-8} \text{ m}^2/\text{s}$$

14-25 EES Prob. 14-24 is reconsidered. The diffusion coefficient as a function of the temperature is to be plotted.

Analysis The problem is solved using EES, and the solution is given below.

"GIVEN"

"The diffusion coefficient of hydrogen in steel as a function of temperature is given"

"ANALYSIS"

$$D_{AB}=1.65E-6*\exp(-4630/T)$$

T [K]	D _{AB} [m ² /s]
200	1.457E-16
250	1.494E-14
300	3.272E-13
350	2.967E-12
400	1.551E-11
450	5.611E-11
500	1.570E-10
550	3.643E-10
600	7.348E-10
650	1.330E-09
700	2.213E-09
750	3.439E-09
800	5.058E-09
850	7.110E-09
900	9.622E-09
950	1.261E-08
1000	1.610E-08
1050	2.007E-08
1100	2.452E-08
1150	2.944E-08
1200	3.482E-08

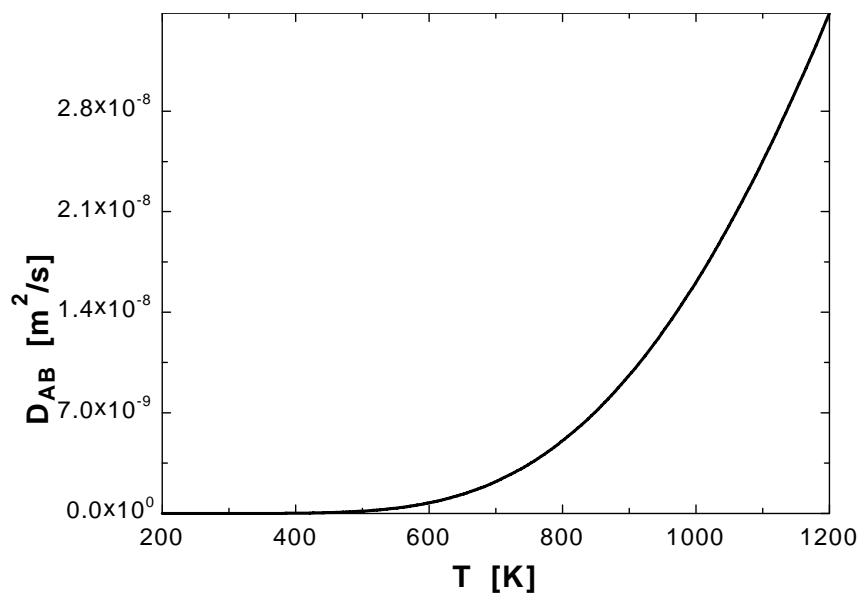

Boundary Conditions

14-26C Three boundary conditions for mass transfer (on mass basis) that correspond to specified temperature, specified heat flux, and convection boundary conditions in heat transfer are expressed as follows:

- 1) $w(0) = w_0$ (specified concentration - corresponds to specified temperature)
- 2) $-\rho D_{AB} \left. \frac{dw_A}{dx} \right|_{x=0} = J_{A,0}$ (specified mass flux - corresponds to specified heat flux)
- 3) $j_{A,s} = -D_{AB} \left. \frac{\partial w_A}{\partial x} \right|_{x=0} = h_{\text{mass}} (w_{A,s} - w_{A,\infty})$ (mass convection - corresponds to heat convection)

14-27C An impermeable surface is a surface that does not allow any mass to pass through. Mathematically it is expressed (at $x = 0$) as

$$\left. \frac{dw_A}{dx} \right|_{x=0} = 0$$

An impermeable surface in mass transfer corresponds to an insulated surface in heat transfer.

14-28C Temperature is necessarily a *continuous* function, but concentration, in general, is not. Therefore, the mole fraction of water vapor in air will, in general, be different from the mole fraction of water in the lake (which is nearly 1).

14-29C When prescribing a boundary condition for mass transfer at a solid-gas interface, we need to specify the side of the surface (whether the solid or the gas side). This is because concentration, in general, is not a continuous function, and there may be large differences in concentrations on the gas and solid sides of the boundary. We did not do this in heat transfer because temperature is a continuous function.

14-30C The mole fraction of the water vapor at the surface of a lake when the temperature of the lake surface and the atmospheric pressure are specified can be determined from

$$y_{\text{vapor}} = \frac{P_{\text{vapor}}}{P} = \frac{P_{\text{sat@T}}}{P_{\text{atm}}}$$

where P_{vapor} is equal to the saturation pressure of water at the lake surface temperature.

14-31C Using solubility data of a solid in a specified liquid, the mass fraction w of the solid A in the liquid at the interface at a specified temperature can be determined from

$$w_A = \frac{m_{\text{solid}}}{m_{\text{solid}} + m_{\text{liquid}}}$$

where m_{solid} is the maximum amount of solid dissolved in the liquid of mass m_{liquid} at the specified temperature.

14-32C The molar concentration C_i of the gas species i in the solid at the interface $C_{i, \text{solid side}}(0)$ is proportional to the *partial pressure* of the species i in the gas $P_{i, \text{gas side}}(0)$ on the gas side of the interface, and is determined from

$$C_{i, \text{solid side}}(0) = S \times P_{i, \text{gas side}}(0) \quad (\text{kmol/m}^3)$$

where S is the *solubility* of the gas in that solid at the specified temperature.

14-33C Using Henry's constant data for a gas dissolved in a liquid, the mole fraction of the gas dissolved in the liquid at the interface at a specified temperature can be determined from Henry's law expressed as

$$y_{i, \text{liquid side}}(0) = \frac{P_{i, \text{gas side}}(0)}{H}$$

where H is *Henry's constant* and $P_{i, \text{gas side}}(0)$ is the partial pressure of the gas i at the gas side of the interface. This relation is applicable for dilute solutions (gases that are weakly soluble in liquids).

14-34C The permeability is a measure of the ability of a gas to penetrate a solid. The permeability of a gas in a solid, P , is related to the solubility of the gas by $P = SD_{AB}$ where D_{AB} is the diffusivity of the gas in the solid.

14-35 The mole fraction of CO_2 dissolved in water at the surface of water at 300 K is to be determined.

Assumptions 1 Both the CO_2 and water vapor are ideal gases. **2** Air at the lake surface is saturated.

Properties The saturation pressure of water at 300 K = 27°C is 3.60 kPa (Table A-9). The Henry's constant for CO_2 in water at 300 K is 1710 bar (Table 14-6).

Analysis The air at the water surface will be saturated. Therefore, the partial pressure of water vapor in the air at the lake surface will simply be the saturation pressure of water at 27°C,

$$P_{\text{vapor}} = P_{\text{sat}@27^\circ\text{C}} = 3.60 \text{ kPa}$$

Assuming both the air and vapor to be ideal gases, the partial pressure and mole fraction of dry air in the air at the surface of the lake are determined to be

$$P_{\text{dry air}} = P - P_{\text{vapor}} = 100 - 3.60 = 96.4 \text{ kPa}$$

The partial pressure of CO_2 is

$$P_{\text{CO}_2} = y_{\text{CO}_2} P_{\text{dry air}} = (0.005)(96.4) = 0.482 \text{ kPa} = 0.00482 \text{ bar}$$

$$y_{\text{CO}_2} = \frac{P_{\text{CO}_2}}{H} = \frac{0.00482 \text{ bar}}{1710 \text{ bar}} = \mathbf{2.82 \times 10^{-6}}$$

14-36E The mole fraction of the water vapor at the surface of a lake and the mole fraction of water in the lake are to be determined and compared.

Assumptions 1 Both the air and water vapor are ideal gases. **2** Air is weakly soluble in water and thus Henry's law is applicable.

Properties The saturation pressure of water at 70°F is 0.3632 psia (Table A-9E). Henry's constant for air dissolved in water at 70°F (294 K) is given in Table 14-6 to be $H = 66,800$ bar.

Analysis The air at the water surface will be saturated. Therefore, the partial pressure of water vapor in the air at the lake surface will simply be the saturation pressure of water at 70°F,

$$P_{\text{vapor}} = P_{\text{sat}@70^\circ\text{F}} = 0.3632 \text{ psia}$$

Assuming both the air and vapor to be ideal gases, the mole fraction of water vapor in the air at the surface of the lake is determined from Eq. 14-11 to be

$$y_{\text{vapor}} = \frac{P_{\text{vapor}}}{P} = \frac{0.3632 \text{ psia}}{13.8 \text{ psia}} = \mathbf{0.0263 \text{ (or 2.63 percent)}}$$

The partial pressure of dry air just above the lake surface is

$$P_{\text{dry air}} = P - P_{\text{vapor}} = 13.8 - 0.3632 = 13.44 \text{ psia}$$

Then the mole fraction of air in the water becomes

$$y_{\text{dry air, liquid side}} = \frac{P_{\text{dry air, gasside}}}{H} = \frac{13.44 \text{ psia} (1 \text{ atm} / 14.696 \text{ psia})}{66,800 \text{ bar} (1 \text{ atm} / 1.01325 \text{ bar})} = 1.39 \times 10^{-5}$$

which is very small, as expected. Therefore, the mole fraction of water in the lake near the surface is

$$y_{\text{water, liquid side}} = 1 - y_{\text{dry air, liquid side}} = 1 - 1.39 \times 10^{-5} = \mathbf{0.99999}$$

Discussion The concentration of air in water just below the air-water interface is 1.39 moles per 100,000 moles. The amount of air dissolved in water will decrease with increasing depth.

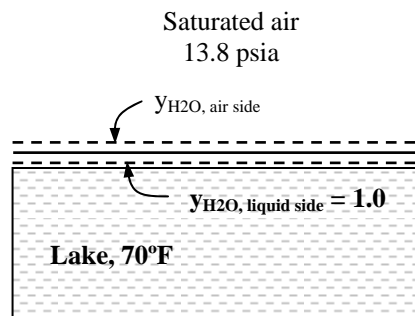

14-37 The mole fraction of the water vapor at the surface of a lake at a specified temperature is to be determined.

Assumptions 1 Both the air and water vapor are ideal gases. **2** Air at the lake surface is saturated.

Properties The saturation pressure of water at 15°C is 1.705 kPa (Table A-9).

Analysis The air at the water surface will be saturated. Therefore, the partial pressure of water vapor in the air at the lake surface will simply be the saturation pressure of water at 15°C,

$$P_{\text{vapor}} = P_{\text{sat}@15^\circ\text{C}} = 1.7051 \text{ kPa}$$

Assuming both the air and vapor to be ideal gases, the partial pressure and mole fraction of dry air in the air at the surface of the lake are determined to be

$$P_{\text{dry air}} = P - P_{\text{vapor}} = 100 - 1.7051 = 98.295 \text{ kPa}$$

$$y_{\text{dry air}} = \frac{P_{\text{dry air}}}{P} = \frac{98.295 \text{ kPa}}{100 \text{ kPa}} = \mathbf{0.983 \text{ (or 98.3%)}}$$

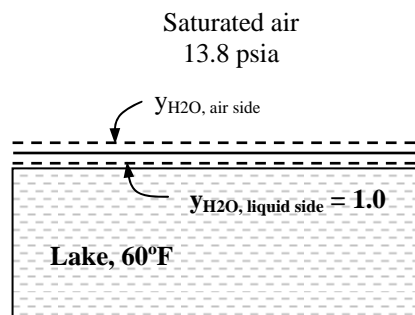

Therefore, the mole fraction of dry air is 98.3 percent just above the air-water interface.

14-38 EES Prob. 14-37 is reconsidered. The mole fraction of dry air at the surface of the lake as a function of the lake temperature is to be plotted.

Analysis The problem is solved using EES, and the solution is given below.

"GIVEN"

T=15 [C]

P_atm=100 [kPa]

"PROPERTIES"

Fluid\$='steam_IAPWS'

P_sat=Pressure(Fluid\$, T=T, x=1)

"ANALYSIS"

P_vapor=P_sat

P_dryair=P_atm-P_vapor

y_dryair=P_dryair/P_atm

T [C]	y _{dry air}
5	0.9913
6	0.9906
7	0.99
8	0.9893
9	0.9885
10	0.9877
11	0.9869
12	0.986
13	0.985
14	0.984
15	0.9829
16	0.9818
17	0.9806
18	0.9794
19	0.978
20	0.9766
21	0.9751
22	0.9736
23	0.9719
24	0.9701
25	0.9683

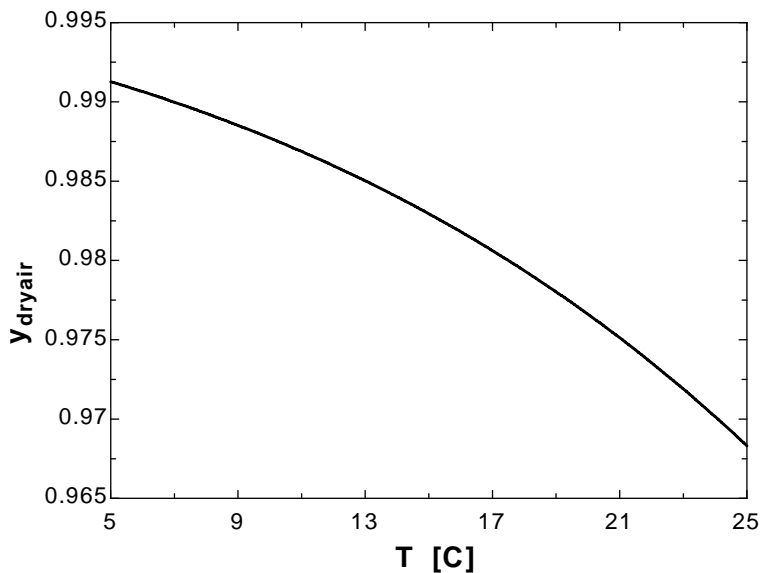

14-39 A rubber plate is exposed to nitrogen. The molar and mass density of nitrogen in the rubber at the interface is to be determined.

Assumptions Rubber and nitrogen are in thermodynamic equilibrium at the interface.

Properties The molar mass of nitrogen is $M = 28.0$ kg/kmol (Table A-1). The solubility of nitrogen in rubber at 298 K is 0.00156 kmol/m³·bar (Table 14-7).

Analysis Noting that 250 kPa = 2.5 bar, the molar density of nitrogen in the rubber at the interface is determined from Eq. 14-20 to be

$$\begin{aligned} C_{N_2, \text{solid side}}(0) &= S \times P_{N_2, \text{gas side}} \\ &= (0.00156 \text{ kmol/m}^3 \cdot \text{bar})(2.5 \text{ bar}) \\ &= \mathbf{0.0039 \text{ kmol/m}^3} \end{aligned}$$

It corresponds to a mass density of

$$\begin{aligned} \rho_{N_2, \text{solid side}}(0) &= C_{N_2, \text{solid side}}(0)M_{N_2} \\ &= (0.0039 \text{ kmol/m}^3)(28 \text{ kmol/kg}) \\ &= \mathbf{0.1092 \text{ kg/m}^3} \end{aligned}$$

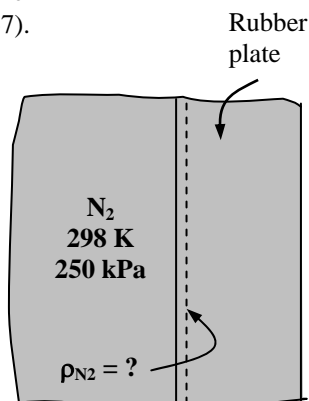

That is, there will be 0.0039 kmol (or 0.1092 kg) of N₂ gas in each m³ volume of rubber adjacent to the interface.

14-40 A rubber wall separates O₂ and N₂ gases. The molar concentrations of O₂ and N₂ in the wall are to be determined.

Assumptions The O₂ and N₂ gases are in phase equilibrium with the rubber wall.

Properties The molar mass of oxygen and nitrogen are 32.0 and 28.0 kg/kmol, respectively (Table A-1). The solubility of oxygen and nitrogen in rubber at 298 K are 0.00312 and 0.00156 kmol/m³·bar, respectively (Table 14-7).

Analysis Noting that 750 kPa = 7.5 bar, the molar densities of oxygen and nitrogen in the rubber wall are determined from Eq. 14-20 to be

$$\begin{aligned} C_{O_2, \text{solid side}}(0) &= S \times P_{O_2, \text{gas side}} \\ &= (0.00312 \text{ kmol/m}^3 \cdot \text{bar})(7.5 \text{ bar}) \\ &= \mathbf{0.0234 \text{ kmol/m}^3} \end{aligned}$$

$$\begin{aligned} C_{N_2, \text{solid side}}(0) &= S \times P_{N_2, \text{gas side}} \\ &= (0.00156 \text{ kmol/m}^3 \cdot \text{bar})(7.5 \text{ bar}) \\ &= \mathbf{0.0117 \text{ kmol/m}^3} \end{aligned}$$

That is, there will be 0.0234 kmol of O₂ and 0.0117 kmol of N₂ gas in each m³ volume of the rubber wall.

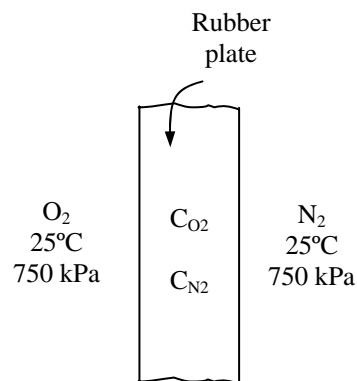

14-41 A glass of water is left in a room. The mole fraction of the water vapor in the air and the mole fraction of air in the water are to be determined when the water and the air are in thermal and phase equilibrium.

Assumptions **1** Both the air and water vapor are ideal gases. **2** Air is saturated since the humidity is 100 percent. **3** Air is weakly soluble in water and thus Henry's law is applicable.

Properties The saturation pressure of water at 20°C is 2.339 kPa (Table A-9). Henry's constant for air dissolved in water at 20°C (293 K) is given in Table 14-6 to be $H = 65,600$ bar. Molar masses of dry air and water are 29 and 18 kg/kmol, respectively (Table A-1).

Analysis (a) Noting that air is saturated, the partial pressure of water vapor in the air will simply be the saturation pressure of water at 20°C,

$$P_{\text{vapor}} = P_{\text{sat @ } 20^{\circ}\text{C}} = 2.339\text{kPa}$$

Assuming both the air and vapor to be ideal gases, the mole fraction of water vapor in the air is determined to be

$$y_{\text{vapor}} = \frac{P_{\text{vapor}}}{P} = \frac{2.339\text{kPa}}{97\text{kPa}} = \mathbf{0.0241}$$

(b) Noting that the total pressure is 97 kPa, the partial pressure of dry air is

$$P_{\text{dry air}} = P - P_{\text{vapor}} = 97 - 2.339 = 94.7\text{ kPa} = 0.947\text{ bar}$$

From Henry's law, the mole fraction of air in the water is determined to be

$$y_{\text{dry air, liquid side}} = \frac{P_{\text{dry air, gas side}}}{H} = \frac{0.947\text{ bar}}{65,600\text{ bar}} = \mathbf{1.44 \times 10^{-5}}$$

Discussion The amount of air dissolved in water is very small, as expected.

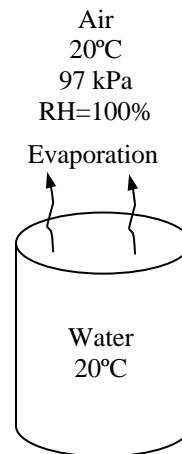

14-42E Water is sprayed into air, and the falling water droplets are collected in a container. The mass and mole fractions of air dissolved in the water are to be determined.

Assumptions 1 Both the air and water vapor are ideal gases. 2 Air is saturated since water is constantly sprayed into it. 3 Air is weakly soluble in water and thus Henry's law is applicable.

Properties The saturation pressure of water at 80°F is 0.5073 psia (Table A-9E). Henry's constant for air dissolved in water at 80°F (300 K) is given in Table 14-6 to be $H = 74,000$ bar. Molar masses of dry air and water are 29 and 18 lbm / lbmol, respectively (Table A-1E).

Analysis Noting that air is saturated, the partial pressure of water vapor in the air will simply be the saturation pressure of water at 80°F,

$$P_{\text{vapor}} = P_{\text{sat}@80^\circ\text{F}} = 0.5073 \text{ psia}$$

Then the partial pressure of dry air becomes

$$P_{\text{dry air}} = P - P_{\text{vapor}} = 14.3 - 0.5073 = 13.79 \text{ psia}$$

From Henry's law, the mole fraction of air in the water is determined to be

$$y_{\text{dry air, liquid side}} = \frac{P_{\text{dry air, gasside}}}{H} = \frac{13.79 \text{ psia} (1 \text{ atm} / 14.696 \text{ psia})}{74,000 \text{ bar} (1 \text{ atm} / 1.01325 \text{ bar})} = \mathbf{1.29 \times 10^{-5}}$$

which is very small, as expected. The mass and mole fractions of a mixture are related to each other by

$$w_i = \frac{m_i}{m_m} = \frac{N_i M_i}{N_m M_m} = y_i \frac{M_i}{M_m}$$

where the apparent molar mass of the liquid water - air mixture is

$$\begin{aligned} M_m &= \sum y_i M_i = y_{\text{liquid water}} M_{\text{water}} + y_{\text{dry air}} M_{\text{dry air}} \\ &\cong 1 \times 29.0 + 0 \times 18.0 \cong 29.0 \text{ kg/kmol} \end{aligned}$$

Then the mass fraction of dissolved air in liquid water becomes

$$w_{\text{dry air, liquid side}} = y_{\text{dry air, liquid side}} \frac{M_{\text{dry air}}}{M_m} = 1.29 \times 10^{-5} \frac{29}{29} = \mathbf{1.29 \times 10^{-5}}$$

Discussion The mass and mole fractions of dissolved air in this case are identical because of the very small amount of air in water.

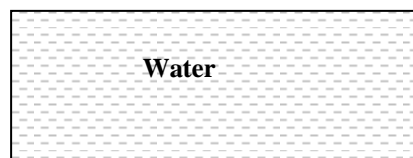
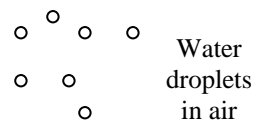

14-43 A carbonated drink in a bottle is considered. Assuming the gas space above the liquid consists of a saturated mixture of CO₂ and water vapor and treating the drink as a water, determine the mole fraction of the water vapor in the CO₂ gas and the mass of dissolved CO₂ in a 200 ml drink are to be determined when the water and the CO₂ gas are in thermal and phase equilibrium.

Assumptions 1 The liquid drink can be treated as water. **2** Both the CO₂ and the water vapor are ideal gases. **3** The CO₂ gas and water vapor in the bottle form a saturated mixture. **4** The CO₂ is weakly soluble in water and thus Henry's law is applicable.

Properties The saturation pressure of water at 37°C is 6.33 kPa (Table A-9). Henry's constant for CO₂ dissolved in water at 37°C (310 K) is given in Table 14-6 to be $H = 2170$ bar. Molar masses of CO₂ and water are 44 and 18 kg/kmol, respectively (Table A-1).

Analysis (a) Noting that the CO₂ gas in the bottle is saturated, the partial pressure of water vapor in the air will simply be the saturation pressure of water at 37°C,

$$P_{\text{vapor}} = P_{\text{sat @ } 37^\circ\text{C}} = 6.33 \text{ kPa}$$

Assuming both CO₂ and vapor to be ideal gases, the mole fraction of water vapor in the CO₂ gas becomes

$$y_{\text{vapor}} = \frac{P_{\text{vapor}}}{P} = \frac{6.33 \text{ kPa}}{130 \text{ kPa}} = \mathbf{0.0487}$$

(b) Noting that the total pressure is 130 kPa, the partial pressure of CO₂ is

$$P_{\text{CO}_2, \text{ gas}} = P - P_{\text{vapor}} = 130 - 6.33 = 123.7 \text{ kPa} = 1.237 \text{ bar}$$

From Henry's law, the mole fraction of CO₂ in the drink is determined to be

$$y_{\text{CO}_2, \text{ liquid side}} = \frac{P_{\text{CO}_2, \text{ gas side}}}{H} = \frac{1.237 \text{ bar}}{2170 \text{ bar}} = 5.70 \times 10^{-4}$$

Then the mole fraction of water in the drink becomes

$$y_{\text{water, liquid side}} = 1 - y_{\text{CO}_2, \text{ liquid side}} = 1 - 5.70 \times 10^{-4} = 0.9994$$

The mass and mole fractions of a mixture are related to each other by

$$w_i = \frac{m_i}{m_m} = \frac{N_i M_i}{N_m M_m} = y_i \frac{M_i}{M_m}$$

where the apparent molar mass of the drink (liquid water - CO₂ mixture) is

$$M_m = \sum y_i M_i = y_{\text{liquid water}} M_{\text{water}} + y_{\text{CO}_2} M_{\text{CO}_2} = 0.9994 \times 18.0 + (5.70 \times 10^{-4}) \times 44 = 18.00 \text{ kg/kmol}$$

Then the mass fraction of dissolved CO₂ gas in liquid water becomes

$$w_{\text{CO}_2, \text{ liquid side}} = y_{\text{CO}_2, \text{ liquid side}} \frac{M_{\text{CO}_2}}{M_m} = 5.70 \times 10^{-4} \frac{44}{18.00} = 0.00139$$

Therefore, the mass of dissolved CO₂ in a 200 ml \approx 200 g drink is

$$m_{\text{CO}_2} = w_{\text{CO}_2} m_m = 0.00139(200 \text{ g}) = \mathbf{0.278 \text{ g}}$$

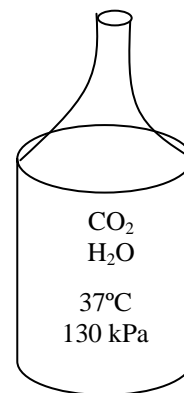

Steady Mass Diffusion through a Wall

14-44C The relations for steady one-dimensional heat conduction and mass diffusion through a plane wall are expressed as follows:

$$\text{Heat conduction:} \quad \dot{Q}_{\text{cond}} = -kA \frac{T_1 - T_2}{L}$$

$$\text{Mass diffusion:} \quad \dot{m}_{\text{diff,A,wall}} = \rho D_{\text{AB}} A \frac{w_{\text{A},1} - w_{\text{A},2}}{L} = D_{\text{AB}} A \frac{\rho_{\text{A},1} - \rho_{\text{A},2}}{L}$$

where A is the normal area and L is the thickness of the wall, and the other variables correspond to each other as follows:

$$\text{rate of heat conduction} \quad \dot{Q}_{\text{cond}} \longleftrightarrow \dot{m}_{\text{diff,A,wall}} \quad \text{rate of mass diffusion}$$

$$\text{thermal conductivity} \quad k \longleftrightarrow D_{\text{AB}} \quad \text{mass diffusivity}$$

$$\text{temperature} \quad T \longleftrightarrow \rho_{\text{A}} \quad \text{density of } A$$

14-45C (a) T, (b) F, (c) T, (d) F

14-46C During one-dimensional mass diffusion of species A through a plane wall of thickness L , the concentration profile of species A in the wall will be a straight line when (1) steady operating conditions are established, (2) the concentrations of the species A at both sides are maintained constant, and (3) the diffusion coefficient is constant.

14-47C During one-dimensional mass diffusion of species A through a plane wall, the species A content of the wall will remain constant during steady mass diffusion, but will change during transient mass diffusion.

14-48 Pressurized helium gas is stored in a spherical container. The diffusion rate of helium through the container is to be determined.

Assumptions 1 Mass diffusion is *steady* and *one-dimensional* since the helium concentration in the tank and thus at the inner surface of the container is practically constant, and the helium concentration in the atmosphere and thus at the outer surface is practically zero. Also, there is symmetry about the center of the container. 2 There are no chemical reactions in the pyrex shell that results in the generation or depletion of helium.

Properties The binary diffusion coefficient of helium in the pyrex at the specified temperature is $4.5 \times 10^{-15} \text{ m}^2/\text{s}$ (Table 14-3b). The molar mass of helium is $M = 4 \text{ kg/kmol}$ (Table A-1).

Analysis We can consider the total molar concentration to be constant ($C = C_A + C_B \cong C_B = \text{constant}$), and the container to be a *stationary* medium since there is no diffusion of pyrex molecules ($\dot{N}_B = 0$) and the concentration of the helium in the container is extremely low ($C_A \ll 1$). Then the molar flow rate of helium through the shell by diffusion can readily be determined from Eq. 14-28 to be

$$\begin{aligned} \dot{N}_{\text{diff}} &= 4\pi r_1 r_2 D_{AB} \frac{C_{A,1} - C_{A,2}}{r_2 - r_1} \\ &= 4\pi (1.45 \text{ m})(1.50 \text{ m})(4.5 \times 10^{-15} \text{ m}^2/\text{s}) \frac{(0.00073 - 0) \text{ kmol/m}^3}{1.50 - 1.45} \\ &= 1.80 \times 10^{-15} \text{ kmol/s} \end{aligned}$$

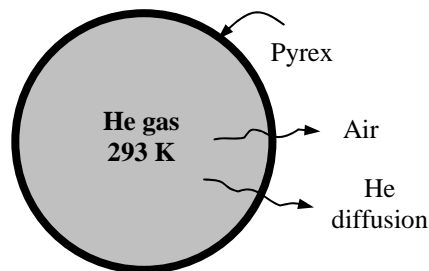

The mass flow rate is determined by multiplying the molar flow rate by the molar mass of helium,

$$\dot{m}_{\text{diff}} = M\dot{N}_{\text{diff}} = (4 \text{ kg/kmol})(1.80 \times 10^{-15} \text{ kmol/s}) = \mathbf{7.2 \times 10^{-15} \text{ kg/s}}$$

Therefore, helium will leak out of the container through the shell by diffusion at a rate of $7.2 \times 10^{-15} \text{ kg/s}$ or 0.00023 g/year .

Discussion Note that the concentration of helium in the pyrex at the inner surface depends on the temperature and pressure of the helium in the tank, and can be determined as explained in the previous example. Also, the assumption of zero helium concentration in pyrex at the outer surface is reasonable since there is only a trace amount of helium in the atmosphere (0.5 parts per million by mole numbers).

14-49 A thin plastic membrane separates hydrogen from air. The diffusion rate of hydrogen by diffusion through the membrane under steady conditions is to be determined.

Assumptions 1 Mass diffusion is *steady* and *one-dimensional* since the hydrogen concentrations on both sides of the membrane are maintained constant. Also, there is symmetry about the center plane of the membrane. 2 There are no chemical reactions in the membrane that results in the generation or depletion of hydrogen.

Properties The binary diffusion coefficient of hydrogen in the plastic membrane at the operation temperature is given to be $5.3 \times 10^{-10} \text{ m}^2/\text{s}$. The molar mass of hydrogen is $M = 2 \text{ kg/kmol}$ (Table A-1).

Analysis (a) We can consider the total molar concentration to be constant ($C = C_A + C_B \cong C_B = \text{constant}$), and the plastic membrane to be a *stationary* medium since there is no diffusion of plastic molecules ($\dot{N}_B = 0$) and the concentration of the hydrogen in the membrane is extremely low ($C_A \ll 1$). Then the molar flow rate of hydrogen through the membrane by diffusion per unit area is determined from

$$\begin{aligned}\bar{j}_{\text{diff}} &= \frac{\dot{N}_{\text{diff}}}{A} = D_{AB} \frac{C_{A,1} - C_{A,2}}{L} \\ &= (5.3 \times 10^{-10} \text{ m}^2/\text{s}) \frac{(0.045 - 0.002) \text{ kmol/m}^3}{2 \times 10^{-3} \text{ m}} \\ &= 1.14 \times 10^{-8} \text{ kmol/m}^2 \cdot \text{s}\end{aligned}$$

The mass flow rate is determined by multiplying the molar flow rate by the molar mass of hydrogen,

$$\begin{aligned}\dot{m}_{\text{diff}} &= M \bar{j}_{\text{diff}} = (2 \text{ kg/kmol})(1.14 \times 10^{-8} \text{ kmol/m}^2 \cdot \text{s}) \\ &= \mathbf{2.28 \times 10^{-8} \text{ kg/m}^2 \cdot \text{s}}\end{aligned}$$

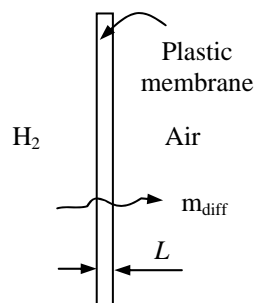

(b) Repeating the calculations for a 0.5-mm thick membrane gives

$$\begin{aligned}\bar{j}_{\text{diff}} &= \frac{\dot{N}_{\text{diff}}}{A} = D_{AB} \frac{C_{A,1} - C_{A,2}}{L} \\ &= (5.3 \times 10^{-10} \text{ m}^2/\text{s}) \frac{(0.045 - 0.002) \text{ kmol/m}^3}{0.5 \times 10^{-3} \text{ m}} \\ &= 4.56 \times 10^{-8} \text{ kmol/m}^2 \cdot \text{s}\end{aligned}$$

and

$$\dot{m}_{\text{diff}} = M \bar{j}_{\text{diff}} = (2 \text{ kg/kmol})(4.56 \times 10^{-8} \text{ kmol/m}^2 \cdot \text{s}) = \mathbf{9.12 \times 10^{-8} \text{ kg/m}^2 \cdot \text{s}}$$

The mass flow rate through the entire membrane can be determined by multiplying the mass flux value above by the membrane area.

14-50 Natural gas with 8% hydrogen content is transported in an above ground pipeline. The highest rate of hydrogen loss through the pipe at steady conditions is to be determined.

Assumptions 1 Mass diffusion is *steady* and *one-dimensional* since the hydrogen concentrations inside the pipe is constant, and in the atmosphere it is negligible. Also, there is symmetry about the centerline of the pipe. 2 There are no chemical reactions in the pipe that results in the generation or depletion of hydrogen. 3 Both H_2 and CH_4 are ideal gases.

Properties The binary diffusion coefficient of hydrogen in the steel pipe at the operation temperature is given to be $2.9 \times 10^{-13} \text{ m}^2/\text{s}$. The molar masses of H_2 and CH_4 are 2 and 16 kg/kmol, respectively (Table A-1). The solubility of hydrogen gas in steel is given as $w_{H_2} = 2.09 \times 10^{-4} \exp(-3950/T) P_{H_2}^{0.5}$. The density of steel pipe is 7854 kg/m^3 (Table A-3).

Analysis We can consider the total molar concentration to be constant ($C = C_A + C_B \cong C_B = \text{constant}$), and the steel pipe to be a *stationary* medium since there is no diffusion of steel molecules ($\dot{N}_B = 0$) and the concentration of the hydrogen in the steel pipe is extremely low ($C_A \ll 1$). The molar mass of the H_2 and CH_4 mixture in the pipe is

$$M = \sum y_i M_i = (0.08)(2) + (0.92)(16) = 14.88 \text{ kg/kmol}$$

Noting that the mole fraction of hydrogen is 0.08, the partial pressure of hydrogen is

$$y_{H_2} = \frac{P_{H_2}}{P} \rightarrow P_{H_2} = (0.08)(500 \text{ kPa}) = 40 \text{ kPa} = 0.4 \text{ bar}$$

Then the mass fraction of hydrogen becomes

$$\begin{aligned} w_{H_2} &= 2.09 \times 10^{-4} \exp(-3950/T) P_{H_2}^{0.5} \\ &= 2.09 \times 10^{-4} \exp(-3950/293)(0.4)^{0.5} \\ &= 1.85 \times 10^{-10} \end{aligned}$$

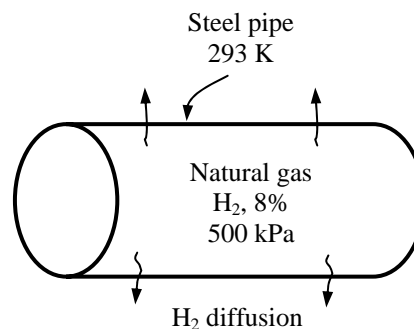

The hydrogen concentration in the atmosphere is practically zero, and thus in the limiting case the hydrogen concentration at the outer surface of pipe can be taken to be zero. Then the highest rate of hydrogen loss through a 100 m long section of the pipe at steady conditions is determined to be

$$\begin{aligned} \dot{m}_{\text{diff,A,cyl}} &= 2\pi L \rho D_{AB} \frac{w_{A,1} - w_{A,2}}{\ln(r_2/r_1)} \\ &= 2\pi(100 \text{ m})(7854 \text{ kg/m}^3)(2.9 \times 10^{-13}) \frac{1.85 \times 10^{-10} - 0}{\ln(1.51/1.50)} \\ &= \mathbf{3.98 \times 10^{-14} \text{ kg/s}} \end{aligned}$$

14-51 EES Prob. 14-50 is reconsidered. The highest rate of hydrogen loss as a function of the mole fraction of hydrogen in natural gas is to be plotted.

Analysis The problem is solved using EES, and the solution is given below.

"GIVEN"

thickness=0.01 [m]
 $D_i=3$ [m]
 $L=100$ [m]
 $P=500$ [kPa]
 $y_{H2}=0.08$
 $T=293$ [K]
 $D_{AB}=2.9E-13$ [m²/s]

"PROPERTIES"

$MM_{H2}=\text{molarmass}(H2)$
 $MM_{CH4}=\text{molarmass}(CH4)$
 $R_u=8.314$ [kPa·m³/kmol·K]
 $\rho=7854$ [kg/m³]

"ANALYSIS"

$MM=y_{H2} \cdot MM_{H2} + (1-y_{H2}) \cdot MM_{CH4}$
 $P_{H2}=y_{H2} \cdot P \cdot \text{Convert}(kPa, bar)$
 $w_{H2}=2.09E-4 \cdot \exp(-3950/T) \cdot P_{H2}^{0.5}$
 $\dot{m}_{diff}=2 \cdot \pi \cdot L \cdot \rho \cdot D_{AB} \cdot w_{H2} / \ln(r_2/r_1) \cdot \text{Convert}(kg/s, g/s)$
 $r_1=D_i/2$
 $r_2=r_1+\text{thickness}$

y_{H2}	\dot{m}_{diff} [g/s]
0.05	3.144E-11
0.06	3.444E-11
0.07	3.720E-11
0.08	3.977E-11
0.09	4.218E-11
0.1	4.446E-11
0.11	4.663E-11
0.12	4.871E-11
0.13	5.070E-11
0.14	5.261E-11
0.15	5.446E-11

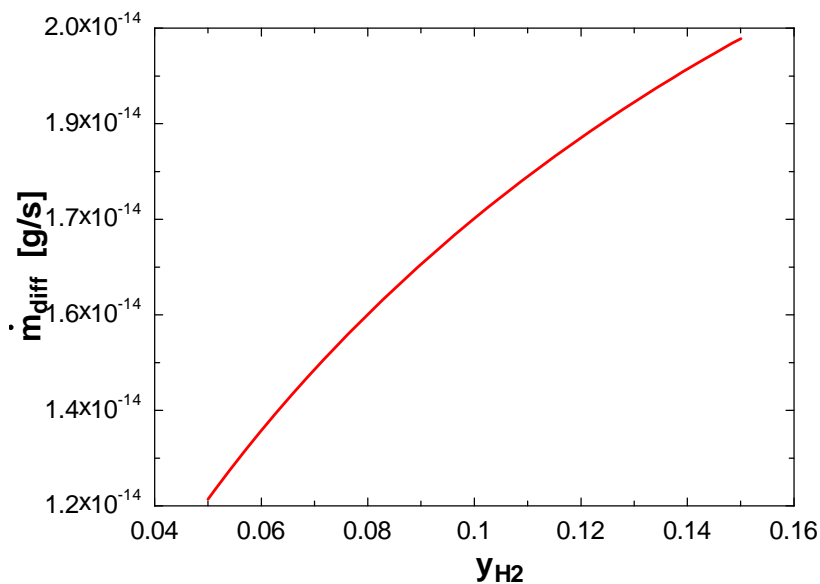

14-52 Helium gas is stored in a spherical fused silica container. The diffusion rate of helium through the container and the pressure drop in the tank in one week as a result of helium loss are to be determined.

Assumptions **1** Mass diffusion is *steady* and *one-dimensional* since the helium concentration in the tank and thus at the inner surface of the container is practically constant, and the helium concentration in the atmosphere and thus at the outer surface is practically zero. Also, there is symmetry about the midpoint of the container. **2** There are no chemical reactions in the fused silica that results in the generation or depletion of helium. **3** Helium is an ideal gas. **4** The helium concentration at the inner surface of the container is at the highest possible level (the solubility).

Properties The solubility of helium in fused silica (SiO_2) at 293 K and 500 kPa is $0.00045 \text{ kmol/m}^3 \cdot \text{bar}$ (Table 14-7). The diffusivity of helium in fused silica at 293 K (actually, at 298 K) is $4 \times 10^{-14} \text{ m}^2/\text{s}$ (Table 14-3b). The molar mass of helium is $M = 4 \text{ kg/kmol}$ (Table A-1).

Analysis (a) We can consider the total molar concentration to be constant ($C = C_A + C_B \cong C_B = \text{constant}$), and the container to be a *stationary* medium since there is no diffusion of silica molecules ($\dot{N}_B = 0$) and the concentration of the helium in the container is extremely low ($C_A \ll 1$). The molar concentration of helium at the inner surface of the container is determined from the solubility data to be

$$C_{A,1} = S \times P_{\text{He}} = (0.00045 \text{ kmol/m}^3 \cdot \text{bar})(5 \text{ bar}) = 2.25 \times 10^{-3} \text{ kmol/m}^3 = 0.00225 \text{ kmol/m}^3$$

The helium concentration in the atmosphere and thus at the outer surface is taken to be zero since the tank is well ventilated. Then the molar flow rate of helium through the tank by diffusion becomes

$$\begin{aligned} \dot{N}_{\text{diff}} &= 4\pi r_1 r_2 D_{AB} \frac{C_{A,1} - C_{A,2}}{r_2 - r_1} \\ &= 4\pi(1\text{m})(1.01\text{m})(4 \times 10^{-14} \text{ m}^2/\text{s}) \frac{(0.00225 - 0) \text{ kmol/m}^3}{(1.01 - 1) \text{ m}} \\ &= 1.14 \times 10^{-13} \text{ kmol/s} \end{aligned}$$

The mass flow rate is determined by multiplying the molar flow rate by the molar mass of helium,

$$\dot{m}_{\text{diff}} = M \dot{N}_{\text{diff}} = (4 \text{ kg/kmol})(1.14 \times 10^{-13} \text{ kmol/s}) = \mathbf{4.57 \times 10^{-13} \text{ kg/s}}$$

(b) Noting that the molar flow rate of helium is $1.14 \times 10^{-13} \text{ kmol/s}$, the amount of helium diffused through the shell in 1 week becomes

$$\begin{aligned} N_{\text{diff}} &= \dot{N}_{\text{diff}} \Delta t = (1.14 \times 10^{-13} \text{ kmol/s})(7 \times 24 \times 3600 \text{ s/week}) \\ &= 6.895 \times 10^{-8} \text{ kmol/week} \end{aligned}$$

The volume of the spherical tank and the initial amount of helium gas in the tank are

$$\begin{aligned} \mathcal{V} &= \frac{4}{3} \pi r^3 = \frac{4}{3} \pi (1\text{m})^3 = 4.189 \text{ m}^3 \\ N_{\text{initial}} &= \frac{P\mathcal{V}}{R_u T} = \frac{(500 \text{ kPa})(4.189 \text{ m}^3)}{(8.314 \text{ kPa} \cdot \text{m}^3/\text{kmolK})(293 \text{ K})} = 0.85977 \text{ kmol} \end{aligned}$$

Then the number of moles of helium remaining in the tank after one week becomes

$$N_{\text{final}} = N_{\text{initial}} - N_{\text{diff}} = 0.85977 - 6.895 \times 10^{-8} \cong 0.85977 \text{ kmol}$$

which is the practically the same as the initial value. Therefore, the amount of helium that leaves the tank by diffusion is negligible, and the final pressure in the tank is the same as the initial pressure of $P_2 = P_1 = \mathbf{500 \text{ kPa}}$.

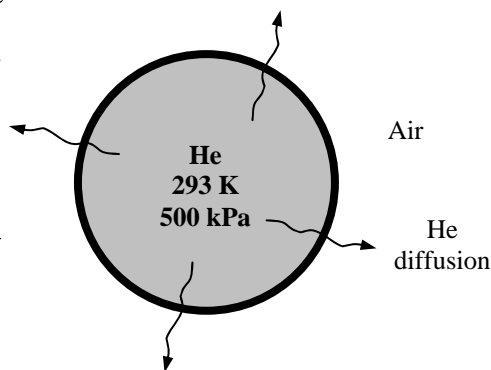

14-53 A balloon is filled with helium gas. The initial rates of diffusion of helium, oxygen, and nitrogen through the balloon and the mass fraction of helium that escapes during the first 5 h are to be determined.

Assumptions 1 The pressure of helium inside the balloon remains nearly constant. **2** Mass diffusion is *steady* for the time period considered. **3** Mass diffusion is *one-dimensional* since the helium concentration in the balloon and thus at the inner surface is practically constant, and the helium concentration in the atmosphere and thus at the outer surface is practically zero. Also, there is symmetry about the midpoint of the balloon. **4** There are no chemical reactions in the balloon that results in the generation or depletion of helium. **5** Both the helium and the air are ideal gases. **7** The curvature effects of the balloon are negligible so that the balloon can be treated as a plane layer.

Properties The permeability of rubber to helium, oxygen, and nitrogen at 25°C are given to be 9.4×10^{-13} , 7.05×10^{-13} , and 2.6×10^{-13} kmol/m.s.bar, respectively. The molar mass of helium is $M = 4$ kg/kmol and its gas constant is $R = 2.0709$ kPa.m³/kg.K (Table A-1).

Analysis We can consider the total molar concentration to be constant ($C = C_A + C_B \cong C_B = \text{constant}$), and the balloon to be a *stationary* medium since there is no diffusion of rubber molecules ($\dot{N}_B = 0$) and the concentration of the helium in the balloon is extremely low ($C_A \ll 1$). The partial pressures of oxygen and nitrogen in the air are

$$P_{N_2} = y_{N_2} P = (0.79)(100 \text{ kPa}) = 79 \text{ kPa} = 0.79 \text{ bar}$$

$$P_{O_2} = y_{O_2} P = (0.21)(100 \text{ kPa}) = 21 \text{ kPa} = 0.21 \text{ bar}$$

The partial pressure of helium in the air is negligible. Since the balloon is filled with pure helium gas at 110 kPa, the initial partial pressure of helium in the balloon is 110 kPa, and the initial partial pressures of oxygen and nitrogen are zero.

When permeability data is available, the molar flow rate of a gas through a solid wall of thickness L under steady one-dimensional conditions can be determined from Eq. 14-29,

$$\dot{N}_{\text{diff,A,wall}} = P_{AB} A \frac{P_{A,1} - P_{A,2}}{L} \quad (\text{kmol/s})$$

where P_{AB} is the permeability and $P_{A,1}$ and $P_{A,2}$ are the partial pressures of gas A on the two sides of the wall (Note that the balloon can be treated as a plain layer since its thickness is very small compared to its diameter). Noting that the surface area of the balloon is $A = \pi D^2 = \pi(0.15 \text{ m})^2 = 0.07069 \text{ m}^2$, the initial rates of diffusion of helium, oxygen, and nitrogen at 25°C are determined to be

$$\begin{aligned} \dot{N}_{\text{diff,He}} &= P_{AB} A \frac{P_{\text{He},1} - P_{\text{He},2}}{L} \\ &= (9.4 \times 10^{-13} \text{ kmol/m.s.bar})(0.07069 \text{ m}^2) \frac{(1.1 - 0) \text{ bar}}{0.1 \times 10^{-3} \text{ m}} = \mathbf{0.731 \times 10^{-9} \text{ kmol/s}} \end{aligned}$$

$$\begin{aligned} \dot{N}_{\text{diff,O}_2} &= P_{AB} A \frac{P_{\text{O}_2,1} - P_{\text{O}_2,2}}{L} \\ &= (7.05 \times 10^{-13} \text{ kmol/m.s.bar})(0.07069 \text{ m}^2) \frac{(0 - 0.21) \text{ bar}}{0.1 \times 10^{-3} \text{ m}} = \mathbf{-0.105 \times 10^{-9} \text{ kmol/s}} \end{aligned}$$

$$\begin{aligned} \dot{N}_{\text{diff,N}_2} &= P_{AB} A \frac{P_{\text{N}_2,1} - P_{\text{N}_2,2}}{r_2 - r_1} \\ &= (2.6 \times 10^{-13} \text{ kmol/m.s.bar})(0.07069 \text{ m}^2) \frac{(0 - 0.79) \text{ bar}}{0.1 \times 10^{-3} \text{ m}} = \mathbf{-0.145 \times 10^{-9} \text{ kmol/s}} \end{aligned}$$

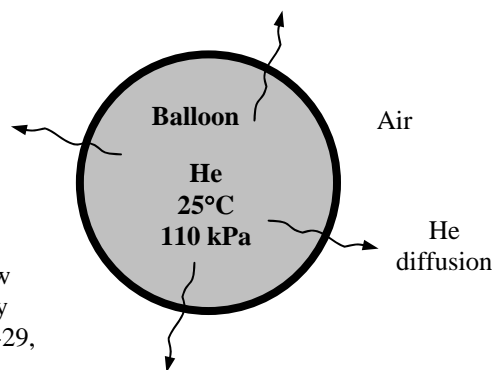

The initial mass flow rate of helium and the amount of helium that escapes during the first 5 hours are

$$\dot{m}_{diff,He} = M \dot{N}_{diff,He} = (4\text{kg/kmol})(0.731 \times 10^{-9} \text{ kmol/s}) = 2.92 \times 10^{-9} \text{ kg/s}$$

$$m_{diff,He} = \dot{m}_{diff,He} \Delta t = (2.92 \times 10^{-9} \text{ kg/s})(5 \times 3600 \text{ s}) = \mathbf{5.26 \times 10^{-5} \text{ kg} = 0.0526 \text{ g}}$$

The initial mass of helium in the balloon is

$$m_{initial} = \frac{PV}{RT} = \frac{(110 \text{ kPa})[4\pi(0.075 \text{ m})^3 / 3]}{(2.077 \text{ kPa}\cdot\text{m}^3/\text{kg}\cdot\text{K})(298 \text{ K})} = 3.14 \times 10^{-4} \text{ kg} = 0.314 \text{ g}$$

Therefore, the fraction of helium that escapes the balloon during the first 5 h is

$$\text{Fraction} = \frac{m_{diff,He}}{m_{initial}} = \frac{0.0526\text{g}}{0.314 \text{ g}} = \mathbf{0.168 \text{ (or } 16.8\%)}$$

Discussion This is a significant amount of helium gas that escapes the balloon, and explains why the helium balloons do not last long. Also, our assumption of constant pressure for the helium in the balloon is obviously not very accurate since 16.8% of helium is lost during the process.

14-54 A balloon is filled with helium gas. A relation for the variation of pressure in the balloon with time as a result of mass transfer through the balloon material is to be obtained, and the time it takes for the pressure in the balloon to drop from 110 to 100 kPa is to be determined.

Assumptions 1 The pressure of helium inside the balloon remains nearly constant. **2** Mass diffusion is *transient* since the conditions inside the balloon change with time. **3** Mass diffusion is *one-dimensional* since the helium concentration in the balloon and thus at the inner surface is practically constant, and the helium concentration in the atmosphere and thus at the outer surface is practically zero. Also, there is symmetry about the midpoint of the balloon. **4** There are no chemical reactions in the balloon material that results in the generation or depletion of helium. **5** Helium is an ideal gas. **6** The diffusion of air into the balloon is negligible. **7** The volume of the balloon is constant. **8** The curvature effects of the balloon are negligible so that the balloon material can be treated as a plane layer.

Properties The permeability of rubber to helium at 25°C is given to be 9.4×10^{-13} kmol/m.s.bar. The molar mass of helium is $M = 4$ kg/kmol and its gas constant is $R = 2.077$ kPa.m³/kg.K (Table A-1).

Analysis We can consider the total molar concentration to be constant ($C = C_A + C_B \cong C_B = \text{constant}$), and the balloon to be a *stationary* medium since there is no diffusion of rubber molecules ($\dot{N}_B = 0$) and the concentration of the helium in the balloon is extremely low ($C_A \ll 1$). The partial pressure of helium in the air is negligible. Since the balloon is filled with pure helium gas at 110 kPa, the initial partial pressure of helium in the balloon is 110 kPa.

When permeability data is available, the molar flow rate of a gas through a solid wall of thickness L under steady one-dimensional conditions can be determined from Eq. 14-29,

$$\dot{N}_{\text{diff,A,wall}} = P_{AB} A \frac{P_{A,1} - P_{A,2}}{L} = P_{AB} A \frac{P}{L} \quad (\text{kmol/s})$$

where P_{AB} is the permeability and $P_{A,1}$ and $P_{A,2}$ are the partial pressures of helium on the two sides of the wall (note that the balloon can be treated as a plain layer since its thickness very small compared to its diameter, and $P_{A,1}$ is simply the pressure P of helium inside the balloon).

Noting that the amount of helium in the balloon can be expressed as $N = P\mathcal{V} / R_u T$ and taking the temperature and volume to be constants,

$$N = \frac{P\mathcal{V}}{R_u T} \rightarrow \frac{dN}{dt} = \frac{\mathcal{V}}{R_u T} \frac{dP}{dt} \rightarrow \frac{dP}{dt} = \frac{R_u T}{\mathcal{V}} \frac{dN}{dt} \quad (1)$$

Conservation of mass dictates that the mass flow rate of helium from the balloon be equal to the rate of change of mass inside the balloon,

$$\frac{dN}{dt} = -\dot{N}_{\text{diff,A,wall}} = -P_{AB} A \frac{P}{L} \quad (2)$$

Substituting (2) into (1),

$$\frac{dP}{dt} = \frac{R_u T}{\mathcal{V}} \frac{dN}{dt} = -\frac{R_u T}{\mathcal{V}} P_{AB} A \frac{P}{L} = -\frac{R_u T P_{AB} A}{\mathcal{V} L} P$$

Separating the variables and integrating gives

$$\frac{dP}{P} = -\frac{R_u T P_{AB} A}{\mathcal{V} L} dt \rightarrow \ln P \Big|_{P_0}^P = -\frac{R_u T P_{AB} A}{\mathcal{V} L} t \Big|_0^t \rightarrow \ln \frac{P}{P_0} = -\frac{R_u T P_{AB} A}{\mathcal{V} L} t$$

Rearranging, the desired relation for the variation of pressure in the balloon with time is determined to be

$$P = P_0 \exp\left(-\frac{R_u T P_{AB} A}{\mathcal{V} L} t\right) = P_0 \exp\left(-\frac{3R_u T P_{AB}}{rL} t\right) \quad \text{since, for a sphere, } \frac{A}{\mathcal{V}} = \frac{4\pi r^2}{4\pi r^3/3} = \frac{3}{r}$$

Then the time it takes for the pressure inside the balloon to drop from 110 kPa to 100 kPa becomes

$$\frac{100 \text{ kPa}}{110 \text{ kPa}} = \exp\left(-\frac{3(0.08314 \text{ bar} \cdot \text{m}^3 / \text{kmol} \cdot \text{K})(298 \text{ K})(9.4 \times 10^{-13} \text{ kmol/m} \cdot \text{s} \cdot \text{bar})}{(0.075 \text{ m})(0.1 \times 10^{-3} \text{ m})} t\right) \rightarrow t = 10,230 \text{ s} = \mathbf{2.84 \text{ h}}$$

Therefore, the balloon will lose 10% of its pressure in about 3 h.

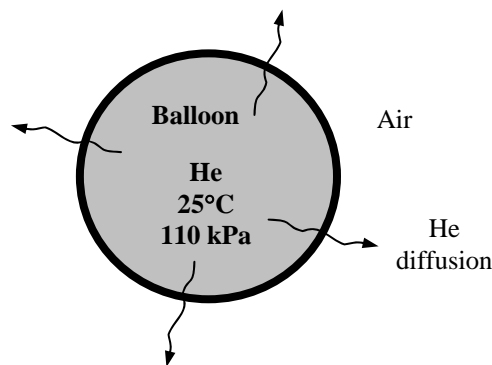

14-55 Pure N₂ gas is flowing through a rubber pipe. The rate at which N₂ leaks out by diffusion is to be determined for the cases of vacuum and atmospheric air outside.

Assumptions 1 Mass diffusion is *steady* and *one-dimensional* since the nitrogen concentration in the pipe and thus at the inner surface of the pipe is practically constant, and the nitrogen concentration in the atmosphere also remains constant. Also, there is symmetry about the centerline of the pipe. **2** There are no chemical reactions in the pipe that results in the generation or depletion of nitrogen. **3** Both the nitrogen and air are ideal gases.

Properties The diffusivity and solubility of nitrogen in rubber at 25°C are $1.5 \times 10^{-10} \text{ m}^2/\text{s}$ and $0.00156 \text{ kmol/m}^3 \cdot \text{bar}$, respectively (Tables 14-3 and 14-7).

Analysis We can consider the total molar concentration to be constant ($C = C_A + C_B \cong C_B = \text{constant}$), and the container to be a *stationary* medium since there is no diffusion of rubber molecules ($\dot{N}_B = 0$) and the concentration of the nitrogen in the container is extremely low ($C_A \ll 1$). The partial pressures of oxygen and nitrogen in the air are

$$P_{\text{N}_2} = y_{\text{N}_2} P = (0.79)(100 \text{ kPa}) = 79 \text{ kPa} = 0.79 \text{ bar}$$

$$P_{\text{O}_2} = y_{\text{O}_2} P = (0.21)(100 \text{ kPa}) = 21 \text{ kPa} = 0.21 \text{ bar}$$

When solubility data is available, the molar flow rate of a gas through a solid can be determined by replacing the molar concentration by $C_{A, \text{solid side}}(0) = S_{AB} P_{A, \text{gas side}}(0)$

For a cylindrical pipe the molar rate of diffusion can be expressed in terms of solubility as

$$\dot{N}_{\text{diff}, A, \text{cyl}} = 2\pi L D_{AB} S_{AB} \frac{P_{A,1} - P_{A,2}}{\ln(r_2 / r_1)}$$

where S_{AB} is the *solubility* and $P_{A,1}$ and $P_{A,2}$ are the partial pressures of gas A on the two sides of the wall.

(a) The pipe is in vacuum and thus $P_{A,2} = 0$:

$$\begin{aligned} \dot{N}_{\text{diff}, A, \text{cyl}} &= 2\pi(10 \text{ m})(1.5 \times 10^{-10} \text{ m}^2 / \text{s})(0.00156 \text{ kmol/m}^3 \cdot \text{s} \cdot \text{bar}) \frac{(1-0) \text{ bar}}{\ln(0.032/0.03)} \\ &= \mathbf{2.278 \times 10^{-10} \text{ kmol/s}} \end{aligned}$$

(b) The pipe is in atmospheric air and thus $P_{A,2} = 0.79 \text{ bar}$:

$$\begin{aligned} \dot{N}_{\text{diff}, A, \text{cyl}} &= 2\pi(10 \text{ m})(1.5 \times 10^{-10} \text{ m}^2 / \text{s})(0.00156 \text{ kmol/m}^3 \cdot \text{s} \cdot \text{bar}) \frac{(1-0.79) \text{ bar}}{\ln(0.032/0.03)} \\ &= \mathbf{4.784 \times 10^{-11} \text{ kmol/s}} \end{aligned}$$

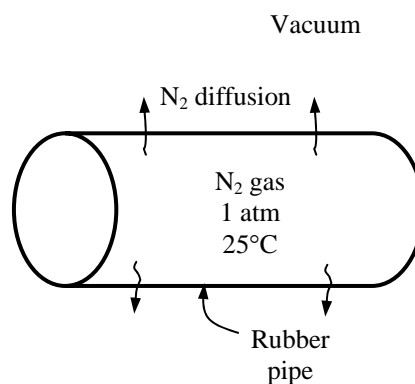

Discussion In the case of a vacuum environment, the diffusion rate of nitrogen from the pipe is about 5 times the rate in atmospheric air. This is expected since mass diffusion is proportional to the concentration difference.

Water Vapor Migration in Buildings

14-56C A tank that contains moist air at 3 atm is located in moist air that is at 1 atm. The driving force for moisture transfer is the vapor pressure difference, and thus it is possible for the water vapor to flow into the tank from surroundings if the vapor pressure in the surroundings is greater than the vapor pressure in the tank.

14-57C The mass flow rate of water vapor through a wall of thickness L in terms of the partial pressure of water vapor on both sides of the wall and the permeability of the wall to the water vapor can be expressed as

$$\dot{m}_{\text{diff,A,wall}} = MP_{\text{AB}}A \frac{P_{\text{A},1} - P_{\text{A},2}}{L}$$

where M is the molar mass of vapor, P_{AB} is the permeability, A is the normal area, and P_{A} is the partial pressure of the vapor.

14-58C The condensation or freezing of water vapor in the wall increases the thermal conductivity of the insulation material, and thus increases the rate of heat transfer through the wall. Similarly, the thermal conductivity of the soil increases with increasing amount of moisture.

14-59C Vapor barriers are materials that are impermeable to moisture such as sheet metals, heavy metal foils, and thick plastic layers, and they completely *eliminate* the vapor migration. Vapor retarders such as reinforced plastics or metals, thin foils, plastic films, treated papers and coated felts, on the other hand, *slow down* the flow of moisture through the structures. Vapor retarders are commonly used in residential buildings to control the vapor migration through the walls.

14-60C Excess moisture changes the *dimensions* of wood, and cyclic changes in dimensions weaken the joints, and can jeopardize the structural integrity of building components, causing “squeaking” at the minimum. Excess moisture can also cause *rotting* in woods, *mold* growth on wood surfaces, *corrosion* and *rusting* in metals, and *peeling of paint* on the interior and exterior wall surfaces.

14-61C Insulations on *chilled water lines* are always wrapped with *vapor barrier jackets* to eliminate the possibility of vapor entering the insulation. This is because moisture that migrates through the insulation to the cold surface will condense and remain there indefinitely with no possibility of vaporizing and moving back to the outside.

14-62C When the temperature, total pressure, and the relative humidity are given, the vapor pressure can be determined from the psychrometric chart or the relation $P_v = \phi P_{\text{sat}}$ where P_{sat} is the saturation (or boiling) pressure of water at the specified temperature and ϕ is the relative humidity.

14-63 The wall of a house is made of a 20-cm thick brick. The amount of moisture flowing through the wall in 24-h is to be determined.

Assumptions 1 Steady operating conditions exist. 2 Mass transfer through the wall is one-dimensional. 3 The vapor permeability of the wall is constant.

Properties The permeance of 100 mm thick wall is 46×10^{-12} kg/s.m².Pa (Table 14-10). The saturation pressures of water are 3169 Pa at 25°C, and 7384 Pa at 40°C (Table 14-9).

Analysis The permeability of the wall is

$$P = ML = (46 \times 10^{-12} \text{ kg/s} \cdot \text{m}^2 \cdot \text{Pa})(0.10 \text{ m}) \\ = 46 \times 10^{-13} \text{ kg/s} \cdot \text{m} \cdot \text{Pa}$$

The mass flow rate of water vapor through a plain layer of thickness L and normal area A is given as (Eq. 14-31)

$$\dot{m}_v = PA \frac{P_{v,1} - P_{v,2}}{L} = PA \frac{\phi_1 P_{\text{sat},1} - \phi_2 P_{\text{sat},2}}{L}$$

where P is the vapor permeability, ϕ is the relative humidity and P_{sat} is the saturation pressure of water at the specified temperature. Subscripts 1 and 2 denote the states of the air on the two sides of the roof. Substituting, the mass flow rate of water vapor through the wall is determined to be

$$\dot{m}_v = (46 \times 10^{-13} \text{ kg/s} \cdot \text{m} \cdot \text{Pa}) \frac{[0.50(7384 \text{ Pa}) - 0.50(3169 \text{ Pa})]}{0.20 \text{ m}} = 4.85 \times 10^{-8} \text{ kg/s} \cdot \text{m}^2$$

Then the total amount of moisture that flows through the roof during a 24-h period becomes

$$m_{v,24-h} = \dot{m}_v \Delta t = (4.85 \times 10^{-8} \text{ kg/s} \cdot \text{m}^2)(24 \times 3600 \text{ s}) = 0.0042 \text{ kg} = \mathbf{4.2 \text{ g}}$$

Discussion The moisture migration through the wall can be reduced significantly by covering the roof with a vapor barrier or vapor retarder.

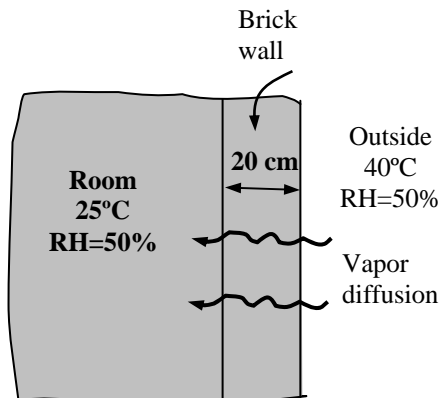

14-64 The inside wall of a house is finished with 9.5-mm thick gypsum wallboard. The maximum amount of water vapor that will diffuse through a 3 m × 8 m section of the wall in 24-h is to be determined.

Assumptions 1 Steady operating conditions exist. 2 Mass transfer through the wall is one-dimensional. 3 The vapor permeability of the wall is constant. 4 The vapor pressure at the outer side of the wallboard is zero.

Properties The permeance of the 9.5 mm thick gypsum wall board to water vapor is given to be 2.86×10^{-9} kg/s.m².Pa. (Table 14-10). The saturation pressure of water at 20°C is 2339 Pa (Table 14-9).

Analysis The mass flow rate of water vapor through a plain layer of thickness L and normal area A is given as (Eq. 14-31)

$$\begin{aligned}\dot{m}_v &= PA \frac{P_{v,1} - P_{v,2}}{L} \\ &= PA \frac{\phi_1 P_{\text{sat},1} - \phi_2 P_{\text{sat},2}}{L} = MA(\phi_1 P_{\text{sat},1} - \phi_2 P_{\text{sat},2})\end{aligned}$$

where P is the vapor permeability and $M = P/L$ is the permeance of the material, ϕ is the relative humidity and P_{sat} is the saturation pressure of water at the specified temperature. Subscripts 1 and 2 denote the air on the two sides of the wall.

Noting that the vapor pressure at the outer side of the wallboard is zero ($\phi_2 = 0$) and substituting, the mass flow rate of water vapor through the wall is determined to be

$$\dot{m}_v = (2.86 \times 10^{-9} \text{ kg/s.m}^2 \cdot \text{Pa})(3 \times 8 \text{ m}^2)[0.60(2339 \text{ Pa}) - 0] = 9.63 \times 10^{-5} \text{ kg/s}$$

Then the total amount of moisture that flows through the wall during a 24-h period becomes

$$m_{v,24\text{-h}} = \dot{m}_v \Delta t = (9.63 \times 10^{-5} \text{ kg/s})(24 \times 3600 \text{ s}) = \mathbf{8.32 \text{ kg}}$$

Discussion This is the maximum amount of moisture that can migrate through the wall since we assumed the vapor pressure on one side of the wall to be zero.

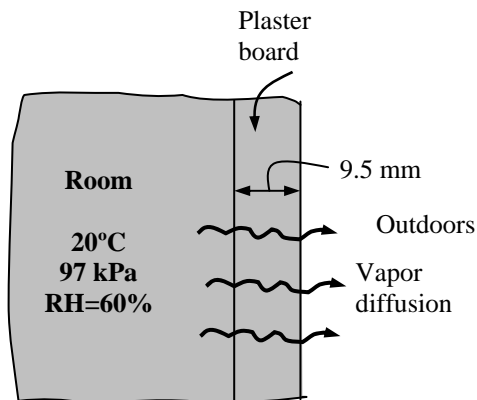

14-65 The inside wall of a house is finished with 9.5-mm thick gypsum wallboard with a 0.051-mm thick polyethylene film on one side. The maximum amount of water vapor that will diffuse through a 3 m × 8 m section of the wall in 24-h is to be determined.

Assumptions 1 Steady operating conditions exist. 2 Mass transfer through the wall is one-dimensional. 3 The vapor permeabilities of the wall and of the vapor barrier are constant. 4 The vapor pressure at the outer side of the wallboard is zero.

Properties The permeances of the 9.5 mm thick gypsum wall board and of the 0.051-mm thick polyethylene film are given to be 2.86×10^{-9} and 9.1×10^{-12} kg/s.m².Pa, respectively (Table 14-10). The saturation pressure of water at 20°C is 2339 Pa (Table 14-9).

Analysis The mass flow rate of water vapor through a two-layer plain wall of normal area A is given as (Eqs. 14-33 and 14-35)

$$\dot{m}_v = A \frac{P_{v,1} - P_{v,2}}{R_{v,\text{total}}} = A \frac{\phi_1 P_{\text{sat},1} - \phi_2 P_{\text{sat},2}}{R_{v,\text{total}}}$$

where $R_{v,\text{total}}$ is the total vapor resistance of the medium, ϕ is the relative humidity and P_{sat} is the saturation pressure of water at the specified temperature. Subscripts 1 and 2 denote the air on the two sides of the wall. The total vapor resistance of the wallboard is

$$\begin{aligned} R_{v,\text{total}} &= R_{v,\text{wall}} + R_{v,\text{film}} \\ &= \frac{1}{2.86 \times 10^{-9} \text{ kg/s.m}^2 \cdot \text{Pa}} + \frac{1}{9.1 \times 10^{-12} \text{ kg/s.m}^2 \cdot \text{Pa}} \\ &= 1.10 \times 10^{11} \text{ s.m}^2 \cdot \text{Pa/kg} \end{aligned}$$

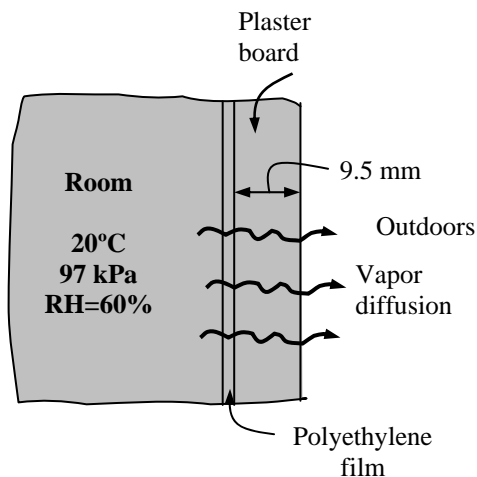

Noting that the vapor pressure at the outer side of the wallboard is zero ($\phi_2 = 0$) and substituting, the mass flow rate of water vapor through the wall is determined to be

$$\dot{m}_v = A \frac{\phi_1 P_{\text{sat},1} - \phi_2 P_{\text{sat},2}}{R_{v,\text{total}}} = (3 \times 8 \text{ m}^2) \frac{0.60(2339 \text{ Pa}) - 0}{1.10 \times 10^{11} \text{ s.m}^2 \cdot \text{Pa/kg}} = 3.06 \times 10^{-7} \text{ kg/s}$$

Then the total amount of moisture that flows through the wall during a 24-h period becomes

$$m_{v,24-h} = \dot{m}_v \Delta t = (3.06 \times 10^{-7} \text{ kg/s})(24 \times 3600 \text{ s}) = \mathbf{0.0264 \text{ kg} = 26.4 \text{ g}}$$

Discussion This is the maximum amount of moisture that can migrate through the wall since we assumed the vapor pressure on one side of the wall to be zero. Note that the vapor barrier reduced the amount of vapor migration to a negligible level.

14-66 The roof of a house is made of a 20-cm thick concrete layer. The amount of water vapor that will diffuse through a 15 m × 8 m section of the roof in 24-h is to be determined.

Assumptions 1 Steady operating conditions exist. 2 Mass transfer through the roof is one-dimensional. 3 The vapor permeability of the roof is constant.

Properties The permeability of the roof to water vapor is given to be 24.7×10^{-12} kg/s.m.Pa. The saturation pressures of water are 768 Pa at 3°C, and 3169 Pa at 25°C (Table 14-9).

Analysis The mass flow rate of water vapor through a plain layer of thickness L and normal area A is given as (Eq. 14-31)

$$\dot{m}_v = PA \frac{P_{v,1} - P_{v,2}}{L} = PA \frac{\phi_1 P_{\text{sat},1} - \phi_2 P_{\text{sat},2}}{L}$$

where P is the vapor permeability, ϕ is the relative humidity and P_{sat} is the saturation pressure of water at the specified temperature. Subscripts 1 and 2 denote the states of the air on the two sides of the roof. Substituting, the mass flow rate of water vapor through the roof is determined to be

$$\dot{m}_v = (24.7 \times 10^{-12} \text{ kg/s.m.Pa})(15 \times 8 \text{ m}^2) \frac{[0.50(3169 \text{ Pa}) - 0.30(768 \text{ Pa})]}{(0.20 \text{ m})} = 2.01 \times 10^{-5} \text{ kg/s}$$

Then the total amount of moisture that flows through the roof during a 24-h period becomes

$$m_{v,24-h} = \dot{m}_v \Delta t = (2.01 \times 10^{-5} \text{ kg/s})(24 \times 3600 \text{ s}) = \mathbf{1.74 \text{ kg}}$$

Discussion The moisture migration through the roof can be reduced significantly by covering the roof with a vapor barrier or vapor retarder.

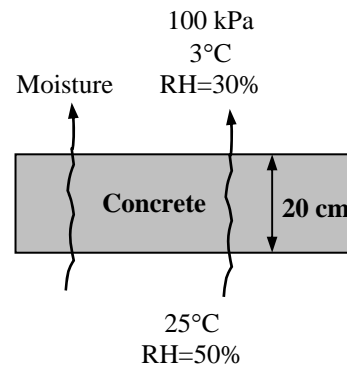

14-67 EES Prob. 14-66 is reconsidered. The effects of temperature and relative humidity of air inside the house on the amount of water vapor that will migrate through the roof are to be investigated.

Analysis The problem is solved using EES, and the solution is given below.

"GIVEN"

A=15*8 [m^2]
 L=0.20 [m]
 T_1=25 [C]
 phi_1=0.50
 P_atm=100 [kPa]
 time=24*3600 [s]
 T_2=3 [C]
 phi_2=0.30
 Permeability=24.7E-12 [kg/s-m-Pa]

"PROPERTIES"

Fluid\$='steam_IAPWS'
 P_sat1=Pressure(Fluid\$, T=T_1, x=1)*Convert(kPa, Pa)
 P_sat2=Pressure(Fluid\$, T=T_2, x=1)*Convert(kPa, Pa)

"ANALYSIS"

m_dot_v=Permeability*A*(phi_1*P_sat1-phi_2*P_sat2)/L
 m_v=m_dot_v*time

T ₁ [C]	m _v [kg]
15	0.8007
16	0.8731
17	0.9496
18	1.03
19	1.116
20	1.206
21	1.301
22	1.402
23	1.508
24	1.62
25	1.738
26	1.862
27	1.992
28	2.13
29	2.275
30	2.427

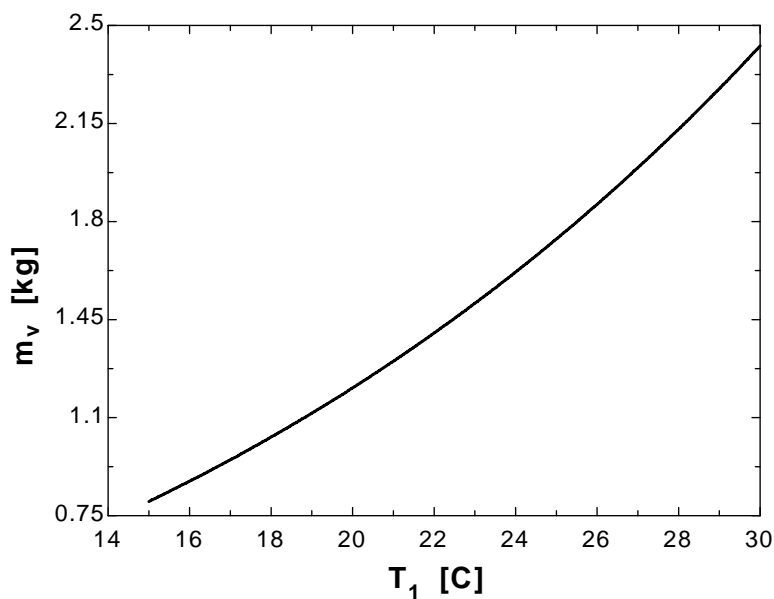

ϕ_1	m_v [kg]
0.3	0.9261
0.32	1.007
0.34	1.088
0.36	1.17
0.38	1.251
0.4	1.332
0.42	1.413
0.44	1.494
0.46	1.575
0.48	1.657
0.5	1.738
0.52	1.819
0.54	1.9
0.56	1.981
0.58	2.062
0.6	2.143
0.62	2.225
0.64	2.306
0.66	2.387
0.68	2.468
0.7	2.549

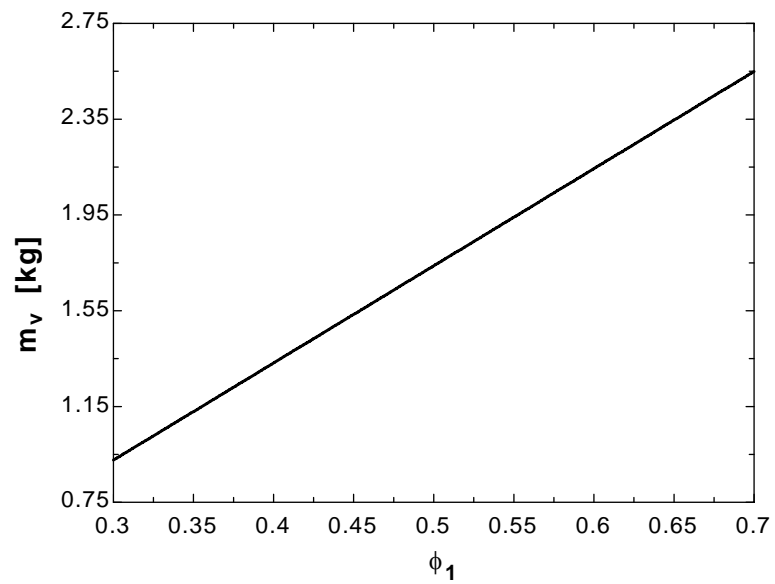

14-68 The roof of a house is made of a 20-cm thick concrete layer painted with a vapor retarder paint. The amount of water vapor that will diffuse through a 15 m × 8 m section of the roof in 24-h is to be determined.

Assumptions 1 Steady operating conditions exist. 2 Mass transfer through the roof is one-dimensional. 3 The vapor permeabilities of the roof and of the vapor barrier are constant.

Properties The permeability of concrete to water vapor and the permeance of the vapor retarder to water vapor are given to be 24.7×10^{-12} kg/s.m.Pa and 26×10^{-12} kg/s.m².Pa, respectively. The saturation pressures of water are 768 Pa at 3°C, and 3169 Pa at 25°C (Table 14-9).

Analysis The mass flow rate of water vapor through a two-layer plain roof of normal area A is given as (Eqs. 14-33 and 14-35)

$$\dot{m}_v = A \frac{P_{v,1} - P_{v,2}}{R_{v,\text{total}}} = A \frac{\phi_1 P_{\text{sat},1} - \phi_2 P_{\text{sat},2}}{R_{v,\text{total}}}$$

where $R_{v,\text{total}}$ is the total vapor resistance of the medium, ϕ is the relative humidity and P_{sat} is the saturation pressure of water at the specified temperature. Subscripts 1 and 2 denote the air on the two sides of the roof. The total vapor resistance of the roof is

$$\begin{aligned} R_{v,\text{total}} &= R_{v,\text{roof}} + R_{v,\text{film}} = \frac{L}{P} + \frac{1}{M} = \frac{0.20 \text{ m}}{24.7 \times 10^{-12} \text{ kg/s.m.Pa}} + \frac{1}{26 \times 10^{-12} \text{ kg/s.m}^2 \text{ .Pa}} \\ &= 4.66 \times 10^{10} \text{ s.m}^2 \text{ .Pa/kg} \end{aligned}$$

Substituting, the mass flow rate of water vapor through the roof is determined to be

$$\dot{m}_v = A \frac{\phi_1 P_{\text{sat},1} - \phi_2 P_{\text{sat},2}}{R_{v,\text{total}}} = (15 \times 8 \text{ m}^2) \frac{0.50(3169 \text{ Pa}) - 0.30(768 \text{ Pa})}{4.66 \times 10^{10} \text{ s.m}^2 \text{ .Pa/kg}} = 3.49 \times 10^{-6} \text{ kg/s}$$

Then the total amount of moisture that flows through the roof during a 24-h period becomes

$$m_{v,24\text{-h}} = \dot{m}_v \Delta t = (3.49 \times 10^{-6} \text{ kg/s})(24 \times 3600 \text{ s}) = \mathbf{0.301 \text{ kg} = 301 \text{ g}}$$

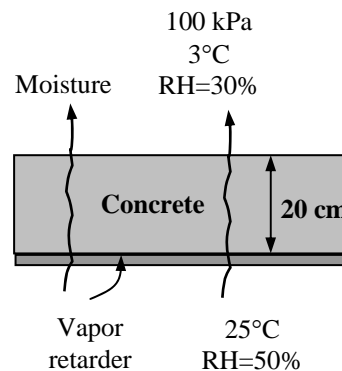

14-69 A glass of milk left on top of a counter is tightly sealed by a sheet of 0.009-mm thick aluminum foil. The drop in the level of the milk in the glass in 12 h due to vapor migration through the foil is to be determined.

Assumptions 1 Steady operating conditions exist. 2 Mass transfer through the foil is one-dimensional. 3 The vapor permeability of the foil is constant.

Properties The permeance of the foil to water vapor is given to be 2.9×10^{-12} kg/s.m².Pa. The saturation pressure of water at 15°C is 1705 Pa (Table 14-9). We take the density of milk to be 1000 kg/m³.

Analysis The mass flow rate of water vapor through a plain layer of thickness L and normal area A is given as (Eq. 14-31)

$$\dot{m}_v = PA \frac{P_{v,1} - P_{v,2}}{L} = PA \frac{\phi_1 P_{\text{sat},1} - \phi_2 P_{\text{sat},2}}{L} = MA(\phi_1 P_{\text{sat},1} - \phi_2 P_{\text{sat},2})$$

where P is the vapor permeability and $M = P/L$ is the permeance of the material, ϕ is the relative humidity and P_{sat} is the saturation pressure of water at the specified temperature. Subscripts 1 and 2 denote the states of the air on the two sides of the foil.

The diffusion area of the foil is $A = \pi r^2 = \pi(0.06 \text{ m})^2 = 0.0113 \text{ m}^2$.

Substituting, the mass flow rate of water vapor through the foil becomes

$$\begin{aligned} \dot{m}_v &= (2.9 \times 10^{-12} \text{ kg/s.m}^2 \cdot \text{Pa})(0.0113 \text{ m}^2)[1(1705 \text{ Pa}) - 0.5(1705 \text{ Pa})] \\ &= 2.79 \times 10^{-11} \text{ kg/s} \end{aligned}$$

Then the total amount of moisture that flows through the foil during a 12-h period becomes

$$m_{v,12\text{-h}} = \dot{m}_v \Delta t = (2.79 \times 10^{-11} \text{ kg/s})(12 \times 3600 \text{ s}) = 1.21 \times 10^{-6} \text{ kg}$$

$$\mathcal{V} = m / \rho = (1.21 \times 10^{-6} \text{ kg}) / (1000 \text{ kg/m}^3) = 1.21 \times 10^{-9} \text{ m}^3$$

Then the drop in the level of the milk becomes

$$\Delta h = \frac{\mathcal{V}}{A} = \frac{1.21 \times 10^{-9} \text{ m}^3}{0.0113 \text{ m}^2} = 1.1 \times 10^{-7} \text{ m} = \mathbf{0.0011 \text{ mm}}$$

Discussion The drop in the level of the milk in 12 h is very small, and thus it is not noticeable.

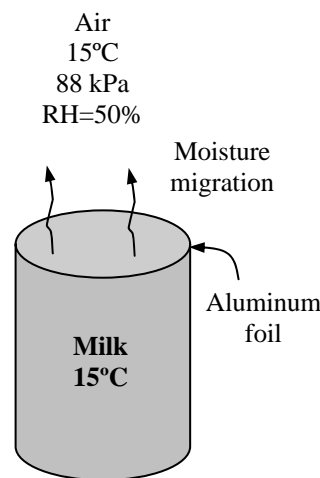

Transient Mass Diffusion

14-70C The diffusion of a solid species into another solid of finite thickness can usually be treated as a diffusion process in a semi-infinite medium regardless of the shape and thickness of the solid since the diffusion process affects a very thin layer at the surface.

14-71C The penetration depth is defined as the location where the tangent to the concentration profile at the surface ($x = 0$) intercepts the $C_A = C_{A,i}$ line, and it represents the depth of diffusion at a given time. The penetration depth can be determined to be

$$\delta_{diff} = \sqrt{\pi D_{AB} t}$$

where D_{AB} is the diffusion coefficient and t is the time.

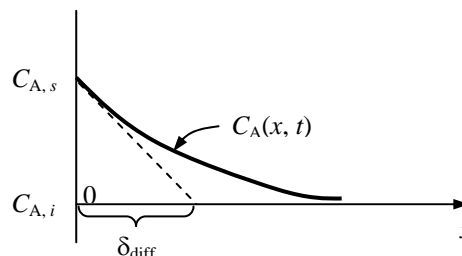

14-72C When the density of a species A in a semi-infinite medium is known initially and at the surface, the concentration of the species A at a specified location and time can be determined from

$$\frac{C_A(x, t) - C_{A,i}}{C_{A,s} - C_{A,i}} = \text{erfc}\left(\frac{x}{2\sqrt{D_{AB}t}}\right)$$

where $C_{A,i}$ is the initial concentration of species A at time $t = 0$, $C_{A,s}$ is the concentration at the inner side of the exposed surface of the medium, and erfc is the complementary error function.

14-73 A steel component is to be surface hardened by packing it in a carbonaceous material in a furnace at 1150 K. The length of time the component should be kept in the furnace is to be determined.

Assumptions **1** Carbon penetrates into a very thin layer beneath the surface of the component, and thus the component can be modeled as a semi-infinite medium regardless of its thickness or shape. **2** The initial carbon concentration in the steel component is uniform. **3** The carbon concentration at the surface remains constant.

Properties The relevant properties are given in the problem statement.

Analysis This problem is analogous to the one-dimensional transient heat conduction problem in a semi-infinite medium with specified surface temperature, and thus can be solved accordingly. Using mass fraction for concentration since the data is given in that form, the solution can be expressed as

$$\frac{w_A(x, t) - w_{A,i}}{w_{A,s} - w_{A,i}} = \operatorname{erfc}\left(\frac{x}{2\sqrt{D_{AB}t}}\right)$$

Substituting the specified quantities gives

$$\frac{0.0032 - 0.0012}{0.011 - 0.0012} = 0.204 = \operatorname{erfc}\left(\frac{x}{2\sqrt{D_{AB}t}}\right)$$

The argument whose complementary error function is 0.204 is determined from Table 4-4 to be 0.898. That is,

$$\frac{x}{2\sqrt{D_{AB}t}} = 0.898$$

Then solving for the time t gives

$$t = \frac{x^2}{4D_{AB}(0.898)^2} = \frac{(0.0007 \text{ m})^2}{4 \times (7.2 \times 10^{-12} \text{ m}^2/\text{s})(0.898)^2} = 21,098 \text{ s} = \mathbf{5.9 \text{ h}}$$

Therefore, the steel component must be held in the furnace for 5.9 h to achieve the desired level of hardening.

Discussion The diffusion coefficient of carbon in steel increases exponentially with temperature, and thus this process is commonly done at high temperatures to keep the diffusion time to a reasonable level.

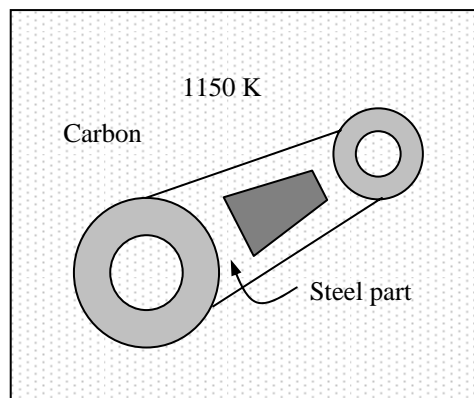

14-74 A steel component is to be surface hardened by packing it in a carbonaceous material in a furnace at 5000 K. The length of time the component should be kept in the furnace is to be determined.

Assumptions 1 Carbon penetrates into a very thin layer beneath the surface of the component, and thus the component can be modeled as a semi-infinite medium regardless of its thickness or shape. 2 The initial carbon concentration in the steel component is uniform. 3 The carbon concentration at the surface remains constant.

Properties The relevant properties are given in the problem statement.

Analysis This problem is analogous to the one-dimensional transient heat conduction problem in a semi-infinite medium with specified surface temperature, and thus can be solved accordingly. Using mass fraction for concentration since the data is given in that form, the solution can be expressed as

$$\frac{w_A(x, t) - w_{A,i}}{w_{A,s} - w_{A,i}} = \operatorname{erfc}\left(\frac{x}{2\sqrt{D_{AB}t}}\right)$$

Substituting the specified quantities gives

$$\frac{0.0032 - 0.0012}{0.011 - 0.0012} = 0.204 = \operatorname{erfc}\left(\frac{x}{2\sqrt{D_{AB}t}}\right)$$

The argument whose complementary error function is 0.204 is determined from Table 4-4 to be 0.898. That is,

$$\frac{x}{2\sqrt{D_{AB}t}} = 0.898$$

Solving for the time t gives

$$t = \frac{x^2}{4D_{AB}(0.742)^2} = \frac{(0.0007\text{ m})^2}{4 \times (2.1 \times 10^{-20}\text{ m}^2/\text{s})(0.898)^2} = 7.233 \times 10^{12}\text{ s} = 232,600\text{ years}$$

Therefore, the steel component must be held in the furnace forever to achieve the desired level of hardening.

Discussion The diffusion coefficient of carbon in steel increases exponentially with temperature, and thus this process is commonly done at high temperatures to keep the diffusion time to a reasonable level.

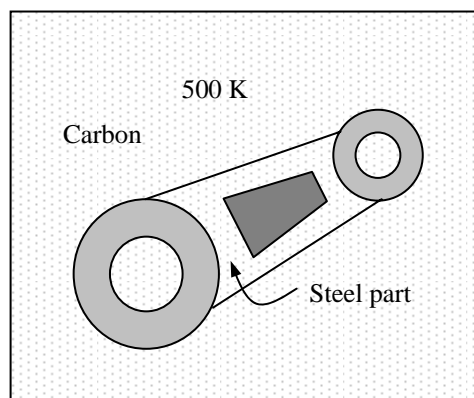

14-75 A pond is to be oxygenated by forming a tent over the water surface and filling the tent with oxygen gas. The molar concentration of oxygen at a depth of 1 cm from the surface after 24 h is to be determined.

Assumptions **1** The oxygen in the tent is saturated with water vapor. **2** Oxygen penetrates into a thin layer at the pond surface, and thus the pond can be modeled as a semi-infinite medium. **3** Both the water vapor and oxygen are ideal gases. **4** The initial oxygen content of the pond is zero.

Properties The diffusion coefficient of oxygen in water at 25°C is $D_{AB} = 2.4 \times 10^{-9} \text{ m}^2/\text{s}$ (Table 14-3a). Henry's constant for oxygen dissolved in water at 300 K ($\cong 25^\circ\text{C}$) is given in Table 14-6 to be $H = 43,600 \text{ bar}$. The saturation pressure of water at 25°C is 3.17 kPa (Table 14-9).

Analysis This problem is analogous to the one-dimensional transient heat conduction problem in a semi-infinite medium with specified surface temperature, and thus can be solved accordingly. The vapor pressure in the tent is the saturation pressure of water at 25°C since the oxygen in the tent is saturated, and thus the partial pressure of oxygen in the tank is

$$P_{O_2} = P - P_v = 130 - 3.17 = 126.83 \text{ kPa}$$

Then the mole fraction of oxygen in the water at the pond surface becomes

$$y_{O_2, \text{liquidside}}(0) = \frac{P_{O_2, \text{gasside}}(0)}{H} = \frac{1.2683 \text{ bar}}{43,600 \text{ bar}} = 2.91 \times 10^{-5}$$

The molar concentration of oxygen at a depth of 2 cm from the surface after 12 h can be determined from

$$\frac{y_{O_2}(x, t) - y_{O_2, i}}{y_{O_2, s} - y_{O_2, i}} = \text{erfc}\left(\frac{x}{2\sqrt{D_{AB}t}}\right)$$

Substituting,

$$\frac{y_{O_2}(x, t) - 0}{2.88 \times 10^{-5} - 0} = \text{erfc}\left(\frac{0.01 \text{ m}}{2\sqrt{(2.4 \times 10^{-9} \text{ m}^2/\text{s})(24 \times 3600 \text{ s})}}\right) = 0.665 \longrightarrow y_{O_2}(0.02 \text{ m}, 24 \text{ h}) = 1.92 \times 10^{-5}$$

Therefore, there will be 18 moles of oxygen per million at a depth of 1 cm from the surface in 24 h.

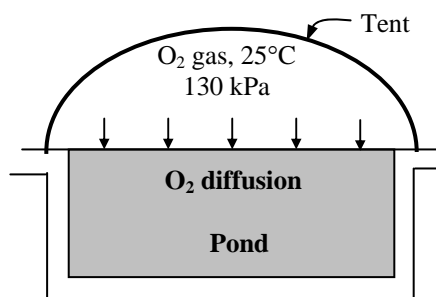

14-76 A long cylindrical nickel bar saturated with hydrogen is taken into an area that is free of hydrogen. The length of time for the hydrogen concentration at the center of the bar to drop by half is to be determined.

Assumptions **1** The bar can be treated as an infinitely long cylinder since it is very long and there is symmetry about the centerline. **2** The initial hydrogen concentration in the steel bar is uniform. **3** The hydrogen concentration at the surface remains constant at zero at all times. **4** The Fourier number is $\tau > 0.2$ so that the one-term transient solutions are valid.

Properties The molar mass of hydrogen H_2 is $M = 2 \text{ kg / kmol}$ (Table A-1). The solubility of hydrogen in nickel at 358 K is $0.00901 \text{ kmol / m}^3 \cdot \text{bar}$ (Table 14-7). The diffusion coefficient of hydrogen in nickel at 298 K is $D_{AB} = 1.2 \times 10^{-12} \text{ m}^2/\text{s}$ (Table 14-3b).

Analysis This problem is analogous to the one-dimensional transient heat conduction problem in an infinitely long cylinder with specified surface temperature, and thus can be solved accordingly. Noting that $300 \text{ kPa} = 3 \text{ bar}$, the molar density of hydrogen in the nickel bar before it is taken out of the storage room is

$$\begin{aligned} C_{H_2, \text{solidside}}(0) &= S \times P_{H_2, \text{gas side}} \\ &= (0.00901 \text{ kmol/m}^3 \cdot \text{bar})(3 \text{ bar}) \\ &= 0.027 \text{ kmol/m}^3 \end{aligned}$$

The molar concentration of hydrogen at the center of the bar can be calculated from

$$\frac{C_{H_2, o} - C_{H_2, \infty}}{C_{H_2, i} - C_{H_2, \infty}} = A_1 e^{-\lambda_1^2 \tau}$$

The Biot number in this case can be taken to be infinity since the bar is in a well-ventilated area during the transient case. The constants A_1 and λ_1 for the infinite Bi are determined from Table 4-2 to be 1.6021 and 2.4048, respectively. Noting that the concentration of hydrogen at the outer surface is zero, and the concentration of hydrogen at the center of the bar is one half of the initial concentration, the Fourier number, τ , can be determined from

$$\frac{(0.027 / 2) - 0}{0.027 - 0} = 1.6021 e^{-(2.4048)^2 \tau} \longrightarrow \tau = 0.2014$$

Using the definition of the Fourier number, the time required to drop the concentration of hydrogen by half is determined to be

$$\tau = \frac{D_{AB} t}{r_o^2} \longrightarrow t = \frac{\tau r_o^2}{D_{AB}} = \frac{(0.2014)(0.025)^2}{1.2 \times 10^{-12}} = 1.049 \times 10^8 \text{ s} = 1214 \text{ days} = \mathbf{3.33 \text{ years}}$$

Therefore, it will take years for this nickel bar to be free of hydrogen.

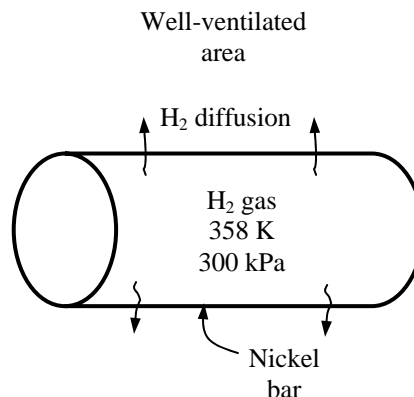

Diffusion in a Moving Medium

14-77C The **mass-average velocity** of a medium at some location is the average velocity of the mass at that location relative to an external reference point. It is the velocity that would be measured by a velocity sensor such as a pitot tube, a turbine device, or a hot wire anemometer inserted into the flow. The **diffusion velocity** at a location is the average velocity of a group of molecules at that location moving under the influence of concentration gradient. A **stationary medium** is a medium whose mass average velocity is zero. A **moving medium** is a medium that involves a bulk fluid motion caused by an external force.

14-78C The **diffusion velocity** at a location is the average velocity of a group of molecules at that location moving under the influence of concentration gradient. The average velocity of a species in a moving medium is equal to the sum of the bulk flow velocity and the diffusion velocity. Therefore, the diffusion velocity can increase or decrease the average velocity, depending on the direction of diffusion relative to the direction of bulk flow. The velocity of a species in the moving medium relative to a fixed reference point **will be zero** when the diffusion velocity of the species and the bulk flow velocity are equal in magnitude and opposite in direction.

14-79 C The **mass-average velocity** of a medium at some location is the average velocity of the mass at that location relative to an external reference point. The **molar-average velocity** of a medium at some location is the average velocity of the molecules at that location, regardless of their mass, relative to an external reference point. If one of these velocities are zero, the other will not necessarily be zero. The mass-average and molar-average velocities of a binary mixture will be the same when the molar masses of the two constituents are equal to each other. The mass and mole fractions of each species in this case will be the same.

14-80C (a) T, (b) T, (c) F, (d) F

14-81C The diffusion of a vapor through a stationary gas column is called the **Stefan flow**. The **Stefan's law** can be expressed as

$$\bar{j}_A = \dot{N}_A / A = \frac{CD_{AB}}{L} \ln \frac{1 - y_{A,L}}{1 - y_{A,o}}$$

where C is the average concentration of the mixture, D_{AB} is the diffusion coefficient of A in B , L is the height of the gas column, $y_{A,L}$ is the molar concentration of a species at $x = L$, and $y_{A,o}$ is the molar concentration of the species A at $x = 0$.

14-82E The pressure in a helium pipeline is maintained constant by venting to the atmosphere through a long tube. The mass flow rates of helium and air, and the net flow velocity at the bottom of the tube are to be determined.

Assumptions 1 Steady operating conditions exist. 2 Helium and atmospheric air are ideal gases. 3 No chemical reactions occur in the tube. 4 Air concentration in the pipeline and helium concentration in the atmosphere are negligible so that the mole fraction of the helium is 1 in the pipeline, and 0 in the atmosphere (we will check this assumption later).

Properties The diffusion coefficient of helium in air (or air in helium) at normal atmospheric conditions is $D_{AB} = 7.75 \times 10^{-4} \text{ ft}^2/\text{s}$ (Table 14-2). The molar mass of helium is $M = 4 \text{ lbm} / \text{lbmol}$, and the molar mass of air is $29 \text{ lbm} / \text{lbmol}$ (Table A-1E).

Analysis This is a typical equimolar counterdiffusion process since the problem involves two large reservoirs of ideal gas mixtures connected to each other by a channel, and the concentrations of species in each reservoir (the pipeline and the atmosphere) remain constant.

(a) The flow area, which is the cross-sectional area of the tube, is

$$A = \pi D^2 / 4 = \pi (0.25 / 12 \text{ ft})^2 / 4 = 3.41 \times 10^{-4} \text{ ft}^2$$

Noting that the pressure of helium is 14.5 psia at the bottom of the tube ($x = 0$) and 0 at the top ($x = L$), its molar flow rate is

$$\begin{aligned} \dot{N}_{\text{helium}} = \dot{N}_{\text{diff,A}} &= \frac{D_{AB} A}{R_u T} \frac{P_{A,0} - P_{A,L}}{L} \\ &= \frac{(7.75 \times 10^{-4} \text{ ft}^2/\text{s})(3.41 \times 10^{-4} \text{ ft}^2)}{(10.73 \text{ psia} \cdot \text{ft}^3/\text{lbmol} \cdot \text{R})(540 \text{ R})} \frac{(14.5 - 0) \text{ psia}}{30 \text{ ft}} \\ &= 2.20 \times 10^{-11} \text{ lbmol/s} \end{aligned}$$

Therefore, the mass flow rate of helium through the tube is

$$\dot{m}_{\text{helium}} = (\dot{N}M)_{\text{helium}} = (2.20 \times 10^{-11} \text{ lbmol/s})(4 \text{ lbm/lbmol}) = \mathbf{8.80 \times 10^{-11} \text{ lbm/s}}$$

which corresponds to 0.00278 lbm per year.

(b) Noting that $\dot{N}_B = -\dot{N}_A$ during an equimolar counterdiffusion process, the molar flow rate of air into the helium pipeline is equal to the molar flow rate of helium. Thus the mass flow rate of air into the pipeline is

$$\dot{m}_{\text{air}} = (\dot{N}M)_{\text{air}} = (-2.20 \times 10^{-11} \text{ lbmol/s})(29 \text{ lbm/lbmol}) = \mathbf{-6.38 \times 10^{-10} \text{ lbm/s}}$$

The mass fraction of air in helium pipeline is

$$w_{\text{air}} = \frac{|\dot{m}_{\text{air}}|}{\dot{m}_{\text{total}}} = \frac{6.38 \times 10^{-10} \text{ lbm/s}}{(5 + 6.38 \times 10^{-10} - 8.8 \times 10^{-11}) \text{ lbm/s}} = 1.28 \times 10^{-10} \approx 0$$

which validates our original assumption of negligible air in the pipeline.

(c) The net mass flow rate through the tube is

$$\dot{m}_{\text{net}} = \dot{m}_{\text{helium}} + \dot{m}_{\text{air}} = 8.80 \times 10^{-11} - 6.38 \times 10^{-10} = \mathbf{-5.50 \times 10^{-10} \text{ lbm/s}}$$

The mass fraction of air at the bottom of the tube is very small, as shown above, and thus the density of the mixture at $x = 0$ can simply be taken to be the density of helium which is

$$\rho \cong \rho_{\text{helium}} = \frac{P}{RT} = \frac{14.5 \text{ psia}}{(2.681 \text{ psia} \cdot \text{ft}^3/\text{lbm} \cdot \text{R})(540 \text{ R})} = 0.01002 \text{ lbm/ft}^3$$

Then the average flow velocity at the bottom part of the tube becomes

$$V = \frac{\dot{m}_{\text{net}}}{\rho A} = \frac{-5.50 \times 10^{-10} \text{ lbm/s}}{(0.01002 \text{ lbm/ft}^3)(3.41 \times 10^{-4} \text{ ft}^2)} = \mathbf{-1.61 \times 10^{-4} \text{ ft/s}}$$

Discussion This flow rate is difficult to measure by even the most sensitive velocity measurement devices. The negative sign indicates flow in the negative x direction (towards the pipeline).

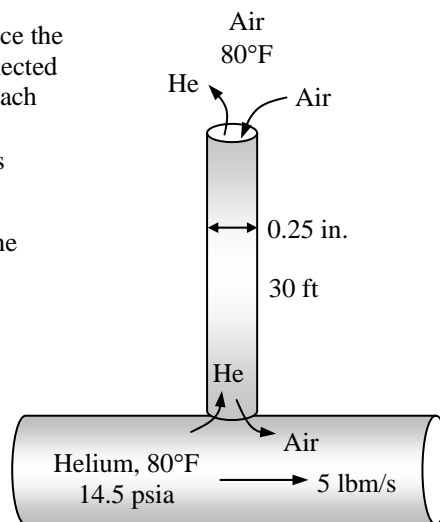

14-83E The pressure in a carbon dioxide pipeline is maintained constant by venting to the atmosphere through a long tube. The mass flow rates of carbon dioxide and air, and the net flow velocity at the bottom of the tube are to be determined.

Assumptions 1 Steady operating conditions exist. 2 Carbon dioxide and atmospheric air are ideal gases. 3 No chemical reactions occur in the tube. 4 Air concentration in the pipeline and carbon dioxide concentration in the atmosphere are negligible so that the mole fraction of the carbon dioxide is 1 in the pipeline, and 0 in the atmosphere (we will check this assumption later).

Properties The diffusion coefficient of carbon dioxide in air (or air in carbon dioxide) at normal atmospheric conditions is $D_{AB} = 1.72 \times 10^{-4} \text{ ft}^2/\text{s}$ (Table 14-2). The molar mass of carbon dioxide is $M = 44 \text{ lbm/lbmol}$, and the molar mass of air is 29 lbm/lbmol (Table A-1E).

Analysis This is a typical equimolar counterdiffusion process since the problem involves two large reservoirs of ideal gas mixtures connected to each other by a channel, and the concentrations of species in each reservoir (the pipeline and the atmosphere) remain constant.

(a) The flow area, which is the cross-sectional area of the tube, is

$$A = \pi D^2 / 4 = \pi (0.25 / 12 \text{ ft})^2 / 4 = 3.41 \times 10^{-4} \text{ ft}^2$$

Noting that the pressure of carbon dioxide is 14.5 psia at the bottom of the tube ($x = 0$) and 0 at the top ($x = L$), its molar flow rate is determined from Eq. 14-64 to be

$$\begin{aligned} \dot{N}_{\text{helium}} = \dot{N}_{\text{diff,A}} &= \frac{D_{AB} A}{R_u T} \frac{P_{A,0} - P_{A,L}}{L} \\ &= \frac{(1.72 \times 10^{-4} \text{ ft}^2/\text{s})(3.41 \times 10^{-4} \text{ ft}^2)}{(10.73 \text{ psia} \cdot \text{ft}^3/\text{lbmol} \cdot \text{R})(540 \text{ R})} \frac{(14.5 - 0) \text{ psia}}{30 \text{ ft}} \\ &= 4.89 \times 10^{-12} \text{ lbmol/s} \end{aligned}$$

Therefore, the mass flow rate of carbon dioxide through the tube is

$$\dot{m}_{\text{CO}_2} = (\dot{N}M)_{\text{CO}_2} = (4.89 \times 10^{-12} \text{ lbmol/s})(44 \text{ lbm/lbmol}) = \mathbf{2.15 \times 10^{-10} \text{ lbm/s}}$$

which corresponds to 0.00678 lbm per year.

(b) Noting that $\dot{N}_B = -\dot{N}_A$ during an equimolar counter diffusion process, the molar flow rate of air into the CO_2 pipeline is equal to the molar flow rate of CO_2 . Thus the mass flow rate of air into the pipeline is

$$\dot{m}_{\text{air}} = (\dot{N}M)_{\text{air}} = (-4.89 \times 10^{-12} \text{ lbmol/s})(29 \text{ lbm/lbmol}) = \mathbf{-1.42 \times 10^{-10} \text{ lbm/s}}$$

The mass fraction of air in carbon dioxide pipeline is

$$w_{\text{air}} = \frac{|\dot{m}_{\text{air}}|}{\dot{m}_{\text{total}}} = \frac{1.42 \times 10^{-10} \text{ lbm/s}}{(5 + 1.42 \times 10^{-10} - 2.15 \times 10^{-10}) \text{ lbm/s}} = 2.84 \times 10^{-11} \approx 0$$

which validates our original assumption of negligible air in the pipeline.

(c) The net mass flow rate through the tube is

$$\dot{m}_{\text{net}} = \dot{m}_{\text{CO}_2} + \dot{m}_{\text{air}} = 2.15 \times 10^{-10} - 1.42 \times 10^{-10} = -7.3 \times 10^{-11} \text{ lbm/s}$$

The mass fraction of air at the bottom of the tube is very small, as shown above, and thus the density of the mixture at $x = 0$ can simply be taken to be the density of carbon dioxide which is

$$\rho \cong \rho_{\text{CO}_2} = \frac{P}{RT} = \frac{14.5 \text{ psia}}{(0.2438 \text{ psia} \cdot \text{ft}^3/\text{lbm} \cdot \text{R})(540 \text{ R})} = 0.110 \text{ lbm/ft}^3$$

Then the average flow velocity at the bottom part of the tube becomes

$$V = \frac{\dot{m}_{\text{net}}}{\rho A} = \frac{-7.30 \times 10^{-11} \text{ lbm/s}}{(0.110 \text{ lbm/ft}^3)(3.41 \times 10^{-4} \text{ ft}^2)} = \mathbf{-1.95 \times 10^{-6} \text{ ft/s}}$$

Discussion This flow rate is difficult to measure by even the most sensitive velocity measurement devices. The negative sign indicates flow in the negative x direction (towards the pipeline).

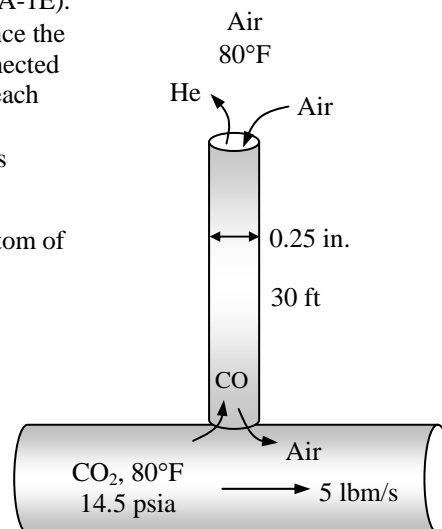

14-84 A hydrogen tank is maintained at atmospheric temperature and pressure by venting to the atmosphere through the charging valve. The initial mass flow rate of hydrogen out of the tank is to be determined.

Assumptions 1 Steady operating conditions at initial conditions exist. 2 Hydrogen and atmospheric air are ideal gases. 3 No chemical reactions occur in the valve. 4 Air concentration in the tank and hydrogen concentration in the atmosphere are negligible so that the mole fraction of the hydrogen is 1 in the tank, and 0 in the atmosphere (we will check this assumption later).

Properties The molar mass of hydrogen is $M = 2 \text{ kg/kmol}$ (Table A-1). The diffusion coefficient of hydrogen in air (or air in hydrogen) at 1 atm and 25°C is $D_{AB} = 7.2 \times 10^{-5} \text{ m}^2/\text{s}$ (Table 14-2). However, the pressure in the tank is $90 \text{ kPa} = 0.88 \text{ atm}$. The diffusion coefficient at 25°C and 0.88 atm is determined from

$$D_{AB} = \frac{D_{AB,1 \text{ atm}}}{P (\text{in atm})} = \frac{7.2 \times 10^{-5}}{0.88} = 8.18 \times 10^{-5} \text{ m}^2/\text{s}$$

Analysis This is a typical equimolar counterdiffusion process since the problem involves two large reservoirs of ideal gas mixtures connected to each other by a channel, and the concentrations of species in each reservoir (the pipeline and the atmosphere) remain constant. The cross-sectional area of the valve is

$$A = \pi D^2 / 4 = \pi (0.03 \text{ m})^2 / 4 = 7.069 \times 10^{-4} \text{ m}^2$$

Noting that the pressure of hydrogen is 90 kPa at the bottom of the charging valve ($x = 0$) and 0 kPa at the top ($x = L$), its molar flow rate is determined from Eq. 14-64 to be

$$\begin{aligned} \dot{N}_{\text{H}_2} &= \dot{N}_{\text{diff},A} = \frac{D_{AB} A}{R_u T} \frac{P_{A,0} - P_{A,L}}{L} \\ &= \frac{(8.18 \times 10^{-5} \text{ m}^2/\text{s})(7.069 \times 10^{-4} \text{ m}^2) (90 - 0) \text{ kPa}}{(8.314 \text{ kPa} \cdot \text{m}^3/\text{kmol} \cdot \text{K})(298 \text{ K})} \frac{1}{0.1 \text{ m}} \\ &= 2.098 \times 10^{-8} \text{ kmol/s} \end{aligned}$$

Then the mass flow rate of hydrogen becomes

$$\dot{m}_{\text{H}_2} = (\dot{N}M)_{\text{H}_2} = (2.081 \times 10^{-8} \text{ kmol/s})(2 \text{ kg/kmol}) = \mathbf{4.2 \times 10^{-8} \text{ kg/s}}$$

Discussion This is the highest mass flow rate. It will decrease during the process as air diffuses into the tank and the concentration of hydrogen in tank drops.

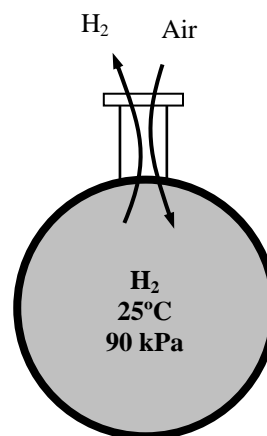

14-85 EES Prob. 14-84 is reconsidered. The mass flow rate of hydrogen lost as a function of the diameter of the charging valve is to be plotted.

Analysis The problem is solved using EES, and the solution is given below.

"GIVEN"

thickness=0.02 [m]

T=25+273 [K]

P_atm=90 [kPa]

D=3 [cm]

extension=0.08 [m]

L=0.10 [m]

"PROPERTIES"

MM_H2=Molar mass(H2)

D_AB_1atm=7.2E-5 [m^2/s] "from Table 14-2 of the text at 1 atm and 25 C"

D_AB=D_AB_1atm*P_1atm/(P_atm*Convert(kPa, atm)) "at 90 kPa and 25 C"

P_1atm=1 [atm]

R_u=8.314 [kJPa-m^3/kmol-K]

"ANALYSIS"

A=pi*D^2/4*Convert(cm^2, m^2)

N_dot_H2=(D_AB*A)/(R_u*T)*(P_atm-0)/L

m_dot_H2=N_dot_H2*MM_H2

D [cm]	m _{H2} [kg/s]
1	4.662E-09
1.2	6.714E-09
1.4	9.138E-09
1.6	1.193E-08
1.8	1.511E-08
2	1.865E-08
2.2	2.257E-08
2.4	2.686E-08
2.6	3.152E-08
2.8	3.655E-08
3	4.196E-08
3.2	4.774E-08
3.4	5.390E-08
3.6	6.043E-08
3.8	6.733E-08
4	7.460E-08
4.2	8.225E-08
4.4	9.026E-08
4.6	9.866E-08
4.8	1.074E-07
5	1.165E-07

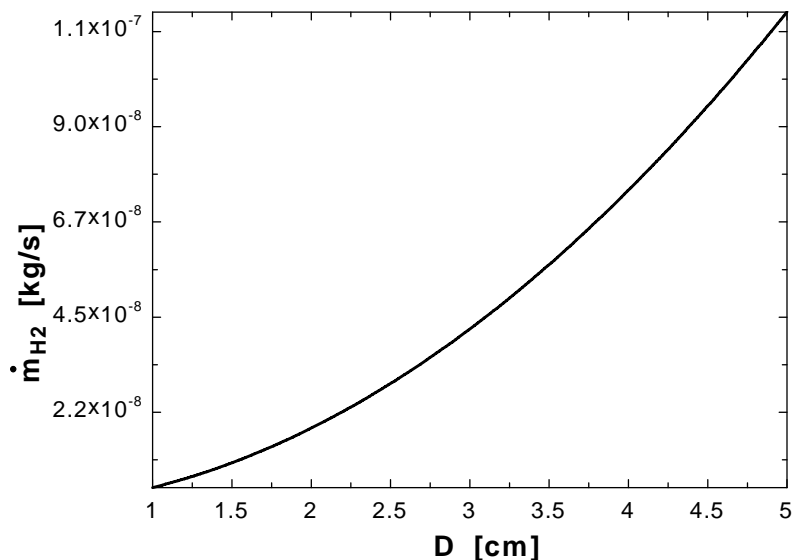

14-86E The amount of water that evaporates from a Stefan tube at a specified temperature and pressure over a specified time period is measured. The diffusion coefficient of water vapor in air is to be determined.

Assumptions **1** Water vapor and atmospheric air are ideal gases. **2** The amount of air dissolved in liquid water is negligible. **3** Heat is transferred to the water from the surroundings to make up for the latent heat of vaporization so that the temperature of water remains constant at 80°F.

Properties The saturation pressure of water at 80°F is 0.5073 psia (Table A-9E).

Analysis The vapor pressure at the air-water interface is the saturation pressure of water at 80°F, and the mole fraction of water vapor (species A) is determined from

$$y_{\text{vapor},o} = y_{A,o} = \frac{P_{\text{vapor},o}}{P} = \frac{0.5073 \text{ psia}}{13.8 \text{ psia}} = 0.0368$$

Dry air is blown on top of the tube and thus $y_{\text{vapor},L} = y_{A,L} = 0$. Also, the total molar density throughout the tube remains constant because of the constant temperature and pressure conditions, and is determined to be

$$C = \frac{P}{R_u T} = \frac{13.8 \text{ psia}}{(10.73 \text{ psia} \cdot \text{ft}^3 / \text{lbmol} \cdot \text{R})(540 \text{ R})} = 0.00238 \text{ lbmol/ft}^3$$

The cross-sectional area of the valve is

$$A = \pi D^2 / 4 = \pi (1/12 \text{ ft})^2 / 4 = 5.45 \times 10^{-3} \text{ ft}^2$$

The evaporation rate is given to be 0.0025 lbm per 10 days. Then the molar flow rate of vapor is determined to be

$$\dot{N}_A = \dot{N}_{\text{vapor}} = \frac{m_{\text{vapor}}}{M_{\text{vapor}}} = \frac{0.0025 \text{ lbm}}{(10 \times 24 \times 3600 \text{ s})(18 \text{ lbm/lbmol})} = 1.61 \times 10^{-10} \text{ lbmol/s}$$

Finally, substituting the information above into Eq. 14-59 we get

$$\frac{\dot{N}_A}{A} = \frac{CD_{AB}}{L} \ln \left(\frac{1 - y_{A,L}}{1 - y_{A,o}} \right) \longrightarrow \frac{1.61 \times 10^{-10} \text{ lbmol/s}}{5.45 \times 10^{-3} \text{ ft}^2} = \frac{(0.00238 \text{ lbmol/ft}^3) D_{AB}}{10/12 \text{ ft}} \ln \left(\frac{1 - 0}{1 - 0.0368} \right)$$

It gives

$$D_{AB} = 2.76 \times 10^{-4} \text{ ft}^2/\text{s}$$

for the binary diffusion coefficient of water vapor in air at 80°F and 13.8 psia.

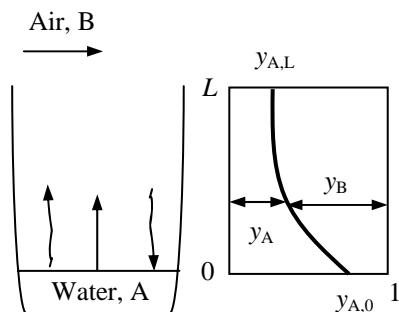

14-87 A pitcher that is half filled with water is left in a room with its top open. The time it takes for the entire water in the pitcher to evaporate is to be determined.

Assumptions **1** Water vapor and atmospheric air are ideal gases. **2** The amount of air dissolved in liquid water is negligible. **3** Heat is transferred to the water from the surroundings to make up for the latent heat of vaporization so that the temperature of water remains constant at 15°C.

Properties The saturation pressure of water at 15°C is 1.705 kPa (Table A-9). The density of water in the pitcher can be taken to be 1000 kg/m³. The diffusion coefficient of water vapor in air at 15°C (= 288 K) and 87 kPa (0.86 atm) can be determined from

$$D_{AB} = 1.87 \times 10^{-10} \frac{T^{2.072}}{P} = 1.87 \times 10^{-10} \frac{(288 \text{ K})^{2.072}}{0.86} = 2.71 \times 10^{-5} \text{ m}^2/\text{s}$$

Analysis The flow area, which is the cross-sectional area of the pitcher, is

$$A = \pi D^2 / 4 = \pi (0.08 \text{ m})^2 / 4 = 5.026 \times 10^{-3} \text{ m}^2$$

The vapor pressure at the air-water interface is the saturation pressure of water at 15°C, which is 1.705 kPa. The air at the top of the pitcher ($x = L$) can be assumed to be dry ($P_{A,L} = 0$). The distance between the water surface and the top of the pitcher is initially 15 cm, and will be 30 cm at the end of the process when all the water is evaporated. Therefore, we can take the average height of the air column above the water surface to be $(15+30)/2 = 22.5$ cm. Then the molar flow rate is determined from

$$\begin{aligned} \dot{N}_A &= \frac{D_{AB} A}{R_u T} \left(\frac{P_{A,o} - P_{A,L}}{L} \right) \\ &= \frac{(2.71 \times 10^{-5} \text{ m}^2/\text{s})(5.026 \times 10^{-3} \text{ m}^2) (1.705 - 0) \text{ kPa}}{(8.314 \text{ kPa} \cdot \text{m}^3/\text{kmol} \cdot \text{K})(288 \text{ K}) (0.225 \text{ m})} \\ &= 4.31 \times 10^{-10} \text{ kmol/s} \end{aligned}$$

The initial mass of water in the pitcher is

$$m_{\text{water}} = \rho \frac{\pi D^2}{4} L = (1000 \text{ kg/m}^3) \frac{\pi (0.08 \text{ m})^2}{4} (0.15 \text{ m}) = 0.754 \text{ kg}$$

Then the time required to evaporate the water completely becomes

$$\begin{aligned} \dot{N}_{\text{vapor}} &= \frac{m_{\text{vapor}}}{\Delta t \times M_{\text{vapor}}} \\ \Delta t &= \frac{m_{\text{vapor}}}{\dot{N}_{\text{vapor}} \times M_{\text{vapor}}} = \frac{0.754 \text{ kg}}{(4.31 \times 10^{-10} \text{ kmol/s})(18 \text{ kg/kmol})} = \mathbf{9.719 \times 10^7 \text{ s}} \end{aligned}$$

which is equivalent to 1125 days. Therefore, it will take the water in the pitcher about 3 years to evaporate completely.

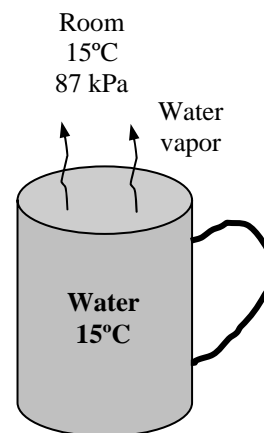

14-88 A large ammonia tank is vented to the atmosphere. The rate of loss of ammonia and the rate of air infiltration into the tank are to be determined.

Assumptions 1 Ammonia vapor and atmospheric air are ideal gases. **2** The amount of air dissolved in liquid ammonia is negligible. **3** Heat is transferred to the ammonia from the surroundings to make up for the latent heat of vaporization so that the temperature of ammonia remains constant at 25°C.

Properties The molar mass of ammonia is $M = 17$ kg/kmol, and the molar mass of air is $M = 29$ kg/kmol (Table A-1). The diffusion coefficient of ammonia in air (or air in ammonia) at 1 atm and 25°C is $D_{AB} = 2.6 \times 10^{-5}$ m²/s (Table 14-2).

Analysis This is a typical equimolar counterdiffusion process since the problem involves two large reservoirs of ideal gas mixtures connected to each other by a channel, and the concentrations of species in each reservoir (the tank and the atmosphere) remain constant. The flow area, which is the cross-sectional area of the tube, is

$$A = \pi D^2 / 4 = \pi (0.015 \text{ m})^2 / 4 = 1.767 \times 10^{-4} \text{ m}^2$$

Noting that the pressure of ammonia is 1 atm = 101.3 kPa at the bottom of the tube ($x = 0$) and 0 at the top ($x = L$), its molar flow rate is determined from Eq. 14-64 to be

$$\begin{aligned} \dot{N}_{\text{ammonia}} = \dot{N}_{\text{diff,A}} &= \frac{D_{AB} A}{R_u T} \frac{P_{A,o} - P_{A,L}}{L} \\ &= \frac{(2.6 \times 10^{-5} \text{ m}^2/\text{s})(1.767 \times 10^{-4} \text{ m}^2)}{(8.314 \text{ kPa} \cdot \text{m}^3/\text{kmol} \cdot \text{K})(298 \text{ K})} \frac{(101.3 - 0) \text{ kPa}}{2 \text{ m}} \\ &= \mathbf{9.39 \times 10^{-11} \text{ kmol/s}} \end{aligned}$$

Therefore, the mass flow rate of ammonia through the tube is

$$\dot{m}_{\text{NH}_3} = (\dot{N}M)_{\text{NH}_3} = (9.39 \times 10^{-11} \text{ kmol/s})(17 \text{ kg/kmol}) = \mathbf{1.60 \times 10^{-9} \text{ kg/s}}$$

which corresponds to 0.0504 kg per year.

Note that $\dot{N}_B = -\dot{N}_A$ during an equimolar counterdiffusion process. Therefore, the molar flow rate of air into the ammonia tank is equal to the molar flow rate of ammonia out of the tank. Then the mass flow rate of air into the pipeline becomes

$$\dot{m}_{\text{air}} = (\dot{N}M)_{\text{air}} = (-9.39 \times 10^{-11} \text{ kmol/s})(29 \text{ kg/kmol}) = \mathbf{-2.72 \times 10^{-9} \text{ kg/s}}$$

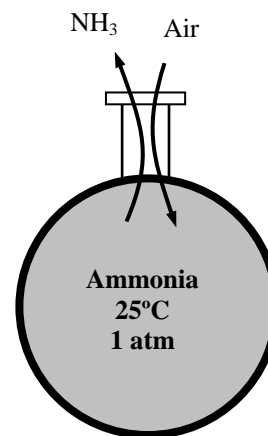

Mass Convection

14-89C Mass convection is expressed on a mass basis in an analogous manner to heat transfer as

$$\dot{m}_{\text{conv}} = h_{\text{mass}} A_s (\rho_{A,s} - \rho_{A,\infty})$$

where h_{mass} is the average mass transfer coefficient in m/s, A_s is the surface area in m^2 , and $\rho_{A,s}$ and $\rho_{A,\infty}$ are the densities of species A at the surface (on the fluid side) and the free stream, respectively.

14-90C The region of the fluid near the surface in which concentration gradients exist is called the **concentration boundary layer**. In **flow over a plate**, the thickness of the concentration boundary layer δ_c for a species A at a specified location on the surface is defined as the normal distance y from the surface at which

$$\frac{\rho_{A,s} - \rho_A}{\rho_{A,s} - \rho_\infty} = 0.99$$

where $\rho_{A,s}$ and $\rho_{A,\infty}$ are the densities of species A at the surface (on the fluid side) and the free stream, respectively.

14-91C The dimensionless **Schmidt number** is defined as the ratio of momentum diffusivity to mass diffusivity $Sc = \nu / D_{AB}$, and it represents the relative magnitudes of momentum and mass diffusion at molecular level in the velocity and concentration boundary layers, respectively. The Schmidt number corresponds to the *Prandtl number* in heat transfer. A Schmidt number of *unity* indicates that momentum and mass transfer by diffusion are comparable, and velocity and concentration boundary layers almost coincide with each other.

14-92C The dimensionless **Sherwood number** is defined as $Sh = h_{\text{mass}} L / D_{AB}$ where L is the characteristic length, h_{mass} is the mass transfer coefficient and D_{AB} is the mass diffusivity. The Sherwood number represents the effectiveness of mass convection at the surface, and serves as the dimensionless mass transfer coefficient. The Sherwood number corresponds to the *Nusselt number* in heat transfer. A Sherwood number of unity for a plain fluid layer indicates mass transfer by pure diffusion in a fluid.

14-93C The dimensionless **Lewis number** is defined as the ratio of thermal diffusivity to mass diffusivity ($Le = \alpha / D_{AB}$), and it represents the relative magnitudes of heat and mass diffusion at molecular level in the thermal and concentration boundary layers, respectively. A Lewis number of unity indicates that heat and mass diffuse at the same rate, and the thermal and concentration boundary layers coincide.

14-94C Yes, the Grashof number evaluated using density difference instead of temperature difference can also be used in natural convection heat transfer calculations. In natural convection heat transfer, the term $\Delta\rho/\rho$ is replaced by $\beta\Delta T$ for convenience in calculations.

14-95C Using the analogy between heat and mass transfer, the mass transfer coefficient can be determined from the relations for heat transfer coefficient using the **Chilton-Colburn Analogy** expressed as

$$\frac{h_{\text{heat}}}{h_{\text{mass}}} = \rho c_p \left(\frac{Sc}{Pr} \right)^{2/3} = \rho c_p \left(\frac{\alpha}{D_{AB}} \right)^{2/3} = \rho c_p Le^{2/3}$$

Once the heat transfer coefficient h_{heat} is available, the mass transfer coefficient h_{mass} can be obtained from the relation above by substituting the values of the properties.

14-96C The molar mass of gasoline (C_8H_{18}) is 114 kg/kmol, which is much larger than the molar mass of air, which is 29 kg/kmol. Therefore, the gasoline vapor will settle down instead of rising even if it is at a much higher temperature than the surrounding air. As a result, the warm mixture of air and gasoline on top of an open gasoline will most likely settle down instead of rising in a cooler environment

14-97C Of the two identical cups of coffee, the one with no sugar will cool much faster than the one with plenty of sugar at the bottom. This is because in the case of no sugar, the coffee at the top will cool relatively fast and it will settle down while the warmer coffee at the bottom will rise to the top and cool off. When there is plenty of sugar at the bottom, however, the warmer coffee at the bottom will be heavier and thus it will not rise to the top. The elimination of natural convection currents and limiting heat transfer in water to conduction only will slow down the heat loss from the coffee considerably. In solar ponds, the rise of warm water at the bottom to the top is prevented by planting salt to the bottom of the pond.

14-98C The normalized velocity, thermal, and concentration boundary layers coincide during flow over a plate when the molecular diffusivity of momentum, heat, and mass are identical. That is, $\nu = \alpha = D_{AB}$ or $Pr = Sc = Le = 1$.

14-99C The relation $fRe/2 = Nu = Sh$ is known as the **Reynolds analogy**. It is valid under the conditions that the Prandtl, Schmidt, and Lewis numbers are equal to unity. That is, $\nu = \alpha = D_{AB}$ or $Pr = Sc = Le = 1$. Reynolds analogy enables us to determine the seemingly unrelated friction, heat transfer, and mass transfer coefficients when only one of them is known or measured.

14-100C The relation $f/2 = St Pr^{2/3} = St_{mass} Sc^{2/3}$ is known as the **Chilton-Colburn analogy**. Here St is the Stanton number, Pr is the Prandtl number, St_{mass} is the Stanton number in mass transfer, and Sc is the Schmidt number. The relation is valid for $0.6 < Pr < 60$ and $0.6 < Sc < 3000$. Its importance in engineering is that Chilton-Colburn analogy enables us to determine the seemingly unrelated friction, heat transfer, and mass transfer coefficients when only one of them is known or measured.

14-101C The relation $h_{heat} = \rho c_p h_{mass}$ is the result of the Lewis number $Le = 1$, and is known as the **Lewis relation**. It is valid for air-water vapor mixtures in the temperature range encountered in heating and air-conditioning applications. The Lewis relation is commonly used in air-conditioning practice. It asserts that the wet-bulb and adiabatic saturation temperatures of moist air are nearly identical. The Lewis relation can be used for heat and mass transfer in turbulent flow even when the Lewis number is not unity.

14-102C A convection mass transfer is referred to as the **low mass flux** when the flow rate of species undergoing mass flow is low relative to the total flow rate of the liquid or gas mixture so that the mass transfer between the fluid and the surface does not affect the *flow velocity*. The evaporation of water into air from lakes, rivers, etc. can be treated as a low mass-flux process since the mass fraction of water vapor in the air in such cases is just a few percent.

14-103 A wet flat plate is dried by blowing air over it. The mass transfer coefficient is to be determined.

Assumptions 1 The low mass flux model and thus the analogy between heat and mass transfer is applicable since the mass fraction of vapor in the air is low (about 2 percent for saturated air at 300 K). **2** The critical Reynolds number for flow over a flat plate is 500,000.

Properties Because of low mass flux conditions, we can use dry air properties for the mixture at the specified temperature of 40°C and 1 atm, for which (Table A-15)

$$\nu = 1.702 \times 10^{-5} \text{ m}^2 / \text{s}$$

Analysis The mass diffusivity of water vapor in air at 313 K is determined from Eq. 14-15 to be

$$\begin{aligned} D_{AB} &= D_{\text{H}_2\text{O-air}} \\ &= 1.87 \times 10^{-10} \frac{T^{2.072}}{P} \\ &= 1.87 \times 10^{-10} \frac{(313 \text{ K})^{2.072}}{1 \text{ atm}} \\ &= 2.77 \times 10^{-5} \text{ m}^2 / \text{s} \end{aligned}$$

The Reynolds number of the flow is

$$\text{Re} = \frac{VL}{\nu} = \frac{(2.5 \text{ m/s})(5 \text{ m})}{1.702 \times 10^{-5} \text{ m}^2/\text{s}} = 734,400$$

which is greater than 500,000, and thus we have combined laminar and turbulent flow. The Schmidt number in this case is

$$\text{Sc} = \frac{\nu}{D_{AB}} = \frac{1.702 \times 10^{-5} \text{ m}^2/\text{s}}{2.77 \times 10^{-5} \text{ m}^2/\text{s}} = 0.614$$

Therefore, the Sherwood number in this case is determined using the analogy between the heat and mass transfer to be

$$\text{Sh} = (0.037 \text{Re}^{0.8} - 871) \text{Sc}^{1/3} = (0.037 \times 734,400^{0.8} - 871)(0.614)^{1/3} = 809.7$$

Using the definition of Sherwood number, the mass transfer coefficient is determined to be

$$h_{\text{mass}} = \frac{\text{Sh}D_{AB}}{L} = \frac{(809.7)(2.77 \times 10^{-5} \text{ m}^2/\text{s})}{5 \text{ m}} = \mathbf{0.00449 \text{ m/s}}$$

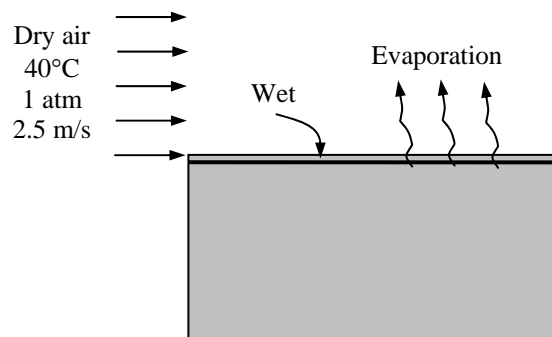

14-104E The liquid layer on the inner surface of a circular pipe is dried by blowing air through it. The mass transfer coefficient is to be determined.

Assumptions 1 The low mass flux model and thus the analogy between heat and mass transfer is applicable since the mass fraction of vapor in the air is low (about 2 percent for saturated air at 540 R). **2** The flow is fully developed.

Properties Because of low mass flux conditions, we can use dry air properties for the mixture at the specified temperature of 540 R and 1 atm, for which $\nu = 1.697 \times 10^{-4} \text{ ft}^2/\text{s}$ (Table A-15E). The mass diffusivity of water vapor in air at 540 R is determined from Eq. 14-15 to be

$$\begin{aligned} D_{AB} &= D_{\text{H}_2\text{O-air}} = 1.87 \times 10^{-10} \frac{T^{2.072}}{P} \\ &= 1.87 \times 10^{-10} \frac{(540/1.8)^{2.072}}{1} = 2.54 \times 10^{-5} \text{ m}^2/\text{s} \\ &= 2.73 \times 10^{-4} \text{ ft}^2/\text{s} \end{aligned}$$

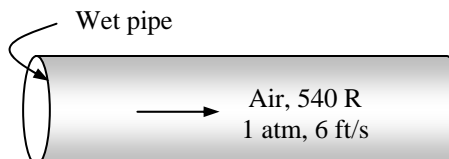

The Reynolds number of the flow is

$$\text{Re} = \frac{VD}{\nu} = \frac{(6 \text{ ft/s})(0.7/12 \text{ ft})}{1.697 \times 10^{-4} \text{ ft}^2/\text{s}} = 2062$$

which is less than 2300 and thus the flow is laminar. Therefore, based on the analogy between heat and mass transfer, the Nusselt and the Sherwood numbers in this case are $\text{Nu} = \text{Sh} = 3.66$. Using the definition of Sherwood number, the mass transfer coefficient is determined to be

$$h_{\text{mass}} = \frac{\text{Sh}D_{AB}}{D} = \frac{(3.66)(2.73 \times 10^{-4} \text{ ft}^2/\text{s})}{0.7/12 \text{ ft}} = \mathbf{0.017 \text{ ft/s}}$$

Discussion The mass transfer rate (or the evaporation rate) in this case can be determined by defining logarithmic mean concentration difference in an analogous manner to the logarithmic mean temperature difference.

14-105 Air is blown over a body covered with a layer of naphthalene, and the rate of sublimation is measured. The heat transfer coefficient under the same flow conditions over the same geometry is to be determined.

Assumptions 1 The concentration of naphthalene in the air is very small, and the low mass flux conditions exist so that the Chilton-Colburn analogy between heat and mass transfer is applicable (will be verified). **2** Both air and naphthalene vapor are ideal gases.

Properties The molar mass of naphthalene is 128.2 kg/kmol. Because of low mass flux conditions, we can use dry air properties for the mixture at the specified temperature of 25°C and 1 atm, at which $\rho = 1.184 \text{ kg/m}^3$, $c_p = 1007 \text{ J/kg} \cdot \text{K}$, and $\alpha = 2.141 \times 10^{-5} \text{ m}^2/\text{s}$ (Table A-15).

Analysis The incoming air is free of naphthalene, and thus the mass fraction of naphthalene at free stream conditions is zero, $w_{A,\infty} = 0$. Noting that the vapor pressure of naphthalene at the surface is 11 Pa, the surface mass fraction is determined to be

$$w_{A,s} = \frac{P_{A,s}}{P} \left(\frac{M_A}{M_{air}} \right) = \frac{11 \text{ Pa}}{101,325 \text{ Pa}} \left(\frac{128.2 \text{ kg/kmol}}{29 \text{ kg/kmol}} \right) = 4.8 \times 10^{-4}$$

which confirms that the low mass flux approximation is valid. The rate of evaporation of naphthalene in this case is

$$\dot{m}_{\text{evap}} = \frac{m}{\Delta t} = \frac{0.1 \text{ kg}}{(45 \times 60 \text{ s})} = 3.703 \times 10^{-5} \text{ kg/s}$$

Then the mass convection coefficient becomes

$$h_{\text{mass}} = \frac{\dot{m}}{\rho A (w_{A,s} - w_{A,\infty})} = \frac{3.703 \times 10^{-5} \text{ kg/s}}{(1.184 \text{ kg/m}^3)(0.75 \text{ m}^2)(4.8 \times 10^{-4} - 0)} = 0.0869 \text{ m/s}$$

Using the analogy between heat and mass transfer, the average heat transfer coefficient is determined from Eq. 14-89 to be

$$\begin{aligned} h_{\text{heat}} &= \rho c_p h_{\text{mass}} \left(\frac{\alpha}{D_{AB}} \right)^{2/3} \\ &= (1.184 \text{ kg/m}^3)(1007 \text{ J/kg} \cdot \text{K})(0.0869 \text{ m/s}) \left(\frac{2.141 \times 10^{-5} \text{ m}^2/\text{s}}{0.61 \times 10^{-5} \text{ m}^2/\text{s}} \right)^{2/3} \\ &= \mathbf{239 \text{ W/m}^2 \cdot \text{°C}} \end{aligned}$$

Discussion Naphthalene has been commonly used in heat transfer studies to determine convection heat transfer coefficients because of the convenience it offers.

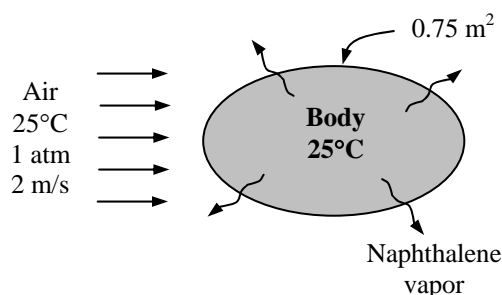

14-106 The liquid layer on the inner surface of a circular pipe is dried by blowing air through it. The mass transfer coefficient is to be determined.

Assumptions 1 The low mass flux model and thus the analogy between heat and mass transfer is applicable since the mass fraction of vapor in the air is low (about 2 percent for saturated air at 300 K). **2** The flow is fully developed.

Properties Because of low mass flux conditions, we can use dry air properties for the mixture at the specified temperature of 15°C and 1 atm, for which $\nu = 1.47 \times 10^{-5} \text{ m}^2/\text{s}$ (Table A-15). The mass diffusivity of water vapor in air at 288 K is determined from Eq. 14-15 to be

$$D_{AB} = D_{\text{H}_2\text{O-air}} = 1.87 \times 10^{-10} \frac{T^{2.072}}{P}$$

$$= 1.87 \times 10^{-10} \frac{(288 \text{ K})^{2.072}}{1} = 2.33 \times 10^{-5} \text{ m}^2/\text{s}$$

Analysis The Reynolds number of the flow is

$$\text{Re} = \frac{VD}{\nu} = \frac{(3 \text{ m/s})(0.15 \text{ m})}{1.47 \times 10^{-5} \text{ m}^2/\text{s}} = 30,612$$

which is greater than 10,000 and thus the flow is turbulent. The Schmidt number in this case is

$$\text{Sc} = \frac{\nu}{D_{AB}} = \frac{1.47 \times 10^{-5} \text{ m}^2/\text{s}}{2.33 \times 10^{-5} \text{ m}^2/\text{s}} = 0.631$$

Therefore, the Sherwood number in this case is determined from Table 14-13 to be

$$\text{Sh} = 0.023 \text{Re}^{0.8} \text{Sc}^{0.4} = 0.023(30,612)^{0.8} (0.631)^{0.4} = 74.2$$

Using the definition of Sherwood number, the mass transfer coefficient is determined to be

$$h_{\text{mass}} = \frac{\text{Sh}D_{AB}}{D} = \frac{(74.2)(2.33 \times 10^{-5} \text{ m}^2/\text{s})}{0.15 \text{ m}} = \mathbf{0.0115 \text{ m/s}}$$

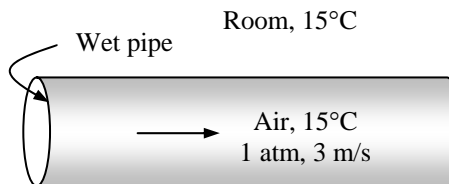

14-107 EES Prob. 14-106 is reconsidered. The mass transfer coefficient as a function of the air velocity is to be plotted.

Analysis The problem is solved using EES, and the solution is given below.

"GIVEN"

D=0.15 [m]
L=10 [m]
P=101.3 [kPa]
T=15+273 "[K]"
Vel=3 [m/s]

"PROPERTIES"

Fluid\$='air'
rho=Density(Fluid\$, T=T, P=P)
mu=Viscosity(Fluid\$, T=T)
nu=mu/rho
D_AB=1.87E-10*T^2.072/(P*Convert(kPa, atm)) "from the text"

"ANALYSIS"

Re=Vel*D/nu
"Re is calculated to be greater than 10,000, and thus the flow is turbulent."
Sc=nu/D_AB
Sh=0.023*Re^0.8*Sc^0.4
h_mass=Sh*D_AB/D

Vel [m/s]	h _{mass} [m/s]
1	0.00479
1.5	0.006625
2	0.00834
2.5	0.00997
3	0.01154
3.5	0.01305
4	0.01452
4.5	0.01595
5	0.01736
5.5	0.01873
6	0.02008
6.5	0.02141
7	0.02272
7.5	0.02401
8	0.02528

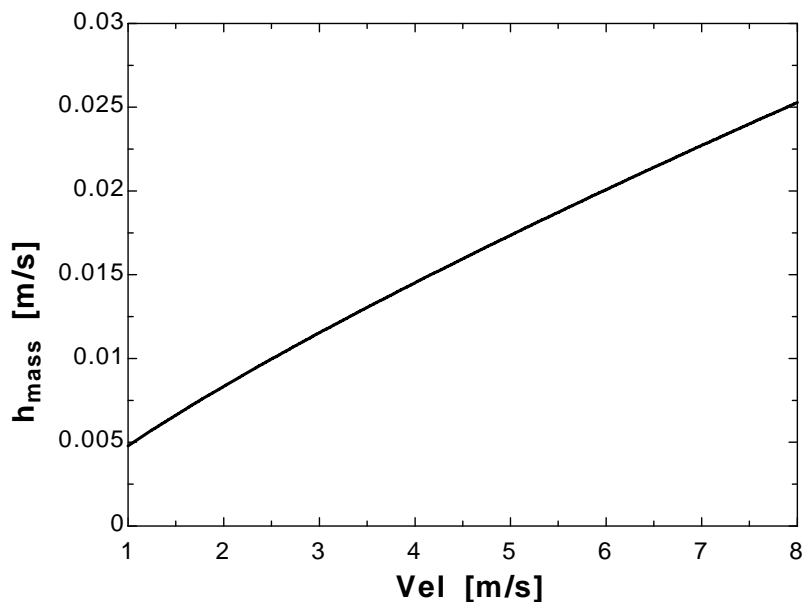

14-108 A wet flat plate is dried by blowing air over it. The mass transfer coefficient is to be determined.

Assumptions 1 The low mass flux model and thus the analogy between heat and mass transfer is applicable since the mass fraction of vapor in the air is low (about 2 percent for saturated air at 300 K). **2** The critical Reynolds number for flow over a flat plate is 500,000.

Properties Because of low mass flux conditions, we can use dry air properties for the mixture at the specified temperature of 15°C and 85 kPa = 85/101.325 = 0.839 atm, for which (Table A-15)

$$\nu = \nu_{1 \text{ atm}} / P(\text{atm}) = (1.47 \times 10^{-5} \text{ m}^2/\text{s}) / 0.839 \text{ atm} = 1.75 \times 10^{-5} \text{ m}^2 / \text{s}$$

Analysis The mass diffusivity of water vapor in air at 288 K is determined from Eq. 14-15 to be

$$\begin{aligned} D_{AB} &= D_{\text{H}_2\text{O-air}} \\ &= 1.87 \times 10^{-10} \frac{T^{2.072}}{P} \\ &= 1.87 \times 10^{-10} \frac{(288 \text{ K})^{2.072}}{0.839 \text{ atm}} \\ &= 2.78 \times 10^{-5} \text{ m}^2 / \text{s} \end{aligned}$$

The Reynolds number of the flow is

$$\text{Re} = \frac{VL}{\nu} = \frac{(3 \text{ m/s})(2 \text{ m})}{1.75 \times 10^{-5} \text{ m}^2/\text{s}} = 342,857$$

which is less than 500,000, and thus the flow is laminar. The Schmidt number in this case is

$$\text{Sc} = \frac{\nu}{D_{AB}} = \frac{1.75 \times 10^{-5} \text{ m}^2/\text{s}}{2.78 \times 10^{-5} \text{ m}^2/\text{s}} = 0.629$$

Therefore, the Sherwood number in this case is determined from Table 14-13 to be

$$\text{Sh} = 0.664 \text{Re}^{0.5} \text{Sc}^{1/3} = 0.664(342,857)^{0.5} (0.629)^{1/3} = 333.1$$

Using the definition of Sherwood number, the mass transfer coefficient is determined to be

$$h_{\text{mass}} = \frac{\text{Sh}D_{AB}}{L} = \frac{(333.1)(2.78 \times 10^{-5} \text{ m}^2/\text{s})}{2 \text{ m}} = \mathbf{0.00463 \text{ m/s}}$$

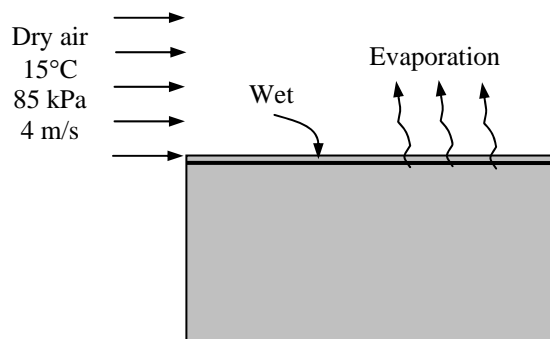

14-109 A wet concrete patio is to be dried by winds. The time it takes for the patio to dry is to be determined.

Assumptions 1 The low mass flux model and thus the analogy between heat and mass transfer is applicable since the mass fraction of vapor in the air is low (about 2 percent for saturated air at 300 K). **2** The critical Reynolds number for flow over a flat plate is 500,000. **3** Water is at the same temperature as air.

Properties Because of low mass flux conditions, we can use dry air properties for the mixture at the specified temperature of 15°C and 1 atm, for which $\nu = 1.47 \times 10^{-5} \text{ m}^2/\text{s}$ and $\rho = 1.225 \text{ kg/m}^3$ (Table A-15). The saturation pressure of water at 15°C is 1.705 kPa. The mass diffusivity of water vapor in air at 15°C = 288 K is determined from Eq. 14-15 to be

$$D_{AB} = D_{\text{H}_2\text{O-air}} = 1.87 \times 10^{-10} \frac{T^{2.072}}{P} = 1.87 \times 10^{-10} \frac{(288 \text{ K})^{2.072}}{1 \text{ atm}} = 2.33 \times 10^{-5} \text{ m}^2/\text{s}$$

Analysis The Reynolds number of the flow is

$$\text{Re} = \frac{VL}{\nu} = \frac{(50 \text{ km/h})(5 \text{ m})}{1.47 \times 10^{-5} \text{ m}^2/\text{s}} \left(\frac{1 \text{ m/s}}{3.6 \text{ km/h}} \right) = 4.724 \times 10^6$$

which is more than 500,000, and thus the flow is turbulent over most of the surface. The Schmidt number in this case is

$$\text{Sc} = \frac{\nu}{D_{AB}} = \frac{1.47 \times 10^{-5} \text{ m}^2/\text{s}}{2.33 \times 10^{-5} \text{ m}^2/\text{s}} = 0.631$$

Therefore, the Sherwood number in this case is determined from Table 14-13 to be

$$\begin{aligned} \text{Sh} &= 0.037 \text{Re}^{0.8} \text{Sc}^{1/3} \\ &= 0.037(4.724 \times 10^6)^{0.8} (0.631)^{1/3} = 6934 \end{aligned}$$

Using the definition of Sherwood number, the mass transfer coefficient is determined to be

$$h_{\text{mass}} = \frac{\text{Sh}D_{AB}}{L} = \frac{(6934)(2.33 \times 10^{-5} \text{ m}^2/\text{s})}{5 \text{ m}} = 0.0323 \text{ m/s}$$

Noting that the air at the water surface will be saturated and that the saturation pressure of water at 15°C is 1.705 kPa, the mass fraction of water vapor in the air at the surface and at the free stream conditions are, from Eq. 14-10,

$$w_{A,s} = y_{A,s} \frac{M_A}{M} = \frac{P_{\text{sat}}}{P} \frac{M_A}{M_{\text{air}}} = \frac{(1.705 \text{ kPa})}{101.325 \text{ kPa}} \left(\frac{18 \text{ kg/kmol}}{29 \text{ kg/kmol}} \right) = 0.01044$$

$$w_{A,\infty} = y_{A,\infty} \frac{M_A}{M_{\text{air}}} = \frac{\phi P_{\text{sat}}}{P} \frac{M_A}{M_{\text{air}}} = \frac{(0.35)(1.705 \text{ kPa})}{101.325 \text{ kPa}} \left(\frac{18 \text{ kg/kmol}}{29 \text{ kg/kmol}} \right) = 0.003655$$

Then the rate of mass transfer to the air becomes

$$\begin{aligned} \dot{m}_{\text{evap.}} &= h_{\text{mass}} \rho A (w_{A,s} - w_{A,\infty}) \\ &= (0.0323 \text{ m/s})(1.225 \text{ kg/m}^3)(5 \text{ m} \times 5 \text{ m})(0.01044 - 0.003655) \\ &= 0.00671 \text{ kg/s} \end{aligned}$$

The total mass of water on the concrete patio is

$$m_{\text{water}} = \rho V = (1000 \text{ kg/m}^3)(5 \text{ m} \times 5 \text{ m} \times 0.3 \times 10^{-3} \text{ m}) = 7.5 \text{ kg}$$

Then the time required to evaporate the water on the concrete patio becomes

$$\Delta t = \frac{m_{\text{water}}}{\dot{m}_{\text{evap}}} = \frac{7.5 \text{ kg}}{0.00671 \text{ kg/s}} = 1118 \text{ s} = \mathbf{18.6 \text{ min}}$$

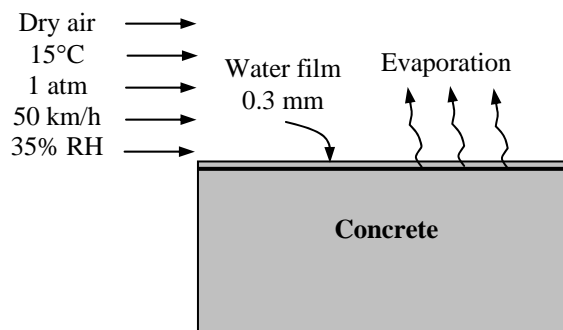

14-110E A spherical naphthalene ball is suspended in a room where it is subjected to forced air flow. The average mass transfer coefficient between the naphthalene and the air is to be determined.

Assumptions 1 The concentration of naphthalene in the air is very small, and the low mass flux conditions exist so that the Chilton–Colburn analogy between heat and mass transfer is applicable (will be verified). **2** Both air and naphthalene vapor are ideal gases. **3** Both the ball and the room are at the same temperature.

Properties The Schmidt number of naphthalene in air at room temperature is given to be 2.35. Because of low mass flux conditions, we can use dry air properties for the mixture at the specified temperature of 80°F and 1 atm from Table A-15E,

$$k = 0.01481 \text{ Btu/h}\cdot\text{ft}\cdot^\circ\text{F}$$

$$\mu = 1.247 \times 10^{-5} \text{ lbm/ft}\cdot\text{s}$$

$$\nu = 1.697 \times 10^{-4} \text{ ft}^2/\text{s}$$

$$\text{Pr} = 0.7290$$

Analysis Noting that the Schmidt number for naphthalene in air is 2.35, the mass diffusivity of naphthalene in air is determined from

$$\text{Sc} = \frac{\nu}{D_{AB}} \longrightarrow D_{AB} = \frac{\nu}{\text{Sc}} = \frac{1.697 \times 10^{-4} \text{ ft}^2/\text{s}}{2.35} = 7.22 \times 10^{-5} \text{ ft}^2/\text{s}$$

The Reynolds number of the flow is

$$\text{Re} = \frac{VD}{\nu} = \frac{(15 \text{ ft/s})(2/12 \text{ ft})}{(1.697 \times 10^{-4} \text{ ft}^2/\text{s})} = 14,732$$

Noting that $\mu_\infty = \mu_s$ for air in this case since the air and the ball are assumed to be at the same temperature, the Sherwood number can be determined from the forced heat convection relation for a sphere by replacing Pr by the Sc number to be

$$\begin{aligned} \text{Sh} &= \frac{h_{\text{mass}} D}{D_{AB}} = 2 + \left[0.4 \text{Re}^{1/2} + 0.06 \text{Re}^{2/3} \right] \text{Sc}^{0.4} \left(\frac{\mu_\infty}{\mu_s} \right)^{1/4} \\ &= 2 + \left[0.4(14,732)^{1/2} + 0.06(14,732)^{2/3} \right] (2.35)^{0.4} \\ &= 121 \end{aligned}$$

Then the mass transfer coefficient becomes

$$h_{\text{mass}} = \frac{\text{Sh} D_{AB}}{D} = \frac{(121)(7.22 \times 10^{-5} \text{ ft}^2/\text{s})}{(2/12) \text{ ft}} = \mathbf{0.0524 \text{ ft/s}}$$

Discussion Note that the Nusselt number relations in heat transfer can be used to determine the Sherwood number in mass transfer by replacing Prandtl number by the Schmidt number.

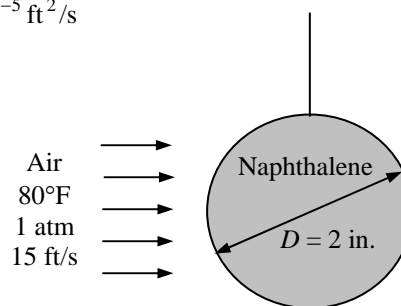

14-111 A raindrop is falling freely in atmospheric air. The terminal velocity of the raindrop at which the drag force equals the weight of the drop and the average mass transfer coefficient are to be determined.

Assumptions 1 The low mass flux model and thus the analogy between heat and mass transfer is applicable since the mass fraction of vapor in the air is low (about 2 percent for saturated air at 300 K). **2** The raindrop is spherical in shape. **3** The reduction in the diameter of the raindrop due to evaporation when the terminal velocity is reached is negligible.

Properties Because of low mass flux conditions, we can use dry air properties for the mixture. The properties of air at 1 atm and the free-stream temperature of 25°C (and the dynamic viscosity at the surface temperature of 9°C) are (Table A-15)

$$\begin{aligned}\rho &= 1.184 \text{ kg/m}^3 & \mu_\infty &= 1.849 \times 10^{-5} \text{ kg/m}\cdot\text{s} \\ \nu &= 1.562 \times 10^{-5} \text{ m}^2/\text{s} & \mu_{s, @ 9^\circ\text{C}} &= 1.759 \times 10^{-5} \text{ kg/m}\cdot\text{s}\end{aligned}$$

At 1 atm and the film temperature of $(25+9)/2 = 17^\circ\text{C} = 290 \text{ K}$, the kinematic viscosity of air is, from Table A-15, $\nu = 1.488 \times 10^{-5} \text{ m}^2/\text{s}$, while the mass diffusivity of water vapor in air is, Eq. 14-15,

$$D_{AB} = D_{\text{H}_2\text{O-air}} = 1.87 \times 10^{-10} \frac{T^{2.072}}{P} = 1.87 \times 10^{-10} \frac{(290 \text{ K})^{2.072}}{1 \text{ atm}} = 2.37 \times 10^{-5} \text{ m}^2/\text{s}$$

Analysis The weight of the raindrop before any evaporation occurs is

$$F_D = mg = \rho V g = (1000 \text{ kg/m}^3) \left[\frac{\pi (0.003 \text{ m})^3}{6} \right] (9.8 \text{ m/s}^2) = 1.38 \times 10^{-4} \text{ N}$$

The drag force is determined from $F_D = C_D A_N \frac{\rho u_\infty^2}{2}$ where drag

coefficient C_D is to be determined using Fig. 10-20 which requires the

Reynolds number. Since we do not know the velocity we cannot determine the Reynolds number. Therefore, the solution requires a trial-error approach. We choose a velocity and perform calculations to obtain the drag force. After a couple trial we choose a velocity of 8 m/s. Then the Reynolds number becomes

$$\text{Re} = \frac{VD}{\nu} = \frac{(8 \text{ m/s})(0.003 \text{ m})}{1.562 \times 10^{-5} \text{ m}^2/\text{s}} = 1536$$

The corresponding drag coefficient from Fig. 7-17 is 0.5. Then,

$$F_D = C_D A_N \frac{\rho u_\infty^2}{2} = (0.5) \left[\frac{\pi (0.003 \text{ m})^2}{4} \right] \frac{(1.184 \text{ kg/m}^3)(8 \text{ m/s})^2}{2} = 1.34 \times 10^{-4}$$

which is sufficiently close to the value calculated before. Therefore, the terminal velocity of the raindrop is $V = 8 \text{ m/s}$. The Schmidt number is

$$\text{Sc} = \frac{\nu}{D_{AB}} = \frac{1.488 \times 10^{-5} \text{ m}^2/\text{s}}{2.37 \times 10^{-5} \text{ m}^2/\text{s}} = 0.628$$

Then the Sherwood number can be determined from the forced heat convection relation for a sphere by replacing Pr by the Sc number to be

$$\begin{aligned}\text{Sh} &= \frac{h_{\text{mass}} D}{D_{AB}} = 2 + \left[0.4 \text{Re}^{1/2} + 0.06 \text{Re}^{2/3} \right] \text{Sc}^{0.4} \left(\frac{\mu_\infty}{\mu_s} \right)^{1/4} \\ &= 2 + \left[0.4(1536)^{1/2} + 0.06(1536)^{2/3} \right] (0.628)^{0.4} \left(\frac{1.849 \times 10^{-5}}{1.759 \times 10^{-5}} \right)^{1/4} \\ &= 21.9\end{aligned}$$

Then the mass transfer coefficient becomes

$$h_{\text{mass}} = \frac{\text{Sh} D_{AB}}{D} = \frac{(21.9)(2.37 \times 10^{-5} \text{ m}^2/\text{s})}{0.003 \text{ m}} = 0.173 \text{ m/s}$$

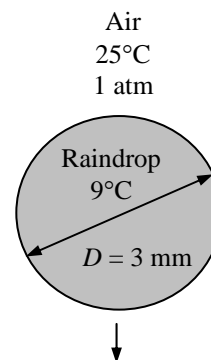

14-112 Wet steel plates are to be dried by blowing air parallel to their surfaces. The rate of evaporation from both sides of a plate is to be determined.

Assumptions 1 The low mass flux model and thus the analogy between heat and mass transfer is applicable since the mass fraction of vapor in the air is low (about 2 percent for saturated air at 300 K). **2** The critical Reynolds number for flow over a flat plate is 500,000. **3** The plates are far enough from each other so that they can be treated as flat plates. **4** The air is dry so that the amount of moisture in the air is negligible.

Properties The molar masses of air and water are $M = 29$ and $M = 18$ kg/kmol, respectively (Table A-1).

Because of low mass flux conditions, we can use dry air properties for the mixture. The properties of the air at 1 atm and at the film temperature of $(15 + 25) = 20^\circ\text{C}$ are (Table A-15)

$$\nu = 1.516 \times 10^{-5} \text{ m}^2/\text{s}$$

$$\rho = 1.204 \text{ kg/m}^3$$

$$c_p = 1007 \text{ J/kg K}$$

$$\text{Pr} = 0.7309$$

The saturation pressure of water at 15°C is 1.705 kPa (Table A-9). The mass diffusivity of water vapor in air at $20^\circ\text{C} = 293 \text{ K}$ is determined from Eq. 14-15 to be

$$D_{AB} = D_{\text{H}_2\text{O-air}} = 1.87 \times 10^{-10} \frac{T^{2.072}}{P} = 1.87 \times 10^{-10} \frac{(293 \text{ K})^{2.072}}{1 \text{ atm}} = 2.42 \times 10^{-5} \text{ m}^2/\text{s}$$

Analysis The Reynolds number for flow over the flat plate is

$$\text{Re} = \frac{VL}{\nu} = \frac{(4 \text{ m/s})(0.4 \text{ m})}{1.516 \times 10^{-5} \text{ m}^2/\text{s}} = 105,540$$

which is less than 500,000, and thus the air flow is laminar over the entire plate. The Schmidt number in this case is

$$\text{Sc} = \frac{\nu}{D_{AB}} = \frac{1.516 \times 10^{-5} \text{ m}^2/\text{s}}{2.42 \times 10^{-5} \text{ m}^2/\text{s}} = 0.626$$

Therefore, the Sherwood number in this case is determined from Table 14-13 to be

$$\text{Sh} = 0.664 \text{Re}_L^{0.5} \text{Sc}^{1/3} = 0.664(105,540)^{0.5} (0.626)^{1/3} = 184.5$$

Using the definition of Sherwood number, the mass transfer coefficient is determined to be

$$h_{\text{mass}} = \frac{\text{Sh}D_{AB}}{L} = \frac{(184.5)(2.42 \times 10^{-5} \text{ m}^2/\text{s})}{0.4 \text{ m}} = 0.0112 \text{ m/s}$$

Noting that the air at the water surface will be saturated and that the saturation pressure of water at 15°C is 1.705 kPa, the mass fraction of water vapor in the air at the surface of the plate is, from Eq. 14-10,

$$w_{A,s} = y_{A,s} \frac{M_A}{M} = \frac{P_{\text{sat}}}{P} \frac{M_A}{M_{\text{air}}} = \frac{(1.705 \text{ kPa})}{101.325 \text{ kPa}} \left(\frac{18 \text{ kg/kmol}}{29 \text{ kg/kmol}} \right) = 0.01044$$

and $w_{A,\infty} = 0$

Then the rate of mass transfer to the air becomes

$$\begin{aligned} \dot{m}_{\text{evap.}} &= h_{\text{mass}} \rho A (w_{A,s} - w_{A,\infty}) \\ &= (0.0112 \text{ m/s})(1.204 \text{ kg/m}^3)(2 \times 0.4 \text{ m} \times 0.4 \text{ m})(0.01044 - 0) \\ &= \mathbf{4.51 \times 10^{-5} \text{ kg/s}} \end{aligned}$$

Discussion This is the upper limit for the evaporation rate since the air is assumed to be completely dry.

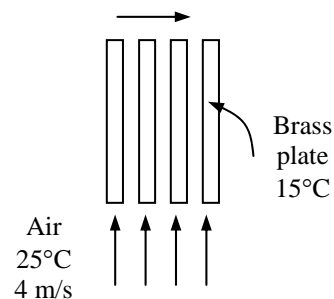

14-113E Air is blown over a square pan filled with water. The rate of evaporation of water and the rate of heat transfer to the pan to maintain the water temperature constant are to be determined.

Assumptions 1 The low mass flux model and thus the analogy between heat and mass transfer is applicable since the mass fraction of vapor in the air is low (about 2 percent for saturated air at 80°F). **2** The critical Reynolds number for flow over a flat plate is 500,000. **3** Water is at the same temperature as the air.

Properties The molar masses of air and water are $M = 29$ and $M = 18$ lbm/lbmol, respectively (Table A-1E). Because of low mass flux conditions, we can use dry air properties for the mixture at the specified temperature of 80°F and 1 atm, for which $\nu = 1.697 \times 10^{-4}$ ft²/s, and $\rho = 0.0735$ lbm/ft³ (Table A-15E). The saturation pressure of water at 80°F is 0.5073 psia, and the heat of vaporization is 1048 Btu/lbm. The mass diffusivity of water vapor in air at 80°F = 540 R = 300 K is determined from Eq. 14-15 to be

$$D_{AB} = D_{\text{H}_2\text{O-air}} = 1.87 \times 10^{-10} \frac{T^{2.072}}{P} = 1.87 \times 10^{-10} \frac{(300\text{K})^{2.072}}{1\text{atm}} = 2.54 \times 10^{-5} \text{ m}^2/\text{s} = 2.734 \times 10^{-4} \text{ ft}^2/\text{s}$$

Analysis The Reynolds number for flow over the free surface is

$$\text{Re} = \frac{VL}{\nu} = \frac{(10 \text{ ft/s})(15/12 \text{ ft})}{1.697 \times 10^{-4} \text{ ft}^2/\text{s}} = 73,660$$

which is less than 500,000, and thus the flow is laminar over the entire surface. The Schmidt number in this case is

$$\text{Sc} = \frac{\nu}{D_{AB}} = \frac{1.697 \times 10^{-4} \text{ ft}^2/\text{s}}{2.734 \times 10^{-4} \text{ ft}^2/\text{s}} = 0.6207$$

Therefore, the Sherwood number in this case is determined from Table 14-13 to be

$$\text{Sh} = 0.664 \text{Re}_L^{0.5} \text{Sc}^{1/3} = 0.664(73,660)^{0.5} (0.6207)^{1/3} = 153.7$$

Using the definition of Sherwood number, the mass transfer coefficient is determined to be

$$h_{\text{mass}} = \frac{\text{Sh}D_{AB}}{L} = \frac{(153.7)(2.734 \times 10^{-4} \text{ ft}^2/\text{s})}{15/12 \text{ ft}} = 0.0336 \text{ ft/s}$$

Noting that the air at the water surface will be saturated and that the saturation pressure of water at 80°F is 0.5073 psia (= 0.0345 atm), the mass fraction of water vapor in the air at the surface and at the free stream conditions are, from Eq. 14-10,

$$w_{A,s} = y_{A,s} \frac{M_A}{M} = \frac{P_{\text{sat}}}{P} \frac{M_A}{M_{\text{air}}} = \frac{(0.3)(0.5073 \text{ psia})}{14.7 \text{ psia}} \left(\frac{18 \text{ lbm/lbmol}}{29 \text{ lbm/lbmol}} \right) = 0.00643$$

$$w_{A,\infty} = y_{A,\infty} \frac{M_A}{M_{\text{air}}} = \frac{\phi P_{\text{sat}}}{P} \frac{M_A}{M_{\text{air}}} = \frac{(1.0)(0.5073 \text{ psia})}{14.7 \text{ psia}} \left(\frac{18 \text{ lbm/lbmol}}{29 \text{ lbm/lbmol}} \right) = 0.02142$$

Then the rate of mass transfer to the air becomes

$$\dot{m}_{\text{evap}} = h_{\text{mass}} \rho A_s (w_{A,s} - w_{A,\infty}) = (0.0336 \text{ ft/s})(0.074 \text{ lbm/ft}^3)(15/12 \text{ ft})^2 (0.02142 - 0.00642) = \mathbf{5.83 \times 10^{-5} \text{ lbm/s}}$$

Noting that the latent heat of vaporization of water at 80°F is $h_{fg} = 1048$ Btu/lbm, the required rate of heat supply to the water to maintain its temperature constant is

$$\dot{Q} = \dot{m}_{\text{evap}} h_{fg} = (5.83 \times 10^{-5} \text{ lbm/s})(1048 \text{ Btu/lbm}) = \mathbf{0.0611 \text{ Btu/s} = 220 \text{ Btu/h}}$$

Discussion If no heat is supplied to the pan, the heat of vaporization of water will come from the water, and thus the water temperature will have to drop below the air temperature.

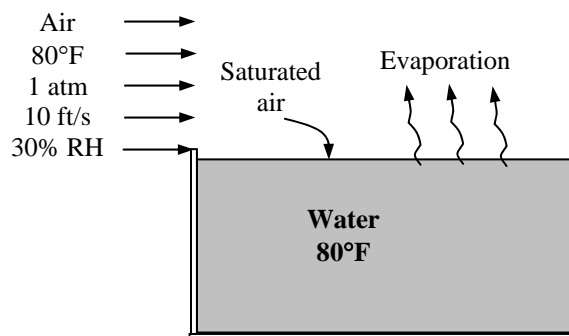

14-114E Air is blown over a square pan filled with water. The rate of evaporation of water and the rate of heat transfer to the pan to maintain the water temperature constant are to be determined.

Assumptions 1 The low mass flux model and thus the analogy between heat and mass transfer is applicable since the mass fraction of vapor in the air is low (about 2 percent for saturated air at 60°F). **2** The critical Reynolds number for flow over a flat plate is 500,000. **3** Water is at the same temperature as air.

Properties The molar masses of air and water are $M = 29$ and $M = 18$ lbm/lbmol, respectively (Table A-1E). Because of low mass flux conditions, we can use dry air properties for the mixture at the specified temperature of 60°F and 1 atm, for which $\nu = 1.588 \times 10^{-4}$ ft²/s, and $\rho = 0.07633$ lbm / ft³ (Table A-15E). The saturation pressure of water at 60°F is 0.2563 psia, and the heat of vaporization is 1060 Btu/lbm. The mass diffusivity of water vapor in air at 60°F = 520 R = 288.9 K is determined from Eq. 14-15 to be

$$D_{AB} = D_{\text{H}_2\text{O-air}} = 1.87 \times 10^{-10} \frac{T^{2.072}}{P} = 1.87 \times 10^{-10} \frac{(288.9\text{K})^{2.072}}{1\text{atm}} = 2.35 \times 10^{-5} \text{ m}^2/\text{s} = 2.53 \times 10^{-4} \text{ ft}^2/\text{s}$$

Analysis The Reynolds number for flow over the free surface is

$$\text{Re} = \frac{VL}{\nu} = \frac{(10 \text{ ft/s})(15/12 \text{ ft})}{1.588 \times 10^{-4} \text{ ft}^2/\text{s}} = 78,715$$

which is less than 500,000, and thus the flow is laminar over the entire surface.

The Schmidt number in this case is

$$\text{Sc} = \frac{\nu}{D_{AB}} = \frac{1.588 \times 10^{-4} \text{ ft}^2/\text{s}}{2.53 \times 10^{-4} \text{ ft}^2/\text{s}} = 0.6277$$

Therefore, the Sherwood number in this case is determined from Table 14-13 to be

$$\text{Sh} = 0.664 \text{Re}_L^{0.5} \text{Sc}^{1/3} = 0.664(78,715)^{0.5} (0.6277)^{1/3} = 159.5$$

Using the definition of Sherwood number, the mass transfer coefficient is determined to be

$$h_{\text{mass}} = \frac{\text{Sh}D_{AB}}{L} = \frac{(159.5)(2.53 \times 10^{-4} \text{ ft}^2/\text{s})}{15/12 \text{ ft}} = 0.0323 \text{ ft/s}$$

Noting that the air at the water surface will be saturated and that the saturation pressure of water at 60°F is 0.2563 psia, the mass fraction of water vapor in the air at the surface and at the free stream conditions are, from Eq. 14-10,

$$w_{A,s} = y_{A,s} \frac{M_A}{M} = \frac{P_{\text{sat}}}{P} \frac{M_A}{M_{\text{air}}} = \frac{(0.3)(0.2563 \text{ psia})}{14.7 \text{ psia}} \left(\frac{18 \text{ lbm/lbmol}}{29 \text{ lbm/lbmol}} \right) = 0.00325$$

$$w_{A,\infty} = y_{A,\infty} \frac{M_A}{M_{\text{air}}} = \frac{\phi P_{\text{sat}}}{P} \frac{M_A}{M_{\text{air}}} = \frac{(1.0)(0.2563 \text{ psia})}{14.7 \text{ psia}} \left(\frac{18 \text{ lbm/lbmol}}{29 \text{ lbm/lbmol}} \right) = 0.01082$$

Then the rate of mass transfer to the air becomes

$$\dot{m}_{\text{evap}} = h_{\text{mass}} \rho A (w_{A,s} - w_{A,\infty}) = (0.0323 \text{ ft/s})(0.07633 \text{ lbm/ft}^3)(15/12 \text{ ft})^2 (0.01082 - 0.00325) = \mathbf{2.82 \times 10^{-5} \text{ lbm/s}}$$

Noting that the latent heat of vaporization of water at 60°F is $h_{fg} = 1060$ Btu/lbm, the required rate of heat supply to the water to maintain its temperature constant is

$$\dot{Q} = \dot{m}_{\text{evap}} h_{fg} = (2.82 \times 10^{-5} \text{ lbm/s})(1060 \text{ Btu/lbm}) = \mathbf{0.0299 \text{ Btu/s} = 108 \text{ Btu/h}}$$

Discussion If no heat is supplied to the pan, the heat of vaporization of water will come from the water, and thus the water temperature will have to drop below the air temperature.

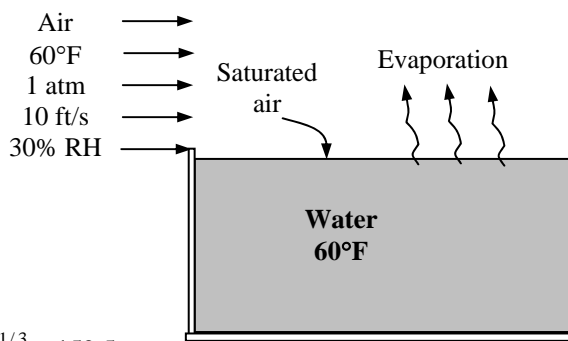

Simultaneous Heat and Mass Transfer

14-115C In steady operation, the mass transfer process does not have to involve heat transfer. However, a mass transfer process that involves phase change (evaporation, sublimation, condensation, melting etc.) must involve heat transfer. For example, the evaporation of water from a lake into air (mass transfer) requires the transfer of latent heat of water at a specified temperature to the liquid water at the surface (heat transfer).

14-116C It is possible for a shallow body of water to freeze during a cool and dry night even when the ambient air and surrounding surface temperatures never drop to 0°C. This is because when the air is not saturated ($\phi < 100$ percent), there will be a difference between the concentration of water vapor at the water-air interface (which is always saturated) and some distance above it. Concentration difference is the driving force for mass transfer, and thus this concentration difference will drive the water into the air. But the water must vaporize first, and it must absorb the latent heat of vaporization from the water. The temperature of water near the surface must drop as a result of the sensible heat loss, possibly below the freezing point.

14-117C During evaporation from a water body to air, the latent heat of vaporization will be equal to *convection* heat transfer from the air when *conduction* from the lower parts of the water body to the surface is negligible, and temperature of the surrounding surfaces is at about the temperature of the water surface so that the *radiation* heat transfer is negligible.

14-118 Air is blown over a jug made of porous clay to cool it by simultaneous heat and mass transfer. The temperature of the water in the jug when steady conditions are reached is to be determined.

Assumptions 1 The low mass flux conditions exist so that the Chilton-Colburn analogy between heat and mass transfer is applicable since the mass fraction of vapor in the air is low (about 2 percent for saturated air at 300 K). **2** Both air and water vapor at specified conditions are ideal gases (the error involved in this assumption is less than 1 percent). **3** Radiation effects are negligible.

Properties Because of low mass flux conditions, we can use dry air properties for the mixture at the average temperature of $(T_\infty + T_s)/2$ which cannot be determined at this point because of the unknown surface temperature T_s . We know that $T_s < T_\infty$ and, for the purpose of property evaluation, we take T_s to be 20°C. Then, the properties of water at 20°C and the properties of dry air at the average temperature of 25°C and 1 atm are (Tables A-9 and A-15)

Water at 20°C: $h_{fg} = 2454 \text{ kJ/kg}$, $P_v = 2.34 \text{ kPa}$. Also, at 30°C, $P_{\text{sat}@30^\circ\text{C}} = 4.25 \text{ kPa}$

Dry air at 25°C: $c_p = 1.007 \text{ kJ/kg}\cdot^\circ\text{C}$, $\alpha = 2.141 \times 10^{-5} \text{ m}^2/\text{s}$

Also, the mass diffusivity of water vapor in air at 25°C is $D_{\text{H}_2\text{O-air}} = 2.50 \times 10^{-5} \text{ m}^2/\text{s}$ (Table 14-4), and the molar masses of water and air are 18 and 29 kg/kmol, respectively (Table A-1).

Analysis The surface temperature of the jug can be determined by rearranging Chilton-Colburn equation as

$$T_s = T_\infty - \frac{h_{fg}}{c_p \text{Le}^{2/3}} \frac{M_v}{M} \frac{P_{v,s} - P_{v,\infty}}{P}$$

where the Lewis number is

$$\text{Le} = \frac{\alpha}{D_{AB}} = \frac{2.141 \times 10^{-5} \text{ m}^2/\text{s}}{2.50 \times 10^{-5} \text{ m}^2/\text{s}} = 0.856$$

Note that we could take the Lewis number to be 1 for simplicity, but we chose to incorporate it for better accuracy.

The air at the surface is saturated, and thus the vapor pressure at the surface is simply the saturation pressure of water at the surface temperature (2.34 kPa). The vapor pressure of air far from the surface is determined from

$$P_{v,\infty} = \phi P_{\text{sat}@T_\infty} = (0.35)P_{\text{sat}@30^\circ\text{C}} = (0.35)(4.25 \text{ kPa}) = 1.488 \text{ kPa}$$

Noting that the atmospheric pressure is 1 atm = 101.3 Pa, substituting the known quantities gives

$$T_s = 30^\circ\text{C} - \frac{2454 \text{ kJ/kg}}{(1.007 \text{ kJ/kg}\cdot^\circ\text{C})(0.856)^{2/3}} \frac{18 \text{ kg/kmol}}{29 \text{ kg/kmol}} \frac{(2.34 - 1.488) \text{ kPa}}{101.3 \text{ kPa}} = \mathbf{15.9^\circ\text{C}}$$

Therefore, the temperature of the drink can be lowered to 15.9°C by this process.

Discussion The accuracy of this result can be improved by repeating the calculations with dry air properties evaluated at $(30+16)/2 = 18^\circ\text{C}$ and water properties at 16.0°C. But the improvement will be minor.

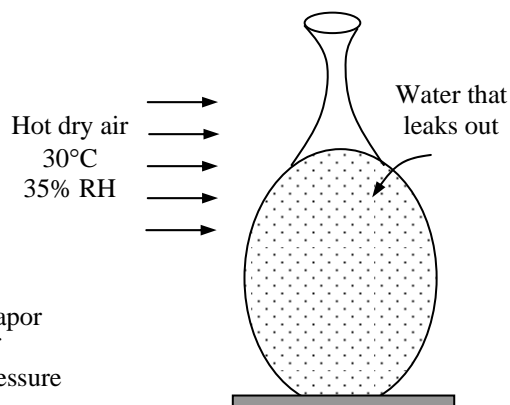

14-119 EES Prob. 14-118 is reconsidered. The water temperature as a function of the relative humidity of air is to be plotted.

Analysis The problem is solved using EES, and the solution is given below.

"GIVEN"

P=101.3 [kPa]
T_infinity=30 [C]
phi=0.35

"PROPERTIES"

Fluid\$='steam_IAPWS'
h_f=enthalpy(Fluid\$, T=T_s, x=0)
h_g=enthalpy(Fluid\$, T=T_s, x=1)
h_fg=h_g-h_f
P_sat_s=Pressure(Fluid\$, T=T_s, x=0)
P_sat_infinity=Pressure(Fluid\$, T=T_infinity, x=0)
C_p_air=CP(air, T=T_ave)
T_ave=1/2*(T_infinity+T_s)
alpha=2.18E-5 [m^2/s] "from the text"
D_AB=2.50E-5 [m^2/s] "from the text"
MM_H2O=molarmass(H2O)
MM_air=molarmass(air)

"ANALYSIS"

Le=alpha/D_AB
P_v_infinity=phi*P_sat_infinity
P_v_s=P_sat_s
T_s=T_infinity-h_fg/(C_p_air*Le^(2/3))*MM_H2O/MM_air*(P_v_s-P_v_infinity)/P

ϕ	T_s [C]
0.1	12.72
0.15	14.05
0.2	15.32
0.25	16.53
0.3	17.68
0.35	18.79
0.4	19.85
0.45	20.87
0.5	21.85
0.55	22.8
0.6	23.71
0.65	24.58
0.7	25.43
0.75	26.25
0.8	27.05
0.85	27.82
0.9	28.57
0.95	29.29
1	30

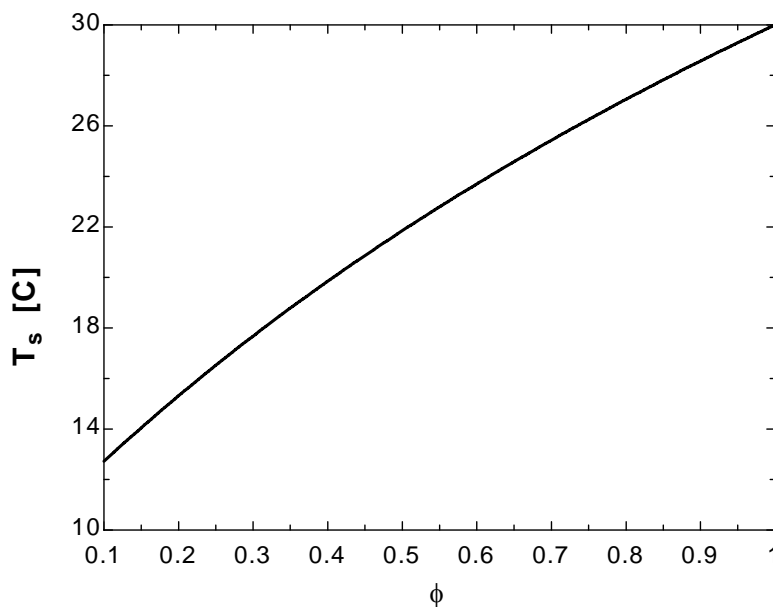

14-120E In a hot summer day, a bottle of drink is to be cooled by wrapping it in a wet cloth, and blowing air to it. The temperature of the drink in the bottle when steady conditions are reached is to be determined.

Assumptions 1 The low mass flux conditions exist so that the Chilton-Colburn analogy between heat and mass transfer is applicable since the mass fraction of vapor in the air is low (about 2 percent for saturated air at 80°F). **2** Both air and water vapor at specified conditions are ideal gases (the error involved in this assumption is less than 1 percent). **3** Radiation effects are negligible.

Properties Because of low mass flux conditions, we can use dry air properties for the mixture at the average temperature of $(T_\infty + T_s)/2$ which cannot be determined at this point because of the unknown surface temperature T_s . We know that $T_s < T_\infty$ and, for the purpose of property evaluation, we take T_s to be 60°F. Then the properties of water at 60°F and the properties of dry air at the average temperature of $(60+80)/2 = 70^\circ\text{F}$ and 1 atm are (Tables A-9E and A-15E)

Water at 60°F: $h_{fg} = 1060 \text{ Btu/lbm}$, $P_v = 0.2563 \text{ psia}$. Also, at 80°F, $P_{\text{sat}@80^\circ\text{F}} = 0.5073 \text{ psia}$

Dry air at 70°F: $c_p = 0.24 \text{ Btu/lbm}\cdot^\circ\text{F}$, $\alpha = 0.8093 \text{ ft}^2/\text{h} = 2.25 \times 10^{-4} \text{ ft}^2/\text{s}$

Also, the molar masses of water and air are 18 and 29 lbm/lbmol, respectively (Table A-1E), and the mass diffusivity of water vapor in air at 70°F ($= 294.4 \text{ K}$) is

$$D_{AB} = D_{\text{H}_2\text{O-air}} = 1.87 \times 10^{-10} \frac{T^{2.072}}{P} = 1.87 \times 10^{-10} \frac{(294.4 \text{ K})^{2.072}}{1 \text{ atm}} = 2.44 \times 10^{-5} \text{ m}^2/\text{s} = 2.63 \times 10^{-4} \text{ ft}^2/\text{s}$$

Analysis The surface temperature of the jug can be determined by rearranging Chilton-Colburn equation as

$$T_s = T_\infty - \frac{h_{fg}}{c_p \text{Le}^{2/3}} \frac{M_v}{M} \frac{P_{v,s} - P_{v,\infty}}{P}$$

where the Lewis number is

$$\text{Le} = \frac{\alpha}{D_{AB}} = \frac{2.25 \times 10^{-4} \text{ ft}^2/\text{s}}{2.63 \times 10^{-4} \text{ ft}^2/\text{s}} = 0.856$$

Note that we could take the Lewis number to be 1 for simplicity, but we chose to incorporate it for better accuracy.

The air at the surface is saturated, and thus the vapor pressure at the surface is simply the saturation pressure of water at the surface temperature (0.2563 psia). The vapor pressure of air far from the surface is determined from

$$P_{v,\infty} = \phi P_{\text{sat}@T_\infty} = (0.3)P_{\text{sat}@80^\circ\text{F}} = (0.3)(0.5073 \text{ psia}) = 0.152 \text{ psia}$$

Noting that the atmospheric pressure is 1 atm = 14.7 psia, substituting the known quantities gives

$$T_s = 80^\circ\text{F} - \frac{1060 \text{ Btu/lbm}}{(0.24 \text{ Btu/lbm}\cdot^\circ\text{F})(0.856)^{2/3}} \left(\frac{18 \text{ lbm/lbmol}}{29 \text{ lbm/lbmol}} \right) \frac{(0.2563 - 0.152) \text{ psia}}{14.7 \text{ psia}} = \mathbf{58.4^\circ\text{F}}$$

Therefore, the temperature of the drink can be lowered to 58.4°F by this process.

Discussion Note that the value obtained is very close to the assumed value of 60°F for the surface temperature. Therefore, there is no need to repeat the calculations with properties at the new surface temperature of 58.4°F

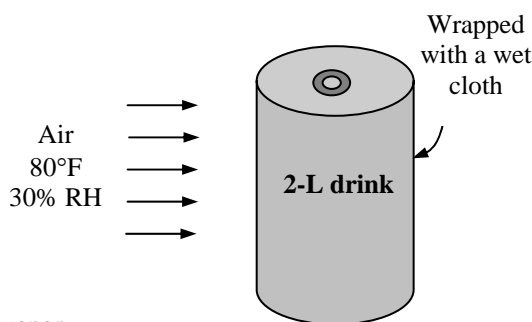

14-121 Glass bottles are washed in hot water in an uncovered rectangular glass washing bath. The rates of heat loss from the top and side surfaces of the bath by radiation, natural convection, and evaporation as well as the rates of heat and water mass that need to be supplied to the water are to be determined.

Assumptions 1 The low mass flux conditions exist so that the Chilton-Colburn analogy between heat and mass transfer is applicable since the mass fraction of vapor in the air is low (about 2 percent for saturated air at 300 K). **2** Both air and water vapor at specified conditions are ideal gases (the error involved in this assumption is less than 1 percent). **3** The entire water body and the metal container are maintained at a uniform temperature of 55°C. **4** Heat losses from the bottom surface are negligible. **5** The air motion around the bath is negligible so that there are no forced convection effects.

Properties The air-water vapor mixture is assumed to be dilute, and thus we can use dry air properties for the mixture at the average temperature of $(T_\infty + T_s)/2 = (25+55)/2 = 40^\circ\text{C}$. The properties of dry air at 40°C and 1 atm are, from Table A-15,

$$k = 0.02662 \text{ W/m} \cdot ^\circ\text{C}, \quad \text{Pr} = 0.7255$$

$$\alpha = 2.346 \times 10^{-5} \text{ m}^2/\text{s} \quad \nu = 1.700 \times 10^{-5} \text{ m}^2/\text{s}$$

The mass diffusivity of water vapor in air at the average temperature of 313 K is determined from Eq. 14-15 to be

$$D_{AB} = D_{\text{H}_2\text{O-air}} = 1.87 \times 10^{-10} \frac{T^{2.072}}{P} = 1.87 \times 10^{-10} \frac{(313\text{K})^{2.072}}{1 \text{ atm}} = 2.77 \times 10^{-5} \text{ m}^2/\text{s}$$

The saturation pressure of water at 25°C is $P_{\text{sat}@25^\circ\text{C}} = 3.169 \text{ kPa}$. Properties of water at 55°C are

$h_{fg} = 2371 \text{ kJ/kg}$ and $P_v = 15.76 \text{ kPa}$ (Table A-9). The specific heat of water at the average temperature of $(15+55)/2 = 35^\circ\text{C}$ is $c_p = 4.178 \text{ kJ/kg} \cdot ^\circ\text{C}$.

The gas constants of dry air and water are $R_{\text{air}} = 0.287 \text{ kPa} \cdot \text{m}^3/\text{kg} \cdot \text{K}$ and $R_{\text{water}} = 0.4615 \text{ kPa} \cdot \text{m}^3/\text{kg} \cdot \text{K}$ (Table A-1). Also, the emissivities of water and the sheet metal are given to be 0.61 and 0.95, respectively, and the specific heat of glass is $1.0 \text{ kJ/kg} \cdot ^\circ\text{C}$.

Analysis (a) The mass flow rate of glass bottles through the water bath in steady operation is

$$\dot{m}_{\text{bottle}} = m_{\text{bottle}} \times \text{Bottle flow rate} = (0.150 \text{ kg/bottle})(800 \text{ bottles/min}) = 120 \text{ kg/min} = 2 \text{ kg/s}$$

Then the rate of heat removal by the bottles as they are heated from 25 to 55°C is

$$\dot{Q}_{\text{bottle}} = \dot{m}_{\text{bottle}} c_p \Delta T = (2 \text{ kg/s})(1 \text{ kJ/kg} \cdot ^\circ\text{C})(55 - 25)^\circ\text{C} = 60,000 \text{ W}$$

The amount of water removed by the bottles is

$$\dot{m}_{\text{water, out}} = (\text{Flow rate of bottles})(\text{Water removed per bottle})$$

$$= (800 \text{ bottles/min})(0.6 \text{ g/bottle}) = 480 \text{ g/min} = 8 \times 10^{-3} \text{ kg/s} = 28.8 \text{ kg/h}$$

Noting that the water removed by the bottles is made up by fresh water entering at 15°C, the rate of heat removal by the water that sticks to the bottles is

$$\dot{Q}_{\text{water removed}} = \dot{m}_{\text{water removed}} c_p \Delta T = (8 \times 10^{-3} \text{ kg/s})(4178 \text{ J/kg} \cdot ^\circ\text{C})(55 - 15)^\circ\text{C} = 1337 \text{ W}$$

Therefore, the total amount of heat removed by the wet bottles is

$$\dot{Q}_{\text{total, removed}} = \dot{Q}_{\text{glass removed}} + \dot{Q}_{\text{water removed}} = 60,000 + 1337 = 61,337 \text{ W}$$

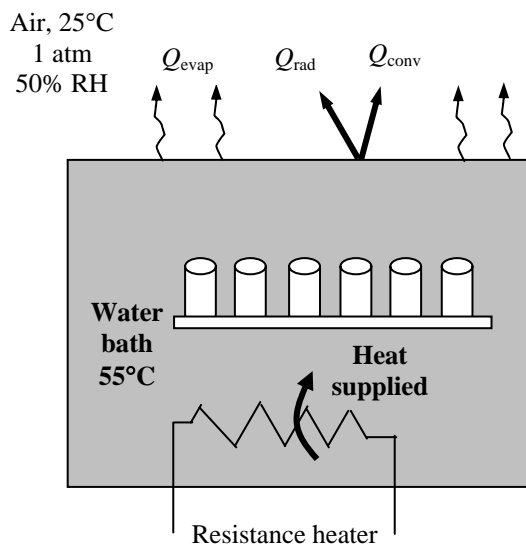

(b) The rate of heat loss from the top surface of the water bath is the sum of the heat losses by radiation, natural convection, and evaporation. Then the radiation heat loss from the top surface of water to the surrounding surfaces is

$$\dot{Q}_{\text{rad,top}} = \varepsilon A \sigma (T_s^4 - T_{\text{surr}}^4) = (0.95)(8 \text{ m}^2)(5.67 \times 10^{-8} \text{ W/m}^2 \cdot \text{K}^4)[(55 + 273 \text{ K})^4 - (15 + 273 \text{ K})^4] = 2023 \text{ W}$$

The air at the water surface is saturated, and thus the vapor pressure at the surface is simply the saturation pressure of water at the surface temperature (15.76 kPa at 55°C). The vapor pressure of air far from the water surface is determined from

$$P_{v,\infty} = \phi P_{\text{sat}@T_\infty} = (0.50)P_{\text{sat}@25^\circ\text{C}} = (0.50)(3.169 \text{ kPa}) = 1.585 \text{ kPa}$$

Treating the water vapor and the air as ideal gases and noting that the total atmospheric pressure is the sum of the vapor and dry air pressures, the densities of the water vapor, dry air, and their mixture at the water-air interface and far from the surface are determined to be

At the surface:

$$\rho_{v,s} = \frac{P_{v,s}}{R_v T_s} = \frac{15.76 \text{ kPa}}{(0.4615 \text{ kPa} \cdot \text{m}^3/\text{kg} \cdot \text{K})(55 + 273 \text{ K})} = 0.1041 \text{ kg/m}^3$$

$$\rho_{a,s} = \frac{P_{a,s}}{R_a T_s} = \frac{(101.325 - 15.76) \text{ kPa}}{(0.287 \text{ kPa} \cdot \text{m}^3/\text{kg} \cdot \text{K})(55 + 273 \text{ K})} = 0.9090 \text{ kg/m}^3$$

$$\rho_s = \rho_{v,s} + \rho_{a,s} = 0.1041 + 0.9090 = 1.0131 \text{ kg/m}^3$$

Away from the surface:

$$\rho_{v,\infty} = \frac{P_{v,\infty}}{R_v T_\infty} = \frac{1.585 \text{ kPa}}{(0.4615 \text{ kPa} \cdot \text{m}^3/\text{kg} \cdot \text{K})(25 + 273 \text{ K})} = 0.0115 \text{ kg/m}^3$$

$$\rho_{a,\infty} = \frac{P_{a,\infty}}{R_a T_\infty} = \frac{(101.325 - 1.585) \text{ kPa}}{(0.287 \text{ kPa} \cdot \text{m}^3/\text{kg} \cdot \text{K})(25 + 273 \text{ K})} = 1.1662 \text{ kg/m}^3$$

$$\rho_\infty = \rho_{v,\infty} + \rho_{a,\infty} = 0.0115 + 1.1662 = 1.1777 \text{ kg/m}^3$$

Note that $\rho_\infty > \rho_s$, and thus this corresponds to hot surface facing up. The area of the top surface of the water bath is $A_s = 2 \text{ m} \times 4 \text{ m} = 8 \text{ m}^2$ and its perimeter is $p = 2(2 + 4) = 12 \text{ m}$. Therefore, the characteristic length is

$$L = \frac{A_s}{p} = \frac{8 \text{ m}^2}{12 \text{ m}} = 0.667 \text{ m}$$

Then using densities (instead of temperatures) since the mixture is not homogeneous, the Grashoff number is determined to be

$$\text{Gr} = \frac{g(\rho_\infty - \rho_s)L^3}{\rho_{\text{avg}}\nu^2} = \frac{(9.81 \text{ m/s}^2)(1.1777 - 1.0131 \text{ kg/m}^3)(0.667 \text{ m})^3}{[(1.1777 + 1.0131)/2 \text{ kg/m}^3](1.702 \times 10^{-5} \text{ m}^2/\text{s})^2} = 1.52 \times 10^9$$

Recognizing that this is a natural convection problem with hot horizontal surface facing up, the Nusselt number and the convection heat transfer coefficients are determined to be

$$\text{Nu} = 0.15(\text{Gr Pr})^{1/3} = 0.15(1.52 \times 10^9 \times 0.726)^{1/3} = 155$$

$$\text{and } h_{\text{conv}} = \frac{\text{Nu}k}{L} = \frac{(155)(0.02662 \text{ W/m} \cdot ^\circ\text{C})}{0.667 \text{ m}} = 6.19 \text{ W/m}^2 \cdot ^\circ\text{C}$$

Then the natural convection heat transfer rate becomes

$$\dot{Q}_{\text{conv}} = h_{\text{conv}} A_s (T_s - T_\infty) = (6.19 \text{ W/m}^2 \cdot ^\circ\text{C})(8 \text{ m}^2)(55 - 25)^\circ\text{C} = 1486 \text{ W}$$

Utilizing the analogy between heat and mass convection, the mass transfer coefficient is determined the same way by replacing Pr by Sc. The Schmidt number is determined from its definition to be

$$\text{Sc} = \frac{\nu}{D_{AB}} = \frac{1.702 \times 10^{-5} \text{ m}^2/\text{s}}{2.77 \times 10^{-5} \text{ m}^2/\text{s}} = 0.614$$

The Sherwood number and the mass transfer coefficients are determined to be

$$\text{Sh} = 0.15(\text{GrSc})^{1/3} = 0.15(1.52 \times 10^9 \times 0.614)^{1/3} = 147$$

$$h_{\text{mass}} = \frac{\text{Sh}D_{AB}}{L} = \frac{(147)(2.77 \times 10^{-5} \text{ m}^2/\text{s})}{0.667 \text{ m}} = 0.00610 \text{ m/s}$$

Then the evaporation rate and the rate of heat transfer by evaporation become

$$\begin{aligned} \dot{m}_v &= h_{\text{mass}} A_s (\rho_{v,s} - \rho_{v,\infty}) \\ &= (0.00610 \text{ m/s})(8 \text{ m}^2)(0.1041 - 0.0115) \text{ kg/m}^3 \\ &= 0.00452 \text{ kg/s} = 16.3 \text{ kg/h} \end{aligned}$$

$$\text{and } \dot{Q}_{\text{evap}} = \dot{m}_v h_{fg} = (0.00452 \text{ kg/s})(2371 \text{ kJ/kg}) = 10.7 \text{ kW} = 10,700 \text{ W}$$

Then the total rate of heat loss from the open top surface of the bath to the surrounding air and surfaces is

$$\dot{Q}_{\text{total, top}} = \dot{Q}_{\text{rad}} + \dot{Q}_{\text{conv}} + \dot{Q}_{\text{evap}} = 2023 + 1486 + 10,700 = \mathbf{14,209 \text{ W}}$$

Therefore, if the water bath is heated electrically, a 14 kW resistance heater will be needed just to make up for the heat loss from the top surface.

(c) The side surfaces are vertical plates, and treating the air as dry air for simplicity, heat transfer from them by natural convection is determined to be

$$\text{Gr} = \frac{g\beta(T_s - T_\infty)L^3}{\nu^2} = \frac{(9.81 \text{ m/s}^2)(1/313 \text{ K})(55 - 25) \text{ K}(1 \text{ m})^3}{(1.702 \times 10^{-5} \text{ m}^2/\text{s})^2} = 3.25 \times 10^9$$

$$\text{Nu} = 0.1(\text{Gr Pr})^{1/3} = 0.1(3.25 \times 10^9 \times 0.7255)^{1/3} = 133$$

$$h_{\text{conv}} = \frac{\text{Nu}k}{L} = \frac{(133)(0.02662 \text{ W/m} \cdot \text{°C})}{1 \text{ m}} = 3.54 \text{ W/m}^2 \cdot \text{°C}$$

$$\dot{Q}_{\text{conv, side}} = h_{\text{conv}} A_s (T_s - T_\infty) = (3.54 \text{ W/m}^2 \cdot \text{°C})(12 \times 1 \text{ m}^2)(55 - 25) \text{°C} = 1275 \text{ W}$$

The radiation heat loss from the side surfaces of the bath to the surrounding surfaces is

$$\begin{aligned} \dot{Q}_{\text{rad, side}} &= \varepsilon A_s \sigma (T_s^4 - T_{\text{surr}}^4) \\ &= (0.61)(12 \text{ m} \times 1 \text{ m})(5.67 \times 10^{-8} \text{ W/m}^2 \cdot \text{K}^4)[(55 + 273 \text{ K})^4 - (15 + 273 \text{ K})^4] = 1948 \text{ W} \end{aligned}$$

$$\text{and } \dot{Q}_{\text{total, side}} = \dot{Q}_{\text{conv}} + \dot{Q}_{\text{rad}} = 1275 + 1948 = \mathbf{3223 \text{ W}}$$

(d) The rate at which water must be supplied to the maintain steady operation is equal to the rate of water removed by the bottles plus the rate evaporation,

$$\dot{m}_{\text{make-up}} = \dot{m}_{\text{removed}} + \dot{m}_{\text{evap}} = 0.00800 + 0.00452 = \mathbf{0.01252 \text{ kg/s} = 45.1 \text{ kg/h}}$$

Noting that the entire make-up water enters the bath 15°C, the rate of heat supply to preheat the make-up water to 55°C is

$$\dot{Q}_{\text{preheating water}} = \dot{m}_{\text{make-up water}} c_p \Delta T = (0.01252 \text{ kg/s})(4178 \text{ J/kg} \cdot \text{°C})(55 - 15) \text{°C} = 2092 \text{ W}$$

Then the rate of required heat supply for the bath becomes the sum of heat losses from the top and side surfaces, plus the heat needed for preheating the make-up water and the bottles,

$$\begin{aligned} \dot{Q}_{\text{total}} &= \dot{Q}_{\text{bottle}} + (\dot{Q}_{\text{rad}} + \dot{Q}_{\text{conv}} + \dot{Q}_{\text{evap}})_{\text{top}} + (\dot{Q}_{\text{rad}} + \dot{Q}_{\text{conv}})_{\text{side}} + \dot{Q}_{\text{makeup water}} \\ &= 61,337 + 14,209 + 3223 + 2092 = \mathbf{80,860 \text{ W}} \end{aligned}$$

Therefore, the heater must be able to supply heat at a rate of 80.9 kW to maintain steady operating conditions.

14-122 Glass bottles are washed in hot water in an uncovered rectangular glass washing bath. The rates of heat loss from the top and side surfaces of the bath by radiation, natural convection, and evaporation as well as the rates of heat and water mass that need to be supplied to the water are to be determined.

Assumptions 1 The low mass flux conditions exist so that the Chilton-Colburn analogy between heat and mass transfer is applicable since the mass fraction of vapor in the air is low (about 2 percent for saturated air at 300 K). **2** Both air and water vapor at specified conditions are ideal gases (the error involved in this assumption is less than 1 percent). **3** The entire water body and the metal container are maintained at a uniform temperature of 50°C. **4** Heat losses from the bottom surface are negligible. **5** The air motion around the bath is negligible so that there are no forced convection effects.

Properties The air-water vapor mixture is assumed to be dilute, and thus we can use dry air properties for the mixture at the average temperature of $(T_\infty + T_s)/2 = (25+50)/2 = 37.5^\circ\text{C}$. The properties of dry air at 37.5°C and 1 atm are, from Table A-15,

$$k = 0.02643 \text{ W/m} \cdot ^\circ\text{C}, \quad \text{Pr} = 0.7262$$

$$\alpha = 2.312 \times 10^{-5} \text{ m}^2/\text{s} \quad \nu = 1.679 \times 10^{-5} \text{ m}^2/\text{s}$$

The mass diffusivity of water vapor in air at the average temperature of 310.5 K is, from Eq. 14-15,

$$D_{AB} = D_{\text{H}_2\text{O-air}} = 1.87 \times 10^{-10} \frac{T^{2.072}}{P} = 1.87 \times 10^{-10} \frac{(310.5 \text{ K})^{2.072}}{1 \text{ atm}} = 2.73 \times 10^{-5} \text{ m}^2/\text{s}$$

The saturation pressure of water at 25°C is $P_{\text{sat}@25^\circ\text{C}} = 3.169 \text{ kPa}$. Properties of water at 50°C are $h_{fg} = 2383 \text{ kJ/kg}$ and $P_v = 12.35 \text{ kPa}$ (Table A-9). The specific heat of water at the average temperature of $(15+50)/2 = 32.5^\circ\text{C}$ is $c_p = 4.178 \text{ kJ/kg} \cdot ^\circ\text{C}$.

The gas constants of dry air and water are $R_{\text{air}} = 0.287 \text{ kPa} \cdot \text{m}^3/\text{kg} \cdot \text{K}$ and $R_{\text{water}} = 0.4615 \text{ kPa} \cdot \text{m}^3/\text{kg} \cdot \text{K}$ (Table A-1). Also, the emissivities of water and the sheet metal are given to be 0.61 and 0.95, respectively, and the specific heat of glass is given to be $1.0 \text{ kJ/kg} \cdot ^\circ\text{C}$.

Analysis (a) The mass flow rate of glass bottles through the water bath in steady operation is

$$\dot{m}_{\text{bottle}} = m_{\text{bottle}} \times \text{Bottle flow rate} = (0.150 \text{ kg/bottle})(800 \text{ bottles/min}) = 120 \text{ kg/min} = 2 \text{ kg/s}$$

Then the rate of heat removal by the bottles as they are heated from 25 to 50°C is

$$\dot{Q}_{\text{bottle}} = \dot{m}_{\text{bottle}} c_p \Delta T = (2 \text{ kg/s})(1 \text{ kJ/kg} \cdot ^\circ\text{C})(50 - 25)^\circ\text{C} = 50,000 \text{ W}$$

The amount of water removed by the bottles is

$$\begin{aligned} \dot{m}_{\text{water, out}} &= (\text{Flow rate of bottles})(\text{Water removed per bottle}) \\ &= (800 \text{ bottles/min})(0.6 \text{ g/bottle}) = 480 \text{ g/min} = \mathbf{8 \times 10^{-3} \text{ kg/s} = 28.8 \text{ kg/h}} \end{aligned}$$

Noting that the water removed by the bottles is made up by fresh water entering at 15°C, the rate of heat removal by the water that sticks to the bottles is

$$\dot{Q}_{\text{water removed}} = \dot{m}_{\text{water removed}} c_p \Delta T = (8 \times 10^{-3} \text{ kg/s})(4178 \text{ J/kg} \cdot ^\circ\text{C})(50 - 15)^\circ\text{C} = 1170 \text{ W}$$

Therefore, the total amount of heat removed by the wet bottles is

$$\dot{Q}_{\text{total, removed}} = \dot{Q}_{\text{glass removed}} + \dot{Q}_{\text{water removed}} = 50,000 + 1170 = \mathbf{51,170 \text{ W}}$$

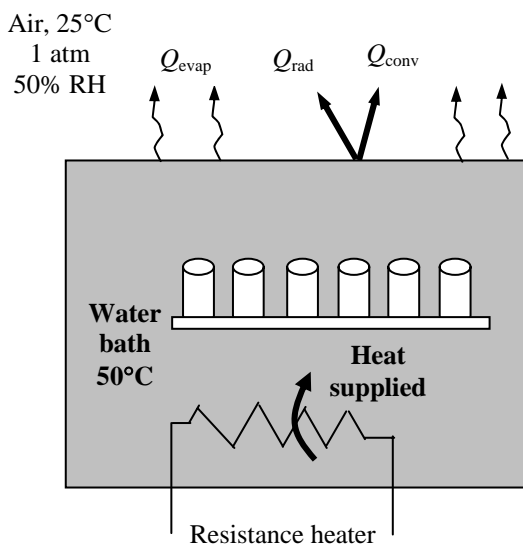

(b) The rate of heat loss from the top surface of the water bath is the sum of the heat losses by radiation, natural convection, and evaporation. Then the radiation heat loss from the top surface of water to the surrounding surfaces is

$$\dot{Q}_{\text{rad,top}} = \varepsilon A_s \sigma (T_s^4 - T_{\text{surr}}^4) = (0.95)(8 \text{ m}^2)(5.67 \times 10^{-8} \text{ W/m}^2 \cdot \text{K}^4)[(50 + 273 \text{ K})^4 - (15 + 273 \text{ K})^4] = \mathbf{1726 \text{ W}}$$

The air at the water surface is saturated, and thus the vapor pressure at the surface is simply the saturation pressure of water at the surface temperature (12.35 kPa at 50°C). The vapor pressure of air far from the water surface is determined from

$$P_{v,\infty} = \phi P_{\text{sat}@T_\infty} = (0.50)P_{\text{sat}@25^\circ\text{C}} = (0.50)(3.169 \text{ kPa}) = 1.585 \text{ kPa}$$

Treating the water vapor and the air as ideal gases and noting that the total atmospheric pressure is the sum of the vapor and dry air pressures, the densities of the water vapor, dry air, and their mixture at the water-air interface and far from the surface are determined to be

At the surface:

$$\rho_{v,s} = \frac{P_{v,s}}{R_v T_s} = \frac{12.35 \text{ kPa}}{(0.4615 \text{ kPa} \cdot \text{m}^3/\text{kg} \cdot \text{K})(50 + 273 \text{ K})} = 0.0829 \text{ kg/m}^3$$

$$\rho_{a,s} = \frac{P_{a,s}}{R_a T_s} = \frac{(101.325 - 12.35) \text{ kPa}}{(0.287 \text{ kPa} \cdot \text{m}^3/\text{kg} \cdot \text{K})(50 + 273 \text{ K})} = 0.9598 \text{ kg/m}^3$$

$$\rho_s = \rho_{v,s} + \rho_{a,s} = 0.0829 + 0.9598 = 1.0427 \text{ kg/m}^3$$

Away from the surface:

$$\rho_{v,\infty} = \frac{P_{v,\infty}}{R_v T_\infty} = \frac{1.585 \text{ kPa}}{(0.4615 \text{ kPa} \cdot \text{m}^3/\text{kg} \cdot \text{K})(25 + 273 \text{ K})} = 0.0115 \text{ kg/m}^3$$

$$\rho_{a,\infty} = \frac{P_{a,\infty}}{R_a T_\infty} = \frac{(101.325 - 1.585) \text{ kPa}}{(0.287 \text{ kPa} \cdot \text{m}^3/\text{kg} \cdot \text{K})(25 + 273 \text{ K})} = 1.1662 \text{ kg/m}^3$$

$$\rho_\infty = \rho_{v,\infty} + \rho_{a,\infty} = 0.0115 + 1.1662 = 1.1777 \text{ kg/m}^3$$

Note that $\rho_\infty > \rho_s$, and thus this corresponds to hot surface facing up. The area of the top surface of the water bath is $A_s = 2 \text{ m} \times 4 \text{ m} = 8 \text{ m}^2$ and its perimeter is $p = 2(2 + 4) = 12 \text{ m}$. Therefore, the characteristic length is

$$L = \frac{A_s}{p} = \frac{8 \text{ m}^2}{12 \text{ m}} = 0.667 \text{ m}$$

Then using densities (instead of temperatures) since the mixture is not homogeneous, the Grashoff number is determined to be

$$\text{Gr} = \frac{g(\rho_\infty - \rho_s)L^3}{\rho_{\text{avg}}\nu^2} = \frac{(9.81 \text{ m/s}^2)(1.1777 - 1.0427 \text{ kg/m}^3)(0.667 \text{ m})^3}{[(1.1777 + 1.0427)/2 \text{ kg/m}^3](1.679 \times 10^{-5} \text{ m}^2/\text{s})^2} = 1.26 \times 10^9$$

Recognizing that this is a natural convection problem with hot horizontal surface facing up, the Nusselt number and the convection heat transfer coefficients are determined to be

$$\text{Nu} = 0.15(\text{Gr Pr})^{1/3} = 0.15(1.26 \times 10^9 \times 0.7262)^{1/3} = 146$$

and
$$h_{\text{conv}} = \frac{\text{Nu}k}{L} = \frac{(146)(0.02643 \text{ W/m} \cdot ^\circ\text{C})}{0.667 \text{ m}} = 5.79 \text{ W/m}^2 \cdot ^\circ\text{C}$$

Then the natural convection heat transfer rate becomes

$$\dot{Q}_{\text{conv}} = h_{\text{conv}} A_s (T_s - T_\infty) = (5.79 \text{ W/m}^2 \cdot ^\circ\text{C})(8 \text{ m}^2)(50 - 25)^\circ\text{C} = \mathbf{1158 \text{ W}}$$

Utilizing the analogy between heat and mass convection, the mass transfer coefficient is determined the same way by replacing Pr by Sc. The Schmidt number is determined from its definition to be

$$\text{Sc} = \frac{\nu}{D_{AB}} = \frac{1.679 \times 10^{-5} \text{ m}^2/\text{s}}{2.73 \times 10^{-5} \text{ m}^2/\text{s}} = 0.615$$

The Sherwood number and the mass transfer coefficients are determined to be

$$\text{Sh} = 0.15(\text{GrSc})^{1/3} = 0.15(1.27 \times 10^9 \times 0.615)^{1/3} = 138$$

$$h_{\text{mass}} = \frac{\text{Sh}D_{AB}}{L} = \frac{(138)(2.73 \times 10^{-5} \text{ m}^2/\text{s})}{0.667 \text{ m}} = 0.00565 \text{ m/s}$$

Then the evaporation rate and the rate of heat transfer by evaporation become

$$\begin{aligned} \dot{m}_v &= h_{\text{mass}} A_s (\rho_{v,s} - \rho_{v,\infty}) \\ &= (0.00568 \text{ m/s})(8 \text{ m}^2)(0.0829 - 0.0115) \text{ kg/m}^3 \\ &= 0.00324 \text{ kg/s} = 11.7 \text{ kg/h} \end{aligned}$$

and $\dot{Q}_{\text{evap}} = \dot{m}_v h_{fg} = (0.00324 \text{ kg/s})(2383 \text{ kJ/kg}) = 7.72 \text{ kW} = \mathbf{7720 \text{ W}}$

The total rate of heat loss from the open top surface of the bath to the surrounding air and surfaces is

$$\dot{Q}_{\text{total, top}} = \dot{Q}_{\text{rad}} + \dot{Q}_{\text{conv}} + \dot{Q}_{\text{evap}} = 1726 + 1158 + 7720 = \mathbf{10,604 \text{ W}}$$

Therefore, if the water bath is heated electrically, a 10.6 kW resistance heater will be needed just to make up for the heat loss from the top surface.

(c) The side surfaces are vertical plates, and treating the air as dry air for simplicity, heat transfer from them by natural convection is determined to be

$$\text{Gr} = \frac{g\beta(T_s - T_\infty)L^3}{\nu^2} = \frac{(9.81 \text{ m/s}^2)(1/310.5 \text{ K})(50 - 25) \text{ K}(1 \text{ m})^3}{(1.679 \times 10^{-5} \text{ m}^2/\text{s})^2} = 2.80 \times 10^9$$

$$\text{Nu} = 0.1(\text{Gr Pr})^{1/3} = 0.1(2.80 \times 10^9 \times 0.7262)^{1/3} = 127$$

$$h_{\text{conv}} = \frac{\text{Nu}k}{L} = \frac{(127)(0.02643 \text{ W/m} \cdot \text{°C})}{1 \text{ m}} = 3.36 \text{ W/m}^2 \cdot \text{°C}$$

$$\dot{Q}_{\text{conv, side}} = h_{\text{conv}} A_s (T_s - T_\infty) = (3.36 \text{ W/m}^2 \cdot \text{°C})(12 \times 1 \text{ m}^2)(50 - 25) \text{°C} = 1007 \text{ W}$$

The radiation heat loss from the side surfaces of the bath to the surrounding surfaces is

$$\begin{aligned} \dot{Q}_{\text{rad, side}} &= \varepsilon A_s \sigma (T_s^4 - T_{\text{surr}}^4) \\ &= (0.61)(12 \text{ m} \times 1 \text{ m})(5.67 \times 10^{-8} \text{ W/m}^2 \cdot \text{K}^4)[(50 + 273 \text{ K})^4 - (15 + 273 \text{ K})^4] = 1662 \text{ W} \end{aligned}$$

and $\dot{Q}_{\text{total, side}} = \dot{Q}_{\text{conv}} + \dot{Q}_{\text{rad}} = 1007 + 1662 = \mathbf{2669 \text{ W}}$

(d) The rate at which water must be supplied to the maintain steady operation is equal to the rate of water removed by the bottles plus the rate evaporation,

$$\dot{m}_{\text{make-up}} = \dot{m}_{\text{removed}} + \dot{m}_{\text{evap}} = 0.00800 + 0.00324 = \mathbf{0.01124 \text{ kg/s}} = \mathbf{40.5 \text{ kg/h}}$$

Noting that the entire make-up water enters the bath 15°C, the rate of heat supply to preheat the make-up water to 50°C is

$$\dot{Q}_{\text{preheating water}} = \dot{m}_{\text{make-up water}} c_p \Delta T = (0.01124 \text{ kg/s})(4178 \text{ J/kg} \cdot \text{°C})(50 - 15) \text{°C} = 1644 \text{ W}$$

Then the rate of required heat supply for the bath becomes the sum of heat losses from the top and side surfaces, plus the heat needed for preheating the make-up water and the bottles,

$$\begin{aligned} \dot{Q}_{\text{total}} &= \dot{Q}_{\text{bottle}} + (\dot{Q}_{\text{rad}} + \dot{Q}_{\text{conv}} + \dot{Q}_{\text{evap}})_{\text{top}} + (\dot{Q}_{\text{rad}} + \dot{Q}_{\text{conv}})_{\text{side}} + \dot{Q}_{\text{makeup water}} \\ &= 51,170 + 10,604 + 2669 + 1644 = \mathbf{66,087 \text{ W}} \end{aligned}$$

Therefore, the heater must be able to supply heat at a rate of 66.1 kW to maintain steady operating conditions.

14-123 A person is standing outdoors in windy weather. The rates of heat loss from the head by radiation, forced convection, and evaporation are to be determined for the cases of the head being wet and dry.

Assumptions 1 The low mass flux conditions exist so that the Chilton-Colburn analogy between heat and mass transfer is applicable since the mass fraction of vapor in the air is low (about 2 percent for saturated air at 300 K). **2** Both air and water vapor at specified conditions are ideal gases (the error involved in this assumption is less than 1 percent). **3** The head can be approximated as a sphere of 30 cm diameter maintained at a uniform temperature of 30°C. **4** The surrounding surfaces are at the same temperature as the ambient air.

Properties The air-water vapor mixture is assumed to be dilute, and thus we can use dry air properties for the mixture. The properties of air at the free stream temperature of 25°C and 1 atm are, from Table A-15,

$$k = 0.02551 \text{ W/m} \cdot \text{C}, \quad \text{Pr} = 0.7296$$

$$\mu = 1.849 \times 10^{-5} \text{ kg/m} \cdot \text{s} \quad \nu = 1.562 \times 10^{-5} \text{ m}^2/\text{s}$$

Also, $\mu_s = \mu_{@30^\circ\text{C}} = 1.872 \times 10^{-5} \text{ kg/m} \cdot \text{s}$. The mass diffusivity of water vapor in air at the average temperature of $(25 + 30)/2 = 27.5^\circ\text{C} = 300.5 \text{ K}$ is, from Eq. 14-15,

$$D_{AB} = D_{\text{H}_2\text{O-air}} = 1.87 \times 10^{-10} \frac{T^{2.072}}{P} = 1.87 \times 10^{-10} \frac{(300.5 \text{ K})^{2.072}}{1 \text{ atm}} = 2.55 \times 10^{-5} \text{ m}^2/\text{s}$$

The saturation pressure of water at 25°C is $P_{\text{sat}@25^\circ\text{C}} = 3.169 \text{ kPa}$. Properties of water at 30°C are $h_{fg} = 2431 \text{ kJ/kg}$ and $P_v = 4.246 \text{ kPa}$ (Table A-9).

The gas constants of dry air and water are $R_{\text{air}} = 0.287 \text{ kPa} \cdot \text{m}^3/\text{kg} \cdot \text{K}$ and $R_{\text{water}} = 0.4615 \text{ kPa} \cdot \text{m}^3/\text{kg} \cdot \text{K}$ (Table A-1). Also, the emissivity of the head is given to be 0.95.

Analysis (a) When the head is dry, heat transfer from the head is by forced convection and radiation only. The radiation heat transfer is

$$\dot{Q}_{\text{rad}} = \varepsilon A_s \sigma (T_s^4 - T_{\text{surr}}^4) = (0.95) [\pi (0.3 \text{ m})^2] (5.67 \times 10^{-8} \text{ W/m}^2 \cdot \text{K}^4) [(30 + 273 \text{ K})^4 - (25 + 273 \text{ K})^4] = 8.3 \text{ W}$$

The Reynolds number for flow over the head is

$$\text{Re} = \frac{VD}{\nu} = \frac{(25/3.6 \text{ m/s})(0.3 \text{ m})}{1.562 \times 10^{-5} \text{ m}^2/\text{s}} = 133,380$$

Then the Nusselt number and the heat transfer coefficient become

$$\begin{aligned} \text{Nu} &= 2 + \left[0.4 \text{Re}^{1/2} + 0.06 \text{Re}^{2/3} \right] \text{Pr}^{0.4} \left(\frac{\mu_\infty}{\mu_s} \right)^{1/4} \\ &= 2 + \left[0.4(133,380)^{1/2} + 0.06(133,380)^{2/3} \right] (0.7296)^{0.4} \left(\frac{1.849 \times 10^{-5}}{1.872 \times 10^{-5}} \right)^{1/4} = 268 \end{aligned}$$

$$h = \frac{k}{D} \text{Nu} = \frac{0.02551 \text{ W/m} \cdot \text{C}}{0.3 \text{ m}} (268) = 22.8 \text{ W/m}^2 \cdot \text{C}$$

Then the rate of convection heat transfer from the head becomes

$$\dot{Q}_{\text{conv}} = h A_s (T_s - T_\infty) = (22.8 \text{ W/m}^2 \cdot \text{C}) [\pi (0.3 \text{ m})^2] (30 - 25)^\circ\text{C} = 32.2 \text{ W}$$

Therefore,

$$\dot{Q}_{\text{total,dry}} = \dot{Q}_{\text{conv}} + \dot{Q}_{\text{rad}} = 32.2 + 8.3 = \mathbf{40.5 \text{ W}}$$

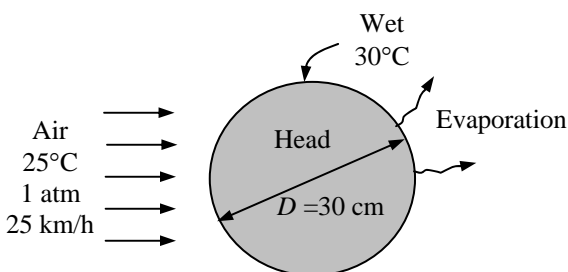

(b) When the head is wet, there is additional heat transfer mechanism by evaporation. The Schmidt number is

$$Sc = \frac{\nu}{D_{AB}} = \frac{1.562 \times 10^{-5} \text{ m}^2/\text{s}}{2.55 \times 10^{-5} \text{ m}^2/\text{s}} = 0.613$$

The Sherwood number and the mass transfer coefficients are determined to be

$$\begin{aligned} Sh &= 2 + \left[0.4 Re^{1/2} + 0.06 Re^{2/3} \right] Sc^{0.4} \left(\frac{\mu_\infty}{\mu_s} \right)^{1/4} \\ &= 2 + \left[0.4(133,380)^{1/2} + 0.06(133,380)^{2/3} \right] (0.613)^{0.4} \left(\frac{1.849 \times 10^{-5}}{1.872 \times 10^{-5}} \right)^{1/4} = 250 \\ h_{\text{mass}} &= \frac{Sh D_{AB}}{L} = \frac{(250)(2.55 \times 10^{-5} \text{ m}^2/\text{s})}{0.3 \text{ m}} = 0.0213 \text{ m/s} \end{aligned}$$

The air at the water surface is saturated, and thus the vapor pressure at the surface is simply the saturation pressure of water at the surface temperature (4.246 kPa at 30°C). The vapor pressure of air far from the water surface is determined from

$$P_{v,\infty} = \phi P_{\text{sat}@T_\infty} = (0.30)P_{\text{sat}@25^\circ\text{C}} = (0.30)(3.169 \text{ kPa}) = 0.9507 \text{ kPa}$$

Treating the water vapor and the air as ideal gases, the vapor densities at the water-air interface and far from the surface are determined to be

$$\text{At the surface:} \quad \rho_{v,s} = \frac{P_{v,s}}{R_v T_s} = \frac{4.246 \text{ kPa}}{(0.4615 \text{ kPa} \cdot \text{m}^3/\text{kg} \cdot \text{K})(30 + 273) \text{ K}} = 0.0304 \text{ kg/m}^3$$

$$\text{Away from the surface:} \quad \rho_{v,\infty} = \frac{P_{v,\infty}}{R_v T_s} = \frac{0.9507 \text{ kPa}}{(0.4615 \text{ kPa} \cdot \text{m}^3/\text{kg} \cdot \text{K})(25 + 273) \text{ K}} = 0.0069 \text{ kg/m}^3$$

Then the evaporation rate and the rate of heat transfer by evaporation become

$$\begin{aligned} \dot{m}_v &= h_{\text{mass}} A_s (\rho_{v,s} - \rho_{v,\infty}) = (0.0213 \text{ m/s})[\pi(0.3 \text{ m})^2](0.0304 - 0.0069) \text{ kg/m}^3 \\ &= 0.0001415 \text{ kg/s} \end{aligned}$$

and

$$\dot{Q}_{\text{evap}} = \dot{m}_v h_{fg} = (0.0001415 \text{ kg/s})(2431 \text{ kJ/kg}) = 0.344 \text{ kW} = 344 \text{ W}$$

Then the total rate of heat loss from the wet head to the surrounding air and surfaces becomes

$$\dot{Q}_{\text{total,wet}} = \dot{Q}_{\text{conv}} + \dot{Q}_{\text{rad}} + \dot{Q}_{\text{evap}} = 32.2 + 8.3 + 344 = \mathbf{385 \text{ W}}$$

Discussion Note that the heat loss from the head can be increased by more than 9 times in this case by wetting the head and allowing heat transfer by evaporation.

14-124 The heating system of a heated swimming pool is being designed. The rates of heat loss from the top surface of the pool by radiation, natural convection, and evaporation are to be determined.

Assumptions 1 The low mass flux conditions exist so that the Chilton-Colburn analogy between heat and mass transfer is applicable since the mass fraction of vapor in the air is low (about 2 percent for saturated air at 300 K). **2** Both air and water vapor at specified conditions are ideal gases (the error involved in this assumption is less than 1 percent). **3** The entire water body in the pool is maintained at a uniform temperature of 30°C. **4** The air motion around the pool is negligible so that there are no forced convection effects.

Properties The air-water vapor mixture is assumed to be dilute, and thus we can use dry air properties for the mixture at the average temperature of $(T_\infty + T_s)/2 = (20+30)/2 = 25^\circ\text{C} = 298\text{ K}$. The properties of dry air at 298 K and 1 atm are, from Table A-15,

$$k = 0.02551\text{ W/m}\cdot^\circ\text{C}, \text{ Pr} = 0.7296$$

$$\alpha = 2.141 \times 10^{-5}\text{ m}^2/\text{s} \quad \nu = 1.562 \times 10^{-5}\text{ m}^2/\text{s}$$

The mass diffusivity of water vapor in air at the average temperature of 298 K is determined from Eq. 14-15 to be

$$\begin{aligned} D_{AB} = D_{\text{H}_2\text{O-air}} &= 1.87 \times 10^{-10} \frac{T^{2.072}}{P} \\ &= 1.87 \times 10^{-10} \frac{(298\text{ K})^{2.072}}{1\text{ atm}} = 2.50 \times 10^{-5}\text{ m}^2/\text{s} \end{aligned}$$

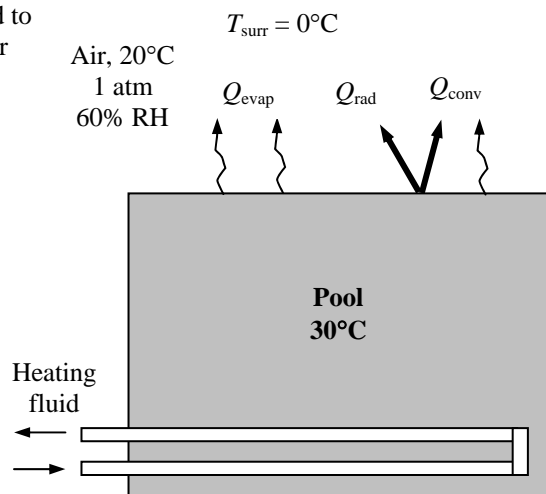

The saturation pressure of water at 20°C is $P_{\text{sat}@20^\circ\text{C}} = 2.339\text{ kPa}$. Properties of water at 30°C are

$h_{fg} = 2431\text{ kJ/kg}$ and $P_v = 4.246\text{ kPa}$ (Table A-9). The gas constants of dry air and water are $R_{\text{air}} = 0.287\text{ kPa}\cdot\text{m}^3/\text{kg}\cdot\text{K}$ and $R_{\text{water}} = 0.4615\text{ kPa}\cdot\text{m}^3/\text{kg}\cdot\text{K}$ (Table A-1). The emissivity of water is 0.95 (Table A-18).

Analysis (a) The surface area of the pool is

$$A = (20\text{ m})(20\text{ m}) = 400\text{ m}^2$$

Heat transfer from the top surface of the pool by radiation is

$$\dot{Q}_{\text{rad}} = \varepsilon A \sigma (T_s^4 - T_{\text{surr}}^4) = (0.95)(400\text{ m}^2)(5.67 \times 10^{-8}\text{ W/m}^2 \cdot \text{K}^4) [(30 + 273\text{ K})^4 - (0 + 273\text{ K})^4] = \mathbf{61,930\text{ W}}$$

(b) The air at the water surface is saturated, and thus the vapor pressure at the surface is simply the saturation pressure of water at the surface temperature (4.246 kPa at 30°C). The vapor pressure of air far from the water surface is determined from

$$P_{v,\infty} = \phi P_{\text{sat}@T_\infty} = (0.60)P_{\text{sat}@20^\circ\text{C}} = (0.60)(2.339\text{ kPa}) = 1.40\text{ kPa}$$

Treating the water vapor and the air as ideal gases and noting that the total atmospheric pressure is the sum of the vapor and dry air pressures, the densities of the water vapor, dry air, and their mixture at the water-air interface and far from the surface are determined to be

At the surface:

$$\rho_{v,s} = \frac{P_{v,s}}{R_v T_s} = \frac{4.246\text{ kPa}}{(0.4615\text{ kPa}\cdot\text{m}^3/\text{kg}\cdot\text{K})(30 + 273)\text{ K}} = 0.0304\text{ kg/m}^3$$

$$\rho_{a,s} = \frac{P_{a,s}}{R_a T_s} = \frac{(101.325 - 4.246)\text{ kPa}}{(0.287\text{ kPa}\cdot\text{m}^3/\text{kg}\cdot\text{K})(30 + 273)\text{ K}} = 1.1164\text{ kg/m}^3$$

$$\rho_s = \rho_{v,s} + \rho_{a,s} = 0.0304 + 1.1164 = 1.1468\text{ kg/m}^3$$

Away from the surface:

$$\rho_{v,\infty} = \frac{P_{v,\infty}}{R_v T_\infty} = \frac{1.40 \text{ kPa}}{(0.4615 \text{ kPa} \cdot \text{m}^3/\text{kg} \cdot \text{K})(20 + 273) \text{ K}} = 0.0104 \text{ kg/m}^3$$

$$\rho_{a,\infty} = \frac{P_{a,\infty}}{R_a T_\infty} = \frac{(101.325 - 1.40) \text{ kPa}}{(0.287 \text{ kPa} \cdot \text{m}^3/\text{kg} \cdot \text{K})(20 + 273) \text{ K}} = 1.1883 \text{ kg/m}^3$$

$$\rho_\infty = \rho_{v,\infty} + \rho_{a,\infty} = 0.0104 + 1.1883 = 1.1987 \text{ kg/m}^3$$

Note that $\rho_\infty > \rho_s$, and thus this corresponds to hot surface facing up. The perimeter of the top surface of the pool is $p = 2(20 + 20) = 80 \text{ m}$. Therefore, the characteristic length is

$$L = \frac{A_s}{p} = \frac{400 \text{ m}^2}{80 \text{ m}} = 5 \text{ m}$$

Then using densities (instead of temperatures) since the mixture is not homogeneous, the Grashoff number is determined to be

$$\text{Gr} = \frac{g(\rho_\infty - \rho_s)L^3}{\rho_{\text{ave}}\nu^2} = \frac{(9.81 \text{ m/s}^2)(1.1987 - 1.1468 \text{ kg/m}^3)(5 \text{ m})^3}{[(1.1987 + 1.1468)/2 \text{ kg/m}^3](1.562 \times 10^{-5} \text{ m}^2/\text{s})^2} = 2.22 \times 10^{11}$$

Recognizing that this is a natural convection problem with hot horizontal surface facing up, the Nusselt number and the convection heat transfer coefficients are determined to be

$$\text{Nu} = 0.15(\text{Gr Pr})^{1/3} = 0.15(2.22 \times 10^{11} \times 0.7296)^{1/3} = 818$$

and
$$h_{\text{conv}} = \frac{\text{Nu}k}{L} = \frac{(818)(0.02551 \text{ W/m} \cdot \text{°C})}{5 \text{ m}} = 4.17 \text{ W/m}^2 \cdot \text{°C}$$

Then natural convection heat transfer rate becomes

$$\dot{Q}_{\text{conv}} = h_{\text{conv}} A_s (T_s - T_\infty) = (4.17 \text{ W/m}^2 \cdot \text{°C})(400 \text{ m}^2)(30 - 20) \text{°C} = \mathbf{16,680 \text{ W}}$$

(c) Utilizing the analogy between heat and mass convection, the mass transfer coefficient is determined the same way by replacing Pr by Sc. The Schmidt number is determined from its definition to be

$$\text{Sc} = \frac{\nu}{D_{AB}} = \frac{1.562 \times 10^{-5} \text{ m}^2/\text{s}}{2.50 \times 10^{-5} \text{ m}^2/\text{s}} = 0.625$$

The Sherwood number and the mass transfer coefficients are determined to be

$$\text{Sh} = 0.15(\text{GrSc})^{1/3} = 0.15(2.22 \times 10^{11} \times 0.625)^{1/3} = 777$$

$$h_{\text{mass}} = \frac{\text{Sh}D_{AB}}{L} = \frac{(777)(2.50 \times 10^{-5} \text{ m}^2/\text{s})}{5 \text{ m}} = 0.00390 \text{ m/s}$$

Then the evaporation rate and the rate of heat transfer by evaporation become

$$\begin{aligned} \dot{m}_v &= h_{\text{mass}} A_s (\rho_{v,s} - \rho_{v,\infty}) = (0.00390 \text{ m/s})(400 \text{ m}^2)(0.0304 - 0.0104) \text{ kg/m}^3 \\ &= 0.0312 \text{ kg/s} = 112 \text{ kg/h} \end{aligned}$$

and
$$\dot{Q}_{\text{evap}} = \dot{m}_v h_{fg} = (0.0312 \text{ kg/s})(2,431,000 \text{ J/kg}) = \mathbf{75,850 \text{ W}}$$

Then the total rate of heat loss from the open top surface of the pool to the surrounding air and surfaces is

$$\dot{Q}_{\text{total, top}} = \dot{Q}_{\text{rad}} + \dot{Q}_{\text{conv}} + \dot{Q}_{\text{evap}} = 61,930 + 16,680 + 75,850 = \mathbf{154,460 \text{ W}}$$

Therefore, if the pool is heated electrically, a 155 kW resistance heater will be needed to make up for the heat losses from the top surface.

14-125 The heating system of a heated swimming pool is being designed. The rates of heat loss from the top surface of the pool by radiation, natural convection, and evaporation are to be determined.

Assumptions 1 The low mass flux conditions exist so that the Chilton-Colburn analogy between heat and mass transfer is applicable since the mass fraction of vapor in the air is low (about 2 percent for saturated air at 300 K). **2** Both air and water vapor at specified conditions are ideal gases (the error involved in this assumption is less than 1 percent). **3** The entire water body in the pool is maintained at a uniform temperature of 25°C. **4** The air motion around the pool is negligible so that there are no forced convection effects.

Properties The air-water vapor mixture is assumed to be dilute, and thus we can use dry air properties for the mixture at the average temperature of $(T_\infty + T_s)/2 = (20+25)/2 = 22.5^\circ\text{C} = 295.5\text{ K}$. The properties of dry air at 22.5°C and 1 atm are, from Table A-15,

$$k = 0.02533\text{ W/m}\cdot^\circ\text{C}, \text{ Pr} = 0.7303$$

$$\alpha = 2.108 \times 10^{-5}\text{ m}^2/\text{s} \quad \nu = 1.539 \times 10^{-5}\text{ m}^2/\text{s}$$

The mass diffusivity of water vapor in air at the average temperature of 295.5 K is, from Eq. 14-15,

$$\begin{aligned} D_{AB} = D_{\text{H}_2\text{O-air}} &= 1.87 \times 10^{-10} \frac{T^{2.072}}{P} \\ &= 1.87 \times 10^{-10} \frac{(295.5\text{ K})^{2.072}}{1\text{ atm}} \\ &= 2.46 \times 10^{-5}\text{ m}^2/\text{s} \end{aligned}$$

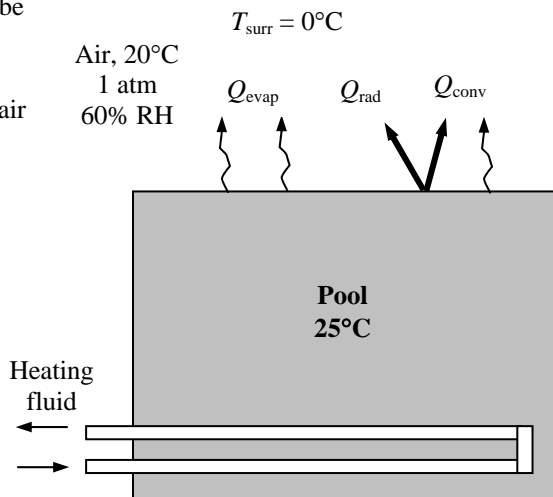

The saturation pressure of water at 20°C is $P_{\text{sat}@20^\circ\text{C}} = 2.339\text{ kPa}$. Properties of water at 25°C are $h_{fg} = 2442\text{ kJ/kg}$ and $P_v = 3.169\text{ kPa}$ (Table A-9). The gas constants of dry air and water are $R_{\text{air}} = 0.287\text{ kPa}\cdot\text{m}^3/\text{kg}\cdot\text{K}$ and $R_{\text{water}} = 0.4615\text{ kPa}\cdot\text{m}^3/\text{kg}\cdot\text{K}$ (Table A-1). The emissivity of water is 0.95 (Table A-18).

Analysis (a) The surface area of the pool is

$$A_s = (20\text{ m})(20\text{ m}) = 400\text{ m}^2$$

Heat transfer from the top surface of the pool by radiation is

$$\dot{Q}_{\text{rad}} = \varepsilon A \sigma (T_s^4 - T_{\text{surr}}^4) = (0.95)(400\text{ m}^2)(5.67 \times 10^{-8}\text{ W/m}^2 \cdot \text{K}^4) [(25 + 273\text{ K})^4 - (0 + 273\text{ K})^4] = \mathbf{50,240\text{ W}}$$

(b) The air at the water surface is saturated, and thus the vapor pressure at the surface is simply the saturation pressure of water at the surface temperature (3.169 kPa at 25°C). The vapor pressure of air far from the water surface is determined from

$$P_{v,\infty} = \phi P_{\text{sat}@T_\infty} = (0.60)P_{\text{sat}@20^\circ\text{C}} = (0.60)(2.339\text{ kPa}) = 1.40\text{ kPa}$$

Treating the water vapor and the air as ideal gases and noting that the total atmospheric pressure is the sum of the vapor and dry air pressures, the densities of the water vapor, dry air, and their mixture at the water-air interface and far from the surface are determined to be

At the surface:

$$\begin{aligned} \rho_{v,s} &= \frac{P_{v,s}}{R_v T_s} = \frac{3.169\text{ kPa}}{(0.4615\text{ kPa}\cdot\text{m}^3/\text{kg}\cdot\text{K})(25 + 273)\text{ K}} = 0.0230\text{ kg/m}^3 \\ \rho_{a,s} &= \frac{P_{a,s}}{R_a T_s} = \frac{(101.325 - 3.169)\text{ kPa}}{(0.287\text{ kPa}\cdot\text{m}^3/\text{kg}\cdot\text{K})(25 + 273)\text{ K}} = 1.1477\text{ kg/m}^3 \\ \rho_s &= \rho_{v,s} + \rho_{a,s} = 0.0230 + 1.1477 = 1.1707\text{ kg/m}^3 \end{aligned}$$

Away from the surface:

$$\rho_{v,\infty} = \frac{P_{v,\infty}}{R_v T_\infty} = \frac{1.40 \text{ kPa}}{(0.4615 \text{ kPa} \cdot \text{m}^3/\text{kg} \cdot \text{K})(20 + 273) \text{ K}} = 0.0104 \text{ kg/m}^3$$

$$\rho_{a,\infty} = \frac{P_{a,\infty}}{R_a T_\infty} = \frac{(101.325 - 1.40) \text{ kPa}}{(0.287 \text{ kPa} \cdot \text{m}^3/\text{kg} \cdot \text{K})(20 + 273) \text{ K}} = 1.1883 \text{ kg/m}^3$$

$$\rho_\infty = \rho_{v,\infty} + \rho_{a,\infty} = 0.0104 + 1.1883 = 1.1987 \text{ kg/m}^3$$

Note that $\rho_\infty > \rho_s$, and thus this corresponds to hot surface facing up. The perimeter of the top surface of the pool is $p = 2(20 + 20) = 80 \text{ m}$. Therefore, the characteristic length is

$$L = \frac{A_s}{p} = \frac{400 \text{ m}^2}{80 \text{ m}} = 5 \text{ m}$$

Then using densities (instead of temperatures) since the mixture is not homogeneous, the Grashoff number is determined to be

$$\text{Gr} = \frac{g(\rho_\infty - \rho_s)L^3}{\rho_{\text{avg}}\nu^2} = \frac{(9.81 \text{ m/s}^2)(1.1987 - 1.1707 \text{ kg/m}^3)(5 \text{ m})^3}{[(1.1987 + 1.1707)/2 \text{ kg/m}^3](1.539 \times 10^{-5} \text{ m}^2/\text{s})^2} = 1.22 \times 10^{11}$$

Recognizing that this is a natural convection problem with hot horizontal surface facing up, the Nusselt number and the convection heat transfer coefficients are determined to be

$$\text{Nu} = 0.15(\text{Gr Pr})^{1/3} = 0.15(1.22 \times 10^{11} \times 0.73)^{1/3} = 670$$

and
$$h_{\text{conv}} = \frac{\text{Nu}k}{L} = \frac{(670)(0.02533 \text{ W/m} \cdot \text{°C})}{5 \text{ m}} = 3.39 \text{ W/m}^2 \cdot \text{°C}$$

Then natural convection heat transfer rate becomes

$$\dot{Q}_{\text{conv}} = h_{\text{conv}} A_s (T_s - T_\infty) = (3.39 \text{ W/m}^2 \cdot \text{°C})(400 \text{ m}^2)(25 - 20) \text{°C} = \mathbf{6780 \text{ W}}$$

(c) Utilizing the analogy between heat and mass convection, the mass transfer coefficient is determined the same way by replacing Pr by Sc. The Schmidt number is determined from its definition to be

$$\text{Sc} = \frac{\nu}{D_{AB}} = \frac{1.539 \times 10^{-5} \text{ m}^2/\text{s}}{2.46 \times 10^{-5} \text{ m}^2/\text{s}} = 0.626$$

The Sherwood number and the mass transfer coefficients are determined to be

$$\text{Sh} = 0.15(\text{GrSc})^{1/3} = 0.15(1.22 \times 10^{11} \times 0.626)^{1/3} = 636$$

$$h_{\text{mass}} = \frac{\text{Sh}D_{AB}}{L} = \frac{(636)(2.46 \times 10^{-5} \text{ m}^2/\text{s})}{5 \text{ m}} = 0.00313 \text{ m/s}$$

Then the evaporation rate and the rate of heat transfer by evaporation become

$$\begin{aligned} \dot{m}_v &= h_{\text{mass}} A_s (\rho_{v,s} - \rho_{v,\infty}) = (0.00313 \text{ m/s})(400 \text{ m}^2)(0.0230 - 0.0104) \text{ kg/m}^3 \\ &= 0.0158 \text{ kg/s} = 57.0 \text{ kg/h} \end{aligned}$$

and
$$\dot{Q}_{\text{evap}} = \dot{m}_v h_{fg} = (0.0158 \text{ kg/s})(2,442,000 \text{ J/kg}) = \mathbf{38,580 \text{ W}}$$

Then the total rate of heat loss from the open top surface of the pool to the surrounding air and surfaces is

$$\dot{Q}_{\text{total, top}} = \dot{Q}_{\text{rad}} + \dot{Q}_{\text{conv}} + \dot{Q}_{\text{evap}} = 50,240 + 6780 + 38,580 = \mathbf{95,600 \text{ W}}$$

Therefore, if the pool is heated electrically, a 96 kW resistance heater will be needed to make up for the heat losses from the top surface.

Review Problems

14-126C (a) T, (b) F, (c) F, (d) T

14-127 Henry's law is expressed as

$$y_{i, \text{liquid side}}(0) = \frac{P_{i, \text{gas side}}(0)}{H}$$

Henry's constant H increases with temperature, and thus the fraction of gas i in the liquid $y_{i, \text{liquid side}}$ decreases. Therefore, heating a liquid will drive off the dissolved gases in a liquid.

14-128 The ideal gas relation can be expressed as $PV = NR_uT = mRT$ where R_u is the universal gas constant, whose value is the same for all gases, and R is the gas constant whose value is different for different gases. The molar and mass densities of an ideal gas mixture can be expressed as

$$PV = NR_uT \rightarrow C = \frac{N}{V} = \frac{P}{R_uT} = \text{constant}$$

and $PV = mRT \rightarrow \rho = \frac{m}{V} = \frac{P}{RT} \neq \text{constant}$

Therefore, for an ideal gas mixture maintained at a constant temperature and pressure, the molar concentration C of the mixture remains constant but this is not necessarily the case for the density ρ of mixture.

14-129E The masses of the constituents of a gas mixture at a specified temperature and pressure are given. The partial pressure of each gas and the volume of the mixture are to be determined.

Assumptions The gas mixture and its constituents are ideal gases.

Properties The molar masses of CO_2 and CH_4 are 44 and 16 kg/kmol, respectively (Table A-1)

Analysis The mole numbers of each gas and of the mixture are

$$\text{CO}_2 : N_{\text{CO}_2} = \frac{m_{\text{CO}_2}}{M_{\text{CO}_2}} = \frac{1 \text{ lbmol}}{44 \text{ lbmol}} = 0.0227 \text{ lbmol}$$

$$\text{CH}_4 : N_{\text{CH}_4} = \frac{m_{\text{CH}_4}}{M_{\text{CH}_4}} = \frac{3 \text{ lbmol}}{16 \text{ lbmol}} = 0.1875 \text{ lbmol}$$

$$N_{\text{total}} = N_{\text{CO}_2} + N_{\text{CH}_4} = 0.0227 + 0.1875 = 0.2102$$

1 lbm CO_2
3 lbm CH_4

600 R
20 psia

Using the ideal gas relation for the mixture and for the constituents, the volume of the mixture and the partial pressures of the constituents are determined to be

$$V = \frac{NR_uT}{P} = \frac{(0.2102 \text{ lbmol})(10.73 \text{ psia} \cdot \text{ft}^3 / \text{lbmol} \cdot \text{R})}{20 \text{ psia}} = \mathbf{67.66 \text{ ft}^3}$$

$$P_{\text{CO}_2} = \frac{N_{\text{CO}_2} R_u T}{V} = \frac{(0.0227 \text{ lbmol})(10.73 \text{ psia} \cdot \text{ft}^3 / \text{lbmol} \cdot \text{R})(600 \text{ R})}{67.66 \text{ ft}^3} = \mathbf{2.16 \text{ psia}}$$

$$P_{\text{CH}_4} = \frac{N_{\text{CH}_4} R_u T}{V} = \frac{(0.1875 \text{ lbmol})(10.73 \text{ psia} \cdot \text{ft}^3 / \text{lbmol} \cdot \text{R})(600 \text{ R})}{67.66 \text{ ft}^3} = \mathbf{17.84 \text{ psia}}$$

Discussion Note that each constituent of a gas mixture occupies the same volume (the volume of the container), and that the total pressure of a gas mixture is equal to the sum of the partial pressures of its constituents. That is, $P_{\text{total}} = P_{\text{CO}_2} + P_{\text{CH}_4} = 2.16 + 17.84 = 20 \text{ psia}$.

14-130 Dry air flows over a water body at constant pressure and temperature until it is saturated. The molar analysis of the saturated air and the density of air before and after the process are to be determined.

Assumptions The air and the water vapor are ideal gases.

Properties The molar masses of N_2 , O_2 , Ar, and H_2O are 28.0, 32.0, 39.95 and 18 kg / kmol, respectively (Table A-1). The molar analysis of dry air is given to be 78.1 percent N_2 , 20.9 percent O_2 , and 1 percent Ar. The saturation pressure of water at 25°C is 3.169 kPa (Table A-9). Also, $1 \text{ atm} = 101.325 \text{ kPa}$.

Analysis (a) Noting that the total pressure remains constant at 101.32 kPa during this process, the partial pressure of air becomes

$$P = P_{\text{air}} + P_{\text{vapor}}$$

$$P_{\text{air}} = P - P_{\text{vapor}}$$

$$= 101.325 - 3.169 = 98.156 \text{ kPa}$$

Then the molar analysis of the saturated air becomes

$$y_{H_2O} = \frac{P_{H_2O}}{P} = \frac{3.169}{101.325} = \mathbf{0.0313}$$

$$y_{N_2} = \frac{P_{N_2}}{P} = \frac{y_{N_2, \text{dry}} P_{\text{dry air}}}{P} = \frac{0.781(98.156 \text{ kPa})}{101.325} = \mathbf{0.7566}$$

$$y_{O_2} = \frac{P_{O_2}}{P} = \frac{y_{O_2, \text{dry}} P_{\text{dry air}}}{P} = \frac{0.209(98.156 \text{ kPa})}{101.325} = \mathbf{0.2025}$$

$$y_{Ar} = \frac{P_{Ar}}{P} = \frac{y_{Ar, \text{dry}} P_{\text{dry air}}}{P} = \frac{0.01(98.156 \text{ kPa})}{101.325} = \mathbf{0.0097}$$

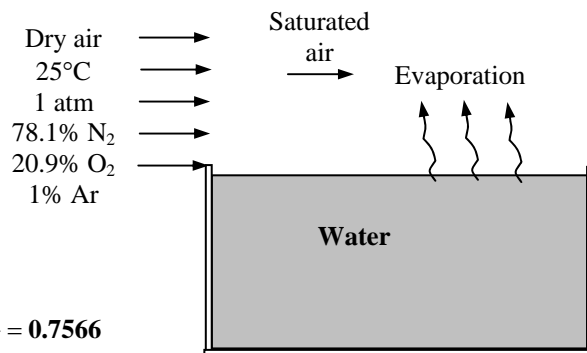

(b) The molar masses of dry and saturated air are

$$M_{\text{dry air}} = \sum y_i M_i = 0.781 \times 28.0 + 0.209 \times 32.0 + 0.01 \times 39.95 = 29.0 \text{ kg/kmol}$$

$$M_{\text{sat air}} = \sum y_i M_i = 0.7566 \times 28.0 + 0.2025 \times 32.0 + 0.0097 \times 39.9 + 0.0313 \times 18 = 28.62 \text{ kg/kmol}$$

Then the densities of dry and saturated air are determined from the ideal gas relation to be

$$\rho_{\text{dry air}} = \frac{P}{(R_u / M_{\text{dry air}}) T} = \frac{101.325 \text{ kPa}}{[(8.314 \text{ kPa} \cdot \text{m}^3/\text{kmol} \cdot \text{K}) / 29.0 \text{ kg/kmol}](25 + 273) \text{ K}} = \mathbf{1.186 \text{ kg/m}^3}$$

$$\rho_{\text{sat air}} = \frac{P}{(R_u / M_{\text{sat air}}) T} = \frac{101.325 \text{ kPa}}{[(8.314 \text{ kPa} \cdot \text{m}^3/\text{kmol} \cdot \text{K}) / 28.62 \text{ kg/kmol}](25 + 273) \text{ K}} = \mathbf{1.170 \text{ kg/m}^3}$$

Discussion We conclude that the density of saturated air is less than that of the dry air, as expected. This is due to the molar mass of water being less than that of dry air.

14-131 A glass of water is left in a room. The mole fraction of the water vapor in the air at the water surface and far from the surface as well as the mole fraction of air in the water near the surface are to be determined when the water and the air are at the same temperature.

Assumptions 1 Both the air and water vapor are ideal gases. **2** Air is weakly soluble in water and thus Henry's law is applicable.

Properties The saturation pressure of water at 20°C is 2.339 kPa (Table A-9). Henry's constant for air dissolved in water at 20°C (293 K) is given in Table 14-6 to be $H = 65,600$ bar. Molar masses of dry air and water are 29 and 18 kg/kmol, respectively (Table A-1).

Analysis (a) Noting that the relative humidity of air is 70%, the partial pressure of water vapor in the air far from the water surface will be

$$P_{v, \text{room air}} = \phi P_{\text{sat @ } 20^\circ\text{C}} = (0.7)(2.339 \text{ kPa}) = 1.637 \text{ kPa}$$

Assuming both the air and vapor to be ideal gases, the mole fraction of water vapor in the room air is

$$y_{\text{vapor}} = \frac{P_{\text{vapor}}}{P} = \frac{1.637 \text{ kPa}}{100 \text{ kPa}} = \mathbf{0.0164} \quad (\text{or } \mathbf{1.64\%})$$

(b) Noting that air at the water surface is saturated, the partial pressure of water vapor in the air near the surface will simply be the saturation pressure of water at 20°C, $P_{v, \text{interface}} = P_{\text{sat @ } 20^\circ\text{C}} = 2.339 \text{ kPa}$. Then the mole fraction of water vapor in the air at the interface becomes

$$y_{v, \text{surface}} = \frac{P_{v, \text{surface}}}{P} = \frac{2.339 \text{ kPa}}{100 \text{ kPa}} = \mathbf{0.0234} \quad (\text{or } \mathbf{2.34\%})$$

(c) Noting that the total pressure is 100 kPa, the partial pressure of dry air at the water surface is

$$P_{\text{air, surface}} = P - P_{v, \text{surface}} = 100 - 2.339 = 97.661 \text{ kPa}$$

From Henry's law, the mole fraction of air in the water is determined to be

$$y_{\text{dry air, liquid side}} = \frac{P_{\text{dry air, gas side}}}{H} = \frac{(97.661/101.325) \text{ bar}}{65,600 \text{ bar}} = \mathbf{1.47 \times 10^{-5}} = \mathbf{0.0015\%}$$

Discussion The water cannot remain at the room temperature when the air is not saturated. Therefore, some water will evaporate and the water temperature will drop until a balance is reached between the rate of heat transfer to the water and the rate of evaporation.

Air
20°C
100 kPa
70% RH

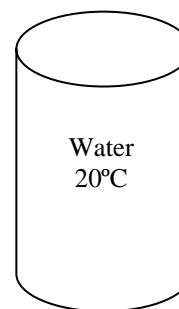

14-132 EES Using the relation $D_{AB} = 2.67 \times 10^{-5} \exp(-17,400/T)$ the diffusion coefficient of carbon in steel is to be plotted.

Analysis The problem is solved using EES, and the solution is given below.

$$D_{AB} = 2.67 \times 10^{-5} \exp(-17400/T)$$

T, K	$D_{AB}, \text{m}^2/\text{s}$
300	1.728×10^{-30}
400	3.426×10^{-24}
500	2.056×10^{-20}
600	6.792×10^{-18}
700	4.277×10^{-16}
800	9.563×10^{-15}
900	1.071×10^{-13}
1000	7.409×10^{-13}
1100	3.604×10^{-12}
1200	1.347×10^{-11}
1300	4.108×10^{-11}
1400	1.068×10^{-10}
1500	2.447×10^{-10}

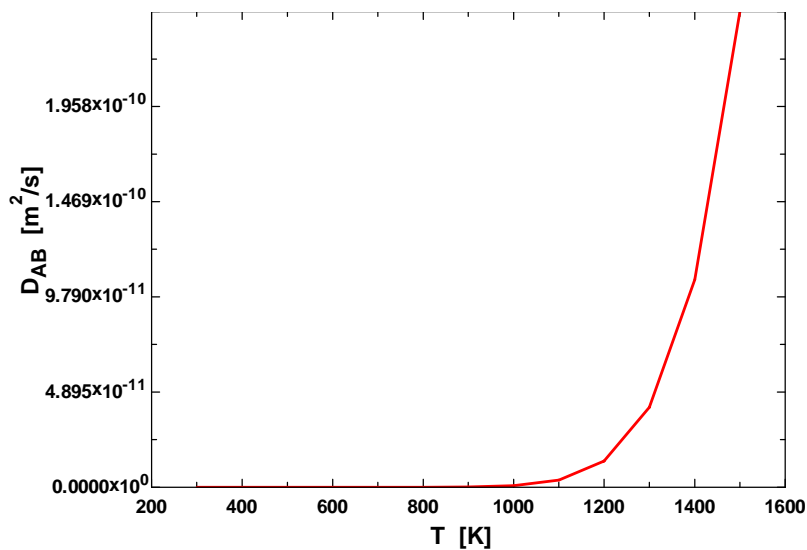

14-133 A 2-L bottle is filled with carbonated drink that is fully charged (saturated) with CO₂ gas. The volume that the CO₂ gas would occupy if it is released and stored in a container at room conditions is to be determined.

Assumptions 1 The liquid drink can be treated as water. **2** Both the CO₂ gas and the water vapor are ideal gases. **3** The CO₂ gas is weakly soluble in water and thus Henry's law is applicable.

Properties The saturation pressure of water at 17°C is 1.96 kPa (Table A-9). Henry's constant for CO₂ dissolved in water at 17°C (290 K) is $H = 1280$ bar (Table 14-6). Molar masses of CO₂ and water are 44.01 and 18.015 kg/kmol, respectively (Table A-1). The gas constant of CO₂ is 0.1889 kPa·m³/kg·K. Also, 1 bar = 100 kPa.

Analysis (a) In the charging station, the CO₂ gas and water vapor mixture above the liquid will form a saturated mixture. Noting that the saturation pressure of water at 17°C is 1.96 kPa, the partial pressure of the CO₂ gas is

$$P_{\text{CO}_2, \text{gas side}} = P - P_{\text{vapor}} = P - P_{\text{sat}@17^\circ\text{C}} = 600 - 1.96 = 598.04 \text{ kPa} = 5.9804 \text{ bar}$$

From Henry's law, the mole fraction of CO₂ in the liquid drink is determined to be

$$y_{\text{CO}_2, \text{liquid side}} = \frac{P_{\text{CO}_2, \text{gas side}}}{H} = \frac{5.9804 \text{ bar}}{1280 \text{ bar}} = 0.00467$$

Then the mole fraction of water in the drink becomes

$$y_{\text{water, liquid side}} = 1 - y_{\text{CO}_2, \text{liquid side}} = 1 - 0.00467 = 0.99533$$

The mass and mole fractions of a mixture are related to each other by

$$w_i = \frac{m_i}{m_m} = \frac{N_i M_i}{N_m M_m} = y_i \frac{M_i}{M_m}$$

where the apparent molar mass of the drink (liquid water - CO₂ mixture) is

$$M_m = \sum y_i M_i = y_{\text{liquid water}} M_{\text{water}} + y_{\text{CO}_2} M_{\text{CO}_2} = 0.99533 \times 18.015 + 0.00467 \times 44.01 = 18.14 \text{ kg/kmol}$$

Then the mass fraction of dissolved CO₂ in liquid drink becomes

$$w_{\text{CO}_2, \text{liquid side}} = y_{\text{CO}_2, \text{liquid side}} \frac{M_{\text{CO}_2}}{M_m} = 0.00467 \frac{44.01}{18.14} = 0.0113$$

Therefore, the mass of dissolved CO₂ in a 2 L ≈ 2 kg drink is

$$m_{\text{CO}_2} = w_{\text{CO}_2} m_m = 0.0113(2 \text{ kg}) = 0.0226 \text{ kg}$$

Then the volume occupied by this CO₂ at the room conditions of 25°C and 100 kPa becomes

$$v = \frac{mRT}{P} = \frac{(0.0226 \text{ kg})(0.1889 \text{ kPa} \cdot \text{m}^3 / \text{kg} \cdot \text{K})(298 \text{ K})}{100 \text{ kPa}} = \mathbf{0.0127 \text{ m}^3 = 12.7 \text{ L}}$$

Discussion Note that the amount of dissolved CO₂ in a 2-L pressurized drink is large enough to fill 6 such bottles at room temperature and pressure. Also, we could simplify the calculations by assuming the molar mass of carbonated drink to be the same as that of water, and take it to be 18 kg/kmol because of the very low mole fraction of CO₂ in the drink.

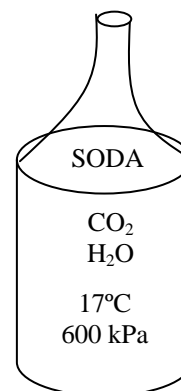

14-134 The walls of a house are made of 20-cm thick bricks. The maximum amount of water vapor that will diffuse through a 3 m × 5 m section of the wall in 24-h is to be determined.

Assumptions 1 Steady operating conditions exist. 2 Mass transfer through the wall is one-dimensional. 3 The vapor permeability of the wall is constant. 4 The vapor pressure at the outer side of the wall is zero.

Properties The permeance of the brick wall is given to be 23×10^{-12} kg/s.m².Pa. The saturation pressure of water at 20°C is 2339 Pa (Table 14-9).

Analysis The mass flow rate of water vapor through a plain layer of thickness L and normal area A is given by (Eq. 14-31)

$$\dot{m}_v = PA \frac{P_{v,1} - P_{v,2}}{L} = PA \frac{\phi_1 P_{\text{sat},1} - \phi_2 P_{\text{sat},2}}{L} = MA(\phi_1 P_{\text{sat},1} - \phi_2 P_{\text{sat},2})$$

where P is the vapor permeability and $M = P/L$ is the permeance of the material, ϕ is the relative humidity and P_{sat} is the saturation pressure of water at the specified temperature. Subscripts 1 and 2 denote the air on the two sides of the wall.

Noting that the vapor pressure at the outer side of the wallboard is zero ($\phi_2 = 0$) and substituting, the mass flow rate of water vapor through the wall is determined to be

$$\dot{m}_v = (23 \times 10^{-12} \text{ kg/s.m}^2 \cdot \text{Pa})(3 \times 5 \text{ m}^2)[0.60(2339 \text{ Pa}) - 0] = 4.842 \times 10^{-7} \text{ kg/s}$$

Then the total amount of moisture that flows through the wall during a 24-h period becomes

$$m_{v,24-h} = \dot{m}_v \Delta t = (4.842 \times 10^{-7} \text{ kg/s})(24 \times 3600 \text{ s}) = \mathbf{0.0418 \text{ kg} = 41.8 \text{ g}}$$

Discussion This is the maximum amount of moisture that can migrate through the wall since we assumed the vapor pressure on one side of the wall to be zero.

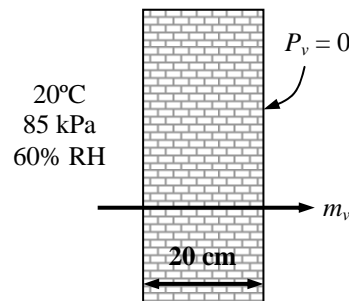

14-135E The thermal and vapor resistances of different layers of a wall are given. The rates of heat and moisture transfer through the wall under steady conditions are to be determined.

Assumptions 1 Steady operating conditions exist. 2 Heat transfer through the wall is one-dimensional. 3 Thermal and vapor resistances of different layers of the wall and the heat transfer coefficients are constant. 4 Condensation does not occur inside the wall.

Properties The thermal and vapor resistances are as given in the problem statement. The saturation pressures of water at 70°F and 32°F are 0.3632 and 0.0887 psia, respectively (Table 14-9E).

Construction	R-value, h.ft ² ·°F/Btu	R _v -value, s.ft ² ·psia/lbm
1. Outside surface, 15 mph wind	0.17	-
2. Face brick, 4 in.	0.43	15,000
3. Cement mortar, 0.5 in.	0.10	1930
4. Concrete block, 6 in.	4.20	23,000
5. Air space, ¾ in.	1.02	77.6
6. Gypsum wallboard, 0.5 in.	0.45	332
7. Inside surface, still air	0.68	-

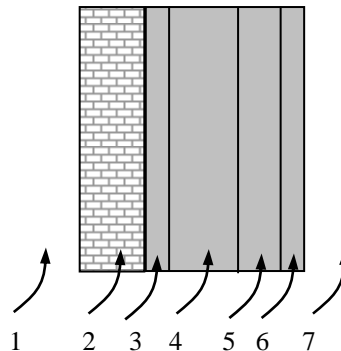

Analysis Noting that all the layers of the wall are in series, the total thermal resistance of the wall for a 1-ft² section is determined by simply adding the R-values of all layers

$$R_{\text{total}} = \sum R\text{-value} = 0.17 + 0.43 + 0.10 + 4.20 + 1.02 + 0.45 + 0.68 = 7.05 \text{ h} \cdot \text{ft}^2 \cdot \text{°F/Btu}$$

Then the rate of heat transfer through the entire wall becomes

$$\dot{Q}_{\text{wall}} = A \frac{T_i - T_o}{R_{\text{total}}} = (9 \times 25 \text{ ft}^2) \frac{(70 - 32) \text{ °F}}{7.05 \text{ h} \cdot \text{ft}^2 \cdot \text{°F/Btu}} = \mathbf{1213 \text{ Btu/h}}$$

The vapor pressures at the indoors and the outdoors is

$$P_{v,1} = \phi_1 P_{\text{sat},1} = 0.65 \times (0.3632 \text{ psia}) = 0.2361 \text{ psia}$$

$$P_{v,2} = \phi_2 P_{\text{sat},2} = 0.40 \times (0.0887 \text{ psia}) = 0.0355 \text{ psia}$$

The total vapor resistance of the wall for a 1-ft² section is determined by simply adding the R_v-values of all layers,

$$R_{v,\text{total}} = \sum R_v\text{-value} = 15,000 + 1930 + 23,000 + 77.6 + 332 = 40,340 \text{ s} \cdot \text{ft}^2 \cdot \text{psia/lbm}$$

Then the rate of moisture flow through the interior and exterior parts of the wall becomes

$$\dot{m}_{v,\text{wall}} = A \frac{P_{v,1} - P_{v,2}}{R_{v,\text{total}}} = (9 \times 25 \text{ ft}^2) \frac{(0.2361 - 0.0355) \text{ psia}}{40,340 \text{ s} \cdot \text{ft}^2 \cdot \text{psia/lbm}} = 0.00112 \text{ lbm/s} = \mathbf{4.03 \text{ lbm/h}}$$

14-136 An aquarium is oxygenated by forcing air to the bottom of it. The mole fraction of water vapor is to be determined at the center of the air bubbles when they reach the free surface of water.

Assumptions **1** The air bubbles are initially completely dry. **2** The bubbles are spherical and possess symmetry about the midpoint. **3** Air is weakly soluble in water and thus Henry's law is applicable. **4** Convection effects in the bubble are negligible. **5** The pressure and temperature of the air bubbles remain constant at 1 atm and 25°C. **6** Both the air and the vapor are ideal gases.

Properties Henry's constant for oxygen dissolved in water at 300 K ($\cong 25^\circ\text{C}$) is given in Table 14-6 to be $H = 43,600$ bar. The saturation pressure of water at 25°C is 3.169 kPa (Table A-9). The mass diffusivity of water vapor in air at 298 K is, from Eq. 14-15,

$$D_{AB} = D_{\text{H}_2\text{O-air}} = 1.87 \times 10^{-10} \frac{T^{2.072}}{P} = 1.87 \times 10^{-10} \frac{(298 \text{ K})^{2.072}}{1 \text{ atm}} = 2.50 \times 10^{-5} \text{ m}^2 / \text{s}$$

Analysis This problem is analogous to the one-dimensional transient heat conduction problem in a sphere with specified surface temperature, and thus can be solved accordingly. Noting that the air in the bubble at the air-water interface will be saturated, the vapor pressure at the interface will be

$$P_{v,\text{surface}} = P_{\text{sat @ } 25^\circ\text{C}} = 3.169 \text{ kPa}$$

Then the mole fraction of vapor at the bubble interface becomes

$$y_{v,\text{surface}} = \frac{P_{v,\text{surface}}}{P} = \frac{3.169 \text{ kPa}}{101.325 \text{ kPa}} = 0.0313$$

The mass transfer Fourier number for $t = 2$ s is

$$\tau = \frac{D_{AB}t}{r_o^2} = \frac{(2.50 \times 10^{-5} \text{ m}^2 / \text{s})(2 \text{ s})}{(2 \times 10^{-3} \text{ m})^2} = 12.5$$

Then the mole fraction of water vapor at the center of the bubble in 2 s can be determined from

$$\frac{y_{v,\text{center}} - y_{v,\text{surface}}}{y_{v,\text{initial}} - y_{v,\text{surface}}} = A_1 e^{-\lambda_1^2 \tau}$$

The Biot number $\text{Bi} = hr_o/k$ in this case is infinity since a specified surface concentration corresponds to an infinitely large mass transfer coefficient ($h \rightarrow \infty$). Then the two constants in the equation above are determined from Table 4-1 to be $\lambda_1 = 3.1416$ and $A_1 = 2$. Also, $y_{v,\text{initial}} = 0$ since the air is initially dry.

Substituting, the mole fraction of water vapor at the center of the bubble in 2 s is determined to be

$$\frac{y_{v,\text{center}} - 0.0313}{0 - 0.0313} = 2e^{-(3.1416)^2(12.5)} = 5.27 \times 10^{-54} \cong 0 \rightarrow y_{v,\text{center}} = y_{v,\text{surface}} = \mathbf{0.0313}$$

That is, the air bubbles become saturated when they leave the aquarium.

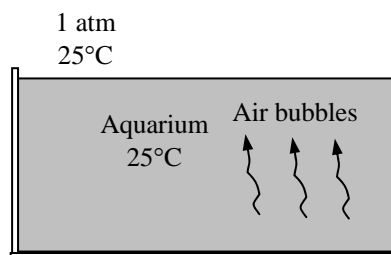

14-137 An aquarium is oxygenated by forcing oxygen to the bottom of it, and letting the oxygen bubbles rise. The penetration depth of oxygen in the water during the rising time is to be determined.

Assumptions **1** Convection effects in the water are negligible. **2** The pressure and temperature of the oxygen bubbles remain constant.

Properties The mass diffusivity of oxygen in liquid water at 298 K is $D_{AB} = 2.4 \times 10^{-9} \text{ m}^2 / \text{s}$ (Table 14-3b).

Analysis The penetration depth can be determined directly from its definition (Eq. 14-38) to be

$$\begin{aligned} \delta_{\text{diff}} &= \sqrt{\pi D_{AB}t} = \sqrt{\pi(2.4 \times 10^{-9} \text{ m}^2 / \text{s})(4 \text{ s})} \\ &= 1.73 \times 10^{-4} \text{ m} = \mathbf{0.173 \text{ mm}} \end{aligned}$$

Therefore, oxygen will penetrate the water only a fraction of a millimeter.

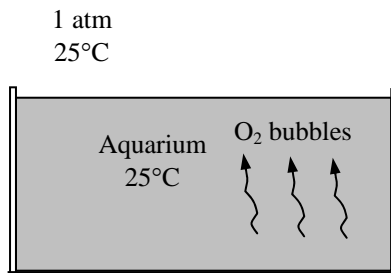

14-138 A circular pan filled with water is cooled naturally. The rate of evaporation of water, the rate of heat transfer by natural convection, and the rate of heat supply to the water needed to maintain its temperature constant are to be determined.

Assumptions 1 The low mass flux model and thus the analogy between heat and mass transfer is applicable since the mass fraction of vapor in the air is low (about 2 percent for saturated air at 25°C). **2** The critical Reynolds number for flow over a flat plate is 500,000. **3** Radiation heat transfer is negligible. **4** Both air and water vapor are ideal gases.

Properties The air-water vapor mixture is assumed to be dilute, and thus we can use dry air properties for the mixture at the average temperature of $(T_\infty + T_s)/2 = (15+20)/2 = 17.5^\circ\text{C} = 290.5\text{ K}$. The properties of dry air at 17.5°C and 1 atm are, from Table A-15,

$$k = 0.02495\text{ W/m}\cdot^\circ\text{C}, \quad \text{Pr} = 0.7316$$

$$\alpha = 2.042 \times 10^{-5}\text{ m}^2/\text{s} \quad \nu = 1.493 \times 10^{-5}\text{ m}^2/\text{s}$$

The mass diffusivity of water vapor in air at the average temperature of 290.5 K is, from Eq. 14-15,

$$\begin{aligned} D_{AB} &= D_{\text{H}_2\text{O-air}} = 1.87 \times 10^{-10} \frac{T^{2.072}}{P} \\ &= 1.87 \times 10^{-10} \frac{(290.5\text{ K})^{2.072}}{1\text{ atm}} = 2.37 \times 10^{-5}\text{ m}^2/\text{s} \end{aligned}$$

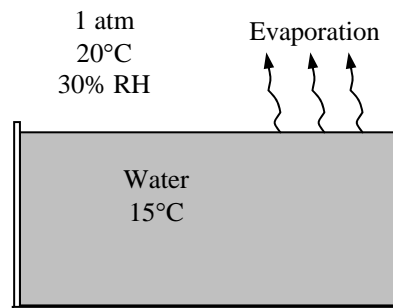

The saturation pressure of water at 20°C is $P_{\text{sat}@20^\circ\text{C}} = 2.339\text{ kPa}$. Properties of water at 15°C are

$h_{fg} = 2466\text{ kJ/kg}$ and $P_v = 1.7051\text{ kPa}$ (Table A-9). The specific heat of water at the average temperature of $(15+20)/2 = 17.5^\circ\text{C}$ is $c_p = 4.184\text{ kJ/kg}\cdot^\circ\text{C}$. The gas constants of dry air and water are $R_{\text{air}} = 0.287\text{ kPa}\cdot\text{m}^3/\text{kg}\cdot\text{K}$ and $R_{\text{water}} = 0.4615\text{ kPa}\cdot\text{m}^3/\text{kg}\cdot\text{K}$ (Table A-1).

Analysis (a) The air at the water surface is saturated, and thus the vapor pressure at the surface is simply the saturation pressure of water at the surface temperature (1.7051 kPa at 15°C). The vapor pressure of air far from the water surface is determined from

$$P_{v,\infty} = \phi P_{\text{sat}@T_\infty} = (0.30)P_{\text{sat}@20^\circ\text{C}} = (0.30)(2.339\text{ kPa}) = 0.7017\text{ kPa}$$

Treating the water vapor and the air as ideal gases and noting that the total atmospheric pressure is the sum of the vapor and dry air pressures, the densities of the water vapor, dry air, and their mixture at the water-air interface and far from the surface are determined to be

At the surface:

$$\rho_{v,s} = \frac{P_{v,s}}{R_v T_s} = \frac{1.7051\text{ kPa}}{(0.4615\text{ kPa}\cdot\text{m}^3/\text{kg}\cdot\text{K})(15 + 273)\text{ K}} = 0.01283\text{ kg/m}^3$$

$$\rho_{a,s} = \frac{P_{a,s}}{R_a T_s} = \frac{(101.325 - 1.7051)\text{ kPa}}{(0.287\text{ kPa}\cdot\text{m}^3/\text{kg}\cdot\text{K})(15 + 273)\text{ K}} = 1.2052\text{ kg/m}^3$$

$$\rho_s = \rho_{v,s} + \rho_{a,s} = 0.01283 + 1.2052 = 1.21803\text{ kg/m}^3$$

Away from the surface:

$$\rho_{v,\infty} = \frac{P_{v,\infty}}{R_v T_\infty} = \frac{0.7017\text{ kPa}}{(0.4615\text{ kPa}\cdot\text{m}^3/\text{kg}\cdot\text{K})(20 + 273)\text{ K}} = 0.00519\text{ kg/m}^3$$

$$\rho_{a,\infty} = \frac{P_{a,\infty}}{R_a T_\infty} = \frac{(101.325 - 0.7017)\text{ kPa}}{(0.287\text{ kPa}\cdot\text{m}^3/\text{kg}\cdot\text{K})(20 + 273)\text{ K}} = 1.1966\text{ kg/m}^3$$

$$\rho_\infty = \rho_{v,\infty} + \rho_{a,\infty} = 0.00519 + 1.1966 = 1.2018\text{ kg/m}^3$$

Note that $\rho_\infty < \rho_s$, and thus this corresponds to hot surface facing down. The area of the top surface of the water $A_s = \pi r_o^2$ and its perimeter is $p = 2\pi r_o$. Therefore, the characteristic length is

$$L = \frac{A_s}{p} = \frac{\pi r_o^2}{2\pi r_o} = \frac{r_o}{2} = \frac{0.15 \text{ m}}{2} = 0.075 \text{ m}$$

Then using densities (instead of temperatures) since the mixture is not homogeneous, the Grashoff number is determined to be

$$\text{Gr} = \frac{g(\rho_\infty - \rho_s)L^3}{\rho_{\text{ave}}\nu^2} = \frac{(9.81 \text{ m/s}^2)(1.21803 - 1.2018 \text{ kg/m}^3)(0.075 \text{ m})^3}{[(1.2180 + 1.2018)/2 \text{ kg/m}^3](1.493 \times 10^{-5} \text{ m}^2/\text{s})^2} = 2.49 \times 10^5$$

Recognizing that this is a natural convection problem with cold horizontal surface facing up, the Nusselt number and the convection heat transfer coefficients are determined to be (Table 14-13)

$$\text{Nu} = 0.27(\text{Gr Pr})^{1/4} = 0.27(2.49 \times 10^5 \times 0.7316)^{1/4} = 5.58$$

and

$$h_{\text{conv}} = \frac{\text{Nu}k}{L} = \frac{(5.58)(0.02495 \text{ W/m} \cdot \text{°C})}{0.075 \text{ m}} = 1.86 \text{ W/m}^2 \cdot \text{°C}$$

Then the rate of heat transfer from the air to the water by forced convection becomes

$$\dot{Q}_{\text{conv}} = h_{\text{conv}} A_s (T_\infty - T_s) = (1.86 \text{ W/m}^2 \cdot \text{°C})[\pi(0.15 \text{ m})^2](20 - 15) \text{°C} = \mathbf{0.66 \text{ W}} \quad (\text{to water})$$

(b) Utilizing the analogy between heat and mass convection, the mass transfer coefficient is determined the same way by replacing Pr by Sc. The Schmidt number is determined from its definition to be

$$\text{Sc} = \frac{\nu}{D_{AB}} = \frac{1.493 \times 10^{-5} \text{ m}^2/\text{s}}{2.37 \times 10^{-5} \text{ m}^2/\text{s}} = 0.630$$

Therefore, the Sherwood number in this case is determined from Table 14-13 to be

$$\text{Sh} = 0.27(\text{GrSc})^{1/4} = 0.27(2.53 \times 10^5 \times 0.629)^{1/4} = 5.39$$

Using the definition of Sherwood number, the mass transfer coefficient is determined to be

$$h_{\text{mass}} = \frac{\text{Sh}D_{AB}}{L} = \frac{(5.39)(2.37 \times 10^{-5} \text{ m}^2/\text{s})}{0.075 \text{ m}} = 0.00170 \text{ m/s}$$

Then the evaporation rate and the rate of heat transfer by evaporation become

$$\begin{aligned} \dot{m}_v &= h_{\text{mass}} A_s (\rho_{v,s} - \rho_{v,\infty}) = (0.00170 \text{ m/s})[\pi(0.15 \text{ m})^2](0.01283 - 0.00519) \text{ kg/m}^3 \\ &= 9.18 \times 10^{-7} \text{ kg/s} = \mathbf{0.0033 \text{ kg/h}} \end{aligned}$$

and

$$\dot{Q}_{\text{evap}} = \dot{m}_v h_{fg} = (9.17 \times 10^{-7} \text{ kg/s})(2466 \text{ kJ/kg}) = 0.00226 \text{ kW} = 2.26 \text{ W}$$

(c) The net rate of heat transfer to the water needed to maintain its temperature constant at 15°C is

$$\dot{Q}_{\text{net}} = \dot{Q}_{\text{evap}} + \dot{Q}_{\text{conv}} = 2.26 + (-0.66) = \mathbf{1.6 \text{ W}}$$

Discussion Note that if no heat is supplied to the water (by a resistance heater, for example), the temperature of the water in the pan would drop until the heat gain by convection equals the heat loss by evaporation.

14-139 Air is blown over a circular pan filled with water. The rate of evaporation of water, the rate of heat transfer by convection, and the rate of energy supply to the water to maintain its temperature constant are to be determined.

Assumptions 1 The low mass flux model and thus the analogy between heat and mass transfer is applicable since the mass fraction of vapor in the air is low (about 2 percent for saturated air at 15°C). **2** The critical Reynolds number for flow over a flat plate is 500,000. **3** Radiation heat transfer is negligible. **4** Both air and water vapor are ideal gases.

Properties The air-water vapor mixture is assumed to be dilute, and thus we can use dry air properties for the mixture at the average temperature of $(T_\infty + T_s)/2 = (15+20)/2 = 17.5^\circ\text{C} = 290.5\text{ K}$. The properties of dry air at 17.5°C and 1 atm are, from Table A-15,

$$k = 0.02496\text{ W/m}\cdot^\circ\text{C}, \quad \text{Pr} = 0.7316$$

$$\alpha = 2.042 \times 10^{-5}\text{ m}^2/\text{s} \quad \nu = 1.493 \times 10^{-5}\text{ m}^2/\text{s}$$

The mass diffusivity of water vapor in air at the average temperature of 290.5 K is, from Eq. 14-15,

$$\begin{aligned} D_{AB} = D_{\text{H}_2\text{O-air}} &= 1.87 \times 10^{-10} \frac{T^{2.072}}{P} \\ &= 1.87 \times 10^{-10} \frac{(290.5\text{ K})^{2.072}}{1\text{ atm}} = 2.37 \times 10^{-5}\text{ m}^2/\text{s} \end{aligned}$$

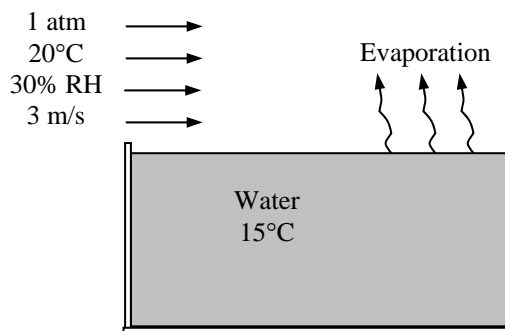

The saturation pressure of water at 20°C is $P_{\text{sat}@20^\circ\text{C}} = 2.339\text{ kPa}$. Properties of water at 15°C are

$h_{fg} = 2466\text{ kJ/kg}$ and $P_v = 1.7051\text{ kPa}$ (Table A-9). Also, the gas constants of water is $R_{\text{water}} = 0.4615\text{ kPa}\cdot\text{m}^3/\text{kg}\cdot\text{K}$ (Table A-1).

Analysis (a) Taking the radius of the pan $r_0 = 0.15\text{ m}$ to be the characteristic length, the Reynolds number for flow over the pan is

$$\text{Re} = \frac{VL}{\nu} = \frac{(3\text{ m/s})(0.15\text{ m})}{1.493 \times 10^{-5}\text{ m}^2/\text{s}} = 30,141$$

which is less than 500,000, and thus the flow is laminar over the entire surface. The Nusselt number and the heat transfer coefficient are

$$\text{Nu} = 0.664 \text{Re}_L^{0.5} \text{Pr}^{1/3} = 0.664(30,141)^{0.5} (0.7316)^{1/3} = 103.9$$

$$h_{\text{heat}} = \frac{\text{Nu}k}{L} = \frac{(103.9)(0.02496\text{ W/m}\cdot^\circ\text{C})}{0.15\text{ m}} = 17.3\text{ W/m}^2\cdot^\circ\text{C}$$

Then the rate of heat transfer from the air to the water by forced convection becomes

$$\dot{Q}_{\text{conv}} = h_{\text{conv}} A_s (T_\infty - T_s) = (17.3\text{ W/m}^2\cdot^\circ\text{C}) [\pi(0.15\text{ m})^2] (20 - 15)^\circ\text{C} = \mathbf{6.1\text{ W}} \quad (\text{to water})$$

(b) Utilizing the analogy between heat and mass convection, the mass transfer coefficient is determined the same way by replacing Pr by Sc. The Schmidt number is determined from its definition to be

$$\text{Sc} = \frac{\nu}{D_{AB}} = \frac{1.493 \times 10^{-5}\text{ m}^2/\text{s}}{2.37 \times 10^{-5}\text{ m}^2/\text{s}} = 0.630$$

Therefore, the Sherwood number in this case is determined from Table 14-13 to be

$$\text{Sh} = 0.664 \text{Re}_L^{0.5} \text{Sc}^{1/3} = 0.664(30,141)^{0.5} (0.630)^{1/3} = 98.8$$

Using the definition of Sherwood number, the mass transfer coefficient is determined to be

$$h_{\text{mass}} = \frac{\text{Sh}D_{AB}}{L} = \frac{(98.8)(2.37 \times 10^{-5}\text{ m}^2/\text{s})}{0.15\text{ m}} = 0.0156\text{ m/s}$$

The air at the water surface is saturated, and thus the vapor pressure at the surface is simply the saturation pressure of water at the surface temperature (1.7051 kPa at 15°C). The vapor pressure of air far from the water surface is determined from

$$P_{v,\infty} = \phi P_{\text{sat}@T_\infty} = (0.30)P_{\text{sat}@20^\circ\text{C}} = (0.30)(2.339 \text{ kPa}) = 0.7017 \text{ kPa}$$

Treating the water vapor and the air as ideal gases, the vapor densities at the water-air interface and far from the surface are determined to be

$$\text{At the surface:} \quad \rho_{v,s} = \frac{P_{v,s}}{R_v T_s} = \frac{1.7051 \text{ kPa}}{(0.4615 \text{ kPa} \cdot \text{m}^3/\text{kg} \cdot \text{K})(15 + 273) \text{ K}} = 0.01283 \text{ kg/m}^3$$

$$\text{Away from the surface:} \quad \rho_{v,\infty} = \frac{P_{v,\infty}}{R_v T_\infty} = \frac{0.7017 \text{ kPa}}{(0.4615 \text{ kPa} \cdot \text{m}^3/\text{kg} \cdot \text{K})(20 + 273) \text{ K}} = 0.00519 \text{ kg/m}^3$$

Then the evaporation rate and the rate of heat transfer by evaporation become

$$\begin{aligned} \dot{m}_v &= h_{\text{mass}} A_s (\rho_{v,s} - \rho_{v,\infty}) = (0.0156 \text{ m/s})[\pi(0.15 \text{ m})^2](0.01283 - 0.00519) \text{ kg/m}^3 \\ &= 8.42 \times 10^{-6} \text{ kg/s} = \mathbf{0.0303 \text{ kg/h}} \end{aligned}$$

and

$$\dot{Q}_{\text{evap}} = \dot{m}_v h_{fg} = (8.42 \times 10^{-6} \text{ kg/s})(2466 \text{ kJ/kg}) = 0.0208 \text{ kW} = 20.8 \text{ W}$$

(c) The net rate of heat transfer to the water needed to maintain its temperature constant at 15°C is

$$\dot{Q}_{\text{net}} = \dot{Q}_{\text{evap}} + \dot{Q}_{\text{conv}} = 20.8 + (-6.1) = \mathbf{14.7 \text{ W}}$$

Discussion Note that if no heat is supplied to the water (by a resistance heater, for example), the temperature of the water in the pan would drop until the heat gain by convection equals the heat loss by evaporation.

Also, the rate of evaporation could be determined almost as accurately using mass fractions of vapor instead of vapor fractions and the average air density from the relation $\dot{m}_{\text{evap}} = h_{\text{mass}} \rho A (w_{A,s} - w_{A,\infty})$.

14-140 A spherical naphthalene ball is hanged in a closet. The time it takes for the naphthalene to sublimate completely is to be determined.

Assumptions 1 The concentration of naphthalene in the air is very small, and the low mass flux conditions exist so that the Chilton-Colburn analogy between heat and mass transfer is applicable (will be verified). **2** Both air and naphthalene vapor are ideal gases. **3** The naphthalene and the surrounding air are at the same temperature. **4** The radiation effects are negligible.

Properties The molar mass of naphthalene is 128.2 kg/kmol. Because of low mass flux conditions, we can use dry air properties for the mixture at the specified temperature of 25°C and 1 atm, at which $\rho = 1.184 \text{ kg/m}^3$, $c_p = 1007 \text{ J/kg} \cdot \text{K}$, and $\alpha = 2.141 \times 10^{-5} \text{ m}^2/\text{s}$ (Table A-15).

Analysis The incoming air is free of naphthalene, and thus the mass fraction of naphthalene at free stream conditions is zero, $w_{A,\infty} = 0$. Noting that the vapor pressure of naphthalene at the surface is 11 Pa, the mass fraction of naphthalene on the air side of the surface is

$$w_{A,s} = \frac{P_{A,s}}{P} \left(\frac{M_A}{M_{\text{air}}} \right) = \frac{11 \text{ Pa}}{101,325 \text{ Pa}} \left(\frac{128.2 \text{ kg/kmol}}{29 \text{ kg/kmol}} \right) = 4.8 \times 10^{-4}$$

Normally we would expect natural convection currents to develop around the naphthalene ball because the amount of naphthalene near the surface is much larger, and determine the Nusselt number (and its counterpart in mass transfer, the Sherwood number) from Eq. 14-16,

$$\text{Nu} = 2 + \frac{0.589 \text{ Ra}^{1/4}}{[1 + (0.469/\text{Pr})^{9/16}]^{4/9}}$$

But the mass fraction value determined above indicates that the amount of naphthalene in the air is so low that it will not cause any significant difference in the density of air. With no density gradient, there will be no natural convection and thus the Rayleigh number can be taken to be zero. Then the Nusselt number relation above will reduce to $\text{Nu} = 2$ or its equivalent $\text{Sh} = 2$. Then using the definition of Sherwood number, the mass transfer coefficient can be expressed as

$$h_{\text{mass}} = \frac{\text{Sh} D_{AB}}{D} = \frac{2 D_{AB}}{D}$$

The mass of naphthalene ball can be expressed as $m = \rho_{\text{naph}} V = \frac{1}{6} \rho_{\text{naph}} (\pi D^3)$. The rate of change of the mass of naphthalene is equal to the rate of mass transfer from naphthalene to the air, and is expressed as

$$\begin{aligned} \frac{dm}{dt} &= -h_{\text{mass}} \rho_{\text{air}} A (w_{A,s} - w_{A,\infty}) \\ \frac{d}{dt} \left(\frac{1}{6} \rho_{\text{naph}} (\pi D^3) \right) &= -\frac{2 D_{AB}}{D} \rho_{\text{air}} (\pi D^2) (w_{A,s} - w_{A,\infty}) \\ \frac{3}{6} \pi \rho_{\text{naph}} D^2 \frac{dD}{dt} &= -2 D_{AB} (\pi D) \rho_{\text{air}} (w_{A,s} - w_{A,\infty}) \end{aligned}$$

Simplifying and rearranging,
$$D dD = -\frac{4 \rho_{\text{air}} D_{AB}}{\rho_{\text{naph}}} (w_{A,s} - w_{A,\infty}) dt$$

Integrating from $D = D_i = 0.03 \text{ m}$ at time $t = 0$ to $D = 0$ (complete sublimation) at time $t = t$ gives

$$t = \frac{\rho_{\text{naph}} D_i^2}{8 \rho_{\text{air}} D_{AB} (w_{A,s} - w_{A,\infty})}$$

Substituting, the time it takes for the naphthalene to sublimate completely is determined to be

$$t = \frac{\rho_{\text{naph}} D_i^2}{8 \rho_{\text{air}} D_{AB} (w_{A,s} - w_{A,\infty})} = \frac{(1100 \text{ kg/m}^3)(0.015 \text{ m})^2}{8(1.184 \text{ kg/m}^3)(0.61 \times 10^{-5})(4.80 \times 10^{-4} - 0) \text{ m}^2/\text{s}} = 8.92 \times 10^6 \text{ s} = \mathbf{103 \text{ days}}$$

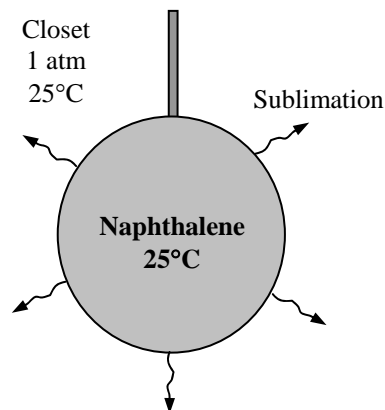

14-141E A swimmer extends his wet arms into the windy air outside. The rate at which water evaporates from both arms and the corresponding rate of heat transfer by evaporation are to be determined.

Assumptions **1** The low mass flux model and thus the analogy between heat and mass transfer is applicable since the mass fraction of vapor in the air is low (about 2 percent for saturated air at 60°F). **2** The arm can be modeled as a long cylinder.

Properties Because of low mass flux conditions, we can use dry air properties for the mixture at the average temperature of $(40 + 80)/2 = 60^\circ\text{F}$ and 1 atm, for which $\nu = 1.588 \times 10^{-4} \text{ ft}^2/\text{s}$, and $\rho = 0.07633 \text{ lbm}/\text{ft}^3$ (Table A-15E). The saturation pressure of water at 40°F is 0.1217 psia. Also, at 80°F, the saturation pressure is 0.5073 psia and the heat of vaporization is 1048 Btu/lbm (Table A-9E). The molar mass of water is $R = 0.5957 \text{ psia}\cdot\text{ft}^3/\text{lbm}\cdot\text{R}$ (Table A-1E). The mass diffusivity of water vapor in air at 60°F = 520 R = 288.9 K is determined from Eq. 14-15 to be

$$D_{AB} = D_{\text{H}_2\text{O-air}} = 1.87 \times 10^{-10} \frac{T^{2.072}}{P} = 1.87 \times 10^{-10} \frac{(288.9 \text{ K})^{2.072}}{1 \text{ atm}} = 2.35 \times 10^{-5} \text{ m}^2/\text{s} = 2.53 \times 10^{-4} \text{ ft}^2/\text{s}$$

Analysis The Reynolds number for flow over a cylinder is

$$\text{Re} = \frac{VD}{\nu} = \frac{(20 \times 5280 / 3600 \text{ ft/s})(3/12 \text{ ft})}{1.588 \times 10^{-4} \text{ ft}^2/\text{s}} = 46,180$$

The Schmidt number in this case is

$$\text{Sc} = \frac{\nu}{D_{AB}} = \frac{1.588 \times 10^{-4} \text{ ft}^2/\text{s}}{2.53 \times 10^{-4} \text{ ft}^2/\text{s}} = 0.628$$

Then utilizing the analogy between heat and mass convection, the Sherwood number is determined from Eq. 10-32 by replacing Pr number by the Schmidt number to be

$$\text{Sh} = 0.3 + \frac{0.62 \text{Re}^{0.5} \text{Sc}^{1/3}}{\left[1 + (0.4/\text{Sc})^{2/3}\right]^{1/4}} \left[1 + \left(\frac{\text{Re}}{282,000}\right)^{5/8}\right]^{4/5} = 0.3 + \frac{0.62(46,180)^{0.5}(0.628)^{1/3}}{\left[1 + (0.4/0.628)^{2/3}\right]^{1/4}} \left[1 + \left(\frac{46,180}{282,000}\right)^{5/8}\right]^{4/5} = 125$$

Using the definition of Sherwood number, the mass transfer coefficient is determined to be

$$h_{\text{mass}} = \frac{\text{Sh}D_{AB}}{D} = \frac{(125)(2.53 \times 10^{-4} \text{ ft}^2/\text{s})}{3/12 \text{ ft}} = 0.1265 \text{ ft/s}$$

The air at the water surface is saturated, and thus the vapor pressure at the surface is simply the saturation pressure of water at the surface temperature (0.5073 psia at 80°F). The vapor pressure of air far from the water surface is determined from

$$P_{v,\infty} = \phi P_{\text{sat}@T_\infty} = (0.50)P_{\text{sat}@40^\circ\text{F}} = (0.50)(0.1217 \text{ psia}) = 0.0609 \text{ psia}$$

Treating the water vapor as an ideal gas, the vapor densities at the water-air interface and far from the surface are determined to be

$$\text{At the surface: } \rho_{v,s} = \frac{P_{v,s}}{R_v T_s} = \frac{0.5073 \text{ psia}}{(0.5957 \text{ psia}\cdot\text{ft}^3/\text{lbm}\cdot\text{R})(80 + 460) \text{ R}} = 0.00158 \text{ lbm}/\text{ft}^3$$

$$\text{Away from the surface: } \rho_{v,\infty} = \frac{P_{v,\infty}}{R_v T_\infty} = \frac{0.0609 \text{ psia}}{(0.5957 \text{ psia}\cdot\text{ft}^3/\text{lbm}\cdot\text{R})(40 + 460) \text{ R}} = 0.000204 \text{ lbm}/\text{ft}^3$$

Then the evaporation rate and the rate of heat transfer by evaporation become

$$\begin{aligned} \dot{m}_v &= h_{\text{mass}} A_s (\rho_{v,s} - \rho_{v,\infty}) = (0.1265 \text{ ft/s})[2 \times \pi(3/12 \text{ ft})(2 \text{ ft})](0.00158 - 0.000204) \text{ lbm}/\text{ft}^3 \\ &= 5.47 \times 10^{-4} \text{ lbm/s} = \mathbf{1.97 \text{ lbm/h}} \end{aligned}$$

$$\text{and } \dot{Q}_{\text{evap}} = \dot{m}_v h_{fg} = (5.47 \times 10^{-4} \text{ lbm/s})(1048 \text{ Btu/lbm}) = \mathbf{0.573 \text{ Btu/s}}$$

Discussion The rate of evaporation could be determined almost as accurately using mass fractions of vapor instead of vapor fractions and the average air density from the relation $\dot{m}_{\text{evap}} = h_{\text{mass}} \rho A (w_{A,s} - w_{A,\infty})$.

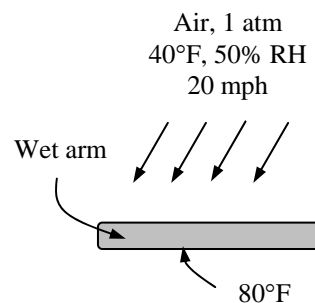

14-142 A nickel part is put into a room filled with hydrogen. The ratio of hydrogen concentrations at the surface of the part and at a depth of 2-mm from the surface after 24 h is to be determined.

Assumptions 1 Hydrogen penetrates into a thin layer beneath the surface of the nickel component, and thus the component can be modeled as a semi-infinite medium regardless of its thickness or shape. 2 The initial hydrogen concentration in the nickel part is zero.

Properties The molar mass of hydrogen H_2 is $M = 2$ kg/kmol (Table A-1). The solubility of hydrogen in nickel at 358 K ($=85^\circ\text{C}$) is 0.00901 kmol/ $\text{m}^3\cdot\text{bar}$ (Table 14-7). The mass diffusivity of hydrogen in nickel at 358 K is $D_{AB} = 1.2 \times 10^{-12}$ m^2/s (Table 14-3b). Also, 1 atm = 1.01325 bar.

Analysis This problem is analogous to the one-dimensional transient heat conduction problem in a semi-infinite medium with specified surface temperature, and thus can be solved accordingly. Using mass fraction for concentration since the data is given in that form, the solution can be expressed as

$$\frac{w_A(x,t) - w_{A,i}}{w_{A,s} - w_{A,i}} = \text{erfc}\left(\frac{x}{2\sqrt{D_{AB}t}}\right)$$

The molar density of hydrogen in the nickel at the interface is determined from Eq. 14-20 to be

$$\begin{aligned} C_{H_2, \text{solid side}}(0) &= S \times P_{H_2, \text{gas side}} \\ &= (0.00901 \text{ kmol}/\text{m}^3 \cdot \text{bar})(3 \times 1.01325 \text{ bar}) \\ &= 0.0274 \text{ kmol}/\text{m}^3 \end{aligned}$$

The argument of the complementary error function is

$$\xi = \frac{x}{2\sqrt{D_{AB}t}} = \frac{2 \times 10^{-3} \text{ m}}{2\sqrt{(1.2 \times 10^{-12} \text{ m}^2/\text{s})(24 \times 3600 \text{ s})}} = 3.106$$

The corresponding value of the complementary error function is determined from Table 4-4 to be

$$\text{erfc}\left(\frac{x}{2\sqrt{D_{AB}t}}\right) = \text{erfc}(3.105) = 0.000015$$

Substituting the known quantities,

$$\frac{C_A(x,t) - 0}{0.0274 - 0} = 0.000015 \rightarrow C_A(x,t) = 4.1 \times 10^{-7} \text{ kmol}/\text{m}^3$$

Therefore, the hydrogen concentration in the steel component at a depth of 2 mm in 24 h is very small.

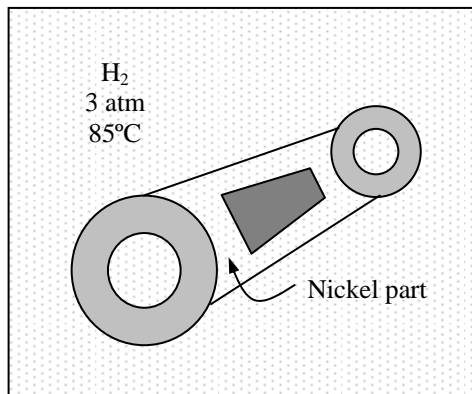

14-143 A 0.1-mm thick soft rubber membrane separates pure O₂ from air. The mass flow rate of O₂ through the membrane per unit area and the direction of flow are to be determined.

Assumptions 1 Steady operating conditions exist. 2 Mass transfer through the membrane is one-dimensional. 3 The permeability of the membrane is constant.

Properties The mass diffusivity of oxygen in rubber at 298 K is $D_{AB} = 2.1 \times 10^{-10} \text{ m}^2/\text{s}$ (Table 14-3b). The solubility of oxygen in rubber at 298 K is $0.00312 \text{ kmol}/\text{m}^3 \cdot \text{bar}$ (Table 14-7). The molar mass of oxygen is $32 \text{ kg}/\text{kmol}$ (Table A-1).

Analysis The molar fraction of oxygen in air is 0.21. Therefore, the partial pressure of oxygen in the air is

$$y_{\text{O}_2} = \frac{P_{\text{O}_2,2}}{P} \rightarrow P_{\text{O}_2,2} = y_{\text{O}_2} P = 0.21 \times (3 \text{ atm}) = 0.63 \text{ atm}$$

The partial pressure of oxygen on the other side is simply $P_{\text{O}_2,1} = 1 \text{ atm}$. Then the molar flow rate of oxygen through the membrane by diffusion can readily be determined to be

$$\begin{aligned} \dot{N}_{\text{diff,A,wall}} &= D_{AB} S \frac{P_{A,1} - P_{A,2}}{L} \\ &= (2.1 \times 10^{-10} \text{ m}^2/\text{s}) (0.00312 \text{ kmol}/\text{m}^3 \cdot \text{bar}) \frac{(1 - 0.63) \text{ atm}}{0.1 \times 10^{-3} \text{ m}} \left(\frac{1.01325 \text{ bar}}{1 \text{ atm}} \right) \\ &= 2.46 \times 10^{-9} \text{ kmol}/\text{m}^2 \cdot \text{s} \end{aligned}$$

Then the mass flow rate of oxygen gas through the membrane becomes

$$\dot{m}_{\text{diff}} = M \dot{N}_{\text{diff}} = (32 \text{ kg}/\text{kmol}) (2.46 \times 10^{-9} \text{ kmol}/\text{m}^2 \cdot \text{s}) = \mathbf{7.87 \times 10^{-8} \text{ kg}/\text{m}^2 \cdot \text{s}}$$

The direction of the flow will be from the pure oxygen inside to the air outside since the partial pressure of oxygen is higher inside.

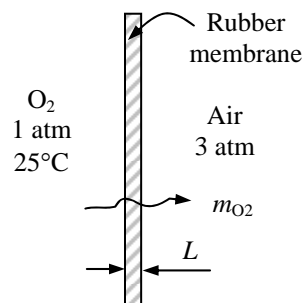

14-144E The top section of a solar pond is maintained at a constant temperature. The rates of heat loss from the top surface of the pond by radiation, natural convection, and evaporation are to be determined.

Assumptions 1 The low mass flux conditions exist so that the Chilton-Colburn analogy between heat and mass transfer is applicable since the mass fraction of vapor in the air is low (about 2 percent for saturated air at 80°F). 2 Both air and water vapor at specified conditions are ideal gases (the error involved in this assumption is less than 1 percent). 3 The water in the pool is maintained at a uniform temperature of 80°F. 4 The critical Reynolds number for flow over a flat surface is 500,000.

Properties The air-water vapor mixture is assumed to be dilute, and thus we can use dry air properties for the mixture at the average temperature of $(T_\infty + T_s)/2 = (70+80)/2 = 75^\circ\text{F}$. The properties of dry air at 75°F and 1 atm are, from Table A-15E,

$$k = 0.01469 \text{ Btu/h} \cdot \text{ft} \cdot ^\circ\text{F}$$

$$\text{Pr} = 0.7298$$

$$\alpha = 2.288 \times 10^{-4} \text{ ft}^2/\text{s}$$

$$\nu = 0.167 \times 10^{-3} \text{ ft}^2/\text{s}$$

The saturation pressure of water at 70°F is

$$P_{\text{sat}@70^\circ\text{F}} = 0.3632 \text{ psia. Properties of}$$

water at 80°F are $h_{fg} = 1048 \text{ Btu/lbm}$ and

$$P_v = 0.5073 \text{ psia (Table A-9). The gas}$$

constant of water is $R_{\text{water}} = 0.5957$

$\text{psia} \cdot \text{ft}^3/\text{lbm} \cdot \text{R}$ (Table A-1E). The

emissivity of water is 0.95 (Table A-18).

The mass diffusivity of water vapor in air

at the average temperature of 75°F = 535

$\text{R} = 297.2 \text{ K}$ is determined from Eq. 14-15

to be

$$D_{AB} = D_{\text{H}_2\text{O-air}} = 1.87 \times 10^{-10} \frac{T^{2.072}}{P} = 1.87 \times 10^{-10} \frac{(297.2 \text{ K})^{2.072}}{1 \text{ atm}} = 2.49 \times 10^{-5} \text{ m}^2/\text{s} = 2.68 \times 10^{-4} \text{ ft}^2/\text{s}$$

Analysis (a) The pond surface can be treated as a flat surface. The Reynolds number for flow over a flat surface is

$$\text{Re} = \frac{VL}{\nu} = \frac{(40 \times 5280 / 3600 \text{ ft/s})(100 \text{ ft})}{0.167 \times 10^{-3} \text{ ft}^2/\text{s}} = 3.51 \times 10^7$$

which is much larger than the critical Reynolds number of 500,000. Therefore, the air flow over the pond surface is turbulent, and the Nusselt number and the heat transfer coefficient are determined to be

$$\text{Nu} = 0.037 \text{Re}_L^{0.8} \text{Pr}^{1/3} = 0.037(3.51 \times 10^7)^{0.8} (0.7298)^{1/3} = 36,212$$

$$h_{\text{heat}} = \frac{\text{Nu}k}{L} = \frac{(36,212)(0.01469 \text{ Btu/h} \cdot \text{ft} \cdot ^\circ\text{F})}{100 \text{ ft}} = 5.32 \text{ Btu/h} \cdot \text{ft}^2 \cdot ^\circ\text{F}$$

Then the rate of heat transfer from the air to the water by forced convection becomes

$$\dot{Q}_{\text{conv}} = h_{\text{conv}} A_s (T_\infty - T_s) = (5.32 \text{ Btu/h} \cdot \text{ft}^2 \cdot ^\circ\text{F})(10,000 \text{ ft}^2)(80 - 70)^\circ\text{F} = \mathbf{532,000 \text{ Btu/h}} \quad (\text{to water})$$

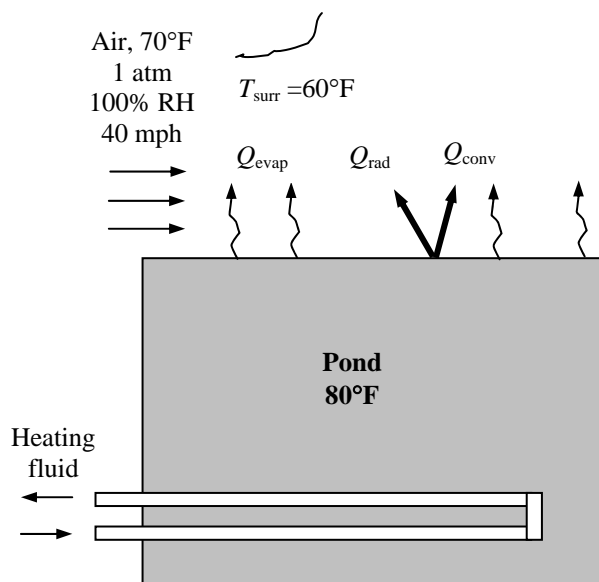

(b) Noting that the emissivity of water is 0.95 and the surface area of the pool is

$A_s = (100\text{ ft})(100\text{ ft}) = 10,000\text{ ft}^2$, heat transfer from the top surface of the pool by radiation is

$$\dot{Q}_{\text{rad}} = \varepsilon A_s \sigma (T_s^4 - T_{\text{sur}}^4) = (0.95)(10,000\text{ ft}^2)(0.1714 \times 10^{-8}\text{ Btu/h} \cdot \text{ft}^2 \cdot \text{R}^4)[(540\text{ R})^4 - (520\text{ R})^4] = \mathbf{194,000\text{ Btu/h}}$$

(c) Utilizing the analogy between heat and mass convection, the mass transfer coefficient is determined the same way by replacing Pr by Sc. The Schmidt number is determined from its definition to be

$$\text{Sc} = \frac{\nu}{D_{AB}} = \frac{0.167 \times 10^{-3}\text{ ft}^2/\text{s}}{2.68 \times 10^{-4}\text{ ft}^2/\text{s}} = 0.623$$

Then utilizing the analogy between heat and mass convection, the Sherwood number is determined by replacing Pr number by the Schmidt number to be

$$\text{Sh} = 0.037 \text{Re}_L^{0.8} \text{Sc}^{1/3} = 0.037(3.51 \times 10^7)^{0.8} (0.623)^{1/3} = 34,350$$

Using the definition of Sherwood number, the mass transfer coefficient is determined to be

$$h_{\text{mass}} = \frac{\text{Sh}D_{AB}}{D} = \frac{(34,350)(2.68 \times 10^{-4}\text{ ft}^2/\text{s})}{100\text{ ft}} = 0.0921\text{ ft/s}$$

The air at the water surface is saturated, and thus the vapor pressure at the surface is simply the saturation pressure of water at the surface temperature ($P_{v,s} = 0.5073\text{ psia}$ at 80°F). The humidity of air is given to be 100%, and thus the air far from the water surface is also saturated. Therefore,

$$P_{v,\infty} = P_{\text{sat}@70^\circ\text{F}} = 0.3632\text{ psia}.$$

Treating the water vapor as an ideal gas, the vapor densities at the water-air interface and far from the surface are determined to be

$$\text{At the surface:} \quad \rho_{v,s} = \frac{P_{v,s}}{R_v T_s} = \frac{0.5073\text{ psia}}{(0.5957\text{ psia} \cdot \text{ft}^3/\text{lbm} \cdot \text{R})(80 + 460)\text{ R}} = 0.00158\text{ lbm/ft}^3$$

$$\text{Away from the surface:} \quad \rho_{v,\infty} = \frac{P_{v,\infty}}{R_v T_\infty} = \frac{0.3632\text{ psia}}{(0.5957\text{ psia} \cdot \text{ft}^3/\text{lbm} \cdot \text{R})(70 + 460)\text{ R}} = 0.00115\text{ lbm/ft}^3$$

Then the evaporation rate and the rate of heat transfer by evaporation become

$$\begin{aligned} \dot{m}_v &= h_{\text{mass}} A_s (\rho_{v,s} - \rho_{v,\infty}) = (0.0921\text{ ft/s})(10,000\text{ ft}^2)(0.00158 - 0.00115)\text{ lbm/ft}^3 \\ &= 0.396\text{ lbm/s} = \mathbf{1426\text{ lbm/h}} \end{aligned}$$

and

$$\dot{Q}_{\text{evap}} = \dot{m}_v h_{fg} = (1426\text{ lbm/h})(1048\text{ Btu/lbm}) = \mathbf{1,494,000\text{ Btu/h}}$$

Discussion All of the quantities calculated above represent heat loss for the pond, and the total rate of heat loss from the open top surface of the pond to the surrounding air and surfaces is

$$\dot{Q}_{\text{total, top}} = \dot{Q}_{\text{rad}} + \dot{Q}_{\text{conv}} + \dot{Q}_{\text{evap}} = 194,000 + 532,000 + 1,494,000 = 2,220,000\text{ Btu/h}$$

This heat loss will come from the deeper parts of the pond, and thus the pond will start cooling unless it gains heat from the sun or another heat source. Note that the evaporative heat losses dominate. Also, the rate of evaporation could be determined almost as accurately using mass fractions of vapor instead of vapor fractions and the average air density from the relation $\dot{m}_{\text{evap}} = h_{\text{mass}} \rho A_s (w_{A,s} - w_{A,\infty})$.

14-145E The top section of a solar pond is maintained at a constant temperature. The rates of heat loss from the top surface of the pond by radiation, natural convection, and evaporation are to be determined.

Assumptions 1 The low mass flux conditions exist so that the Chilton-Colburn analogy between heat and mass transfer is applicable since the mass fraction of vapor in the air is low (about 2 percent for saturated air at 90°F). **2** Both air and water vapor at specified conditions are ideal gases (the error involved in this assumption is less than 1 percent). **3** The water in the pool is maintained at a uniform temperature of 90°F. **4** The critical Reynolds number for flow over a flat surface is 500,000.

Properties The air-water vapor mixture is assumed to be dilute, and thus we can use dry air properties for the mixture at the average temperature of $(T_\infty + T_s)/2 = (70+90)/2 = 80^\circ\text{F}$. The properties of dry air at 80°F and 1 atm are, from Table A-15E,

$$k = 0.01481 \text{ Btu/h} \cdot \text{ft} \cdot ^\circ\text{F}$$

$$\text{Pr} = 0.7290$$

$$\alpha = 2.328 \times 10^{-4} \text{ ft}^2/\text{h}$$

$$\nu = 1.697 \times 10^{-4} \text{ ft}^2/\text{s}$$

The saturation pressure of water at 70°F is

$$P_{\text{sat}@70^\circ\text{F}} = 0.3632 \text{ psia. Properties of water at}$$

90°F are $h_{fg} = 1043 \text{ Btu/lbm}$ and

$P_v = 0.6988 \text{ psia}$ (Table A-9). The gas

constant of water is $R_{\text{water}} = 0.5957$

$\text{psia} \cdot \text{ft}^3/\text{lbm} \cdot \text{R}$ (Table A-1E). The emissivity of

water is 0.95 (Table A-18). The mass

diffusivity of water vapor in air at the average

temperature of 80°F = 540 R = 300 K is

determined from Eq. 14-15 to be

$$D_{AB} = D_{\text{H}_2\text{O-air}} = 1.87 \times 10^{-10} \frac{T^{2.072}}{P} = 1.87 \times 10^{-10} \frac{(300\text{K})^{2.072}}{1 \text{ atm}} = 2.54 \times 10^{-5} \text{ m}^2/\text{s} = 2.73 \times 10^{-4} \text{ ft}^2/\text{s}$$

Analysis (a) The pond surface can be treated as a flat surface. The Reynolds number for flow over a flat surface is

$$\text{Re} = \frac{VL}{\nu} = \frac{(40 \times 5280 / 3600 \text{ ft/s})(100 \text{ ft})}{1.697 \times 10^{-4} \text{ ft}^2/\text{s}} = 3.46 \times 10^7$$

which is much larger than the critical Reynolds number of 500,000. Therefore, the air flow over the pond surface is turbulent, and the Nusselt number and the heat transfer coefficient are determined to be

$$\text{Nu} = 0.037 \text{Re}_L^{0.8} \text{Pr}^{1/3} = 0.037(3.46 \times 10^7)^{0.8} (0.7290)^{1/3} = 35,785$$

$$h_{\text{heat}} = \frac{\text{Nu}k}{L} = \frac{(35,785)(0.01481 \text{ Btu/h} \cdot \text{ft} \cdot ^\circ\text{F})}{100 \text{ ft}} = 5.30 \text{ Btu/h} \cdot \text{ft}^2 \cdot ^\circ\text{F}$$

Then the rate of heat transfer from the air to the water by forced convection becomes

$$\dot{Q}_{\text{conv}} = h_{\text{conv}} A_s (T_\infty - T_s) = (5.30 \text{ Btu/h} \cdot \text{ft}^2 \cdot ^\circ\text{F})(10,000 \text{ ft}^2)(90 - 70)^\circ\text{F} = \mathbf{1,060,000 \text{ Btu/h}} \quad (\text{to water})$$

(b) Noting that the emissivity of water is 0.95 and the surface area of the pool is

$A_s = (100 \text{ ft})(100 \text{ ft}) = 10,000 \text{ ft}^2$, heat transfer from the top surface of the pool by radiation is

$$\dot{Q}_{\text{rad}} = \varepsilon A_s \sigma (T_s^4 - T_{\text{surr}}^4) = (0.95)(10,000 \text{ ft}^2)(0.1714 \times 10^{-8} \text{ Btu/h} \cdot \text{ft}^2 \cdot \text{R}^4)[(550 \text{ R})^4 - (520 \text{ R})^4] = \mathbf{299,400 \text{ Btu/h}}$$

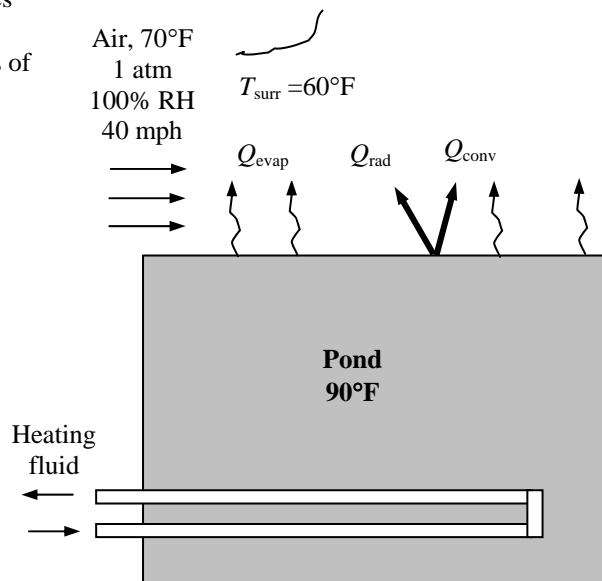

(c) Utilizing the analogy between heat and mass convection, the mass transfer coefficient is determined the same way by replacing Pr by Sc. The Schmidt number is determined from its definition to be

$$Sc = \frac{\nu}{D_{AB}} = \frac{1.697 \times 10^{-4} \text{ ft}^2/\text{s}}{2.73 \times 10^{-4} \text{ ft}^2/\text{s}} = 0.622$$

Then utilizing the analogy between heat and mass convection, the Sherwood number is determined by replacing Pr number by the Schmidt number to be

$$Sh = 0.037 Re_L^{0.8} Sc^{1/3} = 0.037(3.46 \times 10^7)^{0.8} (0.622)^{1/3} = 33,940$$

Using the definition of Sherwood number, the mass transfer coefficient is determined to be

$$h_{\text{mass}} = \frac{Sh D_{AB}}{D} = \frac{(33,940)(2.73 \times 10^{-4} \text{ ft}^2/\text{s})}{100 \text{ ft}} = 0.0927 \text{ ft/s}$$

The air at the water surface is saturated, and thus the vapor pressure at the surface is simply the saturation pressure of water at the surface temperature ($P_{v,s} = 0.6988$ psia at 90°F). The humidity of air is given to be 100%, and thus the air far from the water surface is also saturated. Therefore,

$$P_{v,\infty} = P_{\text{sat}@70^\circ\text{F}} = 0.3632 \text{ psia.}$$

Treating the water vapor as an ideal gas, the vapor densities at the water-air interface and far from the surface are determined to be

$$\text{At the surface:} \quad \rho_{v,s} = \frac{P_{v,s}}{R_v T_s} = \frac{0.6988 \text{ psia}}{(0.5957 \text{ psia} \cdot \text{ft}^3/\text{lbm} \cdot \text{R})(90 + 460) \text{ R}} = 0.00213 \text{ lbm/ft}^3$$

$$\text{Away from the surface:} \quad \rho_{v,\infty} = \frac{P_{v,\infty}}{R_v T_\infty} = \frac{0.3632 \text{ psia}}{(0.5957 \text{ psia} \cdot \text{ft}^3/\text{lbm} \cdot \text{R})(70 + 460) \text{ R}} = 0.00115 \text{ lbm/ft}^3$$

Then the evaporation rate and the rate of heat transfer by evaporation become

$$\begin{aligned} \dot{m}_v &= h_{\text{mass}} A_s (\rho_{v,s} - \rho_{v,\infty}) = (0.0927 \text{ ft/s})(10,000 \text{ ft}^2)(0.00213 - 0.00115) \text{ lbm/ft}^3 \\ &= 0.908 \text{ lbm/s} = \mathbf{3269 \text{ lbm/h}} \end{aligned}$$

$$\text{and} \quad \dot{Q}_{\text{evap}} = \dot{m}_v h_{fg} = (3269 \text{ lbm/h})(1043 \text{ Btu/lbm}) = \mathbf{3,410,000 \text{ Btu/h}}$$

Discussion All of the quantities calculated above represent heat loss for the pond, and the total rate of heat loss from the open top surface of the pond to the surrounding air and surfaces is

$$\dot{Q}_{\text{total, top}} = \dot{Q}_{\text{rad}} + \dot{Q}_{\text{conv}} + \dot{Q}_{\text{evap}} = 299,400 + 1,060,000 + 3,410,000 = 4,769,400 \text{ Btu/h}$$

This heat loss will come from the deeper parts of the pond, and thus the pond will start cooling unless it gains heat from the sun or another heat source. Note that the evaporative heat losses dominate. Also, the rate of evaporation could be determined almost as accurately using mass fractions of vapor instead of vapor fractions and the average air density from the relation $\dot{m}_{\text{evap}} = h_{\text{mass}} \rho A (w_{A,s} - w_{A,\infty})$.

14-146 Liquid toluene evaporates into air from the open-top of a cylindrical container. The concentration of toluene at a certain location is to be determined.

Properties The molar mass of toluene is 92 kg/kmol. The diffusion coefficient of toluene at 25°C is given to be $D_{AB} = 0.084 \times 10^{-4} \text{ m}^2/\text{s}$.

Analysis The vapor pressure of toluene is

$$P_{A,0} = \frac{10 \text{ mmHg}}{760 \text{ mmHg}} (101,325 \text{ kPa}) = 1333 \text{ Pa}$$

The rate of evaporation can be expressed by

$$\frac{0.060 \text{ kg/day}}{24 \times 3600 \text{ s/day}} = \dot{N}_A \frac{\pi(0.2 \text{ m})^2}{4} (92 \text{ kg/kmol}) \longrightarrow \dot{N}_A = 2.40 \times 10^{-7} \text{ kmol/m}^2 \cdot \text{s}$$

The diffusion coefficient at 6.4°C is determined from

$$D_{AB} = (0.084 \times 10^{-4} \text{ m}^2/\text{s}) \left(\frac{6.4 + 273}{25 + 273} \right)^{1.5} = 7.63 \times 10^{-6} \text{ m}^2/\text{s}$$

The vapor pressure of toluene at 10 mm above the surface is determined from

$$\dot{N}_A = \frac{D_{AB} P}{LR_u T} \ln \left(\frac{P - P_{A,L}}{P - P_{A,0}} \right)$$

$$2.40 \times 10^{-7} \text{ kmol/m}^2 \cdot \text{s} = \frac{(7.63 \times 10^{-6} \text{ m}^2/\text{s})(101,325 \text{ Pa})}{(0.010 \text{ m})(8314 \text{ Pa} \cdot \text{m}^3/\text{kmol} \cdot \text{K})(6.4 + 273 \text{ K})} \ln \left(\frac{101,325 - P_{A,L}}{101,325 - 1333} \right)$$

$$P_{A,L} = 609.3 \text{ Pa}$$

Then the concentration of toluene is determined to be

$$C_{A,L} = \frac{P_{A,L}}{R_u T} M = \frac{609.3 \text{ Pa}}{(8314 \text{ Pa} \cdot \text{m}^3/\text{kmol} \cdot \text{K})(6.4 + 273 \text{ K})} (92 \text{ kg/kmol}) = 0.0241 \text{ kg/m}^3 = \mathbf{24.1 \text{ g/m}^3}$$

14-147 A sphere of crystalline sodium chloride (NaCl) was suspended in a stirred tank filled with water. The average mass transfer coefficient is to be determined.

Assumptions 1 The properties of NaCl are constant.

Properties The density of NaCl and its solubility in water at 20°C are given to be 2160 kg/m³ and 320 kg/m³, respectively.

Analysis The initial diameter of the sphere is

$$m_1 = \rho V = \rho \frac{\pi D^3}{6} \longrightarrow 0.100 \text{ kg} = (2160 \text{ kg/m}^3) \frac{\pi D_1^3}{6} \longrightarrow D_1 = 0.04455 \text{ m}$$

The final diameter of the sphere is

$$m_2 = \rho V = \rho \frac{\pi D^3}{6} \longrightarrow (0.90)(0.100 \text{ kg}) = (2160 \text{ kg/m}^3) \frac{\pi D_2^3}{6} \longrightarrow D_2 = 0.04301 \text{ m}$$

The rate of mass change is

$$\dot{m} = \frac{m_1 - m_2}{\Delta t} = \frac{(0.100 - 0.090) \text{ kg}}{10 \times 60 \text{ s}} = 1.667 \times 10^{-5} \text{ kg/s}$$

The average surface area is

$$A_s = \frac{\pi D_1^2 + \pi D_2^2}{2} = \frac{\pi(0.04455 \text{ m})^2 + \pi(0.04301 \text{ m})^2}{2} = 6.023 \times 10^{-3} \text{ m}^2$$

The mass transfer coefficient is determined from

$$h_{\text{mass}} = \frac{\dot{m}}{A_s \Delta \rho_A} = \frac{1.667 \times 10^{-5} \text{ kg/s}}{(6.023 \times 10^{-3} \text{ m}^2)(320 - 0) \text{ kg/m}^3} = \mathbf{8.65 \times 10^{-6} \text{ m/s}}$$

14-148 Benzene-free air flows in a tube whose inner surface is coated with pure benzene. The average mass transfer coefficient, the molar concentration of benzene in the outlet air, and the evaporation rate of benzene are to be determined.

Assumptions 1 The low mass flux model and thus the analogy between heat and mass transfer is applicable. **2** The flow is fully developed.

Properties Because of low mass flux conditions, we can use dry air properties for the mixture at the specified temperature of 25°C and 1 atm, for which $\nu = 1.562 \times 10^{-5} \text{ m}^2/\text{s}$ (Table A-15). The mass diffusivity of benzene in air at 298 K is $D_{AB} = 0.88 \times 10^{-5} \text{ m}^2/\text{s}$ (Table 14-2). The molar mass of benzene is 78 kg/kmol.

Analysis (a) The Reynolds number of the flow is

$$\text{Re} = \frac{VD}{\nu} = \frac{(5 \text{ m/s})(0.05 \text{ m})}{1.562 \times 10^{-5} \text{ m}^2/\text{s}} = 16,005$$

which is greater than 10,000 and thus the flow is turbulent. The Schmidt number in this case is

$$\text{Sc} = \frac{\nu}{D_{AB}} = \frac{1.562 \times 10^{-5} \text{ m}^2/\text{s}}{0.88 \times 10^{-5} \text{ m}^2/\text{s}} = 1.775$$

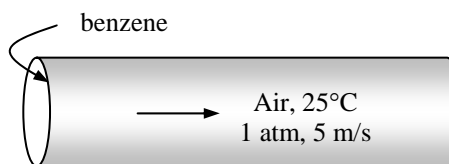

Therefore, the Sherwood number in this case is determined from Table 14-13 to be

$$\text{Sh} = 0.023 \text{Re}^{0.8} \text{Sc}^{0.4} = 0.023(16,005)^{0.8} (1.775)^{0.4} = 66.8$$

Using the definition of Sherwood number, the mass transfer coefficient is determined to be

$$h_{\text{mass}} = \frac{\text{Sh}D_{AB}}{D} = \frac{(66.8)(0.88 \times 10^{-5} \text{ m}^2/\text{s})}{0.05 \text{ m}} = \mathbf{0.0118 \text{ m/s}}$$

(b) The molar concentration of benzene in the outlet air is determined as follows

$$C_s = \frac{P_v}{R_u T} = \frac{13 \text{ kPa}}{(8.314 \text{ kPa} \cdot \text{m}^3/\text{kmol} \cdot \text{K})(25 + 273 \text{ K})} = 5.25 \times 10^{-3} \text{ kmol/m}^3$$

$$VA_c(C_{\text{out}} - C_{\text{in}}) = h_{\text{mass}} A \left[\frac{(C_s - C_{\text{in}}) - (C_s - C_{\text{out}})}{\ln\left(\frac{C_s - C_{\text{in}}}{C_s - C_{\text{out}}}\right)} \right]$$

$$(5)(\pi \times 0.05^2 / 4)(C_{\text{out}} - 0) = (0.0118)(\pi \times 0.05 \times 6) \left[\frac{(5.25 \times 10^{-3} - 0) - (5.25 \times 10^{-3} - C_{\text{out}})}{\ln\left(\frac{5.25 \times 10^{-3} - 0}{5.25 \times 10^{-3} - C_{\text{out}}}\right)} \right]$$

$$\longrightarrow C_{\text{out}} = \mathbf{3.56 \times 10^{-3} \text{ kmol/m}^3}$$

(c) The evaporation rate of benzene is determined from

$$\begin{aligned} \dot{m}_{\text{evap}} &= MVA_c(C_{\text{out}} - C_{\text{in}}) \\ &= (78 \text{ kg/kmol})(5 \text{ m/s}) \frac{\pi \times (0.05 \text{ m})^2}{4} (3.56 \times 10^{-3} \text{ kmol/m}^3 - 0) \\ &= 2.73 \times 10^{-3} \text{ kg/s} = \mathbf{9.81 \text{ kg/h}} \end{aligned}$$

14-149 The liquid layer on the inner surface of a circular pipe is dried by blowing air through it. The average mass transfer coefficient, log-mean driving force for mass transfer (in molar concentration units, the evaporation rate, and the tube length are to be determined.

Assumptions 1 The low mass flux model and thus the analogy between heat and mass transfer is applicable since the mass fraction of vapor in the air is low (about 2 percent for saturated air at 325 K). **2** The flow is fully developed.

Properties Because of low mass flux conditions, we can use dry air properties for the mixture at the specified temperature of 52°C and 1 atm, for which $\nu = 1.818 \times 10^{-5} \text{ m}^2/\text{s}$ (Table A-15). The mass diffusivity of water vapor in air at $52+273 = 325 \text{ K}$ is determined from Eq. 14-15 to be

$$D_{AB} = D_{\text{H}_2\text{O-air}} = 1.87 \times 10^{-10} \frac{T^{2.072}}{P}$$

$$= 1.87 \times 10^{-10} \frac{(325 \text{ K})^{2.072}}{1} = 3.00 \times 10^{-5} \text{ m}^2/\text{s}$$

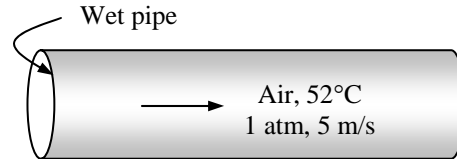

Analysis (a) The Reynolds number of the flow is

$$\text{Re} = \frac{VD}{\nu} = \frac{(5 \text{ m/s})(0.05 \text{ m})}{1.818 \times 10^{-5} \text{ m}^2/\text{s}} = 13,750$$

which is greater than 10,000 and thus the flow is turbulent. The Schmidt number in this case is

$$\text{Sc} = \frac{\nu}{D_{AB}} = \frac{1.818 \times 10^{-5} \text{ m}^2/\text{s}}{3.00 \times 10^{-5} \text{ m}^2/\text{s}} = 0.606$$

Therefore, the Sherwood number in this case is determined from Table 14-13 to be

$$\text{Sh} = 0.023 \text{Re}^{0.8} \text{Sc}^{0.4} = 0.023(13,750)^{0.8} (0.606)^{0.4} = 38.5$$

Using the definition of Sherwood number, the mass transfer coefficient is determined to be

$$h_{mass} = \frac{\text{Sh}D_{AB}}{D} = \frac{(38.5)(3.00 \times 10^{-5} \text{ m}^2/\text{s})}{0.05 \text{ m}} = \mathbf{0.0231 \text{ m/s}}$$

(b) The log-mean driving force for mass transfer (in molar concentration units) is determined as follows

$$C_w = \frac{P_v}{R_u T} = \frac{13.6 \text{ kPa}}{(8.314 \text{ kPa} \cdot \text{m}^3/\text{kmol} \cdot \text{K})(325 \text{ K})} = 5.03 \times 10^{-3} \text{ kmol/m}^3$$

$$C_{in} = \frac{P_v}{R_u T} = \frac{0.1 \times 13.6 \text{ kPa}}{(8.314 \text{ kPa} \cdot \text{m}^3/\text{kmol} \cdot \text{K})(325 \text{ K})} = 5.03 \times 10^{-4} \text{ kmol/m}^3$$

$$C_{out} = \frac{P_v}{R_u T} = \frac{10.0 \text{ kPa}}{(8.314 \text{ kPa} \cdot \text{m}^3/\text{kmol} \cdot \text{K})(325 \text{ K})} = 3.70 \times 10^{-3} \text{ kmol/m}^3$$

$$\Delta C = \frac{(C_w - C_{in}) - (C_w - C_{out})}{\ln\left(\frac{C_w - C_{in}}{C_w - C_{out}}\right)}$$

$$= \frac{(5.03 \times 10^{-3} - 0.503 \times 10^{-3}) - (5.03 \times 10^{-3} - 3.70 \times 10^{-3})}{\ln\left(\frac{5.03 \times 10^{-3} - 0.503 \times 10^{-3}}{5.03 \times 10^{-3} - 3.70 \times 10^{-3}}\right)} = \mathbf{2.61 \times 10^{-3} \text{ kmol/m}^3}$$

(c) The evaporation rate is determined from

$$\dot{m}_{evap} = MVA_c (C_{out} - C_{in}) = (18 \text{ kg/kmol})(5 \text{ m/s}) \frac{\pi(0.05 \text{ m})^2}{4} (3.70 \times 10^{-3} - 0.503 \times 10^{-3}) \text{ kmol/m}^3$$

$$= 5.65 \times 10^{-4} \text{ kg/s} = \mathbf{2.03 \text{ kg/h}}$$

(d) The tube length is determined from

$$\frac{\dot{m}_{evap}}{M} = h_{mass} A \Delta C \rightarrow \frac{5.65 \times 10^{-4} \text{ kg/s}}{18 \text{ kg/kmol}} = (0.0231 \text{ m/s}) \pi (0.05 \text{ m}) L (2.61 \times 10^{-3} \text{ kmol/m}^3) \rightarrow L = \mathbf{3.31 \text{ m}}$$

14-150 Liquid n-octane evaporates in a vertical tube subjected to cross flow of air. The mass diffusivity of n-octane is to be determined.

Properties The molar mass of n-octane is 114 kg/kmol.

Analysis The rate of evaporation of n-octane is

$$\dot{m} = \frac{m}{\Delta t} = \frac{0.001 \text{ kg}}{38 \times 3600 \text{ s/day}} = 7.31 \times 10^{-9} \text{ kg/s}$$

$$\dot{N} = \frac{\dot{m}/M}{A} = \frac{(7.31 \times 10^{-9} \text{ kg/s})/(114 \text{ kg/kmol})}{\frac{\pi(0.05 \text{ m})^2}{4}} = 3.26 \times 10^{-8} \text{ kmol/m}^2 \cdot \text{s}$$

The mass diffusivity of n-octane is determined from

$$\dot{N}_A = \frac{D_{AB} P}{LR_u T} \ln \left(\frac{P - P_{A,L}}{P - P_{A,0}} \right)$$

$$3.26 \times 10^{-8} \text{ kmol/m}^2 \cdot \text{s} = \frac{D_{AB} (101.3 \text{ kPa})}{(0.10 \text{ m})(8.314 \text{ kPa} \cdot \text{m}^3/\text{kmol} \cdot \text{K})(293)} \ln \left(\frac{101.3 - 0}{101.3 - 1.41} \right)$$

$$\longrightarrow D_{AB} = \mathbf{5.6 \times 10^{-6} \text{ m}^2/\text{s}}$$

14-151 A sphere of ice is exposed to wind. The ice evaporation rate is to be determined.

Assumptions 1 The low mass flux model and thus the analogy between heat and mass transfer is applicable since the mass fraction of vapor in the air is low (about 2 percent for saturated air at 300 K). **2** The flow is fully developed.

Properties The properties are given in problem statement.

Analysis The Reynolds and Schmidt numbers are

$$\text{Re} = \frac{VD}{\nu} = \frac{(50/3.6 \text{ m/s})(0.05 \text{ m})}{1.32 \times 10^{-7} \text{ m}^2/\text{s}} = 5.26 \times 10^6$$

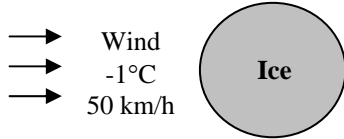
$$\text{Sc} = \frac{\nu}{D_{AB}} = \frac{1.32 \times 10^{-7} \text{ m}^2/\text{s}}{2.5 \times 10^{-5} \text{ m}^2/\text{s}} = 5.28 \times 10^{-3}$$

The Sherwood number is

$$\text{Sh} = \left[4 + 1.21(\text{Re Sc})^{2/3} \right]^{0.5} = \left[4 + 1.21 \left[(5.26 \times 10^6)(5.28 \times 10^{-3}) \right]^{2/3} \right]^{0.5} = 33.4$$

Using the definition of Sherwood number, the mass transfer coefficient is determined to be

$$h_{\text{mass}} = \frac{\text{Sh} D_{AB}}{D} = \frac{(33.4)(2.5 \times 10^{-5} \text{ m}^2/\text{s})}{0.05 \text{ m}} = 0.0167 \text{ m/s}$$

The evaporation rate is determined as follows:

$$\dot{N} = h_{\text{mass}} \Delta C = h_{\text{mass}} \left(\frac{P_{A,0}}{R_u T} - \frac{P_{A,L}}{R_u T} \right) = h_{\text{mass}} \frac{P_v}{R_u T} (1 - 0.1)$$

$$= (0.0167 \text{ m/s}) \frac{0.56 \text{ kPa}}{(8.314 \text{ kPa} \cdot \text{m}^3/\text{kmol} \cdot \text{kg})(272 \text{ K})} (1 - 0.1) = 3.72 \times 10^{-6} \text{ kmol/m}^2 \cdot \text{s}$$

$$\dot{m}_{\text{evap}} = \dot{N} M A = (3.72 \times 10^{-6} \text{ kmol/m}^2 \cdot \text{s})(18 \text{ kg/kmol}) \left[\pi(0.05 \text{ m})^2 \right]$$

$$= 5.26 \times 10^{-7} \text{ kg/s} = \mathbf{1.9 \text{ g/h}}$$

Fundamentals of Engineering (FE) Exam Problems

14-152 When the ____ is unity, one can expect the momentum and mass transfer by diffusion to be the same.

- (a) Grashof (b) Reynolds (c) Lewis (d) Schmidt (e) Sherwood

Answer (d) Schmidt

14-153 The basic equation describing the diffusion of one medium through another stationary medium is

- (a) $j_A = -CD_{AB} \frac{d(C_A / C)}{dx}$ (b) $j_A = -D_{AB} \frac{d(C_A / C)}{dx}$
 (c) $j_A = -k \frac{d(C_A / C)}{dx}$ (d) $j_A = -k \frac{dT}{dx}$ e) None of them

Answer (a) $j_A = -CD_{AB} \frac{d(C_A / C)}{dx}$

14-154 For the absorption of a gas, like carbon dioxide, into a liquid, like water, Henry's law states that partial pressure of the gas is proportional to the mole fraction of the gas in the liquid-gas solution with the constant of proportionality being Henry's constant. A bottle of soda pop (CO₂-H₂O) at room temperature has a Henry's constant of 17,100 kPa. If the pressure in this bottle is 120 kPa and the partial pressure of the water vapor in the gas volume at the top of the bottle is neglected, the concentration of the CO₂ in the liquid H₂O is

- (a) 0.003 mol-CO₂/mol (b) 0.007 mol-CO₂/mol (c) 0.013 mol-CO₂/mol
 (d) 0.022 mol-CO₂/mol (e) 0.047 mol-CO₂/mol

Answer (b) 0.007 mol-CO₂/mol

Solution Solved by EES Software. Solutions can be verified by copying-and-pasting the following lines on a blank EES screen.

```
H=17.1 [MPa]
P=0.120 [MPa]
y=P/H
```

14-155 A recent attempt to circumnavigate the world in a balloon used a helium filled balloon whose volume was 7240 m^3 and surface area was 1800 m^2 . The skin of this balloon is 2 mm thick and is made of a material whose helium diffusion coefficient is $1 \times 10^{-9} \text{ m}^2/\text{s}$. The molar concentration of the helium at the inner surface of the balloon skin is 0.2 kmol/m^3 and the molar concentration at the outer surface is extremely small. The rate at which helium is lost from this balloon is

- (a) 0.26 kg/h (b) 1.5 kg/h (c) 2.6 kg/h (d) 3.8 kg/h (e) 5.2 kg/h

Answer (c) 2.6 kg/h

Solution Solved by EES Software. Solutions can be verified by copying-and-pasting the following lines on a blank EES screen.

```

Ci=0.2 [kmol/m^3]
Co=0 [kmol/m^3]
D=1E-9 [m^2/s]
L=0.002 [m]
M=4 [kg/kmol]
A=1800 [m^2]
Ndot=D*A*(Ci-Co)/L
Mdot=Ndot*M*3600

```

14-156 A rubber object is in contact with nitrogen (N_2) at 298 K and 250 kPa. The solubility of nitrogen gas in rubber is $0.00156 \text{ kmol/m}^3 \cdot \text{bar}$. The mass density of nitrogen at the interface is

- (a) 0.049 kg/m^3 (b) 0.064 kg/m^3 (c) 0.077 kg/m^3 (d) 0.092 kg/m^3 (e) 0.109 kg/m^3

Answer (e) 0.109 kg/m^3

Solution Solved by EES Software. Solutions can be verified by copying-and-pasting the following lines on a blank EES screen.

```

T=298 [K]
P_N2_gasside=250 [kPa]*Convert(kPa, bar)
S=0.00156 [kmol/m^3-bar] "Table 14-7"
C_N2_solidside=S*P_N2_gasside
M_N2=MolarMass(N2)
rho_N2_solidside=C_N2_solidside*M_N2

```

14-157 Nitrogen gas at high pressure and 298 K is contained in a 2-m \times 2-m \times 2-m cubical container made of natural rubber whose walls are 4 cm thick. The concentration of nitrogen in the rubber at the inner and outer surfaces are 0.067 kg/m³ and 0.009 kg/m³, respectively. The diffusion coefficient of nitrogen through rubber is 1.5×10^{-10} m²/s. The mass flow rate of nitrogen by diffusion through the cubical container is

- (a) 8.24×10^{-10} kg/s (b) 1.35×10^{-10} kg/s (c) 5.22×10^{-9} kg/s (d) 9.71×10^{-9} kg/s (e) 3.58×10^{-8} kg/s

Answer (c) 5.22×10^{-9} kg/s

Solution Solved by EES Software. Solutions can be verified by copying-and-pasting the following lines on a blank EES screen.

```
s=2 [m]
L=0.04 [m]
rho_A_1=0.067 [kg/m^3]
rho_A_2=0.009 [kg/m^3]

A=6*s^2
D_AB=1.5E-10 [m^2/s] "Table 14-3b"
m_dot_diff=D_AB*A*(rho_A_1-rho_A_2)/L
```

14-158 Carbon at 1273 K is contained in a 7-cm-inner-diameter cylinder made of iron whose thickness is 1.2 mm. The concentration of carbon in the iron at the inner surface is 0.5 kg/m³ and the concentration of carbon in the iron at the outer surface is negligible. The diffusion coefficient of carbon through iron is 3×10^{-11} m²/s. The mass flow rate carbon by diffusion through the cylinder shell per unit length of the cylinder is

- (a) 2.8×10^{-9} kg/s (b) 5.4×10^{-9} kg/s (c) 8.8×10^{-9} kg/s (d) 1.6×10^{-8} kg/s (e) 5.2×10^{-8} kg/s

Answer (a) 2.8×10^{-9} kg/s

Solution Solved by EES Software. Solutions can be verified by copying-and-pasting the following lines on a blank EES screen.

```
T=1273 [K]
D_i=0.07 [m]
D_o=D_i+2*0.0012 [m]
rho_A_1=0.5 [kg/m^3]
rho_A_2=0 [kg/m^3]

D_AB=3.0E-11 [m^2/s] "Table 14-3b"
r_1=D_i/2
r_2=D_o/2
L=1 [m]
m_dot_diff=2*pi*L*D_AB*(rho_A_1-rho_A_2)/ln(r_2/r_1)
```

14-159 The surface of an iron component is to be hardened by carbon. The diffusion coefficient of carbon in iron at 1000°C is given to be $3 \times 10^{-11} \text{ m}^2/\text{s}$. If the penetration depth of carbon in iron is desired to be 1.0 mm, the hardening process must take at least

- (a) 1.10 h (b) 1.47 h (c) 1.86 h (d) 2.50 h (e) 2.95 h

Answer (e) 2.95 h

Solution Solved by EES Software. Solutions can be verified by copying-and-pasting the following lines on a blank EES screen.

```
D_AB=3E-11 [m^2/s]
delta_diff=1E-3 [m]
delta_diff=sqrt(pi*D_AB*t)
t_hour=t*Convert(s, h)
```

14-160 Saturated water vapor at 25°C ($P_{\text{sat}} = 3.17 \text{ kPa}$) flows in a pipe that passes through air at 25°C with a relative humidity of 40 percent. The vapor is vented to the atmosphere through a 7-mm-internal diameter tube that extends 10 m into the air. The diffusion coefficient of vapor through air is $2.5 \times 10^{-5} \text{ m}^2/\text{s}$. The amount of water vapor lost to the atmosphere through this individual tube by diffusion is

- (a) $1.02 \times 10^{-6} \text{ kg}$ (b) $1.37 \times 10^{-6} \text{ kg}$ (c) $2.28 \times 10^{-6} \text{ kg}$ (d) $4.13 \times 10^{-6} \text{ kg}$ (e) $6.07 \times 10^{-6} \text{ kg}$

Answer (b) $1.37 \times 10^{-6} \text{ kg}$

Solution Solved by EES Software. Solutions can be verified by copying-and-pasting the following lines on a blank EES screen.

```
T=25 [C]
phi=0.40
D=0.007 [m]
L=10 [m]
```

```
D_AB=2.5E-5 [m^2/s] "Table 14-2"
P_A_0=pressure(steam_iapws, x=1, T=T) "pressure of vapor at x=0"
P_A_L=phi*P_A_0 "pressure of vapor at x=L=10 m"
A=pi*D^2/4
R_u=8.314[kPa-m^3/kmol-K]
N_dot_vapor=(D_AB*A)/(R_u*T)*(P_A_0-P_A_L)/L
MM=MolarMass(H2O)
m_dot_vapor=N_dot_vapor*MM
time=24*3600 [s]
m_vapor=m_dot_vapor*time
```

"Some Wrong Solutions with Common Mistakes"

```
W_P_A_L=0 "Taking the vapor pressure at air side zero"
W_N_dot_vapor=(D_AB*A)/(R_u*T)*(P_A_0-W_P_A_L)/L
W_m_dot_vapor=W_N_dot_vapor*MM
W_m_vapor=W_m_dot_vapor*time
```

14-161 Air flows in a 4-cm-diameter wet pipe at 20°C and 1 atm with an average velocity of 4 m/s in order to dry the surface. The Nusselt number in this case can be determined from $Nu = 0.023 Re^{0.8} Pr^{0.4}$ where $Re = 10,550$ and $Pr = 0.731$. Also, the diffusion coefficient of water vapor in air is $2.42 \times 10^{-5} \text{ m}^2/\text{s}$. Using the analogy between heat and mass transfer, the mass transfer coefficient inside the pipe for fully developed flow becomes

- (a) 0.0918 m/s (b) 0.0408 m/s (c) 0.0366 m/s (d) 0.0203 m/s (e) 0.0022 m/s

Answer (d) 0.0203 m/s

Solution Solved by EES Software. Solutions can be verified by copying-and-pasting the following lines on a blank EES screen.

```
D=0.04 [m]
T=20[C]+273 [K]
P=1 [atm]
V=4 [m/s]
Re=10550
Pr=0.731
D_AB=2.42E-5 [m^2/s]

Nus=0.023*Re^0.8*Pr^0.4 "Table 14-13"
Sh=Nus
h_mass=(Sh*D_AB)/D
```

"Some Wrong Solutions with Common Mistakes"

```
W_Sh=3.66 "Considering laminar flow"
W_h_mass=(W_Sh*D_AB)/D
```

14-162 Air flows through a wet pipe at 298 K and 1 atm, and the diffusion coefficient of water vapor in air is $2.5 \times 10^{-5} \text{ m}^2/\text{s}$. If the heat transfer coefficient is determined to be $35 \text{ W/m}^2 \cdot ^\circ\text{C}$, the mass transfer coefficient is

- (a) 0.0326 m/s (b) 0.0387 m/s (c) 0.0517 m/s (d) 0.0583 m/s (e) 0.0707 m/s

Answer (a) 0.0326 m/s

Solution Solved by EES Software. Solutions can be verified by copying-and-pasting the following lines on a blank EES screen.

```
T=298 [K]
P=1 [atm]
h_heat=35 [W/m^2-C]

D_AB=2.5E-5 [m^2/s] "Table 14-2"
rho=1.184 [kg/m^3]
c_p=1007 [J/kg-C]
alpha=2.141E-5 [m^2/s]
h_heat=h_mass*rho*c_p*(alpha/D_AB)^(2/3)
```

14-163 A natural gas (methane, CH₄) storage facility uses 3 cm diameter by 6 m long vent tubes on its storage tanks to keep the pressure in these tanks at atmospheric value. If the diffusion coefficient for methane in air is $0.2 \times 10^{-4} \text{ m}^2/\text{s}$ and the temperature of the tank and environment is 300 K, the rate at which natural gas is lost from a tank through one vent tube is

- (a) $13 \times 10^{-5} \text{ kg/day}$ (b) $3.2 \times 10^{-5} \text{ kg/day}$ (c) $8.7 \times 10^{-5} \text{ kg/day}$ (d) $5.3 \times 10^{-5} \text{ kg/day}$ (e) $0.12 \times 10^{-5} \text{ kg/day}$

Answer (a) $13 \times 10^{-5} \text{ kg/day}$

Solution Solved by EES Software. Solutions can be verified by copying-and-pasting the following lines on a blank EES screen.

```
d=0.03 [m]
L=6 [m]
D_AB=0.2E-4 [m^2/s]
P=101 [kPa]
T=300 [K]
M=16 [kg/kmol]
A=pi*d^2/4
Ndot=(D_AB*A/(R#*T))*(P/L)
Mdot=Ndot*M*Convert(day, s)
```

14-164 14-168 Design and Essay Problems



Chapter 15

COOLING OF ELECTRONIC EQUIPMENT

Introduction and History

15-1C The invention of vacuum diode started the electronic age. The invention of the transistor marked the beginning of a revolution in that age since the transistors performed the functions of the vacuum tubes with greater reliability while occupying negligible space and consuming negligible power compared to the vacuum tubes.

15-2C Integrated circuits are semiconductor devices in which several components such as diodes, transistors, resistors and capacitors are housed together. The initials MSI, LSI, and VLSI stand for medium scale integration, large scale integration, and very large scale integration, respectively.

15-3C The electrical resistance R is a measure of resistance against current flow, and the friction between the electrons and the material causes heating. The amount of the heat generated can be determined from Ohm's law, $W = I^2 R$.

15-4C The electrical energy consumed by the TV is eventually converted to heat, and the blanket wrapped around the TV prevents the heat from escaping. Then the temperature of the TV set will have to start rising as a result of heat build up. The TV set will have to burn up if operated this way for a long time. However, for short time periods, the temperature rise will not reach destructive levels.

15-5C Since the heat generated in the incandescent light bulb which is completely wrapped can not escape, the temperature of the light bulb will increase, and will possibly start a fire by igniting the towel.

15-6C When the air flow to the radiator is blocked, the hot water coming off the engine cannot be cooled, and thus the engine will overheat and fail, and possible catch fire.

15-7C A car is much more likely to break since it has more moving parts than a TV.

15-8C Diffusion in semi-conductor materials, chemical reactions and creep in the bending materials cause electronic components to fail under prolonged use at high temperatures.

15-9 The case temperature of a power transistor and the junction-to-case resistance are given. The junction temperature is to be determined.

Assumptions Steady operating conditions exist.

Analysis The rate of heat transfer between the junction and the case in steady operation is

$$\dot{Q} = \left(\frac{\Delta T}{R} \right)_{\text{junction-case}} = \frac{T_{\text{junction}} - T_{\text{case}}}{R_{\text{junction-case}}}$$

Then the junction temperature is determined to be

$$T_{\text{junction}} = T_{\text{case}} + \dot{Q}R_{\text{junction-case}} = 60^{\circ}\text{C} + (12 \text{ W})(5^{\circ}\text{C/W}) = \mathbf{120^{\circ}\text{C}}$$

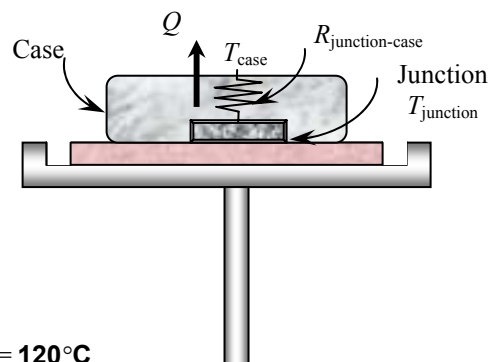

15-10 The power dissipated by an electronic component as well as the junction and case temperatures are measured. The junction-to-case resistance is to be determined.

Assumptions Steady operating conditions exist.

Analysis The rate of heat transfer from the component is

$$\dot{W}_e = \dot{Q} = VI = (12 \text{ V})(0.15 \text{ A}) = 1.8 \text{ W}$$

Then the junction-to-case thermal resistance of this component becomes

$$R_{\text{junction-case}} = \frac{T_{\text{junction}} - T_{\text{case}}}{\dot{Q}} = \frac{(80 - 55)^{\circ}\text{C}}{1.8 \text{ W}} = \mathbf{13.9^{\circ}\text{C/W}}$$

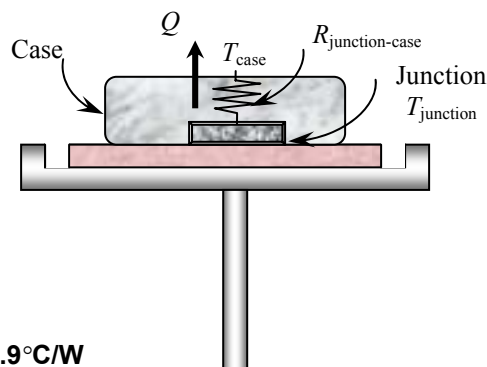

15-11 A logic chip dissipates 6 W power. The amount of heat this chip dissipates during a 10-h period and the heat flux on the surface of the chip are to be determined.

Assumptions 1 Steady operating conditions exist. 2 Heat transfer from the surface is uniform.

Analysis (a) The amount of heat this chip dissipates during an eight-hour workday is

$$Q = \dot{Q}\Delta t = (0.006 \text{ kW})(8 \text{ h}) = \mathbf{0.048 \text{ kWh}}$$

(b) The heat flux on the surface of the chip is

$$\dot{q} = \frac{\dot{Q}}{A} = \frac{6 \text{ W}}{0.32 \text{ cm}^2} = \mathbf{18.8 \text{ W/cm}^2}$$

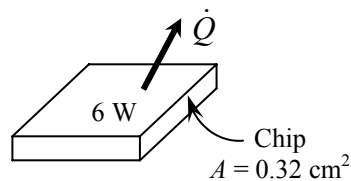

15-12 A circuit board houses 90 closely spaced logic chips, each dissipating 0.1 W. The amount of heat this chip dissipates in 10 h and the heat flux on the surface of the circuit board are to be determined.

Assumptions 1 Steady operating conditions exist. 2 The heat transfer from the back surface of the board is negligible.

Analysis (a) The rate of heat transfer and the amount of heat this circuit board dissipates during a ten-hour period are

$$\dot{Q}_{total} = (90)(0.1 \text{ W}) = 9 \text{ W}$$

$$Q_{total} = \dot{Q}_{total} \Delta t = (0.009 \text{ kW})(10 \text{ h}) = \mathbf{0.09 \text{ kWh}}$$

(b) The average heat flux on the surface of the circuit board is

$$\dot{q} = \frac{\dot{Q}_{total}}{A_s} = \frac{9 \text{ W}}{(15 \text{ cm})(20 \text{ cm})} = \mathbf{0.03 \text{ W/cm}^2}$$

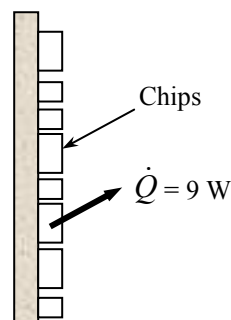

15-13E The total thermal resistance and the temperature of a resistor are given. The power at which it can operate safely in a particular environment is to be determined.

Assumptions Steady operating conditions exist.

Analysis The power at which this resistor can be operate safely is determined from

$$\dot{Q} = \frac{T_{resistor} - T_{ambient}}{R_{total}} = \frac{(360 - 120)^{\circ}\text{F}}{130^{\circ}\text{F/W}} = \mathbf{1.85 \text{ W}}$$

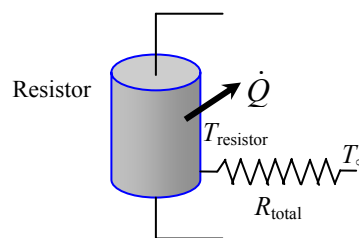

15-14 The surface-to-ambient thermal resistance and the surface temperature of a resistor are given. The power at which it can operate safely in a particular environment is to be determined.

Assumptions Steady operating conditions exist.

Analysis The power at which this resistor can operate safely is determined from

$$\dot{Q} = \frac{T_{resistor} - T_{ambient}}{R_{total}} = \frac{(150 - 30)^{\circ}\text{C}}{300^{\circ}\text{C/W}} = \mathbf{0.4 \text{ W}}$$

At specified conditions, the resistor dissipates

$$\dot{Q} = \frac{V^2}{R} = \frac{(7.5 \text{ V})^2}{(100 \Omega)} = 0.5625 \text{ W}$$

of power. Therefore, the current operation is not safe.

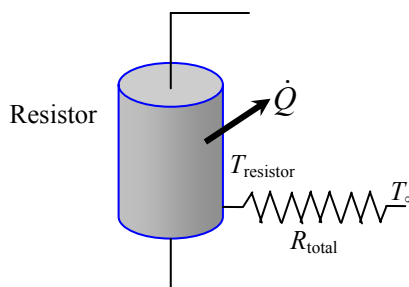

15-15 EES Prob. 15-14 is reconsidered. The power at which the resistor can operate safely as a function of the ambient temperature is to be plotted.

Analysis The problem is solved using EES, and the solution is given below.

"GIVEN"

R_electric=100 [ohm]

R_thermal=300 [C/W]

V=7.5 [volts]

T_resistor=150 [C]

T_ambient=30 [C]

"ANALYSIS"

$\dot{Q}_{\text{safe}} = (T_{\text{resistor}} - T_{\text{ambient}}) / R_{\text{thermal}}$

T_ambient [C]	Q_safe [W]
20	0.4333
21	0.43
22	0.4267
23	0.4233
24	0.42
25	0.4167
26	0.4133
27	0.41
28	0.4067
29	0.4033
30	0.4
31	0.3967
32	0.3933
33	0.39
34	0.3867
35	0.3833
36	0.38
37	0.3767
38	0.3733
39	0.37
40	0.3667

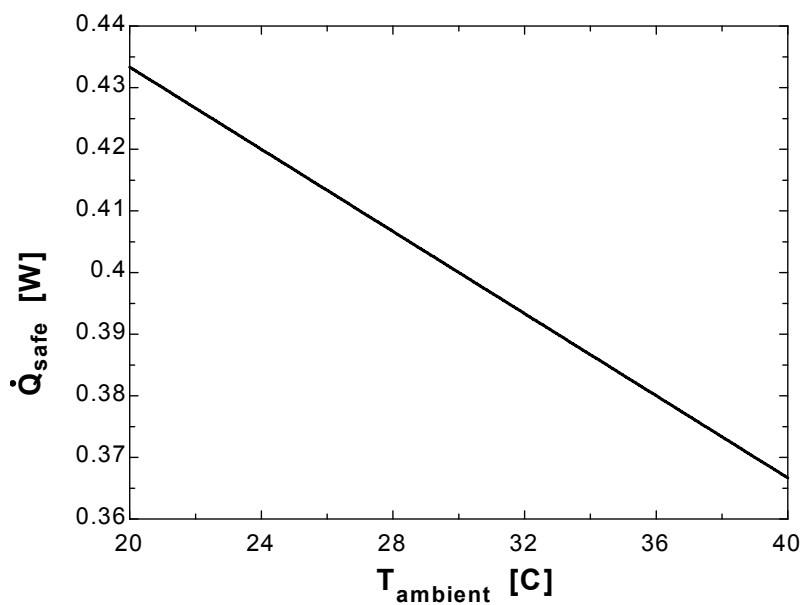

Manufacturing of Electronic Equipment

15-16C The thermal expansion coefficient of the plastic is about 20 times that of silicon. Therefore, bonding the silicon directly to the plastic case will result in such large thermal stresses that the reliability would be seriously jeopardized. To avoid this problem, a lead frame made of a copper alloy with a thermal expansion coefficient close to that of silicon is used as the bonding surface.

15-17C The schematic of chip carrier is given in the figure. Heat generated at the junction is transferred through the chip to the lead frame, then through the case to the leads. From the leads heat is transferred to the ambient or to the medium the leads are connected to.

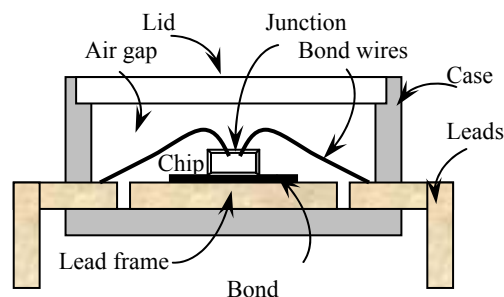

15-18C The cavity of the chip carrier is filled with a gas which is a poor conductor of heat. Also, the case is often made of materials which are also poor conductors of heat. This results in a relatively large thermal resistance between the chip and the case, called the junction-to-case thermal resistance. It depends on the geometry and the size of the chip carrier as well as the material properties of the bonding material and the case.

15-19C A hybrid chip carrier houses several chips, individual electronic components, and ordinary circuit elements connected to each other. The result is improved performance due to the shortening of the wiring lengths, and enhanced reliability. Lower cost would be an added benefit of multi-chip packages if they are produced in sufficiently large quantities.

15-20C A printed circuit board (PCB) is a properly wired plane board on which various electronic components such as the ICs, diodes, transistors, resistors, and capacitors are mounted to perform a certain task. The board of a PCB is made of polymers and glass epoxy materials. The thermal resistance between a device on the board and edge of the board is called as device-to-PCB edge thermal resistance. This resistance is usually high (about 20 to 60 °C/W) because of the low thickness of the board and the low thermal conductivity of the board material.

15-21C The three types of circuit boards are the single-sided, double-sided, and multi-layer boards. The single-sided PCBs have circuitry lines on one side of the board only, and are suitable for low density electronic devices (10-20 components). The double-sided PCBs have circuitry on both sides, and are best suited for intermediate density devices. Multi-layer PCBs contain several layers of circuitry, and they are suitable for high density devices. They are equivalent to several PCBs sandwiched together.

15-22C The desirable characteristics of the materials used in the fabrication of circuit boards are: (1) being an effective electrical insulator to prevent electrical breakdown, (2) being a good heat conductor to conduct the heat generated away, (3) having high material strength to withstand the forces and to maintain dimensional stability, (4) having a thermal expansion coefficient which closely matches to that of copper to prevent cracking in the copper cladding during thermal cycling, (5) having a high resistance to moisture absorption since moisture can effect both mechanical and electrical properties and degrade performance, (6) stability in properties at temperature levels encountered in electronic applications, (7) ready availability and manufacturability, and, of course (8) low cost.

15-23C An electronic enclosure (a case or a cabinet) house the circuit boards and the necessary peripheral equipment and connectors. It protects them from the detrimental effects of the environment, and may provide a cooling path. An electronic enclosure can simply be made of sheet metals such as thin gauge aluminum or steel.

Cooling Load of Electronic Equipment and Thermal Environment

15-24C The heating load of an electronic box which consumes 120 W of power is simply 120 W because of the conservation of energy principle.

15-25C Superconductor materials will generate hardly any heat and as a result, more components can be packed into a smaller volume, resulting in enhanced speed and reliability without having to resort to some exotic cooling techniques.

15-26C The actual power dissipated by a device can be considerably less than its rated power, depending on its duty cycle (the fraction of time it is on). A 5 W power transistor, for example, will dissipate an average of 2 W of power if it is active only 40 percent of the time. Then we can treat this transistor as a 2-W device when designing a cooling system. This may allow the selection of a simpler and cheaper cooling mechanism.

15-27C The cyclic variation of temperature of an electronic device during operation is called the temperature cycling. The thermal stresses caused by temperature cycling undermines the reliability of electronic devices. The failure rate of electronic devices subjected to deliberate temperature cycling of more than 20 °C is observed to increase by eight-fold.

15-28C The ultimate heat sink for a TV is the room air with a temperature range of about 10 to 30°C. For an airplane it is the ambient air with a temperature range of about -50°C to 50°C. The ultimate heat sink for a ship is the sea water with a temperature range of 0°C to 30°C.

15-29C The ultimate heat sink for a VCR is the room air with a temperature range of about 10 to 30°C. For a spacecraft it is the ambient air or space with a temperature range of about -273°C to 50°C. The ultimate heat sink for a communication system on top of a mountain is the ambient air with a temperature range of about -20°C to 50°C.

Electronics Cooling in Different Applications

15-30C The electronics of short-range missiles do not need any cooling because of their short cruising times. The missiles reach their destinations before the electronics reach unsafe temperatures. The long-range missiles must be cooled because of their long cruise times (several hours). The electronics in this case are cooled by passing the liquid fuel they carry through the cold plate of the electronics enclosure as it flows towards the combustion chamber.

15-31C Dynamic temperature is the rise in the temperature of a fluid as a result of the ramming effect or the stagnation process. This is due to the conversion of kinetic energy to internal energy which is significant at high velocities. It is determined from $T_{dynamic} = V^2 / (2c_p)$ where V is the velocity and c_p is the specific heat of the fluid. It is significant at velocities above 100 m/s.

15-32C The electronic equipment in ships and submarines are usually housed in rugged cabinets to protect them from vibrations and shock during stormy weather. Because of easy access to water, water cooled heat exchangers are commonly used to cool sea-born electronics. Often air in a closed or open loop is cooled in an air-to-water heat exchanger, and is forced to the electronic cabinet by a fan.

15-33C The electronics of communication systems operate for long periods of time under adverse conditions such as rain, snow, high winds, solar radiation, high altitude, high humidity, and too high or too low temperatures. Large communication systems are housed in specially built shelters. Sometimes it is necessary to air-condition these shelters to safely dissipate the large quantities of heat generated by the electronics of communication systems.

15-34C The electronic components used in the high power microwave equipment such as radars generate enormous amounts of heat because of the low conversion efficiency of electrical energy to microwave energy. The klystron tubes of high power radar systems where radio frequency (RF) energy is generated can yield local heat fluxes as high as 2000 W/cm^2 . The safe and reliable dissipation of such high heat fluxes usually require the immersion of such equipment into a suitable dielectric fluid which can remove large quantities of heat by boiling.

15-35C The electronic equipment in space vehicles are usually cooled by a liquid circulated through the components where heat is picked up, and then through a space radiator where the waste heat is radiated into deep space at 0 K. In such systems it may be necessary to run a fan in the box to circulate the air since there is no natural convection currents in space because of the absence of a gravity field.

15-36 An airplane cruising in the air at a temperature of -25°C at a velocity of 850 km/h is considered. The temperature rise of air is to be determined.

Assumptions Steady operating conditions exist.

Analysis The temperature rise of air (dynamic temperature) at this speed is

$$T_{dynamic} = \frac{V^2}{2c_p} = \frac{(850 \times 1000 / 3600 \text{ m/s})^2}{(2)(1003 \text{ J/kg}\cdot^\circ\text{C})} \left(\frac{1 \text{ J/kg}}{1 \text{ m}^2/\text{s}^2} \right) = \mathbf{27.8^\circ\text{C}}$$

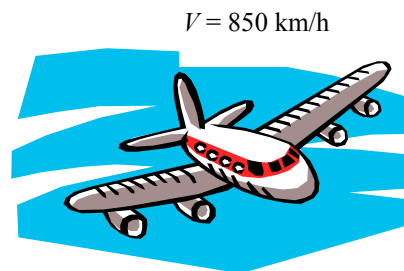

15-37 The temperature of air in the wind at a wind velocity of 90 km/h is measured to be 12°C . The true temperature of air is to be determined.

Assumptions Steady operating conditions exist.

Analysis The temperature rise of air (dynamic temperature) at this speed is

$$T_{dynamic} = \frac{V^2}{2c_p} = \frac{(90 \times 1000 / 3600 \text{ m/s})^2}{(2)(1005 \text{ J/kg}\cdot^\circ\text{C})} \left(\frac{1 \text{ J/kg}}{1 \text{ m}^2/\text{s}^2} \right) = \mathbf{0.3^\circ\text{C}}$$

Therefore, the true temperature of air is

$$T_{true} = T_{measured} - T_{dynamic} = (12 - 0.3)^\circ\text{C} = \mathbf{11.7^\circ\text{C}}$$

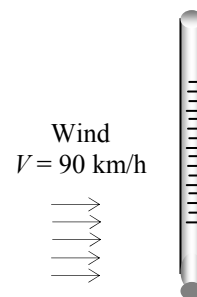

15-38 EES Prob. 15-37 is reconsidered. The true temperature of air as a function of the wind velocity is to be plotted.

Analysis The problem is solved using EES, and the solution is given below.

"GIVEN"

T_measured=12 [C]

Vel=90 [km/h]

"PROPERTIES"

C_p=CP(air, T=T_measured)*Convert(kJ/kg-C, J/kg-C)

"ANALYSIS"

T_dynamic=(Vel*Convert(km/h, m/s))^2/(2*C_p)*Convert(m^2/s^2, J/kg)

T_true=T_measured-T_dynamic

Vel [km/h]	T _{true} [C]
20	11.98
25	11.98
30	11.97
35	11.95
40	11.94
45	11.92
50	11.9
55	11.88
60	11.86
65	11.84
70	11.81
75	11.78
80	11.75
85	11.72
90	11.69
95	11.65
100	11.62
105	11.58
110	11.54
115	11.49
120	11.45

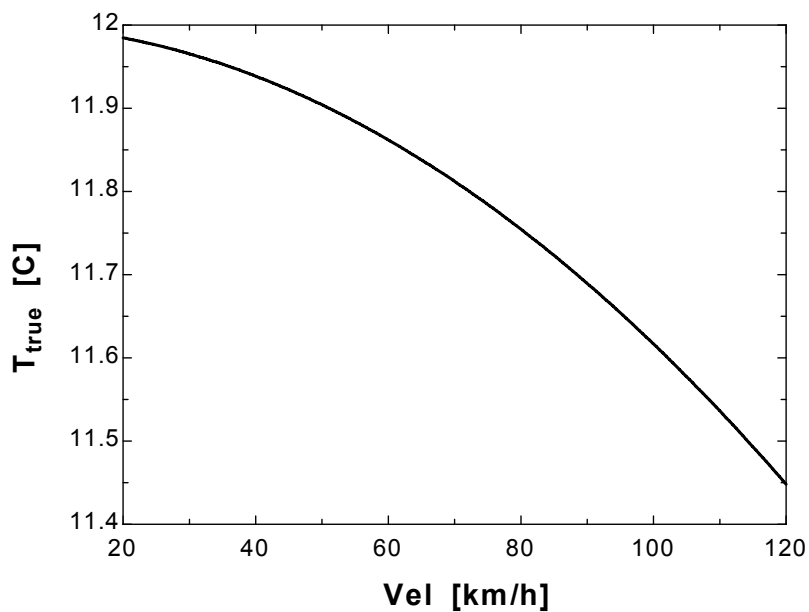

15-39 Air at 25°C is flowing in a channel. The temperature a stationary probe inserted into the channel will read is to be determined for different air velocities.

Assumptions Steady operating conditions exist.

Analysis (a) The temperature rise of air (dynamic temperature) for an air velocity of 1 m/s is

$$T_{dynamic} = \frac{V^2}{2c_p} = \frac{(1 \text{ m/s})^2}{(2)(1005 \text{ J/kg}\cdot^\circ\text{C})} \left(\frac{1 \text{ J/kg}}{1 \text{ m}^2/\text{s}^2} \right) = 0.0005^\circ\text{C}$$

Then the temperature which a stationary probe will read becomes

$$T_{measured} = T_{true} + T_{dynamic} = 25 + 0.0005 = \mathbf{25.0005^\circ\text{C}}$$

(b) For an air velocity of 10 m/s the temperature rise is

$$T_{dynamic} = \frac{V^2}{2c_p} = \frac{(10 \text{ m/s})^2}{(2)(1005 \text{ J/kg}\cdot^\circ\text{C})} \left(\frac{1 \text{ J/kg}}{1 \text{ m}^2/\text{s}^2} \right) = 0.05^\circ\text{C}$$

Then, $T_{measured} = T_{true} + T_{dynamic} = 25 + 0.05 = \mathbf{25.05^\circ\text{C}}$

(c) For an air velocity of 100 m/s the temperature rise is

$$T_{dynamic} = \frac{V^2}{2c_p} = \frac{(100 \text{ m/s})^2}{(2)(1005 \text{ J/kg}\cdot^\circ\text{C})} \left(\frac{1 \text{ J/kg}}{1 \text{ m}^2/\text{s}^2} \right) = 4.98^\circ\text{C}$$

Then, $T_{measured} = T_{true} + T_{dynamic} = 25 + 4.98 = \mathbf{29.98^\circ\text{C}}$

(d) For an air velocity of 1000 m/s the temperature rise is

$$T_{dynamic} = \frac{V^2}{2c_p} = \frac{(1000 \text{ m/s})^2}{(2)(1005 \text{ J/kg}\cdot^\circ\text{C})} \left(\frac{1 \text{ J/kg}}{1 \text{ m}^2/\text{s}^2} \right) = 497.5^\circ\text{C}$$

Then, $T_{measured} = T_{true} + T_{dynamic} = 25 + 497.5 = \mathbf{522.5^\circ\text{C}}$

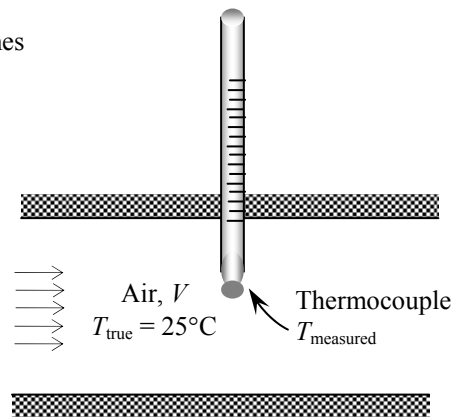

15-40 Power dissipated by an electronic device as well as its surface area and surface temperature are given. A suitable cooling technique for this device is to be determined.

Assumptions Steady operating conditions exist.

Analysis The heat flux on the surface of this electronic device is

$$\dot{q} = \frac{\dot{Q}}{A_s} = \frac{2 \text{ W}}{5 \text{ cm}^2} = \mathbf{0.4 \text{ W/cm}^2}$$

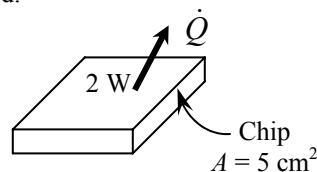

For an allowable temperature rise of 50°C, the suitable cooling technique for this device is determined from Fig. 15-17 to be **forced convection** with direct air.

15-41E Power dissipated by a circuit board as well as its surface area and surface temperature are given. A suitable cooling mechanism is to be selected.

Assumptions Steady operating conditions exist.

Analysis The heat flux on the surface of this electronic device is

$$\dot{q} = \frac{\dot{Q}}{A_s} = \frac{20 \text{ W}}{(6 \text{ in} \times 2.54 \text{ cm/in})(8 \text{ in} \times 2.54 \text{ cm/in})} = \mathbf{0.065 \text{ W/cm}^2}$$

For an allowable temperature rise of 80°F, the suitable cooling technique for this device is determined from Fig. 15-17 to be **natural convection** with direct air.

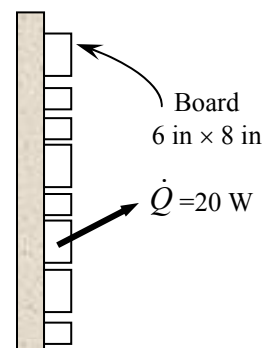

Conduction Cooling

15-42C The major considerations in the selection of a cooling technique are the magnitude of the heat generated, the reliability requirements, the environmental conditions, and the cost.

15-43C Thermal resistance is the resistance of a material or device against heat flow through it. It is analogous to electrical resistance in electrical circuits, and the thermal resistance networks can be analyzed like electrical circuits.

15-44C If the rate of heat conduction through a medium \dot{Q} , and the thermal resistance R of the medium are known, then the temperature difference across the medium can be determined from $\Delta T = \dot{Q}R$.

15-45C The voltage drop across the wire is determined from $\Delta V = IR$. The length of the wire is proportional to the electrical resistance [$R = L/(\rho A)$], which is proportional to the voltage drop. Therefore, doubling the wire length while the current I is held constant will double the voltage drop.

The temperature drop across the wire is determined from $\Delta T = \dot{Q}R$. The length of the wire is proportional to the thermal resistance [$R = L/(kA)$], which is proportional to the temperature drop. Therefore, doubling the wire length while the heat flow \dot{Q} is held constant will double the temperature drop.

15-46C A heat frame is a thick metal plate attached to a circuit board. It enhances heat transfer by providing a low resistance path for the heat flow from the circuit board to the heat sink. The thicker the heat frame, the lower the thermal resistance and thus the smaller the temperature difference between the center and the ends of the heat frame. The electronic components at the middle of a PCB operate at the highest temperature since they are furthest away from the heat sink.

15-47C Heat flow from the junction to the body of a chip is three-dimensional, but can be approximated as being one-dimensional by adding a constriction thermal resistance to the thermal resistance network. For a small heat generation area of diameter a on a considerably larger body, the constriction resistance is given by $R_{constriction} = 1/(2\sqrt{\pi ak})$ where k is the thermal conductivity of the larger body. The constriction resistance is analogous to a partially closed valve in fluid flow, and a sudden drop in the cross-sectional area of an wire in electric flow.

15-48C The junction-to-case thermal resistance of an electronic component is the overall thermal resistance of all parts of the electronic component between the junction and case. In practice, this value is determined experimentally. When the junction-to-case resistance, the power dissipation, and the case temperature are known, the junction temperature of a component is determined from

$$T_{junction} = T_{case} + \dot{Q}R_{junction-case}$$

15-49C The case-to-ambient thermal resistance of an electronic device is the total thermal resistance of all parts of the electronic device between its outer surface and the ambient. In practice, this value is determined experimentally. Usually, manufacturers list the total resistance between the junction and the ambient for devices they manufacture for various configurations and ambient conditions likely to be encountered. When the case-to-ambient resistance, the power dissipation, and the ambient temperature are known, the junction temperature of the device is determined from $T_{junction} = T_{ambient} + \dot{Q}R_{junction-ambient}$

15-50C The junction temperature in this case is determined from

$$T_{junction} = T_{ambient} + \dot{Q}(R_{junction-case} + R_{case-ambient}).$$

When $R_{junction-case} > R_{case-ambient}$, the case temperature will be closer to the ambient temperature.

15-51C The PCBs are made of electrically insulating materials such as glass-epoxy laminates which are poor conductors of heat. Therefore, the rate of heat conduction along a PCB is very low. Heat conduction from the mid parts of a PCB to its outer edges can be improved by attaching heat frames or clamping cold plates to it. Heat conduction across the thickness of the PCB can be improved by planting copper or aluminum pins across the thickness of the PCB to serve as thermal bridges.

15-52C The thermal expansion coefficients of aluminum and copper are about twice as large as that of the epoxy-glass. This large difference in the thermal expansion coefficients can cause warping on the PCBs if the epoxy and the metal are not bonded properly. Warping is a major concern because it decreases reliability. One way of avoiding warping is to use PCBs with components on both sides.

15-53C The thermal conduction module received a lot of attention from thermal designers because the thermal design was incorporated at the initial stages of electrical design. The TCM was different from previous chip designs in that it incorporated both electrical and thermal considerations in early stages of design. The cavity in the TCM is filled with helium (instead of air) because of its very high thermal conductivity (about six times that of air).

15-54 The dimensions and power dissipation of a chip are given. The junction temperature of the chip is to be determined.

Assumptions **1** Steady operating conditions exist. **2** Heat transfer through various components is one-dimensional. **3** Heat transfer through the air gap and the lid on top of the chip is negligible because of the very large thermal resistance involved along this path.

Analysis The various thermal resistances on the path of primary heat flow are

$$R_{constriction} = \frac{1}{2\sqrt{\pi}ak} = \frac{1}{2\sqrt{\pi}(0.5 \times 10^{-3} \text{ m})(120 \text{ W/m}\cdot\text{C})} = 4.7^\circ\text{C/W}$$

$$R_{chip} = \frac{L}{kA} = \frac{0.5 \times 10^{-3} \text{ m}}{(120 \text{ W/m}\cdot\text{C})(0.004 \times 0.004 \text{ m}^2)} = 0.26^\circ\text{C/W}$$

$$R_{bond} = \frac{L}{kA} = \frac{0.05 \times 10^{-3} \text{ m}}{(296 \text{ W/m}\cdot\text{C})(0.004 \times 0.004 \text{ m}^2)} = 0.011^\circ\text{C/W}$$

$$R_{lead\ frame} = \frac{L}{kA} = \frac{0.25 \times 10^{-3} \text{ m}}{(386 \text{ W/m}\cdot\text{C})(0.004 \times 0.004 \text{ m}^2)} = 0.04^\circ\text{C/W}$$

$$R_{plastic} = \frac{L}{kA} = \frac{0.3 \times 10^{-3} \text{ m}}{(1 \text{ W/m}\cdot\text{C})(18 \times 0.001 \times 0.00025 \text{ m}^2)} = 66.67^\circ\text{C/W}$$

$$R_{leads} = \frac{L}{kA} = \frac{6 \times 10^{-3} \text{ m}}{(386 \text{ W/m}\cdot\text{C})(18 \times 0.001 \times 0.00025 \text{ m}^2)} = 3.45^\circ\text{C/W}$$

Since all resistances are in series, the total thermal resistance between the junction and the leads is determined by simply adding them up

$$\begin{aligned} R_{total} &= R_{junction-lead} \\ &= R_{constriction} + R_{chip} + R_{bond} + R_{lead\ frame} + R_{plastic} + R_{leads} \\ &= 4.7 + 0.26 + 0.011 + 0.04 + 66.67 + 3.45 \\ &= 75.13^\circ\text{C/W} \end{aligned}$$

Knowing the junction-to-leads thermal resistance, the junction temperature is determined from

$$\dot{Q} = \frac{T_{junction} - T_{leads}}{R_{junction-case}}$$

$$T_{junction} = T_{leads} + \dot{Q}R_{junction-case} = 50^\circ\text{C} + (0.8 \text{ W})(75.13^\circ\text{C/W}) = \mathbf{110.1^\circ\text{C}}$$

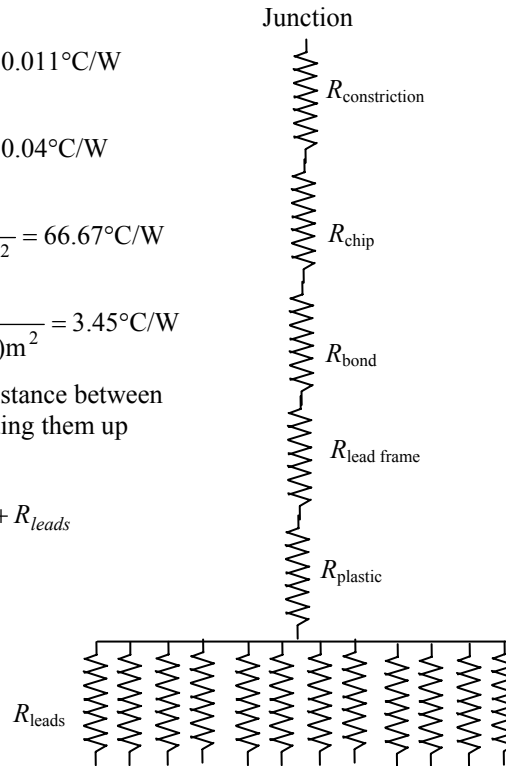

15-55 A plastic DIP with 16 leads is cooled by forced air. Using data supplied by the manufacturer, the junction temperature is to be determined.

Assumptions Steady operating conditions exist.

Analysis The junction-to-ambient thermal resistance of the device with 16 leads corresponding to an air velocity of 300 m/min is determined from Fig. 15-23 to be

$$R_{\text{junction-ambient}} = 50^\circ\text{C/W}$$

Then the junction temperature becomes

$$\dot{Q} = \frac{T_{\text{junction}} - T_{\text{ambient}}}{R_{\text{junction-ambient}}}$$

$$T_{\text{junction}} = T_{\text{ambient}} + \dot{Q}R_{\text{junction-ambient}} = 25^\circ\text{C} + (2 \text{ W})(50^\circ\text{C/W}) = \mathbf{125^\circ\text{C}}$$

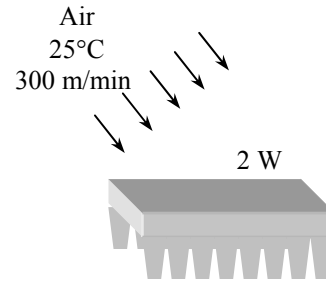

When the fan fails the total thermal resistance is determined from Fig. 15-23 by reading the value for zero air velocity (the intersection point of the curve with the vertical axis) to be

$$R_{\text{junction-ambient}} = 70^\circ\text{C/W}$$

which yields

$$\dot{Q} = \frac{T_{\text{junction}} - T_{\text{ambient}}}{R_{\text{junction-ambient}}}$$

$$T_{\text{junction}} = T_{\text{ambient}} + \dot{Q}R_{\text{junction-ambient}} = 25^\circ\text{C} + (2 \text{ W})(70^\circ\text{C/W}) = \mathbf{165^\circ\text{C}}$$

15-56 A PCB with copper cladding is given. The percentages of heat conduction along the copper and epoxy layers as well as the effective thermal conductivity of the PCB are to be determined.

Assumptions 1 Steady operating conditions exist. **2** Heat conduction along the PCB is one-dimensional since heat transfer from side surfaces is negligible. **3** The thermal properties of epoxy and copper layers are constant.

Analysis Heat conduction along a layer is proportional to the thermal conductivity-thickness product (kt) which is determined for each layer and the entire PCB to be

$$(kt)_{\text{copper}} = (386 \text{ W/m}\cdot^\circ\text{C})(0.06 \times 10^{-3} \text{ m}) = 0.02316 \text{ W}/^\circ\text{C}$$

$$(kt)_{\text{epoxy}} = (0.26 \text{ W/m}\cdot^\circ\text{C})(0.5 \times 10^{-3} \text{ m}) = 0.00013 \text{ W}/^\circ\text{C}$$

$$(kt)_{\text{PCB}} = (kt)_{\text{copper}} + (kt)_{\text{epoxy}} = 0.02316 + 0.00013 = 0.02329 \text{ W}/^\circ\text{C}$$

Therefore the percentages of heat conduction along the epoxy board are

$$f_{\text{epoxy}} = \frac{(kt)_{\text{epoxy}}}{(kt)_{\text{PCB}}} = \frac{0.00013 \text{ W}/^\circ\text{C}}{0.02329 \text{ W}/^\circ\text{C}} = 0.0056 \cong \mathbf{0.6\%}$$

and $f_{\text{copper}} = (100 - 0.6)\% = \mathbf{99.4\%}$

Then the effective thermal conductivity becomes

$$k_{\text{eff}} = \frac{(kt)_{\text{epoxy}} + (kt)_{\text{copper}}}{t_{\text{epoxy}} + t_{\text{copper}}} = \frac{(0.02316 + 0.00013) \text{ W}/^\circ\text{C}}{(0.06 + 0.5) \times 10^{-3} \text{ m}} = \mathbf{41.6 \text{ W/m}\cdot^\circ\text{C}}$$

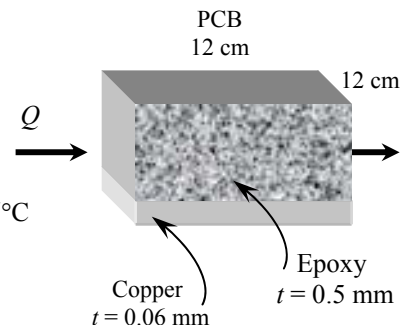

15-57 EES Prob. 15-56 is reconsidered. The effect of the thickness of the copper layer on the percentage of heat conducted along the copper layer and the effective thermal conductivity of the PCB is to be investigated.

Analysis The problem is solved using EES, and the solution is given below.

"GIVEN"

length=0.12 [m]
width=0.12 [m]
t_copper=0.06 [mm]
t_epoxy=0.5 [mm]
k_copper=386 [W/m-C]
k_epoxy=0.26 [W/m-C]

"ANALYSIS"

kt_copper=k_copper*t_copper*Convert(mm, m)
kt_epoxy=k_epoxy*t_epoxy*Convert(mm, m)
kt_PCB=kt_copper+kt_epoxy
f_copper=kt_copper/kt_PCB*Convert(, %)
f_epoxy=100-f_copper
k_eff=(kt_epoxy+kt_copper)/((t_epoxy+t_copper)*Convert(mm, m))

T _{copper} [mm]	f _{copper} [%]	k _{eff} [W/m-C]
0.02	98.34	15.1
0.025	98.67	18.63
0.03	98.89	22.09
0.035	99.05	25.5
0.04	99.17	28.83
0.045	99.26	32.11
0.05	99.33	35.33
0.055	99.39	38.49
0.06	99.44	41.59
0.065	99.48	44.64
0.07	99.52	47.63
0.075	99.55	50.57
0.08	99.58	53.47
0.085	99.61	56.31
0.09	99.63	59.1
0.095	99.65	61.85
0.1	99.66	64.55

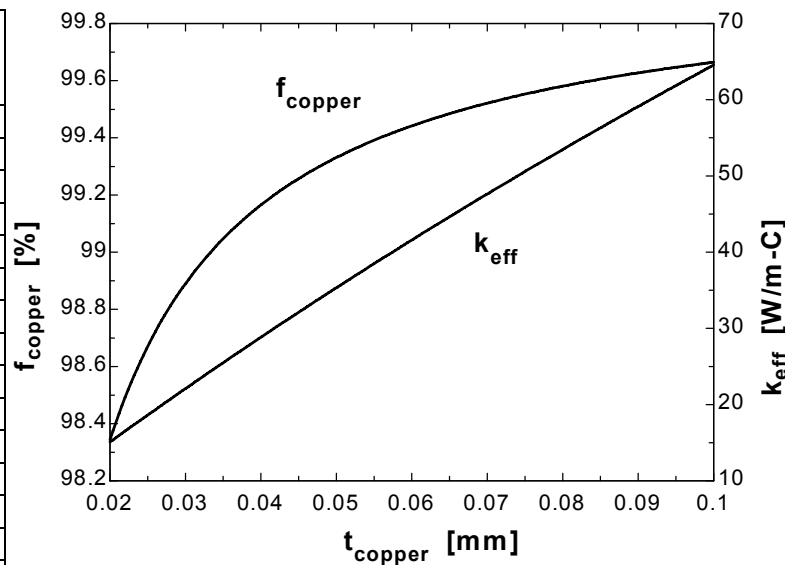

15-58 The heat generated in a silicon chip is conducted to a ceramic substrate to which it is attached. The temperature difference between the front and back surfaces of the chip is to be determined.

Assumptions 1 Steady operating conditions exist. 2 Heat conduction along the chip is one-dimensional.

Analysis The thermal resistance of silicon chip is

$$R_{chip} = \frac{L}{kA} = \frac{0.5 \times 10^{-3} \text{ m}}{(130 \text{ W/m}\cdot\text{°C})(0.006 \times 0.006 \text{ m}^2)} = 0.1068 \text{ °C/W}$$

Then the temperature difference across the chip becomes

$$\Delta T = \dot{Q}R_{chip} = (3 \text{ W})(0.1068 \text{ °C/W}) = \mathbf{0.32 \text{ °C}}$$

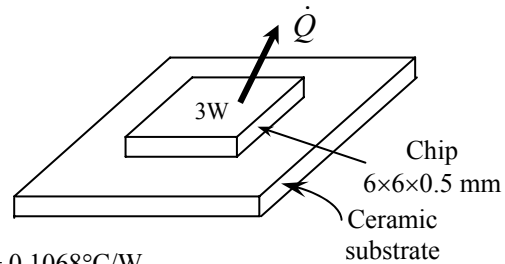

15-59E The dimensions of an epoxy glass laminate are given. The thermal resistances for heat flow along the layers and across the thickness are to be determined.

Assumptions 1 Heat conduction in the laminate is one-dimensional in either case. 2 Thermal properties of the laminate are constant.

Analysis The thermal resistances of the PCB along the 7 in long side and across its thickness are

$$\begin{aligned} R_{along} &= \frac{L}{kA} \\ (a) \quad &= \frac{(7/12) \text{ ft}}{(0.15 \text{ Btu/h}\cdot\text{ft}\cdot\text{°F})(6/12 \text{ ft})(0.05/12 \text{ ft})} \\ &= \mathbf{1867 \text{ h}\cdot\text{°F/Btu}} \end{aligned}$$

$$\begin{aligned} R_{across} &= \frac{L}{kA} \\ (b) \quad &= \frac{(0.05/12) \text{ ft}}{(0.15 \text{ Btu/h}\cdot\text{ft}\cdot\text{°F})(7/12 \text{ ft})(6/12 \text{ ft})} = \mathbf{0.095 \text{ h}\cdot\text{°F/Btu}} \end{aligned}$$

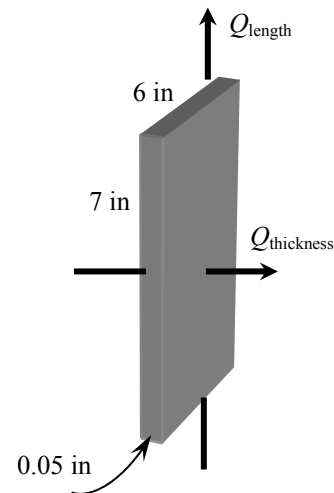

15-60 Cylindrical copper fillings are planted throughout an epoxy glass board. The thermal resistance of the board across its thickness is to be determined.

Assumptions 1 Heat conduction along the board is one-dimensional. **2** Thermal properties of the board are constant.

Analysis The number of copper fillings on the board is

$$n = \frac{\text{Area of board}}{\text{Area of one square}} = \frac{(150 \text{ mm})(180 \text{ mm})}{(3 \text{ mm})(3 \text{ mm})} = 3000$$

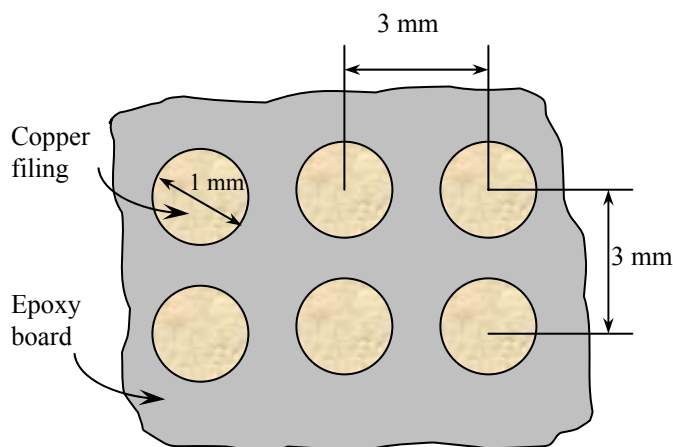

The surface areas of the copper fillings and the remaining part of the epoxy layer are

$$A_{copper} = n \frac{\pi D^2}{4} = (3000) \frac{\pi (0.001 \text{ m})^2}{4} = 0.002356 \text{ m}^2$$

$$A_{total} = (\text{length})(\text{width}) = (0.15 \text{ m})(0.18 \text{ m}) = 0.027 \text{ m}^2$$

$$A_{epoxy} = A_{total} - A_{copper} = 0.027 - 0.002356 = 0.024644 \text{ m}^2$$

The thermal resistance of each material is

$$R_{copper} = \frac{L}{kA} = \frac{0.0014 \text{ m}}{(386 \text{ W/m}\cdot\text{C})(0.002356 \text{ m}^2)} = 0.00154^\circ\text{C/W}$$

$$R_{epoxy} = \frac{L}{kA} = \frac{0.0014 \text{ m}}{(0.26 \text{ W/m}\cdot\text{C})(0.024644 \text{ m}^2)} = 0.2185^\circ\text{C/W}$$

Since these two resistances are in parallel, the equivalent thermal resistance of the entire board is

$$\frac{1}{R_{board}} = \frac{1}{R_{epoxy}} + \frac{1}{R_{copper}} = \frac{1}{0.2185^\circ\text{C/W}} + \frac{1}{0.00154^\circ\text{C/W}} \longrightarrow R_{board} = \mathbf{0.00153^\circ\text{C/W}}$$

15-61 EES Prob. 15-60 is reconsidered. The effects of the thermal conductivity and the diameter of the filling material on the thermal resistance of the epoxy board are to be investigated.

Analysis The problem is solved using EES, and the solution is given below.

"GIVEN"

length=0.18 [m]
width=0.15 [m]
k_epoxy=0.26 [W/m-C]
t_board=1.4/1000 [m]
k_filling=386 [W/m-C]
D_filling=1 [mm]
s=3/1000 [m]

"ANALYSIS"

A_board=length*width
n_filling=A_board/s^2
A_filling=n_filling*pi*(D_filling*Convert(mm, m))^2/4
A_epoxy=A_board-A_filling
R_filling=t_board/(k_filling*A_filling)
R_epoxy=t_board/(k_epoxy*A_epoxy)
1/R_board=1/R_epoxy+1/R_filling

k_{filling} [W/m-C]	R_{board} [C/W]
10	0.04671
29.5	0.01844
49	0.01149
68.5	0.008343
88	0.00655
107.5	0.005391
127	0.00458
146.5	0.003982
166	0.003522
185.5	0.003157
205	0.00286
224.5	0.002615
244	0.002408
263.5	0.002232
283	0.00208
302.5	0.001947
322	0.00183
341.5	0.001726
361	0.001634
380.5	0.00155
400	0.001475

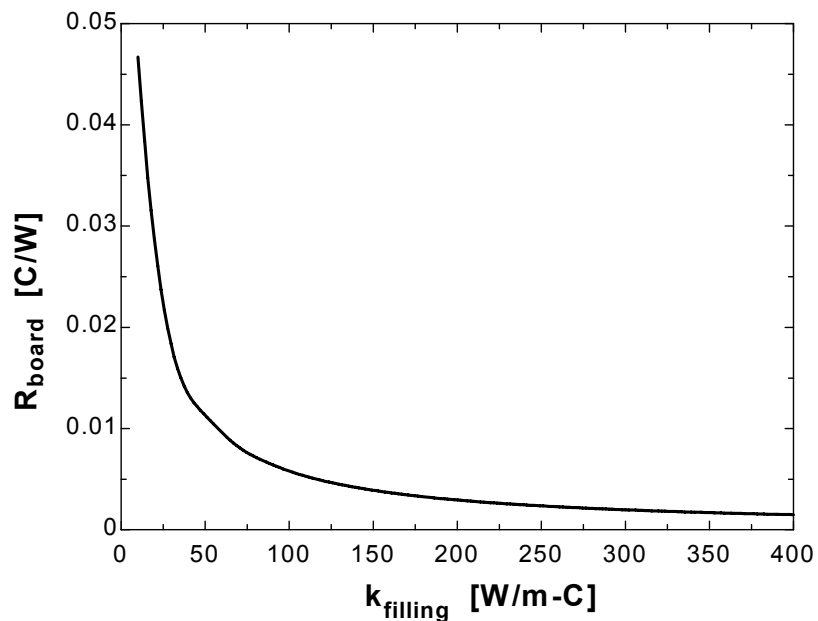

D_{filling} [mm]	R_{board} [C/W]
0.5	0.005977
0.6	0.004189
0.7	0.003095
0.8	0.002378
0.9	0.001884
1	0.001529
1.1	0.001265
1.2	0.001064
1.3	0.0009073
1.4	0.0007828
1.5	0.0006823
1.6	0.0005999
1.7	0.0005316
1.8	0.0004743
1.9	0.0004258
2	0.0003843

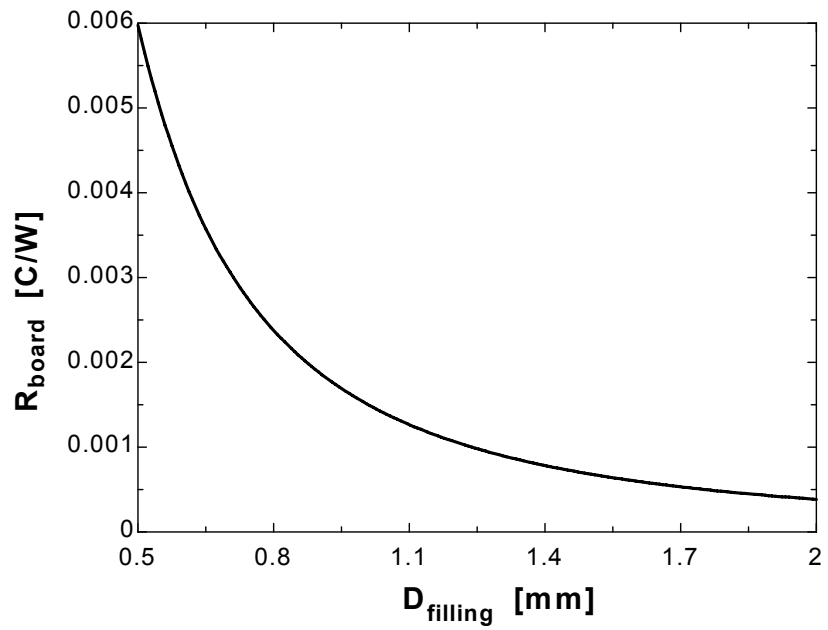

15-62 A circuit board with uniform heat generation is to be conduction cooled by a copper heat frame. Temperature distribution along the heat frame and the maximum temperature in the PCB are to be determined.

Assumptions 1 Steady operating conditions exist 2 Thermal properties are constant. 3 There is no direct heat dissipation from the surface of the PCB, and thus all the heat generated is conducted by the heat frame to the heat sink.

Analysis The properties and dimensions of various section of the PCB are summarized below as

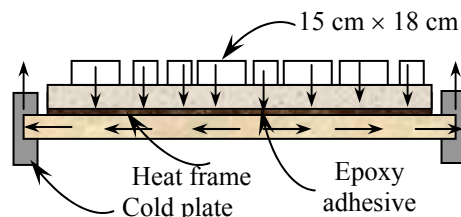

Section and material	Thermal conductivity	Thickness	Heat transfer surface area
Epoxy board	0.26 W/m.°C	2 mm	10 mm × 120 mm
Epoxy adhesive	1.8 W/m.°C	0.12 mm	10 mm × 120 mm
Copper heat frame (normal to frame)	386 W/m.°C	1.5 mm	10 mm × 120 mm
Copper heat frame (along the frame)	386 W/m.°C	10 mm	15 mm × 120 mm

Using the values in the table, the various thermal resistances are determined to be

$$R_{\text{epoxy}} = \frac{L}{kA} = \frac{0.002 \text{ m}}{(0.26 \text{ W/m.}^\circ\text{C})(0.01 \text{ m} \times 0.12 \text{ m})} = 6.41^\circ\text{C/W}$$

$$R_{\text{adhesive}} = \frac{L}{kA} = \frac{0.00012 \text{ m}}{(1.8 \text{ W/m.}^\circ\text{C})(0.01 \text{ m} \times 0.12 \text{ m})} = 0.056^\circ\text{C/W}$$

$$R_{\text{copper},\perp} = \frac{L}{kA} = \frac{0.0015 \text{ m}}{(386 \text{ W/m.}^\circ\text{C})(0.01 \text{ m} \times 0.12 \text{ m})} = 0.0032^\circ\text{C/W}$$

$$R_{\text{frame}} = R_{\text{copper},\text{parallel}} = \frac{L}{kA} = \frac{0.01 \text{ m}}{(386 \text{ W/m.}^\circ\text{C})(0.0015 \times 0.12 \text{ m})} = 0.144^\circ\text{C/W}$$

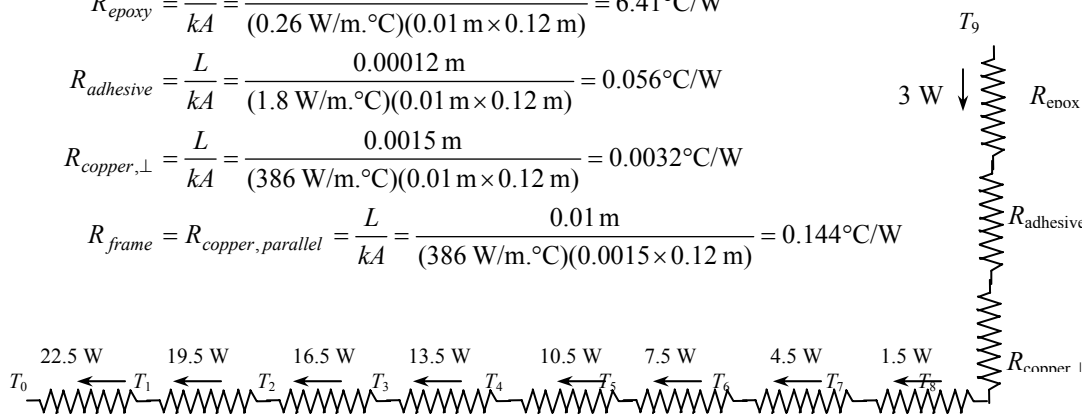

The combined resistance between the electronic components on each strip and the heat frame can be determined by adding the three thermal resistances in series to be

$$R_{\text{vertical}} = R_{\text{epoxy}} + R_{\text{adhesive}} + R_{\text{copper},\perp} = 6.41 + 0.056 + 0.0032 = 6.469^\circ\text{C/W}$$

The temperatures along the heat frame can be determined from the relation $\Delta T = T_{\text{high}} - T_{\text{low}} = \dot{Q}R$. Then,

$$T_1 = T_0 + \dot{Q}_{1-0}R_{1-0} = 30^\circ\text{C} + (22.5 \text{ W})(0.144^\circ\text{C/W}) = \mathbf{33.24^\circ\text{C}}$$

$$T_2 = T_1 + \dot{Q}_{2-1}R_{2-1} = 33.24^\circ\text{C} + (19.5 \text{ W})(0.144^\circ\text{C/W}) = \mathbf{36.05^\circ\text{C}}$$

$$T_3 = T_2 + \dot{Q}_{3-2}R_{3-2} = 36.05^\circ\text{C} + (16.5 \text{ W})(0.144^\circ\text{C/W}) = \mathbf{38.42^\circ\text{C}}$$

$$T_4 = T_3 + \dot{Q}_{4-3}R_{4-3} = 38.42^\circ\text{C} + (13.5 \text{ W})(0.144^\circ\text{C/W}) = \mathbf{40.36^\circ\text{C}}$$

$$T_5 = T_4 + \dot{Q}_{5-4}R_{5-4} = 40.36^\circ\text{C} + (10.5 \text{ W})(0.144^\circ\text{C/W}) = \mathbf{41.87^\circ\text{C}}$$

$$T_6 = T_5 + \dot{Q}_{6-5}R_{6-5} = 41.87^\circ\text{C} + (7.5 \text{ W})(0.144^\circ\text{C/W}) = \mathbf{42.95^\circ\text{C}}$$

$$T_7 = T_6 + \dot{Q}_{7-6}R_{7-6} = 42.95^\circ\text{C} + (4.5 \text{ W})(0.144^\circ\text{C/W}) = \mathbf{43.60^\circ\text{C}}$$

$$T_8 = T_7 + \dot{Q}_{8-7}R_{8-7} = 43.88^\circ\text{C} + (1.5 \text{ W})(0.144^\circ\text{C/W}) = \mathbf{43.81^\circ\text{C}}$$

The maximum surface temperature on the PCB is

$$T_{\text{max}} = T_9 = T_8 + \dot{Q}_{\text{vertical}}R_{\text{vertical}} = 43.81^\circ\text{C} + (3 \text{ W})(6.469^\circ\text{C/W}) = \mathbf{63.2^\circ\text{C}}$$

15-63 A circuit board with uniform heat generation is to be conduction cooled by aluminum wires inserted into it. The magnitude and location of the maximum temperature in the PCB is to be determined.

Assumptions 1 Steady operating conditions exist 2 Thermal properties are constant. 3 There is no direct heat dissipation from the surface of the PCB.

Analysis The number of wires in the board is

$$n = \frac{150 \text{ mm}}{2 \text{ mm}} = 75$$

The surface areas of the aluminum wires and the remaining part of the epoxy layer are

$$A_{aluminum} = n \frac{\pi D^2}{4} = (75) \frac{\pi (0.001 \text{ m})^2}{4} = 0.0000589 \text{ m}^2$$

$$A_{total} = (\text{length})(\text{width}) = (0.003 \text{ m})(0.15 \text{ m}) = 0.00045 \text{ m}^2$$

$$A_{epoxy} = A_{total} - A_{aluminum} = 0.00045 - 0.0000589 = 0.0003911 \text{ m}^2$$

Considering only half of the circuit board because of symmetry, the thermal resistance of each material per 1-cm length is determined to be

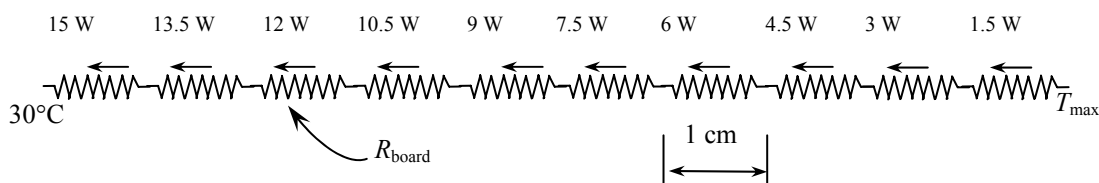
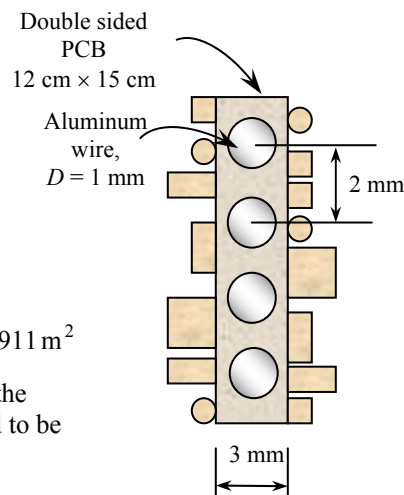

$$R_{aluminum} = \frac{L}{kA} = \frac{0.01 \text{ m}}{(237 \text{ W/m}\cdot\text{C})(0.0000589 \text{ m}^2)} = 0.716^\circ\text{C/W}$$

$$R_{epoxy} = \frac{L}{kA} = \frac{0.01 \text{ m}}{(0.26 \text{ W/m}\cdot\text{C})(0.0003911 \text{ m}^2)} = 98.34^\circ\text{C/W}$$

Since these two resistances are in parallel, the equivalent thermal resistance per cm is determined from

$$\frac{1}{R_{board}} = \frac{1}{R_{epoxy}} + \frac{1}{R_{aluminum}} = \frac{1}{0.716^\circ\text{C/W}} + \frac{1}{98.34^\circ\text{C/W}} \longrightarrow R_{board} = 0.711^\circ\text{C/W}$$

Maximum temperature occurs in the middle of the plate along the 20 cm length, which is determined to be

$$\begin{aligned} T_{max} &= T_{end} + \Delta T_{board, total} = T_{end} + \sum \dot{Q}_i R_{board, 1\text{-cm}} = T_{end} + R_{board, 1\text{-cm}} \sum \dot{Q}_i \\ &= 30^\circ\text{C} + (0.711^\circ\text{C/W})(15 + 13.5 + 12 + 10.5 + 9 + 7.5 + 6 + 4.5 + 3 + 1.5) \text{ W} = \mathbf{88.7^\circ\text{C}} \end{aligned}$$

15-64 A circuit board with uniform heat generation is to be conduction cooled by copper wires inserted in it. The magnitude and location of the maximum temperature in the PCB is to be determined.

Assumptions 1 Steady operating conditions exist 2 Thermal properties are constant. 3 There is no direct heat dissipation from the surface of the PCB.

Analysis The number of wires in the circuit board is

$$n = \frac{150 \text{ mm}}{2 \text{ mm}} = 75$$

The surface areas of the copper wires and the remaining part of the epoxy layer are

$$A_{copper} = n \frac{\pi D^2}{4} = (75) \frac{\pi (0.001 \text{ m})^2}{4} = 0.0000589 \text{ m}^2$$

$$A_{total} = (\text{length})(\text{width}) = (0.003 \text{ m})(0.15 \text{ m}) = 0.00045 \text{ m}^2$$

$$A_{epoxy} = A_{total} - A_{copper} = 0.00045 - 0.0000589 = 0.0003911 \text{ m}^2$$

Considering only half of the circuit board because of symmetry, the thermal resistance of each material per 1-cm length is determined to be

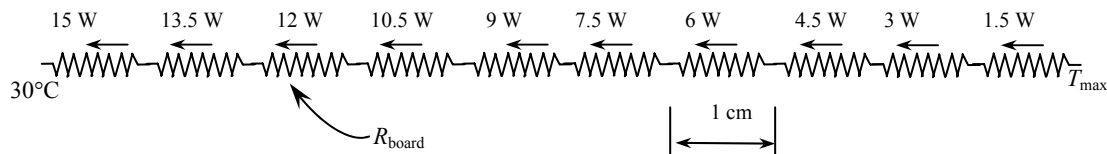
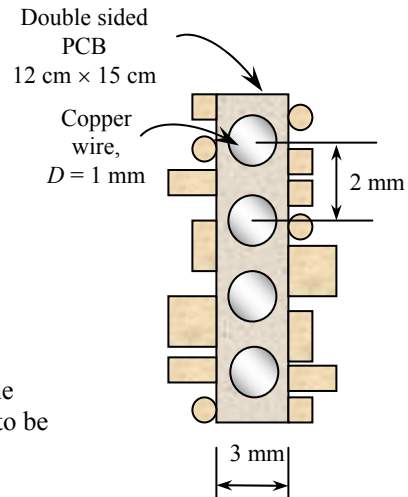

$$R_{copper} = \frac{L}{kA} = \frac{0.01 \text{ m}}{(386 \text{ W/m}\cdot\text{C})(0.0000589 \text{ m}^2)} = 0.440^\circ\text{C/W}$$

$$R_{epoxy} = \frac{L}{kA} = \frac{0.01 \text{ m}}{(0.26 \text{ W/m}\cdot\text{C})(0.0003911 \text{ m}^2)} = 98.34^\circ\text{C/W}$$

Since these two resistances are in parallel, the equivalent thermal resistance is determined from

$$\frac{1}{R_{board}} = \frac{1}{R_{epoxy}} + \frac{1}{R_{copper}} = \frac{1}{0.440^\circ\text{C/W}} + \frac{1}{98.34^\circ\text{C/W}} \longrightarrow R_{board} = 0.438^\circ\text{C/W}$$

Maximum temperature occurs in the middle of the plate along the 20 cm length which is determined to be

$$\begin{aligned} T_{max} &= T_{end} + \Delta T_{board, total} = T_{end} + \sum \dot{Q}_i R_{board, 1\text{-cm}} = T_{end} + R_{board, 1\text{-cm}} \sum \dot{Q}_i \\ &= 30^\circ\text{C} + (0.438^\circ\text{C/W})(15 + 13.5 + 12 + 10.5 + 9 + 7.5 + 6 + 4.5 + 3 + 1.5)\text{W} = \mathbf{66.1^\circ\text{C}} \end{aligned}$$

15-65 A circuit board with uniform heat generation is to be conduction cooled by aluminum wires inserted into it. The magnitude and location of the maximum temperature in the PCB is to be determined.

Assumptions 1 Steady operating conditions exist 2 Thermal properties are constant. 3 There is no direct heat dissipation from the surface of the PCB.

Analysis The number of wires in the board is

$$n = \frac{150 \text{ mm}}{4 \text{ mm}} = 37$$

The surface areas of the aluminum wires and the remaining part of the epoxy layer are

$$A_{aluminum} = n \frac{\pi D^2}{4} = (37) \frac{\pi (0.001 \text{ m})^2}{4} = 0.000029 \text{ m}^2$$

$$A_{total} = (\text{length})(\text{width}) = (0.003 \text{ m})(0.15 \text{ m}) = 0.00045 \text{ m}^2$$

$$A_{epoxy} = A_{total} - A_{aluminum} = 0.00045 - 0.000029 = 0.000421 \text{ m}^2$$

Considering only half of the circuit board because of symmetry, the thermal resistance of each material per 1-cm length is determined to be

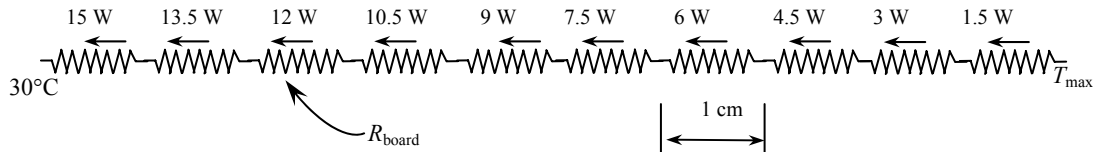
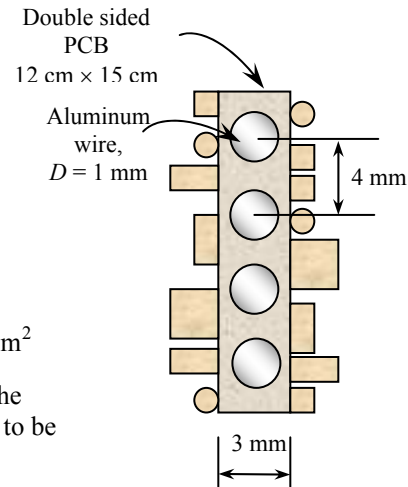

$$R_{aluminum} = \frac{L}{kA} = \frac{0.01 \text{ m}}{(237 \text{ W/m}\cdot\text{C})(0.000029 \text{ m}^2)} = 1.455^\circ\text{C/W}$$

$$R_{epoxy} = \frac{L}{kA} = \frac{0.01 \text{ m}}{(0.26 \text{ W/m}\cdot\text{C})(0.000421 \text{ m}^2)} = 91.36^\circ\text{C/W}$$

Since these two resistances are in parallel, the equivalent thermal resistance is determined from

$$\frac{1}{R_{board}} = \frac{1}{R_{epoxy}} + \frac{1}{R_{aluminum}} = \frac{1}{1.455^\circ\text{C/W}} + \frac{1}{91.36^\circ\text{C/W}} \longrightarrow R_{board} = 1.432^\circ\text{C/W}$$

Maximum temperature occurs in the middle of the plate along the 20 cm length which is determined to be

$$T_{max} = T_{end} + \Delta T_{board, total} = T_{end} + \sum \dot{Q}_i R_{board, 1\text{-cm}} = T_{end} + R_{board, 1\text{-cm}} \sum \dot{Q}_i \\ = 30^\circ\text{C} + (1.432^\circ\text{C/W})(15 + 13.5 + 12 + 10.5 + 9 + 7.5 + 6 + 4.5 + 3 + 1.5) \text{ W} = \mathbf{148.1^\circ\text{C}}$$

15-66 A thermal conduction module with 80 chips is cooled by water. The junction temperature of the chip is to be determined.

Assumptions 1 Steady operating conditions exist 2 Heat transfer through various components is one-dimensional.

Analysis The total thermal resistance between the junction and cooling water is

$$R_{total} = R_{junction-water} = R_{chip} + R_{internal} + R_{external} = 1.2 + 9 + 7 = 17.2^{\circ}\text{C}$$

Then the junction temperature becomes

$$T_{junction} = T_{water} + \dot{Q}R_{junction-water} = 18^{\circ}\text{C} + (4 \text{ W})(17.2^{\circ}\text{C/W}) = \mathbf{86.8^{\circ}\text{C}}$$

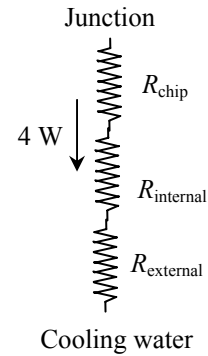

15-67 A layer of copper is attached to the back surface of an epoxy board. The effective thermal conductivity of the board and the fraction of heat conducted through copper are to be determined.

Assumptions 1 Steady operating conditions exist 2 Heat transfer is one-dimensional.

Analysis Heat conduction along a layer is proportional to the thermal conductivity-thickness product (kt) which is determined for each layer and the entire PCB to be

$$(kt)_{copper} = (386 \text{ W/m}\cdot^{\circ}\text{C})(0.0001 \text{ m}) = 0.0386 \text{ W}/^{\circ}\text{C}$$

$$(kt)_{epoxy} = (0.26 \text{ W/m}\cdot^{\circ}\text{C})(0.0003 \text{ m}) = 0.000078 \text{ W}/^{\circ}\text{C}$$

$$(kt)_{PCB} = (kt)_{copper} + (kt)_{epoxy} = 0.0386 + 0.000078 = 0.038678 \text{ W}/^{\circ}\text{C}$$

The effective thermal conductivity can be determined from

$$k_{eff} = \frac{(kt)_{epoxy} + (kt)_{copper}}{t_{epoxy} + t_{copper}} = \frac{(0.0386 + 0.000078) \text{ W}/^{\circ}\text{C}}{(0.0003 \text{ m} + 0.0001 \text{ m})} = \mathbf{96.7 \text{ W/m}\cdot^{\circ}\text{C}}$$

Then the fraction of the heat conducted along the copper becomes

$$f = \frac{(kt)_{copper}}{(kt)_{PCB}} = \frac{0.0386 \text{ W}/^{\circ}\text{C}}{0.038678 \text{ W}/^{\circ}\text{C}} = 0.998 = \mathbf{99.8\%}$$

Discussion Note that heat is transferred almost entirely through the copper layer.

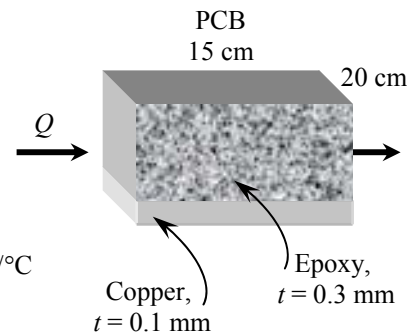

15-68 A copper plate is sandwiched between two epoxy boards. The effective thermal conductivity of the board and the fraction of heat conducted through copper are to be determined.

Assumptions 1 Steady operating conditions exist 2 Heat transfer is one-dimensional.

Analysis Heat conduction along a layer is proportional to the thermal conductivity-thickness product (kt) which is determined for each layer and the entire PCB to be

$$(kt)_{\text{copper}} = (386 \text{ W/m}\cdot\text{°C})(0.0005 \text{ m}) = 0.193 \text{ W/°C}$$

$$(kt)_{\text{epoxy}} = (2)(0.26 \text{ W/m}\cdot\text{°C})(0.003 \text{ m}) = 0.00156 \text{ W/°C}$$

$$(kt)_{\text{PCB}} = (kt)_{\text{copper}} + (kt)_{\text{epoxy}} = 0.193 + 0.00156 = 0.19456 \text{ W/°C}$$

The effective thermal conductivity can be determined from

$$k_{\text{eff}} = \frac{(kt)_{\text{epoxy}} + (kt)_{\text{copper}}}{t_{\text{epoxy}} + t_{\text{copper}}} = \frac{(0.00156 + 0.193) \text{ W/°C}}{[2(0.003 \text{ m}) + 0.0005 \text{ m}]} = \mathbf{29.9 \text{ W/m}\cdot\text{°C}}$$

Then the fraction of the heat conducted along the copper becomes

$$f = \frac{(kt)_{\text{copper}}}{(kt)_{\text{PCB}}} = \frac{0.193 \text{ W/°C}}{0.19456 \text{ W/°C}} = 0.992 = \mathbf{99.2\%}$$

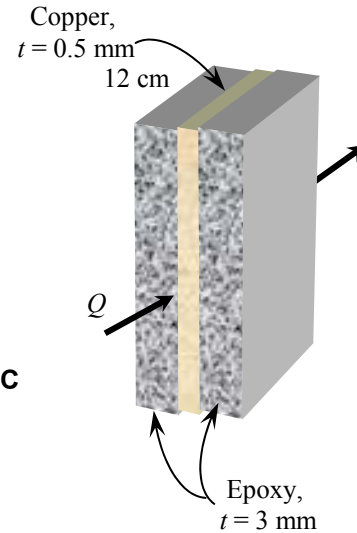

15-69E A copper heat frame is used to conduct heat generated in a PCB. The temperature difference between the mid section and either end of the heat frame is to be determined.

Assumptions 1 Steady operating conditions exist 2 Heat transfer is one-dimensional.

Analysis We assume heat is generated uniformly on the 6 in \times 8 in board, and all the heat generated is conducted by the heat frame along the 8-in side. Noting that the rate of heat transfer along the heat frame is variable, we consider 1 in \times 8 in strips of the board. The rate of heat generation in each strip is $(20 \text{ W})/8 = 2.5 \text{ W}$, and the thermal resistance along each strip of the heat frame is

$$\begin{aligned} R_{\text{frame}} &= \frac{L}{kA} \\ &= \frac{(1/12) \text{ ft}}{(223 \text{ Btu/h}\cdot\text{ft}\cdot\text{°F})(6/12 \text{ ft})(0.06/12 \text{ ft})} \\ &= 0.149 \text{ h}\cdot\text{°F/Btu} \end{aligned}$$

Maximum temperature occurs in the middle of the plate along the 20 cm length. Then the temperature difference between the mid section and either end of the heat frame becomes

$$\begin{aligned} \Delta T_{\text{max}} &= \Delta T_{\text{mid section - edge of frame}} = \sum \dot{Q}_i R_{\text{frame},1-\text{in}} = R_{\text{frame},1-\text{in}} \sum \dot{Q}_i \\ &= (0.149 \text{ h}\cdot\text{°F/Btu})(10 + 7.5 + 5 + 2.5 \text{ W})(3.4121 \text{ Btu/h}\cdot\text{W}) = \mathbf{12.8\text{°F}} \end{aligned}$$

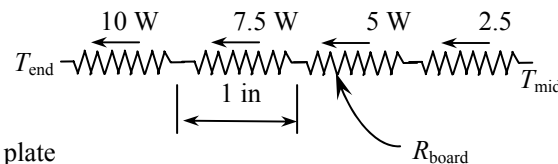
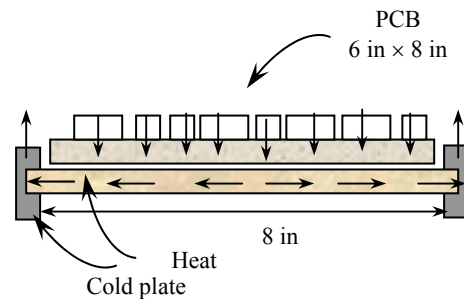

15-70 A power transistor is cooled by mounting it on an aluminum bracket that is attached to a liquid-cooled plate. The temperature of the transistor case is to be determined.

Assumptions 1 Steady operating conditions exist

2 Conduction heat transfer is one-dimensional.

Analysis The rate of heat transfer by conduction is

$$\dot{Q}_{conduction} = (0.80)(12 \text{ W}) = 9.6 \text{ W}$$

The thermal resistance of aluminum bracket and epoxy adhesive are

$$R_{aluminum} = \frac{L}{kA} = \frac{0.01 \text{ m}}{(237 \text{ W/m}\cdot\text{C})(0.003 \text{ m})(0.02 \text{ m})} = 0.703^\circ\text{C/W}$$

$$R_{epoxy} = \frac{L}{kA} = \frac{0.0002 \text{ m}}{(1.8 \text{ W/m}\cdot\text{C})(0.003 \text{ m})(0.02 \text{ m})} = 1.852^\circ\text{C/W}$$

The total thermal resistance between the transistor and the cold plate is

$$R_{total} = R_{case-cold\ plate} = R_{plastic} + R_{epoxy} + R_{aluminum} = 2.5 + 1.852 + 0.703 = 5.055^\circ\text{C/W}$$

Then the temperature of the transistor case is determined from

$$T_{case} = T_{cold\ plate} + \dot{Q}R_{case-cold\ plate} = 50^\circ\text{C} + (9.6 \text{ W})(5.055^\circ\text{C/W}) = \mathbf{98.5^\circ\text{C}}$$

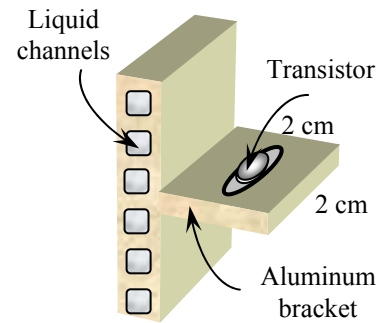

Air Cooling: Natural Convection and Radiation

15-71C As the student watches the movie, the temperature of the electronic components in the VCR will keep increasing because of the blocked air passages. The VCR eventually may overheat and fail.

15-72C There is no natural convection in space because of the absence of gravity (and because of the absence of a medium outside). However, it can be cooled by radiation since radiation does not need a medium.

15-73C The openings on the side surfaces of a TV, VCR or other electronic enclosures provide passage ways for the cold air to enter and warm air to leave. If a TV or VCR is enclosed in a cabinet with no free space around, and if there is no other cooling process involved, the temperature of device will keep rising due to the heat generation in device, which may cause the device to fail eventually.

15-74C The magnitude of radiation, in general, is comparable to the magnitude of natural convection. Therefore, radiation heat transfer should be always considered in the analysis of natural convection cooled electronic equipment.

15-75C The effect of atmospheric pressure to heat transfer coefficient can be written as

$h_{conv,P atm} = h_{conv,1 atm} \sqrt{P}$ (W/m²·°C) where P is the air pressure in atmosphere. Therefore, the greater the air pressure, the greater the heat transfer coefficient. The best and the worst orientation for heat transfer from a square surface are vertical and horizontal, respectively, since the former maximizes and the latter minimizes natural convection.

15-76C The view factor from surface 1 to surface 2 is the fraction of radiation which leaves surface 1 and strikes surface 2 directly. The magnitude of radiation heat transfer between two surfaces is proportional to the view factor. The larger the view factor, the larger the radiation exchange between the two surfaces.

15-77C Emissivity of a surface is the ratio of the radiation emitted by a surface at a specified temperature to the radiation emitted by a blackbody (which is the maximum amount) at the same temperature. The magnitude of radiation heat transfer between a surfaces and it surrounding surfaces is proportional to the emissivity. The larger the emissivity, the larger the radiation heat exchange between the two surfaces.

15-78C For most effective natural convection cooling of a PCB array, the PCB should be placed vertically to take advantage of natural convection currents which tend to rise naturally, and to minimize trapped air pockets. Placing the PCBs too close to each other tends to choke the flow because of the increased resistance. Therefore, the PCBs should be placed far from each other for effective heat transfer (A distance of about 2 cm between the PCBs turns out to be adequate for effective natural convection cooling.)

15-79C Radiation heat transfer from the components on the PCBs in an enclosure is negligible since the view of the components is largely blocked by other heat generating components at about the same temperature, and hot components face other hot surfaces instead of cooler surfaces.

15-80 The surface temperature of a sealed electronic box placed on top of a stand is not to exceed 65°C. It is to be determined if this box can be cooled by natural convection and radiation alone.

Assumptions 1 Steady operating conditions exist. 2 The local atmospheric pressure is 1 atm.

Analysis Using Table 15-1, the heat transfer coefficient and the natural convection heat transfer from side surfaces are determined to be

$$L = 0.2 \text{ m}$$

$$A_{side} = (2)(0.5 \text{ m} + 0.35 \text{ m})(0.2 \text{ m}) = 0.34 \text{ m}^2$$

$$h_{conv,side} = 1.42 \left(\frac{\Delta T}{L} \right)^{0.25} = 1.42 \left(\frac{65 - 30}{0.2} \right)^{0.25} = 5.16 \text{ W/m} \cdot \text{°C}$$

$$\begin{aligned} \dot{Q}_{conv,side} &= h_{conv,side} A_{side} (T_s - T_{fluid}) \\ &= (5.16 \text{ W/m} \cdot \text{°C})(0.34 \text{ m}^2)(65 - 30) \text{°C} = 61.5 \text{ W} \end{aligned}$$

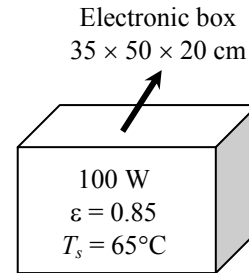

The heat transfer from the horizontal top surface by natural convection is

$$L = \frac{4A_{top}}{p} = \frac{4(0.5 \text{ m})(0.35 \text{ m})}{(2)(0.5 \text{ m} + 0.35 \text{ m})} = 0.41 \text{ m}$$

$$A_{top} = (0.5 \text{ m})(0.35 \text{ m}) = 0.175 \text{ m}^2$$

$$h_{conv,top} = 1.32 \left(\frac{\Delta T}{L} \right)^{0.25} = 1.32 \left(\frac{65 - 30}{0.41} \right)^{0.25} = 4.01 \text{ W/m} \cdot \text{°C}$$

$$\dot{Q}_{conv,top} = h_{conv,top} A_{top} (T_s - T_{fluid}) = (4.01 \text{ W/m} \cdot \text{°C})(0.175 \text{ m}^2)(65 - 30) \text{°C} = 24.6 \text{ W}$$

The rate of heat transfer from the box by radiation is determined from

$$\begin{aligned} \dot{Q}_{rad} &= \varepsilon A_s \sigma (T_s^4 - T_{surr}^4) \\ &= (0.85)(0.34 \text{ m}^2 + 0.175 \text{ m}^2)(5.67 \times 10^{-8} \text{ W/m}^2 \cdot \text{K}^4)[(65 + 273 \text{ K})^4 - (30 + 273 \text{ K})^4] = 114.7 \text{ W} \end{aligned}$$

Then the total rate of heat transfer from the box becomes

$$\dot{Q}_{total} = \dot{Q}_{conv,side} + \dot{Q}_{conv,top} + \dot{Q}_{rad} = 61.5 + 24.6 + 114.7 = \mathbf{200.8 \text{ W}}$$

which is greater than 100 W. Therefore, this box can be cooled by combined natural convection and radiation.

15-81 The surface temperature of a sealed electronic box placed on top of a stand is not to exceed 65°C. It is to be determined if this box can be cooled by natural convection and radiation alone.

Assumptions 1 Steady operating conditions exist. 2 The local atmospheric pressure is 1 atm.

Analysis In given orientation, two side surfaces and the top surface will be vertical and other two side surfaces will be horizontal. Using Table 15-1, the heat transfer coefficient and the natural convection heat transfer from the vertical surfaces are determined to be

$$L = 0.5 \text{ m}$$

$$A_{\text{vertical}} = (2 \times 0.2 \times 0.5 + 0.5 \times 0.35) = 0.375 \text{ m}^2$$

$$h_{\text{conv, vertical}} = 1.42 \left(\frac{\Delta T}{L} \right)^{0.25} = 1.42 \left(\frac{65 - 30}{0.5} \right)^{0.25} = 4.107 \text{ W/m} \cdot ^\circ\text{C}$$

$$\begin{aligned} \dot{Q}_{\text{conv, vertical}} &= h_{\text{conv, vertical}} A_{\text{vertical}} (T_s - T_{\text{fluid}}) \\ &= (4.107 \text{ W/m} \cdot ^\circ\text{C})(0.375 \text{ m}^2)(65 - 30)^\circ\text{C} = 53.9 \text{ W} \end{aligned}$$

The heat transfer from the horizontal top surface by natural convection is

$$A_{\text{top}} = (0.2 \text{ m})(0.35 \text{ m}) = 0.07 \text{ m}^2$$

$$L = \frac{4A_{\text{top}}}{p} = \frac{(4)(0.07 \text{ m}^2)}{(4)(0.2 \text{ m} + 0.35 \text{ m})} = 0.1273 \text{ m}$$

$$h_{\text{conv, top}} = 1.32 \left(\frac{\Delta T}{L} \right)^{0.25} = 1.32 \left(\frac{65 - 30}{0.1273} \right)^{0.25} = 5.4 \text{ W/m} \cdot ^\circ\text{C}$$

$$\dot{Q}_{\text{conv, top}} = h_{\text{conv, top}} A_{\text{top}} (T_s - T_{\text{fluid}}) = (5.4 \text{ W/m} \cdot ^\circ\text{C})(0.07 \text{ m}^2)(65 - 30)^\circ\text{C} = 13.2 \text{ W}$$

The heat transfer from the horizontal top surface by natural convection is

$$h_{\text{conv, bottom}} = 0.59 \left(\frac{\Delta T}{L} \right)^{0.25} = 0.59 \left(\frac{65 - 30}{0.1273} \right)^{0.25} = 2.4 \text{ W/m} \cdot ^\circ\text{C}$$

$$\dot{Q}_{\text{conv, bottom}} = h_{\text{conv, bottom}} A_{\text{bottom}} (T_s - T_{\text{fluid}}) = (2.4 \text{ W/m} \cdot ^\circ\text{C})(0.07 \text{ m}^2)(65 - 30)^\circ\text{C} = 5.9 \text{ W}$$

The rate of heat transfer from the box by radiation is determined from

$$\begin{aligned} \dot{Q}_{\text{rad}} &= \varepsilon A_s \sigma (T_s^4 - T_{\text{surr}}^4) \\ &= (0.85)(0.34 \text{ m}^2 + 0.175 \text{ m}^2)(5.67 \times 10^{-8} \text{ W/m}^2 \cdot \text{K}^4)[(65 + 273 \text{ K})^4 - (30 + 273 \text{ K})^4] = 114.7 \text{ W} \end{aligned}$$

Then the total rate of heat transfer from the box becomes

$$\dot{Q}_{\text{total}} = \dot{Q}_{\text{conv, vertical}} + \dot{Q}_{\text{conv, top}} + \dot{Q}_{\text{conv, bottom}} + \dot{Q}_{\text{rad}} = 53.9 + 13.2 + 5.9 + 114.7 = \mathbf{187.7 \text{ W}}$$

which is greater than 100 W. Therefore, this box can be cooled by combined natural convection and radiation.

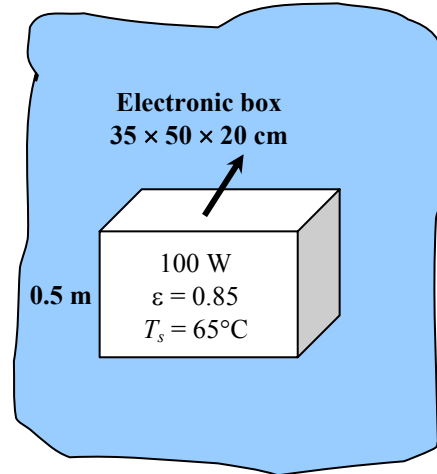

15-82E A small cylindrical resistor mounted on a PCB is being cooled by natural convection and radiation. The surface temperature of the resistor is to be determined.

Assumptions **1** Steady operating conditions exist. **2** The local atmospheric pressure is 1 atm. **3** Radiation is negligible in this case since the resistor is surrounded by surfaces which are at about the same temperature, and the radiation heat transfer between two surfaces at the same temperature is zero. This leaves natural convection as the only mechanism of heat transfer from the resistor.

Analysis For components on a circuit board, the heat transfer coefficient relation from Table 15-1 is

$$h_{conv} = 0.50 \left(\frac{T_s - T_{fluid}}{D} \right)^{0.25} \quad (L = D)$$

Substituting it into the heat transfer relation to get

$$\begin{aligned} \dot{Q}_{conv} &= h_{conv} A_s (T_s - T_{fluid}) \\ &= 0.50 \left(\frac{T_s - T_{fluid}}{D} \right)^{0.25} A_s (T_s - T_{fluid}) \\ &= 0.50 A_s \frac{(T_s - T_{fluid})^{1.25}}{D^{0.25}} \end{aligned}$$

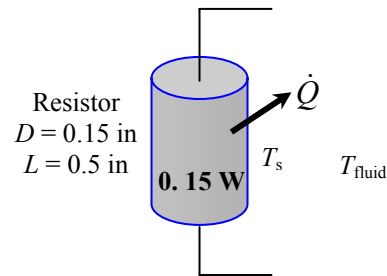

Calculating surface area and substituting it into above equation for the surface temperature yields

$$\begin{aligned} A_s &= 2 \left(\frac{\pi D^2}{4} \right) + \pi D L = 2 \left[\frac{\pi (0.15 / 12 \text{ ft})^2}{4} \right] + \pi (0.15 / 12 \text{ ft})(0.5 / 12 \text{ ft}) = 0.00188 \text{ ft}^2 \\ (0.15 \text{ W} \times 3.41214 \text{ Btu/h.W}) &= (0.50)(0.00188 \text{ ft}^2) \frac{(T_s - 130)^{1.25}}{(0.15 / 12 \text{ ft})^{0.25}} \longrightarrow T_s = \mathbf{194^\circ\text{F}} \end{aligned}$$

15-83 The surface temperature of a PCB is not to exceed 90°C. The maximum environment temperatures for safe operation at sea level and at 3,000 m altitude are to be determined.

Assumptions 1 Steady operating conditions exist. 2 Radiation heat transfer is negligible since the PCB is surrounded by other PCBs at about the same temperature. 3 Heat transfer from the back surface of the PCB will be very small and thus negligible.

Analysis Using the simplified relation for a vertical orientation from Table 15-1, the natural convection heat transfer coefficient is determined to be

$$h_{conv} = 1.42 \left(\frac{T_s - T_{fluid}}{L} \right)^{0.25}$$

Substituting it into the heat transfer relation to get

$$\begin{aligned} \dot{Q}_{conv} &= h_{conv} A_s (T_s - T_{fluid}) \\ &= 1.42 \left(\frac{T_s - T_{fluid}}{L} \right)^{0.25} A_s (T_s - T_{fluid}) \\ &= 1.42 A_s \frac{(T_s - T_{fluid})^{1.25}}{L^{0.25}} \end{aligned}$$

Calculating surface area and characteristic length and substituting them into above equation for the surface temperature yields

$$\begin{aligned} L &= 0.14 \text{ m} \\ A_s &= (0.14 \text{ m})(0.2 \text{ m}) = 0.028 \text{ m}^2 \\ 5 \text{ W} &= (1.42)(0.028 \text{ m}^2) \frac{(90 - T_{fluid})^{1.25}}{(0.14 \text{ m})^{0.25}} \longrightarrow T_{fluid} = \mathbf{57.7^\circ\text{C}} \end{aligned}$$

At an altitude of 3000 m, the atmospheric pressure is 70.12 kPa which is equivalent to

$$P = (70.12 \text{ kPa}) \frac{1 \text{ atm}}{101.325 \text{ kPa}} = 0.692 \text{ atm}$$

Modifying the heat transfer relation for this pressure (by multiplying by the square root of it) yields

$$5 \text{ W} = (1.42)(0.028 \text{ m}^2) \frac{(90 - T_{fluid})^{1.25}}{(0.14 \text{ m})^{0.25}} \sqrt{0.692} \longrightarrow T_{fluid} = \mathbf{52.6^\circ\text{C}}$$

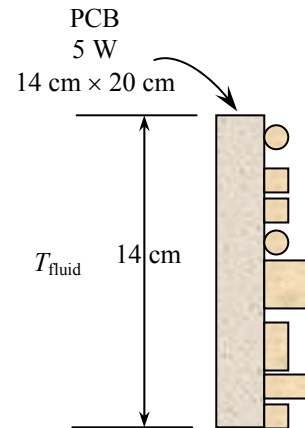

15-84 A cylindrical electronic component is mounted on a board with its axis in the vertical direction. The average surface temperature of the component is to be determined.

Assumptions 1 Steady operating conditions exist. **2** The local atmospheric pressure is 1 atm.

Analysis The natural convection heat transfer coefficient for vertical orientation using Table 15-1 can be determined from

$$h_{conv} = 1.42 \left(\frac{T_s - T_{fluid}}{L} \right)^{0.25}$$

Substituting it into the heat transfer relation gives

$$\begin{aligned} \dot{Q}_{conv} &= h_{conv} A_s (T_s - T_{fluid}) \\ &= 1.42 \left(\frac{T_s - T_{fluid}}{L} \right)^{0.25} A_s (T_s - T_{fluid}) \\ &= 1.42 A_s \frac{(T_s - T_{fluid})^{1.25}}{L^{0.25}} \end{aligned}$$

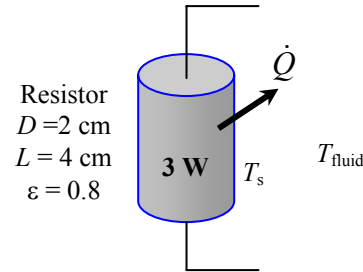

The rate of heat transfer from the cylinder by radiation is

$$\dot{Q}_{rad} = \varepsilon A_s \sigma (T_s^4 - T_{surr}^4)$$

Then the total rate of heat transfer can be written as

$$\dot{Q}_{total} = \dot{Q}_{conv} + \dot{Q}_{rad} = 1.42 A_s \frac{(T_s - T_{fluid})^{1.25}}{L^{0.25}} + \varepsilon A_s \sigma (T_s^4 - T_{surr}^4)$$

We will calculate total surface area of the cylindrical component including top and bottom surfaces, and assume the natural heat transfer coefficient to be the same throughout all surfaces of the component

$$A_s = 2 \left(\frac{\pi D^2}{4} \right) + \pi D L = 2 \left[\frac{\pi (0.02 \text{ m})^2}{4} \right] + \pi (0.02 \text{ m})(0.04 \text{ m}) = 0.00314 \text{ m}^2$$

Substituting

$$\begin{aligned} 3 \text{ W} &= (1.42)(0.00314 \text{ m}^2) \frac{[T_s - (30 + 273 \text{ K})]^{1.25}}{(0.04 \text{ m})^{0.25}} \\ &\quad + (0.8)(0.00314 \text{ m}^2)(5.67 \times 10^{-8} \text{ W/m}^2 \text{ K}^4)[T_s^4 - (20 + 273 \text{ K})^4] \end{aligned}$$

Solving for the surface temperature gives

$$T_s = 363 \text{ K} = \mathbf{90^\circ \text{C}}$$

15-85 A cylindrical electronic component is mounted on a board with its axis in horizontal direction. The average surface temperature of the component is to be determined.

Assumptions 1 Steady operating conditions exist. **2** The local atmospheric pressure is 1 atm.

Analysis Since atmospheric pressure is not given, we assume it to be 1 atm. The natural convection heat transfer coefficient for horizontal orientation using Table 15-1 can be determined from

$$h_{conv} = 1.32 \left(\frac{T_s - T_{fluid}}{D} \right)^{0.25}$$

Substituting it into the heat transfer relation to get

$$\begin{aligned} \dot{Q}_{conv} &= h_{conv} A_s (T_s - T_{fluid}) \\ &= 1.32 \left(\frac{T_s - T_{fluid}}{D} \right)^{0.25} A_s (T_s - T_{fluid}) \\ &= 1.32 A_s \frac{(T_s - T_{fluid})^{1.25}}{D^{0.25}} \end{aligned}$$

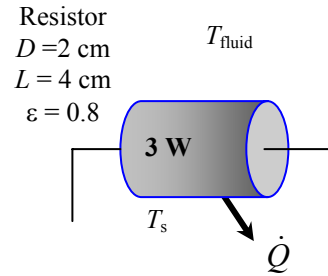

The rate of heat transfer from the cylinder by radiation is

$$\dot{Q}_{rad} = \varepsilon A_s \sigma (T_s^4 - T_{surr}^4)$$

Then the total heat transfer can be written as

$$\dot{Q}_{total} = \dot{Q}_{conv} + \dot{Q}_{rad} = 1.32 A_s \frac{(T_s - T_{fluid})^{1.25}}{D^{0.25}} + \varepsilon A_s \sigma (T_s^4 - T_{surr}^4)$$

We will calculate total surface area of the cylindrical component including top and bottom surfaces, and assume the natural heat transfer coefficient to be the same throughout all surfaces of the component

$$A_s = 2 \left(\frac{\pi D^2}{4} \right) + \pi D L = 2 \left[\frac{\pi (0.02 \text{ m})^2}{4} \right] + \pi (0.02 \text{ m})(0.04 \text{ m}) = 0.00314 \text{ m}^2$$

Substituting,

$$\begin{aligned} 3 \text{ W} &= (1.32)(0.00314 \text{ m}^2) \frac{[T_s - (30 + 273) \text{ K}]^{1.25}}{(0.02 \text{ m})^{0.25}} \\ &\quad + (0.8)(0.00314 \text{ m}^2)(5.67 \times 10^{-8} \text{ W/m}^2 \text{ K}^4)[T_s^4 - (20 + 273 \text{ K})^4] \end{aligned}$$

Solving for the surface temperature gives

$$T_s = 361 \text{ K} = \mathbf{88^\circ \text{C}}$$

15-86 EES Prob. 15-84 is reconsidered. The effects of surface emissivity and ambient temperature on the average surface temperature of the component are to be investigated.

Analysis The problem is solved using EES, and the solution is given below.

"GIVEN"

$$D=0.02 \text{ [m]}$$

$$L=0.04 \text{ [m]}$$

$$Q_{\text{dot}}=3 \text{ [W]}$$

$$\text{epsilon}=0.8$$

$$T_{\text{ambient}}=30+273 \text{ [K]}$$

$$T_{\text{surr}}=T_{\text{ambient}}-10$$

"ANALYSIS"

$$Q_{\text{dot}}=Q_{\text{dot_conv}}+Q_{\text{dot_rad}}$$

$$Q_{\text{dot_conv}}=h*A*(T_s-T_{\text{ambient}})$$

$$h=1.42*((T_s-T_{\text{ambient}})/L)^{0.25}$$

$$A=2*(\pi*D^2)/4+\pi*D*L$$

$$Q_{\text{dot_rad}}=\text{epsilon}*A*\sigma*(T_s^4-T_{\text{surr}}^4)$$

$$\sigma=5.67\text{E-}8 \text{ [W/m}^2\text{-K}^4\text{]}$$

ϵ	T_s [K]
0.1	391.6
0.15	388.4
0.2	385.4
0.25	382.6
0.3	380.1
0.35	377.7
0.4	375.5
0.45	373.4
0.5	371.4
0.55	369.5
0.6	367.8
0.65	366.1
0.7	364.5
0.75	363
0.8	361.5
0.85	360.2
0.9	358.9
0.95	357.6
1	356.4

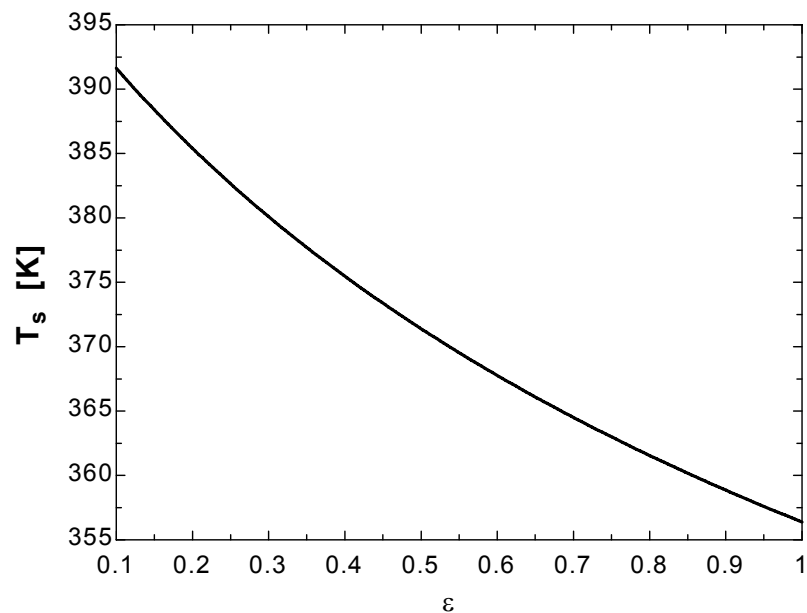

T_{ambient} [K]	T_s [K]
288	349.6
289	350.4
290	351.2
291	352
292	352.8
293	353.6
294	354.4
295	355.2
296	356
297	356.8
298	357.6
299	358.4
300	359.2
301	360
302	360.7
303	361.5
304	362.3
305	363.1
306	363.9
307	364.7
308	365.5

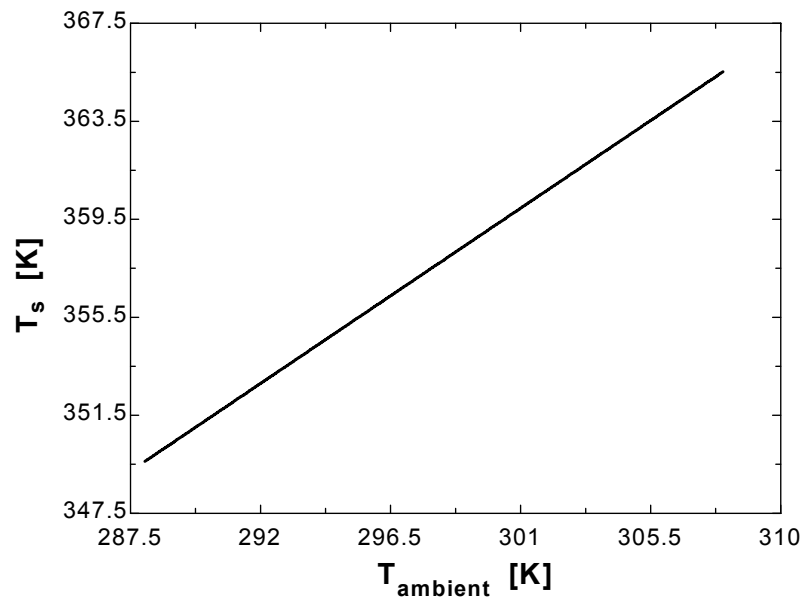

15-87 A power transistor dissipating 0.1 W of power is considered. The heat flux on the surface of the transistor and the surface temperature of the transistor are to be determined.

Assumptions 1 Steady operating conditions exist. 2 Heat is transferred uniformly from all surfaces of the transistor.

Analysis (a) The heat flux on the surface of the transistor is

$$\begin{aligned}
 A_s &= 2\left(\frac{\pi D^2}{4}\right) + \pi DL \\
 &= 2\left[\frac{\pi(0.4 \text{ cm})^2}{4}\right] + \pi(0.4 \text{ cm})(0.4 \text{ cm}) = 0.754 \text{ cm}^2 \\
 \dot{q} &= \frac{\dot{Q}}{A_s} = \frac{0.1 \text{ W}}{0.754 \text{ cm}^2} = 0.1326 \text{ W/cm}^2
 \end{aligned}$$

(b) The surface temperature of the transistor is determined from Newton's law of cooling to be

$$\begin{aligned}
 \dot{q} &= h_{\text{combined}}(T_s - T_{\text{fluid}}) \\
 T_s &= T_{\text{fluid}} + \frac{\dot{q}}{h_{\text{combined}}} = 30^\circ\text{C} + \frac{1326 \text{ W/m}^2}{18 \text{ W/m}^2 \cdot ^\circ\text{C}} = \mathbf{103.7^\circ\text{C}}
 \end{aligned}$$

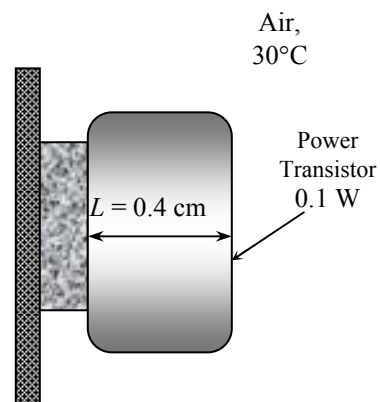

15-88 The components of an electronic equipment located in a horizontal duct with rectangular cross-section are cooled by forced air. The heat transfer from the outer surfaces of the duct by natural convection and the average temperature of the duct are to be determined.

Assumptions 1 Steady operating conditions exist. **2** Radiation heat transfer from the outer surfaces is negligible.

Analysis (a) Using air properties at 300 K and 1 atm, the mass flow rate of air and the heat transfer rate by forced convection are determined to be

$$\dot{m} = \rho \dot{V} = (1.177 \text{ kg/m}^3)(0.4 / 60 \text{ m}^3/\text{s}) = 0.00785 \text{ kg/s}$$

$$\dot{Q}_{\text{forced convection}} = \dot{m} c_p \Delta T = (0.00785 \text{ kg/s})(1005 \text{ J/kg} \cdot \text{C})(45 - 30)^\circ\text{C} = 118.3 \text{ W}$$

Noting that radiation heat transfer is negligible, the rest of the 150 W heat generated must be dissipated by natural convection,

$$\dot{Q}_{\text{natural convection}} = \dot{Q}_{\text{total}} - \dot{Q}_{\text{forced convection}} = 150 - 118.3 = \mathbf{31.7 \text{ W}}$$

(b) The natural convection heat transfer from the vertical side surfaces of the duct is

$$A_{\text{side}} = 2 \times (0.15 \text{ m})(1 \text{ m}) = 0.3 \text{ m}^2$$

$$h_{\text{conv,side}} = 1.42 \left(\frac{\Delta T}{L} \right)^{0.25}$$

$$\dot{Q}_{\text{conv,side}} = h_{\text{conv,side}} A_{\text{side}} (T_s - T_{\text{fluid}}) = 1.42 \left(\frac{T_s - T_{\text{fluid}}}{L} \right)^{0.25} A_{\text{side}} (T_s - T_{\text{fluid}}) = 1.42 A_{\text{side}} \frac{(T_s - T_{\text{fluid}})^{1.25}}{L^{0.25}}$$

Natural convection from the top and bottom surfaces of the duct is

$$L = \frac{4A_{\text{top}}}{p} = \frac{(4)(0.15 \text{ m})(1 \text{ m})}{(2)(0.15 \text{ m} + 1 \text{ m})} = 0.26 \text{ m}, \quad A_{\text{top}} = (0.15 \text{ m})(1 \text{ m}) = 0.15 \text{ m}^2$$

$$h_{\text{conv,top}} = 1.32 \left(\frac{\Delta T}{L} \right)^{0.25}$$

$$\dot{Q}_{\text{conv,top}} = h_{\text{conv,top}} A_{\text{top}} (T_s - T_{\text{fluid}})$$

$$= 1.32 \left(\frac{T_s - T_{\text{fluid}}}{L} \right)^{0.25} A_{\text{top}} (T_s - T_{\text{fluid}}) = 1.32 A_{\text{top}} \frac{(T_s - T_{\text{fluid}})^{1.25}}{L^{0.25}}$$

$$h_{\text{conv,bottom}} = 0.59 \left(\frac{\Delta T}{L} \right)^{0.25}$$

$$\dot{Q}_{\text{conv,bottom}} = h_{\text{conv,bot}} A_{\text{top}} (T_s - T_{\text{fluid}})$$

$$= 0.59 \left(\frac{T_s - T_{\text{fluid}}}{L} \right)^{0.25} A_{\text{bot}} (T_s - T_{\text{fluid}}) = 0.59 A_{\text{bot}} \frac{(T_s - T_{\text{fluid}})^{1.25}}{L^{0.25}}$$

Then the total heat transfer by natural convection becomes

$$\dot{Q}_{\text{total,conv}} = \dot{Q}_{\text{conv,side}} + \dot{Q}_{\text{conv,top}} + \dot{Q}_{\text{conv,bottom}}$$

$$\dot{Q}_{\text{total,conv}} = 1.42 A_{\text{side}} \frac{(T_s - T_{\text{fluid}})^{1.25}}{L^{0.25}} + 1.32 A_{\text{top}} \frac{(T_s - T_{\text{fluid}})^{1.25}}{L^{0.25}} + 0.59 A_{\text{bottom}} \frac{(T_s - T_{\text{fluid}})^{1.25}}{L^{0.25}}$$

Substituting all known quantities with proper units gives the average temperature of the duct to be

$$31.7 = (1.42)(0.3) \frac{(T_s - 25)^{1.25}}{0.15^{0.25}} + (1.32)(0.15) \frac{(T_s - 25)^{1.25}}{0.26^{0.25}} + (0.59)(0.15) \frac{(T_s - 25)^{1.25}}{0.26^{0.25}}$$

$$31.7 = (1.086)(T_s - 25)^{1.25} \longrightarrow T_s = \mathbf{40^\circ\text{C}}$$

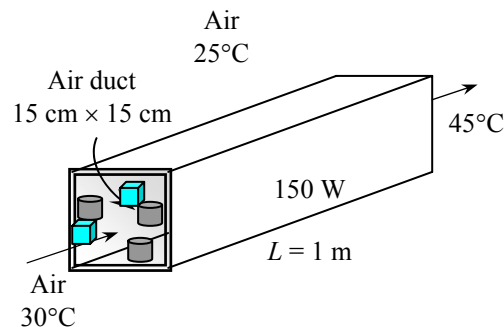

15-89 The components of an electronic equipment located in a circular horizontal duct are cooled by forced air. The heat transfer from the outer surfaces of the duct by natural convection and the average temperature of the duct are to be determined.

Assumptions 1 Steady operating conditions exist. 2 Radiation heat transfer from the outer surfaces is negligible.

Analysis (a) Using air properties at 300 K and 1 atm, the mass flow rate of air and the heat transfer rate by forced convection are determined to be

$$\dot{m} = \rho \dot{V} = (1.177 \text{ kg/m}^3)(0.4 / 60 \text{ m}^3/\text{s}) = 0.00785 \text{ kg/s}$$

$$\dot{Q}_{\text{forced convection}} = \dot{m} c_p \Delta T = (0.00785 \text{ kg/s})(1005 \text{ J/kg} \cdot ^\circ\text{C})(45 - 30)^\circ\text{C} = 118.3 \text{ W}$$

Noting that radiation heat transfer is negligible, the rest of the 150 W heat generated must be dissipated by natural convection,

$$\dot{Q}_{\text{natural convection}} = \dot{Q}_{\text{total}} - \dot{Q}_{\text{forced convection}} = 150 - 118.3 = \mathbf{31.7 \text{ W}}$$

(b) The natural convection heat transfer from the circular duct is

$$L = D = 0.1 \text{ m}$$

$$A_s = 2 \left(\frac{\pi D^2}{4} \right) + \pi DL = 2 \left[\frac{\pi (0.1 \text{ m})^2}{4} \right] + \pi (0.1 \text{ m})(1 \text{ m}) = 0.33 \text{ m}^2$$

$$h_{\text{conv}} = 1.32 \left(\frac{\Delta T}{D} \right)^{0.25}$$

$$\dot{Q}_{\text{conv}} = h_{\text{conv}} A_s (T_s - T_{\text{fluid}}) = 1.32 \left(\frac{(T_s - T_{\text{fluid}})}{D} \right)^{0.25} A_s (T_s - T_{\text{fluid}})$$

$$= 1.32 A_s \frac{(T_s - T_{\text{fluid}})^{1.25}}{D^{0.25}}$$

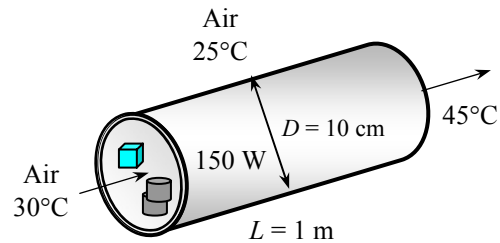

Substituting all known quantities with proper units gives the average temperature of the duct to be

$$31.7 \text{ W} = (1.32)(0.33 \text{ m}^2) \frac{(T_s - 25)^{1.25}}{(0.1 \text{ m})^{0.25}} \longrightarrow T_s = \mathbf{44^\circ\text{C}}$$

15-90 EES Prob. 15-88 is reconsidered. The effects of the volume flow rate of air and the side-length of the duct on heat transfer by natural convection and the average temperature of the duct are to be investigated.

Analysis The problem is solved using EES, and the solution is given below.

"GIVEN"

$$Q_{\text{dot_total}}=150 \text{ [W]}$$

$$L=1 \text{ [m]}$$

$$\text{side}=0.15 \text{ [m]}$$

$$T_{\text{in}}=30 \text{ [C]}$$

$$T_{\text{out}}=45 \text{ [C]}$$

$$V_{\text{dot}}=0.4 \text{ [m}^3\text{/min]}$$

$$T_{\text{ambient}}=25 \text{ [C]}$$

"PROPERTIES"

$$\rho=\text{Density}(\text{air}, T=T_{\text{ave}}, P=101.3)$$

$$C_p=\text{CP}(\text{air}, T=T_{\text{ave}})*\text{Convert}(\text{kJ/kg-C}, \text{J/kg-C})$$

$$T_{\text{ave}}=1/2*(T_{\text{in}}+T_{\text{out}})$$

"ANALYSIS"

"(a)"

$$m_{\text{dot}}=\rho*V_{\text{dot}}*\text{Convert}(\text{m}^3\text{/min}, \text{m}^3\text{/s})$$

$$Q_{\text{dot_ForcedConv}}=m_{\text{dot}}*C_p*(T_{\text{out}}-T_{\text{in}})$$

$$Q_{\text{dot_NaturalConv}}=Q_{\text{dot_total}}-Q_{\text{dot_ForcedConv}}$$

"(b)"

$$A_{\text{side}}=2*\text{side}*L$$

$$h_{\text{conv_side}}=1.42*((T_s-T_{\text{ambient}})/L)^{0.25}$$

$$Q_{\text{dot_conv_side}}=h_{\text{conv_side}}*A_{\text{side}}*(T_s-T_{\text{ambient}})$$

$$L_{\text{top}}=(4*A_{\text{top}})/p_{\text{top}}$$

$$A_{\text{top}}=\text{side}*L$$

$$p_{\text{top}}=2*(\text{side}+L)$$

$$h_{\text{conv_top}}=1.32*((T_s-T_{\text{ambient}})/L_{\text{top}})^{0.25}$$

$$Q_{\text{dot_conv_top}}=h_{\text{conv_top}}*A_{\text{top}}*(T_s-T_{\text{ambient}})$$

$$h_{\text{conv_bottom}}=0.59*((T_s-T_{\text{ambient}})/L_{\text{top}})^{0.25}$$

$$Q_{\text{dot_conv_bottom}}=h_{\text{conv_bottom}}*A_{\text{top}}*(T_s-T_{\text{ambient}})$$

$$Q_{\text{dot_NaturalConv}}=Q_{\text{dot_conv_side}}+Q_{\text{dot_conv_top}}+Q_{\text{dot_conv_bottom}}$$

V [m ³ /min]	Q _{NaturalConv} [W]	T _s [C]
0.1	121.4	79.13
0.15	107.1	73.97
0.2	92.81	68.66
0.25	78.51	63.19
0.3	64.21	57.52
0.35	49.92	51.58
0.4	35.62	45.29
0.45	21.32	38.46
0.5	7.023	30.54

side [m]	$\dot{Q}_{\text{NaturalConv}}$ [W]	T_s [C]
0.1	35.62	52.08
0.11	35.62	50.31
0.12	35.62	48.8
0.13	35.62	47.48
0.14	35.62	46.32
0.15	35.62	45.29
0.16	35.62	44.38
0.17	35.62	43.55
0.18	35.62	42.81
0.19	35.62	42.13
0.2	35.62	41.5

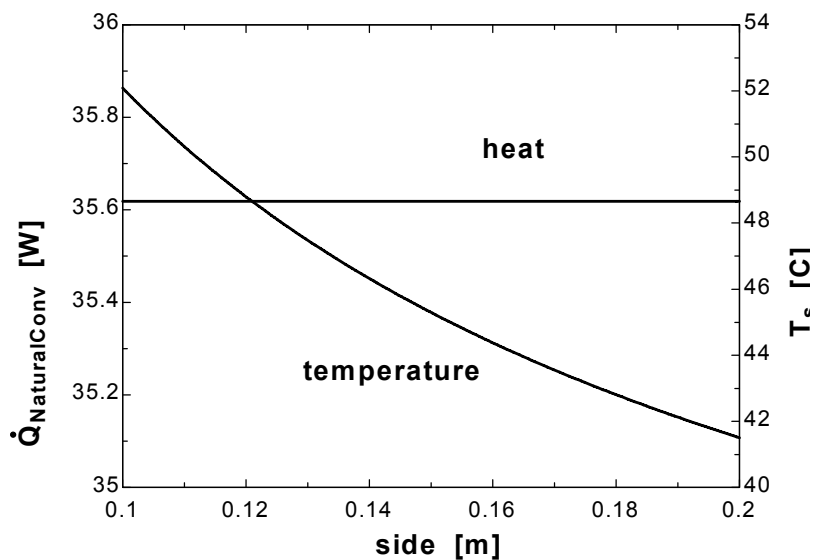
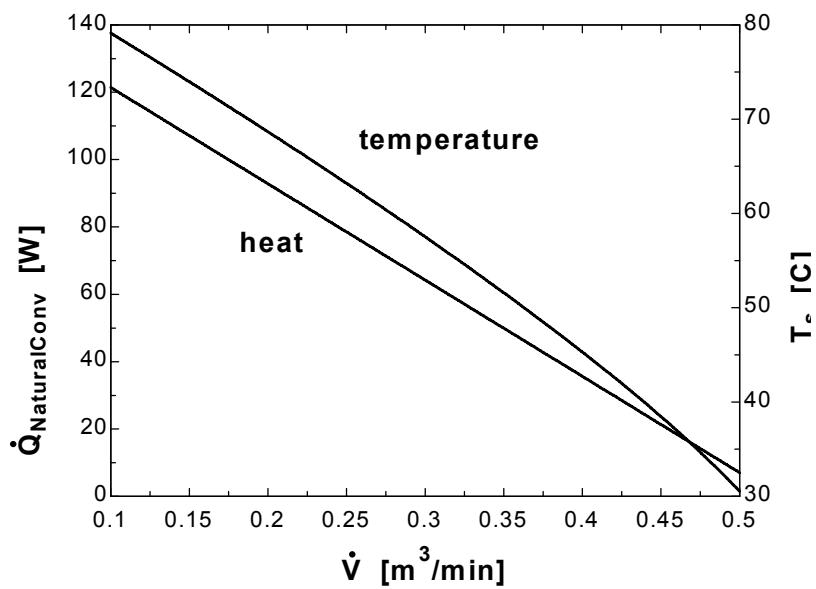

15-91 The components of an electronic equipment located in a horizontal duct with rectangular cross-section are cooled by forced air. The heat transfer from the outer surfaces of the duct by natural convection and the average temperature of the duct are to be determined.

Assumptions 1 Steady operating conditions exist. **2** Radiation heat transfer from the outer surfaces is negligible.

Analysis In this case the entire 150 W must be dissipated by natural convection from the outer surface of the duct. Natural convection from the vertical side surfaces of the duct can be expressed as

$$L = 0.15 \text{ m}$$

$$A_{\text{side}} = 2 \times (0.15 \text{ m})(1 \text{ m}) = 0.3 \text{ m}^2$$

$$h_{\text{conv,side}} = 1.42 \left(\frac{\Delta T}{L} \right)^{0.25}$$

$$\begin{aligned} \dot{Q}_{\text{conv,side}} &= h_{\text{conv,side}} A_{\text{side}} (T_s - T_{\text{fluid}}) = 1.42 \left(\frac{(T_s - T_{\text{fluid}})}{L} \right)^{0.25} A_{\text{side}} (T_s - T_{\text{fluid}}) \\ &= 1.42 A_{\text{side}} \frac{(T_s - T_{\text{fluid}})^{1.25}}{L^{0.25}} \end{aligned}$$

Natural convection from the top surface of the duct is

$$L = \frac{4A_{\text{top}}}{p} = \frac{(4)(0.15 \text{ m})(1 \text{ m})}{(2)(0.15 \text{ m} + 1 \text{ m})} = 0.26 \text{ m}$$

$$A_{\text{top}} = (0.15 \text{ m})(1 \text{ m}) = 0.15 \text{ m}^2$$

$$h_{\text{conv,top}} = 1.32 \left(\frac{\Delta T}{L} \right)^{0.25}$$

$$\begin{aligned} \dot{Q}_{\text{conv,top}} &= h_{\text{conv,top}} A_{\text{top}} (T_s - T_{\text{fluid}}) = 1.32 \left(\frac{(T_s - T_{\text{fluid}})}{L} \right)^{0.25} A_{\text{top}} (T_s - T_{\text{fluid}}) \\ &= 1.32 A_{\text{top}} \frac{(T_s - T_{\text{fluid}})^{1.25}}{L^{0.25}} \end{aligned}$$

Natural convection from the bottom surface of the duct is

$$h_{\text{conv,bottom}} = 0.59 \left(\frac{\Delta T}{L} \right)^{0.25}$$

$$\begin{aligned} \dot{Q}_{\text{conv,bottom}} &= h_{\text{conv,bottom}} A_{\text{top}} (T_s - T_{\text{fluid}}) = 0.59 \left(\frac{(T_s - T_{\text{fluid}})}{L} \right)^{0.25} A_{\text{bottom}} (T_s - T_{\text{fluid}}) \\ &= 0.59 A_{\text{bottom}} \frac{(T_s - T_{\text{fluid}})^{1.25}}{L^{0.25}} \end{aligned}$$

Then the total heat transfer by natural convection becomes

$$\begin{aligned} \dot{Q}_{\text{total,conv}} &= \dot{Q}_{\text{conv,side}} + \dot{Q}_{\text{conv,top}} + \dot{Q}_{\text{conv,bottom}} \\ \dot{Q}_{\text{total,conv}} &= 1.42 A_{\text{side}} \frac{(T_s - T_{\text{fluid}})^{1.25}}{L^{0.25}} + 1.32 A_{\text{top}} \frac{(T_s - T_{\text{fluid}})^{1.25}}{L^{0.25}} + 0.59 A_{\text{bottom}} \frac{(T_s - T_{\text{fluid}})^{1.25}}{L^{0.25}} \end{aligned}$$

Substituting all known quantities with proper units gives the average temperature of the duct to be

$$\begin{aligned} 150 &= (1.42)(0.3) \frac{(T_s - 25)^{1.25}}{0.15^{0.25}} + (1.32)(0.15) \frac{(T_s - 25)^{1.25}}{0.26^{0.25}} + (0.59)(0.15) \frac{(T_s - 25)^{1.25}}{0.26^{0.25}} \\ 150 &= (1.086)(T_s - 25)^{1.25} \longrightarrow T_s = \mathbf{77^\circ\text{C}} \end{aligned}$$

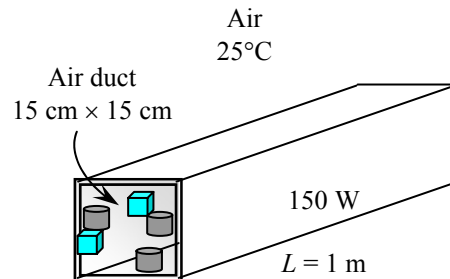

15-92 A wall-mounted circuit board containing 81 square chips is cooled by combined natural convection and radiation. The surface temperature of the chips is to be determined.

Assumptions 1 Steady operating conditions exist. 2 Heat transfer from the back side of the circuit board is negligible. 3 Temperature of surrounding surfaces is the same as the air temperature. 3 The local atmospheric pressure is 1 atm.

Analysis The natural convection heat transfer coefficient for the vertical orientation of board can be determined from (Table 15-1)

$$h_{conv} = 1.42 \left(\frac{T_s - T_{fluid}}{L} \right)^{0.25}$$

Substituting it relation into the heat transfer relation gives

$$\begin{aligned} \dot{Q}_{conv} &= h_{conv} A_s (T_s - T_{fluid}) \\ &= 1.42 \left(\frac{T_s - T_{fluid}}{L} \right)^{0.25} A_s (T_s - T_{fluid}) = 1.42 A_s \frac{(T_s - T_{fluid})^{1.25}}{L^{0.25}} \end{aligned}$$

The rate of heat transfer from the board by radiation is

$$\dot{Q}_{rad} = \varepsilon A_s \sigma (T_s^4 - T_{surr}^4)$$

Then the total heat transfer can be expressed as

$$\dot{Q}_{total} = \dot{Q}_{conv} + \dot{Q}_{rad} = 1.42 A_s \frac{(T_s - T_{fluid})^{1.25}}{L^{0.25}} + \varepsilon A_s \sigma (T_s^4 - T_{surr}^4)$$

where $\dot{Q}_{total} = (0.08 \text{ W}) \times 81 = 6.48 \text{ W}$. Noting that the characteristic length is $L = 0.2 \text{ m}$, calculating the surface area and substituting the known quantities into the above equation, the surface temperature is determined to be

$$\begin{aligned} L &= 0.2 \text{ m} \\ A_s &= (0.2 \text{ m})(0.2 \text{ m}) = 0.04 \text{ m}^2 \\ 6.48 \text{ W} &= (2.44)(0.04 \text{ m}^2) \frac{[T_s - (25 + 273 \text{ K})]^{1.25}}{(0.2 \text{ m})^{0.25}} \\ &\quad + (0.65)(0.04 \text{ m}^2)(5.67 \times 10^{-8} \text{ W/m}^2\text{K}^4)[T_s^4 - (25 + 273 \text{ K})^4] \\ T_s &= 312.3 \text{ K} = \mathbf{39.3^\circ\text{C}} \end{aligned}$$

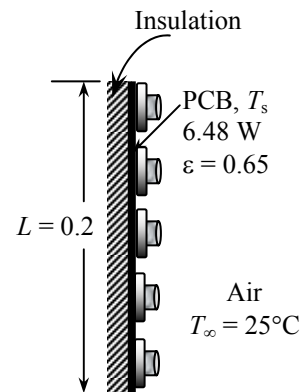

15-93 A horizontal circuit board containing 81 square chips is cooled by combined natural convection and radiation. The surface temperature of the chips is to be determined for two cases.

Assumptions 1 Steady operating conditions exist. 2 Heat transfer from the back side of the circuit board is negligible. 3 Temperature of surrounding surfaces is the same as the air temperature. 3 The local atmospheric pressure is 1 atm.

Analysis (a) The natural convection heat transfer coefficient for the horizontal orientation of board with chips facing up can be determined from (Table 15-1)

$$h_{conv} = 1.32 \left(\frac{T_s - T_{fluid}}{L} \right)^{0.25}$$

Substituting it into the heat transfer relation gives

$$\begin{aligned} \dot{Q}_{conv} &= h_{conv} A_s (T_s - T_{fluid}) \\ &= 1.32 \left(\frac{T_s - T_{fluid}}{L} \right)^{0.25} A_s (T_s - T_{fluid}) = 1.32 A_s \frac{(T_s - T_{fluid})^{1.25}}{L^{0.25}} \end{aligned}$$

The rate of heat transfer from the board by radiation is

$$\dot{Q}_{rad} = \varepsilon A_s \sigma (T_s^4 - T_{surr}^4)$$

Then the total heat transfer can be written as

$$\dot{Q}_{total} = \dot{Q}_{conv} + \dot{Q}_{rad} = 1.32 A_s \frac{(T_s - T_{fluid})^{1.25}}{L^{0.25}} + \varepsilon A_s \sigma (T_s^4 - T_{surr}^4)$$

where $\dot{Q}_{total} = (0.08 \text{ W}) \times 81 = 6.48 \text{ W}$. Noting that the characteristic length is $L = 0.2 \text{ m}$, calculating the surface area and substituting the known quantities into the above equation, the surface temperature is determined to be

$$\begin{aligned} L &= \frac{4A_s}{p} = \frac{(4)(0.2 \text{ m})(0.2 \text{ m})}{(4)(0.2 \text{ m})} = 0.2 \text{ m} \\ A_s &= (0.2 \text{ m})(0.2 \text{ m}) = 0.04 \text{ m}^2 \\ 6.48 \text{ W} &= (1.32)(0.04 \text{ m}^2) \frac{(T_s - (25 + 273)\text{K})^{1.25}}{(0.2 \text{ m})^{0.25}} \\ &\quad + (0.65)(0.04 \text{ m}^2)(5.67 \times 10^{-8} \text{ W/m}^2 \text{K}^4)[T_s^4 - (25 + 273 \text{ K})^4] \\ \longrightarrow T_s &= 317.2 \text{ K} = \mathbf{44.2^\circ\text{C}} \end{aligned}$$

(b) The solution in this case (the chips are facing down instead of up) is identical to the one above, except we must replace the constant 1.32 in the heat transfer coefficient relation by 0.59. Then the surface temperature in this case becomes

$$\begin{aligned} 6.48 \text{ W} &= (0.59)(0.04 \text{ m}^2) \frac{(T_s - (25 + 273)\text{K})^{1.25}}{(0.2 \text{ m})^{0.25}} \\ &\quad + (0.65)(0.04 \text{ m}^2)(5.67 \times 10^{-8} \text{ W/m}^2 \text{K}^4)[T_s^4 - (25 + 273 \text{ K})^4] \\ \longrightarrow T_s &= 323.3 \text{ K} = \mathbf{50.3^\circ\text{C}} \end{aligned}$$

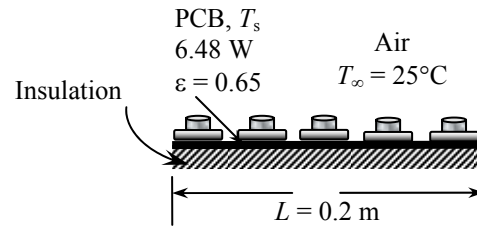

Air Cooling: Forced Convection

15-94C Radiation heat transfer in forced air cooled systems is usually disregarded with no significant error since the forced convection heat transfer coefficient is usually much larger than the radiation heat transfer coefficient.

15-95C We would definitely prefer natural convection cooling whenever it is adequate in order to avoid all the problems associated with the fans such as cost, power consumption, noise, complexity, maintenance, and possible failure.

15-96C The convection heat transfer coefficient depends strongly on the average fluid velocity. Forced convection usually involves much higher fluid velocities, and thus much higher heat transfer coefficients. Consequently, forced convection cooling is much more effective.

15-97C Increasing the flow rate of air will increase the heat transfer coefficient. Then from Newton's law of cooling $\dot{Q}_{conv} = hA_s(T_s - T_{fluid})$, it becomes obvious that for a fixed amount of power, the temperature difference between the surface and the air will decrease. Therefore, the surface temperature will decrease. The exit temperature of the air will also decrease since $\dot{Q}_{conv} = \dot{m}_{air}c_p(T_{out} - T_{in})$ and the flow rate of air is increased.

15-98C Fluid flow over a body is called external flow, and flow through a confined space such as a tube or the parallel passage area between two circuit boards in an enclosure is called internal flow. A fan cooled personal computer left in windy area involves both types of flow.

15-99C For a specified power dissipation and air inlet temperature, increasing the heat transfer coefficient will decrease the surface temperature of the electronic components since, from Newton's law of cooling, $\dot{Q}_{conv} = hA_s(T_s - T_{fluid})$

15-100C A fan at a fixed speed (or fixed rpm) will deliver a fixed volume of air regardless of the altitude and pressure. But the mass flow rate of air will be less at high altitude as a result of the lower density of air. This may create serious reliability problems and catastrophic failures of electronic equipment if proper precautions are not taken. Variable speed fans which automatically increase the speed when the air density decreases are available to avoid such problems.

15-101C A fan placed at the inlet draws the air in and pressurizes the electronic box, and prevents air infiltration into the box through the cracks or other openings. Having only one location for air inlet makes it practical to install a filter at the inlet to catch all the dust and dirt before they enter the box. This allows the electronic system to operate in a clean environment. Also, the fan placed at the inlet handles cooler and thus denser air which results in a higher mass flow rate for the same volume flow rate or rpm. Being subjected to cool air has the added benefit that it increases the reliability and extends the life of the fan. The major disadvantage associated with the fan mounted at the inlet is that the heat generated by the fan and its motor is picked up by air on its way into the box, which adds to the heat load of the system.

When the fan is placed at the exit, the heat generated by the fan and its motor is immediately discarded to the atmosphere without getting blown first into the electronic box. However, the fan at the exit creates a vacuum inside the box, which draws air into the box through inlet vents as well as any cracks and openings. Therefore, the air is difficult to filter, and the dirt and dust which collects on the components undermine the reliability of the system.

15-102C The volume flow rate of air in a forced-air-cooled electronic system that has a constant speed fan is established at point where the fan static head curve and the system resistance curve intersects. Therefore, a fan will deliver a higher flow rate through a system which offers a lower flow resistance. A few PCBs added into an electronic box will increase the flow resistance and thus decrease the flow rate of air.

15-103C An undersized fan may cause the electronic system to overheat and fail. An oversized fan will definitely provide adequate cooling but it will needlessly be larger, noisier, more expensive, and will consume more power.

15-104 A hollow core PCB is cooled by forced air. The outlet temperature of the air and the highest surface temperature are to be determined.

Assumptions 1 Steady operating conditions exist. 2 The inner surfaces of the duct are smooth. 3 Air is an ideal gas. 4 The local atmospheric pressure is 1 atm. 5 The entire heat generated in electronic components is removed by the air flowing through the hollow core.

Properties The air properties at the anticipated average temperature of 40°C and 1 atm (Table A-15) are

$$\begin{aligned}\rho &= 1.127 \text{ kg/m}^3 & c_p &= 1007 \text{ J/kg}\cdot^\circ\text{C} \\ \text{Pr} &= 0.7255 & k &= 0.02662 \text{ W/m}\cdot^\circ\text{C} \\ \nu &= 1.702 \times 10^{-5} \text{ m}^2/\text{s}\end{aligned}$$

Analysis (a) The cross-sectional area of the channel and its hydraulic diameter are

$$\begin{aligned}A_c &= (\text{height})(\text{width}) = (0.15 \text{ m})(0.0025 \text{ m}) = 3.75 \times 10^{-4} \text{ m}^2 \\ D_h &= \frac{4A_c}{p} = \frac{(4)(3.75 \times 10^{-4} \text{ m}^2)}{(2)(0.15 \text{ m} + 0.0025 \text{ m})} = 0.00492 \text{ m}\end{aligned}$$

The average velocity and the mass flow rate of air are

$$\begin{aligned}V &= \frac{\dot{V}}{A_c} = \frac{1 \times 10^{-3} \text{ m}^3/\text{s}}{3.75 \times 10^{-4} \text{ m}^2} = 2.67 \text{ m/s} \\ \dot{m} &= \rho \dot{V} = (1.127 \text{ kg/m}^3)(1 \times 10^{-3} \text{ m}^3/\text{s}) = 1.127 \times 10^{-3} \text{ kg/s}\end{aligned}$$

Then the temperature of air at the exit of the hollow core becomes

$$\begin{aligned}\dot{Q} &= \dot{m}c_p(T_{out} - T_{in}) \\ T_{out} &= T_{in} + \frac{\dot{Q}}{\dot{m}c_p} = 30^\circ\text{C} + \frac{30 \text{ W}}{(1.127 \times 10^{-3} \text{ kg/s})(1007 \text{ J/kg}\cdot^\circ\text{C})} = \mathbf{56.4^\circ\text{C}}\end{aligned}$$

(b) The highest surface temperature in the channel will occur near the exit, and the surface temperature there can be determined from

$$\dot{q}_{conv} = h(T_s - T_{fluid})$$

To determine heat transfer coefficient, we first need to calculate the Reynolds number,

$$\text{Re} = \frac{VD_h}{\nu} = \frac{(2.67 \text{ m/s})(0.00492 \text{ m})}{1.702 \times 10^{-5} \text{ m}^2/\text{s}} = 771.8 < 2300$$

Therefore the flow is laminar. Assuming fully developed flow, the Nusselt number for the air flow in this rectangular cross-section corresponding to the aspect ratio of $a/b = \text{height}/\text{width} = 15/0.25 = 60 \approx \infty$ is determined from Table 15-3 to be $Nu = 8.24$. Then,

$$h = \frac{k}{D_h} Nu = \frac{0.02662 \text{ W/m}\cdot^\circ\text{C}}{0.00492 \text{ m}} (8.24) = 44.58 \text{ W/m}^2\cdot^\circ\text{C}$$

The surface temperature of the hollow core near the exit is determined to be

$$T_{s,\max} = T_{out} + \frac{\dot{q}}{h} = 56.4^\circ\text{C} + \frac{(30 \text{ W})/(0.06 \text{ m}^2)}{(44.58 \text{ W/m}^2\cdot^\circ\text{C})} = \mathbf{67.6^\circ\text{C}}$$

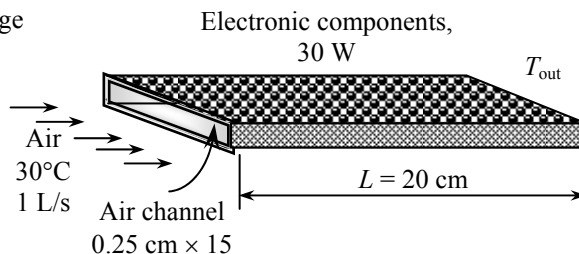

15-105 A hollow core PCB is cooled by forced air. The outlet temperature of the air and the highest surface temperature are to be determined.

Assumptions 1 Steady operating conditions exist. 2 The inner surfaces of the duct are smooth. 3 Air is an ideal gas. 4 The local atmospheric pressure is 1 atm. 5 The entire heat generated in electronic components is removed by the air flowing through the hollow core.

Properties The air properties at the anticipated average temperature of 40°C and 1 atm (Table A-15) are

$$\begin{aligned}\rho &= 1.127 \text{ kg/m}^3 & c_p &= 1007 \text{ J/kg}\cdot^\circ\text{C} \\ \text{Pr} &= 0.7255 & k &= 0.02662 \text{ W/m}\cdot^\circ\text{C} \\ \nu &= 1.702 \times 10^{-5} \text{ m}^2/\text{s}\end{aligned}$$

Analysis (a) The cross-sectional area of the channel and its hydraulic diameter are

$$\begin{aligned}A_c &= (\text{height})(\text{width}) = (0.15 \text{ m})(0.0025 \text{ m}) = 3.75 \times 10^{-4} \text{ m}^2 \\ D_h &= \frac{4A_c}{p} = \frac{(4)(3.75 \times 10^{-4} \text{ m}^2)}{(2)(0.15 \text{ m} + 0.0025 \text{ m})} = 0.00492 \text{ m}\end{aligned}$$

The average velocity and the mass flow rate of air are

$$\begin{aligned}V &= \frac{\dot{V}}{A_c} = \frac{1 \times 10^{-3} \text{ m}^3/\text{s}}{3.75 \times 10^{-4} \text{ m}^2} = 2.67 \text{ m/s} \\ \dot{m} &= \rho \dot{V} = (1.127 \text{ kg/m}^3)(1 \times 10^{-3} \text{ m}^3/\text{s}) = 1.127 \times 10^{-3} \text{ kg/s}\end{aligned}$$

Then the temperature of air at the exit of the hollow core becomes

$$\begin{aligned}\dot{Q} &= \dot{m}c_p(T_{out} - T_{in}) \\ T_{out} &= T_{in} + \frac{\dot{Q}}{\dot{m}c_p} = 30^\circ\text{C} + \frac{45 \text{ W}}{(1.127 \times 10^{-3} \text{ kg/s})(1007 \text{ J/kg}\cdot^\circ\text{C})} = \mathbf{69.7^\circ\text{C}}\end{aligned}$$

(b) The highest surface temperature in the channel will occur near the exit, and the surface temperature there can be determined from

$$\dot{q}_{conv} = h(T_s - T_{fluid})$$

To determine heat transfer coefficient, we first need to calculate the Reynolds number,

$$\text{Re} = \frac{VD_h}{\nu} = \frac{(2.67 \text{ m/s})(0.00492 \text{ m})}{1.702 \times 10^{-5} \text{ m}^2/\text{s}} = 771.8 < 2300$$

Therefore the flow is laminar. Assuming fully developed flow, the Nusselt number for the air flow in this rectangular cross-section corresponding to the aspect ratio of $a/b = \text{height}/\text{width} = 15/0.25 = 60 \approx \infty$ is determined from Table 15-3 to be $Nu = 8.24$. Then,

$$h = \frac{k}{D_h} Nu = \frac{0.02662 \text{ W/m}\cdot^\circ\text{C}}{0.00492 \text{ m}} (8.24) = 44.58 \text{ W/m}^2\cdot^\circ\text{C}$$

The surface temperature of the hollow core near the exit is determined to be

$$T_{s,\max} = T_{out} + \frac{\dot{q}}{h} = 69.7^\circ\text{C} + \frac{(45 \text{ W})/(0.06 \text{ m}^2)}{(44.58 \text{ W/m}^2\cdot^\circ\text{C})} = \mathbf{86.5^\circ\text{C}}$$

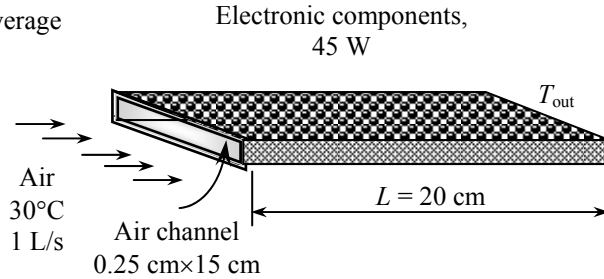

15-106 EES Prob. 15-104 is reconsidered. The effects of the power rating of the PCB and the volume flow rate of the air on the exit temperature of the air and the maximum temperature on the inner surface of the core are to be investigated.

Analysis The problem is solved using EES, and the solution is given below.

"GIVEN"

height=15/100 [m]
length=20/100 [m]
width=0.25/100 [m]
Q_dot_total=30 [W]
T_in=30 [C]
V_dot=1 [L/s]

"PROPERTIES"

Fluid\$='air'
rho=Density(Fluid\$, T=T_ave, P=101.3)
C_p=CP(Fluid\$, T=T_ave)*Convert(kJ/kg-C, J/kg-C)
k=Conductivity(Fluid\$, T=T_ave)
Pr=Prandtl(Fluid\$, T=T_ave)
mu=Viscosity(Fluid\$, T=T_ave)
nu=mu/rho
T_ave=1/2*((T_in+T_out)/2+T_s_max)

"ANALYSIS"

"(a)"

A_c=height*width
p=2*(height+width)
D_h=(4*A_c/p)
Vel=(V_dot*Convert(L/s, m^3/s))/A_c
m_dot=rho*V_dot*Convert(L/s, m^3/s)
Q_dot_total=m_dot*C_p*(T_out-T_in)

"(b)"

Re=(Vel*D_h)/nu
"Re is calculated to be smaller than 2300. Therefore, the flow is laminar. From Table 15-3 of the text"
Nusselt=8.24
h=k/D_h*Nusselt
A=2*height*length
Q_dot_total=h*A*(T_s_max-T_out)

Q_{total} [W]	T_{out} [C]	$T_{\text{s,max}}$ [C]
20	48.03	55.36
22	49.94	57.96
24	51.87	60.58
26	53.83	63.22
28	55.8	65.87
30	57.8	68.53
32	59.82	71.21
34	61.86	73.9
36	63.92	76.61
38	66	79.34
40	68.11	82.08
42	70.24	84.83
44	72.39	87.61
46	74.57	90.4
48	76.76	93.2
50	78.98	96.03
52	81.23	98.87
54	83.5	101.7
56	85.79	104.6
58	88.11	107.5
60	90.45	110.4

V [L/s]	T_{out} [C]	$T_{\text{s,max}}$ [C]
0.5	89.52	99.63
0.6	78.46	88.78
0.7	70.87	81.34
0.8	65.33	75.91
0.9	61.12	71.78
1	57.8	68.53
1.1	55.12	65.91
1.2	52.91	63.75
1.3	51.06	61.94
1.4	49.49	60.4
1.5	48.13	59.07
1.6	46.96	57.92
1.7	45.92	56.91
1.8	45	56.01
1.9	44.19	55.21
2	43.46	54.49
2.1	42.8	53.85
2.2	42.2	53.26
2.3	41.65	52.73
2.4	41.15	52.24
2.5	40.7	51.8

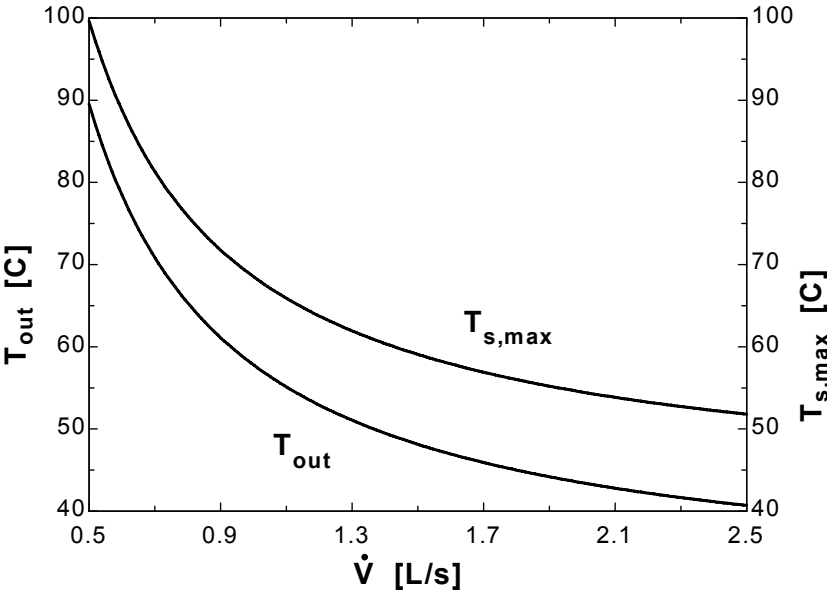
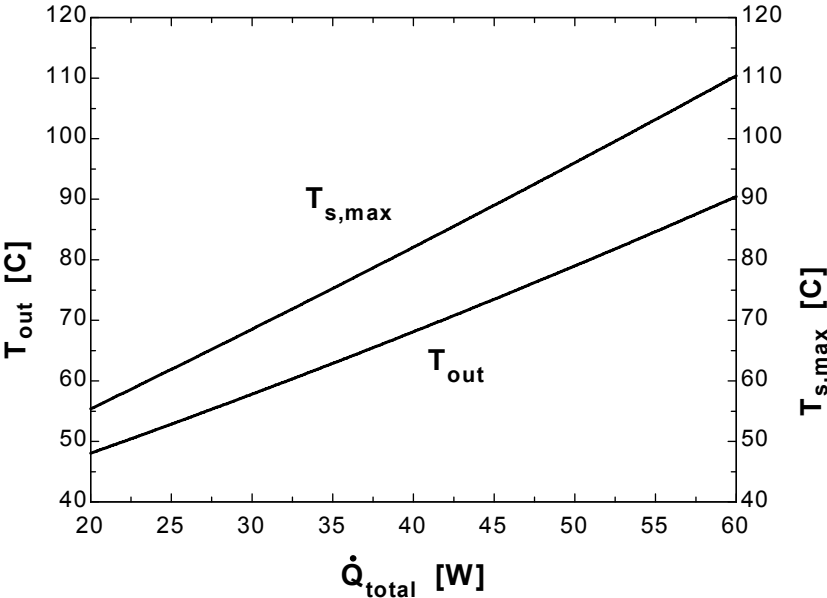

15-107E A transistor mounted on a circuit board is cooled by air flowing over it. The power dissipated when its case temperature is 175°F is to be determined.

Assumptions 1 Steady operating conditions exist. 2 Air is an ideal gas. 3 The local atmospheric pressure is 1 atm.

Properties The properties of air at 1 atm pressure and the film temperature of $T_f = (T_s + T_{\text{fluid}})/2 = (175 + 140)/2 = 157.5^\circ\text{F}$ are (Table A-15E)

$$k = 0.0166 \text{ Btu/h}\cdot\text{ft}\cdot^\circ\text{F}$$

$$\nu = 0.214 \times 10^{-3} \text{ ft}^2/\text{s}$$

$$\text{Pr} = 0.718$$

Analysis The transistor is cooled by forced convection through its cylindrical surface as well as its flat top surface. The characteristic length for flow over a cylinder is the diameter $D = 0.2$ in. Then,

$$\text{Re} = \frac{VD}{\nu} = \frac{(400/60 \text{ ft/s})(0.2/12 \text{ ft})}{0.214 \times 10^{-3} \text{ ft}^2/\text{s}} = 519$$

which falls into the range of 40–4000. Using the appropriate relation from Table 15-2, the Nusselt number and the convection heat transfer coefficient are determined to be

$$\text{Nu} = 0.683 \text{Re}^{0.466} \text{Pr}^{1/3} = (0.683)(519)^{0.466} (0.718)^{1/3} = 11.3$$

$$h = \frac{k}{D} \text{Nu} = \frac{0.0166 \text{ Btu/h}\cdot\text{ft}\cdot^\circ\text{F}}{(0.2/12 \text{ ft})} (11.3) = 11.2 \text{ Btu/h}\cdot\text{ft}^2\cdot^\circ\text{F}$$

The transistor loses heat through its cylindrical surface as well as its circular top surface. For convenience, we take the heat transfer coefficient at the top surfaces to be the same as that of the side surface. (The alternative is to treat the top surface as a flat plate, but this will double the amount of calculations without providing much improvement in accuracy since the area of the top surface is much smaller and it is circular in shape rather than being rectangular). Then,

$$A_{\text{cyl}} = \pi DL + \pi D^2/4 = \pi(0.2/12 \text{ ft})(0.25/12 \text{ ft}) + \pi(0.2/12 \text{ ft})^2/4 = 0.00131 \text{ ft}^2$$

$$\dot{Q}_{\text{cyl}} = hA_{\text{cyl}}(T_s - T_{\text{fluid}}) = (11.2 \text{ Btu/h}\cdot\text{ft}^2\cdot^\circ\text{F})(0.00131 \text{ ft}^2)(175 - 140)^\circ\text{F} = 0.514 \text{ Btu/h} = \mathbf{0.15 \text{ W}}$$

since $1 \text{ W} = 3.4121 \text{ Btu/h}$. Therefore, the transistor can dissipate 0.15 W safely.

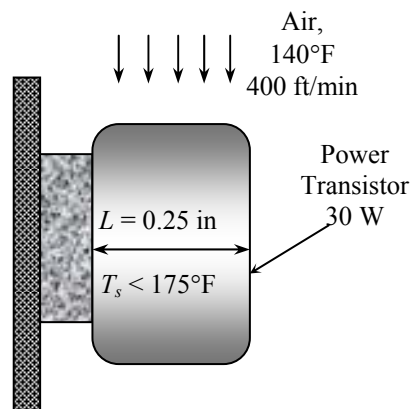

15-108 A desktop computer is to be cooled by a fan safely in hot environments and high elevations. The air flow rate of the fan and the diameter of the casing are to be determined.

Assumptions 1 Steady operation under worst conditions is considered. 2 Air is an ideal gas.

Properties The specific heat of air at the average temperature of $T_{\text{avg}} = (45+60)/2 = 52.5^\circ\text{C}$ is $c_p = 1007$ J/kg $\cdot^\circ\text{C}$ (Table A-15)

Analysis The fan selected must be able to meet the cooling requirements of the computer at worst conditions. Therefore, we assume air to enter the computer at 66.63 kPa and 45°C, and leave at 60°C. Then the required mass flow rate of air to absorb heat generated is determined to be

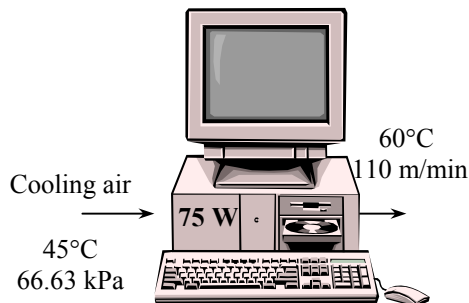

$$\dot{Q} = \dot{m}c_p(T_{\text{out}} - T_{\text{in}}) \rightarrow \dot{m} = \frac{\dot{Q}}{c_p(T_{\text{out}} - T_{\text{in}})} = \frac{75 \text{ W}}{(1007 \text{ J/kg}\cdot^\circ\text{C})(60 - 45)^\circ\text{C}} = 0.00497 \text{ kg/s} = 0.298 \text{ kg/min}$$

The density of air entering the fan at the exit and its volume flow rate are

$$\rho = \frac{P}{RT} = \frac{66.63 \text{ kPa}}{(0.287 \text{ kPa}\cdot\text{m}^3/\text{kg}\cdot\text{K})(60 + 273)\text{K}} = 0.6972 \text{ kg/m}^3$$

$$\dot{V} = \frac{\dot{m}}{\rho} = \frac{0.298 \text{ kg/min}}{0.6972 \text{ kg/m}^3} = \mathbf{0.427 \text{ m}^3/\text{min}}$$

For an average exit velocity of 110 m/min, the diameter of the casing of the fan is determined from

$$\dot{V} = A_c V = \frac{\pi D^2}{4} V \rightarrow D = \sqrt{\frac{4\dot{V}}{\pi V}} = \sqrt{\frac{(4)(0.427 \text{ m}^3/\text{min})}{\pi(110 \text{ m/min})}} = 0.070 \text{ m} = \mathbf{7.0 \text{ cm}}$$

15-109 A desktop computer is to be cooled by a fan safely in hot environments and high elevations. The air flow rate of the fan and the diameter of the casing are to be determined.

Assumptions 1 Steady operation under worst conditions is considered. 2 Air is an ideal gas.

Properties The specific heat of air at the average temperature of $T_{\text{avg}} = (45+60)/2 = 52.5^\circ\text{C}$ is $c_p = 1007 \text{ J/kg}\cdot^\circ\text{C}$ (Table A-15)

Analysis The fan selected must be able to meet the cooling requirements of the computer at worst conditions. Therefore, we assume air to enter the computer at 66.63 kPa and 45°C , and leave at 60°C . Then the required mass flow rate of air to absorb heat generated is determined to be

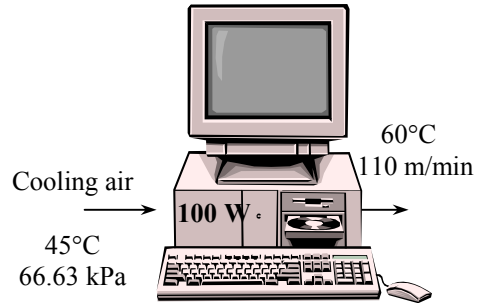

$$\dot{Q} = \dot{m}c_p(T_{\text{out}} - T_{\text{in}}) \rightarrow \dot{m} = \frac{\dot{Q}}{c_p(T_{\text{out}} - T_{\text{in}})} = \frac{100 \text{ W}}{(1007 \text{ J/kg}\cdot^\circ\text{C})(60 - 45)^\circ\text{C}} = 0.00662 \text{ kg/s} = 0.397 \text{ kg/min}$$

The density of air entering the fan at the exit and its volume flow rate are

$$\rho = \frac{P}{RT} = \frac{66.63 \text{ kPa}}{(0.287 \text{ kPa}\cdot\text{m}^3/\text{kg}\cdot\text{K})(60 + 273)\text{K}} = 0.6972 \text{ kg/m}^3$$

$$\dot{V} = \frac{\dot{m}}{\rho} = \frac{0.397 \text{ kg/min}}{0.6972 \text{ kg/m}^3} = \mathbf{0.570 \text{ m}^3/\text{min}}$$

For an average exit velocity of 110 m/min , the diameter of the casing of the fan is determined from

$$\dot{V} = A_c V = \frac{\pi D^2}{4} V \rightarrow D = \sqrt{\frac{4\dot{V}}{\pi V}} = \sqrt{\frac{(4)(0.570 \text{ m}^3/\text{min})}{\pi(110 \text{ m/min})}} = 0.081 \text{ m} = \mathbf{8.1 \text{ cm}}$$

15-110 A computer is cooled by a fan, and the temperature rise of air is limited to 15°C. The flow rate of air, the fraction of the temperature rise of air caused by the fan and its motor, and maximum allowable air inlet temperature are to be determined.

Assumptions 1 Steady operating conditions exist. 2 Air is an ideal gas. 3 The local atmospheric pressure is 1 atm. 4 The entire heat generated in electronic components is removed by the air flowing through the opening between the PCBs. 5 The entire power consumed by the fan motor is transferred as heat to the cooling air.

Properties We use air properties at 1 atm and 30°C since air enters at room temperature, and the temperature rise is limited to 15°C (Table A-15)

$$\begin{aligned}\rho &= 1.164 \text{ kg/m}^3 \\ c_p &= 1007 \text{ J/kg}\cdot^\circ\text{C} \\ \text{Pr} &= 0.728 \\ k &= 0.0259 \text{ W/m}\cdot^\circ\text{C} \\ \nu &= 1.61 \times 10^{-5} \text{ m}^2/\text{s}\end{aligned}$$

Analysis (a) Because of symmetry, we consider the flow area between the two adjacent PCBs only. We assume the flow rate of air through all 8 channels to be identical, and to be equal to one-eighth of the total flow rate. The total mass and volume flow rates of air through the computer are determined from

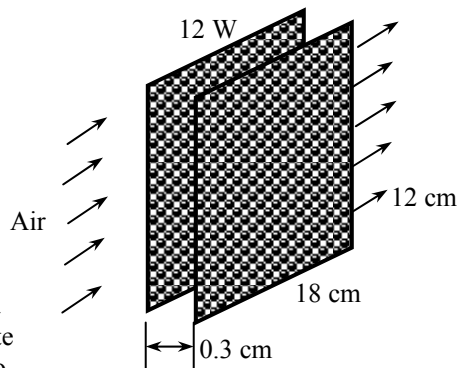

$$\dot{Q} = \dot{m} c_p (T_{out} - T_{in}) \longrightarrow \dot{m} = \frac{\dot{Q}}{c_p (T_{out} - T_{in})} = \frac{[(8 \times 12) + 15] \text{ J/s}}{(1007 \text{ J/kg}\cdot^\circ\text{C})(15^\circ\text{C})} = 0.00735 \text{ kg/s}$$

$$\dot{V} = \frac{\dot{m}}{\rho} = \frac{0.00735 \text{ kg/s}}{1.164 \text{ kg/m}^3} = \mathbf{0.00631 \text{ m}^3/\text{s}}$$

Noting that we have 8 PCBs and the flow area between the PCBs is 0.12 m and 0.003 m wide, the air velocity is determined to be

$$V = \frac{\dot{V}}{A_c} = \frac{(0.006819 \text{ m}^3/\text{s})/8}{(0.12 \text{ m})(0.003 \text{ m})} = 2.37 \text{ m/s}$$

(b) The temperature rise of air due to the 15 W of power consumed by the fan is

$$\Delta T_{air} = \frac{\dot{Q}_{fan}}{\dot{m} c_p} = \frac{15 \text{ W}}{(0.00735 \text{ kg/s})(1007 \text{ J/kg}\cdot^\circ\text{C})} = 2.0^\circ\text{C}$$

Then the fraction of temperature rise of air which is due to the heat generated by the fan becomes

$$f = \frac{2.0^\circ\text{C}}{15^\circ\text{C}} \times 100 = \mathbf{13.5\%}$$

(c) To determine the surface temperature, we need to evaluate the convection heat transfer coefficient,

$$A_c = (\text{height})(\text{width}) = (0.12 \text{ m})(0.003 \text{ m}) = 0.00036 \text{ m}^2$$

$$D_h = \frac{4A_c}{p} = \frac{(4)(0.00036 \text{ m}^2)}{(2)(0.12 \text{ m} + 0.003 \text{ m})} = 0.00585 \text{ m}$$

$$\text{Re} = \frac{VD_h}{\nu} = \frac{(2.37 \text{ m/s})(0.00585 \text{ m})}{1.61 \times 10^{-5} \text{ m}^2/\text{s}} = 861 < 2300$$

Therefore, the flow is laminar. (Actually, the components will cause the flow to be turbulent. The laminar assumption gives conservative results). Assuming fully developed flow, the Nusselt number for the air flow through this rectangular channel corresponding to the aspect ratio $a/b = 12/0.3 = 40 \approx \infty$ is determined from Table 15-3 to be $Nu = 8.24$. Then the heat transfer coefficient becomes

$$h = \frac{k}{D_h} Nu = \frac{0.0259 \text{ W/m}\cdot\text{°C}}{0.00585 \text{ m}} (8.24) = 36.5 \text{ W/m}^2 \cdot \text{°C}$$

Disregarding the entrance effects, the temperature difference between the surface of the PCB and the air anywhere along the channel is determined to be

$$T_s - T_{fluid} = \frac{\dot{Q}}{hA_s} = \frac{12 \text{ W}}{(36.5 \text{ W/m}^2 \cdot \text{°C})(0.12 \times 0.18 \text{ m}^2)} = 15.2 \text{°C}$$

The highest air and component temperatures will occur at the exit. Therefore, in the limiting case, the component surface temperature at the exit will be 90°C. The air temperature at the exit in this case will be

$$T_{out,max} = T_{s,max} - \Delta T_{rise} = 90 \text{°C} - 15.2 \text{°C} = 74.8 \text{°C}$$

Noting that the air experiences a temperature rise of 15°C between the inlet and the exit, the inlet temperature of air becomes

$$T_{in,max} = T_{out,max} - 15 \text{°C} = 74.8 \text{°C} - 15 \text{°C} = \mathbf{59.8 \text{°C}}$$

15-111 An array of power transistors is to be cooled by mounting them on a square aluminum plate and blowing air over the plate. The number of transistors that can be placed on this plate is to be determined.

Assumptions 1 Steady operating conditions exist. 2 Air is an ideal gas. 3 The local atmospheric pressure is 1 atm. 4 The entire heat generated by transistors is removed by the air flowing over the plate. 5 The heat transfer from the back side of the plate is negligible.

Properties The properties of air at the free stream temperature of 30°C are (Table A-15)

$$\rho = 1.164 \text{ kg/m}^3$$

$$c_p = 1007 \text{ J/kg}\cdot\text{°C}$$

$$\text{Pr} = 0.728$$

$$k = 0.0259 \text{ W/m}\cdot\text{°C}$$

$$\nu = 1.61 \times 10^{-5} \text{ m}^2/\text{s}$$

Analysis The plate area and the convection heat transfer coefficient are determined to be (from Table 15-2)

$$A_s = (0.2 \text{ m})(0.2 \text{ m}) = 0.04 \text{ m}^2$$

$$\text{Re} = \frac{VL}{\nu} = \frac{(3 \text{ m/s})(0.2 \text{ m})}{1.61 \times 10^{-5} \text{ m}^2/\text{s}} = 37,267$$

$$\text{Nu} = 0.664 \text{Re}^{1/2} \text{Pr}^{1/3} = (0.664)(37,267)^{1/2} (0.728)^{1/3} = 115.3$$

$$h = \frac{k}{L} \text{Nu} = \frac{0.0259 \text{ W/m}\cdot\text{°C}}{0.2 \text{ m}} (115.3) = 14.9 \text{ W/m}^2 \cdot \text{°C}$$

The rate of heat transfer from the plate is

$$\dot{Q}_{conv} = hA_s(T_s - T_{fluid}) = (14.9 \text{ W/m}^2 \cdot \text{°C})(0.04 \text{ m}^2)(60 - 30) \text{°C} = 17.9 \text{ W}$$

Then the number of transistors that can be placed on this plate becomes

$$n = \frac{17.9 \text{ W}}{2 \text{ W}} = \mathbf{9} \text{ transistors}$$

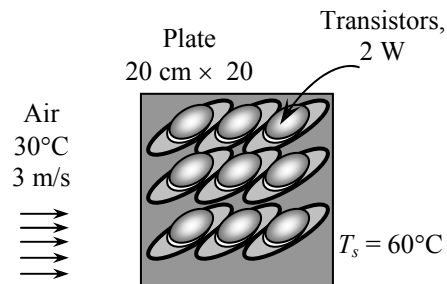

15-112 An array of power transistors is to be cooled by mounting them on a square aluminum plate and blowing air over the plate. The number of transistors that can be placed on this plate is to be determined.

Assumptions 1 Steady operating conditions exist. 2 Air is an ideal gas. 3 The local atmospheric pressure is 83.4 kPa. 4 The entire heat generated by transistors is removed by the air flowing over the plate. 5 The heat transfer from the back side of the plate is negligible.

Properties At an elevation of 1610 m, the atmospheric pressure is 83.4 kPa or

$$P = (83.4 \text{ kPa}) \frac{1 \text{ atm}}{101.325 \text{ kPa}} = 0.823 \text{ atm}$$

The properties of air at 30°C are (Table A-15)

$$\rho = 1.164 \text{ kg/m}^3$$

$$c_p = 1007 \text{ J/kg}\cdot^\circ\text{C}$$

$$\text{Pr} = 0.728$$

$$k = 0.0259 \text{ W/m}\cdot^\circ\text{C}$$

$$\nu = 1.61 \times 10^{-5} \text{ m}^2/\text{s} / 0.823 = 1.96 \times 10^{-5} \text{ m}^2/\text{s}$$

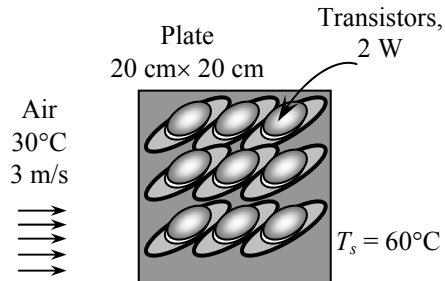

Analysis The plate area and the convection heat transfer coefficient are determined to be (from Table 15-2)

$$A_s = (0.2 \text{ m})(0.2 \text{ m}) = 0.04 \text{ m}^2$$

$$\text{Re} = \frac{VL}{\nu} = \frac{(3 \text{ m/s})(0.2 \text{ m})}{1.96 \times 10^{-5} \text{ m}^2/\text{s}} = 30,612$$

$$\text{Nu} = 0.664 \text{ Re}^{1/2} \text{ Pr}^{1/3} = (0.664)(30,612)^{1/2} (0.728)^{1/3} = 104.5$$

$$h = \frac{k}{L} \text{Nu} = \frac{0.0259 \text{ W/m}\cdot^\circ\text{C}}{0.2 \text{ m}} (104.5) = 13.5 \text{ W/m}^2\cdot^\circ\text{C}$$

The rate of heat transfer from the plate is

$$\dot{Q}_{\text{conv}} = hA_s(T_s - T_{\text{fluid}}) = (13.5 \text{ W/m}^2\cdot^\circ\text{C})(0.04 \text{ m}^2)(60 - 30)^\circ\text{C} = 16.2 \text{ W}$$

Then the number of transistors that can be placed on this plate becomes

$$n = \frac{16.2 \text{ W}}{2 \text{ W}} = \mathbf{8} \text{ transistors}$$

15-113 EES Prob. 15-111 is reconsidered. The effects effects of air velocity and the maximum plate temperature on the number of transistors are to be investigated.

Analysis The problem is solved using EES, and the solution is given below.

"GIVEN"

Q_dot=2 [W]
L=0.20 [m]
T_air=30 [C]
Vel=3 [m/s]
T_plate=60 [C]

"PROPERTIES"

Fluid\$='air'
rho=Density(Fluid\$, T=T_air, P=101.3)
k=Conductivity(Fluid\$, T=T_air)
Pr=Prandtl(Fluid\$, T=T_air)
mu=Viscosity(Fluid\$, T=T_air)
nu=mu/rho

"ANALYSIS"

A=L^2
Re=(Vel*L)/nu
Nusselt=0.664*Re^0.5*Pr^(1/3)
h=k/L*Nusselt
Q_dot_conv=h*A*(T_plate-T_air)
n_transistor=Q_dot_conv/Q_dot

Vel [m/s]	n _{transistor}
1	5.173
1.5	6.335
2	7.315
2.5	8.179
3	8.96
3.5	9.677
4	10.35
4.5	10.97
5	11.57
5.5	12.13
6	12.67
6.5	13.19
7	13.69
7.5	14.17
8	14.63

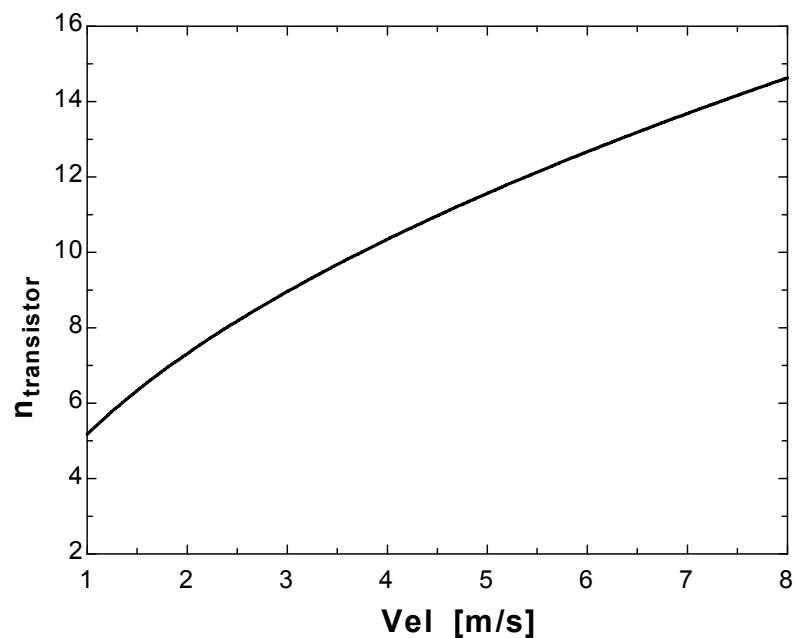

T_{plate} [C]	$n_{\text{transistor}}$
40	2.987
42.5	3.733
45	4.48
47.5	5.226
50	5.973
52.5	6.72
55	7.466
57.5	8.213
60	8.96
62.5	9.706
65	10.45
67.5	11.2
70	11.95
72.5	12.69
75	13.44
77.5	14.19
80	14.93

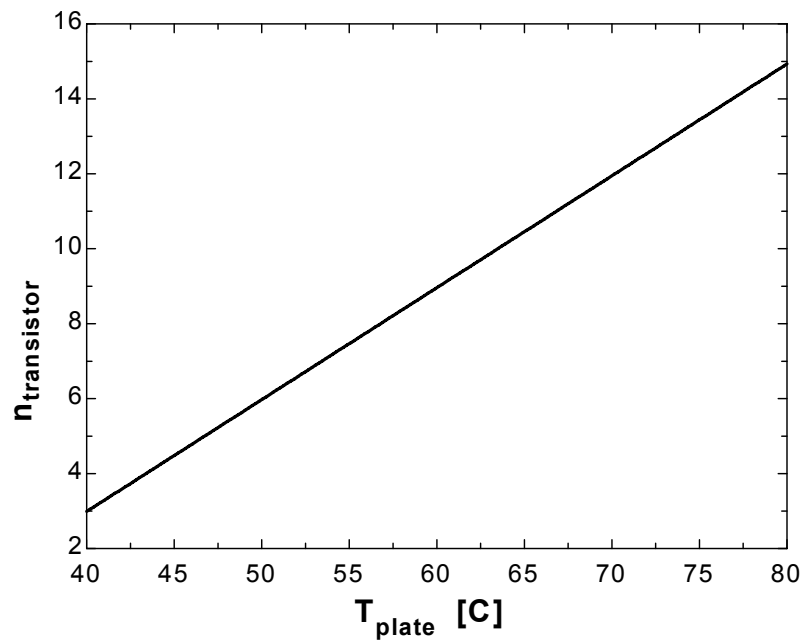

15-114 An enclosure containing an array of circuit boards is cooled by forced air flowing through the clearance between the tips of the components on the PCB and the back surface of the adjacent PCB. The exit temperature of the air and the highest surface temperature of the chips are to be determined.

Assumptions 1 Steady operating conditions exist. 2 Air is an ideal gas. 3 The local atmospheric pressure is 1 atm. 4 The entire heat generated by the PCBs is removed by the air flowing through the clearance inside the enclosure. 5 The heat transfer from the back side of the circuit board is negligible.

Properties We use the properties of air at 1 atm and 40°C (Table A-15)

$$\begin{aligned}\rho &= 1.127 \text{ kg/m}^3 \\ c_p &= 1007 \text{ J/kg}\cdot^\circ\text{C} \\ \text{Pr} &= 0.726 \\ k &= 0.0266 \text{ W/m}\cdot^\circ\text{C} \\ \nu &= 1.7 \times 10^{-5} \text{ m}^2/\text{s}\end{aligned}$$

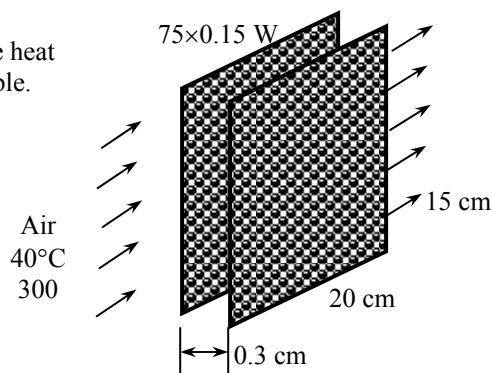

Analysis The volume and the mass flow rates of air are

$$\dot{Q} = \dot{m} c_p \Delta T \longrightarrow \dot{m} = \frac{\dot{Q}}{c_p \Delta T} = \frac{3 \text{ kJ/s}}{(4.18 \text{ kJ/kg}\cdot^\circ\text{C})(4^\circ\text{C})} = \mathbf{0.1794 \text{ kg/s}}$$

Then the exit temperature of air is determined from

$$\dot{Q} = \dot{m} c_p (T_{out} - T_{in}) \longrightarrow T_{out} = T_{in} + \frac{\dot{Q}}{\dot{m} c_p} = 40^\circ\text{C} + \frac{(75 \times 0.15) \text{ W}}{(0.00255 \text{ kg/s})(1007 \text{ J/kg}\cdot^\circ\text{C})} = \mathbf{44.4^\circ\text{C}}$$

To determine the surface temperature, we need to calculate the convection heat transfer coefficient first,

$$\begin{aligned}A_s &= (0.15 \text{ m})(0.2 \text{ m}) = 0.03 \text{ m}^2 \\ A_c &= (0.15 \text{ m})(0.003 \text{ m}) = 0.00045 \text{ m}^2 \\ D_h &= \frac{4A_c}{p} = \frac{(4)(0.00045 \text{ m}^2)}{(2)(0.15 \text{ m} + 0.003 \text{ m})} = 0.0059 \text{ m} \\ \text{Re} &= \frac{VD_h}{\nu} = \frac{(300 / 60 \text{ m/s})(0.0059 \text{ m})}{1.7 \times 10^{-5} \text{ m}^2/\text{s}} = 1735 < 2300\end{aligned}$$

Therefore, the flow is laminar. Assuming fully developed flow, the Nusselt number for the air flow in this rectangular cross-section corresponding to the aspect ratio of $a/b = \text{height} / \text{width} = 15 / 0.3 = 50 \approx \infty$ is determined from Table 15-3 to be $Nu = 8.24$. Then,

$$h = \frac{k}{L} Nu = \frac{0.0266 \text{ W/m}\cdot^\circ\text{C}}{0.0059 \text{ m}} (8.24) = 37.1 \text{ W/m}^2\cdot^\circ\text{C}$$

The highest surface temperature of the chips then becomes

$$\dot{Q} = hA_s (T_{s,\max} - T_{fluid}) \longrightarrow T_{s,\max} = T_{air,out} + \frac{\dot{Q}}{hA_s} = 44.4^\circ\text{C} + \frac{(75 \times 0.15) \text{ W}}{(37.1 \text{ W/m}^2\cdot^\circ\text{C})(0.03 \text{ m}^2)} = \mathbf{54.5^\circ\text{C}}$$

15-115 The components of an electronic system located in a horizontal duct of rectangular cross-section are cooled by forced air flowing through the duct. The exit temperature of air and the highest component surface temperature in the duct are to be determined.

Assumptions 1 Steady operating conditions exist. 2 Air is an ideal gas. 3 The local atmospheric pressure is 1 atm.

Properties We use the properties of air at 1 atm and 30°C (Table A-15)

$$\begin{aligned}\rho &= 1.164 \text{ kg/m}^3 \\ c_p &= 1007 \text{ J/kg}\cdot^\circ\text{C} \\ \text{Pr} &= 0.728 \\ k &= 0.0259 \text{ W/m}\cdot^\circ\text{C} \\ \nu &= 1.61 \times 10^{-5} \text{ m}^2/\text{s}\end{aligned}$$

Analysis (a) The rate of heat transfer from the components to the forced air in the duct is

$$\dot{Q} = (0.80)(120 \text{ W}) = 96 \text{ W}$$

The mass flow rate of air is

$$\dot{m} = \rho \dot{V} = (1.164 \text{ kg/m}^3)(0.5/60 \text{ m}^3/\text{s}) = 0.0097 \text{ kg/s}$$

Then the exit temperature of air is determined from

$$\dot{Q} = \dot{m} c_p (T_{out} - T_{in}) \longrightarrow T_{out} = T_{in} + \frac{\dot{Q}}{\dot{m} c_p} = 30^\circ\text{C} + \frac{96 \text{ W}}{(0.0097 \text{ kg/s})(1007 \text{ J/kg}\cdot^\circ\text{C})} = \mathbf{39.8^\circ\text{C}}$$

(b) The highest surface temperature can be determined from

$$\dot{Q}_{conv} = h A_s (T_s - T_{fluid})$$

But we first need to determine convection heat transfer coefficient,

$$\begin{aligned}A_s &= (4)(1 \text{ m})(0.20 \text{ m}) = 0.8 \text{ m}^2 \\ V &= \frac{\dot{V}}{A_c} = \frac{(0.5/60 \text{ m}^3/\text{s})}{(0.20 \text{ m})^2} = 0.208 \text{ m/s} \\ \text{Re} &= \frac{VD_h}{\nu} = \frac{(0.208 \text{ m/s})(0.20 \text{ m})}{1.61 \times 10^{-5} \text{ m}^2/\text{s}} = 2588\end{aligned}$$

From Table 15-2,

$$\text{Nu} = 0.102 \text{Re}^{0.675} \text{Pr}^{1/3} = (0.102)(2588)^{0.675} (0.728)^{1/3} = 18.5$$

$$h = \frac{k}{D_h} \text{Nu} = \frac{0.0259 \text{ W/m}\cdot^\circ\text{C}}{0.20 \text{ m}} (18.5) = 2.39 \text{ W/m}^2\cdot^\circ\text{C}$$

Then the highest component surface temperature in the duct becomes

$$\dot{Q} = h A_s (T_{s,max} - T_{air,out}) \longrightarrow T_{s,max} = T_{air,out} + \frac{\dot{Q}}{h A_s} = 39.8^\circ\text{C} + \frac{96 \text{ W}}{(2.39 \text{ W/m}^2\cdot^\circ\text{C})(0.8 \text{ m}^2)} = \mathbf{90.0^\circ\text{C}}$$

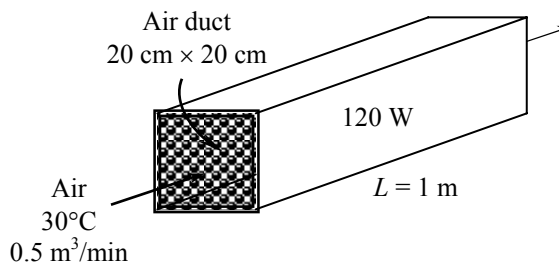

15-116 The components of an electronic system located in a circular horizontal duct are cooled by forced air flowing through the duct. The exit temperature of air and the highest component surface temperature in the duct are to be determined.

Assumptions 1 Steady operating conditions exist. 2 Air is an ideal gas. 3 The local atmospheric pressure is 1 atm.

Properties We use the properties of air at 1 atm and 30°C (Table A-15)

$$\begin{aligned}\rho &= 1.164 \text{ kg/m}^3 \\ c_p &= 1007 \text{ J/kg}\cdot^\circ\text{C} \\ \text{Pr} &= 0.728 \\ k &= 0.0259 \text{ W/m}\cdot^\circ\text{C} \\ \nu &= 1.61 \times 10^{-5} \text{ m}^2/\text{s}\end{aligned}$$

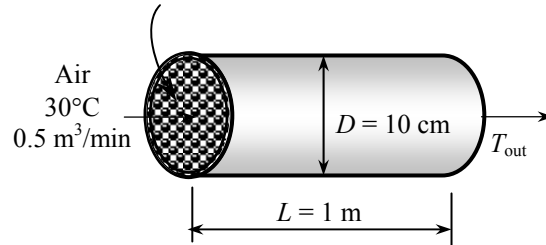

Analysis (a) The rate of heat transfer from the components to the forced air in the duct is

$$\dot{Q} = (0.80)(120 \text{ W}) = 96 \text{ W}$$

The mass flow rate of air is

$$\dot{m} = \rho \dot{V} = (1.164 \text{ kg/m}^3)(0.5/60 \text{ m}^3/\text{s}) = 0.0097 \text{ kg/s}$$

Then the exit temperature of air is determined from

$$\dot{Q} = \dot{m} c_p (T_{out} - T_{in}) \longrightarrow T_{out} = T_{in} + \frac{\dot{Q}}{\dot{m} c_p} = 30^\circ\text{C} + \frac{96 \text{ W}}{(0.0097 \text{ kg/s})(1007 \text{ J/kg}\cdot^\circ\text{C})} = \mathbf{39.8^\circ\text{C}}$$

(b) The highest surface temperature can be determined from

$$\dot{Q}_{conv} = h A_s (T_s - T_{fluid})$$

But we first need to determine convection heat transfer coefficient,

$$\begin{aligned}A_s &= \pi D L = \pi(0.1 \text{ m})(1 \text{ m}) = 0.314 \text{ m}^2 \\ V &= \frac{\dot{V}}{A_c} = \frac{(0.5/60 \text{ m}^3/\text{s})}{\pi(0.10 \text{ m})^2/4} = 1.061 \text{ m/s} \\ \text{Re} &= \frac{VD}{\nu} = \frac{(1.061 \text{ m/s})(0.10 \text{ m})}{1.61 \times 10^{-5} \text{ m}^2/\text{s}} = 6590\end{aligned}$$

From Table 15-2,

$$Nu = 0.102 \text{ Re}^{0.675} \text{ Pr}^{1/3} = (0.102)(6590)^{0.675} (0.728)^{1/3} = 34.7$$

$$h = \frac{k}{D_h} Nu = \frac{0.0259 \text{ W/m}\cdot^\circ\text{C}}{0.10 \text{ m}} (34.7) = 8.99 \text{ W/m}^2\cdot^\circ\text{C}$$

Then the highest component surface temperature in the duct becomes

$$\dot{Q} = h A_s (T_{s,max} - T_{air,out}) \longrightarrow T_{s,max} = T_{air,out} + \frac{\dot{Q}}{h A_s} = 39.8^\circ\text{C} + \frac{96 \text{ W}}{(8.99 \text{ W/m}^2\cdot^\circ\text{C})(0.314 \text{ m}^2)} = \mathbf{73.8^\circ\text{C}}$$

Liquid Cooling

15-117C When both are adequate, we would prefer forced air cooling in order to avoid the potential risks and problems associated with water cooling such as leakage, corrosion, extra weight, and condensation.

15-118C In direct cooling systems, the electronic components are in direct contact with the liquid, and thus the heat generated in the components is transferred directly to the liquid. In indirect cooling systems, however, there is no direct contact with the components. The heat generated in this case is first transferred to a medium such as a cold plate before it is removed by the liquid.

15-119C In closed loop cooling systems the liquid is recirculated while in the open loop systems the liquid is discarded after use. The heated liquid in closed loop systems is cooled in a heat exchanger, and it is recirculated through the system. In open loop systems, liquid (usually tap water) flows through the cooling system is discarded into a drain after it is heated.

15-120C The properties of a liquid ideally suited for cooling electronic equipment include high thermal conductivity, high specific heat, low viscosity, high surface tension, high dielectric strength, chemical inertness, chemical stability, being non toxic, having low freezing and high boiling points, and low cost.

15-121 A cold plate is to be cooled by water. The mass flow rate of water, the diameter of the pipe, and the case temperature of the transistors are to be determined.

Assumptions 1 Steady operating conditions exist. 2 About 25 percent of the heat generated is dissipated from the components to the surroundings by convection and radiation.

Properties The properties of water at room temperature are $\rho = 1000 \text{ kg/m}^3$ and $c_p = 4180 \text{ J/kg}\cdot^\circ\text{C}$ (Table A-9).

Analysis Noting that each of the 10 transistors dissipates 40 W of power and 75% of this power is removed by the water, the rate of heat transfer to the water is

$$\dot{Q} = (10 \text{ transistors})(40 \text{ W/transistor})(0.75) = 300 \text{ W}$$

In order to limit the temperature rise of water to 4°C , the mass flow rate of water must be no less than

$$\dot{m} = \frac{\dot{Q}}{c_p \Delta T_{\text{rise}}} = \frac{300 \text{ W}}{(4180 \text{ J/kg}\cdot^\circ\text{C})(4^\circ\text{C})} = 0.0179 \text{ kg/s} = \mathbf{1.08 \text{ kg/min}}$$

The diameter of the pipe to maintain the velocity under 0.5 m/s is determined from

$$\dot{m} = \rho A_c V = \rho \frac{\pi D^2}{4} V$$

$$D = \sqrt{\frac{4\dot{m}}{\pi\rho V}} = \sqrt{\frac{4(0.0179 \text{ kg/s})}{\pi(1000 \text{ kg/m}^3)(0.5 \text{ m/s})}} = 0.0068 \text{ m} = \mathbf{0.68 \text{ cm}}$$

Noting that the case-to-liquid thermal resistance is $0.04 \text{ }^\circ\text{C/W}$, the case temperature of the transistors is

$$\dot{Q} = \frac{T_{\text{case}} - T_{\text{liquid}}}{R_{\text{case-liquid}}} \longrightarrow T_{\text{case}} = T_{\text{liquid}} + \dot{Q}R_{\text{case-liquid}} = 25^\circ\text{C} + (300 \text{ W})(0.04 \text{ }^\circ\text{C/W}) = \mathbf{37^\circ\text{C}}$$

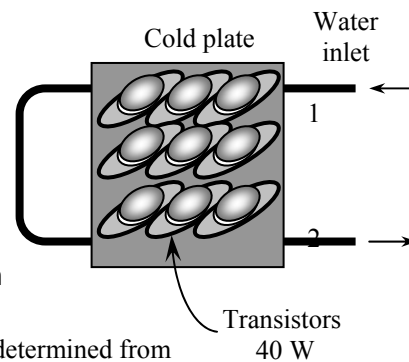

15-122 EES Prob. 15-121 is reconsidered. The effect of the maximum temperature rise of the water on the mass flow rate of water, the diameter of the pipe, and the case temperature is to be investigated.

Analysis The problem is solved using EES, and the solution is given below.

"GIVEN"

n_transistor=10
 Q_dot=40 [W]
 DELTAT_water=4 [C]
 Vel=0.5 [m/s]
 f_ConvRad=0.25
 f_water=0.75
 R_CaseLiquid=0.04 [C/W]
 T_water=25 [C]

"PROPERTIES"

Fluid\$='water'
 rho=Density(Fluid\$, T=T_water, P=101.3)
 C_p=CP(Fluid\$, T=T_water, P=101.3)*Convert(kJ/kg-C, J/kg-C)

"ANALYSIS"

Q_dot_total=n_transistor*Q_dot*f_water
 m_dot=Q_dot_total/(C_p*DELTAT_water)*Convert(kg/s, kg/min)
 m_dot*Convert(kg/min, kg/s)=rho*A*Vel
 A=pi*(D*Convert(mm, m))^2/4
 Q_dot_total=(T_case-T_water)/R_CaseLiquid

ΔT_{water} [C]	m [kg/min]	D [mm]	T_{case} [C]
1	4.31	13.54	37
1.5	2.873	11.05	37
2	2.155	9.574	37
2.5	1.724	8.563	37
3	1.437	7.817	37
3.5	1.231	7.237	37
4	1.077	6.77	37
4.5	0.9578	6.382	37
5	0.862	6.055	37
5.5	0.7836	5.773	37
6	0.7183	5.527	37
6.5	0.6631	5.31	37
7	0.6157	5.117	37
7.5	0.5747	4.944	37
8	0.5387	4.787	37
8.5	0.507	4.644	37
9	0.4789	4.513	37
9.5	0.4537	4.393	37
10	0.431	4.281	37

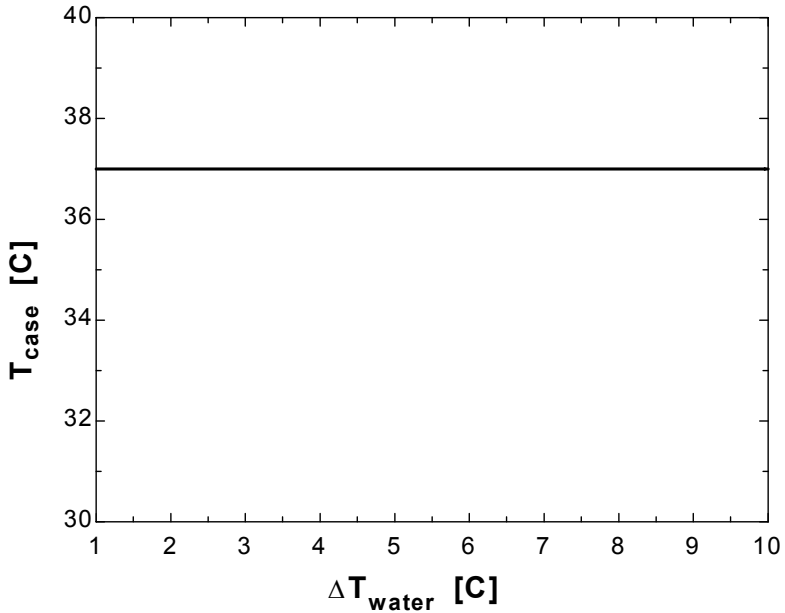
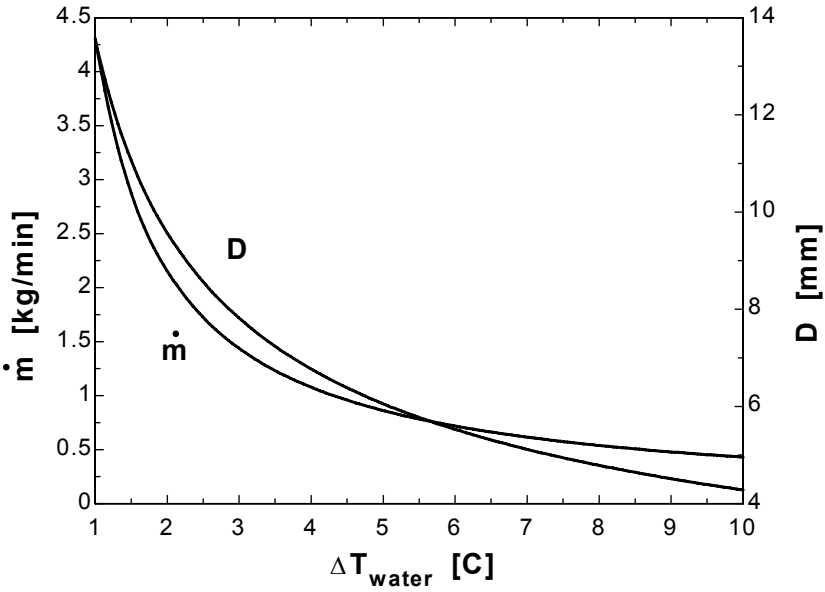

15-123E Electronic devices mounted on a cold plate is cooled by water. The amount of heat generated by the electronic devices is to be determined.

Assumptions 1 Steady operating conditions exist. 2 About 15 percent of the heat generated is dissipated from the components to the surroundings by convection and radiation.

Properties The properties of water at room temperature are $\rho = 62.2 \text{ lbm/ft}^3$ and $c_p = 0.998 \text{ Btu/lbm}\cdot^\circ\text{F}$.

Analysis The mass flow rate of water and the rate of heat removal by the water are

$$\dot{m} = \rho A_c V = \rho \frac{\pi D^2}{4} V = (62.2 \text{ lbm/ft}^3) \frac{\pi (0.25/12 \text{ ft})^2}{4} (60 \text{ ft/min}) = 1.272 \text{ lbm/min} = 76.33 \text{ lbm/h}$$

$$\dot{Q} = \dot{m} c_p (T_{out} - T_{in}) = (76.33 \text{ lbm/h})(0.998 \text{ Btu/lbm}\cdot^\circ\text{F})(105 - 95)^\circ\text{F} = 761.8 \text{ Btu/h}$$

which is 85 percent of the heat generated by the electronic devices. Then the total amount of heat generated by the electronic devices becomes

$$\dot{Q} = \frac{761.8 \text{ Btu/h}}{0.85} = \mathbf{896 \text{ Btu/h} = 263 \text{ W}}$$

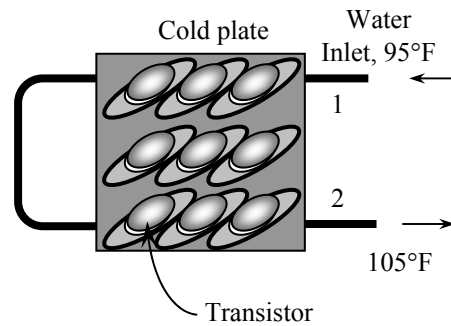

15-124 A sealed electronic box is to be cooled by tap water flowing through channels on two of its sides. The mass flow rate of water and the amount of water used per year are to be determined.

Assumptions 1 Steady operating conditions exist. 2 Entire heat generated is dissipated by water.

Properties The specific heat of water at room temperature is $c_p = 4180 \text{ J/kg}\cdot^\circ\text{C}$.

Analysis The mass flow rate of tap water flowing through the electronic box is

$$\dot{Q} = \dot{m} c_p \Delta T \longrightarrow \dot{m} = \frac{\dot{Q}}{c_p \Delta T} = \frac{2 \text{ kJ/s}}{(4.18 \text{ kJ/kg}\cdot^\circ\text{C})(3^\circ\text{C})} = \mathbf{0.1595 \text{ kg/s}}$$

Therefore, 0.1595 kg water is needed per second to cool this electronic box. Then the amount of cooling water used per year becomes

$$m = \dot{m} \Delta t = (0.1595 \text{ kg/s})(365 \text{ days/yr} \times 24 \text{ h/day} \times 3600 \text{ s/h}) \\ = 5,030,000 \text{ kg/yr} = \mathbf{5030 \text{ tons/yr}}$$

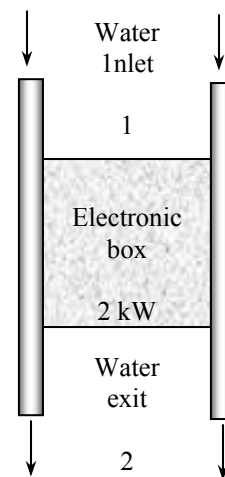

15-125 A sealed electronic box is to be cooled by tap water flowing through channels on two of its sides. The mass flow rate of water and the amount of water used per year are to be determined.

Assumptions 1 Steady operating conditions exist. 2 Entire heat generated is dissipated by water.

Properties The specific heat of water at room temperature is $c_p = 4180 \text{ J/kg}\cdot^\circ\text{C}$.

Analysis The mass flow rate of tap water flowing through the electronic box is

$$\dot{Q} = \dot{m}c_p\Delta T \longrightarrow \dot{m} = \frac{\dot{Q}}{c_p\Delta T} = \frac{3 \text{ kJ/s}}{(4.18 \text{ kJ/kg}\cdot^\circ\text{C})(3^\circ\text{C})} = \mathbf{0.2392 \text{ kg/s}}$$

Therefore, 0.2392 kg water is needed per second to cool this electronic box. Then the amount of cooling water used per year becomes

$$\begin{aligned} m &= \dot{m}\Delta t = (0.2392 \text{ kg/s})(365 \text{ days/yr} \times 24 \text{ h/day} \times 3600 \text{ s/h}) \\ &= 7,544,500 \text{ kg/yr} = \mathbf{7545 \text{ tons/yr}} \end{aligned}$$

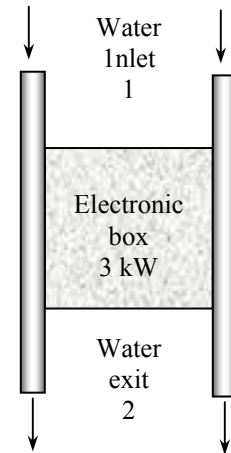

Immersion Cooling

15-126C The desirable characteristics of a dielectric liquid used in immersion cooling of electronic devices are non-flammability, being chemically inert, compatibility with materials used in electronic equipment, and low boiling and freezing points.

15-127C An open loop immersion cooling system involves an external reservoir which supplies liquid continually to the electronic enclosure. The vapor generated inside is allowed to escape to the atmosphere. A pressure relief valve on the vapor vent line keeps the pressure and thus the temperature inside the enclosure at a preset value. In a closed loop immersion system, the vapor is condensed and returned to the electronic enclosure instead of being purged into the atmosphere.

15-128C In external immersion cooling systems, the vapor is condensed outside the enclosure whereas in internal immersion cooling systems the vapor is condensed inside the enclosure by circulating a cooling fluid through the vapor. Therefore, in condenser is built into the enclosure in internal immersion cooling systems whereas it is placed outside in external immersion cooling systems.

15-129C The heat transfer coefficient is much greater in the boiling heat transfer than it is in the forced air or liquid cooling. Therefore, in the cooling of high-power electronic devices, boiling heat transfer is used to achieve high cooling rates with minimal temperature differences.

15-130 A logic chip is to be cooled by immersion in a dielectric fluid. The minimum heat transfer coefficient and the type of cooling mechanism are to be determined.

Assumptions Steady operating conditions exist.

Analysis The average heat transfer coefficient over the surface of the chip is determined from Newton's law of cooling to be

$$\begin{aligned}\dot{Q} &= hA_s(T_{chip} - T_{fluid}) \\ h &= \frac{\dot{Q}}{A_s(T_{chip} - T_{fluid})} \\ &= \frac{4 \text{ W}}{(0.3 \times 10^{-4} \text{ m}^2)(70 - 20)^\circ\text{C}} = \mathbf{2667 \text{ W/m}^2 \cdot ^\circ\text{C}}\end{aligned}$$

which is rather high. An examination of Fig. 15-62 reveals that we can obtain such heat transfer coefficients with the boiling of fluorocarbon fluids. Therefore, a suitable cooling technique in this case is immersion cooling in such a fluid.

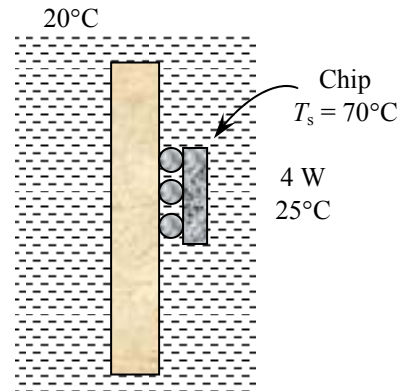

15-131 A chip is cooled by boiling in a dielectric fluid. The surface temperature of the chip is to be determined.

Assumptions The boiling curve in Fig. 15-63 is prepared for a chip having a surface area of 0.457 cm² being cooled in FC86 maintained at 5°C. The chart can be used for similar cases with reasonable accuracy.

Analysis The heat flux in this case is

$$\dot{q} = \frac{\dot{Q}}{A_s} = \frac{6 \text{ W}}{0.5 \text{ cm}^2} = 12 \text{ W/cm}^2$$

The temperature of the chip surface corresponding to this heat flux is determined from Fig. 15-63 to be

$$T_{chip} - T_{fluid} = 57^\circ\text{C} \rightarrow T_{chip} = (T_{fluid} + 57)^\circ\text{C} = (25 + 57)^\circ\text{C} = \mathbf{82^\circ\text{C}}$$

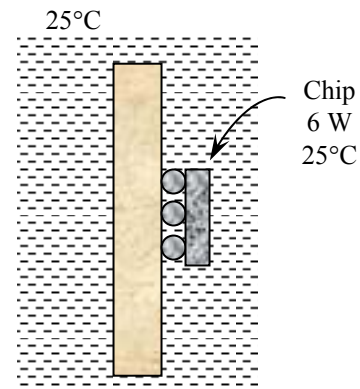

15-132 A logic chip is cooled by immersion in a dielectric fluid. The heat flux and the heat transfer coefficient on the surface of the chip and the thermal resistance between the surface of the chip and the cooling medium are to be determined.

Assumptions Steady operating conditions exist.

Analysis (a) The heat flux on the surface of the chip is

$$\dot{q} = \frac{\dot{Q}}{A_s} = \frac{3.5 \text{ W}}{0.8 \text{ cm}^2} = \mathbf{4.375 \text{ W/cm}^2}$$

(b) The heat transfer coefficient on the surface of the chip is

$$\begin{aligned} \dot{Q} &= hA_s(T_{chip} - T_{fluid}) \\ h &= \frac{\dot{Q}}{A_s(T_{chip} - T_{fluid})} \\ &= \frac{3.5 \text{ W}}{(0.8 \times 10^{-4} \text{ m}^2)(95 - 50)^\circ\text{C}} = \mathbf{972 \text{ W/m}^2 \cdot ^\circ\text{C}} \end{aligned}$$

(c) The thermal resistance between the surface of the chip and the cooling medium is

$$\dot{Q} = \frac{T_{chip} - T_{fluid}}{R_{chip-fluid}} \longrightarrow R_{chip-fluid} = \frac{T_{chip} - T_{fluid}}{\dot{Q}} = \frac{(95 - 50)^\circ\text{C}}{3.5 \text{ W}} = \mathbf{12.9^\circ\text{C/W}}$$

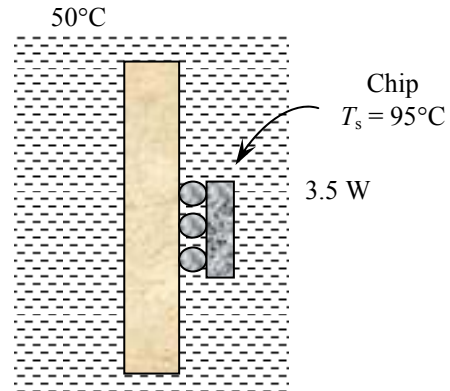

15-133 EES Prob. 15-132 is reconsidered. The effect of chip power on the heat flux, the heat transfer coefficient, and the convection resistance on chip surface is to be investigated.

Analysis The problem is solved using EES, and the solution is given below.

"GIVEN"

$$Q_{\text{dot_total}}=3.5 \text{ [W]}$$

$$T_{\text{ambient}}=50 \text{ [C]}$$

$$T_{\text{chip}}=95 \text{ [C]}$$

$$A=0.8 \text{ [cm}^2\text{]}$$

"ANALYSIS"

$$q_{\text{dot}}=Q_{\text{dot_total}}/A$$

$$Q_{\text{dot_total}}=h*A*\text{Convert}(\text{cm}^2, \text{m}^2)*(T_{\text{chip}}-T_{\text{ambient}})$$

$$Q_{\text{dot_total}}=(T_{\text{chip}}-T_{\text{ambient}})/R_{\text{ChipFluid}}$$

Q_{total} [W]	q [W/cm ²]	h [W/m ² -C]	$R_{\text{ChipFluid}}$ [C/W]
2	2.5	555.6	22.5
2.5	3.125	694.4	18
3	3.75	833.3	15
3.5	4.375	972.2	12.86
4	5	1111	11.25
4.5	5.625	1250	10
5	6.25	1389	9
5.5	6.875	1528	8.182
6	7.5	1667	7.5
6.5	8.125	1806	6.923
7	8.75	1944	6.429
7.5	9.375	2083	6
8	10	2222	5.625
8.5	10.63	2361	5.294
9	11.25	2500	5
9.5	11.88	2639	4.737
10	12.5	2778	4.5

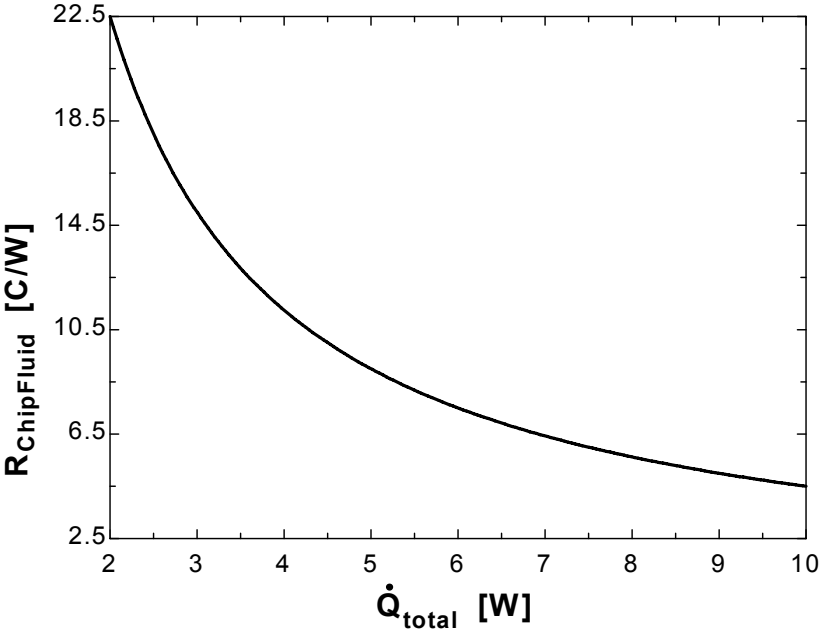
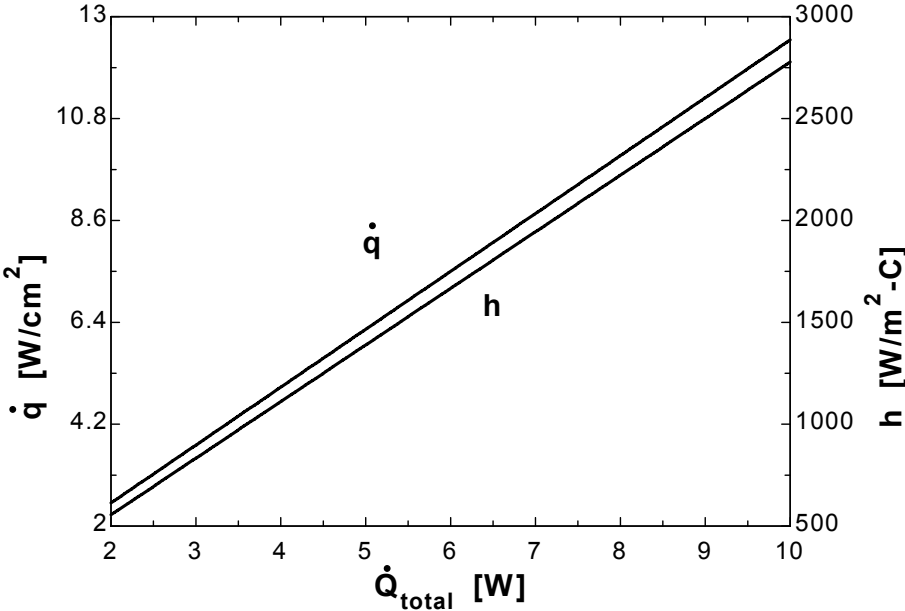

15-134 A computer chip is to be cooled by immersion in a dielectric fluid. The minimum heat transfer coefficient and the appropriate type of cooling mechanism are to be determined.

Assumptions Steady operating conditions exist.

Analysis The average heat transfer coefficient over the surface of the chip is determined from Newton's law of cooling to be

$$\begin{aligned}\dot{Q} &= hA_s(T_{chip} - T_{fluid}) \\ h &= \frac{\dot{Q}}{A_s(T_{chip} - T_{fluid})} = \frac{5 \text{ W}}{(0.4 \times 10^{-4} \text{ m}^2)(55 - 10)^\circ\text{C}} \\ &= \mathbf{2778 \text{ W/m}^2 \cdot ^\circ\text{C}}\end{aligned}$$

which is rather high. An examination of Fig. 15-62 reveals that we can obtain such heat transfer coefficients with the boiling of fluorocarbon fluids. Therefore, a suitable cooling technique in this case is immersion cooling in such a fluid.

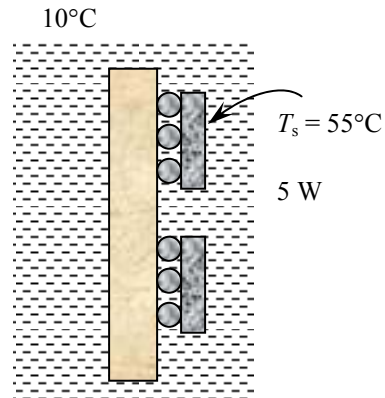

15-135 A chip is cooled by boiling in a dielectric fluid. The surface temperature of the chip is to be determined.

Assumptions The boiling curve in Fig. 15-63 is prepared for a chip having a surface area of 0.457 cm^2 being cooled in FC86 maintained at 5°C . The chart can be used for similar cases with reasonable accuracy.

Analysis The heat flux in this case is

$$\dot{q} = \frac{\dot{Q}}{A_s} = \frac{3 \text{ W}}{0.2 \text{ cm}^2} = 15 \text{ W/cm}^2$$

The temperature of the chip surface corresponding to this value is determined from Fig. 15-63 to be

$$T_{chip} - T_{fluid} = 63^\circ\text{C} \longrightarrow T_{chip} = (T_{fluid} + 63)^\circ\text{C} = (45 + 63)^\circ\text{C} = \mathbf{108^\circ\text{C}}$$

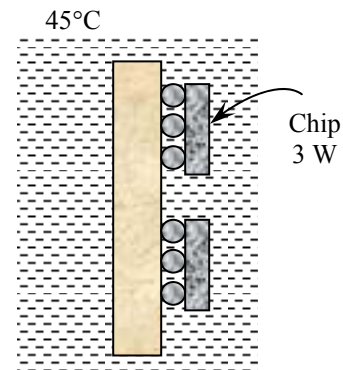

15-136 A chip is cooled by boiling in a dielectric fluid. The maximum power that the chip can dissipate safely is to be determined.

Assumptions The boiling curve in Fig. 15-63 is prepared for a chip having a surface area of 0.457 cm^2 being cooled in FC86 maintained at 5°C . The chart can be used for similar cases with reasonable accuracy.

Analysis The temperature difference between the chip surface and the liquid is

$$T_{\text{chip}} - T_{\text{fluid}} = (60 - 35)^\circ\text{C} = 25^\circ\text{C}$$

Using this value, the heat flux can be determined from Fig. 15-63 to be

$$\dot{q} = 3.3 \text{ W/cm}^2$$

Then the maximum power that the chip can dissipate safely becomes

$$\dot{Q} = \dot{q}A_s = (3.3 \text{ W/cm}^2)(0.3 \text{ cm}^2) = \mathbf{0.99 \text{ W}}$$

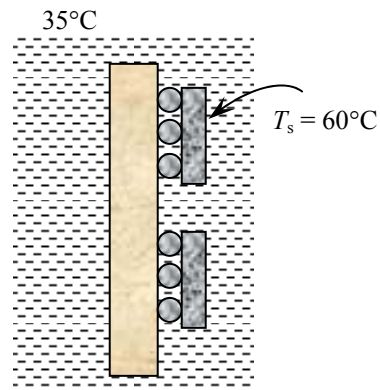

15-137 An electronic device is to be cooled by immersion in a dielectric fluid. It is to be determined if the heat generated inside can be dissipated to the ambient air by natural convection and radiation as well as the heat transfer coefficient at the surface of the electronic device.

Assumptions Steady operating conditions exist.

Analysis Assuming the surfaces of the cubic enclosure to be at the temperature of the boiling dielectric fluid at 60°C , the rate at which heat can be dissipated to the ambient air at 20°C by combined natural convection and radiation is determined from

$$\begin{aligned} \dot{Q} &= hA_s(T_s - T_{\text{air}}) = h(6a^2)(T_s - T_{\text{air}}) \\ &= (10 \text{ W/m}^2 \cdot ^\circ\text{C})[6(1 \text{ m})^2](60 - 20)^\circ\text{C} = 2400 \text{ W} = \mathbf{2.4 \text{ kW}} \end{aligned}$$

Therefore, the heat generated inside the cubic enclosure can be dissipated by natural convection and radiation. The heat transfer coefficient at the surface of the electronic device is

$$\dot{Q} = hA_s(T_s - T_{\text{fluid}}) \longrightarrow h = \frac{\dot{Q}}{A_s(T_s - T_{\text{fluid}})} = \frac{2000 \text{ W}}{(0.012 \text{ m}^2)(80 - 60)^\circ\text{C}} = \mathbf{8333 \text{ W/m}^2 \cdot ^\circ\text{C}}$$

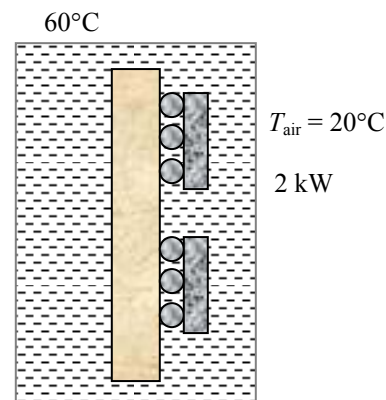

Review Problems

15-138C For most effective cooling, (1) the transistors must be mounted directly over the cooling lines, (2) the thermal contact resistance between the transistors and the cold plate must be minimized by attaching them tightly with a thermal grease, and (3) the thickness of the plates and the tubes should be as small as possible to minimize the thermal resistance between the transistors and the tubes.

15-139C There is no such thing as heat rising. Only heated fluid rises because of lower density due to buoyancy. Heat conduction in a solid is due to the molecular vibrations and electron movement, and gravitational force has no effect on it. Therefore, the orientation of the bar is irrelevant.

15-140 A multilayer circuit board consisting of four layers of copper and three layers of glass-epoxy sandwiched together is considered. The magnitude and location of the maximum temperature that occurs in the PCB are to be determined.

Assumptions 1 Steady operating conditions exist 2 Thermal properties are constant. 3 There is no direct heat dissipation from the surface of the PCB, and thus all the heat generated is conducted by the PCB to the heat sink.

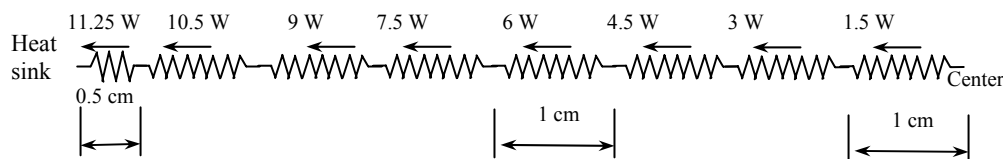

Analysis The effective thermal conductivity of the board is determined from

$$(k_1 t_1)_{copper} = 4[(386 \text{ W/m}\cdot\text{C})(0.0001 \text{ m})] = 0.1544 \text{ W/C}$$

$$(k_2 t_2)_{epoxy} = 3[(0.26 \text{ W/m}\cdot\text{C})(0.0005 \text{ m})] = 0.00039 \text{ W/C}$$

$$k_{eff} = \frac{(k_1 t_1)_{copper} + (k_2 t_2)_{epoxy}}{t_1 + t_2} = \frac{(0.1544 + 0.00039) \text{ W/C}}{4(0.0001 \text{ m}) + 3(0.0005 \text{ m})} = 81.5 \text{ W/m}\cdot\text{C}$$

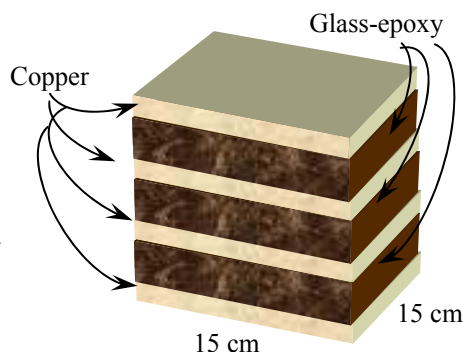

The maximum temperature will occur in the middle of the board which is farthest away from the heat sink. We consider half of the board because of symmetry, and divide the region in 1-cm thick strips, starting at the mid-plane. Then from Fourier's law, the temperature difference across a strip can be determined from

$$\dot{Q} = k_{eff} A \frac{\Delta T}{L} \longrightarrow \Delta T = \frac{\dot{Q}L}{k_{eff} A}$$

where $L = 1 \text{ cm} = 0.01 \text{ m}$ (except it is 0.5 cm for the strip attached to the heat sink), and the heat transfer area for all the strips is

$$A = (0.15 \text{ m})[4(0.0001 \text{ m}) + 3(0.0005 \text{ m})] = 0.000285 \text{ m}^2$$

Then the temperature at the center of the board is determined by adding the temperature differences across all the strips as

$$\begin{aligned} \Delta T_{\text{center-heat sink}} &= \sum \frac{\dot{Q}L}{k_{eff} A} = \frac{(\dot{Q}_1 + \dot{Q}_2 + \dot{Q}_3 + \dot{Q}_4 + \dot{Q}_5 + \dot{Q}_6 + \dot{Q}_7 + \dot{Q}_8 / 2)L}{k_{eff} A} \\ &= \frac{(1.5 + 3 + 4.5 + 6 + 7.5 + 9 + 10.5 + 11.25 / 2 \text{ W})(0.01 \text{ m})}{(81.5 \text{ W/m}\cdot\text{C})(0.000285 \text{ m}^2)} = 20.5^\circ\text{C} \end{aligned}$$

$$\text{and } T_{\text{center}} = T_{\text{heat sink}} + \Delta T_{\text{center-heat sink}} = 35^\circ\text{C} + 20.5^\circ\text{C} = 55.5^\circ\text{C}$$

Discussion This problem can also be solved approximately by using the "average" heat transfer rate for the entire half board, and treating it as a constant. The heat transfer rate in each half changes from 0 at the center to $22.5/2 = 11.25 \text{ W}$ at the heat sink, with an average of $11.25/2 = 5.625 \text{ W}$. Then the center temperature becomes

$$\dot{Q}_{avg} \cong k_{eff} A \frac{T_1 - T_2}{L} \longrightarrow T_{\text{center}} \cong T_{\text{heat sink}} + \frac{\dot{Q}_{ave} L}{k_{eff} A} = 35^\circ\text{C} + \frac{(5.625 \text{ W})(0.075 \text{ m})}{(81.5 \text{ W/m}\cdot\text{C})(0.000285 \text{ m}^2)} = 53.2^\circ\text{C}$$

15-141 A circuit board consisting of a single layer of glass-epoxy is considered. The magnitude and location of the maximum temperature that occurs in the PCB are to be determined.

Assumptions 1 Steady operating conditions exist 2 Thermal properties are constant. 3 There is no direct heat dissipation from the surface of the PCB, and thus all the heat generated is conducted by the PCB to the heat sink.

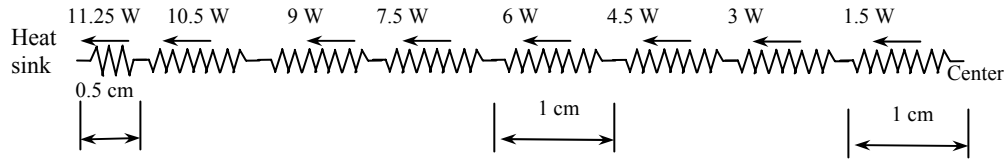

Analysis In this case the board consists of a 1.5-mm thick layer of epoxy. Again the maximum temperature will occur in the middle of the board which is farthest away from the heat sink. We consider half of the board because of symmetry, and divide the region in 1-cm thick strips, starting at the mid-plane. Then from Fourier's law, the temperature difference across a strip can be determined from

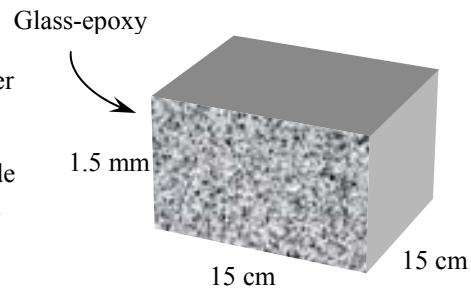

$$\dot{Q} = k_{eff} A \frac{\Delta T}{L} \longrightarrow \Delta T = \frac{\dot{Q}L}{k_{eff} A}$$

where $L = 1 \text{ cm} = 0.01 \text{ m}$ (except it is 0.5 cm for the strip attached to the heat sink), and the heat transfer area for all the strips is

$$A = (0.15 \text{ m})(0.0015 \text{ m}) = 0.000225 \text{ m}^2$$

Then the temperature at the center of the board is determined by adding the temperature differences across all the strips as

$$\begin{aligned} \Delta T_{\text{center-heat sink}} &= \sum \frac{\dot{Q}_i L}{k_{eff} A} = \frac{(\dot{Q}_1 + \dot{Q}_2 + \dot{Q}_3 + \dot{Q}_4 + \dot{Q}_5 + \dot{Q}_6 + \dot{Q}_7 + \dot{Q}_8 / 2)L}{k_{eff} A} \\ &= \frac{(1.5 + 3 + 4.5 + 6 + 7.5 + 9 + 10.5 + 11.25 / 2 \text{ W})(0.01 \text{ m})}{(0.26 \text{ W/m}\cdot\text{C})(0.000225 \text{ m}^2)} = 8141^\circ\text{C} \end{aligned}$$

$$\text{and } T_{\text{center}} = T_{\text{heat sink}} + \Delta T_{\text{center-heat sink}} = 35^\circ\text{C} + 8141^\circ\text{C} = \mathbf{8176^\circ\text{C}}$$

Discussion This problem can also be solved approximately by using the “average” heat transfer rate for the entire half board, and treating it as a constant. The heat transfer rate in each half changes from 0 at the center to $22.5/2 = 11.25 \text{ W}$ at the heat sink, with an average of $11.25/2 = 5.625 \text{ W}$. Then the center temperature becomes

$$\dot{Q}_{avg} \cong k_{eff} A \frac{T_1 - T_2}{L} \longrightarrow T_{\text{center}} \cong T_{\text{heat sink}} + \frac{\dot{Q}_{avg} L}{k_{eff} A} = 35^\circ\text{C} + \frac{(5.625 \text{ W})(0.075 \text{ m})}{(0.26 \text{ W/m}\cdot\text{C})(0.000225 \text{ m}^2)} = \mathbf{7247^\circ\text{C}}$$

15-142 The components of an electronic system located in a horizontal duct of rectangular cross-section are cooled by forced air flowing through the duct. The heat transfer from the outer surfaces of the duct by natural convection, the average temperature of the duct and the highest component surface temperature in the duct are to be determined.

Assumptions 1 Steady operating conditions exist. 2 Air is an ideal gas. 3 The local atmospheric pressure is 1 atm.

Properties We use the properties of air at $(30+45)/2 = 37.5^\circ\text{C}$ are (Table A-15)

$$\begin{aligned}\rho &= 1.136 \text{ kg/m}^3 \\ c_p &= 1007 \text{ J/kg}\cdot^\circ\text{C} \\ \text{Pr} &= 0.726 \\ k &= 0.0264 \text{ W/m}\cdot^\circ\text{C} \\ \nu &= 1.68 \times 10^{-5} \text{ m}^2/\text{s}\end{aligned}$$

Analysis (a) The volume and the mass flow rates of air are

$$\begin{aligned}\dot{V} &= A_c V = (0.1 \text{ m})(0.1 \text{ m})(50/60 \text{ m/s}) = 0.008333 \text{ m}^3/\text{s} \\ \dot{m} &= \rho \dot{V} = (1.136 \text{ kg/m}^3)(0.008333 \text{ m}^3/\text{s}) = 0.009466 \text{ kg/s}\end{aligned}$$

The rate of heat transfer to the air flowing through the duct is

$$\dot{Q}_{\text{forced conv}} = \dot{m} c_p (T_{\text{in}} - T_{\text{out}}) = (0.009466 \text{ kg/s})(1007 \text{ J/kg}\cdot^\circ\text{C})(45 - 30)^\circ\text{C} = 143.0 \text{ W}$$

Then the rate of heat loss from the outer surfaces of the duct to the ambient air by natural convection becomes

$$\dot{Q}_{\text{conv}} = \dot{Q}_{\text{total}} - \dot{Q}_{\text{forced conv}} = 150 \text{ W} - 143 \text{ W} = \mathbf{57 \text{ W}}$$

(b) The average surface temperature can be determined from

$$\dot{Q}_{\text{conv}} = h A_s (T_{s,\text{duct}} - T_{\text{ambient}})$$

But we first need to determine convection heat transfer coefficient. Using the Nusselt number relation from Table 15-2,

$$\begin{aligned}A_s &= (4)(0.1 \text{ m})(1 \text{ m}) = 0.4 \text{ m}^2 \\ \text{Re} &= \frac{VD_h}{\nu} = \frac{(50/60 \text{ m/s})(0.1 \text{ m})}{1.68 \times 10^{-5} \text{ m}^2/\text{s}} = 4960 \\ \text{Nu} &= 0.102 \text{Re}^{0.675} \text{Pr}^{1/3} = (0.102)(4960)^{0.675} (0.726)^{1/3} = 28.6 \\ h &= \frac{k}{D_h} \text{Nu} = \frac{0.0264 \text{ W/m}\cdot^\circ\text{C}}{0.1 \text{ m}} (28.6) = 7.56 \text{ W/m}^2\cdot^\circ\text{C}\end{aligned}$$

Then the average surface temperature of the duct becomes

$$\dot{Q}_{\text{conv}} = h A_s (T_s - T_{\text{ambient}}) \longrightarrow T_s = T_{\text{ambient}} + \frac{\dot{Q}_{\text{conv}}}{h A_s} = 30^\circ\text{C} + \frac{57 \text{ W}}{(7.56 \text{ W/m}^2\cdot^\circ\text{C})(0.4 \text{ m}^2)} = \mathbf{48.9^\circ\text{C}}$$

(c) The highest component surface temperature will occur at the exit of the duct. From Newton's law relation at the exit,

$$\dot{q}_{\text{conv}} = h(T_{s,\text{max}} - T_{\text{air,exit}}) \longrightarrow T_{s,\text{max}} = T_{\text{air,exit}} + \frac{\dot{Q}_{\text{conv}}/A_s}{h} = 45^\circ\text{C} + \frac{57 \text{ W}}{(7.56 \text{ W/m}^2\cdot^\circ\text{C})(0.4 \text{ m}^2)} = \mathbf{63.8^\circ\text{C}}$$

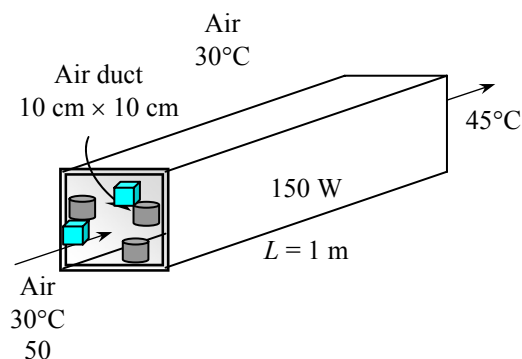

15-143 Two power transistors are cooled by mounting them on the two sides of an aluminum bracket that is attached to a liquid-cooled plate. The temperature of the transistor case and the fraction of heat dissipation to the ambient air by natural convection and to the cold plate by conduction are to be determined.

Assumptions 1 Steady operating conditions exist **2** Conduction heat transfer is one-dimensional. **3** We assume the ambient temperature is 25°C.

Analysis The rate of heat transfer by conduction is

$$\dot{Q}_{conduction} = (0.80)(12 \text{ W}) = 9.6 \text{ W}$$

Assuming heat conduction in the plate to be one-dimensional for simplicity, the thermal resistance of the aluminum plate and epoxy adhesive are

$$R_{aluminum} = \frac{L}{kA} = \frac{0.02 \text{ m}}{(237 \text{ W/m}\cdot\text{C})(0.003 \text{ m})(0.03 \text{ m})} = 0.938^\circ\text{C/W}$$

$$R_{epoxy} = \frac{L}{kA} = \frac{0.0002 \text{ m}}{(1.8 \text{ W/m}\cdot\text{C})(0.003 \text{ m})(0.03 \text{ m})} = 1.235^\circ\text{C/W}$$

The total thermal resistance of the plate and the epoxy is

$$R_{plate+epoxy} = R_{epoxy} + R_{plate} = 1.235 + 0.938 = 2.173^\circ\text{C/W}$$

Heat generated by the transistors is conducted to the plate, and then it is dissipated to the cold plate by conduction, and to the ambient air by convection. Denoting the plate temperature where the transistors are connected as $T_{s,max}$ and using the heat transfer coefficient relation from Table 15-1 for a vertical plate, the total heat transfer from the plate can be expressed as

$$\dot{Q}_{total} = \dot{Q}_{cond} + \dot{Q}_{conv} = \frac{\Delta T_{plate}}{R_{plate+epoxy}} + hA_{side}(T_{s,ave} - T_{air})$$

$$= \frac{T_{s,max} - T_{cold \text{ plate}}}{R_{plate+epoxy}} + 1.42 \left(\frac{T_{s,ave} - T_{air}}{L} \right)^{0.25} A_{side}(T_{s,max} - T_{air})$$

where $T_{s,ave} = (T_{s,max} + T_{cold \text{ plate}})/2$, $L = 0.03 \text{ m}$, and $A_{side} = 2(0.03 \text{ m})(0.03 \text{ m}) = 0.0018 \text{ m}^2$.

Substituting the known quantities gives

$$20 \text{ W} = \frac{T_{s,max} - 40}{2.173^\circ\text{C/W}} + 1.42(0.0018) \frac{[(T_{s,max} + 40)/2 - 25]^{1.25}}{(0.03)^{0.25}}$$

Solving for $T_{s,max}$ gives

$$T_{s,max} = 83.3^\circ\text{C}$$

Then the rate of heat transfer by natural convection becomes

$$\dot{Q}_{conv} = 1.42(0.0018) \frac{[(83.3 + 40)/2 - 25]^{1.25}}{(0.03)^{0.25}} = 0.055 \text{ W}$$

which is $0.055/20 = 0.00275$ or **0.3%** of the total heat dissipated. The remaining **99.7%** of the heat is transferred by conduction. Therefore, heat transfer by natural convection is negligible. Then the surface temperature of the transistor case becomes

$$T_{case} = T_{s,max} + \dot{Q}R_{plastic \text{ washer}} = 83.3^\circ\text{C} + (10 \text{ W})(2^\circ\text{C/W}) = \mathbf{103.3^\circ\text{C}}$$

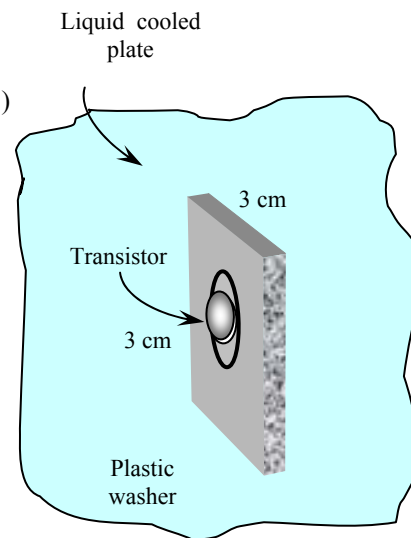

15-144E A plastic DIP with 24 leads is cooled by forced air. Using data supplied by the manufacturer, the junction temperature is to be determined for two cases.

Assumptions Steady operating conditions exist.

Analysis The junction-to-ambient thermal resistance of the device with 24 leads corresponding to an air velocity of $500 \times 0.3048 = 152.4$ m/min is determined from Fig. 15-23 to be

$$R_{\text{junction-ambient}} = 50 \text{ }^\circ\text{C/W} = (50 \times 1.8) + 32 = 122 \text{ }^\circ\text{F/W}$$

Then the junction temperature becomes

$$\begin{aligned} \dot{Q} &= \frac{T_{\text{junction}} - T_{\text{ambient}}}{R_{\text{junction-ambient}}} \longrightarrow T_{\text{junction}} = T_{\text{ambient}} + \dot{Q}R_{\text{junction-ambient}} \\ &= 70^\circ\text{F} + (1.5 \text{ W})(122 \text{ }^\circ\text{F/W}) = \mathbf{253^\circ\text{F}} \end{aligned}$$

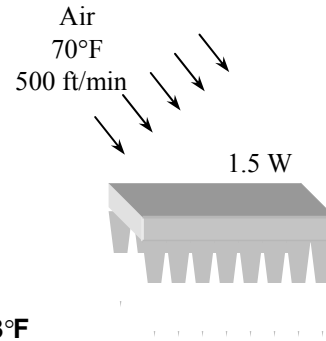

When the fan fails the total thermal resistance is determined from Fig. 15-23 by reading the value at the intersection of the curve at the vertical axis to be

$$R_{\text{junction-ambient}} = 66 \text{ }^\circ\text{C/W} = (66 \times 1.8) + 32 = 150.8 \text{ }^\circ\text{F/W}$$

which yields

$$\begin{aligned} \dot{Q} &= \frac{T_{\text{junction}} - T_{\text{ambient}}}{R_{\text{junction-ambient}}} \longrightarrow T_{\text{junction}} = T_{\text{ambient}} + \dot{Q}R_{\text{junction-ambient}} \\ &= 70^\circ\text{F} + (1.5 \text{ W})(150.8 \text{ }^\circ\text{F/W}) = \mathbf{296^\circ\text{F}} \end{aligned}$$

15-145 A circuit board is to be conduction-cooled by aluminum core plate sandwiched between two epoxy laminates. The maximum temperature rise between the center and the sides of the PCB is to be determined.

Assumptions 1 Steady operating conditions exist 2 Thermal properties are constant. 3 There is no direct heat dissipation from the surface of the PCB., and thus all the heat generated is conducted by the PCB to the heat sink.

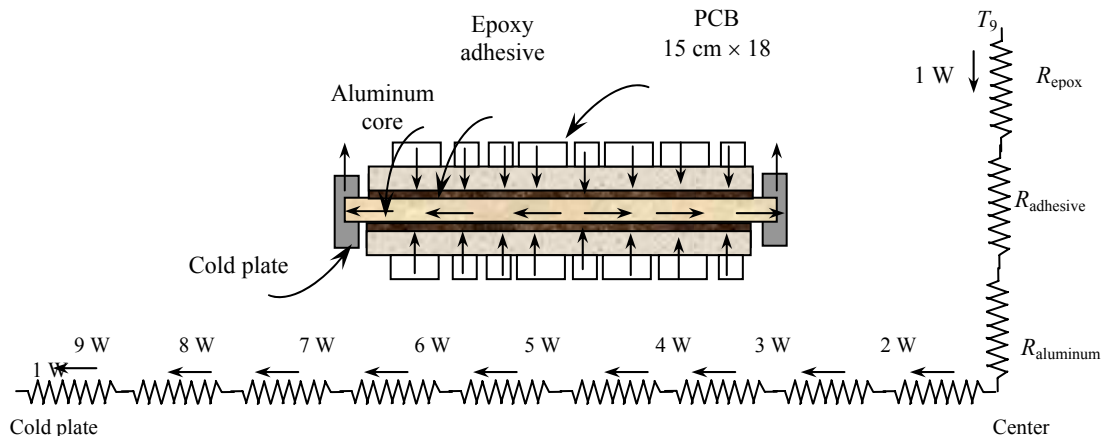

Analysis Using the half thickness of the aluminum frame because of symmetry, the thermal resistances against heat flow in the vertical direction for a 1-cm wide strip are

$$R_{\text{aluminum},\perp} = \frac{L}{kA} = \frac{0.0006 \text{ m}}{(237 \text{ W/m}\cdot\text{C})(0.01 \text{ m})(0.15 \text{ m})} = 0.00169 \text{ }^{\circ}\text{C/W}$$

$$R_{\text{epoxy}} = \frac{L}{kA} = \frac{0.0005 \text{ m}}{(0.26 \text{ W/m}\cdot\text{C})(0.01 \text{ m})(0.15 \text{ m})} = 1.28205 \text{ }^{\circ}\text{C/W}$$

$$R_{\text{adhesive}} = \frac{L}{kA} = \frac{0.0001 \text{ m}}{(1.8 \text{ W/m}\cdot\text{C})(0.01 \text{ m})(0.15 \text{ m})} = 0.03703 \text{ }^{\circ}\text{C/W}$$

$$R_{\text{vertical}} = R_{\text{aluminum},\perp} + R_{\text{epoxy}} + R_{\text{adhesive}} = 0.00169 + 1.28205 + 0.03704 = 1.321 \text{ }^{\circ}\text{C/W}$$

We assume heat conduction along the epoxy and adhesive in the horizontal direction to be negligible, and heat to be conduction to the heat sink along the aluminum frame. The thermal resistance of the aluminum frame against heat conduction in the horizontal direction for a 1-cm long strip is

$$R_{\text{frame}} = R_{\text{aluminum},\parallel} = \frac{L}{kA} = \frac{0.01 \text{ m}}{(237 \text{ W/m}\cdot\text{C})(0.0012 \text{ m})(0.18 \text{ m})} = 0.1953 \text{ }^{\circ}\text{C/W}$$

The temperature difference across a strip is determined from

$$\Delta T = \dot{Q} R_{\text{aluminum},\parallel}$$

The maximum temperature rise across the 9 cm distance between the center and the sides of the board is determined by adding the temperature differences across all the strips as

$$\begin{aligned} \Delta T_{\text{horizontal}} &= \sum \dot{Q} R_{\text{aluminum},\parallel} = (\dot{Q}_1 + \dot{Q}_2 + \dot{Q}_3 + \dot{Q}_4 + \dot{Q}_5 + \dot{Q}_6 + \dot{Q}_7 + \dot{Q}_8 + \dot{Q}_9) R_{\text{aluminum},\parallel} \\ &= (1 + 2 + 3 + 4 + 5 + 6 + 7 + 8 + 9 \text{ W})(0.1953 \text{ }^{\circ}\text{C/W}) = 8.8 \text{ }^{\circ}\text{C} \end{aligned}$$

The temperature difference between the center of the aluminum core and the outer surface of the PCB is determined similarly to be

$$\Delta T_{\text{vertical}} = \sum \dot{Q} R_{\text{vertical},\perp} = (1 \text{ W})(1.321 \text{ }^{\circ}\text{C/W}) = 1.3 \text{ }^{\circ}\text{C}$$

Then the maximum temperature rise across the 9-cm distance between the center and the sides of the PCB becomes

$$\Delta T_{\text{max}} = \Delta T_{\text{horizontal}} + \Delta T_{\text{vertical}} = 8.8 + 1.3 = \mathbf{10.1 \text{ }^{\circ}\text{C}}$$

15-146 Ten power transistors attached to an aluminum plate are cooled from two sides of the plate by liquid. The temperature rise between the transistors and the heat sink is to be determined.

Assumptions 1 Steady operating conditions exist 2 Thermal properties are constant.

Analysis We consider only half of the plate because of symmetry. It is stated that 70% of the heat generated is conducted through the aluminum plate, and this heat will be conducted across the 1-cm wide section between the transistors and the cooled edge of the plate. (Note that the mid section of the plate will essentially be isothermal and thus there will be no significant heat transfer towards the midsection). The rate of heat conduction to each side is of the plate is

$$\dot{Q}_{\text{cond,1-side}} = 0.70 \times (10 \text{ W}) = 7 \text{ W}$$

Then the temperature rise across the 1-cm wide section of the plate can be determined from

$$\dot{Q}_{\text{cond,1-side}} = kA \frac{(\Delta T)_{\text{plate}}}{L}$$

Solving for $(\Delta T)_{\text{plate}}$ and substituting gives

$$(\Delta T)_{\text{plate}} = \frac{\dot{Q}_{\text{cond,1-side}} L}{kA} = \frac{(7 \text{ W})(0.01 \text{ m})}{(237 \text{ W/m}\cdot\text{°C})(0.07 \times 0.002 \text{ m}^2)} = \mathbf{2.1\text{°C}}$$

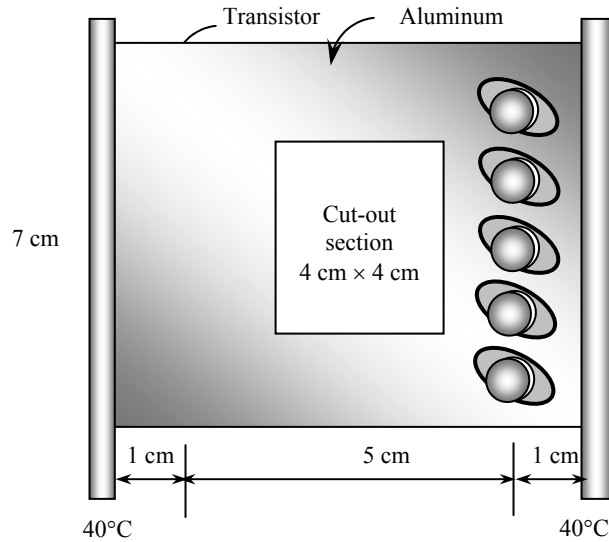

15-147 The components of an electronic system located in a horizontal duct are cooled by air flowing over the duct. The total power rating of the electronic devices that can be mounted in the duct is to be determined for two cases.

Assumptions 1 Steady operating conditions exist 2 Thermal properties of air are constant. 3 The local atmospheric pressure is 1 atm.

Properties The properties of air at the film temperature of $(30+60)/2 = 45^\circ\text{C}$ are (Table A-15)

$$\text{Pr} = 0.724$$

$$k = 0.0270 \text{ W/m}\cdot^\circ\text{C}$$

$$\nu = 1.75 \times 10^{-5} \text{ m}^2/\text{s}$$

Analysis The surface area of the duct is

$$A_s = 2\{[(1.2 \text{ m})(0.1 \text{ m})] + [(1.2 \text{ m})(0.2 \text{ m})]\} = 0.72 \text{ m}^2$$

The duct is oriented such that air strikes the 10 cm high side normally. Using the Nusselt number relation from Table 15-2 for a 10-cm by 10-cm cross-section square as an approximation, the heat transfer coefficient is determined to be

$$\text{Re} = \frac{VD}{\nu} = \frac{(250/60 \text{ m/s})(0.1 \text{ m})}{1.75 \times 10^{-5} \text{ m}^2/\text{s}} = 23,810$$

$$\text{Nu} = 0.102 \text{Re}^{0.675} \text{Pr}^{1/3} = (0.102)(23,810)^{0.675} (0.724)^{1/3} = 82.4$$

$$h = \frac{k}{D_h} \text{Nu} = \frac{0.0270 \text{ W/m}\cdot^\circ\text{C}}{0.1 \text{ m}} (82.4) = 22.3 \text{ W/m}^2\cdot^\circ\text{C}$$

Then the heat transfer rate (and thus the power rating of the components inside) in this orientation is determined from

$$\dot{Q} = hA_s(T_s - T_{\text{fluid}}) = (22.3 \text{ W/m}^2\cdot^\circ\text{C})(0.72 \text{ m}^2)(60 - 30)^\circ\text{C} = \mathbf{481 \text{ W}}$$

We now consider the duct oriented such that air strikes the 20 cm high side normally. Using the Nusselt number relation from Table 15-2 for a 20-cm by 20-cm cross-section square as an approximation, the heat transfer coefficient is determined to be

$$\text{Re} = \frac{VD}{\nu} = \frac{(250/60 \text{ m/s})(0.2 \text{ m})}{1.75 \times 10^{-5} \text{ m}^2/\text{s}} = 47,619$$

$$\text{Nu} = 0.102 \text{Re}^{0.675} \text{Pr}^{1/3} = (0.102)(47,619)^{0.675} (0.724)^{1/3} = 131.6$$

$$h = \frac{k}{D_h} \text{Nu} = \frac{0.0270 \text{ W/m}\cdot^\circ\text{C}}{0.2 \text{ m}} (131.6) = 17.8 \text{ W/m}^2\cdot^\circ\text{C}$$

Then the heat transfer rate (and thus the power rating of the components inside) in this orientation is determined from

$$\dot{Q} = hA_s(T_s - T_{\text{fluid}}) = (17.8 \text{ W/m}^2\cdot^\circ\text{C})(0.72 \text{ m}^2)(60 - 30)^\circ\text{C} = \mathbf{384 \text{ W}}$$

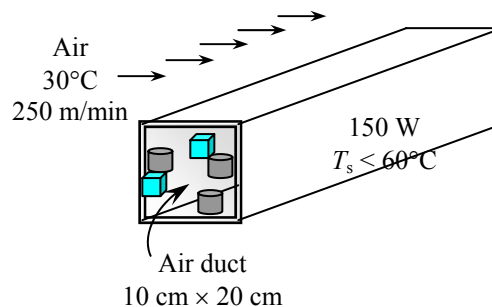

15-148 The components of an electronic system located in a horizontal duct are cooled by air flowing over the duct. The total power rating of the electronic devices that can be mounted in the duct is to be determined for two cases.

Assumptions 1 Steady operating conditions exist 2 Thermal properties of air are constant. 3 The local atmospheric pressure is 1 atm.

Properties The properties of air at the film temperature of $(30+60)/2 = 45^\circ\text{C}$ and 54.05 kPa are (Table A-15)

$$\text{Pr} = 0.724$$

$$k = 0.0270 \text{ W/m}\cdot^\circ\text{C}$$

$$\nu = \frac{1.75 \times 10^{-5} \text{ m}^2/\text{s}}{54.05/101.325} = 3.28 \times 10^{-5} \text{ m}^2/\text{s}$$

Analysis The surface area of the duct is

$$A_s = 2\{[(1.2 \text{ m})(0.1 \text{ m})] + [(1.2 \text{ m})(0.2 \text{ m})]\} = 0.72 \text{ m}^2$$

The duct is oriented such that air strikes the 10 cm high side normally. Using the Nusselt number relation from Table 15-2 for a 10-cm by 10-cm cross-section square as an approximation, the heat transfer coefficient is determined to be

$$\text{Re} = \frac{VD}{\nu} = \frac{(250/60 \text{ m/s})(0.1 \text{ m})}{3.28 \times 10^{-5} \text{ m}^2/\text{s}} = 12,703$$

$$\text{Nu} = 0.102 \text{Re}^{0.675} \text{Pr}^{1/3} = (0.102)(12,703)^{0.675} (0.724)^{1/3} = 53.9$$

$$h = \frac{k}{D_h} \text{Nu} = \frac{0.0270 \text{ W/m}\cdot^\circ\text{C}}{0.1 \text{ m}} (53.9) = 14.6 \text{ W/m}^2\cdot^\circ\text{C}$$

Then the heat transfer rate (and thus the power rating of the components inside) in this orientation is determined from

$$\dot{Q} = hA_s(T_s - T_{\text{fluid}}) = (14.6 \text{ W/m}^2\cdot^\circ\text{C})(0.72 \text{ m}^2)(60 - 30)^\circ\text{C} = \mathbf{315 \text{ W}}$$

We now consider the duct oriented such that air strikes the 20 cm high side normally. Using the Nusselt number relation from Table 15-2 for a 20-cm by 20-cm cross-section square as an approximation, the heat transfer coefficient is determined to be

$$\text{Re} = \frac{VD}{\nu} = \frac{(250/60 \text{ m/s})(0.2 \text{ m})}{3.28 \times 10^{-5} \text{ m}^2/\text{s}} = 25,407$$

$$\text{Nu} = 0.102 \text{Re}^{0.675} \text{Pr}^{1/3} = (0.102)(25,407)^{0.675} (0.724)^{1/3} = 86.1$$

$$h = \frac{k}{D_h} \text{Nu} = \frac{0.0270 \text{ W/m}\cdot^\circ\text{C}}{0.2 \text{ m}} (86.1) = 11.6 \text{ W/m}^2\cdot^\circ\text{C}$$

Then the heat transfer rate (and thus the power rating of the components inside) in this orientation is determined from

$$\dot{Q} = hA_s(T_s - T_{\text{fluid}}) = (11.6 \text{ W/m}^2\cdot^\circ\text{C})(0.72 \text{ m}^2)(60 - 30)^\circ\text{C} = \mathbf{251 \text{ W}}$$

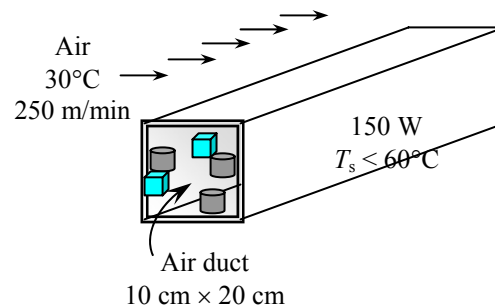

15-149E A computer is cooled by a fan blowing air into the computer enclosure. The fraction of heat lost from the outer surfaces of the computer case is to be determined.

Assumptions 1 Steady operating conditions exist 2 Thermal properties of air are constant. 3 The local atmospheric pressure is 1 atm.

Analysis Using the proper relation from Table 15-1, the heat transfer coefficient and the rate of natural convection heat transfer from the vertical side surfaces are determined to be

$$L = \frac{6}{12} \text{ ft}$$

$$A_{\text{side}} = (2) \left(\frac{20}{12} \text{ ft} + \frac{24}{12} \text{ ft} \right) \left(\frac{6}{12} \text{ ft} \right) = 3.67 \text{ ft}^2$$

$$h_{\text{conv,side}} = 1.42 \left(\frac{\Delta T}{L} \right)^{0.25} = 1.42 \left(\frac{95 - 80}{6/12} \right)^{0.25} = 3.32 \text{ Btu/h}\cdot\text{ft}^2\cdot^{\circ}\text{F}$$

$$\dot{Q}_{\text{conv,side}} = h_{\text{conv,side}} A_{\text{side}} (T_s - T_{\text{fluid}}) = (3.32 \text{ Btu/h}\cdot\text{ft}^2\cdot^{\circ}\text{F})(3.67 \text{ ft}^2)(95 - 80)^{\circ}\text{F} = 182.9 \text{ Btu/h}$$

Similarly, the rate of heat transfer from the horizontal top surface by natural convection is determined to be

$$L = \frac{4A_{\text{top}}}{P} = \frac{4 \left(\frac{20}{12} \text{ ft} \right) \left(\frac{24}{12} \text{ ft} \right)}{2 \left[\left(\frac{20}{12} \text{ ft} \right) + \left(\frac{24}{12} \text{ ft} \right) \right]} = 1.82 \text{ ft}$$

$$A_{\text{top}} = \left(\frac{20}{12} \text{ ft} \right) \left(\frac{24}{12} \text{ ft} \right) = 3.33 \text{ ft}^2$$

$$h_{\text{conv,top}} = 1.32 \left(\frac{\Delta T}{L} \right)^{0.25} = 1.32 \left(\frac{95 - 80}{1.82} \right)^{0.25} = 2.24 \text{ Btu/h}\cdot\text{ft}^2\cdot^{\circ}\text{F}$$

$$\dot{Q}_{\text{conv,top}} = h_{\text{conv,top}} A_{\text{top}} (T_s - T_{\text{fluid}}) = (2.24 \text{ Btu/h}\cdot\text{ft}^2\cdot^{\circ}\text{F})(3.33 \text{ ft}^2)(95 - 80)^{\circ}\text{F} = 111.7 \text{ Btu/h}$$

The rate of heat transfer from the outer surfaces of the computer case by radiation is

$$\begin{aligned} \dot{Q}_{\text{rad}} &= \varepsilon A_s \sigma (T_s^4 - T_{\text{surr}}^4) \\ &= (0.85)(3.67 \text{ ft}^2 + 3.33 \text{ ft}^2)(0.1714 \text{ Btu/h}\cdot\text{ft}^2\cdot\text{R}^4)[(95 + 460 \text{ R})^4 - (80 + 273 \text{ R})^4] \\ &= 100.4 \text{ Btu/h} \end{aligned}$$

Then the total rate of heat transfer from the outer surfaces of the computer case becomes

$$\dot{Q}_{\text{total}} = \dot{Q}_{\text{conv,side}} + \dot{Q}_{\text{conv,top}} + \dot{Q}_{\text{rad}} = 182.9 + 111.7 + 100.4 = 395 \text{ Btu/h}$$

Therefore, the fraction of the heat loss from the outer surfaces of the computer case is

$$f = \frac{(395 / 3.41214) \text{ W}}{165 \text{ W}} = 0.70 = \mathbf{70\%}$$

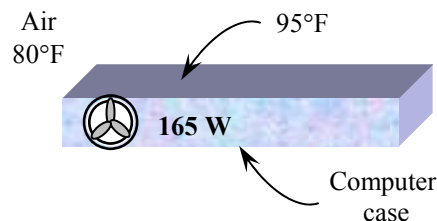

15-150 . . . 15-152 Design and Essay Problems



Chapter 16

HEATING AND COOLING OF BUILDINGS

A Brief History

16-1C Ice can be made by evacuating the air in a water tank. During evacuation, vapor is also thrown out, and thus the vapor pressure in the tank drops, causing a difference between the vapor pressures at the water surface and in the tank. This pressure difference is the driving force of vaporization, and forces the liquid to evaporate. But the liquid must absorb the heat of vaporization before it can vaporize, and it absorbs it from the liquid and the air in the neighborhood, causing the temperature in the tank to drop. The process continues until water starts freezing. The process can be made more efficient by insulating the tank well so that the entire heat of vaporization comes essentially from the water.

16-2C The first ammonia absorption refrigeration system was developed in 1851 by Ferdinand Carre. The formulas related to dry-bulb, wet-bulb, and dew-point temperatures were developed by Willis Carrier in 1911.

16-3C The concept of *heat pump* was conceived by Sadi Carnot in 1824. The first heat pump was built by T. G. N. Haldane in 1930, and the heat pumps were mass produced in 1952.

Human Body and Thermal Comfort

16-4C The metabolism refers to the burning of foods such as carbohydrates, fat, and protein in order to perform the necessary bodily functions. The metabolic rate for an average man ranges from 108 W while reading, writing, typing, or listening to a lecture in a classroom in a seated position to 1250 W at age 20 (730 at age 70) during strenuous exercise. The corresponding rates for women are about 30 percent lower. Maximum metabolic rates of trained athletes can exceed 2000 W. We are interested in metabolic rate of the occupants of a building when we deal with heating and air conditioning because the metabolic rate represents the rate at which a body generates heat and dissipates it to the room. This body heat contributes to the heating in winter, but it adds to the cooling load of the building in summer.

16-5C The metabolic rate is proportional to the size of the body, and the metabolic rate of women, in general, is lower than that of men because of their smaller size. Clothing serves as insulation, and the thicker the clothing, the lower the environmental temperature that feels comfortable.

16-6C Asymmetric thermal radiation is caused by the *cold surfaces* of large windows, uninsulated walls, or cold products on one side, and the *warm surfaces* of gas or electric radiant heating panels on the walls or ceiling, solar heated masonry walls or ceilings on the other. Asymmetric radiation causes discomfort by exposing different sides of the body to surfaces at different temperatures and thus to different rates of heat loss or gain by radiation. A person whose left side is exposed to a cold window, for example, will feel like heat is being drained from that side of his or her body.

16-7C (a) Draft causes undesired local cooling of the human body by exposing parts of the body to high heat transfer coefficients. (b) Direct contact with *cold floor surfaces* causes localized discomfort in the feet by excessive heat loss by conduction, dropping the temperature of the bottom of the feet to uncomfortable levels.

16-8C Stratification is the formation of vertical still air layers in a room at different temperatures, with highest temperatures occurring near the ceiling. It is likely to occur at places with high ceilings. It causes discomfort by exposing the head and the feet to different temperatures. This effect can be prevented or minimized by using destratification fans (ceiling fans running in reverse).

16-9C It is necessary to ventilate buildings to provide adequate fresh air and to get rid of excess carbon dioxide, contaminants, odors, and humidity. Ventilation increases the energy consumption for heating in winter by replacing the warm indoors air by the colder outdoors air. Ventilation also increases the energy consumption for cooling in summer by replacing the cold indoors air by the warm outdoors air. It is not a good idea to keep the bathroom fans on all the time since they will waste energy by expelling conditioned air (warm in winter and cool in summer) by the unconditioned outdoor air.

Heat Transfer from the Human Body

16-10C Yes, roughly one-third of the metabolic heat generated by a person who is resting or doing light work is dissipated to the environment by convection, one-third by evaporation, and the remaining one-third by radiation.

16-11C Sensible heat is the energy associated with a temperature change. The sensible heat loss from a human body increases as (a) the skin temperature increases, (b) the environment temperature decreases, and (c) the air motion (and thus the convection heat transfer coefficient) increases.

16-12C Latent heat is the energy released as water vapor condenses on cold surfaces, or the energy absorbed from a warm surface as liquid water evaporates. The latent heat loss from a human body increases as (a) the skin wettedness increases and (b) the relative humidity of the environment decreases. The rate of evaporation from the body is related to the rate of latent heat loss by $\dot{Q}_{\text{latent}} = \dot{m}_{\text{vapor}} h_{fg}$ where h_{fg} is the latent heat of vaporization of water at the skin temperature.

16-13C The insulating effect of clothing is expressed in the unit **clo** with $1 \text{ clo} = 0.155 \text{ m}^2 \cdot \text{C}/\text{W} = 0.880 \text{ ft}^2 \cdot \text{F} \cdot \text{h}/\text{Btu}$. Clothing serves as insulation, and thus reduces heat loss from the body by convection, radiation, and evaporation by serving as a resistance against heat flow and vapor flow. Clothing decreases heat gain from the sun by serving as a radiation shield.

16-14C (a) Heat is lost through the skin by convection, radiation, and evaporation. (b) The body loses both sensible heat by convection and latent heat by evaporation from the lungs, but there is no heat transfer in the lungs by radiation.

16-15C The *operative temperature* $T_{\text{operative}}$ is the average of the mean radiant and ambient temperatures weighed by their respective convection and radiation heat transfer coefficients, and is expressed as

$$T_{\text{operative}} = \frac{h_{\text{conv}} T_{\text{ambient}} + h_{\text{rad}} T_{\text{surr}}}{h_{\text{conv}} + h_{\text{rad}}} \cong \frac{T_{\text{ambient}} + T_{\text{surr}}}{2}$$

When the convection and radiation heat transfer coefficients are equal to each other, the operative temperature becomes the arithmetic average of the ambient and surrounding surface temperatures. Another environmental index used in thermal comfort analysis is the effective temperature, which combines the effects of temperature and humidity.

16-16 The convection heat transfer coefficient for a clothed person while walking in still air at a velocity of 0.5 to 2 m/s is given by $h = 8.6V^{0.53}$ where V is in m/s and h is in $\text{W}/\text{m}^2 \cdot ^\circ\text{C}$. The convection coefficients in that range vary from $5.96 \text{ W}/\text{m}^2 \cdot ^\circ\text{C}$ at 0.5 m/s to $12.42 \text{ W}/\text{m}^2 \cdot ^\circ\text{C}$ at 2 m/s. Therefore, at low velocities, the radiation and convection heat transfer coefficients are comparable in magnitude. But at high velocities, the convection coefficient is much larger than the radiation heat transfer coefficient.

Velocity, m/s	$h = 8.6V^{0.53}$ $\text{W}/\text{m}^2 \cdot ^\circ\text{C}$
0.50	5.96
0.75	7.38
1.00	8.60
1.25	9.68
1.50	10.66
1.75	11.57
2.00	12.42

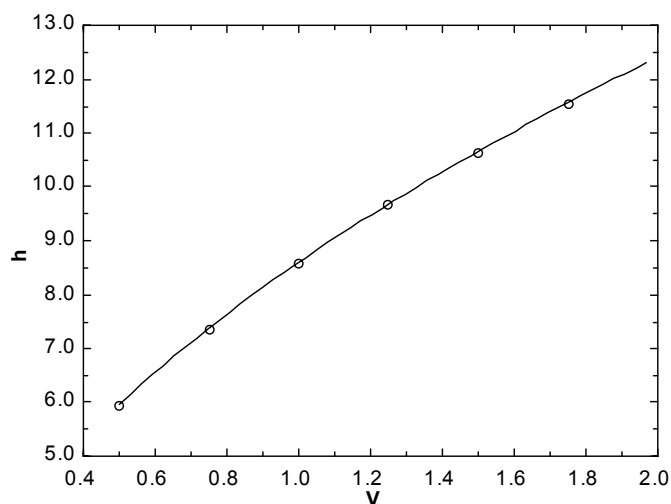

16-17 A man wearing summer clothes feels comfortable in a room at 20°C. The room temperature at which this man would feel thermally comfortable when unclothed is to be determined.

Assumptions 1 Steady conditions exist. 2 The latent heat loss from the person remains the same. 3 The heat transfer coefficients remain the same. 4 The air in the room is still (there are no winds or running fans). 5 The surface areas of the clothed and unclothed person are the same.

Analysis At low air velocities, the convection heat transfer coefficient for a standing man is given in Table 13-3 to be 4.0 W/m²·°C. The radiation heat transfer coefficient at typical indoor conditions is 4.7 W/m²·°C. Therefore, the heat transfer coefficient for a standing person for combined convection and radiation is

$$h_{\text{combined}} = h_{\text{conv}} + h_{\text{rad}} = 4.0 + 4.7 = 8.7 \text{ W/m}^2 \cdot \text{°C}$$

The thermal resistance of the clothing is given to be

$$R_{\text{cloth}} = 1.1 \text{ clo} = 1.1 \times 0.155 \text{ m}^2 \cdot \text{°C/W} = 0.171 \text{ m}^2 \cdot \text{°C/W}$$

Noting that the surface area of an average man is 1.8 m², the sensible heat loss from this person when clothed is determined to be

$$\dot{Q}_{\text{sensible, clothed}} = \frac{A_s (T_{\text{skin}} - T_{\text{ambient}})}{R_{\text{cloth}} + \frac{1}{h_{\text{combined}}}} = \frac{(1.8 \text{ m}^2)(33 - 20) \text{°C}}{0.171 \text{ m}^2 \cdot \text{°C/W} + \frac{1}{8.7 \text{ W/m}^2 \cdot \text{°C}}} = 82 \text{ W}$$

From heat transfer point of view, taking the clothes off is equivalent to removing the clothing insulation or setting $R_{\text{cloth}} = 0$. The heat transfer in this case can be expressed as

$$\dot{Q}_{\text{sensible, unclothed}} = \frac{A_s (T_{\text{skin}} - T_{\text{ambient}})}{\frac{1}{h_{\text{combined}}}} = \frac{(1.8 \text{ m}^2)(33 - T_{\text{ambient}}) \text{°C}}{\frac{1}{8.7 \text{ W/m}^2 \cdot \text{°C}}}$$

To maintain thermal comfort after taking the clothes off, the skin temperature of the person and the rate of heat transfer from him must remain the same. Then setting the equation above equal to 82 W gives

$$T_{\text{ambient}} = 27.8 \text{°C}$$

Therefore, the air temperature needs to be raised from 22 to 27.8°C to ensure that the person will feel comfortable in the room after he takes his clothes off. Note that the effect of clothing on latent heat is assumed to be negligible in the solution above. We also assumed the surface area of the clothed and unclothed person to be the same for simplicity, and these two effects should counteract each other.

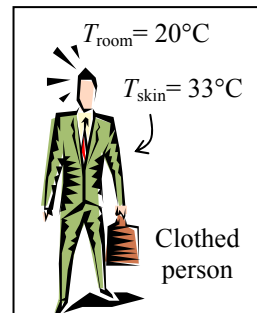

16-18E An average person produces 0.50 lbm of moisture while taking a shower. The contribution of showers of a family of four to the latent heat load of the air-conditioner per day is to be determined.

Assumptions All the water vapor from the shower is condensed by the air-conditioning system.

Properties The latent heat of vaporization of water is given to be 1050 Btu/lbm.

Analysis The amount of moisture produced per day is

$$\begin{aligned}\dot{m}_{\text{vapor}} &= (\text{Moisture produced per person})(\text{No. of persons}) \\ &= (0.5 \text{ lbm/person})(4 \text{ persons/day}) = 2 \text{ lbm/day}\end{aligned}$$

Then the latent heat load due to showers becomes

$$\dot{Q}_{\text{latent}} = \dot{m}_{\text{vapor}} h_{fg} = (2 \text{ lbm/day})(1050 \text{ Btu/lbm}) = \mathbf{2100 \text{ Btu/day}}$$

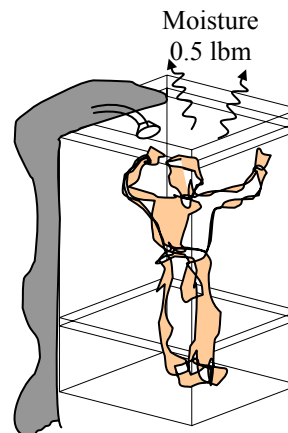

16-19 There are 100 chickens in a breeding room. The rate of total heat generation and the rate of moisture production in the room are to be determined.

Assumptions All the moisture from the chickens is condensed by the air-conditioning system.

Properties The latent heat of vaporization of water is given to be 2430 kJ/kg. The average metabolic rate of chicken during normal activity is 10.2 W (3.78 W sensible and 6.42 W latent).

Analysis The total rate of heat generation of the chickens in the breeding room is

$$\begin{aligned}\dot{Q}_{\text{gen, total}} &= \dot{q}_{\text{gen, total}} (\text{No. of chickens}) \\ &= (10.2 \text{ W/chicken})(100 \text{ chickens}) = \mathbf{1020 \text{ W}}\end{aligned}$$

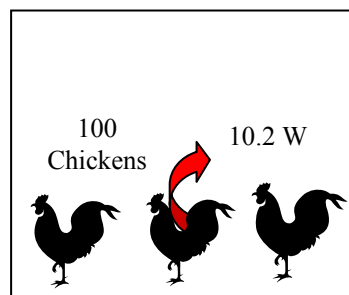

The latent heat generated by the chicken and the rate of moisture production are

$$\begin{aligned}\dot{Q}_{\text{gen, latent}} &= \dot{q}_{\text{gen, latent}} (\text{No. of chickens}) \\ &= (6.42 \text{ W/chicken})(100 \text{ chickens}) = 642 \text{ W} \\ &= 0.642 \text{ kW}\end{aligned}$$

$$\dot{m}_{\text{moisture}} = \frac{\dot{Q}_{\text{gen, latent}}}{h_{fg}} = \frac{0.642 \text{ kW}}{2430 \text{ kJ/kg}} = 0.000264 \text{ kg/s} = \mathbf{0.264 \text{ g/s}}$$

16-20 Chilled air is to cool a room by removing the heat generated in a large insulated classroom by lights and students. The required flow rate of air that needs to be supplied to the room is to be determined.

Assumptions 1 The moisture produced by the bodies leave the room as vapor without any condensing, and thus the classroom has no latent heat load. **2** Heat gain through the walls and the roof is negligible.

Properties The specific heat of air at room temperature is $1.00 \text{ kJ/kg}\cdot^\circ\text{C}$ (Table A-15). The average rate of metabolic heat generation by a person sitting or doing light work is 115 W (70 W sensible, and 45 W latent).

Analysis The rate of sensible heat generation by the people in the room and the total rate of sensible internal heat generation are

$$\begin{aligned}\dot{Q}_{\text{gen, sensible}} &= \dot{q}_{\text{gen, sensible}} (\text{No. of people}) \\ &= (70 \text{ W/person})(90 \text{ persons}) = 6300 \text{ W}\end{aligned}$$

$$\begin{aligned}\dot{Q}_{\text{total, sensible}} &= \dot{Q}_{\text{gen, sensible}} + \dot{Q}_{\text{lighting}} \\ &= 6300 + 2000 = 8300 \text{ W}\end{aligned}$$

Then the required mass flow rate of chilled air becomes

$$\begin{aligned}\dot{m}_{\text{air}} &= \frac{\dot{Q}_{\text{total, sensible}}}{c_p \Delta T} \\ &= \frac{8.3 \text{ kJ/s}}{(1.0 \text{ kJ/kg}\cdot^\circ\text{C})(25 - 15)^\circ\text{C}} = \mathbf{0.83 \text{ kg/s}}\end{aligned}$$

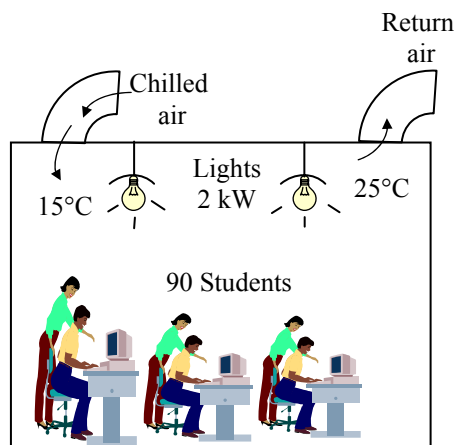

Discussion The latent heat will be removed by the air-conditioning system as the moisture condenses outside the cooling coils.

16-21 A smoking lounge that can accommodate 15 smokers is considered. The required minimum flow rate of air that needs to be supplied to the lounge is to be determined.

Assumptions Infiltration of air into the smoking lounge is negligible.

Properties The minimum fresh air requirements for a smoking lounge is 30 L/s per person (Table 16-2).

Analysis The required minimum flow rate of air that needs to be supplied to the lounge is determined directly from

$$\begin{aligned}\dot{V}_{\text{air}} &= \dot{v}_{\text{air per person}} (\text{No. of persons}) \\ &= (30 \text{ L/s}\cdot\text{person})(15 \text{ persons}) \\ &= 450 \text{ L/s} = \mathbf{0.45 \text{ m}^3/\text{s}}\end{aligned}$$

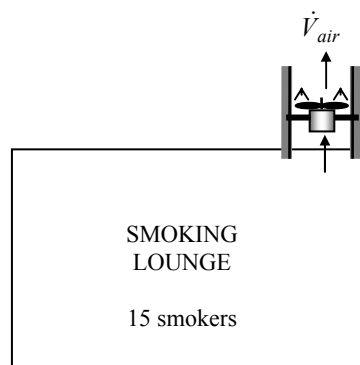

16-22 The average mean radiation temperature during a cold day drops to 18°C. The required rise in the indoor air temperature to maintain the same level of comfort in the same clothing is to be determined.

Assumptions 1 Air motion in the room is negligible. 2 The average clothing and exposed skin temperature remains the same. 3 The latent heat loss from the body remains constant. 4 Heat transfer through the lungs remain constant.

Properties The emissivity of the person is 0.95 (Table A-15). The convection heat transfer coefficient from the body in still air or air moving with a velocity under 0.2 m/s is $h_{\text{conv}} = 3.1 \text{ W/m}^2 \cdot ^\circ\text{C}$ (Table 16-3).

Analysis The total rate of heat transfer from the body is the sum of the rates of heat loss by convection, radiation, and evaporation,

$$\begin{aligned}\dot{Q}_{\text{body, total}} &= \dot{Q}_{\text{sensible}} + \dot{Q}_{\text{latent}} + \dot{Q}_{\text{lungs}} \\ &= (\dot{Q}_{\text{conv}} + \dot{Q}_{\text{rad}}) + \dot{Q}_{\text{latent}} + \dot{Q}_{\text{lungs}}\end{aligned}$$

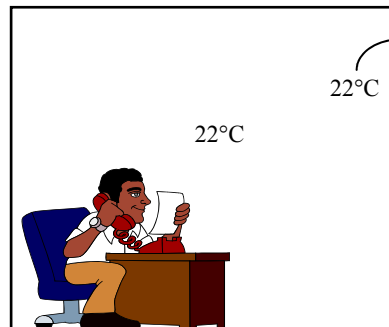

Noting that heat transfer from the skin by evaporation and from the lungs remains constant, the sum of the convection and radiation heat transfer from the person must remain constant.

$$\begin{aligned}\dot{Q}_{\text{sensible, old}} &= hA(T_s - T_{\text{air, old}}) + \varepsilon A \sigma (T_s^4 - T_{\text{surr, old}}^4) = hA(T_s - 22) + 0.95A\sigma[(T_s + 273)^4 - (22 + 273)^4] \\ \dot{Q}_{\text{sensible, new}} &= hA(T_s - T_{\text{air, new}}) + \varepsilon A \sigma (T_s^4 - T_{\text{surr, new}}^4) = hA(T_s - T_{\text{air, new}}) + 0.95A\sigma[(T_s + 273)^4 - (18 + 273)^4]\end{aligned}$$

Setting the two relations above equal to each other, canceling the surface area A , and simplifying gives

$$\begin{aligned}-22h - 0.95\sigma(22 + 273)^4 &= -hT_{\text{air, new}} - 0.95\sigma(18 + 273)^4 \\ 3.1(T_{\text{air, new}} - 22) + 0.95 \times 5.67 \times 10^{-8}(291^4 - 295^4) &= 0\end{aligned}$$

Solving for the new air temperature gives

$$T_{\text{air, new}} = \mathbf{29.0^\circ\text{C}}$$

Therefore, the air temperature must be raised to 29°C to counteract the increase in heat transfer by radiation.

16-23 A car mechanic is working in a shop heated by radiant heaters in winter. The lowest ambient temperature the worker can work in comfortably is to be determined.

Assumptions 1 The air motion in the room is negligible, and the mechanic is standing. **2** The average clothing and exposed skin temperature of the mechanic is 33°C.

Properties The emissivity and absorptivity of the person is given to be 0.95. The convection heat transfer coefficient from a standing body in still air or air moving with a velocity under 0.2 m/s is $h_{\text{conv}} = 4.0 \text{ W/m}^2 \cdot \text{°C}$ (Table 13-3).

Analysis The equivalent thermal resistance of clothing is

$$R_{\text{cloth}} = 0.7 \text{ clo} = 0.7 \times 0.155 \text{ m}^2 \cdot \text{°C/W} = 0.1085 \text{ m}^2 \cdot \text{°C/W}$$

Radiation from the heaters incident on the person and the rate of sensible heat generation by the person are

$$\dot{Q}_{\text{rad, incident}} = 0.05 \times \dot{Q}_{\text{rad, total}} = 0.05(4 \text{ kW}) = 0.2 \text{ kW} = 200 \text{ W}$$

$$\dot{Q}_{\text{gen, sensible}} = 0.5 \times \dot{Q}_{\text{gen, total}} = 0.5(350 \text{ W}) = 175 \text{ W}$$

Under steady conditions, and energy balance on the body can be expressed as

$$\dot{E}_{\text{in}} - \dot{E}_{\text{out}} + \dot{E}_{\text{gen}} = 0$$

$$\dot{Q}_{\text{rad from heater}} - \dot{Q}_{\text{conv+rad from body}} + \dot{Q}_{\text{gen, sensible}} = 0$$

or

$$\alpha \dot{Q}_{\text{rad, incident}} - h_{\text{conv}} A_s (T_s - T_{\text{surr}}) - \varepsilon A_s \sigma (T_s^4 - T_{\text{surr}}^4) + \dot{Q}_{\text{gen, sensible}} = 0$$

$$0.95(200 \text{ W}) - (4.0 \text{ W/m}^2 \cdot \text{K})(1.8 \text{ m}^2)(306 - T_{\text{surr}}) - 0.95(1.8 \text{ m}^2)(5.67 \times 10^{-8} \text{ W/m}^2 \cdot \text{K}^4)[(306 \text{ K})^4 - T_{\text{surr}}^4] + 175 \text{ W} = 0$$

Solving the equation above gives

$$T_{\text{surr}} = 284.8 \text{ K} = \mathbf{11.8^\circ\text{C}}$$

Therefore, the mechanic can work comfortably at temperatures as low as 12°C.

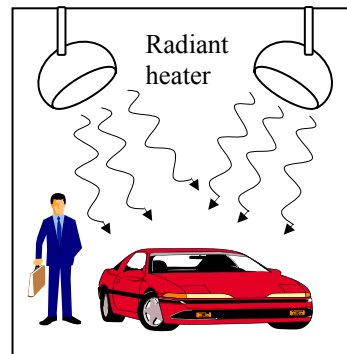

Design conditions for Heating and Cooling

16-24C The extreme outdoor temperature under which a heating or cooling system must be able to maintain a building at the indoor design conditions is called the *outdoor design temperature*. It differs from the average winter temperature in that the average temperature represents the arithmetic average of the hourly outdoors temperatures. The 97.5% winter design temperature ensures that the heating system will provide thermal comfort 97.5 percent of the time, but may fail to do so during 2.5 percent of the time. The 99% winter design temperature, on the other hand, ensures that the heating system will provide thermal comfort 99 percent of the time, but may fail to do so during 1 percent of the time in an average year.

16-25C Yes, it is possible for a city A to have a lower winter design temperature but a higher average winter temperature than another city B. In that case, a house in city A will require a larger heating system, but it will use less energy during a heating season.

16-26C The solar radiation has no effect on the design heating load in winter since the coldest outdoor temperatures occur before sunrise, but it may reduce the annual energy consumption for heating considerably. Similarly, the heat generated by people, lights, and appliances has no effect on the design heating load in winter since the heating system should be able to meet the heating load of a house even when there is no internal heat generation, but it will reduce the annual energy consumption for heating.

16-27C The solar radiation constitutes a major part of the cooling load, and thus it increases both the design cooling load in summer and the annual energy consumption for cooling. Similarly, the heat generated by people, lights, and appliances constitute a significant part of the cooling load, and thus it increases both the design cooling load in summer and the annual energy consumption for cooling.

16-28C The moisture level of the outdoor air contributes to the latent heat load, and it affects the cooling load in summer. This is because the humidity ratio of the outdoor air is higher than that of the indoor air in summer, and the outdoor air that infiltrates into the building increases the amount of moisture inside. This excess moisture must be removed by the air-conditioning system. The moisture level of the outdoor air, in general, does affect the heating load in winter since the humidity ratio of the outdoor air is much lower than that of the indoor air in winter, and the moisture production in the building is sufficient to keep the air moist. However, in some cases, it may be necessary to add moisture to the indoor air. The heating load in this case will increase because of the energy needed to vaporize the water.

16-29C The reason for different values of recommended design heat transfer coefficients for combined convection and radiation on the outer surface of a building in summer and in winter is the wind velocity. In winter, the wind velocity and thus the heat transfer coefficient is higher.

16-30C The *sol-air temperature* is defined as the equivalent outdoor air temperature that gives the same rate of heat flow to a surface as would the combination of incident solar radiation, convection with the ambient air, and radiation exchange with the sky and the surrounding surfaces. It is used to account for the effect of solar radiation by considering the outside temperature to be higher by an amount equivalent to the effect of solar radiation. The higher the solar absorptivity of the outer surface of a wall, the higher is the amount of solar radiation absorption and thus the sol-air temperature.

16-31C Most of the solar energy absorbed by the walls of a brick house will be transferred to the outdoors since the thermal resistance between the outer surface and the indoor air (the wall resistance + the convection resistance on the inner surface) is much larger than the thermal resistance between the outer surface and the outdoor air (just the convection resistance).

16-32 The climatic conditions for major cities in the U.S. are listed in Table 16-4, and for the indicated design levels we read

$$\begin{aligned} \text{Winter:} \quad & T_{\text{outdoor}} = -19^{\circ}\text{C} \quad (97.5 \text{ percent level}) \\ \text{Summer:} \quad & T_{\text{outdoor}} = 35^{\circ}\text{C} \\ & T_{\text{wet-bulb}} = 23^{\circ}\text{C} \quad (2.5 \text{ percent level}) \end{aligned}$$

Therefore, the heating and cooling systems in Lincoln, Nebraska for common applications should be sized for these outdoor conditions. Note that when the wet-bulb and ambient temperatures are available, the relative humidity and the humidity ratio of air can be determined from the psychrometric chart.

16-33 The climatic conditions for major cities in the U.S. are listed in Table 16-4, and for the indicated design levels we read

$$\begin{aligned} \text{Winter:} \quad & T_{\text{outdoor}} = -16^{\circ}\text{C} \quad (99 \text{ percent level}) \\ \text{Summer:} \quad & T_{\text{outdoor}} = 37^{\circ}\text{C} \\ & T_{\text{wet-bulb}} = 23^{\circ}\text{C} \quad (2.5 \text{ percent level}) \end{aligned}$$

Therefore, the heating and cooling systems in Wichita, Kansas for common applications should be sized for these outdoor conditions. Note that when the wet-bulb and ambient temperatures are available, the relative humidity and the humidity ratio of air can be determined from the psychrometric chart.

16-34 The south wall of a house is subjected to solar radiation at summer design conditions. The design heat gain, the fraction of heat gain due to solar heating, and the fraction of solar radiation that is transferred to the house are to be determined.

Assumptions 1 Steady conditions exist. 2 Thermal properties of the wall and the heat transfer coefficients are constant.

Properties The overall heat transfer coefficient of the wall is given to be $1.6 \text{ W/m}^2 \cdot ^\circ\text{C}$.

Analysis (a) The house is located at 40°N latitude, and thus we can use the sol-air temperature data directly from Table 16-7. At 15:00 the tabulated air temperature is 35°C , which is identical to the air temperature given in the problem. Therefore, the sol-air temperature on the south wall in this case is 43.6°C , and the heat gain through the wall is determined to be

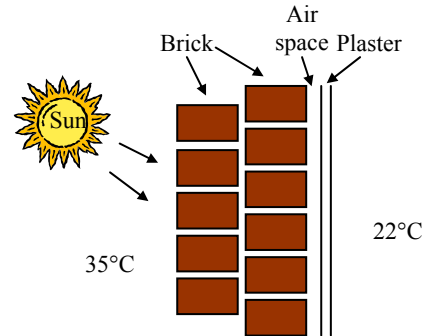

$$\dot{Q}_{\text{wall}} = UA(T_{\text{sol-air}} - T_{\text{inside}}) = (1.6 \text{ W/m}^2 \cdot ^\circ\text{C})(20 \text{ m}^2)(43.6 - 22)^\circ\text{C} = \mathbf{691.2 \text{ W}}$$

(b) Heat transfer is proportional to the temperature difference, and the overall temperature difference in this case is $43.6 - 22 = 21.6^\circ\text{C}$. Also, the difference between the sol-air temperature and the ambient air temperature is

$$\Delta T_{\text{solar}} = T_{\text{sol-air}} - T_{\text{ambient}} = 43.6 - 35 = 8.6^\circ\text{C}$$

which is the equivalent temperature rise of the ambient air due to solar heating. The fraction of heat gain due to solar heating is equal to the fraction of the solar temperature difference to the overall temperature difference, and is determined to be

$$\text{Solar fraction} = \frac{\dot{Q}_{\text{wall,solar}}}{\dot{Q}_{\text{wall,total}}} = \frac{UA\Delta T_{\text{solar}}}{UA\Delta T_{\text{total}}} = \frac{\Delta T_{\text{solar}}}{\Delta T_{\text{total}}} = \frac{8.6^\circ\text{C}}{21.6^\circ\text{C}} = \mathbf{0.40 \text{ (or 40\%)}}$$

Therefore, almost half of the heat gain through the west wall in this case is due to solar heating of the wall.

(c) The outer layer of the wall is made of red brick which is dark colored. Therefore, the value of α_s / h_o is $0.052 \text{ m}^2 \cdot ^\circ\text{C/W}$. Then the fraction of incident solar energy transferred to the interior of the house is determined directly from Eq. 16-20 to be

$$\text{Solar fraction transferred} = U \frac{\alpha_s}{h_o} = (1.6 \text{ W/m}^2 \cdot ^\circ\text{C})(0.052 \text{ m}^2 \cdot ^\circ\text{C/W}) = \mathbf{0.0832}$$

Discussion Less than 10 percent of the solar energy incident on the surface will be transferred to the house in this case. Note that a glass wall would transmit about 10 times more energy into the house.

16-35E The west wall of a house is subjected to solar radiation at summer design conditions. The design heat gain and the fraction of heat gain due to solar heating are to be determined.

Assumptions 1 Steady conditions exist. 2 Thermal properties of the wall and the heat transfer coefficients are constant.

Properties The overall heat transfer coefficient of the wall is given to be $0.14 \text{ Btu/h}\cdot\text{ft}^2\cdot^\circ\text{F}$.

Analysis (a) The house is located at 40°N latitude, and thus we can use the sol-air temperature data directly from Table 16-7. At 15:00 the tabulated air temperature is 94°F , which is 8°F higher than the air temperature given in the problem. But we can still use the data in that table provided that we subtract 8°F from all temperatures. Therefore, the sol-air temperature on the west wall in this case is $159 - 8 = 151^\circ\text{F}$, and the heat gain through the wall is determined to be

$$\dot{Q}_{\text{wall}} = UA(T_{\text{sol-air}} - T_{\text{inside}}) = (0.14 \text{ Btu/h}\cdot\text{ft}^2\cdot^\circ\text{F})(150 \times 12 \text{ ft}^2)(151 - 72)^\circ\text{F} = \mathbf{19,908 \text{ Btu/h}}$$

(b) Heat transfer is proportional to the temperature difference, and the overall temperature difference in this case is $151 - 72 = 79^\circ\text{F}$. Also, the difference between the sol-air temperature and the ambient air temperature is

$$\Delta T_{\text{solar}} = T_{\text{sol-air}} - T_{\text{ambient}} = 151 - 86 = 65^\circ\text{F}$$

which is the equivalent temperature rise of the ambient air due to solar heating. The fraction of heat gain due to solar heating is equal to the ratio of the solar temperature difference to the overall temperature difference, and is determined to be

$$\text{Solar fraction} = \frac{\dot{Q}_{\text{wall,solar}}}{\dot{Q}_{\text{wall,total}}} = \frac{UA\Delta T_{\text{solar}}}{UA\Delta T_{\text{total}}} = \frac{\Delta T_{\text{solar}}}{\Delta T_{\text{total}}} = \frac{65^\circ\text{F}}{79^\circ\text{F}} = \mathbf{0.823} \text{ (or } 82.3\%)$$

Therefore, almost the entire heat gain through the west wall in this case is due to solar heating of the wall.

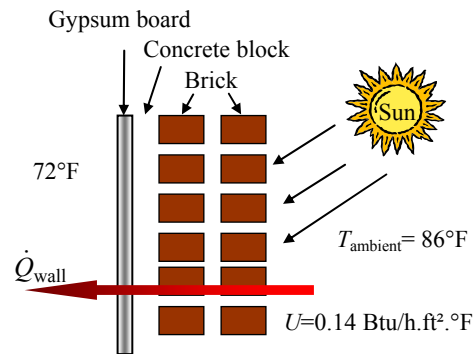

16-36 The roof of a house is subjected to solar radiation at summer design conditions. The design heat gain and the fraction of heat gain due to solar heating are to be determined.

Assumptions 1 Steady conditions exist. 2 Thermal properties of the wall and the heat transfer coefficients are constant.

Properties The overall heat transfer coefficient of the roof is given to be $1.8 \text{ W/m}^2 \cdot ^\circ\text{C}$.

Analysis (a) The house is located at 40°N latitude, and thus we can use the sol-air temperature data directly from Table 16-7. At 16:00 the tabulated air temperature is 34.7°C , which is 4.7°C higher than the air temperature given in the problem. But we can still use the data in that table provided that we subtract 4.7°C from all temperatures. Therefore, the sol-air temperature on the roof in this case is $42.7 - 4.7 = 38.0^\circ\text{C}$, and the heat gain through the roof is determined to be

$$\begin{aligned}\dot{Q}_{\text{roof}} &= UA(T_{\text{sol-air}} - T_{\text{inside}}) \\ &= (1.8 \text{ W/m}^2 \cdot ^\circ\text{C})(150 \text{ m}^2)(38 - 22)^\circ\text{C} = \mathbf{4320 \text{ W}}\end{aligned}$$

(b) Heat transfer is proportional to the temperature difference, and the overall temperature difference in this case is $38 - 22 = 16^\circ\text{C}$. Also, the difference between the sol-air temperature and the ambient air temperature is

$$\Delta T_{\text{solar}} = T_{\text{sol-air}} - T_{\text{ambient}} = 38 - 30 = 8^\circ\text{C}$$

which is the equivalent temperature rise of the ambient air due to solar heating. The fraction of heat gain due to solar heating is equal to the ratio of the solar temperature difference to the overall temperature difference, and is determined to be

$$\text{Solar fraction} = \frac{\dot{Q}_{\text{wall,solar}}}{\dot{Q}_{\text{wall,total}}} = \frac{UA\Delta T_{\text{solar}}}{UA\Delta T_{\text{total}}} = \frac{\Delta T_{\text{solar}}}{\Delta T_{\text{total}}} = \frac{8^\circ\text{C}}{16^\circ\text{C}} = \mathbf{0.50 \text{ (or 50%)}}$$

Therefore, half of the heat gain through the roof in this case is due to solar heating of the roof.

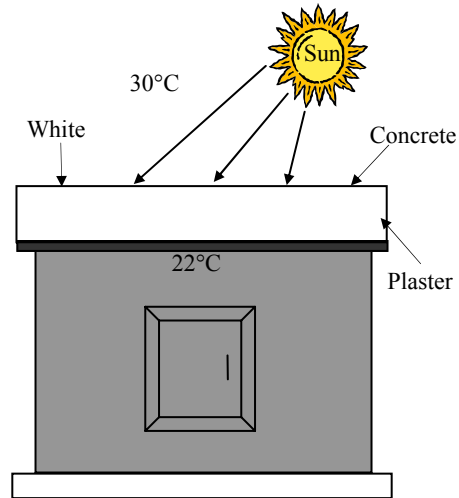

Heat Gain from People, Lights, and Appliances

16-37C The heat given off by people in a concert hall is an important consideration in the sizing of the air-conditioning system for that building because of the high density of people in the hall, and the heat generation from the people contributes a significant amount to the cooling load.

16-38C By replacing the incandescent lamps of a building by high-efficiency fluorescent lamps, (a) the design cooling load will decrease, (b) annual energy consumption for cooling will also decrease, and (c) annual energy consumption for heating for the building will increase since fluorescent lamps generate much less heat than incandescent lamps for the same light output.

16-39C It is usually a good idea to replace incandescent light bulbs by compact fluorescent bulbs that may cost 40 times as much to purchase since incandescent lights waste energy by (1) consuming more electricity for the same amount of lighting, and (2) making the cooling system work harder and longer to remove the heat given off.

16-40C The motors and appliances in a building generate heat, and thus (a) they increase the design cooling load, (b) they increase the annual energy consumption for cooling, and (c) they reduce the annual energy consumption for heating of the building.

16-41C The motor efficiency η_{motor} is defined as the ratio of the shaft power delivered to the electrical power consumed by the motor. The higher the motor efficiency, the lower is the amount of heat generated by the motor. Therefore, high efficiency motors decrease the design cooling load of a building and the annual energy consumption for cooling.

16-42C The heat generated by a hooded range in a kitchen with a powerful fan that exhausts all the air heated and humidified by the range still needs to be considered in the determination of the cooling load of the kitchen although all the heated air is exhausted since part of the energy (32% of it) is radiated to the surroundings from the hot surfaces.

16-43 A hooded electric open burner and a gas burner are considered. The amount of the electrical energy used directly for cooking, the cost of energy per “utilized” kWh, and the contribution of this burner to the design cooling load are to be determined.

Analysis The efficiency of the electric heater is given to be 78 percent. Therefore, a burner that consumes 3-kW of electrical energy will supply

$$\dot{Q}_{\text{utilized}} = (\text{Energy input}) \times (\text{Efficiency}) = (3 \text{ kW})(0.78) = \mathbf{2.19 \text{ kW}}$$

of useful energy. The unit cost of utilized energy is inversely proportional to the efficiency, and is determined from

$$\text{Cost of utilized energy} = \frac{\text{Cost of energy input}}{\text{Efficiency}} = \frac{\$0.09 / \text{kWh}}{0.78} = \mathbf{\$0.123/\text{kWh}}$$

The design heat gain from a hooded appliance is taken to be 32% of the half of its rated energy consumption, and is determined to be

$$\dot{Q}_{\text{hooded appliance}} = 0.5 \times 0.32 \dot{Q}_{\text{appliance, input}} = 0.5 \times 0.32 \times (3 \text{ kW}) = \mathbf{0.48 \text{ kW}} \quad (\text{electric burner})$$

Noting that the efficiency of a gas burner is 38 percent, the energy input to a gas burner that supplies utilized energy at the same rate (2.19 kW) is

$$\dot{Q}_{\text{input, gas}} = \frac{\dot{Q}_{\text{utilized}}}{\text{Efficiency}} = \frac{2.19 \text{ kW}}{0.38} = \mathbf{5.76 \text{ kW}} \quad (= 19,660 \text{ Btu/h})$$

since 1 kW = 3412 Btu/h. Therefore, a gas burner should have a rating of at least 19,660 Btu/h to perform as well as the electric unit.

Noting that 1 therm = 29.3 kWh, the unit cost of utilized energy in the case of gas burner is determined the same way to be

$$\text{Cost of utilized energy} = \frac{\text{Cost of energy input}}{\text{Efficiency}} = \frac{\$1.10 / (29.3 \text{ kWh})}{0.38} = \mathbf{\$0.099/\text{kWh}}$$

which is about 20 percent less than the unit cost of utilized electricity. The design heat gain from this hooded gas burner is determined similarly to be

$$\dot{Q}_{\text{unhooded appliance}} = 0.5 \times 0.32 \dot{Q}_{\text{appliance, input}} = 0.5 \times 0.32 \times (5.76 \text{ kW}) = \mathbf{0.922 \text{ kW}} \quad (\text{gas burner})$$

which is almost twice as much as that of the electric burner. Therefore, a hooded gas appliance will contribute more to the heat gain than a comparable electric appliance.

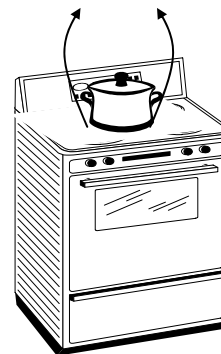

16-44 Several people are working out in an exercise room. The rate of heat gain from people and the equipment, and the fraction of that heat in the latent form are to be determined.

Analysis The 8 weight lifting machines do not have any motors, and thus they do not contribute to the internal heat gain directly. The usage factors of the motors of the treadmills are taken to be unity since they are used constantly during peak periods. Noting that 1 hp = 746 W, the total heat generated by the motors is

$$\dot{Q}_{\text{motors}} = (\text{No. of motors}) \times \dot{W}_{\text{motor}} \times f_{\text{load}} \times f_{\text{usage}} / \eta_{\text{motor}} = 4 \times (2.5 \times 746 \text{ W}) \times 0.70 \times 1.0 / 0.77 = 6782 \text{ W}$$

The average rate of heat dissipated by people in an exercise room is given in Table 16-8 to be 525 W, of which 315 W is in latent form. Therefore, the heat gain from 14 people is

$$\dot{Q}_{\text{people}} = (\text{No. of people}) \times \dot{Q}_{\text{person}} = 14 \times (525 \text{ W}) = 7350 \text{ W}$$

Then the total rate of heat gain (or the internal heat load) of the exercise room during peak period becomes

$$\dot{Q}_{\text{total}} = \dot{Q}_{\text{motors}} + \dot{Q}_{\text{people}} = 6782 + 7350 = \mathbf{14,132 \text{ W}}$$

The entire heat given off by the motors is in sensible form. Therefore, the latent heat gain is due to people only, which is determined to be

$$\dot{Q}_{\text{latent}} = (\text{No. of people}) \times \dot{Q}_{\text{latent, per person}} = 14 \times (315 \text{ W}) = \mathbf{4410 \text{ W}}$$

The remaining 14,132 - 4410 = 9722 W of heat gain is in the sensible form.



16-45 A worn out standard motor is replaced by a high efficiency one. The reduction in the internal heat gain due to higher efficiency under full load conditions is to be determined.

Assumptions 1 The motor and the equipment driven by the motor are in the same room. **2** The motor operates at full load so that $f_{\text{load}} = 1$.

Analysis The heat generated by a motor is due to its inefficiency, and the difference between the heat generated by two motors that deliver the same shaft power is simply the difference between the electric power drawn by the motors,

$$\dot{W}_{\text{in, electric, standard}} = \dot{W}_{\text{shaft}} / \eta_{\text{motor}} = (75 \times 746 \text{ W}) / 0.91 = 61,484 \text{ W}$$

$$\dot{W}_{\text{in, electric, efficient}} = \dot{W}_{\text{shaft}} / \eta_{\text{motor}} = (75 \times 746 \text{ W}) / 0.954 = 58,648 \text{ W}$$

Then the reduction in heat generation becomes

$$\dot{Q}_{\text{reduction}} = \dot{W}_{\text{in, electric, standard}} - \dot{W}_{\text{in, electric, efficient}} = 61,484 - 58,648 = \mathbf{2836 \text{ W}}$$

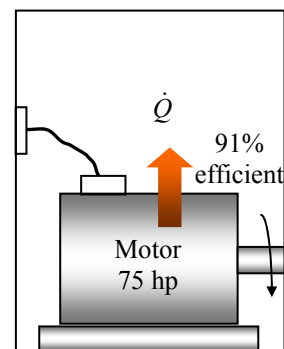

16-46 An electric hot plate and a gas hot plate are considered. For the same amount of “utilized” energy, the ratio of internal heat generated by gas hot plates to that by electric ones is to be determined.

Assumptions Hot plates are not hooded and thus the entire energy they consume is dissipated to the room they are in.

Analysis The utilized energy can be expressed in terms of the energy input and the efficiency as

$$\begin{aligned}\dot{E}_{\text{utilized}} &= (\text{Energy input}) \times (\text{Efficiency}) \\ &= \dot{E}_{\text{in}} \times \eta \rightarrow \dot{E}_{\text{in}} = \dot{E}_{\text{utilized}} / \eta\end{aligned}$$

Noting that the utilized energy is the same for both the electric and gas hot plates, the ratio of internal heat generated by gas hot plates to that by electric ones is determined to be

$$\text{Ratio of heat generation} = \frac{\dot{E}_{\text{in, gas}}}{\dot{E}_{\text{in, electric}}} = \frac{\dot{E}_{\text{utilized}} / \eta_{\text{gas}}}{\dot{E}_{\text{utilized}} / \eta_{\text{electric}}} = \frac{\eta_{\text{electric}}}{\eta_{\text{gas}}} = \frac{0.48}{0.23} = \mathbf{2.07}$$

Therefore, the gas hot plate will contribute twice as much to the internal heat gain of the room.

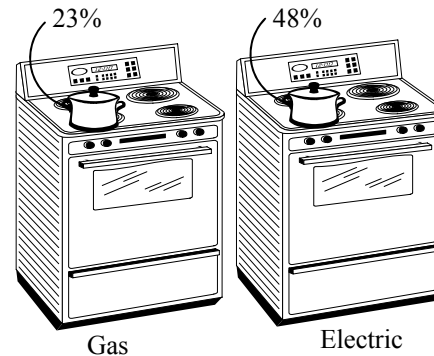

16-47 A classroom has 40 students, one instructor, and 18 fluorescent light bulbs. The rate of internal heat generation in this classroom is to be determined.

Assumptions **1** There is a mix of men, women, and children in the classroom. **2** The amount of light (and thus energy) leaving the room through the windows is negligible.

Properties The average rate of heat generation from people seated in a room/office is 115 W (Table 16-8).

Analysis The amount of heat dissipated by the lamps is equal to the amount of electrical energy consumed by the lamps, including the 10% additional electricity consumed by the ballasts. Therefore,

$$\begin{aligned}\dot{Q}_{\text{lighting}} &= (\text{Energy consumed per lamp}) \times (\text{No. of lamps}) \\ &= (40 \text{ W})(1.1)(18) = 792 \text{ W} \\ \dot{Q}_{\text{people}} &= (\text{No. of people}) \times \dot{Q}_{\text{person}} = 41 \times (115 \text{ W}) = 4715 \text{ W}\end{aligned}$$

Then the total rate of heat gain (or the internal heat load) of the classroom from the lights and people become

$$\dot{Q}_{\text{total}} = \dot{Q}_{\text{lighting}} + \dot{Q}_{\text{people}} = 792 + 4715 = \mathbf{5507 \text{ W}}$$

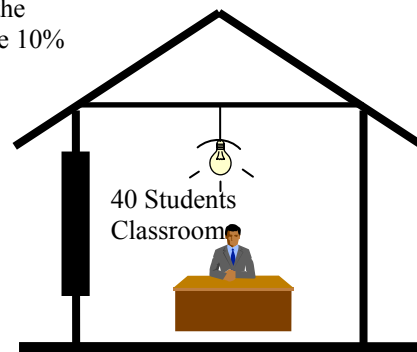

16-48 An electric car is powered by an electric motor mounted in the engine compartment. The rate of heat supply by the motor to the engine compartment at full load conditions is to be determined.

Assumptions The motor operates at full load so that $f_{\text{load}} = 1$.

Analysis The heat generated by a motor is due to its inefficiency, and the heat generated by a motor is equal to the difference between the electrical energy it consumes and the shaft power it delivers,

$$\begin{aligned}\dot{W}_{\text{in, electric}} &= \dot{W}_{\text{shaft}} / \eta_{\text{motor}} = (60 \text{ hp}) / 0.88 = 68.18 \text{ hp} \\ \dot{Q}_{\text{generation}} &= \dot{W}_{\text{in, electric}} - \dot{W}_{\text{shaft out}} \\ &= 68.18 - 60 = 8.18 \text{ hp} = \mathbf{6.10 \text{ kW}}\end{aligned}$$

since 1 hp = 0.746 kW.

Discussion The motor will supply as much heat to the compartment as a 6.1 kW resistance heater.

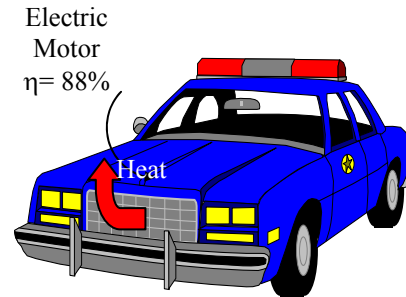

16-49 A room is cooled by circulating chilled water, and the air is circulated through the heat exchanger by a fan. The contribution of the fan-motor assembly to the cooling load of the room is to be determined.

Assumptions The fan motor operates at full load so that $f_{\text{load}} = 1$.

Analysis The entire electrical energy consumed by the motor, including the shaft power delivered to the fan, is eventually dissipated as heat. Therefore, the contribution of the fan-motor assembly to the cooling load of the room is equal to the electrical energy it consumes,

$$\begin{aligned}\dot{Q}_{\text{internal generation}} &= \dot{W}_{\text{in, electric}} = \dot{W}_{\text{shaft}} / \eta_{\text{motor}} \\ &= (0.25 \text{ hp}) / 0.54 = 0.463 \text{ hp} = \mathbf{345 \text{ W}}\end{aligned}$$

since 1 hp = 746 W.

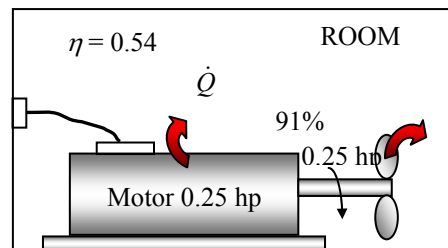

16-50 An office that is being cooled adequately by a 12,000 Btu/h window air-conditioner is converted to a computer room. The number of additional air-conditioners that need to be installed is to be determined.

Assumptions 1 The computers are operated by 4 adult men. **2** The computers consume 40 percent of their rated power at any given time.

Properties The average rate of heat generation from a man seated in a room/office is 130 W (Table 16-8).

Analysis The amount of heat dissipated by the computers is equal to the amount of electrical energy they consume.

Therefore,

$$\begin{aligned}\dot{Q}_{\text{computers}} &= (\text{Rated power}) \times (\text{Usage factor}) \\ &= (3.5 \text{ kW})(0.4) = 1.4 \text{ kW}\end{aligned}$$

$$\begin{aligned}\dot{Q}_{\text{people}} &= (\text{No. of people}) \times \dot{Q}_{\text{person}} \\ &= 4 \times (130 \text{ W}) = 520 \text{ W}\end{aligned}$$

$$\begin{aligned}\dot{Q}_{\text{total}} &= \dot{Q}_{\text{computers}} + \dot{Q}_{\text{people}} \\ &= 1400 + 520 = 1920 \text{ W} = 6551 \text{ Btu/h}\end{aligned}$$

since 1 W = 3.412 Btu/h. Then noting that each available air conditioner provides 4,000 Btu/h cooling, the number of air-conditioners needed becomes

$$\text{No. of air conditioners} = \frac{\text{Cooling load}}{\text{Cooling capacity of A/C}} = \frac{6551 \text{ Btu/h}}{4000 \text{ Btu/h}} = 1.6 \approx \mathbf{2 \text{ Air conditioners}}$$

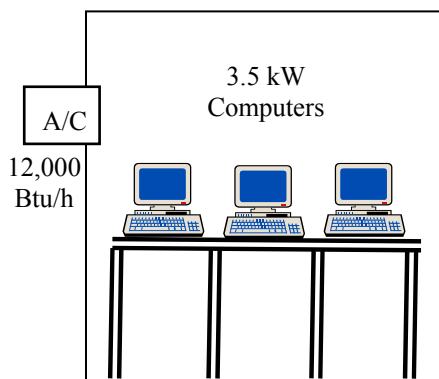

16-51 A restaurant purchases a new 8-kW electric range for its kitchen. The increase in the design cooling load is to be determined for the cases of hooded and unhooded range.

Assumptions 1 The contribution of an appliance to the design cooling is half of its rated power. **2** The hood of an appliance removes all the heated air and moisture generated, except the radiation heat that constitutes 38 percent of the heat generated.

Analysis The design cooling load due to an unhooded range is half of its rated power, and the design cooling of a hooded range is half of the radiation component of heat dissipation, which is taken to be 38 percent. Then the increase in the design cooling load for both cases becomes

$$\dot{Q}_{\text{unhooded appliance}} = 0.5 \times \dot{Q}_{\text{appliance, input}} = 0.5 \times (8 \text{ kW}) = \mathbf{4 \text{ kW}}$$

$$\dot{Q}_{\text{hooded appliance}} = 0.5 \times 0.32 \dot{Q}_{\text{appliance, input}} = 0.5 \times 0.32 \times (8 \text{ kW}) = \mathbf{1.28 \text{ kW}}$$

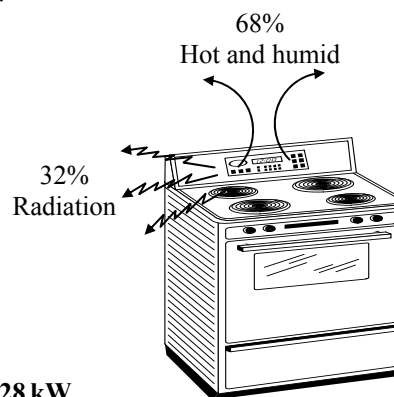

16-52 A department store expects to have 95 people at peak times in summer. The contribution of people to the sensible, latent, and total cooling load of the store is to be determined.

Assumptions There is a mix of men, women, and children in the classroom.

Properties The average rate of heat generation from people in a shopping center is 130 W, and 75 W of it is in sensible form and 55 W in latent form (Table 16-8).

Analysis The contribution of people to the sensible, latent, and total cooling load of the store are

$$\begin{aligned}\dot{Q}_{\text{people, total}} &= (\text{No. of people}) \times \dot{Q}_{\text{person, total}} = 95 \times (130 \text{ W}) = \mathbf{12,350 \text{ W}} \\ \dot{Q}_{\text{people, sensible}} &= (\text{No. of people}) \times \dot{Q}_{\text{person, sensible}} = 95 \times (70 \text{ W}) = \mathbf{7125 \text{ W}} \\ \dot{Q}_{\text{people, latent}} &= (\text{No. of people}) \times \dot{Q}_{\text{person, latent}} = 95 \times (35 \text{ W}) = \mathbf{5225 \text{ W}}\end{aligned}$$



16-53E There are 500 people in a movie theater in winter. It is to be determined if the theater needs to be heated or cooled.

Assumptions There is a mix of men, women, and children in the classroom.

Properties The average rate of heat generation from people in a movie theater is 105 W, and 70 W of it is in sensible form and 35 W in latent form (Table 16-8).

Analysis Noting that only the sensible heat from a person contributes to the heating load of a building, the contribution of people to the heating of the building is

$$\begin{aligned}\dot{Q}_{\text{people, sensible}} &= (\text{No. of people}) \times \dot{Q}_{\text{person, sensible}} \\ &= 500 \times (70 \text{ W}) = 35,000 \text{ W} \\ &= \mathbf{119,420 \text{ Btu/h}}\end{aligned}$$

since $1 \text{ W} = 3.412 \text{ Btu/h}$. The building needs to be heated since the heat gain from people is less than the rate of heat loss of 150,000 Btu/h from the building.

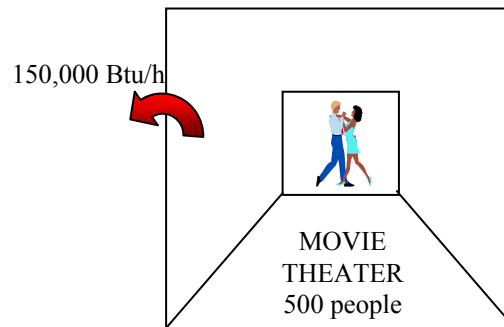

Heat Transfer through the Walls and Roofs

16-54C The R -value of a wall is the thermal resistance of the wall per unit surface area. It is the same as the unit thermal resistance of the wall. It is the inverse of the U -factor of the wall, $R = 1/U$.

16-55C The effective emissivity for a plane-parallel air space is the “equivalent” emissivity of one surface for use in the relation $\dot{Q}_{\text{rad}} = \varepsilon_{\text{effective}}\sigma A(T_2^4 - T_1^4)$ that results in the same rate of radiation heat transfer between the two surfaces across the air space. It is determined from

$$\frac{1}{\varepsilon_{\text{effective}}} = \frac{1}{\varepsilon_1} + \frac{1}{\varepsilon_2} - 1$$

where ε_1 and ε_2 are the emissivities of the surfaces of the air space. When the effective emissivity is known, the radiation heat transfer through the air space is determined from the \dot{Q}_{rad} relation above.

16-56C The unit thermal resistances (R -value) of both 40-mm and 90-mm vertical air spaces are given to be the same, which implies that more than doubling the thickness of air space in a wall has no effect on heat transfer through the wall. This is not surprising since the convection currents that set in in the thicker air space offset any additional resistance due to a thicker air space.

16-57C Radiant barriers are highly reflective materials that minimize the radiation heat transfer between surfaces. Highly reflective materials such as aluminum foil or aluminum coated paper are suitable for use as radiant barriers. Yes, it is worthwhile to use radiant barriers in the attics of homes by covering at least one side of the attic (the roof or the ceiling side) since they reduce radiation heat transfer between the ceiling and the roof considerably.

16-58C The roof of a house whose attic space is ventilated effectively so that the air temperature in the attic is the same as the ambient air temperature at all times will still have an effect on heat transfer through the ceiling since the roof in this case will act as a radiation shield, and reduce heat transfer by radiation.

16-59 The R -value and the U -factor of a wood frame wall are to be determined.

Assumptions 1 Steady operating conditions exist. 2 Heat transfer through the wall is one-dimensional. 3 Thermal properties of the wall and the heat transfer coefficients are constant.

Properties The R -values of different materials are given in Table 16-10.

Analysis The schematic of the wall as well as the different elements used in its construction are shown below. Heat transfer through the insulation and through the studs will meet different resistances, and thus we need to analyze the thermal resistance for each path separately. Once the unit thermal resistances and the U -factors for the insulation and stud sections are available, the overall average thermal resistance for the entire wall can be determined from

$$R_{\text{overall}} = 1/U_{\text{overall}} \quad \text{where} \quad U_{\text{overall}} = (Uf_{\text{area}})_{\text{insulation}} + (Uf_{\text{area}})_{\text{stud}}$$

and the value of the area fraction f_{area} is 0.80 for insulation section and 0.20 for stud section since the headers that constitute a small part of the wall are to be treated as studs. Using the available R -values from Table 16-10 and calculating others, the total R -values for each section is determined in the table below.

Construction	R -value, $\text{m}^2 \cdot ^\circ\text{C}/\text{W}$	
	Between studs	At studs
1. Outside surface, 12 km/h wind	0.044	0.044
2. Wood bevel lapped siding	0.14	0.14
3. Fiberboard sheathing, 13 mm	0.23	0.23
4a. Mineral fiber insulation, 140 mm	3.696	--
4b. Wood stud, 38 mm by 140 mm	--	0.98
5. Gypsum wallboard, 13 mm	0.079	0.079
6. Inside surface, still air	0.12	0.12

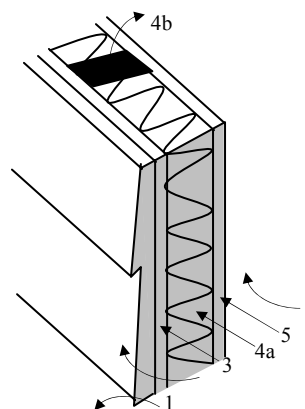

Total unit thermal resistance of each section, R (in $\text{m}^2 \cdot ^\circ\text{C}/\text{W}$)	4.309	1.593
The U -factor of each section, $U = 1/R$, in $\text{W}/\text{m}^2 \cdot ^\circ\text{C}$	0.232	0.628
Area fraction of each section, f_{area}	0.80	0.20
Overall U -factor, $U = \sum f_{\text{area},i} U_i = 0.80 \times 0.232 + 0.20 \times 0.628$	0.311 $\text{W}/\text{m}^2 \cdot ^\circ\text{C}$	
Overall unit thermal resistance, $R = 1/U$	3.213 $\text{m}^2 \cdot ^\circ\text{C}/\text{W}$	

Therefore, the R -value and U -factor of the wall are $R = 3.213 \text{ m}^2 \cdot ^\circ\text{C}/\text{W}$ and $U = 0.311 \text{ W}/\text{m}^2 \cdot ^\circ\text{C}$.

16-60 The change in the R -value of a wood frame wall due to replacing fiberwood sheathing in the wall by rigid foam sheathing is to be determined.

Assumptions 1 Steady operating conditions exist. 2 Heat transfer through the wall is one-dimensional. 3 Thermal properties of the wall and the heat transfer coefficients are constant.

Properties The R -values of different materials are given in Table 16-10.

Analysis The schematic of the wall as well as the different elements used in its construction are shown below. Heat transfer through the insulation and through the studs will meet different resistances, and thus we need to analyze the thermal resistance for each path separately. Once the unit thermal resistances and the U -factors for the insulation and stud sections are available, the overall average thermal resistance for the entire wall can be determined from

$$R_{\text{overall}} = 1/U_{\text{overall}} \quad \text{where} \quad U_{\text{overall}} = (Uf_{\text{area}})_{\text{insulation}} + (Uf_{\text{area}})_{\text{stud}}$$

and the value of the area fraction f_{area} is 0.80 for insulation section and 0.20 for stud section since the headers that constitute a small part of the wall are to be treated as studs. Using the available R -values from Table 16-10 and calculating others, the total R -values for each section of the existing wall is determined in the table below.

Construction	R -value, $\text{m}^2 \cdot \text{C}/\text{W}$	
	Between studs	At studs
1. Outside surface, 12 km/h wind	0.044	0.044
2. Wood bevel lapped siding	0.14	0.14
3. Rigid foam, 25 mm	0.98	0.98
4a. Mineral fiber insulation, 140 mm	3.696	--
4b. Wood stud, 38 mm by 140 mm	--	0.98
5. Gypsum wallboard, 13 mm	0.079	0.079
6. Inside surface, still air	0.12	0.12

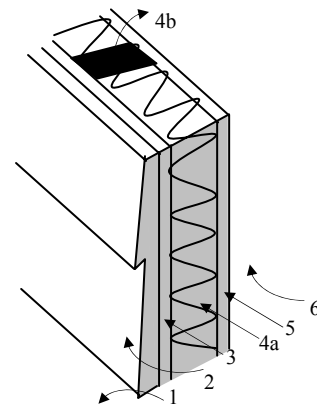

Total unit thermal resistance of each section, R (in $\text{m}^2 \cdot \text{C}/\text{W}$)	5.059	2.343
The U -factor of each section, $U = 1/R$, in $\text{W}/\text{m}^2 \cdot \text{C}$	0.198	0.426
Area fraction of each section, f_{area}	0.80	0.20
Overall U -factor, $U = \sum f_{\text{area},i} U_i = 0.80 \times 0.232 + 0.20 \times 0.628$	0.2436 $\text{W}/\text{m}^2 \cdot \text{C}$	
Overall unit thermal resistance, $R = 1/U$	4.105 $\text{m}^2 \cdot \text{C}/\text{W}$	

The R -value of the existing wall is $R = 3.213 \text{ m}^2 \cdot \text{C}/\text{W}$. Then the change in the R -value becomes

$$\% \text{ Change} = \frac{\Delta R - \text{value}}{R - \text{value, old}} = \frac{4.105 - 3.213}{4.105} = 0.217 \quad (\text{or } 21.7\%)$$

16-61E The R -value and the U -factor of a masonry cavity wall are to be determined.

Assumptions 1 Steady operating conditions exist. 2 Heat transfer through the wall is one-dimensional. 3 Thermal properties of the wall and the heat transfer coefficients are constant.

Properties The R -values of different materials are given in Table 16-10.

Analysis The schematic of the wall as well as the different elements used in its construction are shown below. Heat transfer through the air space and through the studs will meet different resistances, and thus we need to analyze the thermal resistance for each path separately. Once the unit thermal resistances and the U -factors for the air space and stud sections are available, the overall average thermal resistance for the entire wall can be determined from

$$R_{\text{overall}} = 1/U_{\text{overall}} \quad \text{where} \quad U_{\text{overall}} = (Uf_{\text{area}})_{\text{air space}} + (Uf_{\text{area}})_{\text{stud}}$$

and the value of the area fraction f_{area} is 0.80 for air space and 0.20 for the furrings and similar structures. Using the available R -values from Table 16-10 and calculating others, the total R -values for each section of the existing wall is determined in the table below.

Construction	R -value, $\text{h}\cdot\text{ft}^2\cdot^\circ\text{F}/\text{Btu}$	
	Between furring	At furring
1. Outside surface, 15 mph wind	0.17	0.17
2. Face brick, 4 in	0.43	0.43
3. Cement mortar, 0.5 in	0.10	0.10
4. Concrete block, 4-in	1.51	1.51
5a. Air space, 3/4-in, nonreflective	2.91	--
5b. Nominal 1 × 3 vertical furring	--	0.94
6. Gypsum wallboard, 0.5 in	0.45	0.45
7. Inside surface, still air	0.68	0.68

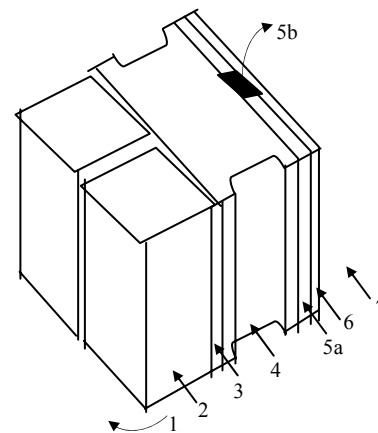

Total unit thermal resistance of each section, R	6.25	4.28
The U -factor of each section, $U = 1/R$, in $\text{Btu}/\text{h}\cdot\text{ft}^2\cdot^\circ\text{F}$	0.160	0.234
Area fraction of each section, f_{area}	0.80	0.20
Overall U -factor, $U = \sum f_{\text{area},i} U_i = 0.80 \times 0.160 + 0.20 \times 0.234$	0.175 $\text{Btu}/\text{h}\cdot\text{ft}^2\cdot^\circ\text{F}$	
Overall unit thermal resistance, $R = 1/U$	5.72 $\text{h}\cdot\text{ft}^2\cdot^\circ\text{F}/\text{Btu}$	

Therefore, the overall unit thermal resistance of the wall is $R = 5.72 \text{ h}\cdot\text{ft}^2\cdot^\circ\text{F}/\text{Btu}$ and the overall U -factor is $U = 0.175 \text{ Btu}/\text{h}\cdot\text{ft}^2\cdot^\circ\text{F}$. These values account for the effects of the vertical furring.

16-62 The winter R -value and the U -factor of a flat ceiling with an air space are to be determined for the cases of air space with reflective and nonreflective surfaces.

Assumptions 1 Steady operating conditions exist. **2** Heat transfer through the ceiling is one-dimensional. **3** Thermal properties of the ceiling and the heat transfer coefficients are constant.

Properties The R -values of different materials are given in Table 16-10. The R -values of different air layers are given in Table 16-13.

Analysis The schematic of the ceiling as well as the different elements used in its construction are shown below. Heat transfer through the air space and through the studs will meet different resistances, and thus we need to analyze the thermal resistance for each path separately. Once the unit thermal resistances and the U -factors for the air space and stud sections are available, the overall average thermal resistance for the entire wall can be determined from

$R_{\text{overall}} = 1/U_{\text{overall}}$ where $U_{\text{overall}} = (Uf_{\text{area}})_{\text{air space}} + (Uf_{\text{area}})_{\text{stud}}$ and the value of the area fraction f_{area} is 0.82 for air space and 0.18 for stud section since the headers which constitute a small part of the wall are to be treated as studs.

(a) Nonreflective surfaces, $\varepsilon_1 = \varepsilon_2 = 0.9$ and thus $\varepsilon_{\text{effective}} = \frac{1}{1/\varepsilon_1 + 1/\varepsilon_2 - 1} = \frac{1}{1/0.9 + 1/0.9 - 1} = 0.82$

Construction	R -value, $\text{m}^2 \cdot \text{C}/\text{W}$	
	Between studs	At studs
1. Still air above ceiling	0.12	0.044
2. Linoleum ($R = 0.009 \text{ m}^2 \cdot \text{C}/\text{W}$)	0.009	0.14
3. Felt ($R = 0.011 \text{ m}^2 \cdot \text{C}/\text{W}$)	0.011	0.23
4. Plywood, 13 mm	0.11	
5. Wood subfloor ($R = 0.166 \text{ m}^2 \cdot \text{C}/\text{W}$)	0.166	
6a. Air space, 90 mm, nonreflective	0.16	---
6b. Wood stud, 38 mm by 90 mm	---	0.63
7. Gypsum wallboard, 13 mm	0.079	0.079
8. Still air below ceiling	0.12	0.12

Total unit thermal resistance of each section, R (in $\text{m}^2 \cdot \text{C}/\text{W}$)	0.775	1.243
The U -factor of each section, $U = 1/R$, in $\text{W}/\text{m}^2 \cdot \text{C}$	1.290	0.805
Area fraction of each section, f_{area}	0.82	0.18
Overall U -factor, $U = \sum f_{\text{area},i} U_i = 0.82 \times 1.290 + 0.18 \times 0.805$	1.203 $\text{W}/\text{m}^2 \cdot \text{C}$	
Overall unit thermal resistance, $R = 1/U$	0.831 $\text{m}^2 \cdot \text{C}/\text{W}$	

(b) One-reflective surface, $\varepsilon_1 = 0.05$ and $\varepsilon_2 = 0.9 \rightarrow \varepsilon_{\text{effective}} = \frac{1}{1/\varepsilon_1 + 1/\varepsilon_2 - 1} = \frac{1}{1/0.05 + 1/0.9 - 1} = 0.05$

In this case we replace item 6a from 0.16 to $0.47 \text{ m}^2 \cdot \text{C}/\text{W}$. It gives $R = 1.085 \text{ m}^2 \cdot \text{C}/\text{W}$ and $U = 0.922 \text{ W}/\text{m}^2 \cdot \text{C}$ for the air space. Then,

Overall U -factor, $U = \sum f_{\text{area},i} U_i = 0.82 \times 1.085 + 0.18 \times 0.805$	1.035 $\text{W}/\text{m}^2 \cdot \text{C}$
Overall unit thermal resistance, $R = 1/U$	0.967 $\text{m}^2 \cdot \text{C}/\text{W}$

(c) Two-reflective surface, $\varepsilon_1 = \varepsilon_2 = 0.05 \rightarrow \varepsilon_{\text{effective}} = \frac{1}{1/\varepsilon_1 + 1/\varepsilon_2 - 1} = \frac{1}{1/0.05 + 1/0.05 - 1} = 0.03$

In this case we replace item 6a from 0.16 to $0.49 \text{ m}^2 \cdot \text{C}/\text{W}$. It gives $R = 1.105 \text{ m}^2 \cdot \text{C}/\text{W}$ and $U = 0.905 \text{ W}/\text{m}^2 \cdot \text{C}$ for the air space. Then,

Overall U -factor, $U = \sum f_{\text{area},i} U_i = 0.82 \times 1.105 + 0.18 \times 0.805$	1.051 $\text{W}/\text{m}^2 \cdot \text{C}$
Overall unit thermal resistance, $R = 1/U$	0.951 $\text{m}^2 \cdot \text{C}/\text{W}$

16-63 The winter R -value and the U -factor of a masonry cavity wall are to be determined.

Assumptions 1 Steady operating conditions exist. 2 Heat transfer through the wall is one-dimensional. 3 Thermal properties of the wall and the heat transfer coefficients are constant.

Properties The R -values of different materials are given in Table 16-10.

Analysis The schematic of the wall as well as the different elements used in its construction are shown below. Heat transfer through the air space and through the studs will meet different resistances, and thus we need to analyze the thermal resistance for each path separately. Once the unit thermal resistances and the U -factors for the air space and stud sections are available, the overall average thermal resistance for the entire wall can be determined from

$$R_{\text{overall}} = 1/U_{\text{overall}} \quad \text{where} \quad U_{\text{overall}} = (Uf_{\text{area}})_{\text{air space}} + (Uf_{\text{area}})_{\text{stud}}$$

and the value of the area fraction f_{area} is 0.84 for air space and 0.16 for the ferrings and similar structures. Using the available R -values from Tables 16-10 and 16-13 and calculating others, the total R -values for each section of the existing wall is determined in the table below.

Construction	R -value, $\text{m}^2 \cdot ^\circ\text{C}/\text{W}$	
	Between furring	At furring
1. Outside surface, 24 km/h	0.030	0.030
2. Face brick, 100 mm	0.12	0.12
3. Air space, 90-mm, nonreflective	0.16	0.16
4. Concrete block, lightweight, 100-mm	0.27	0.27
5a. Air space, 20 mm, nonreflective	0.17	---
5b. Vertical furring, 20 mm thick	---	0.94
6. Gypsum wallboard, 13	0.079	0.079
7. Inside surface, still air	0.12	0.12

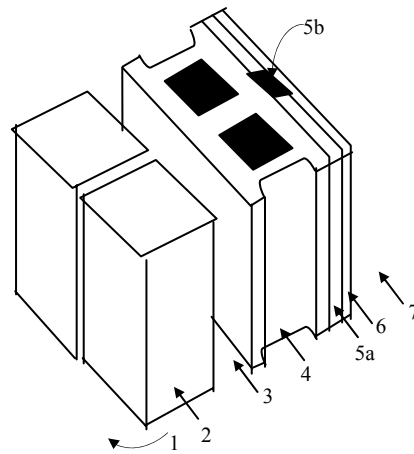

Total unit thermal resistance of each section, R	0.949	1.719
The U -factor of each section, $U = 1/R$, in $\text{W}/\text{m}^2 \cdot ^\circ\text{C}$	1.054	0.582
Area fraction of each section, f_{area}	0.84	0.16
Overall U -factor, $U = \sum f_{\text{area},i} U_i = 0.84 \times 1.054 + 0.16 \times 0.582$	0.978 $\text{W}/\text{m}^2 \cdot ^\circ\text{C}$	
Overall unit thermal resistance, $R = 1/U$	1.02 $\text{m}^2 \cdot ^\circ\text{C}/\text{W}$	

Therefore, the overall unit thermal resistance of the wall is $R = 1.02 \text{ m}^2 \cdot ^\circ\text{C}/\text{W}$ and the overall U -factor is $U = 0.978 \text{ W}/\text{m}^2 \cdot ^\circ\text{C}$. These values account for the effects of the vertical furring.

16-64 The winter R -value and the U -factor of a masonry cavity wall with a reflective surface are to be determined.

Assumptions 1 Steady operating conditions exist. 2 Heat transfer through the wall is one-dimensional. 3 Thermal properties of the wall and the heat transfer coefficients are constant.

Properties The R -values of different materials are given in Table 16-10. The R -values of air spaces are given in Table 16-13.

Analysis The schematic of the wall as well as the different elements used in its construction are shown below. Heat transfer through the air space and through the studs will meet different resistances, and thus we need to analyze the thermal resistance for each path separately. Once the unit thermal resistances and the U -factors for the air space and stud sections are available, the overall average thermal resistance for the entire wall can be determined from

$$R_{\text{overall}} = 1/U_{\text{overall}}$$

$$\text{where } U_{\text{overall}} = (Uf_{\text{area}})_{\text{air space}} + (Uf_{\text{area}})_{\text{stud}}$$

and the value of the area fraction f_{area} is 0.84 for air space and 0.16 for the furrings and similar structures.

For an air space with one-reflective surface, we have

$$\varepsilon_1 = 0.05 \text{ and } \varepsilon_2 = 0.9, \text{ and thus}$$

$$\varepsilon_{\text{effective}} = \frac{1}{1/\varepsilon_1 + 1/\varepsilon_2 - 1} = \frac{1}{1/0.05 + 1/0.9 - 1} = 0.05$$

Using the available R -values from Tables 16-10 and 16-13 and calculating others, the total R -values for each section of the existing wall is determined in the table below.

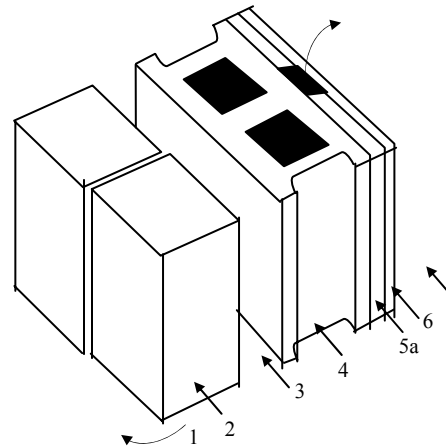

Construction	R -value, $\text{m}^2 \cdot ^\circ\text{C}/\text{W}$	
	Between furring	At furring
1. Outside surface, 24 km/h	0.030	0.030
2. Face brick, 100 mm	0.12	0.12
3. Air space, 90-mm, reflective with $\varepsilon = 0.05$	0.45	0.45
4. Concrete block, lightweight, 100-mm	0.27	0.27
5a. Air space, 20 mm, reflective with $\varepsilon = 0.05$	0.49	---
5b. Vertical furring, 20 mm thick	---	0.94
6. Gypsum wallboard, 13	0.079	0.079
7. Inside surface, still air	0.12	0.12

Total unit thermal resistance of each section, R	1.559	2.009
The U -factor of each section, $U = 1/R$, in $\text{W}/\text{m}^2 \cdot ^\circ\text{C}$	0.641	0.498
Area fraction of each section, f_{area}	0.84	0.16
Overall U -factor, $U = \sum f_{\text{area},i} U_i = 0.84 \times 1.05 + 0.16 \times 0.582$	0.618 $\text{W}/\text{m}^2 \cdot ^\circ\text{C}$	
Overall unit thermal resistance, $R = 1/U$	1.62 $\text{m}^2 \cdot ^\circ\text{C}/\text{W}$	

Therefore, the overall unit thermal resistance of the wall is $R = 1.62 \text{ m}^2 \cdot ^\circ\text{C}/\text{W}$ and the overall U -factor is $U = 0.618 \text{ W}/\text{m}^2 \cdot ^\circ\text{C}$. These values account for the effects of the vertical furring.

Discussion The change in the U -value as a result of adding reflective surfaces is

$$\text{Change} = \frac{\Delta U - \text{value}}{U - \text{value, nonreflective}} = \frac{0.978 - 0.618}{0.978} = 0.368$$

Therefore, the rate of heat transfer through the wall will decrease by 36.8% as a result of adding a reflective surface.

16-65 The winter R -value and the U -factor of a masonry wall are to be determined.

Assumptions 1 Steady operating conditions exist. 2 Heat transfer through the wall is one-dimensional. 3 Thermal properties of the wall and the heat transfer coefficients are constant.

Properties The R -values of different materials are given in Table 16-10.

Analysis Using the available R -values from Tables 16-10, the total R -value of the wall is determined in the table below.

Construction	R -value, $\text{m}^2 \cdot ^\circ\text{C}/\text{W}$
1. Outside surface, 24 km/h	0.030
2. Face brick, 100 mm	0.075
3. Common brick, 100 mm	0.12
4. Urethane foam insulation, 25-mm	0.98
5. Gypsum wallboard, 13 mm	0.079
6. Inside surface, still air	0.12

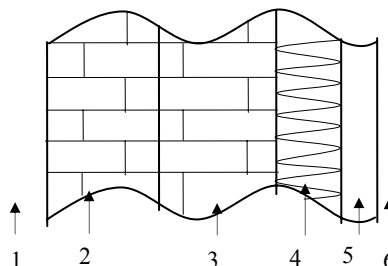

Total unit thermal resistance of each section, R	1.404 $\text{m}^2 \cdot ^\circ\text{C}/\text{W}$
The U -factor of each section, $U = 1/R$	0.712 $\text{W}/\text{m}^2 \cdot ^\circ\text{C}$

Therefore, the overall unit thermal resistance of the wall is $R = 1.404 \text{ m}^2 \cdot ^\circ\text{C}/\text{W}$ and the overall U -factor is $U = 0.712 \text{ W}/\text{m}^2 \cdot ^\circ\text{C}$.

16-66 The U -value of a wall under winter design conditions is given. The U -value of the wall under summer design conditions is to be determined.

Assumptions 1 Steady operating conditions exist. 2 Heat transfer through the wall is one-dimensional. 3 Thermal properties of the wall and the heat transfer coefficients are constant except the one at the outer surface.

Properties The R -values at the outer surface of a wall for summer (12 km/h winds) and winter (24 km/h winds) conditions are given in Table 3-6 to be $R_{o, \text{summer}} = 0.044 \text{ m}^2 \cdot ^\circ\text{C}/\text{W}$ and $R_{o, \text{winter}} = 0.030 \text{ m}^2 \cdot ^\circ\text{C}/\text{W}$.

Analysis The R -value of the existing wall is

$$R_{\text{winter}} = 1/U_{\text{winter}} = 1/1.40 = 0.714 \text{ m}^2 \cdot ^\circ\text{C}/\text{W}$$

Noting that the added and removed thermal resistances are in series, the overall R -value of the wall under summer conditions becomes

$$\begin{aligned} R_{\text{summer}} &= R_{\text{winter}} - R_{o, \text{winter}} + R_{o, \text{summer}} \\ &= 0.714 - 0.030 + 0.044 \\ &= 0.728 \text{ m}^2 \cdot ^\circ\text{C}/\text{W} \end{aligned}$$

Then the summer U -value of the wall becomes

$$R_{\text{summer}} = 1/U_{\text{summer}} = 1/0.728 = \mathbf{1.37 \text{ m}^2 \cdot ^\circ\text{C}/\text{W}}$$

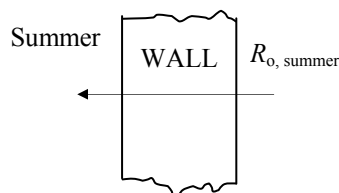
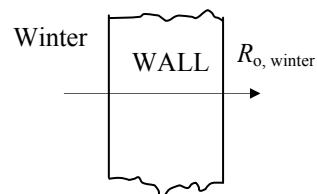

16-67 The U -value of a wall is given. A layer of face brick is added to the outside of a wall, leaving a 20-mm air space between the wall and the bricks. The new U -value of the wall and the rate of heat transfer through the wall is to be determined.

Assumptions 1 Steady operating conditions exist. 2 Heat transfer through the wall is one-dimensional. 3 Thermal properties of the wall and the heat transfer coefficients are constant.

Properties The U -value of a wall is given to be $U = 2.25 \text{ W/m}^2 \cdot ^\circ\text{C}$. The R -values of 100-mm face brick and a 20-mm air space between the wall and the bricks various layers are 0.075 and $0.170 \text{ m}^2 \cdot ^\circ\text{C/W}$, respectively.

Analysis The R -value of the existing wall for the winter conditions is

$$R_{\text{existing wall}} = 1/U_{\text{existing wall}} = 1/2.25 = 0.444 \text{ m}^2 \cdot ^\circ\text{C/W}$$

Noting that the added thermal resistances are in series, the overall R -value of the wall becomes

$$\begin{aligned} R_{\text{modified wall}} &= R_{\text{existing wall}} + R_{\text{brick}} + R_{\text{air layer}} \\ &= 0.44 + 0.075 + 0.170 = 0.689 \text{ m}^2 \cdot ^\circ\text{C/W} \end{aligned}$$

Then the U -value of the wall after modification becomes

$$R_{\text{modified wall}} = 1/U_{\text{modified wall}} = 1/0.689 = \mathbf{1.45 \text{ m}^2 \cdot ^\circ\text{C/W}}$$

The rate of heat transfer through the modified wall is

$$\dot{Q}_{\text{wall}} = (UA)_{\text{wall}}(T_i - T_o) = (1.45 \text{ W/m}^2 \cdot ^\circ\text{C})(21 \text{ m}^2)[22 - (-5)^\circ\text{C}] = \mathbf{822 \text{ W}}$$

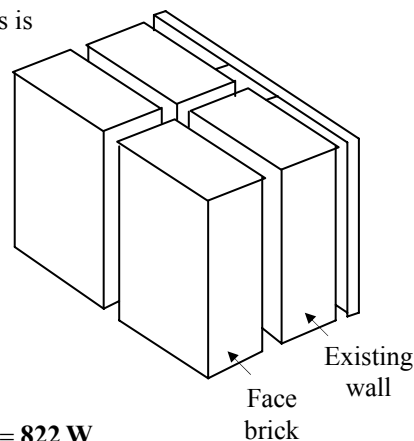

16-68 The summer and winter R -values of a masonry wall are to be determined.

Assumptions 1 Steady operating conditions exist. 2 Heat transfer through the wall is one-dimensional. 3 Thermal properties of the wall and the heat transfer coefficients are constant. 4 The air cavity does not have any reflecting surfaces.

Properties The R -values of different materials are given in Table 16-10.

Analysis Using the available R -values from Tables 16-10, the total R -value of the wall is determined in the table below.

Construction	R -value, $\text{m}^2 \cdot ^\circ\text{C/W}$	
	Summer	Winter
1a. Outside surface, 24 km/h (winter)	---	0.030
1b. Outside surface, 12 km/h (summer)	0.044	---
2. Face brick, 100 mm	0.075	0.075
3. Cement mortar, 13 mm	0.12	0.12
4. Concrete block, lightweight, 100 mm	0.27	0.27
5. Air space, nonreflecting, 40-mm	0.16	0.16
5. Plaster board, 20 mm	0.122	0.122
6. Inside surface, still air	0.12	0.12
Total unit thermal resistance of each section (the R -value), $\text{m}^2 \cdot ^\circ\text{C/W}$	0.809	0.795

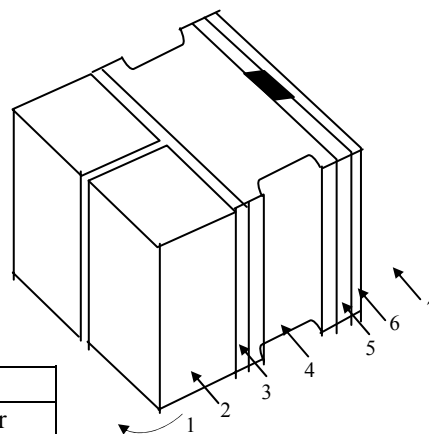

Therefore, the overall unit thermal resistance of the wall is $R = 0.809 \text{ m}^2 \cdot ^\circ\text{C/W}$ in summer and $R = 0.795 \text{ m}^2 \cdot ^\circ\text{C/W}$ in winter.

16-69E The U -value of a wall for 7.5 mph winds outside are given. The U -value of the wall for the case of 15 mph winds outside is to be determined.

Assumptions 1 Steady operating conditions exist. 2 Heat transfer through the wall is one-dimensional. 3 Thermal properties of the wall and the heat transfer coefficients are constant except the one at the outer surface.

Properties The R -values at the outer surface of a wall for summer (7.5 mph winds) and winter (15 mph winds) conditions are given in Table 3-8 to be

$$R_{o, 7.5 \text{ mph}} = R_{o, \text{summer}} = 0.25 \text{ h}\cdot\text{ft}^2\cdot\text{°F}/\text{Btu}$$

and $R_{o, 15 \text{ mph}} = R_{o, \text{winter}} = 0.17 \text{ h}\cdot\text{ft}^2\cdot\text{°F}/\text{Btu}$

Analysis The R -value of the wall at 7.5 mph winds (summer) is

$$R_{\text{wall}, 7.5 \text{ mph}} = 1/U_{\text{wall}, 7.5 \text{ mph}} = 1/0.075 = 13.33 \text{ h}\cdot\text{ft}^2\cdot\text{°F}/\text{Btu}$$

Noting that the added and removed thermal resistances are in series, the overall R -value of the wall at 15 mph (winter) conditions is obtained by replacing the summer value of outer convection resistance by the winter value,

$$\begin{aligned} R_{\text{wall}, 15 \text{ mph}} &= R_{\text{wall}, 7.5 \text{ mph}} - R_{o, 7.5 \text{ mph}} + R_{o, 15 \text{ mph}} \\ &= 13.33 - 0.25 + 0.17 = 13.25 \text{ h}\cdot\text{ft}^2\cdot\text{°F}/\text{Btu} \end{aligned}$$

Then the U -value of the wall at 15 mph winds becomes

$$R_{\text{wall}, 15 \text{ mph}} = 1/U_{\text{wal}, 15 \text{ mph}} = 1/13.25 = \mathbf{0.0755 \text{ h}\cdot\text{ft}^2\cdot\text{°F}/\text{Btu}}$$

Discussion Note that the effect of doubling the wind velocity on the U -value of the wall is less than 1 percent since

$$\text{Change} = \frac{\Delta U - \text{value}}{U - \text{value}} = \frac{0.0755 - 0.075}{0.075} = 0.0067 \quad (\text{or } 0.67\%)$$

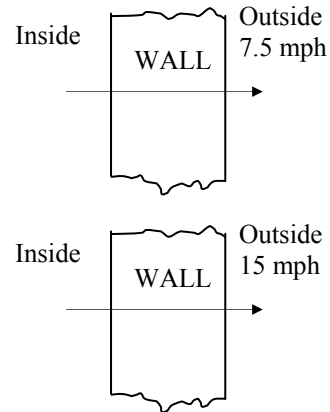

16-70 Two homes are identical, except that their walls are constructed differently. The house that is more energy efficient is to be determined.

Assumptions 1 The homes are identical, except that their walls are constructed differently. 2 Heat transfer through the wall is one-dimensional. 3 Thermal properties of the wall and the heat transfer coefficients are constant.

Properties The R -values of different materials are given in Table 16-10.

Analysis Using the available R -values from Tables 16-10, the total R -value of the masonry wall is determined in the table below.

Construction	R -value, $\text{m}^2 \cdot ^\circ\text{C}/\text{W}$
1. Outside surface, 24 km/h (winter)	0.030
2. Concrete block, light weight, 200 mm	$2 \times 0.27 = 0.54$
3. Air space, nonreflecting, 20 mm	0.17
4. Urethane foam insulation, 25-mm	0.98
5. Plasterboard, 20 mm	0.12
6. Inside surface, still air	0.12

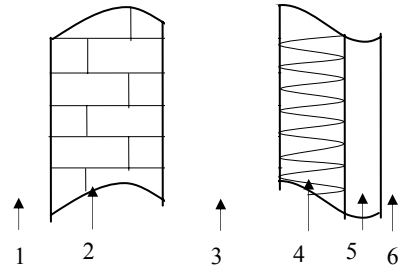

Total unit thermal resistance (the R -value)	$0.98 \text{ m}^2 \cdot ^\circ\text{C}/\text{W}$
--	--

which is less than $2.4 \text{ m}^2 \cdot ^\circ\text{C}/\text{W}$. Therefore, the standard $R=2.4 \text{ m}^2 \cdot ^\circ\text{C}/\text{W}$ wall is better insulated and thus it is more energy efficient.

16-71 A ceiling consists of a layer of reflective acoustical tiles. The R -value of the ceiling is to be determined for winter conditions.

Assumptions 1 Heat transfer through the ceiling is one-dimensional. 3 Thermal properties of the ceiling and the heat transfer coefficients are constant.

Properties The R -values of different materials are given in Tables 16-10 and 16-11.

Analysis Using the available R -values, the total R -value of the ceiling is determined in the table below.

Construction	R -value, $\text{m}^2 \cdot ^\circ\text{C}/\text{W}$
1. Still air, reflective horizontal surface facing up	$R = 1/h = 1/4.32 = 0.23$
2. Acoustic tile, 19 mm	0.32
3. Still air, horizontal surface, facing down	$R = 1/h = 1/9.26 = 0.11$

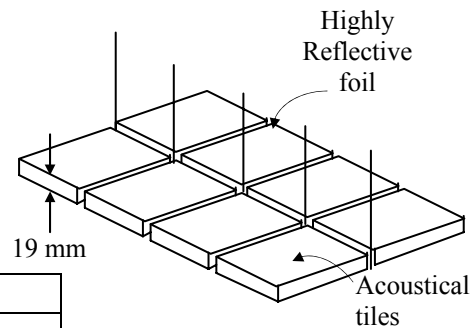

Total unit thermal resistance (the R -value)	$0.66 \text{ m}^2 \cdot ^\circ\text{C}/\text{W}$
--	--

Therefore, the R -value of the hanging ceiling is $0.66 \text{ m}^2 \cdot ^\circ\text{C}/\text{W}$.

Heat Loss from Basement Walls and Floors

16-72C The mechanism of heat transfer from the basement walls and floors to the ground is *conduction heat transfer* because of the direct contact between the walls and the floor. The rate of heat loss through the ground depends on the thermal conductivity of the soil, which depends on the composition and moisture content of the soil. The higher the moisture content, the higher the thermal conductivity, and the higher the rate of heat transfer.

16-73C For a basement wall that is completely below grade, the heat loss through the upper half of the wall will be greater than the heat loss through the lower half since the heat at a lower section must pass through a longer path to reach the ground surface, and thus overcome a larger thermal resistance.

16-74C A building loses more heat to the ground through the below grade section of the basement wall than it does through the floor of a basement per unit surface area. This is because the floor has a very long path for heat transfer to the ground surface compared to the wall.

16-75C Heat transfer from a floor on grade at ground level is proportional to the perimeter of the floor, not the surface area.

16-76C Venting a crawl space increases heat loss through the floor since it will expose the bottom of the floor to a lower temperature in winter. Venting a crawl space in summer will increase heat gain through the floor since it will expose the bottom of the floor to a higher temperature.

16-77C The cold water pipes in an unheated crawl space in winter does not need to be insulated to avoid the danger of freezing in winter if the vents of the crawl space are tightly closed since, in this case, the temperature in the crawl space will be somewhere between the house temperature and the ambient temperature that will normally be above freezing.

16-78 The peak heat loss from a below grade basement in Anchorage, Alaska to the ground through its walls and the floor is to be determined.

Assumptions 1 Steady operating conditions exist. 2 The basement is maintained at 20°C.

Properties The heat transfer coefficients are given in Table 16-14a, and the amplitudes in Fig. 16-37.

Solution The floor and wall areas of the basement are

$$A_{\text{wall}} = \text{Height} \times \text{Perimeter} = 2 \times (1.8 \text{ m})(7 + 10 \text{ m}) = 61.2 \text{ m}^2$$

$$A_{\text{floor}} = \text{Length} \times \text{Width} = (7 \text{ m})(10 \text{ m}) = 70 \text{ m}^2$$

The amplitude of the annual soil temperature is determined from Fig. 16-37 to be 10°C. Then the ground surface temperature for the design heat loss becomes

$$T_{\text{ground surface}} = T_{\text{winter, mean}} - A = -5 - 10 = -15^\circ\text{C}$$

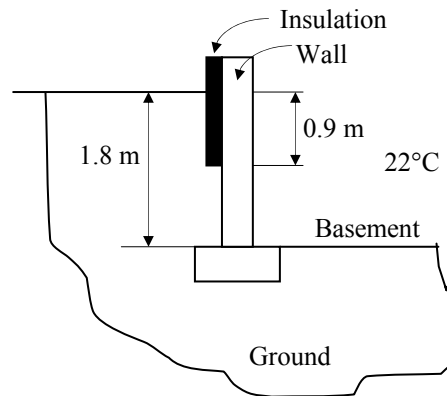

The top 0.9-m section of the wall below the grade is insulated with R -2.2, and the heat transfer coefficients through that section are given in Table 16-14a to be 1.27, 1.20, and 1.00 $\text{W}/\text{m}^2 \cdot ^\circ\text{C}$ through the 1st, 2nd, and 3rd 0.3-m wide depth increments, respectively. The heat transfer coefficients through the uninsulated section of the wall which extends from 0.9 m to 1.8 m level is determined from the same table to be 2.23, 1.80, and 1.50 $\text{W}/\text{m}^2 \cdot ^\circ\text{C}$ for each of the remaining 0.3-m wide depth increments. The average overall heat transfer coefficient is

$$U_{\text{wall, ave}} = \frac{\sum U_{\text{wall}}}{\text{No. of increments}} = \frac{1.27 + 1.2 + 1.0 + 2.23 + 1.8 + 1.5}{6} = 1.50 \text{ W}/\text{m}^2 \cdot ^\circ\text{C}$$

Then the heat loss through the basement wall becomes

$$\begin{aligned} \dot{Q}_{\text{basement walls}} &= U_{\text{wall, ave}} A_{\text{wall}} (T_{\text{basement}} - T_{\text{ground surface}}) \\ &= (1.50 \text{ W}/\text{m}^2 \cdot ^\circ\text{C})(61.2 \text{ m}^2)[20 - (-15)^\circ\text{C}] = 3213 \text{ W} \end{aligned}$$

The shortest width of the house is 7 m, and the depth of the foundation below grade is 1.8 m. The floor heat transfer coefficient is given in Table 16-14b to be 0.15 $\text{W}/\text{m}^2 \cdot ^\circ\text{C}$. Then the heat loss through the floor of the basement becomes

$$\begin{aligned} \dot{Q}_{\text{basement floor}} &= U_{\text{floor}} A_{\text{floor}} (T_{\text{basement}} - T_{\text{ground surface}}) \\ &= (0.15 \text{ W}/\text{m}^2 \cdot ^\circ\text{C})(70 \text{ m}^2)[20 - (-15)^\circ\text{C}] = 368 \text{ W} \end{aligned}$$

which is considerably less than the heat loss through the wall. The total heat loss from the basement is then determined to be

$$\dot{Q}_{\text{basement}} = \dot{Q}_{\text{basement wall}} + \dot{Q}_{\text{basement floor}} = 3213 + 368 = \mathbf{3581 \text{ W}}$$

Discussion This is the *design* or *peak* rate of heat transfer from below-grade section of the basement, and this is the value to be used when sizing the heating system. The actual heat loss from the basement will be much less than that most of the time.

16-79 The vent of the crawl space is kept open. The rate of heat loss to the crawl space through insulated and uninsulated floors is to be determined.

Assumptions 1 Steady operating conditions exist. 2 The vented crawl space temperature is the same as the ambient temperature.

Properties The overall heat transfer coefficient for the insulated floor is given in Table 16-15 to be $0.432 \text{ W/m}^2 \cdot ^\circ\text{C}$. It is $1.42 \text{ W/m}^2 \cdot ^\circ\text{C}$ for the uninsulated floor.

Analysis (a) The floor area of the house (or the ceiling area of the crawl space) is

$$A_{\text{floor}} = \text{Length} \times \text{Width} = (8 \text{ m})(12 \text{ m}) = 96 \text{ m}^2$$

Then the heat loss from the house to the crawl space becomes

$$\begin{aligned} \dot{Q}_{\text{insulated floor}} &= U_{\text{insulated floor}} A_{\text{floor}} (T_{\text{indoor}} - T_{\text{crawl}}) \\ &= (0.432 \text{ W/m}^2 \cdot ^\circ\text{C})(180 \text{ m}^2)(21 - 2.5)^\circ\text{C} \\ &= \mathbf{1439 \text{ W}} \end{aligned}$$

(b) The heat loss for the uninsulated case is determined similarly to be

$$\begin{aligned} \dot{Q}_{\text{uninsulated floor}} &= U_{\text{uninsulated floor}} A_{\text{floor}} (T_{\text{indoor}} - T_{\text{crawl}}) \\ &= (1.42 \text{ W/m}^2 \cdot ^\circ\text{C})(180 \text{ m}^2)(21 - 2.5)^\circ\text{C} = \mathbf{4729 \text{ W}} \end{aligned}$$

Discussion Note that heat loss through the uninsulated floor is more than 3 times the heat loss through the insulated floor. Therefore, it is a good practice to insulate floors when the crawl space is ventilated to conserve energy and enhance comfort.

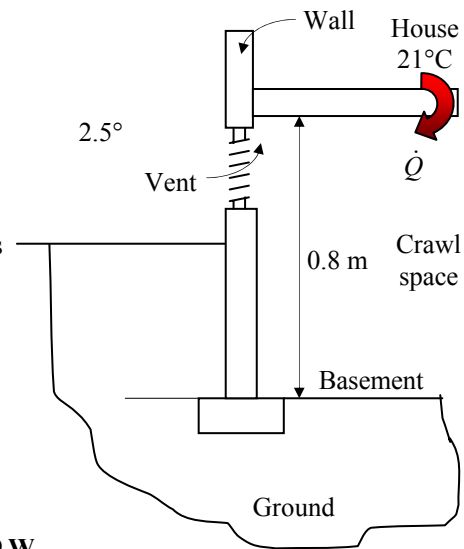

16-80 The peak heat loss from a below grade basement in Boise, Idaho to the ground through its walls and the floor is to be determined.

Assumptions 1 Steady operating conditions exist. 2 The basement is maintained at 18°C.

Properties The heat transfer coefficients are given in Table 16-14a, and the amplitudes in Fig. 16-37. The mean winter temperature in Boise is 4.6°C (Table 16-5).

Analysis The floor and wall areas of the basement are

$$A_{\text{wall}} = \text{Height} \times \text{Perimeter} = 2 \times (1.8 \text{ m})(8 + 12 \text{ m}) = 108 \text{ m}^2$$

$$A_{\text{floor}} = \text{Length} \times \text{Width} = (8 \text{ m})(12 \text{ m}) = 96 \text{ m}^2$$

The amplitude of the annual soil temperature is determined from Fig. 16-37 to be 11°C. Then the ground surface temperature for the design heat loss becomes

$$T_{\text{ground surface}} = T_{\text{winter, mean}} - A = 4.6 - 11 = -6.4^\circ\text{C}$$

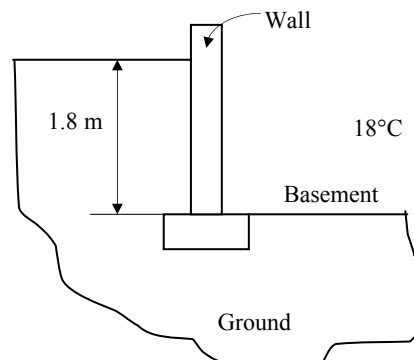

The entire 1.8-m section of the wall below the grade is uninsulated, and the heat transfer coefficients through that section are given in Table 16-14a to be 7.77, 4.20, 2.93, 2.23, 1.80, and 1.50 W/m²·°C for each 0.3-m wide depth increments. The average overall heat transfer coefficient is

$$U_{\text{wall, ave}} = \frac{\sum U_{\text{wall}}}{\text{No. of increments}} = \frac{7.77 + 4.20 + 2.93 + 2.23 + 1.8 + 1.5}{6} = 3.405 \text{ W/m}^2 \cdot ^\circ\text{C}$$

Then the heat loss through the basement wall becomes

$$\begin{aligned} \dot{Q}_{\text{basement walls}} &= U_{\text{wall, ave}} A_{\text{wall}} (T_{\text{basement}} - T_{\text{ground surface}}) \\ &= (3.405 \text{ W/m}^2 \cdot ^\circ\text{C})(108 \text{ m}^2)[18 - (-6.4)^\circ\text{C}] = 8973 \text{ W} \end{aligned}$$

The shortest width of the house is 12 m, and the depth of the foundation below grade is 1.8 m. The floor heat transfer coefficient is given in Table 16-14b to be 0.10 W/m²·°C. Then the heat loss through the floor of the basement becomes

$$\begin{aligned} \dot{Q}_{\text{basement floor}} &= U_{\text{floor}} A_{\text{floor}} (T_{\text{basement}} - T_{\text{ground surface}}) \\ &= (0.10 \text{ W/m}^2 \cdot ^\circ\text{C})(96 \text{ m}^2)[18 - (-6.4)^\circ\text{C}] = 234 \text{ W} \end{aligned}$$

which is considerably less than the heat loss through the wall. The total heat loss from the basement is then determined to be

$$\dot{Q}_{\text{basement}} = \dot{Q}_{\text{basement wall}} + \dot{Q}_{\text{basement floor}} = 8973 + 234 = \mathbf{9207 \text{ W}}$$

Discussion This is the *design* or *peak* rate of heat transfer from below-grade section of the basement, and this is the value to be used when sizing the heating system. The actual heat loss from the basement will be much less than that most of the time.

16-81E The peak heat loss from a below grade basement in Boise, Idaho to the ground through its walls and the floor is to be determined.

Assumptions 1 Steady operating conditions exist. 2 The basement is maintained at 68°F.

Properties The heat transfer coefficients are given in Table 16-14a, and the amplitudes in Fig. 16-37. The mean winter temperature in Boise is 39.7°F (Table 16-5).

Solution The floor and wall areas of the basement are

$$A_{\text{wall}} = \text{Height} \times \text{Perimeter} = 2 \times (6 \text{ ft})(32 + 60 \text{ ft}) = 1104 \text{ ft}^2$$

$$A_{\text{floor}} = \text{Length} \times \text{Width} = (32 \text{ ft})(60 \text{ ft}) = 1920 \text{ ft}^2$$

The amplitude of the annual soil temperature is determined from Fig. 16-37 to be 19.8°F. Then the ground surface temperature for the design heat loss becomes

$$T_{\text{ground surface}} = T_{\text{winter, mean}} - A = 39.7 - 19.8 = 19.9^\circ\text{F}$$

The entire 6-ft section of the wall below the grade is uninsulated, and the heat transfer coefficients through that section are given in Table 16-14a to be 0.410, 0.222, 0.155, 0.119, 0.096, 0.079 Btu/h·ft²·°F for each 1-ft wide depth increments. The average overall heat transfer coefficient is

$$U_{\text{wall, ave}} = \frac{\sum U_{\text{wall}}}{\text{No. of increments}} = \frac{0.410 + 0.222 + 0.155 + 0.119 + 0.096 + 0.079}{6} = 0.180 \text{ Btu/h} \cdot \text{ft}^2 \cdot ^\circ\text{F}$$

Then the heat loss through the basement wall becomes

$$\begin{aligned} \dot{Q}_{\text{basement walls}} &= U_{\text{wall, ave}} A_{\text{wall}} (T_{\text{basement}} - T_{\text{ground surface}}) \\ &= (0.180 \text{ Btu/h} \cdot \text{ft}^2 \cdot ^\circ\text{F})(1104 \text{ ft}^2)(68 - 19.9)^\circ\text{F} = 9558 \text{ Btu/h} \end{aligned}$$

The shortest width of the house is 32 ft, and the depth of the foundation below grade is 6 ft. The floor heat transfer coefficient is given in Table 16-14b to be 0.02 Btu/h·ft²·°F. Then the heat loss through the floor of the basement becomes

$$\begin{aligned} \dot{Q}_{\text{basement floor}} &= U_{\text{floor}} A_{\text{floor}} (T_{\text{basement}} - T_{\text{ground surface}}) \\ &= (0.022 \text{ Btu/h} \cdot \text{ft}^2 \cdot ^\circ\text{F})(1920 \text{ ft}^2)(68 - 19.9)^\circ\text{F} = 2032 \text{ Btu/h} \end{aligned}$$

which is considerably less than the heat loss through the wall. The total heat loss from the basement is then determined to be

$$\dot{Q}_{\text{basement}} = \dot{Q}_{\text{basement wall}} + \dot{Q}_{\text{basement floor}} = 9558 + 2032 = \mathbf{11,590 \text{ Btu/h}}$$

Discussion This is the *design* or *peak* rate of heat transfer from below-grade section of the basement, and this is the value to be used when sizing the heating system. The actual heat loss from the basement will be much less than that most of the time.

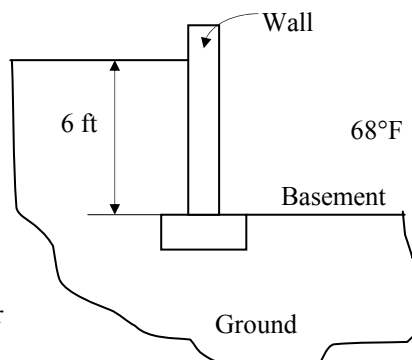

16-82 A house with a concrete slab floor sits directly on the ground at grade level, and the wall below grade is insulated. The heat loss from the floor at winter design conditions is to be determined.

Assumptions 1 Steady operating conditions exist. 2 The house is maintained at 22°C. 3 The weather in Baltimore is moderate.

Properties The 97.5% winter design conditions in Baltimore is -11°C (Table 16-4). The heat transfer coefficient for the insulated wall below grade is $U = 0.86$ W/m·°C (Table 16-14c).

Solution Heat transfer from a floor on the ground at the grade level is proportional to the perimeter of the floor, and the perimeter in this case is

$$p_{\text{floor}} = 2 \times (\text{Length} + \text{Width}) = 2(15 + 18) \text{ m} = 66 \text{ m}$$

Then the heat loss from the floor becomes

$$\begin{aligned} \dot{Q}_{\text{floor}} &= U_{\text{floor}} p_{\text{floor}} (T_{\text{indoor}} - T_{\text{outdoor}}) \\ &= (0.86 \text{ W/m} \cdot \text{°C})(66 \text{ m})[22 - (-11)]\text{°C} = \mathbf{1873 \text{ W}} \end{aligned}$$

Discussion This is the *design* or *peak* rate of heat transfer from below-grade section of the basement, and this is the value to be used when sizing the heating system. The actual heat loss from the basement will be much less than that most of the time.

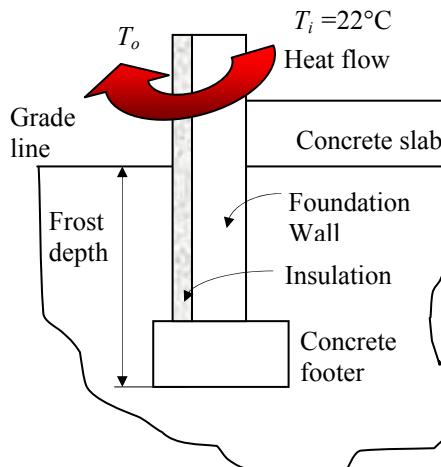

16-83 A house with a concrete slab floor sits directly on the ground at grade level, and the wall below grade is uninsulated. The heat loss from the floor at winter design conditions is to be determined.

Assumptions 1 Steady operating conditions exist. 2 The house is maintained at 22°C. 3 The weather in Baltimore is moderate.

Properties The 97.5% winter design conditions in Baltimore is -11°C (Table 16-4). The heat transfer coefficient for the uninsulated wall below grade is $U = 1.17$ W/m·°C (Table 16-14c).

Solution Heat transfer from a floor on the ground at the grade level is proportional to the perimeter of the floor, and the perimeter in this case is

$$p_{\text{floor}} = 2 \times (\text{Length} + \text{Width}) = 2(15 + 18) \text{ m} = 66 \text{ m}$$

Then the heat loss from the floor becomes

$$\begin{aligned} \dot{Q}_{\text{floor}} &= U_{\text{floor}} p_{\text{floor}} (T_{\text{indoor}} - T_{\text{outdoor}}) \\ &= (1.17 \text{ W/m} \cdot \text{°C})(66 \text{ m})[22 - (-11)]\text{°C} = \mathbf{2548 \text{ W}} \end{aligned}$$

Discussion This is the *design* or *peak* rate of heat transfer from below-grade section of the basement, and this is the value to be used when sizing the heating system. The actual heat loss from the basement will be much less than that most of the time.

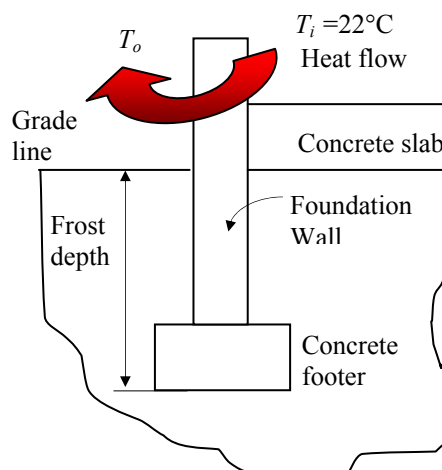

16-84 The vents of the crawl space of a house are kept closed, but air still infiltrates. The heat loss from the house to the crawl space and the crawl space temperature are to be determined for the cases of insulated and uninsulated walls, floor, and ceiling of the crawl space.

Assumptions 1 Steady operating conditions exist. 2 The thermal properties and heat transfer coefficients remain constant. 3 The atmospheric pressure is 1 atm.

Properties The indoor and outdoor design temperatures are given to be 22°C and -5°C, respectively, and the deep-down ground temperature is 10°C. The properties of air at -5°C and 1 atm are $\rho = 1.328 \text{ kg/m}^3$ and $c_p = 1.004 \text{ kJ/kg}\cdot^\circ\text{C}$ (Table A-11). The overall heat transfer coefficients (the U -values) for insulated and uninsulated crawl spaces are given in Table 16-15 to be

Application	U , $\text{W/m}^2\cdot^\circ\text{C}$	
	uninsulated	insulated*
Floor above crawl space	1.42	0.432
Ground of crawl space	0.437	0.437
Wall of crawl space	2.77	1.07

*An insulation R -value of $1.94 \text{ m}^2\cdot^\circ\text{C/W}$ is used on the floor, and $0.95 \text{ m}^2\cdot^\circ\text{C/W}$ on the walls.

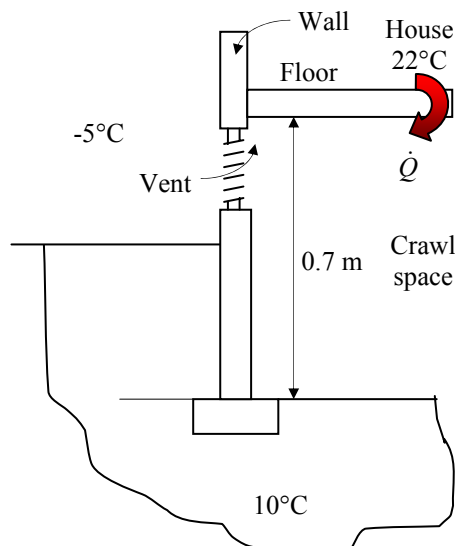

Analysis (a) The floor (ceiling), ground, and wall areas of the crawl space are

$$A_{\text{floor}} = A_{\text{ground}} = \text{Length} \times \text{Width} = (12 \text{ m})(20 \text{ m}) = 240 \text{ m}^2$$

$$A_{\text{wall}} = \text{Height} \times \text{Perimeter} = (0.7 \text{ m})[2 \times (12 + 20 \text{ m})] = 44.8 \text{ m}^2$$

The volume of the crawl space and the infiltration heat loss is

$$V_{\text{crawl}} = (\text{Height})(\text{Width})(\text{Length}) = (0.7 \text{ m})(12 \text{ m})(20 \text{ m}) = 168 \text{ m}^3$$

$$\begin{aligned} \dot{Q}_{\text{infiltration}} &= \rho \dot{V} c_p (T_{\text{ambient}} - T_{\text{crawl}}) = \rho (V_{\text{crawl}} \times ACH) c_p (T_{\text{ambient}} - T_{\text{crawl}}) \\ &= (1.328 \text{ kg/m}^3)(168 \text{ m}^3)(1.2/\text{h})(1004 \text{ J/kg}\cdot^\circ\text{C})(-5 - T_{\text{crawl}})^\circ\text{C} \\ &= 268,800(-5 - T_{\text{crawl}}) \text{ J/h} = 74.7(-5 - T_{\text{crawl}}) \text{ W} \quad (\text{since } 1 \text{ h} = 3600 \text{ s}) \end{aligned}$$

Noting that under steady conditions the net heat transfer to the crawl space is zero, the energy balance for the crawl space can be written as

$$\dot{Q}_{\text{floor}} + \dot{Q}_{\text{wall}} + \dot{Q}_{\text{ground}} + \dot{Q}_{\text{infiltration}} = 0$$

or

$$[UA(T_{\text{indoor}} - T_{\text{crawl}})]_{\text{floor}} + [UA(T_{\text{ambient}} - T_{\text{crawl}})]_{\text{wall}} + [UA(T_{\text{ground}} - T_{\text{crawl}})]_{\text{ground}} + \rho \dot{V} c_p (T_{\text{ambient}} - T_{\text{crawl}}) = 0$$

Using the U -values from the table above for the **insulated case** and substituting,

$$\begin{aligned} (0.432 \text{ W/m}^2\cdot^\circ\text{C})(240 \text{ m}^2)(22 - T_{\text{crawl}})^\circ\text{C} + (1.07 \text{ W/m}^2\cdot^\circ\text{C})(44.8 \text{ m}^2)(-5 - T_{\text{crawl}})^\circ\text{C} \\ + (0.437 \text{ W/m}^2\cdot^\circ\text{C})(240 \text{ m}^2)(10 - T_{\text{crawl}})^\circ\text{C} + 74.7(-5 - T_{\text{crawl}}) \text{ W} = 0 \end{aligned}$$

Solving for the equation above for the crawl space temperature gives $T_{\text{crawl}} = 1.3^\circ\text{C}$.

(b) Similarly, using the U -values from the table above for the **uninsulated case** and substituting,

$$\begin{aligned} (1.42 \text{ W/m}^2\cdot^\circ\text{C})(240 \text{ m}^2)(22 - T_{\text{crawl}})^\circ\text{C} + (2.77 \text{ W/m}^2\cdot^\circ\text{C})(44.8 \text{ m}^2)(-5 - T_{\text{crawl}})^\circ\text{C} \\ + (0.437 \text{ W/m}^2\cdot^\circ\text{C})(240 \text{ m}^2)(10 - T_{\text{crawl}})^\circ\text{C} + 74.7(-5 - T_{\text{crawl}}) \text{ W} = 0 \end{aligned}$$

Solving for the equation above for the crawl space temperature gives $T_{\text{crawl}} = 11.7^\circ\text{C}$.

16-85 The vents of the crawl space of a house are tightly sealed, and no air infiltrates. The heat loss from the house to the crawl space and the crawl space temperature are to be determined for the cases of insulated and uninsulated walls, floor, and ceiling of the crawl space.

Assumptions 1 Steady operating conditions exist. 2 The thermal properties and heat transfer coefficients remain constant. 3 The atmospheric pressure is 1 atm. 4 Air infiltration is negligible.

Properties The indoor and outdoor design temperatures are given to be 22°C and -5°C, respectively, and the deep-down ground temperature is 10°C. The properties of air at -5°C and 1 atm are $\rho = 1.328 \text{ kg/m}^3$ and $C_p = 1.004 \text{ kJ/kg}\cdot^\circ\text{C}$ (Table A-11). The overall heat transfer coefficients (the U -values) for insulated and uninsulated crawl spaces are given in Table 16-15 to be

Application	$U, \text{W/m}^2\cdot^\circ\text{C}$	
	uninsulated	insulated*
Floor above crawl space	1.42	0.432
Ground of crawl space	0.437	0.437
Wall of crawl space	2.77	1.07

*An insulation R -value of $1.94 \text{ m}^2\cdot^\circ\text{C/W}$ is used on the floor, and $0.95 \text{ m}^2\cdot^\circ\text{C/W}$ on the walls.

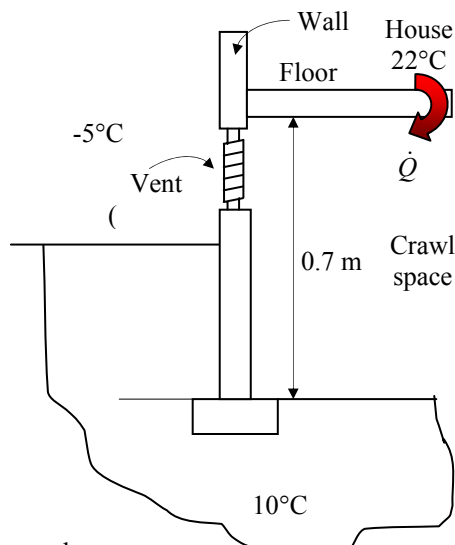

Analysis (a) The floor (ceiling), ground, and wall areas of the crawl space are

$$A_{\text{floor}} = A_{\text{ground}} = \text{Length} \times \text{Width} = (12 \text{ m})(20 \text{ m}) = 240 \text{ m}^2$$

$$A_{\text{wall}} = \text{Height} \times \text{Perimeter} = (0.7 \text{ m})[2 \times (12 + 20) \text{ m}] = 44.8 \text{ m}^2$$

Noting that under steady conditions the net heat transfer to the crawl space is zero, the energy balance for the crawl space can be written as

$$\dot{Q}_{\text{floor}} + \dot{Q}_{\text{wall}} + \dot{Q}_{\text{ground}} = 0$$

or

$$[UA(T_{\text{indoor}} - T_{\text{crawl}})]_{\text{floor}} + [UA(T_{\text{ambient}} - T_{\text{crawl}})]_{\text{wall}} + [UA(T_{\text{ground}} - T_{\text{crawl}})]_{\text{ground}} = 0$$

Using the U -values from the table above for the **insulated case** and substituting,

$$(0.432 \text{ W/m}^2 \cdot ^\circ\text{C})(240 \text{ m}^2)(22 - T_{\text{crawl}})^\circ\text{C} + (1.07 \text{ W/m}^2 \cdot ^\circ\text{C})(44.8 \text{ m}^2)(-5 - T_{\text{crawl}})^\circ\text{C} \\ + (0.437 \text{ W/m}^2 \cdot ^\circ\text{C})(240 \text{ m}^2)(10 - T_{\text{crawl}})^\circ\text{C} = 0$$

Solving for the equation above for the crawl space temperature gives $T_{\text{crawl}} = 6.5^\circ\text{C}$.

(b) Similarly, using the U -values from the table above for the **uninsulated case** and substituting,

$$(1.42 \text{ W/m}^2 \cdot ^\circ\text{C})(240 \text{ m}^2)(22 - T_{\text{crawl}})^\circ\text{C} + (2.77 \text{ W/m}^2 \cdot ^\circ\text{C})(44.8 \text{ m}^2)(-5 - T_{\text{crawl}})^\circ\text{C} \\ + (0.437 \text{ W/m}^2 \cdot ^\circ\text{C})(240 \text{ m}^2)(10 - T_{\text{crawl}})^\circ\text{C} = 0$$

Solving for the equation above for the crawl space temperature gives $T_{\text{crawl}} = 13.9^\circ\text{C}$.

Heat Transfer through Windows

16-86C Windows are considered in three regions when analyzing heat transfer through them because the structure and properties of the frame are quite different than those of the glazing. As a result, heat transfer through the frame and the edge section of the glazing adjacent to the frame is two-dimensional. Even in the absence of solar radiation and air infiltration, heat transfer through the windows is more complicated than it appears to be. Therefore, it is customary to consider the windows in three regions when analyzing heat transfer through them: (1) the *center-of-glass*, (2) the *edge-of-glass*, and (3) the *frame* regions. When the heat transfer coefficient for all three regions are known, the overall U-value of the window is determined from

$$U_{\text{window}} = (U_{\text{center}}A_{\text{center}} + U_{\text{edge}}A_{\text{edge}} + U_{\text{frame}}A_{\text{frame}}) / A_{\text{window}}$$

where A_{window} is the window area, and A_{center} , A_{edge} , and A_{frame} are the areas of the center, edge, and frame sections of the window, respectively, and U_{center} , U_{edge} , and U_{frame} are the heat transfer coefficients for the center, edge, and frame sections of the window.

16-87C Of the three similar double pane windows with air gap widths of 5, 10, and 20 mm, the U-factor and thus the rate of heat transfer through the window will be a minimum for the window with 10-mm air gap, as can be seen from Fig. 16-44.

16-88C In an ordinary double pane window, about half of the heat transfer is by radiation. A practical way of reducing the radiation component of heat transfer is to reduce the emissivity of glass surfaces by coating them with low-emissivity (or “low-e”) material.

16-89C When a thin polyester film is used to divide the 20-mm wide air of a double pane window space into two 10-mm wide layers, both (a) convection and (b) radiation heat transfer through the window will be reduced.

16-90C When a double pane window whose air space is flashed and filled with argon gas, (a) convection heat transfer will be reduced but (b) radiation heat transfer through the window will remain the same.

16-91C The heat transfer rate through the glazing of a double pane window is higher at the edge section than it is at the center section because of the two-dimensional effects due to heat transfer through the frame.

16-92C The U-factors of windows with aluminum frames will be highest because of the higher conductivity of aluminum. The U-factors of wood and vinyl frames are comparable in magnitude.

16-93 The U-factor for the center-of-glass section of a double pane window is to be determined.

Assumptions 1 Steady operating conditions exist. 2 Heat transfer through the window is one-dimensional. 3 The thermal resistance of glass sheets is negligible.

Properties The emissivity of clear glass is given to be 0.84. The values of h_i and h_o for winter design conditions are $h_i = 8.29 \text{ W/m}^2 \cdot ^\circ\text{C}$ and $h_o = 34.0 \text{ W/m}^2 \cdot ^\circ\text{C}$ (Table 16-11).

Analysis Disregarding the thermal resistance of glass sheets, which are small, the U-factor for the center region of a double pane window is determined from

$$\frac{1}{U_{\text{center}}} \cong \frac{1}{h_i} + \frac{1}{h_{\text{space}}} + \frac{1}{h_o}$$

where h_i , h_{space} , and h_o are the heat transfer coefficients at the inner surface of window, the air space between the glass layers, and the outer surface of the window, respectively. The effective emissivity of the air space of the double pane window is

$$\varepsilon_{\text{effective}} = \frac{1}{1/\varepsilon_1 + 1/\varepsilon_2 - 1} = \frac{1}{1/0.84 + 1/0.84 - 1} = 0.72$$

For this value of emissivity and an average air space temperature of 10°C with a temperature difference across the air space to be 15°C , we read $h_{\text{space}} = 5.7 \text{ W/m}^2 \cdot ^\circ\text{C}$ from Table 9-3 for 13-mm thick air space. Therefore,

$$\frac{1}{U_{\text{center}}} = \frac{1}{8.29} + \frac{1}{5.7} + \frac{1}{34.0} \longrightarrow U_{\text{center}} = \mathbf{3.07 \text{ W/m}^2 \cdot ^\circ\text{C}}$$

Discussion The overall U-factor of the window will be higher because of the edge effects of the frame.

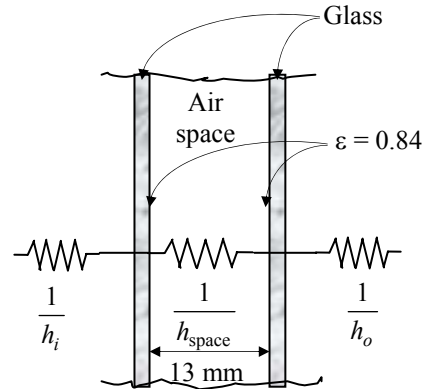

16-94 The rate of heat loss through an double-door wood framed window and the inner surface temperature are to be determined for the cases of single pane, double pane, and low-e triple pane windows.

Assumptions 1 Steady operating conditions exist. 2 Heat transfer through the window is one-dimensional. 3 Thermal properties of the windows and the heat transfer coefficients are constant. 4 Infiltration heat losses are not considered.

Properties The U-factors of the windows are given in Table 16-19.

Analysis The rate of heat transfer through the window can be determined from

$$\dot{Q}_{\text{window}} = U_{\text{overall}} A_{\text{window}} (T_i - T_o)$$

where T_i and T_o are the indoor and outdoor air temperatures, respectively, U_{overall} is the U-factor (the overall heat transfer coefficient) of the window, and A_{window} is the window area which is determined to be

$$A_{\text{window}} = \text{Height} \times \text{Width} = (1.2 \text{ m})(1.8 \text{ m}) = 2.16 \text{ m}^2$$

The U-factors for the three cases can be determined directly from Table 9-6 to be 5.57, 2.86, and 1.46 W/m²·°C, respectively. Also, the inner surface temperature of the window glass can be determined from Newton's law,

$$\dot{Q}_{\text{window}} = h_i A_{\text{window}} (T_i - T_{\text{glass}}) \longrightarrow T_{\text{glass}} = T_i - \frac{\dot{Q}_{\text{window}}}{h_i A_{\text{window}}}$$

where h_i is the heat transfer coefficient on the inner surface of the window which is determined from Table 9-5 to be $h_i = 8.3 \text{ W/m}^2 \cdot \text{°C}$. Then the rate of heat loss and the interior glass temperature for each case are determined as follows:

(a) Single glazing:

$$\dot{Q}_{\text{window}} = (5.57 \text{ W/m}^2 \cdot \text{°C})(2.16 \text{ m}^2)[20 - (-8) \text{°C}] = \mathbf{337 \text{ W}}$$

$$T_{\text{glass}} = T_i - \frac{\dot{Q}_{\text{window}}}{h_i A_{\text{window}}} = 20 \text{°C} - \frac{337 \text{ W}}{(8.29 \text{ W/m}^2 \cdot \text{°C})(2.16 \text{ m}^2)} = \mathbf{1.2 \text{°C}}$$

(b) Double glazing (13 mm air space):

$$\dot{Q}_{\text{window}} = (2.86 \text{ W/m}^2 \cdot \text{°C})(2.16 \text{ m}^2)[20 - (-8) \text{°C}] = \mathbf{173 \text{ W}}$$

$$T_{\text{glass}} = T_i - \frac{\dot{Q}_{\text{window}}}{h_i A_{\text{window}}} = 20 \text{°C} - \frac{173 \text{ W}}{(8.29 \text{ W/m}^2 \cdot \text{°C})(2.16 \text{ m}^2)} = \mathbf{10.3 \text{°C}}$$

(c) Triple glazing (13 mm air space, low-e coated):

$$\dot{Q}_{\text{window}} = (1.46 \text{ W/m}^2 \cdot \text{°C})(2.16 \text{ m}^2)[20 - (-8) \text{°C}] = \mathbf{88.3 \text{ W}}$$

$$T_{\text{glass}} = T_i - \frac{\dot{Q}_{\text{window}}}{h_i A_{\text{window}}} = 20 - \frac{88.3 \text{ W}}{(8.3 \text{ W/m}^2 \cdot \text{°C})(2.16 \text{ m}^2)} = \mathbf{15.1 \text{°C}}$$

Discussion Note that heat loss through the window will be reduced by 49 percent in the case of double glazing and by 74 percent in the case of triple glazing relative to the single glazing case. Also, in the case of single glazing, the low inner glass surface temperature will cause considerable discomfort in the occupants because of the excessive heat loss from the body by radiation. It is raised from 1.2°C to 10.3°C in the case of double glazing and to 15.1°C in the case of triple glazing.

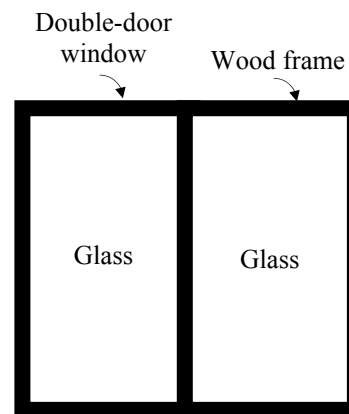

16-95 The overall U-factor for a double-door type window is to be determined, and the result is to be compared to the value listed in Table 16-19.

Assumptions 1 Steady operating conditions exist. 2 Heat transfer through the window is one-dimensional.

Properties The U-factors for the various sections of windows are given in Tables 16-11 and 16-19.

Analysis The areas of the window, the glazing, and the frame are

$$A_{\text{window}} = \text{Height} \times \text{Width} = (2 \text{ m})(2.4 \text{ m}) = 4.80 \text{ m}^2$$

$$A_{\text{glazing}} = 2 \times \text{Height} \times \text{Width} = 2(1.92 \text{ m})(1.14 \text{ m}) = 4.38 \text{ m}^2$$

$$A_{\text{frame}} = A_{\text{window}} - A_{\text{glazing}} = 4.80 - 4.38 = 0.42 \text{ m}^2$$

The edge-of-glass region consists of a 6.5-cm wide band around the perimeter of the glazings, and the areas of the center and edge sections of the glazing are determined to be

$$A_{\text{center}} = 2(\text{Height} \times \text{Width}) = 2(1.92 - 0.13 \text{ m})(1.14 - 0.13 \text{ m}) = 3.62 \text{ m}^2$$

$$A_{\text{edge}} = A_{\text{glazing}} - A_{\text{center}} = 4.38 - 3.62 = 0.76 \text{ m}^2$$

The U-factor for the frame section is determined from Table 9-4 to be $U_{\text{frame}} = 2.8 \text{ W/m}^2 \cdot ^\circ\text{C}$. The U-factor for the center and edge sections are determined from Table 9-6 to be $U_{\text{center}} = 2.78 \text{ W/m}^2 \cdot ^\circ\text{C}$ and $U_{\text{edge}} = 3.40 \text{ W/m}^2 \cdot ^\circ\text{C}$. Then the overall U-factor of the entire window becomes

$$\begin{aligned} U_{\text{window}} &= (U_{\text{center}}A_{\text{center}} + U_{\text{edge}}A_{\text{edge}} + U_{\text{frame}}A_{\text{frame}}) / A_{\text{window}} \\ &= (2.78 \times 3.62 + 3.40 \times 0.76 + 2.8 \times 0.42) / 4.80 \\ &= \mathbf{2.88 \text{ W/m}^2 \cdot ^\circ\text{C}} \end{aligned}$$

Discussion The overall U-factor listed in Table 9-6 for the specified type of window is $2.86 \text{ W/m}^2 \cdot ^\circ\text{C}$, which is sufficiently close to the value obtained above.

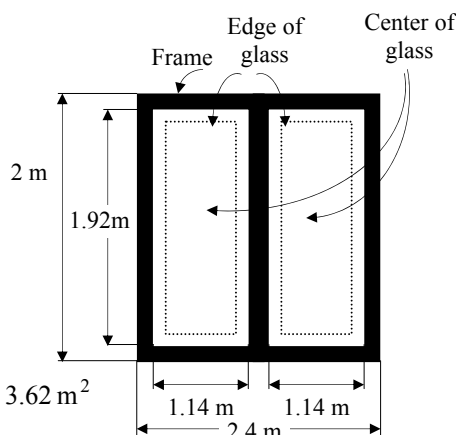

16-96 The windows of a house in Atlanta are of double door type with wood frames and metal spacers. The average rate of heat loss through the windows in winter is to be determined.

Assumptions 1 Steady operating conditions exist. 2 Heat transfer through the window is one-dimensional. 3 Thermal properties of the windows and the heat transfer coefficients are constant. 4 Infiltration heat losses are not considered.

Properties The U-factor of the window is given in Table 9-6 to be $2.13 \text{ W/m}^2 \cdot ^\circ\text{C}$.

Analysis The rate of heat transfer through the window can be determined from

$$\dot{Q}_{\text{window, avg}} = U_{\text{overall}} A_{\text{window}} (T_i - T_{o, \text{avg}})$$

where T_i and T_o are the indoor and outdoor air temperatures, respectively, U_{overall} is the U-factor (the overall heat transfer coefficient) of the window, and A_{window} is the window area. Substituting,

$$\dot{Q}_{\text{window, avg}} = (2.13 \text{ W/m}^2 \cdot ^\circ\text{C})(14 \text{ m}^2)(22 - 11.3)^\circ\text{C} = \mathbf{319 \text{ W}}$$

Discussion This is the “average” rate of heat transfer through the window in winter in the absence of any infiltration.

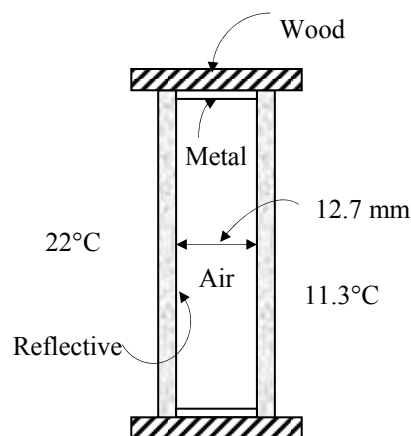

16-97E The R -value of the common double door windows that are double pane with 1/4-in of air space and have aluminum frames is to be compared to the R -value of R -13 wall. It is also to be determined if more heat is transferred through the windows or the walls.

Assumptions 1 Steady operating conditions exist. 2 Heat transfer through the window is one-dimensional. 3 Thermal properties of the windows and the heat transfer coefficients are constant. 4 Infiltration heat losses are not considered.

Properties The U -factor of the window is given in Table 16-19 to be $4.66 \times 0.176 = 0.801$ Btu/h.ft².°F.

Analysis The R -value of the windows is simply the inverse of its U -factor, and is determined to be

$$R_{\text{window}} = \frac{1}{U} = \frac{1}{0.801 \text{ Btu/h} \cdot \text{ft}^2 \cdot ^\circ\text{F}} = 1.25 \text{ h} \cdot \text{ft}^2 \cdot ^\circ\text{F}/\text{Btu}$$

which is less than 13. Therefore, the R -value of a double pane window is **much less** than the R -value of an R -13 wall.

Now consider a 1-ft² section of a wall. The solid wall and the window areas of this section are $A_{\text{wall}} = 0.8$ ft² and $A_{\text{window}} = 0.2$ ft². Then the rates of heat transfer through the two sections are determined to be

$$\dot{Q}_{\text{wall}} = U_{\text{wall}} A_{\text{wall}} (T_i - T_o) = A_{\text{wall}} \frac{T_i - T_o}{R - \text{value, wall}} = (0.8 \text{ ft}^2) \frac{\Delta T (^\circ\text{F})}{(13 \text{ h} \cdot \text{ft}^2 \cdot ^\circ\text{F}/\text{Btu})} = 0.0615 \Delta T \text{ Btu/h}$$

$$\dot{Q}_{\text{window}} = U_{\text{window}} A_{\text{window}} (T_i - T_o) = A_{\text{window}} \frac{T_i - T_o}{R - \text{value}} = (0.2 \text{ ft}^2) \frac{\Delta T (^\circ\text{F})}{(1.25 \text{ h} \cdot \text{ft}^2 \cdot ^\circ\text{F}/\text{Btu})} = 0.160 \Delta T \text{ Btu/h}$$

Therefore, the rate of heat transfer through a double pane window is **much more** than the rate of heat transfer through an R -13 wall.

Discussion The ratio of heat transfer through the wall and through the window is

$$\frac{\dot{Q}_{\text{window}}}{\dot{Q}_{\text{wall}}} = \frac{0.160 \text{ Btu/h}}{0.0615 \text{ Btu/h}} = 2.60$$

Therefore, 2.6 times more heat is lost through the windows than through the walls although the windows occupy only 20% of the wall area.

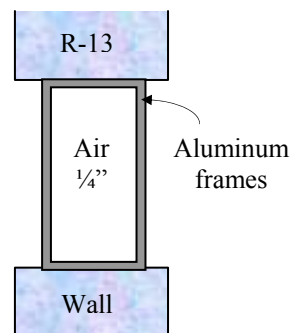

16-98 The overall U-factor of a window is given to be $U = 2.76 \text{ W/m}^2 \cdot ^\circ\text{C}$ for 12 km/h winds outside. The new U-factor when the wind velocity outside is doubled is to be determined.

Assumptions Thermal properties of the windows and the heat transfer coefficients are constant.

Properties The heat transfer coefficients at the outer surface of the window are $h_o = 22.7 \text{ W/m}^2 \cdot ^\circ\text{C}$ for 12 km/h winds, and $h_o = 34.0 \text{ W/m}^2 \cdot ^\circ\text{C}$ for 24 km/h winds (Table 16-11).

Analysis The corresponding convection resistances for the outer surfaces of the window are

$$R_{o,12 \text{ km/h}} = \frac{1}{h_{o,12 \text{ km/h}}} = \frac{1}{22.7 \text{ W/m}^2 \cdot ^\circ\text{C}} = 0.044 \text{ m}^2 \cdot ^\circ\text{C/W}$$

$$R_{o,24 \text{ km/h}} = \frac{1}{h_{o,24 \text{ km/h}}} = \frac{1}{34.0 \text{ W/m}^2 \cdot ^\circ\text{C}} = 0.029 \text{ m}^2 \cdot ^\circ\text{C/W}$$

Also, the R-value of the window at 12 km/h winds is

$$R_{\text{window},12 \text{ km/h}} = \frac{1}{U_{\text{window},12 \text{ km/h}}} = \frac{1}{2.76 \text{ W/m}^2 \cdot ^\circ\text{C}} = 0.362 \text{ m}^2 \cdot ^\circ\text{C/W}$$

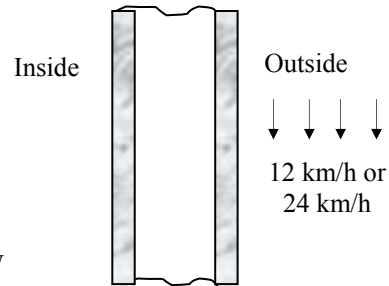

Noting that all thermal resistances are in series, the thermal resistance of the window for 24 km/h winds is determined by replacing the convection resistance for 12 km/h winds by the one for 24 km/h:

$$R_{\text{window},24 \text{ km/h}} = R_{\text{window},12 \text{ km/h}} - R_{o,12 \text{ km/h}} + R_{o,24 \text{ km/h}} = 0.362 - 0.044 + 0.029 = 0.347 \text{ m}^2 \cdot ^\circ\text{C/W}$$

Then the U-factor for the case of 24 km/h winds becomes

$$U_{\text{window},24 \text{ km/h}} = \frac{1}{R_{\text{window},24 \text{ km/h}}} = \frac{1}{0.347 \text{ m}^2 \cdot ^\circ\text{C/W}} = \mathbf{2.88 \text{ W/m}^2 \cdot ^\circ\text{C}}$$

Discussion Note that doubling of the wind velocity increases the U-factor only slightly (about 4%) from 2.76 to 2.88 $\text{W/m}^2 \cdot ^\circ\text{C}$.

16-99 The existing wood framed single pane windows of an older house in Wichita are to be replaced by double-door type vinyl framed double pane windows with an air space of 6.4 mm. The amount of money the new windows will save the home owner per month is to be determined.

Assumptions 1 Steady operating conditions exist. 2 Heat transfer through the window is one-dimensional. 3 Thermal properties of the windows and the heat transfer coefficients are constant. 4 Infiltration heat losses are not considered.

Properties The U-factors of the windows are $5.57 \text{ W/m}^2 \cdot ^\circ\text{C}$ for the old single pane windows, and $3.20 \text{ W/m}^2 \cdot ^\circ\text{C}$ for the new double pane windows (Table 9-6).

Analysis The rate of heat transfer through the window can be determined from

$$\dot{Q}_{\text{window}} = U_{\text{overall}} A_{\text{window}} (T_i - T_o)$$

where T_i and T_o are the indoor and outdoor air temperatures, respectively, U_{overall} is the U-factor (the overall heat transfer coefficient) of the window, and A_{window} is the window area. Noting that the heaters will turn on only when the outdoor temperature drops below 18°C , the rates of heat transfer due to electric heating for the old and new windows are determined to be

$$\dot{Q}_{\text{window, old}} = (5.57 \text{ W/m}^2 \cdot ^\circ\text{C})(17 \text{ m}^2)(18 - 7.1)^\circ\text{C} = 1032 \text{ W}$$

$$\dot{Q}_{\text{window, new}} = (3.20 \text{ W/m}^2 \cdot ^\circ\text{C})(17 \text{ m}^2)(18 - 7.1)^\circ\text{C} = 593 \text{ W}$$

$$\dot{Q}_{\text{saved}} = \dot{Q}_{\text{window, old}} - \dot{Q}_{\text{window, new}} = 1032 - 593 = 439 \text{ W}$$

Then the electrical energy and cost savings per month becomes

$$\text{Energy savings} = \dot{Q}_{\text{saved}} \Delta t = (0.439 \text{ kW})(30 \times 24 \text{ h/month}) = 316 \text{ kWh/month}$$

$$\text{Cost savings} = (\text{Energy savings})(\text{Unit cost of energy}) = (316 \text{ kWh/month})(\$0.085/\text{kWh}) = \mathbf{\$26.9/\text{month}}$$

Discussion We would obtain the same result if we used the actual indoor temperature (probably 22°C) for T_i instead of the balance point temperature of 18°C .

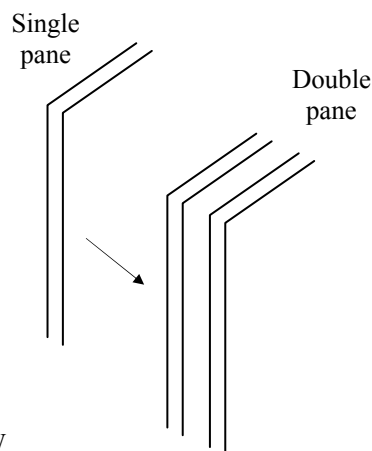

Solar Heat Gain through Windows

16-100C (a) The spectral distribution of solar radiation beyond the earth's atmosphere resembles the energy emitted by a black body at 5982°C, with about 39 percent in the visible region (0.4 to 0.7 μm), and the 52 percent in the near infrared region (0.7 to 3.5 μm). (b) At a solar altitude of 41.8°, the total energy of direct solar radiation incident at sea level on a clear day consists of about 3 percent ultraviolet, 38 percent visible, and 59 percent infrared radiation.

16-101C A window that transmits visible part of the spectrum while absorbing the infrared portion is ideally suited for minimizing the air-conditioning load since such windows provide maximum daylighting and minimum solar heat gain. The ordinary window glass approximates this behavior remarkably well.

16-102C The **solar heat gain coefficient (SHGC)** is defined as the fraction of incident solar radiation that enters through the glazing. The solar heat gain of a glazing relative to the solar heat gain of a reference glazing, typically that of a standard 3 mm (1/8 in) thick double-strength clear window glass sheet whose SHGC is 0.87, is called the **shading coefficient**. They are related to each other by

$$SC = \frac{\text{Solar heat gain of product}}{\text{Solar heat gain of reference glazing}} = \frac{SHGC}{SHGC_{ref}} = \frac{SHGC}{0.87} = 1.15 \times SHGC$$

For single pane clear glass window, SHGC = 0.87 and SC = 1.0.

16-103C The SC (shading coefficient) of a device represents the solar heat gain relative to the solar heat gain of a reference glazing, typically that of a standard 3 mm (1/8 in) thick double-strength clear window glass sheet whose SHGC is 0.87. The shading coefficient of a 3-mm thick *clear glass* is SC = 1.0 whereas SC = 0.88 for 3-mm thick *heat absorbing glass*.

16-104C A device that blocks solar radiation and thus reduces the solar heat gain is called a shading device. External shading devices are more effective in reducing the solar heat gain since they intercept sun's rays before they reach the glazing. The solar heat gain through a window can be reduced by as much as 80 percent by exterior shading. *Light colored* shading devices maximize the back reflection and thus minimize the solar gain. *Dark colored* shades, on the other hand, minimize the back reflection and thus maximize the solar heat gain.

16-105C A low-e coating on the inner surface of a window glass reduces both the (a) heat loss in winter and (b) heat gain in summer. This is because the radiation heat transfer to or from the window is proportional to the emissivity of the inner surface of the window. In winter, the window is colder and thus radiation heat loss from the room to the window is low. In summer, the window is hotter and the radiation transfer from the window to the room is low.

16-106C Glasses coated with reflective films on the outer surface of a window glass reduces solar heat both in summer and in winter.

16-107 The net annual cost savings due to installing reflective coating on the West windows of a building and the simple payback period are to be determined.

Assumptions 1 The calculations given below are for an average year. 2 The unit costs of electricity and natural gas remain constant.

Analysis Using the daily averages for each month and noting the number of days of each month, the total solar heat flux incident on the glazing during summer and winter months are determined to be

$$\begin{aligned} Q_{\text{solar, summer}} &= 4.24 \times 30 + 4.16 \times 31 + 3.93 \times 31 + 3.48 \times 30 \\ &= 482 \text{ kWh/year} \end{aligned}$$

$$\begin{aligned} Q_{\text{solar, winter}} &= 2.94 \times 31 + 2.33 \times 30 + 2.07 \times 31 + 2.35 \times 31 + 3.03 \times 28 + 3.62 \times 31 + 4.00 \times 30 \\ &= 615 \text{ kWh/year} \end{aligned}$$

Then the decrease in the annual cooling load and the increase in the annual heating load due to reflective film become

$$\begin{aligned} \text{Cooling load decrease} &= Q_{\text{solar, summer}} A_{\text{glazing}} (\text{SHGC}_{\text{without film}} - \text{SHGC}_{\text{with film}}) \\ &= (482 \text{ kWh/year})(60 \text{ m}^2)(0.766 - 0.261) \\ &= 14,605 \text{ kWh/year} \end{aligned}$$

$$\begin{aligned} \text{Heating load increase} &= Q_{\text{solar, winter}} A_{\text{glazing}} (\text{SHGC}_{\text{without film}} - \text{SHGC}_{\text{with film}}) \\ &= (615 \text{ kWh/year})(60 \text{ m}^2)(0.766 - 0.261) \\ &= 18,635 \text{ kWh/year} = 635.8 \text{ therms/year} \end{aligned}$$

since 1 therm = 29.31 kWh. The corresponding decrease in cooling costs and increase in heating costs are

$$\begin{aligned} \text{Decrease in cooling costs} &= (\text{Cooling load decrease})(\text{Unit cost of electricity})/\text{COP} \\ &= (14,605 \text{ kWh/year})(\$0.09/\text{kWh})/3.2 = \$411/\text{year} \end{aligned}$$

$$\begin{aligned} \text{Increase in heating costs} &= (\text{Heating load increase})(\text{Unit cost of fuel})/\text{Efficiency} \\ &= (635.8 \text{ therms/year})(\$0.45/\text{therm})/0.80 = \$358/\text{year} \end{aligned}$$

Then the net annual cost savings due to reflective films become

$$\text{Cost Savings} = \text{Decrease in cooling costs} - \text{Increase in heating costs} = \$411 - 358 = \mathbf{\$53/\text{year}}$$

The implementation cost of installing films is

$$\text{Implementation Cost} = (\$20/\text{m}^2)(60 \text{ m}^2) = \$1200$$

This gives a simple payback period of

$$\text{Simple payback period} = \frac{\text{Implementation cost}}{\text{Annual cost savings}} = \frac{\$1200}{\$53/\text{year}} = \mathbf{23 \text{ years}}$$

Discussion The reflective films will pay for themselves in this case in about 23 years, which is unacceptable to most manufacturers since they are not usually interested in any energy conservation measure which does not pay for itself within 3 years.

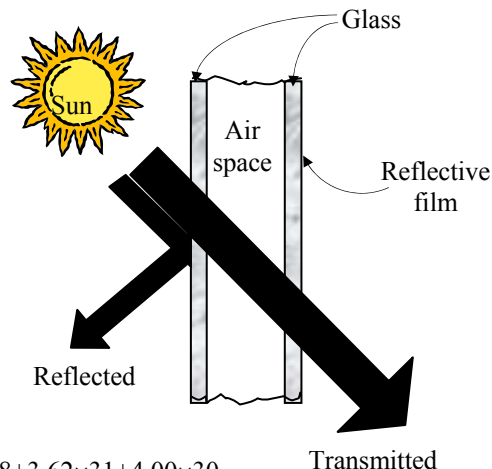

16-108 A house located at 40° N latitude has ordinary double pane windows. The total solar heat gain of the house at 9:00, 12:00, and 15:00 solar time in July and the total amount of solar heat gain per day for an average day in January are to be determined.

Assumptions The calculations are performed for an average day in a given month.

Properties The shading coefficient of a double pane window with 6-mm thick glasses is $SC = 0.82$ (Table 16-21). The incident radiation at different windows at different times are given as (Table 16-20)

Month	Time	Solar radiation incident on the surface, W/m^2			
		North	East	South	West
July	9:00	117	701	190	114
July	12:00	138	149	395	149
July	15:00	117	114	190	701
January	Daily total	446	1863	5897	1863

Analysis The solar heat gain coefficient (SHGC) of the windows is determined from Eq. 16-40 to be

$$SHGC = 0.87 \times SC = 0.87 \times 0.82 = 0.7134$$

The rate of solar heat gain is determined from

$$\dot{Q}_{\text{solar gain}} = SHGC \times A_{\text{glazing}} \times \dot{q}_{\text{solar, incident}} = 0.7134 \times A_{\text{glazing}} \times \dot{q}_{\text{solar, incident}}$$

Then the rates of heat gain at the 4 walls at 3 different times in July become

North wall:

$$\dot{Q}_{\text{solar gain, 9:00}} = 0.7134 \times (4 \text{ m}^2) \times (117 \text{ W/m}^2) = \mathbf{334 \text{ W}}$$

$$\dot{Q}_{\text{solar gain, 12:00}} = 0.7134 \times (4 \text{ m}^2) \times (138 \text{ W/m}^2) = \mathbf{394 \text{ W}}$$

$$\dot{Q}_{\text{solar gain, 15:00}} = 0.7134 \times (4 \text{ m}^2) \times (117 \text{ W/m}^2) = \mathbf{334 \text{ W}}$$

East wall:

$$\dot{Q}_{\text{solar gain, 9:00}} = 0.7134 \times (6 \text{ m}^2) \times (701 \text{ W/m}^2) = \mathbf{3001 \text{ W}}$$

$$\dot{Q}_{\text{solar gain, 12:00}} = 0.7134 \times (6 \text{ m}^2) \times (149 \text{ W/m}^2) = \mathbf{638 \text{ W}}$$

$$\dot{Q}_{\text{solar gain, 15:00}} = 0.7134 \times (6 \text{ m}^2) \times (114 \text{ W/m}^2) = \mathbf{488 \text{ W}}$$

South wall:

$$\dot{Q}_{\text{solar gain, 9:00}} = 0.7134 \times (8 \text{ m}^2) \times (190 \text{ W/m}^2) = \mathbf{1084 \text{ W}}$$

$$\dot{Q}_{\text{solar gain, 12:00}} = 0.7134 \times (8 \text{ m}^2) \times (395 \text{ W/m}^2) = \mathbf{2254 \text{ W}}$$

$$\dot{Q}_{\text{solar gain, 15:00}} = 0.7134 \times (8 \text{ m}^2) \times (190 \text{ W/m}^2) = \mathbf{1084 \text{ W}}$$

West wall:

$$\dot{Q}_{\text{solar gain, 9:00}} = 0.7134 \times (6 \text{ m}^2) \times (114 \text{ W/m}^2) = \mathbf{488 \text{ W}}$$

$$\dot{Q}_{\text{solar gain, 12:00}} = 0.7134 \times (6 \text{ m}^2) \times (149 \text{ W/m}^2) = \mathbf{638 \text{ W}}$$

$$\dot{Q}_{\text{solar gain, 15:00}} = 0.7134 \times (6 \text{ m}^2) \times (701 \text{ W/m}^2) = \mathbf{3001 \text{ W}}$$

Similarly, the solar heat gain of the house through all of the windows in January is determined to be

January:

$$\dot{Q}_{\text{solar gain, North}} = 0.7134 \times (4 \text{ m}^2) \times (446 \text{ Wh/m}^2 \cdot \text{day}) = 1273 \text{ Wh/day}$$

$$\dot{Q}_{\text{solar gain, East}} = 0.7134 \times (6 \text{ m}^2) \times (1863 \text{ Wh/m}^2 \cdot \text{day}) = 7974 \text{ Wh/day}$$

$$\dot{Q}_{\text{solar gain, South}} = 0.7134 \times (8 \text{ m}^2) \times (5897 \text{ Wh/m}^2 \cdot \text{day}) = 33,655 \text{ Wh/day}$$

$$\dot{Q}_{\text{solar gain, West}} = 0.7134 \times (6 \text{ m}^2) \times (1863 \text{ Wh/m}^2 \cdot \text{day}) = 7974 \text{ Wh/day}$$

Therefore, for an average day in January,

$$\dot{Q}_{\text{solar gain per day}} = 1273 + 7974 + 33,655 + 7974 = 58,876 \text{ Wh/day} \cong \mathbf{58.9 \text{ kWh/day}}$$

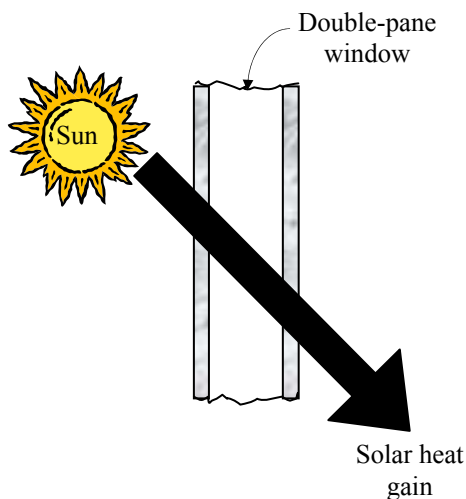

16-109 A house located at 40° N latitude has gray-tinted double pane windows. The total solar heat gain of the house at 9:00, 12:00, and 15:00 solar time in July and the total amount of solar heat gain per day for an average day in January are to be determined.

Assumptions The calculations are performed for an average day in a given month.

Properties The shading coefficient of a gray-tinted double pane window with 6-mm thick glasses is $SC = 0.58$ (Table 16-21). The incident radiation at different windows at different times are given as (Table 16-20)

Month	Time	Solar radiation incident on the surface, W/m^2			
		North	East	South	West
July	9:00	117	701	190	114
July	12:00	138	149	395	149
July	15:00	117	114	190	701
January	Daily total	446	1863	5897	1863

Analysis The solar heat gain coefficient (SHGC) of the windows is determined from Eq.16-40 to be

$$SHGC = 0.87 \times SC = 0.87 \times 0.58 = 0.5046$$

The rate of solar heat gain is determined from

$$\dot{Q}_{\text{solar gain}} = SHGC \times A_{\text{glazing}} \times \dot{q}_{\text{solar, incident}} = 0.5046 \times A_{\text{glazing}} \times \dot{q}_{\text{solar, incident}}$$

Then the rates of heat gain at the 4 walls at 3 different times in July become

North wall:

$$\dot{Q}_{\text{solar gain, 9:00}} = 0.5046 \times (4 \text{ m}^2) \times (117 \text{ W/m}^2) = \mathbf{236 \text{ W}}$$

$$\dot{Q}_{\text{solar gain, 12:00}} = 0.5046 \times (4 \text{ m}^2) \times (138 \text{ W/m}^2) = \mathbf{279 \text{ W}}$$

$$\dot{Q}_{\text{solar gain, 15:00}} = 0.5046 \times (4 \text{ m}^2) \times (117 \text{ W/m}^2) = \mathbf{236 \text{ W}}$$

East wall:

$$\dot{Q}_{\text{solar gain, 9:00}} = 0.5046 \times (6 \text{ m}^2) \times (701 \text{ W/m}^2) = \mathbf{2122 \text{ W}}$$

$$\dot{Q}_{\text{solar gain, 12:00}} = 0.5046 \times (6 \text{ m}^2) \times (149 \text{ W/m}^2) = \mathbf{451 \text{ W}}$$

$$\dot{Q}_{\text{solar gain, 15:00}} = 0.5046 \times (6 \text{ m}^2) \times (114 \text{ W/m}^2) = \mathbf{345 \text{ W}}$$

South wall:

$$\dot{Q}_{\text{solar gain, 9:00}} = 0.5046 \times (8 \text{ m}^2) \times (190 \text{ W/m}^2) = \mathbf{767 \text{ W}}$$

$$\dot{Q}_{\text{solar gain, 12:00}} = 0.5046 \times (8 \text{ m}^2) \times (395 \text{ W/m}^2) = \mathbf{1595 \text{ W}}$$

$$\dot{Q}_{\text{solar gain, 15:00}} = 0.5046 \times (8 \text{ m}^2) \times (190 \text{ W/m}^2) = \mathbf{767 \text{ W}}$$

West wall:

$$\dot{Q}_{\text{solar gain, 9:00}} = 0.5046 \times (6 \text{ m}^2) \times (114 \text{ W/m}^2) = \mathbf{345 \text{ W}}$$

$$\dot{Q}_{\text{solar gain, 12:00}} = 0.5046 \times (6 \text{ m}^2) \times (149 \text{ W/m}^2) = \mathbf{451 \text{ W}}$$

$$\dot{Q}_{\text{solar gain, 15:00}} = 0.5046 \times (6 \text{ m}^2) \times (701 \text{ W/m}^2) = \mathbf{2122 \text{ W}}$$

Similarly, the solar heat gain of the house through all of the windows in January is determined to be

January:

$$\dot{Q}_{\text{solar gain, North}} = 0.5046 \times (4 \text{ m}^2) \times (446 \text{ Wh/m}^2 \cdot \text{day}) = 900 \text{ Wh/day}$$

$$\dot{Q}_{\text{solar gain, East}} = 0.5046 \times (6 \text{ m}^2) \times (1863 \text{ Wh/m}^2 \cdot \text{day}) = 5640 \text{ Wh/day}$$

$$\dot{Q}_{\text{solar gain, South}} = 0.5046 \times (8 \text{ m}^2) \times (5897 \text{ Wh/m}^2 \cdot \text{day}) = 23,805 \text{ Wh/day}$$

$$\dot{Q}_{\text{solar gain, West}} = 0.5046 \times (6 \text{ m}^2) \times (1863 \text{ Wh/m}^2 \cdot \text{day}) = 5640 \text{ Wh/day}$$

Therefore, for an average day in January,

$$\dot{Q}_{\text{solar gain per day}} = 900 + 5640 + 23,805 + 5640 = 35,985 \text{ Wh/day} = \mathbf{35.895 \text{ kWh/day}}$$

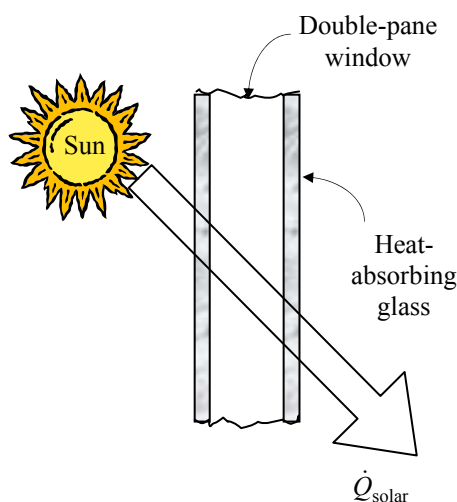

16-110 A building at 40° N latitude has double pane heat absorbing type windows that are equipped with light colored venetian blinds. The total solar heat gains of the building through the south windows at solar noon in April for the cases of with and without the blinds are to be determined.

Assumptions The calculations are performed for an “average” day in April, and may vary from location to location.

Properties The shading coefficient of a double pane heat absorbing type windows is $SC = 0.58$ (Table 11-5). It is given to be $SC = 0.30$ in the case of blinds. The solar radiation incident at a South-facing surface at 12:00 noon in April is 559 W/m^2 (Table 11-4).

Analysis The solar heat gain coefficient (SHGC) of the windows without the blinds is determined from Eq. 16-40 to be

$$SHGC = 0.87 \times SC = 0.87 \times 0.58 = 0.5046$$

Then the rate of solar heat gain through the window becomes

$$\begin{aligned} \dot{Q}_{\text{solar gain, no blinds}} &= SHGC \times A_{\text{glazing}} \times \dot{q}_{\text{solar, incident}} \\ &= 0.5046(130 \text{ m}^2)(559 \text{ W/m}^2) \\ &= \mathbf{36,670 \text{ W}} \end{aligned}$$

In the case of windows equipped with venetian blinds, the SHGC and the rate of solar heat gain become

$$SHGC = 0.87 \times SC = 0.87 \times 0.30 = 0.261$$

Then the rate of solar heat gain through the window becomes

$$\begin{aligned} \dot{Q}_{\text{solar gain, no blinds}} &= SHGC \times A_{\text{glazing}} \times \dot{q}_{\text{solar, incident}} \\ &= 0.261(130 \text{ m}^2)(559 \text{ W/m}^2) \\ &= \mathbf{18,970 \text{ W}} \end{aligned}$$

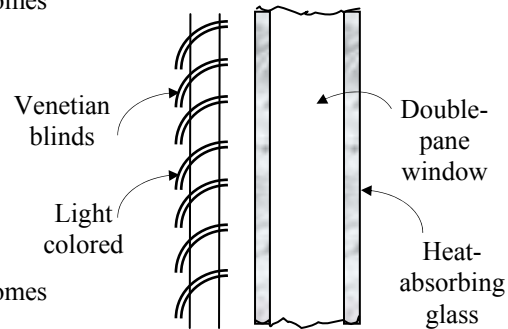

Discussion Note that light colored venetian blinds significantly reduce the solar heat, and thus air-conditioning load in summers.

16-111 A house has double door type windows that are double pane with 6.4 mm of air space and aluminum frames and spacers. It is to be determined if the house is losing more or less heat than it is gaining from the sun through an east window in a typical day in January.

Assumptions 1 The calculations are performed for an “average” day in January. **2** Solar data at 40° latitude can also be used for a location at 39° latitude.

Properties The shading coefficient of a double pane window with 3-mm thick clear glass is $SC = 0.88$ (Table 16-21). The overall heat transfer coefficient for double door type windows that are double pane with 6.4 mm of air space and aluminum frames and spacers is $4.55 \text{ W/m}^2 \cdot ^\circ\text{C}$ (Table 16-19). The total solar radiation incident at an East-facing surface in January during a typical day is 1863 Wh/m^2 (Table 16-20).

Analysis The solar heat gain coefficient (SHGC) of the windows is determined from Eq. 16-40 to be

$$SHGC = 0.87 \times SC = 0.87 \times 0.88 = 0.7656$$

Then the solar heat gain through the window per unit area becomes

$$\begin{aligned} Q_{\text{solar gain}} &= SHGC \times A_{\text{glazing}} \times q_{\text{solar, daily total}} \\ &= 0.7656(1 \text{ m}^2)(1863 \text{ Wh/m}^2) \\ &= \mathbf{1426 \text{ Wh} = 1.426 \text{ kWh}} \end{aligned}$$

The heat loss through a unit area of the window during a 24-h period is

$$\begin{aligned} Q_{\text{loss, window}} &= \dot{Q}_{\text{loss, window}} \Delta t = U_{\text{window}} A_{\text{window}} (T_i - T_{0, \text{ave}})(1 \text{ day}) \\ &= (4.55 \text{ W/m}^2 \cdot ^\circ\text{C})(1 \text{ m}^2)(22 - 10)^\circ\text{C}(24 \text{ h}) \\ &= \mathbf{1310 \text{ Wh} = 1.31 \text{ kWh}} \end{aligned}$$

Therefore, the house is losing **less** heat than it is gaining through the East windows during a typical day in January.

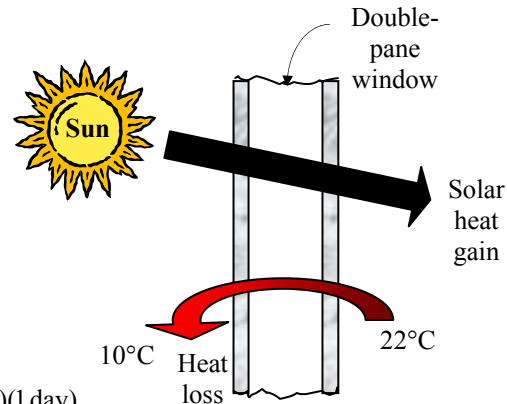

16-112 A house has double door type windows that are double pane with 6.4 mm of air space and aluminum frames and spacers. It is to be determined if the house is losing more or less heat than it is gaining from the sun through a South window in a typical day in January.

Assumptions 1 The calculations are performed for an “average” day in January. **2** Solar data at 40° latitude can also be used for a location at 39° latitude.

Properties The shading coefficient of a double pane window with 3-mm thick clear glass is $SC = 0.88$ (Table 16-21). The overall heat transfer coefficient for double door type windows that are double pane with 6.4 mm of air space and aluminum frames and spacers is $4.55 \text{ W/m}^2 \cdot ^\circ\text{C}$ (Table 16-19). The total solar radiation incident at a South-facing surface in January during a typical day is 5897 Wh/m^2 (Table 16-20).

Analysis The solar heat gain coefficient (SHGC) of the windows is determined from Eq. 16-40 to be

$$SHGC = 0.87 \times SC = 0.87 \times 0.88 = 0.7656$$

Then the solar heat gain through the window per unit area becomes

$$\begin{aligned} Q_{\text{solar gain}} &= SHGC \times A_{\text{glazing}} \times q_{\text{solar, daily total}} \\ &= 0.7656(1 \text{ m}^2)(5897 \text{ Wh/m}^2) \\ &= \mathbf{4515 \text{ Wh} = 4.515 \text{ kWh}} \end{aligned}$$

The heat loss through a unit area of the window during a 24-h period is

$$\begin{aligned} Q_{\text{loss, window}} &= \dot{Q}_{\text{loss, window}} \Delta t = U_{\text{window}} A_{\text{window}} (T_i - T_{0, \text{ave}})(1 \text{ day}) \\ &= (4.55 \text{ W/m}^2 \cdot ^\circ\text{C})(1 \text{ m}^2)(22 - 10)^\circ\text{C}(24 \text{ h}) \\ &= \mathbf{1310 \text{ Wh} = 1.31 \text{ kWh}} \end{aligned}$$

Therefore, the house is **losing** much less heat than it is gaining through the South windows during a typical day in January.

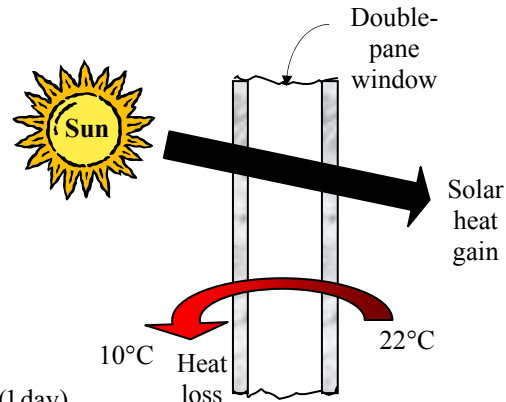

16-113E A house has 1/8-in thick single pane windows with aluminum frames on a West wall. The rate of net heat gain (or loss) through the window at 3 PM during a typical day in January is to be determined.

Assumptions **1** The calculations are performed for an “average” day in January. **2** The frame area relative to glazing area is small so that the glazing area can be taken to be the same as the window area.

Properties The shading coefficient of a 1/8-in thick single pane window is $SC = 1.0$ (Table 16-21). The overall heat transfer coefficient for 1/8-in thick single pane windows with aluminum frames is $6.63 \text{ W/m}^2 \cdot ^\circ\text{C} = 1.17 \text{ Btu/h} \cdot \text{ft}^2 \cdot ^\circ\text{F}$ (Table 9-6). The total solar radiation incident at a West-facing surface at 3 PM in January during a typical day is $557 \text{ W/m}^2 = 177 \text{ Btu/h} \cdot \text{ft}^2$ (Table 16-20).

Analysis The solar heat gain coefficient (SHGC) of the windows is determined from Eq. 16-40 to be

$$SHGC = 0.87 \times SC = 0.87 \times 1.0 = 0.87$$

The window area is: $A_{\text{window}} = (9 \text{ ft})(15 \text{ ft}) = 135 \text{ ft}^2$

Then the rate of solar heat gain through the window at 3 PM becomes

$$\begin{aligned} \dot{Q}_{\text{solar gain, 3 PM}} &= SHGC \times A_{\text{glazing}} \times \dot{q}_{\text{solar, 3 PM}} \\ &= 0.87(135 \text{ ft}^2)(177 \text{ Btu/h} \cdot \text{ft}^2) \\ &= 20,789 \text{ Btu/h} \end{aligned}$$

The rate of heat loss through the window at 3 PM is

$$\begin{aligned} \dot{Q}_{\text{loss, window}} &= U_{\text{window}} A_{\text{window}} (T_i - T_o) \\ &= (1.17 \text{ Btu/h} \cdot \text{ft}^2 \cdot ^\circ\text{F})(135 \text{ ft}^2)(70 - 20)^\circ\text{F} \\ &= 7898 \text{ Btu/h} \end{aligned}$$

The house will be gaining heat at 3 PM since the solar heat gain is larger than the heat loss. The rate of net heat gain through the window is

$$\dot{Q}_{\text{net}} = \dot{Q}_{\text{solar gain, 3 PM}} - \dot{Q}_{\text{loss, window}} = 20,789 - 7898 = \mathbf{12,890 \text{ Btu/h}}$$

Discussion The actual heat gain will be less because of the area occupied by the window frame.

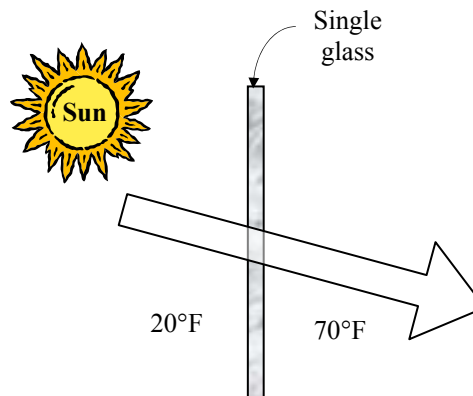

16-114 A building located near 40° N latitude has equal window areas on all four sides. The side of the building with the highest solar heat gain in summer is to be determined.

Assumptions The shading coefficients of windows on all sides of the building are identical.

Analysis The reflective films should be installed on the side that receives the most incident solar radiation in summer since the window areas and the shading coefficients on all four sides are identical. The incident solar radiation at different windows in July are given to be (Table 16-20)

Month	Time	The daily total solar radiation incident on the surface, Wh/m^2			
		North	East	South	West
July	Daily total	1621	4313	2552	4313

Therefore, the reflective film should be installed on the **East** or **West** windows (instead of the South windows) in order to minimize the solar heat gain and thus the cooling load of the building.

Infiltration Heat Load and Weatherizing

16-115C The uncontrolled entry of outside air into a building through unintentional openings is called *infiltration*. It differs from ventilation in that ventilation is intentional and controlled whereas infiltration is unintentional and uncontrolled. Infiltration increases the heating loss in winter and the cooling load in summer since the air entering must be heated in winter and cooled in summer. Therefore, the warm air leaving the house represents *energy loss*. This is also the case for cool air leaving in summer since some electricity is used to cool that air.

16-116C Air infiltration rate of a building can be determined by direct measurements by (1) *injecting a tracer gas* into a building and observing the decline of its concentration with time, or (2) *pressurizing the building* to 10 to 75 Pa gage pressure by a large fan mounted on a door or window, and measuring the air flow required to maintain a specified indoor-outdoor pressure difference. The larger the airflow to maintain a pressure difference, the more the building may leak. Sulfur hexafluoride (SF₆) is commonly used as a tracer gas because it is inert, nontoxic, and easily detectable at concentrations as low as 1 part per billion. Pressurization testing is easier to conduct, and thus preferable to tracer gas testing.

The *design infiltration rate* determined at design conditions is used to size a heating or cooling equipment where as the *seasonal average infiltration rate* is used to properly estimate the seasonal energy consumption for heating or cooling.

16-117C The infiltration unit ACH (air changes per hour) is defined as

$$\text{ACH} = \frac{\text{Flow rate of outdoor air into the building (per hour)}}{\text{Internal volume of the building}} = \frac{\dot{V} \text{ (m}^3\text{/h)}}{V \text{ (m}^3\text{)}}$$

Therefore, the quantity ACH represents the number of building volumes of outdoor air that infiltrates (and eventually exfiltrates) per hour.

Too low and too high values of ACH should be avoided since too little fresh air will cause health and comfort problems such as the sick-building syndrome, which is experienced in super airtight buildings, and too much of it will waste energy. Therefore, the rate of fresh air supply should be just enough to maintain the indoor air quality at an acceptable level.

16-118C The energy of the air vented out from the kitchens and bathrooms can be saved by installing an *air-to-air heat exchanger* (also called “economizer” or “heat recuperator”) that transfers the heat from the exhausted stale air to the incoming fresh air without any mixing. Such heat exchangers are commonly used in superinsulated houses, but the benefits of such heat exchangers must be weighed against the cost and complexity of their installation.

16-119C The latent heat load of infiltration **is not** necessarily zero when the relative humidity of the hot outside air in summer is the same as that of inside air since

$\dot{Q}_{\text{infiltration, latent}} = \rho_o h_{fg} (\text{ACH})(V_{\text{building}})(w_i - w_o)$ where $w_i - w_o$ is the humidity ratio difference between the indoor and outdoor air, and w is higher at higher temperatures for the same relative humidity.

16-120C The latent heat load of infiltration **is** necessarily zero when the humidity ratio w of the hot outside air in summer is the same as that of inside air since $\dot{Q}_{\text{infiltration, latent}} = \rho_o h_{fg} (\text{ACH})(V_{\text{building}})(w_i - w_o) = 0$ when $w_i = w_o$.

16-121C Some practical ways of preventing infiltration in homes are (1) *caulking* that can be applied with a caulking gun inside and outside where two stationary surfaces such as a wall and a window frame meet and (2) *weather-stripping* with a narrow piece of metal, vinyl, rubber, felt or foam that seals the contact area between the fixed and movable sections of a joint.

16-122C Yes, it is true that the infiltration rate and infiltration losses can be reduced by using radiant panel heaters since the air temperature can be lowered without sacrificing comfort, and the lower the temperature difference between the indoors and the outdoors the lower the infiltration loss. It is also true that radiant panels will increase the heat losses through the wall and the roof by conduction as a result of increased surface temperature if this turns out to be the case since heat conduction through the wall is proportional to the temperature difference across the wall.

16-123E A winterizing project is to reduce the infiltration rate of a house from 2.2 ACH to 1.1 ACH. The resulting cost savings are to be determined.

Assumptions 1 The house is maintained at 72°F at all times. **2** The latent heat load during the heating season is negligible. **3** The infiltrating air is heated to 72°F before it exfiltrates.

Properties The gas constant of air is 0.3704 psia·ft³/lbm·R (Table A-1E). The specific heat of air at room temperature is 0.24 Btu/lbm·°F (Table A-11E).

Analysis The density of air at the outdoor conditions is

$$\rho_o = \frac{P_o}{RT_o} = \frac{13.5 \text{ psia}}{(0.3704 \text{ psia}\cdot\text{ft}^3/\text{lbm}\cdot\text{R})(496.5 \text{ R})} = 0.0734 \text{ lbm/ft}^3$$

The volume of the building is

$$V_{\text{building}} = (\text{Floor area})(\text{Height}) = (3000 \text{ ft}^2)(9 \text{ ft}) = 27,000 \text{ ft}^3$$

The reduction in the infiltration rate is 2.2 – 1.1 = 1.1 ACH.

The sensible infiltration heat load corresponding to it is

$$\begin{aligned} \dot{Q}_{\text{infiltration, saved}} &= \rho_o c_p (\text{ACH}_{\text{saved}})(V_{\text{building}})(T_i - T_o) \\ &= (0.0734 \text{ lbm/ft}^3)(0.24 \text{ Btu/lbm}\cdot\text{°F})(1.1/\text{h})(27,000 \text{ ft}^3)(72 - 36.5)\text{°F} \\ &= 18,573 \text{ Btu/h} = 0.18573 \text{ therm/h} \end{aligned}$$

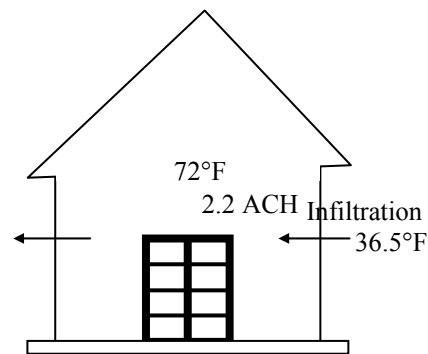

since 1 therm = 100,000 Btu. The number of hours during a six month period is 6×30×24 = 4320 h. Noting that the furnace efficiency is 0.65 and the unit cost of natural gas is \$1.20/therm, the energy and money saved during the 6-month period are

$$\begin{aligned} \text{Energy savings} &= (\dot{Q}_{\text{infiltration, saved}})(\text{No. of hours per year})/\text{Efficiency} \\ &= (0.18573 \text{ therm/h})(4320 \text{ h/year})/0.65 \\ &= 1234 \text{ therms/year} \end{aligned}$$

$$\begin{aligned} \text{Cost savings} &= (\text{Energy savings})(\text{Unit cost of energy}) \\ &= (1234 \text{ therms/year})(\$1.20/\text{therm}) \\ &= \mathbf{\$1480/\text{year}} \end{aligned}$$

Therefore, reducing the infiltration rate by one-half will reduce the heating costs of this homeowner by \$1480 per year.

16-124 Two identical buildings in Los Angeles and Denver have the same infiltration rate. The ratio of the heat losses by infiltration at the two cities under identical conditions is to be determined.

Assumptions Both homes are identical and both are subjected to the same conditions except the atmospheric conditions.

Analysis The sensible infiltration heat loss is given as

$$\dot{Q}_{\text{infiltration}} = \dot{m}_{\text{air}} c_p (T_i - T_o) = \rho_{o, \text{air}} (ACH)(V_{\text{building}}) c_p (T_i - T_o)$$

Therefore, the infiltration heat loss is proportional to the density of air, and thus the ratio of infiltration heat losses at the two cities is simply the densities of outdoor air at those cities,

$$\begin{aligned} \text{Infiltration heat loss ratio} &= \frac{\dot{Q}_{\text{infiltration, Los Angeles}}}{\dot{Q}_{\text{infiltration, Denver}}} = \frac{\rho_{o, \text{air, Los Angeles}}}{\rho_{o, \text{air, Denver}}} \\ &= \frac{(P_o / RT_o)_{\text{Los Angeles}}}{(P_o / RT_o)_{\text{Denver}}} = \frac{P_{o, \text{Los Angeles}}}{P_{o, \text{Denver}}} \\ &= \frac{101 \text{ kPa}}{83 \text{ kPa}} = \mathbf{1.22} \end{aligned}$$

Therefore, the infiltration heat loss in Los Angeles will be 22% higher than that in Denver under identical conditions.

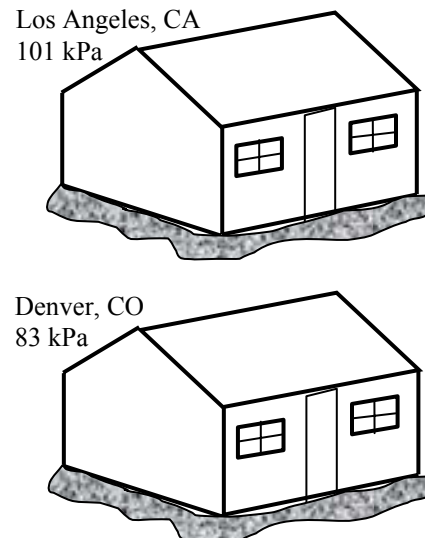

16-125 Outdoor air at -10°C and 90 kPa enters the building at a rate of 35 L/s when the indoors is maintained at 22°C . The rate of sensible heat loss from the building due to infiltration is to be determined.

Assumptions 1 The house is maintained at 22°C at all times. 2 The latent heat load is negligible. 3 The infiltrating air is heated to 22°C before it exfiltrates.

Properties The gas constant of air is $R = 0.287 \text{ kPa}\cdot\text{m}^3/\text{kg}\cdot\text{K}$ (Table A-1). The specific heat of air at room temperature is $c_p = 1.0 \text{ kJ}/\text{kg}\cdot^\circ\text{C}$ (Table A-11).

Analysis The density of air at the outdoor conditions is

$$\rho_o = \frac{P_o}{RT_o} = \frac{90 \text{ kPa}}{(0.287 \text{ kPa}\cdot\text{m}^3/\text{kg}\cdot\text{K})(-10 + 273 \text{ K})} = 1.19 \text{ kg}/\text{m}^3$$

Then the sensible infiltration heat load corresponding to an infiltration rate of 35 L/s becomes

$$\begin{aligned} \dot{Q}_{\text{infiltration}} &= \rho_o \dot{V}_{\text{air}} c_p (T_i - T_o) \\ &= (1.19 \text{ kg}/\text{m}^3)(0.035 \text{ m}^3/\text{s})(1.0 \text{ kJ}/\text{kg}\cdot^\circ\text{C})[22 - (-10)]^\circ\text{C} \\ &= \mathbf{1.335 \text{ kW}} \end{aligned}$$

Therefore, sensible heat will be lost at a rate of 1.335 kJ/s due to infiltration.

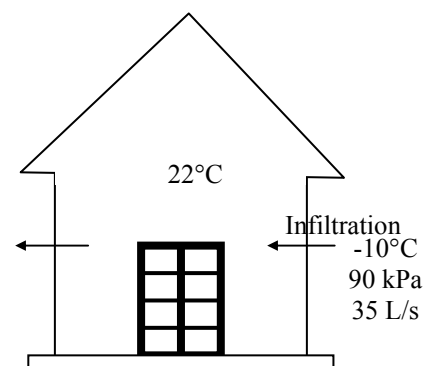

16-126 The ventilating fan of the bathroom of an electrically heated building in San Francisco runs continuously. The amount and cost of the heat “vented out” per month in winter are to be determined.

Assumptions **1** We take the atmospheric pressure to be 1 atm = 101.3 kPa since San Francisco is at sea level. **2** The house is maintained at 22°C at all times. **3** The infiltrating air is heated to 22°C before it exfiltrates.

Properties The gas constant of air is $R = 0.287 \text{ kPa}\cdot\text{m}^3/\text{kg}\cdot\text{K}$ (Table A-1). The specific heat of air at room temperature is $c_p = 1.0 \text{ kJ/kg}\cdot^\circ\text{C}$ (Table A-11).

Analysis The density of air at the indoor conditions of 1 atm and 22°C is

$$\rho_o = \frac{P_o}{RT_o} = \frac{(101.3 \text{ kPa})}{(0.287 \text{ kPa}\cdot\text{m}^3/\text{kg}\cdot\text{K})(22 + 273 \text{ K})} = 1.20 \text{ kg/m}^3$$

Then the mass flow rate of air vented out becomes

$$\dot{m}_{\text{air}} = \rho \dot{V}_{\text{air}} = (1.20 \text{ kg/m}^3)(0.030 \text{ m}^3/\text{s}) = 0.036 \text{ kg/s}$$

Noting that the indoor air vented out at 22°C is replaced by infiltrating outdoor air at 12.2°C, this corresponds to energy loss at a rate of

$$\begin{aligned} \dot{Q}_{\text{loss by fan}} &= \dot{m}_{\text{air}} c_p (T_{\text{indoors}} - T_{\text{outdoors}}) \\ &= (0.036 \text{ kg/s})(1.005 \text{ kJ/kg}\cdot^\circ\text{C})(22 - 12.2)^\circ\text{C} = 0.355 \text{ kJ/s} = 0.355 \text{ kW} \end{aligned}$$

Then the amount and cost of the heat “vented out” per month (1 month = 30×24 = 720 h) becomes

$$\text{Energy loss} = \dot{Q}_{\text{loss by fan}} \Delta t = (0.355 \text{ kW})(720 \text{ h/month}) = \mathbf{256 \text{ kWh/month}}$$

$$\text{Money loss} = (\text{Energy loss})(\text{Unit cost of energy}) = (256 \text{ kWh/month})(\$0.09/\text{kWh}) = \mathbf{\$23.0/\text{month}}$$

Discussion Note that the energy and money loss associated with ventilating fans can be very significant. Therefore, ventilating fans should be used with care.

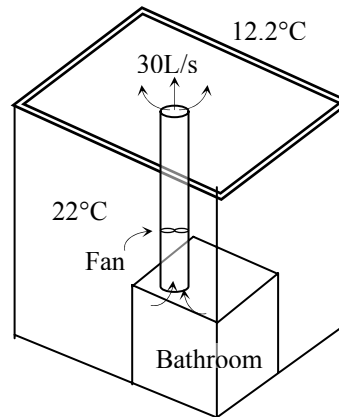

16-127 The infiltration rate of a building is estimated to be 1.2 ACH. The sensible, latent, and total infiltration heat loads of the building at sea level are to be determined.

Assumptions 1 Steady operating conditions exist. 2 The air infiltrates at the outdoor conditions, and exfiltrates at the indoor conditions. 3 Excess moisture condenses at 5°C. 4 The effect of water vapor on air density is negligible.

Properties The gas constant and the specific heat of air are $R = 0.287 \text{ kPa}\cdot\text{m}^3/\text{kg}\cdot\text{K}$ and $c_p = 1.0 \text{ kJ}/\text{kg}\cdot^\circ\text{C}$ (Tables A-1 and A-15). The heat of vaporization of water at 5°C is $h_{fg} = h_{fg@5^\circ\text{C}} = 2490 \text{ kJ}/\text{kg}$ (Table A-9). The properties of the ambient and room air are determined from the psychrometric chart to be

$$\left. \begin{array}{l} T_{\text{ambient}} = 32^\circ\text{C} \\ \phi_{\text{ambient}} = 50\% \end{array} \right\} \omega_{\text{ambient}} = 0.0150 \text{ kg}/\text{kg dry air}$$

$$\left. \begin{array}{l} T_{\text{room}} = 24^\circ\text{C} \\ \phi_{\text{room}} = 50\% \end{array} \right\} \omega_{\text{room}} = 0.0093 \text{ kg}/\text{kg dry air}$$

Analysis Noting that the infiltration of ambient air will cause the air in the cold storage room to be changed 0.8 times every hour, the air will enter the room at a mass flow rate of

$$\rho_{\text{ambient}} = \frac{P_o}{RT_o} = \frac{101.325 \text{ kPa}}{(0.287 \text{ kPa}\cdot\text{m}^3/\text{kg}\cdot\text{K})(32 + 273 \text{ K})} = 1.16 \text{ kg}/\text{m}^3$$

$$\dot{m}_{\text{air}} = \rho_{\text{ambient}} \mathbf{V}_{\text{room}} \text{ACH} = (1.16 \text{ kg}/\text{m}^3)(20 \times 13 \times 3 \text{ m}^3)(1.2 \text{ h}^{-1}) = 1085 \text{ kg}/\text{s} = 0.3016 \text{ kg}/\text{s}$$

Then the sensible, latent, and total infiltration heat loads of the room are determined to be

$$\dot{Q}_{\text{infiltration,sensible}} = \dot{m}_{\text{air}} c_p (T_{\text{ambient}} - T_{\text{room}}) = (0.3016 \text{ kg}/\text{s})(1.0 \text{ kJ}/\text{kg}\cdot^\circ\text{C})(32 - 24)^\circ\text{C} = \mathbf{2.41 \text{ kW}}$$

$$\dot{Q}_{\text{infiltration,latent}} = \dot{m}_{\text{air}} (\omega_{\text{ambient}} - \omega_{\text{room}}) h_{fg} = (0.3016 \text{ kg}/\text{s})(0.0150 - 0.0093)(2490 \text{ kJ}/\text{kg}) = \mathbf{4.28 \text{ kW}}$$

$$\dot{Q}_{\text{infiltration,total}} = \dot{Q}_{\text{infiltration,sensible}} + \dot{Q}_{\text{infiltration,latent}} = 2.41 + 4.28 = \mathbf{6.69 \text{ kW}}$$

Discussion The specific volume of the dry air at the ambient conditions could also be determined from the psychrometric chart at ambient conditions.

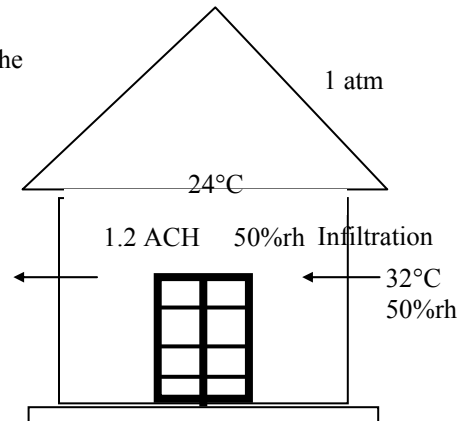

Annual Energy Consumption

16-128C Yes, it is possible for a building in a city to have a higher peak heating load but a lower energy consumption for heating in winter than an identical building in another city. This will be the case for a city with severe but relatively short heating seasons.

16-129C No, we cannot determine the annual energy consumption of a building for heating by simply multiplying the design heating load of the building by the number of hours in the heating season. This is because the design heating load represents the heat loss under extreme conditions, not average conditions.

16-130C No, as the manager of a large commercial building, I would not lower the thermostat setting in winter and raise it in summer by a few degrees. Although this practice will save energy and thus money, it may cost much more in reduced productivity.

16-131C Taking the balance point temperature to be 18°C, as is commonly done, the number of heating degree-days for a winter day during which the average outdoor temperature was 10°C, and never went above 18°C, is determined to be

$$DD_{1 \text{ day}} = (T_{\text{balance point}} - T_{\text{daily average}})(1 \text{ day}) = (18 - 10)^{\circ}\text{C}(1 \text{ day}) = \mathbf{8^{\circ}\text{C}\cdot\text{day}}$$

16-132C Taking the balance point temperature to be 18°C, as is commonly done, the number of heating degree-days for a winter month during which the average outdoor temperature was 12°C, and never rose above 18°C, is determined to be

$$DD_{1 \text{ mont}} = (T_{\text{balance point}} - T_{\text{monthly average}})(1 \text{ month}) = (18 - 12)^{\circ}\text{C}(30 \text{ days}) = \mathbf{180^{\circ}\text{C}\cdot\text{day}}$$

16-133C The °C-days are based on temperature differences, and $\Delta T(^{\circ}\text{F}) = 1.8\Delta T(^{\circ}\text{C})$ for temperature differences. Therefore, we should not add 32 to the result.

16-134C The outdoor temperature above which no heating is required is called the *balance point temperature* T_{balance} . The balance-point temperature is used in the determination of degree-days instead of the actual thermostat setting of a building since the internal heat generated by people, lights, and appliances in occupied buildings as well as the heat gain from the sun during the day, \dot{Q}_{gain} , will be sufficient to compensate for the heat losses from the building until the outdoor temperature drops below T_{balance} .

16-135C It is proper to use the degree-day method to determine the annual energy consumption of a building under relatively *steady* conditions. The method is based on constant indoor conditions during the heating or cooling season, and it assumes the efficiency of the heating or cooling equipment is not affected by the variation of outdoor temperature. These conditions will be closely approximated if all the thermostats in a building are set at the same temperature at the beginning of a heating or cooling season, and are never changed, and a seasonal average efficiency is used (rather than the full-load or design efficiency) for the furnaces or coolers.

16-136 A person offers to his roommate in Syracuse, New York, to pay the heating bills during the upcoming year (starting January 1st) if he pays the heating bills for the current calendar year until Dec. 31. It is to be determined if this is a good offer.

Assumptions The calculations are performed for an “average” year. **2** The time value of money is not considered.

Properties The annual heating degree-days of Syracuse, NY, is 6756°F-days (Table 16-5). The monthly distribution of degree-days are 6, 28, 132, 415, 744, 1153, 1271, 1140, 1004, 570, 248, and 45°F-days for July through June, respectively.

Analysis It makes sense to accept this offer if the cost of heating before December 31st is less than the cost of heating after December 31st. The amount and cost of energy consumption of a building for heating is proportional to the heating degree days. For Syracuse, we have

$$DD_{\text{heating, before Dec. 31}} = 6 + 28 + 132 + 415 + 744 + 1153 = 2478^\circ\text{F-days} \quad (2478/6756 = 0.367)$$

$$DD_{\text{heating, after Dec. 31}} = 1271 + 1140 + 1004 + 570 + 248 + 45 = 4278^\circ\text{F-days} \quad (4278/6756 = 0.633)$$

This is clearly a **good offer** for the roommate since 63.3% of the heating load occurs after December 31st, and the proposer is offering to pay for it. Therefore, the offer should be accepted.

16-137E A house whose design heat load is 83,000 Btu/h is heated by a high-efficiency natural gas furnace. The annual gas consumption of this house and its cost are to be determined.

Assumptions 1 The house is maintained at 70°F at all times during the heating season. **2** The calculations are performed for an “average” year.

Properties The annual heating degree-days of Billing, Montana, is 7049°F-days (Table 16-5). The winter design temperature of Billing is given to be -10°F.

Analysis The fuel (natural gas) consumption rate of the house for heating at design conditions is

$$\dot{Q}_{\text{design}} = \frac{\dot{Q}_{\text{design, load}}}{\eta_{\text{heating}}} = \frac{83,000 \text{ Btu/h}}{0.95} = 87,368 \text{ Btu/h} = 0.874 \text{ therm/h}$$

Then the annual natural gas usage of the house and its cost can be determined from Eq. 16-48 to be

$$\begin{aligned} \text{Annual fuel consumption} &= Q_{\text{heating, year}} = \frac{DD_{\text{heating}}}{(T_i - T_o)_{\text{design}}} \dot{Q}_{\text{design}} \\ &= \frac{7049^\circ\text{F} \cdot \text{day}}{[70 - (-10)]^\circ\text{F}} \left(\frac{24 \text{ h}}{1 \text{ day}} \right) (0.874 \text{ therm/h}) \\ &= \mathbf{1848 \text{ therms/year}} \end{aligned}$$

and

$$\begin{aligned} \text{Annual fuel cost} &= (\text{Annual fuel consumption})(\text{Unit cost of fuel}) \\ &= (1848 \text{ therms/year})(\$1.10/\text{therm}) = \mathbf{\$2033/\text{year}} \end{aligned}$$

Therefore, it will cost \$2033 per year to heat this house during an average year.

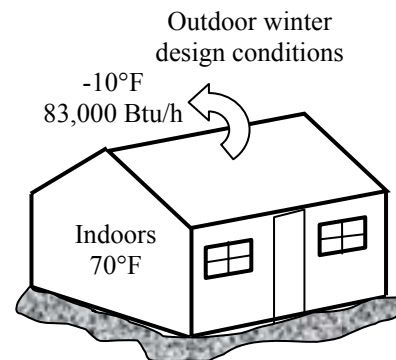

16-138 A decision is to be made between a cheaper but inefficient and an expensive but efficient air-conditioner for a building.

Assumptions The two air conditioners are comparable in all aspects other than the initial cost and the efficiency.

Analysis The unit that will cost less during its lifetime is a better buy. The total cost of a system during its lifetime (the initial, operation, maintenance, etc.) can be determined by performing a life cycle cost analysis. A simpler alternative is to determine the simple payback period. The energy and cost savings of the more efficient air conditioner in this case is

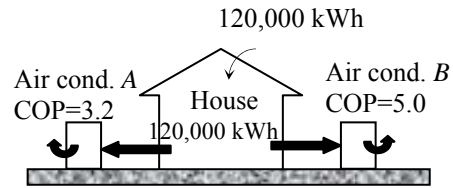

$$\begin{aligned}\text{Energy savings} &= (\text{Annual energy usage of A}) - (\text{Annual energy usage of B}) \\ &= (\text{Annual cooling load})(1/\text{COP}_A - 1/\text{COP}_B) \\ &= (120,000 \text{ kWh/year})(1/3.2 - 1/5.0) \\ &= 13,500 \text{ kWh/year}\end{aligned}$$

$$\begin{aligned}\text{Cost savings} &= (\text{Energy savings})(\text{Unit cost of energy}) \\ &= (13,500 \text{ kWh/year})(\$0.10/\text{kWh}) = \mathbf{\$1350/\text{year}}\end{aligned}$$

The installation cost difference between the two air-conditioners is

$$\text{Cost difference} = \text{Cost of B} - \text{cost of A} = 7000 - 5500 = \$1500$$

Therefore, the more efficient air-conditioner B will pay for the \$1500 cost differential in this case in about 1 year.

Discussion A cost conscious consumer will have no difficulty in deciding that the more expensive but more efficient air-conditioner B is clearly a better buy in this case since air conditioners last at least 15 years. But the decision would not be so easy if the unit cost of electricity at that location was much less than \$0.10/kWh, or if the annual air-conditioning load of the house was much less than 120,000 kWh.

16-139 An industrial facility is to replace its 40-W standard fluorescent lamps by their 34-W high efficiency counterparts. The amount of energy and money that will be saved a year as a result of switching to the high efficiency fluorescent lamps as well as the simple payback period are to be determined.

Analysis The reduction in the total electric power consumed by the lighting as a result of switching to the high efficiency fluorescent is

$$\begin{aligned}\text{Wattage reduction} &= (\text{Wattage reduction per lamp})(\text{Number of lamps}) \\ &= (40 - 34 \text{ W/lamp})(700 \text{ lamps}) \\ &= 4200 \text{ W}\end{aligned}$$

Then using the relations given earlier, the energy and cost savings associated with the replacement of the high efficiency fluorescent lamps are determined to be

$$\begin{aligned}\text{Energy Savings} &= (\text{Total wattage reduction})(\text{Ballast factor})(\text{Operating hours}) \\ &= (4.2 \text{ kW})(1.1)(2800 \text{ h/year}) \\ &= \mathbf{12,936 \text{ kWh/year}}\end{aligned}$$

$$\begin{aligned}\text{Cost Savings} &= (\text{Energy savings})(\text{Unit electricity cost}) \\ &= (12,936 \text{ kWh/year})(\$0.08/\text{kWh}) \\ &= \mathbf{\$1035}\end{aligned}$$

The implementation cost of this measure is simply the extra cost of the energy efficient fluorescent bulbs relative to standard ones, and is determined to be

$$\begin{aligned}\text{Implementation Cost} &= (\text{Cost difference of lamps})(\text{Number of lamps}) \\ &= [(\$2.26 - \$1.77)/\text{lamp}](700 \text{ lamps}) \\ &= \$343\end{aligned}$$

This gives a simple payback period of

$$\text{Simple payback period} = \frac{\text{Implementation cost}}{\text{Annual cost savings}} = \frac{\$343}{\$1035 / \text{year}} = \mathbf{0.33 \text{ year}} \quad (4.0 \text{ months})$$

Discussion Note that if all the lamps were burnt out today and are replaced by high-efficiency lamps instead of the conventional ones, the savings from electricity cost would pay for the cost differential in about 4 months. The electricity saved will also help the environment by reducing the amount of CO₂, CO, NO_x, etc. associated with the generation of electricity in a power plant.

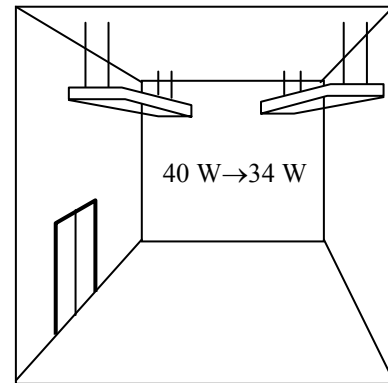

16-140 The lighting energy consumption of a storage room is to be reduced by installing motion sensors. The amount of energy and money that will be saved as a result of installing motion sensor as well as the simple payback period are to be determined.

Assumptions The electrical energy consumed by the ballasts is negligible.

Analysis The plant operates 12 hours a day, and thus currently the lights are on for the entire 12 hour period. The motion sensors installed will keep the lights on for 3 hours, and off for the remaining 9 hours every day. This corresponds to a total of $9 \times 365 = 3285$ off hours per year. Disregarding the ballast factor, the annual energy and cost savings become

$$\begin{aligned} \text{Energy Savings} &= (\text{Number of lamps})(\text{Lamp wattage})(\text{Reduction of annual operating hours}) \\ &= (24 \text{ lamps})(60 \text{ W/lamp})(3285 \text{ hours/year}) \\ &= \mathbf{4730 \text{ kWh/year}} \end{aligned}$$

$$\begin{aligned} \text{Cost Savings} &= (\text{Energy Savings})(\text{Unit cost of energy}) \\ &= (5,203 \text{ kWh/year})(\$0.08/\text{kWh}) \\ &= \mathbf{\$378/\text{year}} \end{aligned}$$

The implementation cost of this measure is the sum of the purchase price of the sensor plus the labor,

$$\text{Implementation Cost} = \text{Material} + \text{Labor} = \$32 + \$40 = \$72$$

This gives a simple payback period of

$$\begin{aligned} \text{Simple payback period} &= \frac{\text{Implementation cost}}{\text{Annual cost savings}} = \frac{\$72}{\$378/\text{year}} \\ &= \mathbf{0.19 \text{ year}} \quad (2.3 \text{ months}) \end{aligned}$$

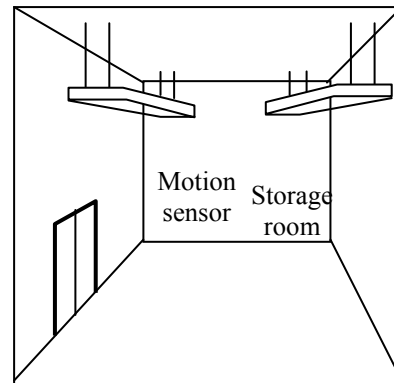

Therefore, the motion sensor will pay for itself in about 2 months.

16-141 The existing manual thermostats of an office building are to be replaced by programmable ones to reduce the heating costs by lowering the temperature setting shortly before closing at 6 PM and raising it shortly before opening at 8 AM. The annual energy and cost savings as result of installing programmable thermostats as well as the simple payback period are to be determined.

Assumptions 1 The ambient temperature remains below 7.2°C during the entire heating season (Nov.-Apr). This assumption will most likely be violated some days, and thus the result is optimistic. **2** The balance point temperature is 18°C so that no heating is required at temperatures above 18°C.

Properties The annual heating degree-days for Reno, Nevada is given to be 3346°C-days.

Analysis The energy usage for heating is proportional to degree days, and the reduction in the degree days due to lowering the thermostat setting to 7.2°C from about 6 PM to 8 AM for 10 h for everyday during the heating season for 180 days is

$$DD_{\text{reduction}} = (22 - 7.2)^{\circ}\text{C}(10 \text{ h/day})(180 \text{ days}) = 32,614^{\circ}\text{C}\cdot\text{h} = 1359^{\circ}\text{C}\cdot\text{day}$$

which is

$$\text{Reduction fraction} = \frac{DD_{\text{reduction}}}{DD_{\text{annual}}} = \frac{1359^{\circ}\text{C}\cdot\text{days}}{3346^{\circ}\text{C}\cdot\text{days}} = 0.406 \text{ (or 40.6\%)}$$

Therefore, the energy usage for heating will be reduced by 40.6%. Then the reduction in the amount and cost of heating energy as a result of installing programmable thermostats become

$$\begin{aligned} \text{Energy Savings} &= (\text{Reduction fraction})(\text{Annual heating energy usage}) \\ &= 0.406(3530 \text{ therms/year}) = \mathbf{1433 \text{ therms/year}} \end{aligned}$$

and

$$\text{Cost Savings} = (\text{Reduction fraction})(\text{Annual heating bill}) = 0.406(\$4060/\text{year}) = \mathbf{\$1648/\text{year}}$$

The total implementation cost of installation of 5 programmable thermostats is

$$\text{Implementation Cost} = 5 \times \$325 = \$1625$$

This gives a simple payback period of

$$\text{Simple payback period} = \frac{\text{Implementation cost}}{\text{Annual cost savings}} = \frac{\$1625}{\$1648/\text{year}} = \mathbf{0.986 \text{ year}}$$

Therefore, the programmable thermostats will pay for themselves during the first heating season.

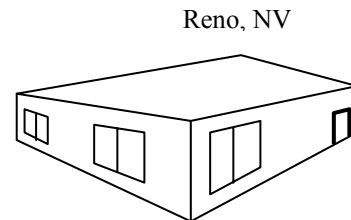

16-142 A worn out standard motor is to be replaced by a high efficiency one. The amount of electrical energy and money savings as a result of installing the high efficiency motor instead of the standard one as well as the simple payback period are to be determined.

Assumptions The load factor of the motor remains constant at 0.75.

Analysis The electric power drawn by each motor and their difference can be expressed as

$$\dot{W}_{\text{electric in, standard}} = \dot{W}_{\text{shaft}} / \eta_{\text{standard}} = (\text{Power rating})(\text{Load factor}) / \eta_{\text{standard}}$$

$$\dot{W}_{\text{electric in, efficient}} = \dot{W}_{\text{shaft}} / \eta_{\text{efficient}} = (\text{Power rating})(\text{Load factor}) / \eta_{\text{efficient}}$$

$$\begin{aligned} \text{Power savings} &= \dot{W}_{\text{electric in, standard}} - \dot{W}_{\text{electric in, efficient}} \\ &= (\text{Power rating})(\text{Load factor})[1/\eta_{\text{standard}} - 1/\eta_{\text{efficient}}] \end{aligned}$$

where η_{standard} is the efficiency of the standard motor, and $\eta_{\text{efficient}}$ is the efficiency of the comparable high efficiency motor. Then the annual energy and cost savings associated with the installation of the high efficiency motor are determined to be

$$\begin{aligned} \text{Energy Savings} &= (\text{Power savings})(\text{Operating Hours}) \\ &= (\text{Power Rating})(\text{Operating Hours})(\text{Load Factor})(1/\eta_{\text{standard}} - 1/\eta_{\text{efficient}}) \\ &= (75 \text{ hp})(0.746 \text{ kW/hp})(4,368 \text{ hours/year})(0.75)(1/0.91 - 1/0.954) \\ &= \mathbf{9,290 \text{ kWh/year}} \end{aligned}$$

$$\begin{aligned} \text{Cost Savings} &= (\text{Energy savings})(\text{Unit cost of energy}) \\ &= (9,290 \text{ kWh/year})(\$0.08/\text{kWh}) \\ &= \mathbf{\$743/\text{year}} \end{aligned}$$

The implementation cost of this measure consists of the excess cost the high efficiency motor over the standard one. That is,

$$\text{Implementation Cost} = \text{Cost differential} = \$5,520 - \$5,449 = \$71$$

This gives a simple payback period of

$$\text{Simple payback period} = \frac{\text{Implementation cost}}{\text{Annual cost savings}} = \frac{\$71}{\$743/\text{year}} = \mathbf{0.096 \text{ year}} \text{ (or 1.1 months)}$$

Therefore, the high-efficiency motor will pay for its cost differential in about one month.

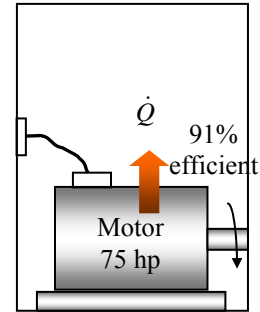

16-143 The combustion efficiency of a furnace is raised from 0.7 to 0.8 by tuning it up. The annual energy and cost savings as a result of tuning up the boiler are to be determined.

Assumptions The boiler operates at full load while operating.

Analysis The heat output of boiler is related to the fuel energy input to the boiler by

$$\text{Boiler output} = (\text{Boiler input})(\text{Combustion efficiency})$$

or
$$\dot{Q}_{\text{out}} = \dot{Q}_{\text{in}} \eta_{\text{furnace}}$$

The current rate of heat input to the boiler is given to be

$\dot{Q}_{\text{in, current}} = 3.8 \times 10^6 \text{ Btu/h}$. Then the rate of useful heat output of the boiler becomes

$$\dot{Q}_{\text{out}} = (\dot{Q}_{\text{in}} \eta_{\text{furnace}})_{\text{current}} = (3.8 \times 10^6 \text{ Btu/h})(0.7) = 2.66 \times 10^6 \text{ Btu/h}$$

The boiler must supply useful heat at the same rate after the tune up.

Therefore, the rate of heat input to the boiler after the tune up and the rate of energy savings become

$$\dot{Q}_{\text{in, new}} = \dot{Q}_{\text{out}} / \eta_{\text{furnace, new}} = (2.66 \times 10^6 \text{ Btu/h}) / 0.8 = 3.325 \times 10^6 \text{ Btu/h}$$

$$\dot{Q}_{\text{in, saved}} = \dot{Q}_{\text{in, current}} - \dot{Q}_{\text{in, new}} = 3.8 \times 10^6 - 3.325 \times 10^6 = 0.475 \times 10^6 \text{ Btu/h}$$

Then the annual energy and cost savings associated with tuning up the boiler become

$$\begin{aligned} \text{Energy Savings} &= \dot{Q}_{\text{in, saved}} (\text{Operation hours}) \\ &= (0.475 \times 10^6 \text{ Btu/h})(1500 \text{ h/year}) = \mathbf{712.5 \times 10^6 \text{ Btu/yr}} \end{aligned}$$

$$\begin{aligned} \text{Cost Savings} &= (\text{Energy Savings})(\text{Unit cost of energy}) \\ &= (712.5 \times 10^6 \text{ Btu/yr})(\$4.35 \text{ per } 10^6 \text{ Btu}) = \mathbf{\$3099/\text{year}} \end{aligned}$$

Discussion Notice that tuning up the boiler will save \$3099 a year, which is a significant amount. The implementation cost of this measure is negligible if the adjustment can be made by in-house personnel. Otherwise it is worthwhile to have an authorized representative of the boiler manufacturer to service the boiler twice a year.

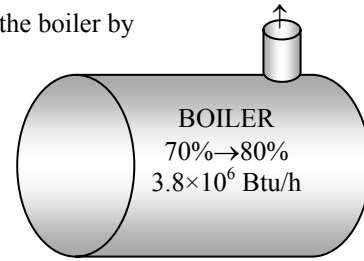

16-144 The gas space heating of a facility is to be supplemented by air heated in a liquid-to-air heat exchanger of a compressor. The amount of money that will be saved by diverting the compressor waste heat into the facility during the heating season is to be determined.

Assumptions The atmospheric pressure at that location is 1 atm.

Analysis The mass flow rate of air through the liquid-to-air heat exchanger is

$$\begin{aligned}\text{Mass flow rate of air} &= (\text{Density of air})(\text{Average velocity})(\text{Flow area}) \\ &= (1.21 \text{ kg/m}^3)(3 \text{ m/s})(1.0 \text{ m}^2) \\ &= 3.63 \text{ kg/s} = 13,068 \text{ kg/h}\end{aligned}$$

Noting that the exit temperature of air is 52°C, the rate at which heat can be recovered (or the rate at which heat is transferred to air) is

$$\begin{aligned}\text{Rate of Heat Recovery} &= (\text{Mass flow rate of air})(\text{Specific heat of air})(\text{Temperature rise}) \\ &= (13,068 \text{ kg/h})(1.0 \text{ kJ/kg} \cdot \text{°C})(52 - 20) \text{°C} \\ &= 418,176 \text{ kJ/h}\end{aligned}$$

The number of operating hours of this compressor during the heating season is

$$\text{Operating hours} = (20 \text{ hours/day})(5 \text{ days/week})(26 \text{ weeks/year}) = 2600 \text{ hours/year}$$

Then the annual energy and cost savings become

$$\begin{aligned}\text{Energy Savings} &= (\text{Rate of Heat Recovery})(\text{Annual Operating Hours})/\text{Efficiency} \\ &= (418,176 \text{ kJ/h})(2600 \text{ h/year})/0.8 \\ &= 1,359,100,000 \text{ kJ/year} \\ &= 12,882 \text{ therms/year}\end{aligned}$$

$$\begin{aligned}\text{Cost Savings} &= (\text{Energy savings})(\text{Unit cost of energy saved}) \\ &= (12,882 \text{ therms/year})(\$1.00/\text{therm}) \\ &= \$12,882/\text{year}\end{aligned}$$

Discussion Notice that utilizing the waste heat from the compressor will save \$12,882 per year from the heating costs. The implementation of this measure requires the installation of an ordinary sheet metal duct from the outlet of the heat exchanger into the building. The installation cost associated with this measure is relatively low. Several manufacturing facilities already have this conservation system in place. A damper is used to direct the air into the building in winter and to the ambient in summer. Combined compressor/heat-recovery systems are available in the market for both air-cooled (greater than 50 hp) water cooled (greater than 125 hp) systems.

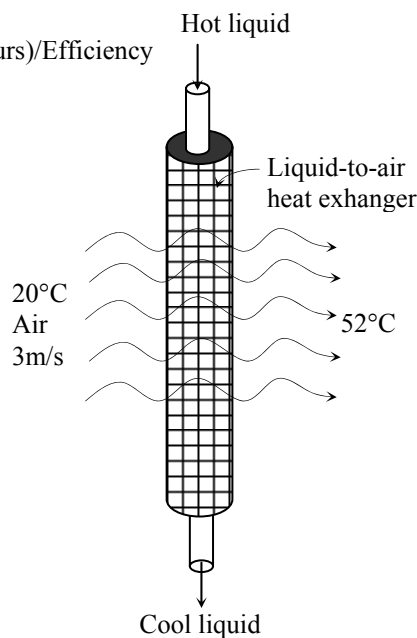

16-145 An Atlanta family has moved to an identical house in Denver, CO where the fuel and electricity prices are the same. The annual heating cost of this family in their new house is to be determined.

Assumptions Calculations are performed for an average year.

Properties The annual heating degree-days are 2961°F-days for Atlanta, and 6283°F-days for Denver (Table 16-5).

Solution The heating cost is proportional to the energy consumption, which is proportional to the degree-days. The ratio of the degree-days in the two cities is

$$DD_{\text{ratio}} = \frac{\text{°C - days for Atlanta}}{\text{°C - day for Denver}} = \frac{6283^{\circ}\text{F - days}}{2961^{\circ}\text{F - days}} = 2.12$$

Therefore, the heating load will increase by factor of 2.12 in Denver. Then the annual heating cost of this new house in Denver becomes

$$\text{Annual heating cost in Denver} = 2.12 \times (\text{Annual heating cost in Atlanta}) = 2.12(\$600/\text{yr}) = \mathbf{\$1272}$$

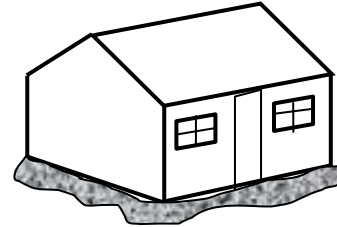

16-146E The annual gas consumption and its cost for a house in Cleveland, Ohio with a design heat load of 65,000 Btu/h and a furnace efficiency of 90% are to be determined.

Assumptions The house is maintained at 72°F at all times during the heating season.

Properties The annual heating degree-days of Cleveland, Ohio is 6351°F-days (Table 16-5). The 97.5% winter design temperature of Cleveland is 5°F.

Analysis The overall heat loss coefficient K_{overall} of the building is determined from

$$\dot{Q}_{\text{design}} = UA\Delta T_{\text{design}} = UA(T_i - T_o)_{\text{design}} = K_{\text{overall}}(T_i - T_o)_{\text{design}}$$

Substituting,

$$K_{\text{overall}} = \frac{\dot{Q}_{\text{design}}}{(T_i - T_o)_{\text{design}}} = \frac{65,000 \text{ Btu/h}}{(72 - 5)^{\circ}\text{F}} = 970 \text{ Btu/h} \cdot ^{\circ}\text{F}$$

Then the annual gas consumption of the house for heating is determined to be

$$\begin{aligned} \text{Annual Gas Consumption} &= \frac{K_{\text{overall}} DD_{\text{heating}}}{\eta_{\text{heating}}} \\ &= \frac{970 \text{ Btu/h} \cdot ^{\circ}\text{F}}{0.90} (6351^{\circ}\text{F - days}) \left(\frac{24 \text{ h}}{1 \text{ day}} \right) \left(\frac{1 \text{ therm}}{100,000 \text{ Btu}} \right) \\ &= 1643 \text{ therms} \end{aligned}$$

Therefore, the house will consume 1643 therms of natural gas for heating.

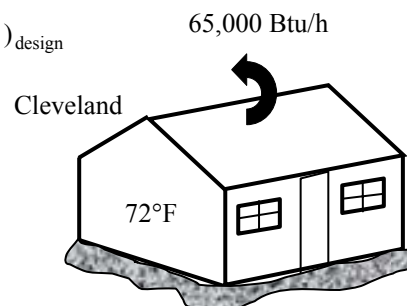

16-147 A house in Boise, Idaho is heated by electric resistance heaters. The amount of money the home owner will save if she lowers the thermostat from 22°C to 14°C every night in December is to be determined.

Assumptions **1** The house is maintained at 22°C during the day, and 14°C for 8 hours at night. **2** The efficiency of electric resistance heating system is 100%.

Properties The annual heating degree-days of Cleveland, Ohio is 6351°F-days (Table 16-5). The 97.5% winter design temperature of Boise is given to be -12°C.

Analysis The overall heat loss coefficient K_{overall} of the building is determined from

$$\dot{Q}_{\text{design}} = UA\Delta T_{\text{design}} = UA(T_i - T_o)_{\text{design}} = K_{\text{overall}}(T_i - T_o)_{\text{design}}$$

Substituting,

$$K_{\text{overall}} = \frac{\dot{Q}_{\text{design}}}{(T_i - T_o)_{\text{design}}} = \frac{38 \text{ kW}}{[72 - (-12)]^\circ\text{C}} = 1.12 \text{ kW}/^\circ\text{C}$$

The rate at which energy is saved at night is

$$\begin{aligned}\dot{Q}_{\text{saved}} &= UA\Delta T_{\text{reduction}} = K_{\text{overall}}\Delta T_{\text{reduction}} \\ &= (1.12 \text{ kW}/^\circ\text{C})(22 - 14)^\circ\text{C} = 8.96 \text{ kW}\end{aligned}$$

Then the energy and cost savings in December due to lowering the thermostat becomes

$$\text{Energy savings} = \dot{Q}_{\text{saved}}\Delta t = (8.96 \text{ kW})(31 \times 8 \text{ h}) = \mathbf{2222 \text{ kWh}}$$

$$\text{Cost savings} = (\text{Energy savings})(\text{Unit cost of energy}) = (2222 \text{ kWh})(\$0.06/\text{kWh}) = \mathbf{\$133}$$

Discussion Note that thermostat setback results in considerable savings in winter, and is commonly used in practice.

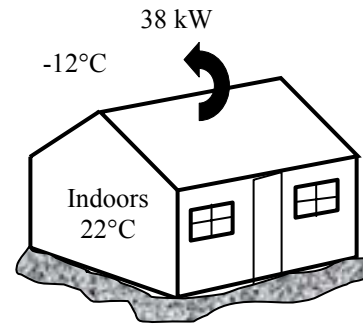

Review Problems

16-148 A decision is to be made between a cheaper but inefficient and an expensive but efficient natural gas heater for a house.

Assumptions The two heaters are comparable in all aspects other than the initial cost and efficiency.

Analysis Other things being equal, the logical choice is the heater that will cost less during its lifetime. The total cost of a system during its lifetime (the initial, operation, maintenance, etc.) can be determined by performing a life cycle cost analysis. A simpler alternative is to determine the simple payback period.

The annual heating cost is given to be \$1100. Noting that the existing heater is 60% efficient, only 60% of that energy (and thus money) is delivered to the house, and the rest is wasted due to the inefficiency of the heater. Therefore, the monetary value of the heating load of the house is

$$\text{Cost of useful heat} = (60\%)(\text{Current annual heating cost}) = 0.60 \times (\$1100/\text{yr}) = \$660/\text{yr}$$

This is how much it would cost to heat this house with a heater that is 100% efficient. For heaters that are less efficient, the annual heating cost is determined by dividing \$660 by the efficiency:

82% heater: Annual cost of heating = (Cost of useful heat)/Efficiency = $(\$660/\text{yr})/0.82 = \$805/\text{yr}$

95% heater: Annual cost of heating = (Cost of useful heat)/Efficiency = $(\$660/\text{yr})/0.95 = \$695/\text{yr}$

Annual cost savings with the efficient heater = $805 - 695 = \$110$

Excess initial cost of the efficient heater = $2700 - 1600 = \$1100$

The simple payback period becomes

$$\text{Simple payback period} = \frac{\text{Excess initial cost}}{\text{Annual cost savings}} = \frac{\$1100}{\$110/\text{yr}} = \mathbf{10 \text{ years}}$$

Therefore, the more efficient heater will pay for the \$1100 cost differential in this case in 10 years, which is more than the 8-year limit. Therefore, the purchase of the cheaper and less efficient heater is indicated in this case.

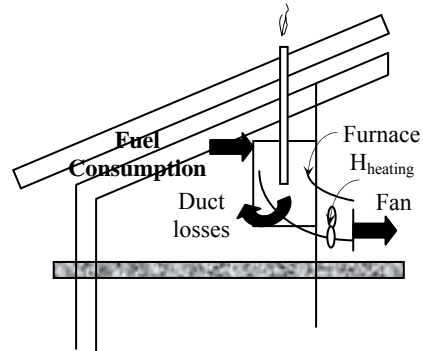

16-149 The convection heat transfer coefficient for a clothed person seated in moving air at a velocity of 0.2 to 4 m/s is given by $h = 8.3V^{0.6}$ where V is in m/s and h is in $\text{W/m}^2\cdot^\circ\text{C}$. The convection coefficients in that range vary from $3.16 \text{ W/m}^2\cdot^\circ\text{C}$ at 0.2 m/s to $19.07 \text{ W/m}^2\cdot^\circ\text{C}$ at 4.0 m/s. Therefore, at low velocities, the radiation and convection heat transfer coefficients are comparable in magnitude. But at high velocities, the convection coefficient is much larger than the radiation heat transfer coefficient.

Velocity, m/s	$h = 8.3V^{0.6}$ $\text{W/m}^2\cdot^\circ\text{C}$
0.0	3.10
0.20	3.16
0.5	5.48
1.00	8.30
1.5	10.59
2.0	12.58
2.5	14.40
3.0	16.05
3.5	17.60
4.0	19.07

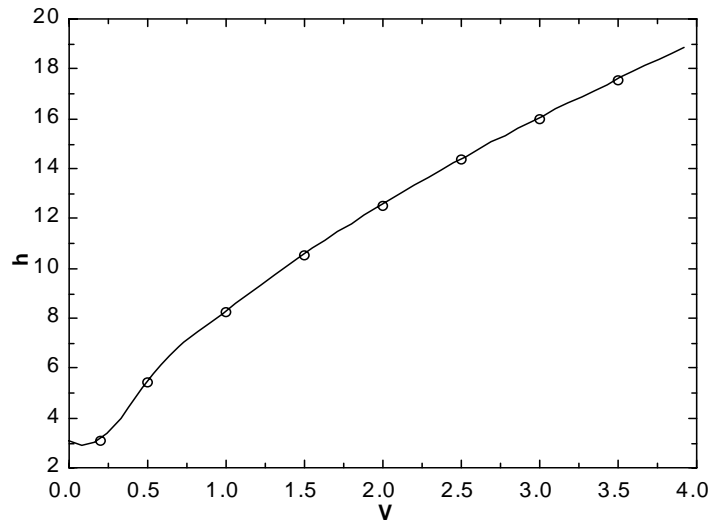

16-150 Workers in a casting facility are surrounded with hot surfaces. The velocity of air needed to provide comfort for the workers is to be determined.

Assumptions **1** The average clothing and exposed skin temperature of the workers is 30°C. **2** The workers are standing in moving air.

Properties The emissivity of the person is 0.95 (Table A-15). The convection heat transfer coefficient for a standing man in air moving with a velocity V is given by $h = 14.8V^{0.69}$ where V is in m/s and h is in $\text{W/m}^2 \cdot ^\circ\text{C}$ (Table 16-3).

Analysis The rate of sensible heat transfer from the person is

$$\dot{Q}_{\text{gen, sensible}} = 0.5 \times \dot{Q}_{\text{gen, total}} = 0.5(300 \text{ W}) = 150 \text{ W}$$

Under steady conditions, and energy balance on the body can be expressed as

$$\dot{E}_{\text{in}} - \dot{E}_{\text{out}} + \dot{E}_{\text{gen}} = 0$$

$$\dot{Q}_{\text{in, radiation}} - \dot{Q}_{\text{out, convection}} + \dot{Q}_{\text{gen, sensible}} = 0$$

or

$$\begin{aligned} \varepsilon A \sigma (T_{\text{surr}}^4 - T_{\text{person}}^4) - h_{\text{conv}} A (T_{\text{person}} - T_{\text{ambient}}) + \dot{Q}_{\text{gen, sensible}} &= 0 \\ 0.95(1.8 \text{ m}^2)(5.67 \times 10^{-8} \text{ W/m}^2 \cdot \text{K}^4)[(40 + 273 \text{ K})^4 - (30 + 273 \text{ K})^4] \\ - h(1.8 \text{ m}^2)(30 - 22)^\circ\text{C} + 150 \text{ W} &= 0 \end{aligned}$$

Solving the equation above for h gives

$$h = 18.3 \text{ W/m}^2 \cdot ^\circ\text{C}$$

Then the velocity of air needed to provide comfort for the workers is determined from $h = 14.8V^{0.69} = 18.3$ to be

$$V = \mathbf{1.36 \text{ m/s}}$$

Therefore, the velocity of air must be at least 1.36 m/s.

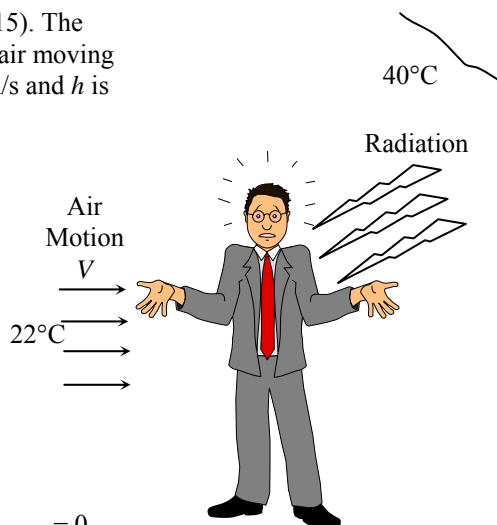

16-151 Switching to energy efficient lighting reduces the electricity consumed for lighting as well as the cooling load in summer, but increases the heating load in winter. It is to be determined if switching to efficient lighting will increase or decrease the total heating and cooling cost of the building whose annual heating load is roughly equal to the annual cooling load.

Assumptions 1 The annual heating load of the building is roughly equal to the annual cooling load. **2** The light escaping through the windows is negligible so that the entire lighting energy becomes part of the internal heat generation.

Analysis Consider 1 h of operation of lighting in summer and 1 h of operation winter.

Current lighting:

$$\text{Lighting cost: (Energy used)(Unit cost)} = (2 \text{ kWh})(\$0.08/\text{kWh}) = \$0.16$$

$$\text{Increase in the air conditioning load:} = 1 \text{ kWh}$$

$$\text{Increase in the air conditioning cost: (Increase in load/COP)(unit cost)} = (1 \text{ kWh}/3.5)(\$0.08/\text{kWh}) = \$0.0229$$

$$\text{Decrease in the heating cost} = (1/29.3 \text{ therm})(\$1.25/\text{therm}) = 0.0427$$

Net cost of 1 h of operation of lighting in summer and 1 h of operation in winter is

$$\begin{aligned} \text{Current net cost} &= \text{Cost of lighting} - \text{Cost of heating} + \text{Cost of Air-conditioning.} \\ &= 0.16 - 0.0427 + 0.0239 \\ &= \mathbf{\$0.14} \end{aligned}$$

(a) *Energy-efficient lighting* (consumes 1/4th of the electricity for the same lighting)

$$\text{Lighting cost: (Energy used)(Unit cost)} = (0.5 \text{ kWh})(\$0.08/\text{kWh}) = \$0.04$$

$$\text{Increase in the air conditioning load:} = 0.25 \text{ kWh}$$

$$\text{Increase in air conditioning cost: (Increase in load/COP)(unit cost)} = (0.25 \text{ kWh}/3.5)(\$0.08/\text{kWh}) = \$0.0057$$

$$\text{Decrease in the heating cost} = (0.25/29.3 \text{ therm})(\$1.25/\text{therm}) = \$0.0107$$

Net cost of 1 h of operation of lighting in summer and 1 h of operation in winter is

$$\begin{aligned} \text{Current net cost} &= \text{Cost of lighting} - \text{Cost of heating} + \text{Cost of Air-conditioning.} \\ &= 0.04 - 0.0057 + 0.0107 \\ &= \mathbf{\$0.045} \end{aligned}$$

Therefore, the energy efficient lighting will reduce the total energy usage and cost of this family considerably.

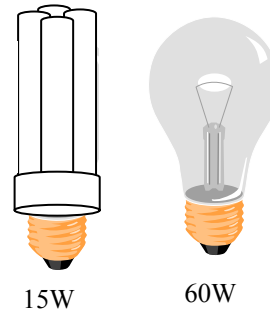

16-152 The outer surfaces of the walls of a brick farmhouse are exposed to 24 km/h winds. The rate of heat transfer through a 20-m² section of the wall is to be determined.

Assumptions 1 Steady operating conditions exist. 2 Heat transfer through the wall is one-dimensional. 3 Thermal properties of the wall and the heat transfer coefficients are constant.

Properties The R-values of different materials are given in Table 16-10.

Analysis The schematic of the wall as well as the different elements used in its construction are shown below. Heat transfer through the insulation and through the studs will meet different resistances, and thus we need to analyze the thermal resistance for each path separately. Once the unit thermal resistances and the U -factors for the insulation and stud sections are available, the overall average thermal resistance for the entire wall can be determined from

$$R_{\text{overall}} = 1/U_{\text{overall}} \quad \text{where} \quad U_{\text{overall}} = (Uf_{\text{area}})_{\text{insulation}} + (Uf_{\text{area}})_{\text{stud}}$$

and the value of the area fraction f_{area} is 0.80 for insulation section and 0.20 for stud section since the headers that constitute a small part of the wall are to be treated as studs. Using the available R -values from Table 16-10 and calculating others, the total R -values for each section is determined in the table below.

Construction	R -value,
	m ² ·°C/W
1. Outside surface, 24 km/h winds	0.030
2. Common brick, 200 mm	0.12×2 = 0.24
3. Inside surface, still air	0.12
TOTAL	0.39

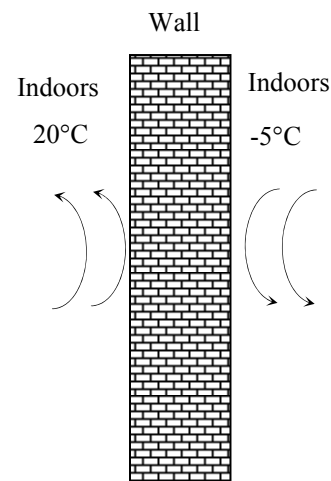

Then the U -factor of the wall after the rate of heat transfer through the wall become

$$U_{\text{wall}} = 1/R_{\text{wall}} = 1/0.39 = 2.56 \text{ m}^2 \cdot \text{°C/W}$$

$$\dot{Q}_{\text{wall}} = UA(T_i - T_o) = (2.56 \text{ W/m}^2 \cdot \text{°C})(20 \text{ m}^2)[20 - (-5)\text{°C}] = \mathbf{1280 \text{ W}}$$

16-153E The R -value and the U -factor of a 45° pitched roof are to be determined.

Assumptions 1 Steady operating conditions exist. 2 Heat transfer through the roof is one-dimensional. 3 Thermal properties of the roof and the heat transfer coefficients are constant.

Properties The R -values of different materials are given in Table 16-10.

Analysis The schematic of the pitched roof as well as the different elements used in its construction are shown below. Using the available R -values from Table 16-10, the overall R -value of the roof can be determined as shown in the table below.

Construction	R -value, $\text{h}\cdot\text{ft}^2\cdot^\circ\text{F}/\text{Btu}$	
	Between studs	At studs
1. Outside surface, 15 mph wind	0.17	0.17
2. Asphalt shingle roofing	0.44	0.44
3. Building paper	0.10	0.10
4. Plywood deck, 5/8 in	0.78	0.78
5a. Reflective air space, 3.5-in	2.17	----
5b. Wood stud, 2 in by 4 in	----	3.58
6. Gypsum wallboard, 0.5 in	0.45	0.45
7. Inside surface, still air	0.63	0.63

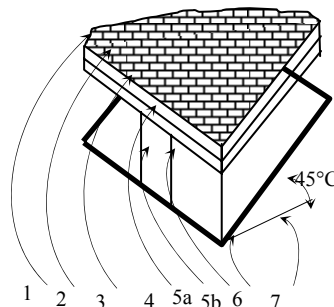

Total unit thermal resistance of each section, R	4.74	6.15
The U -factor of each section, $U = 1/R$, in $\text{Btu}/\text{h}\cdot\text{ft}^2\cdot^\circ\text{F}$	0.211	0.163
Area fraction of each section, f_{area}	0.80	0.20
Overall U -factor, $U = \sum f_{\text{area},i} U_i = 0.80 \times 0.211 + 0.20 \times 0.163$	0.201 $\text{Btu}/\text{h}\cdot\text{ft}^2\cdot^\circ\text{F}$	
Overall unit thermal resistance, $R = 1/U$	4.97 $\text{h}\cdot\text{ft}^2\cdot^\circ\text{F}/\text{Btu}$	

Therefore, the R -value and U -factor of the roof are $R = 4.97 \text{ h}\cdot\text{ft}^2\cdot^\circ\text{F}/\text{Btu}$ and $U = 0.201 \text{ Btu}/\text{h}\cdot\text{ft}^2\cdot^\circ\text{F}$

16-154 Heat losses through the windows of a house with aluminum frame single pane windows account for 26 percent of the total. The reduction in the heat load of the house as a result of switching to vinyl frame double pane windows is to be determined.

Properties The U -factors of the aluminum frame single pane and vinyl frame double pane windows are 7.16 and $2.74 \text{ W}/\text{m}^2\cdot^\circ\text{C}$, respectively.

Analysis The rate of heat transfer through the windows for the existing house is

$$\dot{Q}_{\text{window, old}} = (\text{Fraction of heat loss through windows}) \dot{Q}_{\text{house, total}} = 0.26 \times (32 \text{ kW}) = 8.32 \text{ kW}$$

Then the rate of heat transfer through the new windows becomes

$$\frac{\dot{Q}_{\text{window, new}}}{\dot{Q}_{\text{window, old}}} = \frac{U_{\text{new}} A \Delta T}{U_{\text{old}} A \Delta T}$$

which gives

$$\dot{Q}_{\text{window, new}} = \frac{U_{\text{new}}}{U_{\text{old}}} \dot{Q}_{\text{window, old}} = \frac{2.74}{7.14} (8.32 \text{ kW}) = 3.19 \text{ kW}$$

Therefore, the reduction in the heat load of the house is

$$\dot{Q}_{\text{reduction}} = \dot{Q}_{\text{window, old}} - \dot{Q}_{\text{window, new}} = 8.32 - 3.19 = \mathbf{5.13 \text{ kW}}$$

Discussion Note that the heat load from the house will go down by 16% since $5.13/32 = 0.16$.

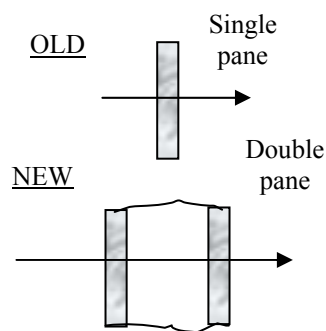

16-155 The attic of a house in Thessaloniki, Greece is not vented in summer. The rate of heat gain through the roof in late July is to be determined assuming the roof is (a) light colored and (b) dark colored.

Assumptions 1 Steady operating conditions exist. 2 Thermal properties of the roof and the heat transfer coefficients are constant. 3 The effect of air infiltration on the attic temperature is negligible (this will result in a higher rate of heat transfer than actual). 4 The sol-air temperature for a horizontal surface can be used for the tilted roof.

Properties The R -values of the roof and the ceiling are given to be $1.4 \text{ m}^2 \cdot ^\circ\text{C}/\text{W}$ and $0.50 \text{ m}^2 \cdot ^\circ\text{C}/\text{W}$, respectively.

Analysis Noting that the roof-to-ceiling area ratio is 1.4, the thermal resistance of the roof-attic-ceiling combination per unit area of the ceiling is

$$R_{\text{total}} = R_{\text{ceiling}} + \left(\frac{A_{\text{ceiling}}}{A_{\text{roof}}} \right) R_{\text{roof}} = 0.50 + \frac{1}{4} 1.40 = 1.50 \text{ m}^2 \cdot ^\circ\text{C}/\text{W}$$

(a) The house is located at 40°N latitude, and thus we can use the sol-air temperature data directly from Table 16-7. At 16:00, the tabulated sol-air temperatures for a light-colored horizontal surface is 42.7°C . Also, the tabulated air temperature is 34.7°C , which is 2.7°C higher than the air temperature given in the problem. But we can still use the data in that table provided that we subtract 2.7°C from all temperatures. Therefore, the sol-air temperature on the roof in this case is $42.7 - 2.7 = 40.0^\circ\text{C}$, and the heat gain through the roof is determined to be

$$\begin{aligned} \dot{Q}_{\text{roof, light color}} &= UA(T_{\text{sol-air, light color}} - T_{\text{inside}}) \\ &= A \frac{T_{\text{sol-air, light color}} - T_{\text{inside}}}{R} \\ &= (150 \text{ m}^2) \frac{(40 - 23)^\circ\text{C}}{1.50 \text{ m}^2 \cdot ^\circ\text{C}/\text{W}} = \mathbf{1700 \text{ W}} \end{aligned}$$

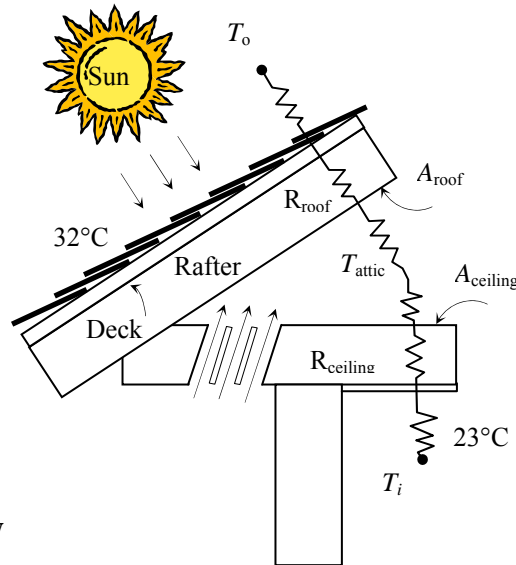

(b) The tabulated sol-air temperatures for a dark-colored horizontal surface is 54.7°C . Therefore, the sol-air temperature on the roof in this case is $54.7 - 2.7 = 52.0^\circ\text{C}$, and the heat gain through the roof is determined to be

$$\begin{aligned} \dot{Q}_{\text{roof, dark color}} &= UA(T_{\text{sol-air, dark color}} - T_{\text{inside}}) \\ &= A \frac{T_{\text{sol-air, dark color}} - T_{\text{inside}}}{R} = (150 \text{ m}^2) \frac{(52 - 23)^\circ\text{C}}{1.50 \text{ m}^2 \cdot ^\circ\text{C}/\text{W}} = \mathbf{2900 \text{ W}} \end{aligned}$$

Discussion Note that the color of the exposed surface of the roof has a major effect on the rate of heat gain through the roof.

16-156 The peak heat loss from a below grade basement in Norfolk, Virginia to the ground through its walls and floor is to be determined.

Assumptions 1 Steady operating conditions exist. 2 The basement is maintained at 17°C.

Properties The winter average temperature of Norfolk is 9.9°C (Table 16-5). The heat transfer coefficients are given in Table 16-14a, and the amplitudes in Fig. 16-37.

Solution The floor and wall areas of the basement are

$$A_{\text{wall}} = \text{Height} \times \text{Perimeter} = 2 \times (1.8 \text{ m})(10 + 19 \text{ m}) = 104.4 \text{ m}^2$$

$$A_{\text{floor}} = \text{Length} \times \text{Width} = (10 \text{ m})(19 \text{ m}) = 190 \text{ m}^2$$

The amplitude of the annual soil temperature is determined from Fig. 16-37 to be 10°C. Then the ground surface temperature for the design heat loss becomes

$$T_{\text{ground surface}} = T_{\text{winter, mean}} - A = 9.9 - 10 = -0.1^\circ\text{C}$$

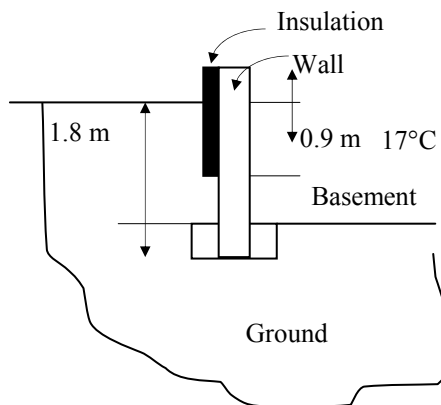

The top 0.9-m section of the wall below the grade is insulated with $R=0.73$, and the heat transfer coefficients through that section are given in Table 16-14a to be 2.87 and 2.20 $\text{W}/\text{m}^2 \cdot ^\circ\text{C}$ through the 1st and 2nd 0.3-m wide depth increments, respectively. The heat transfer coefficients through the uninsulated section of the wall which extends from 0.6 m to 1.8 m level is determined from the same table to be 2.93, 2.23, 1.80, and 1.50 $\text{W}/\text{m}^2 \cdot ^\circ\text{C}$ for each of the remaining 0.3-m wide depth increments. The average overall heat transfer coefficient is

$$U_{\text{wall, ave}} = \frac{\sum U_{\text{wall}}}{\text{No. of increments}} = \frac{2.87 + 2.20 + 2.93 + 2.23 + 1.8 + 1.5}{6} = 2.255 \text{ W}/\text{m}^2 \cdot ^\circ\text{C}$$

Then the heat loss through the basement wall becomes

$$\begin{aligned} \dot{Q}_{\text{basement walls}} &= U_{\text{wall, ave}} A_{\text{wall}} (T_{\text{basement}} - T_{\text{ground surface}}) \\ &= (2.255 \text{ W}/\text{m}^2 \cdot ^\circ\text{C})(104.4 \text{ m}^2)[17 - (-0.1)^\circ\text{C}] = 4026 \text{ W} \end{aligned}$$

The shortest width of the house is 10 m, and the depth of the foundation below grade is 1.8 m. The floor heat transfer coefficient is determined from Table 16-14b to be 0.12 $\text{W}/\text{m}^2 \cdot ^\circ\text{C}$. Then the heat loss through the floor of the basement becomes

$$\begin{aligned} \dot{Q}_{\text{basement floor}} &= U_{\text{floor}} A_{\text{floor}} (T_{\text{basement}} - T_{\text{ground surface}}) \\ &= (0.12 \text{ W}/\text{m}^2 \cdot ^\circ\text{C})(190 \text{ m}^2)[17 - (-0.1)^\circ\text{C}] = 390 \text{ W} \end{aligned}$$

which is considerably less than the heat loss through the wall. The total heat loss from the basement is then determined to be

$$\dot{Q}_{\text{basement}} = \dot{Q}_{\text{basement wall}} + \dot{Q}_{\text{basement floor}} = 4026 + 390 = \mathbf{4416 \text{ W}}$$

Discussion This is the *design* or *peak* rate of heat transfer from below-grade section of the basement, and this is the value to be used when sizing the heating system. The actual heat loss from the basement will be much less than that most of the time.

16-157 A house with a concrete slab floor sits directly on the ground at grade level, and the wall below grade is insulated. The heat loss from the floor at winter design conditions is to be determined.

Assumptions 1 Steady operating conditions exist. 2 The house is maintained at 22°C. 3 The weather in Anchorage is severe.

Properties The 97.5% winter design conditions in Anchorage is -28°C (Table 16-4). The heat transfer coefficient for the insulated wall below grade is $U = 0.86 \text{ W/m}\cdot\text{°C}$ (Table 16-14c).

Solution Heat transfer from a floor on the ground at the grade level is proportional to the perimeter of the floor, and the perimeter in this case is

$$p_{\text{floor}} = 2 \times (\text{Length} + \text{Width}) = 2(15 + 20) \text{ m} = 70 \text{ m}$$

Then the heat loss from the floor becomes

$$\begin{aligned} \dot{Q}_{\text{floor}} &= U_{\text{floor}} p_{\text{floor}} (T_{\text{indoor}} - T_{\text{outdoor}}) \\ &= (0.86 \text{ W/m}\cdot\text{°C})(70 \text{ m})[22 - (-28)]\text{°C} = \mathbf{2890 \text{ W}} \end{aligned}$$

Discussion This is the *design* or *peak* rate of heat transfer from below-grade section of the basement, and this is the value to be used when sizing the heating system. The actual heat loss from the basement will be much less than that most of the time.

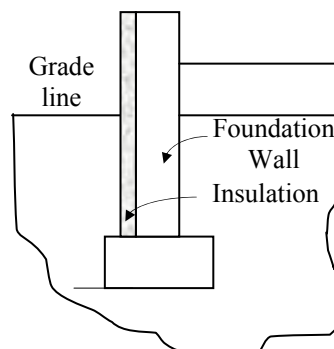

16-158 A house with a concrete slab floor sits directly on the ground at grade level, and the wall below grade is uninsulated. The heat loss from the floor at winter design conditions is to be determined.

Assumptions 1 Steady operating conditions exist. 2 The house is maintained at 22°C. 3 The weather in Anchorage is severe.

Properties The 97.5% winter design conditions in Baltimore is -28°C (Table 16-4). The heat transfer coefficient for the uninsulated wall below grade is $U = 1.17 \text{ W/m}\cdot\text{°C}$ (Table 16-14c).

Analysis Heat transfer from a floor on the ground at the grade level is proportional to the perimeter of the floor, and the perimeter in this case is

$$p_{\text{floor}} = 2 \times (\text{Length} + \text{Width}) = 2(15 + 20) \text{ m} = 70 \text{ m}$$

Then the heat loss from the floor becomes

$$\begin{aligned} \dot{Q}_{\text{floor}} &= U_{\text{floor}} p_{\text{floor}} (T_{\text{indoor}} - T_{\text{outdoor}}) \\ &= (1.17 \text{ W/m}\cdot\text{°C})(70 \text{ m})[22 - (-28)]\text{°C} = \mathbf{3931 \text{ W}} \end{aligned}$$

Discussion This is the *design* or *peak* rate of heat transfer from below-grade section of the basement, and this is the value to be used when sizing the heating system. The actual heat loss from the basement will be much less than that most of the time.

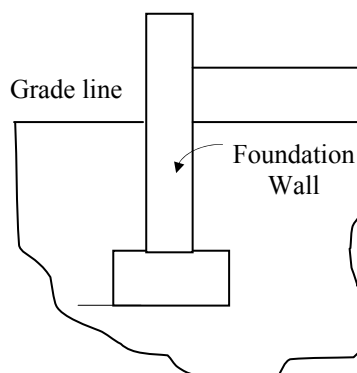

16-159 The classrooms and faculty offices of a university campus are not occupied an average of 4 hours a day, but the lights are kept on. The amounts of electricity and money the campus will save a year if the lights are turned off during unoccupied periods are to be determined.

Analysis The total electric power consumed by the lights in the classrooms and faculty offices is

$$\dot{E}_{\text{lighting, classroom}} = (\text{Power consumed per lamp}) \times (\text{No. of lamps}) = (200 \times 12 \times 110 \text{ W}) = 264,000 = 264 \text{ kW}$$

$$\dot{E}_{\text{lighting, offices}} = (\text{Power consumed per lamp}) \times (\text{No. of lamps}) = (400 \times 6 \times 110 \text{ W}) = 264,000 = 264 \text{ kW}$$

$$\dot{E}_{\text{lighting, total}} = \dot{E}_{\text{lighting, classroom}} + \dot{E}_{\text{lighting, offices}} = 264 + 264 = 528 \text{ kW}$$

Noting that the campus is open 240 days a year, the total number of unoccupied work hours per year is

$$\text{Unoccupied hours} = (4 \text{ hours/day})(240 \text{ days/year}) = 960 \text{ h/yr}$$

Then the amount of electrical energy consumed per year during unoccupied work period and its cost are

$$\text{Energy savings} = (\dot{E}_{\text{lighting, classroom}})(\text{Unoccupied hours}) = (528 \text{ kW})(960 \text{ h/yr}) = \mathbf{506,880 \text{ kWh}}$$

$$\text{Cost savings} = (\text{Energy savings})(\text{Unit cost of energy}) = (506,880 \text{ kWh})(\$0.075/\text{kWh}) = \mathbf{\$38,016/\text{yr}}$$

Discussion Note that simple conservation measures can result in significant energy and cost savings.

16-160E The infiltration rate of a building is estimated to be 0.8 ACH. The sensible, latent, and total infiltration heat loads of the building at sea level are to be determined.

Assumptions 1 Steady operating conditions exist. 2 The air infiltrates at the outdoor conditions, and exfiltrates at the indoor conditions. 3 Excess moisture condenses at 40°F. 4 The effect of water vapor on air density is negligible.

Properties The gas constant and the specific heat of air are $R = 0.3704 \text{ psia} \cdot \text{ft}^3/\text{lbm} \cdot \text{R}$ and $C_p = 0.24 \text{ Btu}/\text{lbm} \cdot \text{°F}$ (Tables A-1E and A-11E). The heat of vaporization of water at 40°F is

$h_{fg} = h_{fg@40^\circ\text{F}} = 1071 \text{ Btu}/\text{lbm}$ (Table A-9E). The properties of the ambient and room air are determined

from the psychrometric chart (Fig. A-13E) to be

$$\left. \begin{array}{l} T_{\text{ambient}} = 82^\circ \text{F} \\ \phi_{\text{ambient}} = 40\% \end{array} \right\} \begin{array}{l} \omega_{\text{ambient}} = 0.094 \text{ lbm}/\text{lbm dry air} \\ v = 13.7 \text{ ft}^3/\text{lbm dry air} \end{array}$$

$$\left. \begin{array}{l} T_{\text{room}} = 74^\circ \text{F} \\ \phi_{\text{room}} = 40\% \end{array} \right\} \omega_{\text{room}} = 0.073 \text{ lbm}/\text{lbm dry air}$$

Analysis Noting that the infiltration of ambient air will cause the air in the cold storage room to be changed 0.8 times every hour, the air will enter the room at a mass flow rate of

$$\dot{m}_{\text{air}} = \frac{V_{\text{room}}}{v_{\text{ambient}}} \text{ACH} = \frac{9 \times 50 \times 60 \text{ ft}^3}{13.7 \text{ ft}^3/\text{lbm dry air}} (0.8 \text{ h}^{-1}) = 176 \text{ lbm/h}$$

Then the sensible, latent, and total infiltration heat loads of the room are

$$\dot{Q}_{\text{infiltration, sensible}} = \dot{m}_{\text{air}} c_p (T_{\text{ambient}} - T_{\text{room}}) = (176 \text{ lbm/h})(0.24 \text{ Btu}/\text{lbm} \cdot \text{°F})(82 - 74)^\circ\text{F} = \mathbf{337 \text{ Btu/h}}$$

$$\dot{Q}_{\text{infiltration, latent}} = \dot{m}_{\text{air}} (\omega_{\text{ambient}} - \omega_{\text{room}}) h_{fg} = (176 \text{ lbm/h})(0.094 - 0.073) (1071 \text{ Btu}/\text{lbm}) = \mathbf{3952 \text{ Btu/h}}$$

$$\dot{Q}_{\text{infiltration}} = \dot{Q}_{\text{infiltration, sensible}} + \dot{Q}_{\text{infiltration, latent}} = 3952 + 337 = \mathbf{4289 \text{ Btu/h}}$$

Discussion The specific volume of the dry air at the ambient conditions could also be determined from the ideal gas relation, $v = RT/P = (0.3704 \text{ psia} \cdot \text{ft}^3/\text{lbm} \cdot \text{R})(82 + 460 \text{ R})/14.7 \text{ psia} = 13.7 \text{ ft}^3/\text{lbm}$.

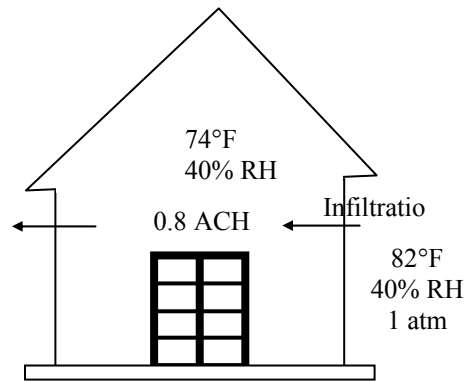

16-161 It is believed that January is the coldest month in the Northern hemisphere. On the basis of Table 16-5, it is to be determined if this is true for all locations.

Analysis Degree-days is a measure of coldness of a location. We notice from Table 16-5 that in Atlanta, Georgia the heating degree-days are 648°F-days in December and 636°F-days in January. Therefore, January is **not** necessarily the coldest month in Northern Hemisphere.

16-162 The December space heating bill of a fully occupied house is given. The heating bill of this house is to be determined if it were not occupied.

Assumptions The outdoors temperature never rises above 18°C in January.

Properties The heating degree-days for Louisville, Kentucky for the month of January is 890°F-days (Table 16-5). It is equivalent to $890/1.8 = 494^\circ\text{C-days}$.

Analysis The degree-days method is based on the assumption that the internal heat gain can meet the heating needs of a house when the outdoors temperature is above 18°C. Therefore, for an indoor temperature of 22°C, the number of degree-days that correspond to the temperature range of 18 to 22°C is

$$DD_{\text{internal}} = (22 - 18)^\circ\text{C}(31 \text{ days}) = 124^\circ\text{C-days}$$

Then the total °C-days for an unoccupied building becomes

$$DD_{\text{total}} = DD_{\text{standard}} + DD_{\text{internal}} = 494 + 124 = 618^\circ\text{C-days}$$

Noting that $618/494 = 1.251$, we conclude that the number of heating degree-days and thus the heating bill in January will increase by 25.1%. Therefore, the January heating bill for the unoccupied house will be

$$\begin{aligned} \text{Heating bill of unoccupied house} &= 1.251 \times (\text{Heating bill of occupied house}) \\ &= 1.251 \times \$110 = \mathbf{\$138} \end{aligned}$$

Discussion Note that the heating bill of this house will increase by 25.1% in the absence of any internal heat gain.

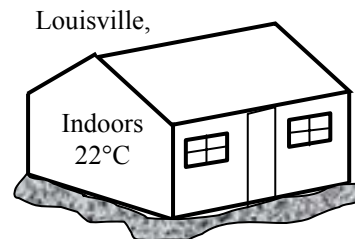

16-163 The annual gas consumption and its cost for a house in Charlotte, NC with a design heat load of 28 kW and a furnace efficiency of 80% are to be determined.

Assumptions The house is maintained at 22°C at all times during the heating season.

Properties The annual heating degree-days of Charlotte, NC is 3191°F-days (Table 16-5). It is equivalent to $3191/1.8 = 1773^\circ\text{C}$ -days. The 97.5% winter design temperature of Charlotte is -6°C .

Analysis (a) The overall heat loss coefficient K_{overall} of the building is determined from

$$\dot{Q}_{\text{design}} = UA\Delta T_{\text{design}} = UA(T_i - T_o)_{\text{design}} = K_{\text{overall}}(T_i - T_o)_{\text{design}}$$

Substituting,

$$K_{\text{overall}} = \frac{\dot{Q}_{\text{design}}}{(T_i - T_o)_{\text{design}}} = \frac{28,000 \text{ W}}{[22 - (-6)]^\circ\text{C}} = 1000 \text{ W} = \mathbf{1 \text{ kW}/^\circ\text{C}}$$

(b) The annual gas consumption of the house for heating and its cost are determined to be

$$\begin{aligned} \text{Annual Gas Consumption} &= \frac{K_{\text{overall}}}{\eta_{\text{heating}}} DD_{\text{heating}} \\ &= \frac{1000 \text{ W}/^\circ\text{C}}{0.80} (1773^\circ\text{C} \cdot \text{days}) \left(\frac{24 \times 3600 \text{ s}}{1 \text{ day}} \right) \\ &= 1.915 \times 10^8 = \mathbf{1815 \text{ therms}} \quad (\text{since } 1 \text{ therm} = 105,500 \text{ kJ}) \end{aligned}$$

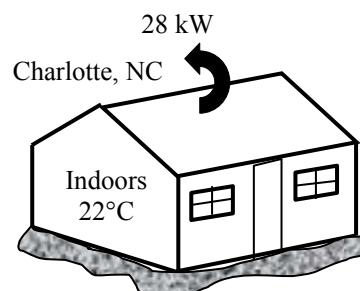

Then the annual heating cost becomes

$$\begin{aligned} \text{Annual heating cost} &= (\text{Annual energy consumption})(\text{Unit cost of energy}) \\ &= (1815 \text{ therms/year})(\$1.20/\text{therm}) = \mathbf{\$2178/\text{year}} \end{aligned}$$

Therefore, it will cost \$2178 per year to heat this house.

16-164 16-171 Computer, Design, and Essay Problems



Chapter 17

REFRIGERATION AND FREEZING OF FOODS

Control of Microorganisms in Foods

17-1C The common kinds of microorganisms are bacteria, yeasts, molds, and viruses. The undesirable changes caused by microorganisms are off-flavors and colors, slime production, changes in the texture and appearances, and the spoilage of foods.

17-2C Microorganisms are the prime cause for the spoilage of foods. Refrigeration prevents or delays the spoilage of foods by reducing the rate of growth of microorganisms. Freezing extends the storage life of foods for months by preventing the growths of microorganisms.

17-3C The environmental factors that affect of the growth rate of microorganisms are the temperature, the relative humidity, the oxygen level of the environment, and air motion.

17-4C Cooking kills the microorganisms in foods, and thus prevents spoilage of foods. It is important to raise the internal temperature of a roast in an oven above 70°C. since most microorganisms, including some that cause diseases, may survive temperatures below 70°C.

17-5C The contamination of foods with microorganisms can be prevented or minimized by (1) preventing contamination by following strict sanitation practices such as washing hands and using fine filters in ventilation systems, (2) inhibiting growth by altering the environmental conditions, and (3) destroying the organisms by heat treatment or chemicals.

The growth of microorganisms in foods can be retarded by keeping the temperature below 4°C and relative humidity below 60 percent. Microorganisms can be destroyed by heat treatment, chemicals, ultraviolet light, and solar radiation.

17-6C (a) High air motion retards the growth of microorganisms in foods by keeping the food surfaces dry, and creating an undesirable environment for the microorganisms. (b) Low relative humidity (dry) environments also retard the growth of microorganisms by depriving them of water that they need to grow. Moist air supplies the microorganisms with the water they need, and thus encourages their growth. Relative humidities below 60 percent prevent the growth rate of most microorganisms on food surfaces.

Refrigeration and Freezing of Foods

17-7C Both freezing and chilling injury refers to the tissue damage that occurs in fruits and vegetables when they are exposed to low temperatures for a long time. However, freezing injury occurs at subfreezing temperatures whereas chilling injury occurs at above freezing temperatures.

17-8C The rate of freezing affects the size and number of ice crystals formed in foods during freezing. During slow freezing, ice crystals grow to a large size, damaging the walls of the cells and causing the loss of natural juices and sagging of foods. During fast freezing, a large number of ice crystals start forming at once, and thus the size of ice crystals is much smaller than that in slow freezing, causing minimal damage. Also, fast freezing forms a crust on the outer layer of the food product that prevents dehydration, and keeps all the flavoring agents sealed in foods.

17-9C The loss of moisture from fresh fruits and vegetables is called transpiration. A lettuce has a higher transpiration coefficient than an apple since the lettuce loses its moisture much faster than the apple in the same environment.

17-10C The mechanisms of heat transfer involved during the cooling of fruits and vegetables by refrigerated air are convection, radiation, and evaporation.

17-11C The four primary methods of freezing of foods are air-blast freezing, contact freezing, immersion freezing, and cryogenic freezing.

17-12C Air-blast freezing involves the blowing of high velocity air at about -30°C over the food products, and thus heat transfer from the foods to the metal plates by convection. In contact freezing, on the other hand, the food is sandwiched between two metal plates, and heat is transferred from the food to the cold metal plates by conduction.

17-13C Cryogenic freezing is the freezing of foods by dropping them into a cryogenic fluid bath such as liquid nitrogen or liquid (or solid) carbon dioxide. The typical temperature for cryogenic freezing is about -195°C . Immersion freezing also involves the freezing of foods by dropping them into a fluid at subfreezing temperature, but the fluid temperature in this case is much higher (such as brine at -20°C).

17-14C Air-blast freezing is much more likely to cause dehydration in foods since the vapor pressure in air is usually much lower than the vapor pressure in food, and this vapor pressure difference will tend to drive moisture out of foods. Cryogenic freezing, on the other hand, will immediately form a crust at the outer layer of the food, that will seal moisture in.

17-15 The center temperature of potatoes is to be lowered to 6°C during cooling. The cooling time and if any part of the potatoes will suffer chilling injury during this cooling process are to be determined.

Assumptions 1 The potatoes are spherical in shape with a radius of $r_0 = 3$ cm. **2** Heat conduction in the potato is one-dimensional in the radial direction because of the symmetry about the midpoint. **3** The thermal properties of the potato are constant. **4** The heat transfer coefficient is constant and uniform over the entire surface. **5** The Fourier number is $\tau > 0.2$ so that the one-term approximate solutions (or the transient temperature charts) are applicable (this assumption will be verified).

Properties The thermal conductivity and thermal diffusivity of potatoes are given to be $k = 0.50$ W/m·°C and $\alpha = 0.13 \times 10^{-6}$ m²/s.

Analysis The time required to cool the midsection of the potatoes to $T_0 = 6^\circ\text{C}$ is determined from the one-term solution relation for spheres presented in Chap. 4. First we find the Biot number:

$$\text{Bi} = \frac{hr_0}{k} = \frac{(19 \text{ W/m}^2 \cdot ^\circ\text{C})(0.03 \text{ m})}{0.5 \text{ W/m} \cdot ^\circ\text{C}} = 1.14$$

From Table 4-2 we read, for a sphere, $\lambda_1 = 1.635$ and $A_1 = 1.302$.

Substituting these values into the one-term solution gives

$$\theta_0 = \frac{T_0 - T_\infty}{T_i - T_\infty} = A_1 e^{-\lambda_1^2 \tau} \rightarrow \frac{6-2}{25-2} = 1.302 e^{-(1.635)^2 \tau} \rightarrow \tau = 0.753$$

which is greater than 0.2 and thus the one-term solution is applicable.

Then the cooling time becomes

$$\tau = \frac{\alpha t}{r_0^2} \rightarrow t = \frac{\tau r_0^2}{\alpha} = \frac{(0.753)(0.03 \text{ m})^2}{0.13 \times 10^{-6} \text{ m}^2/\text{s}} = 5213 \text{ s} = \mathbf{1.45 \text{ h}}$$

The lowest temperature during cooling will occur on the surface ($r/r_0 = 1$), and is determined to be

$$\frac{T(r) - T_\infty}{T_i - T_\infty} = A_1 e^{-\lambda_1^2 \tau} \frac{\sin(\lambda_1 r / r_0)}{\lambda_1 r / r_0} \rightarrow \frac{T(r_0) - T_\infty}{T_i - T_\infty} = \theta_0 \frac{\sin(\lambda_1 r_0 / r_0)}{\lambda_1 r_0 / r_0} = \frac{T_0 - T_\infty}{T_i - T_\infty} \frac{\sin(\lambda_1 r_0 / r_0)}{\lambda_1 r_0 / r_0}$$

Substituting,

$$\frac{T(r_0) - 2}{25 - 2} = \frac{6 - 2}{25 - 2} \frac{\sin(1.635 \text{ rad})}{1.635} \rightarrow T(r_0) = 4.44^\circ\text{C}$$

which is above the temperature range of 3 to 4°C for chilling injury for potatoes. Therefore, **no part** of the potatoes will experience chilling injury during this cooling process.

Alternative solution We could also solve this problem using transient temperature charts as follows:

$$\left. \begin{aligned} \frac{1}{\text{Bi}} = \frac{k}{hr_0} = \frac{0.50 \text{ W/m} \cdot ^\circ\text{C}}{(19 \text{ W/m}^2 \cdot ^\circ\text{C})(0.03 \text{ m})} = 0.877 \\ \frac{T_0 - T_\infty}{T_i - T_\infty} = \frac{6 - 2}{25 - 2} = 0.174 \end{aligned} \right\} \tau = \frac{\alpha t}{r_0^2} = 0.75 \quad (\text{Fig. 4-17a})$$

$$\text{Therefore, } t = \frac{\tau r_0^2}{\alpha} = \frac{(0.75)(0.03)^2}{0.13 \times 10^{-6} \text{ m}^2/\text{s}} = 5192 \text{ s} \cong \mathbf{1.44 \text{ h}}$$

The surface temperature is determined from

$$\left. \begin{aligned} \frac{1}{\text{Bi}} = \frac{k}{hr_0} = 0.877 \\ \frac{r}{r_0} = 1 \end{aligned} \right\} \frac{T(r) - T_\infty}{T_0 - T_\infty} = 0.6 \quad (\text{Fig. 4-17b})$$

$$\text{which gives } T_{\text{surface}} = T_\infty + 0.6(T_0 - T_\infty) = 2 + 0.6(6 - 2) = 4.4^\circ\text{C}$$

The slight difference between the two results is due to the reading error of the charts.

17-16E The center temperature of oranges is to be lowered to 40°F during cooling. The cooling time and if any part of the oranges will freeze during this cooling process are to be determined.

Assumptions 1 The oranges are spherical in shape with a radius of $r_o = 1.25 \text{ in} = 0.1042 \text{ ft}$. **2** Heat conduction in the orange is one-dimensional in the radial direction because of the symmetry about the midpoint. **3** The thermal properties of the orange are constant. **4** The heat transfer coefficient is constant and uniform over the entire surface. **5** The Fourier number is $\tau > 0.2$ so that the one-term approximate solutions (or the transient temperature charts) are applicable (this assumption will be verified).

Properties The thermal conductivity and thermal diffusivity of oranges are given to be $k = 0.26 \text{ Btu/h}\cdot\text{ft}\cdot^\circ\text{F}$ and $\alpha = 1.4 \times 10^{-6} \text{ ft}^2/\text{s}$.

Analysis The time required to cool the midsection of the oranges to $T_o = 40^\circ\text{F}$ is determined from the one-term solution relation for spheres presented in Chap. 4. First we find the Biot number:

$$\text{Bi} = \frac{hr_o}{k} = \frac{(4.6 \text{ Btu/h}\cdot\text{ft}^2\cdot^\circ\text{F})(1.25/12 \text{ ft})}{0.26 \text{ Btu/h}\cdot\text{ft}\cdot^\circ\text{F}} = 1.843$$

From Table 4-2 we read, for a sphere, $\lambda_1 = 1.9569$ and $A_1 = 1.447$.

Substituting these values into the one-term solution gives

$$\theta_0 = \frac{T_o - T_\infty}{T_i - T_\infty} = A_1 e^{-\lambda_1^2 \tau} \rightarrow \frac{40 - 25}{78 - 25} = 1.447 e^{-(1.9569)^2 \tau} \rightarrow \tau = 0.426$$

which is greater than 0.2 and thus the one-term solution is applicable.

Then the cooling time becomes

$$\tau = \frac{\alpha t}{r_o^2} \rightarrow t = \frac{\tau r_o^2}{\alpha} = \frac{(0.426)(1.25/12 \text{ ft})^2}{1.4 \times 10^{-6} \text{ ft}^2/\text{s}} = 3302 \text{ s} = \mathbf{55.0 \text{ min}}$$

The lowest temperature during cooling will occur on the surface ($r/r_o = 1$), and is determined to be

$$\frac{T(r) - T_\infty}{T_i - T_\infty} = A_1 e^{-\lambda_1^2 \tau} \frac{\sin(\lambda_1 r / r_o)}{\lambda_1 r / r_o} \rightarrow \frac{T(r_o) - T_\infty}{T_i - T_\infty} = \theta_0 \frac{\sin(\lambda_1 r_o / r_o)}{\lambda_1 r_o / r_o} = \frac{T_o - T_\infty}{T_i - T_\infty} \frac{\sin(\lambda_1 r_o / r_o)}{\lambda_1 r_o / r_o}$$

Substituting,

$$\frac{T(r_o) - 25}{78 - 25} = \frac{40 - 25}{78 - 25} \frac{\sin(1.9569 \text{ rad})}{1.9569} \rightarrow T(r_o) = 32.1^\circ\text{F}$$

which is above the freezing temperature of 31°C for oranges. Therefore, no part of the oranges will freeze during this cooling process.

Alternative solution We could also solve this problem using transient temperature charts as follows:

$$\left. \begin{aligned} \frac{1}{\text{Bi}} = \frac{k}{hr_o} &= \frac{0.26 \text{ Btu/h}\cdot\text{ft}\cdot^\circ\text{F}}{(4.6 \text{ Btu/h}\cdot\text{ft}^2\cdot^\circ\text{F})(1.25/12 \text{ ft})} = 0.543 \\ \frac{T_o - T_\infty}{T_i - T_\infty} &= \frac{40 - 25}{78 - 25} = 0.283 \end{aligned} \right\} \tau = \frac{\alpha t}{r_o^2} = 0.43 \quad (\text{Fig.4-17a})$$

$$\text{Therefore, } t = \frac{\tau r_o^2}{\alpha} = \frac{(0.43)(1.25/12 \text{ ft})^2}{1.4 \times 10^{-6} \text{ ft}^2/\text{s}} = 3333 \text{ s} = 55.5 \text{ min}$$

The lowest temperature during cooling will occur on the surface ($r/r_o = 1$) of the oranges is determined to be

$$\left. \begin{aligned} \frac{1}{\text{Bi}} = \frac{k}{hr_o} &= 0.543 \\ \frac{r}{r_o} &= 1 \end{aligned} \right\} \frac{T(r) - T_\infty}{T_o - T_\infty} = 0.45 \quad (\text{Fig.4-17b})$$

which gives

$$T_{\text{surface}} = T_\infty + 0.45(T_o - T_\infty) = 25 + 0.45(40 - 25) = 31.8^\circ\text{F}$$

The slight difference between the two results is due to the reading error of the charts.

17-17 The center temperature of a beef carcass is to be lowered to 4°C during cooling. The cooling time and if any part of the carcass will suffer freezing injury during this cooling process are to be determined.

Assumptions 1 The beef carcass can be approximated as a cylinder with insulated top and base surfaces having a radius of $r_o = 12$ cm and a height of $H = 1.4$ m. **2** Heat conduction in the carcass is one-dimensional in the radial direction because of the symmetry about the centerline. **3** The thermal properties of the carcass are constant. **4** The heat transfer coefficient is constant and uniform over the entire surface. **5** The Fourier number is $\tau > 0.2$ so that the one-term approximate solutions (or the transient temperature charts) are applicable (this assumption will be verified).

Properties The thermal conductivity and thermal diffusivity of carcass are given to be $k = 0.47$ W/m·°C and $\alpha = 0.13 \times 10^{-6}$ m²/s.

Analysis The time required to cool the midsection of the carcass to $T_o = 6^\circ\text{C}$ is determined from the one-term solution relation for spheres presented in Chap. 4. First we find the Biot number:

$$\text{Bi} = \frac{hr_o}{k} = \frac{(22 \text{ W/m}^2 \cdot ^\circ\text{C})(0.12 \text{ m})}{0.47 \text{ W/m} \cdot ^\circ\text{C}} = 5.62$$

From Table 4-2 we read, for a cylinder, $\lambda_1 = 2.027$ and $A_1 = 1.517$.

Substituting these values into the one-term solution gives

$$\theta_0 = \frac{T_o - T_\infty}{T_i - T_\infty} = A_1 e^{-\lambda_1^2 \tau} \rightarrow \frac{4 - (-6)}{37 - (-6)} = 1.517 e^{-(2.027)^2 \tau} \rightarrow \tau = 0.456$$

which is greater than 0.2 and thus the one-term solution is applicable.

Then the cooling time becomes

$$\tau = \frac{\alpha t}{r_o^2} \rightarrow t = \frac{\tau r_o^2}{\alpha} = \frac{(0.456)(0.12 \text{ m})^2}{0.13 \times 10^{-6} \text{ m}^2/\text{s}} = 50,510 \text{ s} = \mathbf{14.0 \text{ h}}$$

The lowest temperature during cooling will occur on the surface ($r/r_o = 1$), and is determined to be

$$\frac{T(r) - T_\infty}{T_i - T_\infty} = A_1 e^{-\lambda_1^2 \tau} J_0(\lambda_1 r / r_o) \rightarrow \frac{T(r_o) - T_\infty}{T_i - T_\infty} = \theta_0 J_0(\lambda_1 r / r_o) = \frac{T_o - T_\infty}{T_i - T_\infty} J_0(\lambda_1 r_o / r_o)$$

Substituting,

$$\frac{T(r_o) - (-6)}{37 - (-6)} = \frac{4 - (-6)}{37 - (-6)} J_0(\lambda_1) = 0.2326 \times 0.2084 = 0.0485 \rightarrow T(r_o) = -3.9^\circ\text{C}$$

which is below the freezing temperature of -1.7°C . Therefore, the outer part of the beef carcass will freeze during this cooling process.

Alternative solution We could also solve this problem using transient temperature charts as follows:

$$\left. \begin{aligned} \frac{1}{\text{Bi}} = \frac{k}{hr_o} &= \frac{0.47 \text{ W/m} \cdot ^\circ\text{C}}{(22 \text{ W/m}^2 \cdot ^\circ\text{C})(0.12 \text{ m})} = 0.178 \\ \frac{T_o - T_\infty}{T_i - T_\infty} &= \frac{4 - (-6)}{37 - (-6)} = 0.23 \end{aligned} \right\} \tau = \frac{\alpha t}{r_o^2} = 0.4 \quad (\text{Fig. 4-16})$$

$$\text{Therefore, } t = \frac{\tau r_o^2}{\alpha} = \frac{(0.4)(0.12 \text{ m})^2}{0.13 \times 10^{-6} \text{ m}^2/\text{s}} = 44,308 \text{ s} \cong \mathbf{12.3 \text{ h}}$$

The surface temperature is determined from

$$\left. \begin{aligned} \frac{1}{\text{Bi}} = \frac{k}{hr_o} &= 0.178 \\ \frac{r}{r_o} &= 1 \end{aligned} \right\} \frac{T(r) - T_\infty}{T_o - T_\infty} = 0.17 \quad (\text{Fig. 4-16})$$

$$\text{which gives } T_{\text{surface}} = T_\infty + 0.17(T_o - T_\infty) = -6 + 0.17[4 - (-6)] = -4.3^\circ\text{C}$$

The slight difference between the two results is due to the reading error of the charts.

17-18 The center temperature of meat slabs is to be lowered to -18°C during cooling. The cooling time and the surface temperature of the slabs at the end of the cooling process are to be determined.

Assumptions 1 The meat slabs can be approximated as very large plane walls of half-thickness $L = 11.5$ cm. **2** Heat conduction in the meat slabs is one-dimensional because of the symmetry about the centerplane. **3** The thermal properties of the meat slabs are constant. **4** The heat transfer coefficient is constant and uniform over the entire surface. **5** The Fourier number is $\tau > 0.2$ so that the one-term approximate solutions (or the transient temperature charts) are applicable (this assumption will be verified). **6** The phase change effects are not considered, and thus the actual cooling time will be much longer than the value determined.

Properties The thermal conductivity and thermal diffusivity of meat slabs are given to be $k = 0.47 \text{ W/m}\cdot^{\circ}\text{C}$ and $\alpha = 0.13 \times 10^{-6} \text{ m}^2/\text{s}$. These properties will be used for both fresh and frozen meat.

Analysis The time required to cool the midsection of the meat slabs to $T_o = -18^{\circ}\text{C}$ is determined from the one-term solution relation for infinite plane walls presented in Chap. 4. First we find the Biot number:

$$\text{Bi} = \frac{hr_o}{k} = \frac{(20 \text{ W/m}^2 \cdot ^{\circ}\text{C})(0.115 \text{ m})}{0.47 \text{ W/m}\cdot^{\circ}\text{C}} = 4.89$$

From Table 4-2 we read, for a plane wall, $\lambda_1 = 1.308$ and $A_1 = 1.239$.

Substituting these values into the one-term solution gives

$$\theta_o = \frac{T_o - T_{\infty}}{T_i - T_{\infty}} = A_1 e^{-\lambda_1^2 \tau} \rightarrow \frac{-18 - (-30)}{7 - (-30)} = 1.239 e^{-(1.308)^2 \tau} \rightarrow \tau = 0.783$$

which is greater than 0.2 and thus the one-term solution is applicable.

Then the cooling time becomes

$$\tau = \frac{\alpha t}{L^2} \rightarrow t = \frac{\tau L^2}{\alpha} = \frac{(0.783)(0.115 \text{ m})^2}{0.13 \times 10^{-6} \text{ m}^2/\text{s}} = 79,650 \text{ s} = \mathbf{22.1 \text{ h}}$$

The lowest temperature during cooling will occur on the surface ($x/L = 1$), and is determined to be

$$\frac{T(x) - T_{\infty}}{T_i - T_{\infty}} = A_1 e^{-\lambda_1^2 \tau} \cos(\lambda_1 x / L) \rightarrow \frac{T(L) - T_{\infty}}{T_i - T_{\infty}} = \theta_o \cos(\lambda_1 L / L) = \frac{T_o - T_{\infty}}{T_i - T_{\infty}} \cos(\lambda_1)$$

Substituting,

$$\frac{T(L) - (-30)}{7 - (-30)} = \frac{-18 - (-30)}{7 - (-30)} \cos(\lambda_1) = 0.3243 \times 0.2598 = 0.0219 \rightarrow T(L) = \mathbf{-29.2^{\circ}\text{C}}$$

which is very close the temperature of the refrigerated air.

Alternative solution We could also solve this problem using transient temperature charts as follows:

$$\left. \begin{aligned} \frac{1}{\text{Bi}} = \frac{k}{hL} &= \frac{0.47 \text{ W/m}\cdot^{\circ}\text{C}}{(20 \text{ W/m}^2 \cdot ^{\circ}\text{C})(0.115 \text{ m})} = 0.204 \\ \frac{T_o - T_{\infty}}{T_i - T_{\infty}} &= \frac{-18 - (-30)}{7 - (-30)} = 0.324 \end{aligned} \right\} \tau = \frac{\alpha t}{L^2} = 0.75 \quad (\text{Fig.4-15})$$

$$\text{Therefore, } t = \frac{\tau r_o^2}{\alpha} = \frac{(0.75)(0.115 \text{ m})^2}{0.13 \times 10^{-6} \text{ m}^2/\text{s}} = 76,300 \text{ s} \cong 21.2 \text{ h}$$

The surface temperature is determined from

$$\left. \begin{aligned} \frac{1}{\text{Bi}} = \frac{k}{hL} &= 0.204 \\ \frac{x}{L} &= 1 \end{aligned} \right\} \frac{T(x) - T_{\infty}}{T_o - T_{\infty}} = 0.22 \quad (\text{Fig.4-15})$$

$$\text{which gives } T_{\text{surface}} = T_{\infty} + 0.22(T_o - T_{\infty}) = -30 + 0.22[-18 - (-30)] = \mathbf{-27.4^{\circ}\text{C}}$$

The slight difference between the two results is due to the reading error of the charts.

17-19E The center temperature of meat slabs is to be lowered to 36°F during 12-h of cooling. The average heat transfer coefficient during this cooling process is to be determined.

Assumptions 1 The meat slabs can be approximated as very large plane walls of half-thickness $L = 3$ -in. **2** Heat conduction in the meat slabs is one-dimensional because of symmetry about the centerplane. **3** The thermal properties of the meat slabs are constant. **4** The heat transfer coefficient is constant and uniform over the entire surface. **5** The Fourier number is $\tau > 0.2$ so that the one-term approximate solutions (or the transient temperature charts) are applicable (this assumption will be verified).

Properties The thermal conductivity and thermal diffusivity of meat slabs are given to be $k = 0.26$ Btu/h·ft·°F and $\alpha = 1.4 \times 10^{-6}$ ft²/s.

Analysis The average heat transfer coefficient during this cooling process is determined from the transient temperature charts in Chap. 4 for a flat plate as follows:

$$\left. \begin{aligned} \tau &= \frac{\alpha t}{L^2} = \frac{(1.4 \times 10^{-6} \text{ ft}^2/\text{s})(12 \times 3600 \text{ s})}{(0.25 \text{ ft})^2} = 0.968 \\ \frac{T_o - T_\infty}{T_i - T_\infty} &= \frac{36 - 23}{50 - 23} = 0.481 \end{aligned} \right\} \frac{1}{Bi} = 0.7 \quad (\text{Fig.4-15})$$

Therefore,

$$h = \frac{kBi}{L} = \frac{(0.26 \text{ Btu/h}\cdot\text{ft}\cdot^\circ\text{F})(1/0.7)}{0.25 \text{ ft}} = \mathbf{1.5 \text{ Btu/h}\cdot\text{ft}\cdot^\circ\text{F}}$$

Discussion We could avoid the uncertainty associated with the reading of the charts and obtain a more accurate result by using the one-term solution relation for an infinite plane wall, but it would require a trial and error approach since the Bi number is not known.

17-20 Chickens are to be chilled by holding them in agitated brine for 2.5 h. The center and surface temperatures of the chickens are to be determined, and if any part of the chickens will freeze during this cooling process is to be assessed.

Assumptions 1 The chickens are spherical in shape. **2** Heat conduction in the chickens is one-dimensional in the radial direction because of symmetry about the midpoint. **3** The thermal properties of the chickens are constant. **4** The heat transfer coefficient is constant and uniform over the entire surface. **5** The Fourier number is $\tau > 0.2$ so that the one-term approximate solutions (or the transient temperature charts) are applicable (this assumption will be verified). **6** The phase change effects are not considered, and thus the actual the temperatures will be much higher than the values determined since a considerable part of the cooling process will occur during phase change (freezing of chicken).

Properties The thermal conductivity, thermal diffusivity, and density of chickens are given to be $k = 0.45$ W/m \cdot °C, $\alpha = 0.13 \times 10^{-6}$ m²/s, and $\rho = 950$ kg/m³. These properties will be used for both fresh and frozen chicken.

Analysis We first find the volume and equivalent radius of the chickens:

$$V = m / \rho = (1700\text{g}) / (0.95\text{g/cm}^3) = 1789\text{cm}^3$$

$$r_o = \left(\frac{3}{4\pi} V \right)^{1/3} = \left(\frac{3}{4\pi} 1789\text{cm}^3 \right)^{1/3} = 7.53\text{cm} = 0.0753\text{m}$$

Then the Biot and Fourier numbers become

$$\text{Bi} = \frac{hr_o}{k} = \frac{(440\text{W/m}^2\cdot\text{°C})(0.0753\text{m})}{0.43\text{W/m}\cdot\text{°C}} = 73.6$$

$$\tau = \frac{\alpha t}{r_o^2} = \frac{(0.13 \times 10^{-6}\text{m}^2/\text{s})(2.5 \times 3600\text{s})}{(0.0753\text{m})^2} = 0.207$$

Note that $\tau = 0.207 > 0.2$, and thus the one-term solution is applicable.

From Table 4-2 we read, for a sphere, $\lambda_1 = 3.094$ and $A_1 = 1.999$. Substituting these values into the one-term solution gives

$$\theta_0 = \frac{T_o - T_\infty}{T_i - T_\infty} = A_1 e^{-\lambda_1^2 \tau} \rightarrow \frac{T_o - (-10)}{15 - (-10)} = 1.999 e^{-(3.094)^2 (0.207)} = 0.276 \rightarrow T_o = -3.1^\circ\text{C}$$

The lowest temperature during cooling will occur on the surface ($r/r_o = 1$), and is determined to be

$$\frac{T(r) - T_\infty}{T_i - T_\infty} = A_1 e^{-\lambda_1^2 \tau} \frac{\sin(\lambda_1 r / r_o)}{\lambda_1 r / r_o} \rightarrow \frac{T(r_o) - T_\infty}{T_i - T_\infty} = \theta_0 \frac{\sin(\lambda_1 r_o / r_o)}{\lambda_1 r_o / r_o} = \frac{T_o - T_\infty}{T_i - T_\infty} \frac{\sin(\lambda_1 r_o / r_o)}{\lambda_1 r_o / r_o}$$

Substituting,

$$\frac{T(r_o) - (-10)}{15 - (-10)} = 0.276 \frac{\sin(3.094\text{rad})}{3.094} \rightarrow T(r_o) = -9.9^\circ\text{C}$$

The entire chicken will freeze during this process since the freezing point of chicken is -2.8°C , and even the center temperature of chicken is below this value.

Discussion We could also solve this problem using transient temperature charts, but the data in this case falls at a point on the chart which is very difficult to read:

$$\left. \begin{aligned} \tau = \frac{\alpha t}{r_o^2} &= \frac{(0.13 \times 10^{-6}\text{m}^2/\text{s})(2.5 \times 3600\text{s})}{(0.0753\text{m})^2} = 0.207 \\ \frac{1}{\text{Bi}} &= \frac{k}{hr_o} = \frac{0.45\text{W/m}\cdot\text{°C}}{(440\text{W/m}^2\cdot\text{°C})(0.0753\text{m})} = 0.0136 \end{aligned} \right\} \frac{T_o - T_\infty}{T_i - T_\infty} = 0.15 \dots 0.30 \text{ ?? (Fig. 4-17)}$$

Thermal Properties of Foods

17-21C The latent heat of fusion of food products whose water content is known can be determined from $h_{\text{latent}} = 334a$ where a is the fraction of water in the food and 334 kJ/kg is the latent heat of fusion of water.

17-22C The specific heat of apples will be higher than that of apricots since the specific heats of food products is proportional to their water content, and the water content of apples (82%) is larger than that of apricots (70%).

17-23C Carrots (and any other fresh foods) freeze over a range of temperatures since the composition of the remaining liquid in carrots, and thus its freezing point, changes during freezing.

17-24C The heat removed from the cherries will be *about equal to* the heat removed from the beef since the water content of both foods is the same, and the specific and latent heats of food products primarily depend on their water content.

17-25C The heat removed from the cherries will be *about equal to* the heat removed from the beef since the water content of both foods is the same, and the specific and latent heats of food products primarily depend on their water content.

17-26 A box of beef is to be frozen. The amount of heat removed, the remaining amount of unfrozen water, and the average rate of heat removal are to be determined.

Assumptions The beef is at uniform temperatures at the beginning and at the end of the process.

Properties At a water content of 60 percent, the enthalpies of beef at 6 and -20°C are $h_{\text{initial}} = 250$ kJ/kg and $h_{\text{final}} = 45$ kJ/kg (Fig. 17-13).

Analysis (a) The total heat transfer from the beef as it is cooled from 6 to -20°C is determined from

$$Q_{\text{out}} = m(h_{\text{initial}} - h_{\text{final}}) = (35 \text{ kg})[(250 - 45) \text{ kJ/kg}] = \mathbf{7,175 \text{ kJ}}$$

(b) The unfrozen water content of beef at -20°C is determined from Fig. 17-13 to be about 25 percent. Therefore, the total amount of unfrozen water in the beef at -20°C is

$$m_{\text{unfrozen}} = (m_{\text{total}})(\% \text{ unfrozen}) = (35 \text{ kg})(0.25) = \mathbf{8.75 \text{ kg}}$$

(c) Noting that 7,175 kJ of heat is removed from the beef in 3 h, the average rate of heat removal is determined to be

$$\dot{Q}_{\text{avg}} = \frac{Q_{\text{out, total}}}{\Delta t} = \frac{7,175 \text{ kJ}}{3 \text{ h} \times 3600 \text{ s}} = \mathbf{0.66 \text{ kW}}$$

17-27 A box of sweet cherries is to be frozen. The amount of heat that must be removed and the amount of unfrozen water in cherries are to be determined.

Assumptions The cherries are at uniform temperatures at the beginning and at the end of the process.

Properties At a water content of 77 percent, the enthalpy of sweet cherries at 0 and -20°C are determined from Table 17-4 to be $h_{\text{initial}} = 324 \text{ kJ/kg}$ and $h_{\text{final}} = 58 \text{ kJ/kg}$ (Table 17-4).

Analysis (a) At a water content of 77 percent, the enthalpy of sweet cherries at 0 and -20°C are determined from Table 17-4 to be $h_{\text{initial}} = 324 \text{ kJ/kg}$ and $h_{\text{final}} = 58 \text{ kJ/kg}$. Then the total heat transfer from the cherries as they are cooled from 0 to -20°C is

$$Q_{\text{freezing}} = m(h_{\text{initial}} - h_{\text{final}}) = (50 \text{ kg})(324 - 58) \text{ kJ/kg} = \mathbf{13,300 \text{ kJ}}$$

Also, the amount of heat removed as the sweet cherries are cooled from 8 to 0°C is

$$Q_{\text{cooling}} = mc_p(\Delta T)_{\text{cooling}} = (50 \text{ kg})(3.42 \text{ kJ/kg}\cdot^{\circ}\text{C})(8 - 0)^{\circ}\text{C} = \mathbf{1368 \text{ kJ}}$$

Then the total heat removed as the sweet cherries are cooled from 8 to -20°C becomes

$$Q_{\text{total}} = Q_{\text{cooling}} + Q_{\text{freezing}} = 13,300 + 1,368 = \mathbf{14,668 \text{ kJ}}$$

(b) The unfrozen water content of sweet cherries at -20°C is determined from Table 17-4 to be 15 percent. Therefore, the total amount of unfrozen water in sweet cherries at -20°C is

$$m_{\text{unfrozen}} = (m_{\text{total}})(\% \text{ unfrozen}) = (50 \text{ kg})(0.15) = \mathbf{7.5 \text{ kg}}$$

17-28 A polypropylene box filled with cod fish is to be frozen in 2 h. The total amount of heat removed from the fish and its container, the remaining amount of unfrozen water, and the average rate of heat removal are to be determined.

Assumptions The box and the fish are at uniform temperatures at the beginning and at the end of the process.

Properties At a water content of 80.3 percent, the specific heat of the cod fish above freezing is given to be $3.69 \text{ kJ/kg}\cdot^{\circ}\text{C}$. The specific heat of the box is given to be $1.9 \text{ kJ/kg}\cdot^{\circ}\text{C}$. The enthalpies of fish at 0 and -18°C are given to be $h_{\text{initial}} = 323 \text{ kJ/kg}$ and $h_{\text{final}} = 47 \text{ kJ/kg}$. Also, the unfrozen water content of the fish at -18°C is given to be 12%.

Analysis (a) The amounts of heat removed as the cod fish is cooled from 18 to 0°C and then from 0°C to -18°C are

$$Q_{\text{cooling}} = mc_p(\Delta T)_{\text{cooling}} = (40 \text{ kg})(3.69 \text{ kJ/kg}\cdot^{\circ}\text{C})(18 - 0)^{\circ}\text{C} = 2657 \text{ kJ}$$

$$Q_{\text{freezing}} = m(h_{\text{initial}} - h_{\text{final}}) = (40 \text{ kg})(323 - 47) \text{ kJ/kg} = 11,040 \text{ kJ}$$

Also, the amount of heat removed as the box is cooled from 18 to -18°C is

$$Q_{\text{box}} = mc_p(\Delta T)_{\text{cooling}} = (2 \text{ kg})(1.9 \text{ kJ/kg}\cdot^{\circ}\text{C})[18 - (-18)^{\circ}\text{C}] = 137 \text{ kJ}$$

Then the total amount of heat removed from the package as it is cooled from 18 to -18°C becomes

$$Q_{\text{total}} = Q_{\text{fish}} + Q_{\text{box}} = 2657 + 11,040 + 137 = \mathbf{13,834 \text{ kJ}}$$

(b) The water content of the cod fish at -18°C is given to be 12%. Therefore, the total amount of unfrozen water in fish at -18°C is

$$m_{\text{unfrozen}} = (m_{\text{total}})(\% \text{ unfrozen}) = (40 \text{ kg})(0.12) = \mathbf{4.8 \text{ kg}}$$

(c) Noting that 13,834 kJ of heat is removed in 2 h, the average rate of heat removal from the fish and its container is determined to be

$$\dot{Q}_{\text{avg}} = \frac{Q_{\text{total}}}{\Delta t} = \frac{13,834 \text{ kJ}}{2 \times 3600 \text{ s}} = \mathbf{1.92 \text{ kW}}$$

17-29E Applesauce in a stainless steel container is to be frozen. The total amount of heat removed from the applesauce and its container and the remaining amount of unfrozen water in the applesauce are to be determined.

Assumptions The applesauce and its container are at uniform temperatures at the beginning and at the end of the process.

Properties At a water content of 82.8 percent, the specific heat of applesauce above freezing is given to be 0.89 Btu/lbm·°F. The specific heat of the container is given to be 0.12 Btu/lbm·°F. The enthalpy of applesauce is given to be 147.5 Btu/lbm at 32°F and 31.4 Btu/lbm at 7°F. Also, the unfrozen water content of the applesauce at 7°F is given to be 14%.

Analysis (a) The amounts of heat removed as the applesauce is cooled from 77 to 32°F and then from 32°F to 7°F are

$$Q_{\text{cooling}} = mc_p (\Delta T)_{\text{cooling}} = (90 \text{ lbm})(0.89 \text{ Btu/lbm}\cdot\text{°F})(77 - 32)\text{°F} = 3605 \text{ Btu}$$

$$Q_{\text{freezing}} = m(h_{\text{initial}} - h_{\text{final}}) = (90 \text{ lbm})[(147.5 - 31.4) \text{ Btu/lbm}] = 10,449 \text{ Btu}$$

Also, the amount of heat removed as the box is cooled from 77 to 7°F is

$$Q_{\text{box}} = mc_p (\Delta T)_{\text{cooling}} = (5 \text{ lbm})(0.12 \text{ Btu/lbm}\cdot\text{°F})(77 - 7)\text{°F} = 42 \text{ Btu}$$

Then the total amount of heat removed from the package as it is cooled from 77 to 7°F becomes

$$Q_{\text{total}} = Q_{\text{applesauce}} + Q_{\text{box}} = 3605 + 10,449 + 42 = \mathbf{14,096 \text{ Btu}}$$

(b) The water content of the applesauce at 7°F is given to be 14%. Therefore, the total amount of unfrozen water in the applesauce at 7°F is

$$m_{\text{unfrozen}} = (m_{\text{total}})(\% \text{ unfrozen}) = (90 \text{ kg})(0.14) = \mathbf{12.6 \text{ lbm}}$$

17-30 Fresh strawberries in a polypropylene box is to be frozen. The total amount of heat removed from the strawberries and the container is to be determined.

Assumptions The box and the strawberries are at uniform temperatures at the beginning and at the end of the process.

Properties At a water content of 89.3 percent, the specific heat of the strawberries above freezing is given to be 3.94 kJ/kg·°C. The specific heat of the box is given to be 2.3 kJ/kg·°C. The enthalpy of the strawberries is given to be 367 kJ/kg at 0°C and 54 kJ/kg at -16°C.

Analysis (a) The amounts of heat removed as the strawberries is cooled from 26 to 0°C and then from 0°C to -16°C are

$$Q_{\text{cooling}} = mc_p (\Delta T)_{\text{cooling}} = (25 \text{ kg})(3.94 \text{ kJ/kg}\cdot\text{°C})(26 - 0)\text{°C} = 2561 \text{ kJ}$$

$$Q_{\text{freezing}} = m(h_{\text{initial}} - h_{\text{final}}) = (25 \text{ kg})[(367 - 54) \text{ kJ/kg}] = 7825 \text{ kJ}$$

Also, the amount of heat removed as the box is cooled from 26 to -16°C is

$$Q_{\text{box}} = mc_p (\Delta T)_{\text{cooling}} = (0.8 \text{ kg})(2.3 \text{ kJ/kg}\cdot\text{°C})[26 - (-16)]\text{°C} = 77 \text{ kJ}$$

Then the total amount of heat removed from the package as it is cooled from 18 to -18°C becomes

$$Q_{\text{total}} = Q_{\text{strawberries}} + Q_{\text{box}} = 2561 + 7825 + 77 = 10,463 \text{ kJ (per box)}$$

Noting that strawberries are cooled at a rate of 80 boxes per hour, the average rate of heat removal from the strawberries is determined to be

$$\dot{Q}_{\text{avg}} = \dot{m} \times Q_{\text{total,box}} = (80 \text{ box/h})(10,463 \text{ kJ/box}) = 837,064 \text{ kJ/h} = \mathbf{232.5 \text{ kW}}$$

Refrigeration of Fruits and Vegetables

17-31C The process of cooling the fruits and vegetables at the field before they are shipped to the market or storage warehouse is called precooling. It is commonly utilized in practice because precooling preserves preharvest freshness and flavor of fruits and vegetables, and extends storage and shelf life.

17-32C The primary cooling methods of fruits and vegetables are hydrocooling, forced air cooling, package icing, and vacuum cooling.

17-33C Heat of respiration is the heat generated by fruits and vegetables due to their respiration during which glucose combines with O_2 to produce CO_2 and H_2O . This is an exothermic reaction that releases heat to surroundings.

17-34C The heat transfer coefficients in forced air cooling are considerably lower than those in hydrocooling, and the higher air velocities increase the moisture loss from the fruits and vegetables. Therefore, the cooling times are much longer in forced air cooling, and the moisture loss can be a serious problem. Hydrocooling does not cause any moisture loss, and it is associated with relatively short cooling times.

17-35C Vacuum cooling is based on reducing the pressure of a sealed cooling chamber to the saturation pressure at the desired low temperature by a vacuum pump, and to achieve cooling by the evaporation of some water from the products to be cooled. The moisture loss can be minimized by spraying water onto food products before vacuum cooling.

17-36C An atmosphere whose composition is considerably different than the standard atmosphere is called the modified atmosphere. The modified atmosphere is usually obtained by reducing the oxygen level in the air to 1 to 5 percent and increasing the CO_2 level to retard the respiration rate and decay in storage rooms. Fruits and vegetables require oxygen to respire and age, and thus the storage life of fruits and vegetables can be extended considerably by reducing the oxygen level in the cold storage rooms.

17-37C Apples, cucumbers, and tomatoes are not suitable for vacuum cooling because (1) their skin has a very low permeability for moisture, and (2) they have much smaller surface area relative to leafy vegetables such as lettuce and spinach.

17-38C Because bananas suffer chilling injury at temperatures below $13^\circ C$, but apples do not.

17-39 A banana cooling room is being analyzed. The minimum flow rate of air needed to cool bananas at a rate of $0.2^\circ\text{C}/\text{h}$ is to be determined.

Assumptions 1 Heat transfer through the walls, floor, and ceiling of the banana room is negligible. **2** Thermal properties of air, bananas, and boxes are constant.

Properties The specific heats of banana and the fiberboard are given to be $3.55 \text{ kJ/kg}\cdot^\circ\text{C}$ and $1.7 \text{ kJ/kg}\cdot^\circ\text{C}$, respectively. The peak heat of respiration of bananas is given to be 0.3 W/kg . The density and specific heat of air are given to be 1.2 kg/m^3 and $1.0 \text{ kJ/kg}\cdot^\circ\text{C}$.

Analysis Noting that the banana room holds 432 boxes, the total mass of bananas and the boxes are determined to be

$$m_{\text{banana}} = (\text{Mass per box})(\text{Number of boxes}) = (19 \text{ kg/box})(864 \text{ box}) = 16,416 \text{ kg}$$

$$m_{\text{box}} = (\text{Mass per box})(\text{Number of boxes}) = (2.3 \text{ kg/box})(864 \text{ box}) = 1987 \text{ kg}$$

The total refrigeration load in this case is due to the heat of respiration, the cooling of the bananas and the boxes, and the heat gain through the walls, and is determined from

$$\dot{Q}_{\text{total}} = \dot{Q}_{\text{respiration}} + \dot{Q}_{\text{banana}} + \dot{Q}_{\text{box}} + \dot{Q}_{\text{wall}}$$

where

$$\dot{Q}_{\text{respiration}} = m_{\text{banana}} \dot{q}_{\text{respiration}} = (16,416 \text{ kg})(0.3 \text{ W/kg}) = 4925 \text{ W}$$

$$\dot{Q}_{\text{banana}} = (mc_p \Delta T / \Delta t)_{\text{banana}} = (16,416 \text{ kg})(3.55 \text{ kJ/kg}\cdot^\circ\text{C})(0.4^\circ\text{C}/\text{h}) = 23,315 \text{ kJ/h} = 6476 \text{ W}$$

$$\dot{Q}_{\text{box}} = (mc_p \Delta T / \Delta t)_{\text{box}} = (1987 \text{ kg})(1.7 \text{ kJ/kg}\cdot^\circ\text{C})(0.4^\circ\text{C}/\text{h}) = 1351 \text{ kJ/h} = 375 \text{ W}$$

$$\dot{Q}_{\text{wall}} = 1800 \text{ kJ/kg} = 0.5 \text{ kW} = 500 \text{ W}$$

and the quantity $\Delta T / \Delta t$ is the rate of change of temperature of the products, and is given to be $0.4^\circ\text{C}/\text{h}$. Then the total rate of cooling becomes

$$\dot{Q}_{\text{total}} = \dot{Q}_{\text{respiration}} + \dot{Q}_{\text{banana}} + \dot{Q}_{\text{box}} + \dot{Q}_{\text{wall}} = 4925 + 6476 + 375 + 500 = 12,276 \text{ W}$$

The temperature rise of air is limited to 2.0 K as it flows through the load. Noting that air picks up heat at a rate of $12,276 \text{ W}$, the minimum mass and volume flow rates of air are determined to be

$$\dot{m}_{\text{air}} = \frac{\dot{Q}_{\text{air}}}{(c_p \Delta T)_{\text{air}}} = \frac{12,276 \text{ W}}{(1000 \text{ J/kg}\cdot^\circ\text{C})(2.0^\circ\text{C})} = 6.14 \text{ kg/s}$$

$$\dot{V}_{\text{air}} = \frac{\dot{m}_{\text{air}}}{\rho_{\text{air}}} = \frac{6.14 \text{ kg/s}}{1.2 \text{ kg/m}^3} = 5.12 \text{ m}^3/\text{s}$$

Therefore, the fan selected for the banana room must be large enough to circulate air at a rate of $5.12 \text{ m}^3/\text{s}$.

17-40 A claim that fruits and vegetables are cooled by 6°C for each percentage point of weight loss as moisture during vacuum cooling is to be evaluated.

Analysis Assuming the fruits and vegetables are cooled from 30°C and 0°C , the average heat of vaporization can be taken to be 2466 kJ/kg , which is the value at 15°C , and the specific heat of products can be taken to be $4 \text{ kJ/kg}\cdot^\circ\text{C}$. Then the vaporization of 0.01 kg water will lower the temperature of 1 kg of produce by $24.66/4 = 6^\circ\text{C}$. Therefore, the vacuum cooled products will lose 1 percent moisture for each 6°C drop in temperature. Thus the claim is **reasonable**.

17-41 Peaches are to be cooled to 5°C by chilled water. The cooling time is to be determined on the basis of Fig. 17-16 and the transient one-term solutions. Also, the daily cooling capacity of an existing cooling unit is to be determined.

Assumptions 1 The peaches are spherical in shape with a radius of $r_o = 3$ cm. **2** Heat conduction in the peaches is one-dimensional in the radial direction because of the symmetry about the midpoint. **3** The thermal properties of the peaches are constant. **4** The heat transfer coefficient is constant and uniform over the entire surface. **5** The Fourier number is $\tau > 0.2$ so that the one-term approximate solutions (or the transient temperature charts) are applicable (this assumption will be verified).

Properties The properties of peaches are $c_p = 3.91$ kJ/kg·°C, $k = 0.526$ W/m·°C, and $\alpha = 0.14 \times 10^{-6}$ m²/s (Table A-7).

Analysis The time required to cool the peaches to $T_{avg} = 5^\circ\text{C}$ is determined directly from Fig. 17-16 to be

$$\frac{T_{avg} - T_\infty}{T_i - T_\infty} = \frac{5 - 2}{30 - 2} = 0.107 \xrightarrow{\text{Fig. 17-16}} t = \mathbf{0.39 \text{ h}}$$

Noting that the hydrocooling unit has a refrigeration capacity of 120 tons, the amount of peaches that can be cooled per day (10-h work day) is determined to be

$$\dot{m}_{peach} = \frac{\dot{Q}}{c_p \Delta T} = \frac{(120 \times 21 \text{ kJ/min})(10 \times 60 \text{ min/day})}{(3.91 \text{ kJ/kg} \cdot \text{°C})(30 - 5) \text{ °C}} = 155,420 \text{ kg/day} \cong \mathbf{155.4 \text{ tons/day}}$$

Therefore, the hydrocooling unit can cool 155.4 tons of peaches per day.

Comparison with the solution obtained from approximate transient solution

The Biot and Fourier numbers are

$$\text{Bi} = \frac{hr_o}{k} = \frac{(550 \text{ W/m}^2 \cdot \text{°C})(0.03 \text{ m})}{0.526 \text{ W/m} \cdot \text{°C}} = 31.4$$

$$\tau = \frac{\alpha t}{r_o^2} = \frac{(0.14 \times 10^{-6} \text{ m}^2/\text{s})(0.39 \times 3600 \text{ s})}{(0.03 \text{ m})^2} = 0.218$$

Note that $\tau = 0.207 > 0.2$, and thus the one-term solution is applicable. From Table 4-2 we read, for a sphere, $\lambda_1 = 3.041$ and $A_1 = 1.990$. Substituting these values into the one-term solution, the center temperature of the peaches 0.39 h after the start of the cooling is determined to be

$$\theta_0 = \frac{T_0 - T_\infty}{T_i - T_\infty} = A_1 e^{-\lambda_1^2 \tau} \rightarrow \frac{T_0 - 2}{30 - 2} = 1.990 e^{-(3.041)^2 (0.218)} = 0.265 \rightarrow T_0 = 9.4^\circ\text{C}$$

The lowest temperature during cooling will occur on the surface ($r/r_o = 1$), and is determined to be

$$\frac{T(r) - T_\infty}{T_i - T_\infty} = A_1 e^{-\lambda_1^2 \tau} \frac{\sin(\lambda_1 r / r_o)}{\lambda_1 r / r_o} \rightarrow \frac{T(r_o) - T_\infty}{T_i - T_\infty} = \frac{T_0 - T_\infty}{T_i - T_\infty} \frac{\sin(\lambda_1 r_o / r_o)}{\lambda_1 r_o / r_o}$$

$$\text{Substituting, } \frac{T(r_o) - 2}{30 - 2} = 0.265 \frac{\sin(3.041 \text{ rad})}{3.041} \rightarrow T(r_o) = 2.2^\circ\text{C}$$

The arithmetic average of the center and the surface temperatures is $(9.4 + 2.2)/2 = 5.8^\circ\text{C}$. The actual average temperature will be somewhat lower since a larger portion of the peaches will be at or near the surface temperature. Therefore, the average temperature of 5°C determined earlier from the chart is **reasonable**.

17-42 Apples are to be cooled to 4°C by chilled water. The cooling time is to be determined on the basis of Fig. 17-16 and the transient one-term solutions. Also, the daily cooling capacity of an existing cooling unit is to be determined.

Assumptions 1 The apples are spherical in shape with a radius of $r_o = 3.5$ cm. **2** Heat conduction in the apples is one-dimensional in the radial direction because of the symmetry about the midpoint. **3** The thermal properties of the apples are constant. **4** The heat transfer coefficient is constant and uniform over the entire surface. **5** The Fourier number is $\tau > 0.2$ so that the one-term approximate solutions (or the transient temperature charts) are applicable (this assumption will be verified).

Properties The properties of apples are $c_p = 3.81$ kJ/kg·°C, $k = 0.418$ W/m·°C, and $\alpha = 0.13 \times 10^{-6}$ m²/s. (Table A-7).

Analysis The time required to cool the apples to $T_{\text{avg}} = 4^\circ\text{C}$ is determined directly from Fig. 17-16 to be

$$\frac{T_{\text{ave}} - T_\infty}{T_i - T_\infty} = \frac{4 - 1.5}{28 - 1.5} = 0.0943 \xrightarrow{\text{Fig. 17-16}} t = \mathbf{0.50 \text{ h}}$$

Noting that the hydrocooling unit has a refrigeration capacity of 80 tons, the amount of apples that can be cooled per day (10-h work day) is determined to be

$$\dot{m}_{\text{apple}} = \frac{\dot{Q}}{c_p \Delta T} = \frac{(80 \times 21 \text{ kJ/min})(10 \times 60 \text{ min/day})}{(3.81 \text{ kJ/kg} \cdot ^\circ\text{C})(28 - 4)^\circ\text{C}} = 110,760 \text{ kg/day} \cong \mathbf{110.8 \text{ tons/day}}$$

Therefore, the hydrocooling unit can cool 110.8 tons of apples per day.

Comparison with the solution obtained from approximate transient solution

The Biot and Fourier numbers become

$$\text{Bi} = \frac{hr_o}{k} = \frac{(540 \text{ W/m}^2 \cdot ^\circ\text{C})(0.035 \text{ m})}{0.418 \text{ W/m} \cdot ^\circ\text{C}} = 45.2$$

$$\tau = \frac{\alpha t}{r_o^2} = \frac{(0.13 \times 10^{-6} \text{ m}^2/\text{s})(0.50 \times 3600 \text{ s})}{(0.035 \text{ m})^2} = 0.191$$

Note that $\tau = 0.191 \approx 0.2$, and thus the one-term solution is applicable. From Table 4-2 we read, for a sphere, $\lambda_1 = 3.051$ and $A_1 = 1.992$. Substituting these values into the one-term solution, the center temperature of the apples 0.50 h after the start of the cooling is determined to be

$$\theta_0 = \frac{T_0 - T_\infty}{T_i - T_\infty} = A_1 e^{-\lambda_1^2 \tau} \rightarrow \frac{T_0 - 1.5}{28 - 1.5} = 1.992 e^{-(3.051)^2 (0.191)} = 0.337 \rightarrow T_0 = 10.4^\circ\text{C}$$

The lowest temperature during cooling will occur on the surface ($r/r_o = 1$), and is determined to be

$$\frac{T(r) - T_\infty}{T_i - T_\infty} = A_1 e^{-\lambda_1^2 \tau} \frac{\sin(\lambda_1 r / r_o)}{\lambda_1 r / r_o} \rightarrow \frac{T(r_o) - T_\infty}{T_i - T_\infty} = \frac{T_0 - T_\infty}{T_i - T_\infty} \frac{\sin(\lambda_1 r_o / r_o)}{\lambda_1 r_o / r_o}$$

$$\text{Substituting, } \frac{T(r_o) - 1.5}{28 - 1.5} = 0.337 \frac{\sin(3.051 \text{ rad})}{3.051} \rightarrow T(r_o) = 1.8^\circ\text{C}$$

The arithmetic average of the center and the surface temperatures is $(10.4 + 1.8)/2 = 6.1^\circ\text{C}$. The actual average temperature will be somewhat lower since a larger portion of the apples will be at or near the surface temperature. Therefore, the average temperature of 4°C determined earlier from the chart is **reasonable**.

17-43E Apples are to be cooled to 38°F by chilled air. The volume of the cooling section and its dimensions, the amount of total heat transfer from a full load of apples, and the time it will take for the center temperature of the apples to drop to 40°F are to be determined.

Assumptions **1** The apples are spherical in shape with a radius of $r_o = 1.25$ in. **2** Heat conduction in the apples is one-dimensional in the radial direction because of the symmetry about the midpoint. **3** The thermal properties of the apples are constant. **4** The heat transfer coefficient is constant and uniform over the entire surface. **5** The Fourier number is $\tau > 0.2$ so that the one-term approximate solutions (or the transient temperature charts) are applicable (this assumption will be verified). **6** The heat of respiration is negligible.

Properties The properties of apples are given to be $\rho = 52.4$ lbm/ft³, $c_p = 0.91$ Btu/lbm·°F, $k = 0.24$ Btu/h·ft·°F, and $\alpha = 1.4 \times 10^{-6}$ ft²/s.

Analysis (a) The porosity of the cooling section is 0.38. Then the volume of the cooling section is determined to be

$$V_{\text{cooling}} = \frac{m}{\rho} \times (1 + \text{porosity}) = \frac{10,000 \text{ lbm}}{52.4 \text{ lbm/ft}^3} (1 + 0.38) = \mathbf{263.4 \text{ ft}^3}$$

Assuming the cooling section to be cubic, the length of each side becomes

$$L = (263.4 \text{ ft}^3)^{1/3} = \mathbf{6.4 \text{ ft}}$$

(b) The amount of total heat transfer from a full load of apples to the cooling air is

$$Q_{\text{apple}} = mc_p \Delta T = (10,000 \text{ lbm/load})(0.91 \text{ Btu/lbm}\cdot\text{°F})(80 - 38)\text{°F} = \mathbf{382,200 \text{ Btu/load}}$$

(c) The time required to cool the mid section of the apples to $T_o = 40^\circ\text{F}$ is determined from the one-term solution relation for spheres presented in Chap. 4. First we find the Biot number:

$$Bi = \frac{hr_o}{k} = \frac{(7.8 \text{ Btu/h}\cdot\text{ft}^2\cdot\text{°F})(1.25/12 \text{ ft})}{0.242 \text{ Btu/h}\cdot\text{ft}\cdot\text{°C}} = 3.36$$

From Table 4-2 we read, for a sphere, $\lambda_1 = 2.349$ and $A_1 = 1.658$.

Substituting these values into the one-term solution gives

$$\theta_0 = \frac{T_o - T_\infty}{T_i - T_\infty} = A_1 e^{-\lambda_1^2 \tau} \rightarrow \frac{40 - 28}{80 - 28} = 1.658 e^{-(2.349)^2 \tau} \rightarrow \tau = 0.390$$

which is greater than 0.2 and thus the one-term solution is applicable. Then the cooling time becomes

$$\tau = \frac{\alpha t}{r_o^2} \rightarrow t = \frac{\tau r_o^2}{\alpha} = \frac{(0.390)(1.25/12 \text{ ft})^2}{1.4 \times 10^{-6} \text{ ft}^2/\text{s}} = 3023 \text{ s} = \mathbf{50.4 \text{ min}}$$

Alternative solution We could also solve part (c) of this problem using transient temperature charts as follows:

$$\left. \begin{aligned} \frac{1}{Bi} = \frac{k}{hr_o} &= \frac{0.24 \text{ Btu/h}\cdot\text{ft}\cdot\text{°F}}{(7.8 \text{ Btu/h}\cdot\text{ft}^2\cdot\text{°F})(1.25/12 \text{ ft})} = 0.295 \\ \frac{T_o - T_\infty}{T_i - T_\infty} &= \frac{38 - 28}{80 - 28} = 0.23 \end{aligned} \right\} \tau = \frac{\alpha t}{r_o^2} = 0.40 \quad (\text{Fig. 4-17a})$$

Therefore, $t = \frac{\tau r_o^2}{\alpha} = \frac{(0.40)(1.25/12 \text{ ft})^2}{1.4 \times 10^{-6} \text{ ft}^2/\text{s}} = 3,096 \text{ s} = 52 \text{ min}$

The slight difference between the two results is due to the reading error of the chart.

17-44 Fresh strawberries in nylon boxes are to be cooled to 4°C. The rate of heat removal from the strawberries and the percent error involved if the strawberry boxes were ignored in calculations are to be determined.

Assumptions 1 Steady operating conditions exist. 2 The thermal properties of strawberries are constant.

Properties The specific heat of strawberries is given to be $c_p = 3.89 \text{ kJ/kg}\cdot^\circ\text{C}$. The specific heat of nylon box is given to be $c_p = 1.7 \text{ kJ/kg}\cdot^\circ\text{C}$. The heat of respiration of strawberries is given to be 0.21 W/kg .

Analysis (a) Noting that the strawberries are cooled at a rate of 60 boxes per hour, the total amounts of strawberries and the box material cooled per hour are

$$m_{\text{strawberry}} = (\text{Mass per box})(\text{Number of boxes per hour}) = (23 \text{ kg/box})(60 \text{ box}) = 1380 \text{ kg}$$

$$m_{\text{box}} = (\text{Mass per box})(\text{Number of boxes per hour}) = (0.8 \text{ kg/box})(60 \text{ box/h}) = 48 \text{ kg}$$

The total refrigeration load in this case is due to the heat of respiration and the cooling of the strawberries and the boxes, and is determined from

$$\dot{Q}_{\text{total}} = \dot{Q}_{\text{respiration}} + \dot{Q}_{\text{strawberry}} + \dot{Q}_{\text{box}}$$

where

$$\dot{Q}_{\text{respiration}} = m_{\text{strawberry}} \dot{q}_{\text{respiration}} = (1380 \text{ kg})(0.21 \text{ W/kg}) = 290 \text{ W} = 1044 \text{ kJ/h}$$

$$\dot{Q}_{\text{strawberry}} = (mc_p \Delta T / \Delta t)_{\text{strawberry}} = [(1380 \text{ kg})(3.89 \text{ kJ/kg}\cdot^\circ\text{C})(30 - 4)^\circ\text{C}]/(1 \text{ h}) = 139,573 \text{ kJ/h}$$

$$\dot{Q}_{\text{box}} = (mc_p \Delta T / \Delta t)_{\text{box}} = [(48 \text{ kg})(1.7 \text{ kJ/kg}\cdot^\circ\text{C})(30 - 4)^\circ\text{C}]/(1 \text{ h}) = 2122 \text{ kJ/h}$$

Then the total rate of cooling becomes

$$\dot{Q}_{\text{total}} = \dot{Q}_{\text{respiration}} + \dot{Q}_{\text{strawberry}} + \dot{Q}_{\text{box}} = 1044 + 139,573 + 2122 = \mathbf{142,739 \text{ kJ/h}}$$

If the strawberry boxes were ignored, the total rate of cooling would be

$$\dot{Q}_{\text{total}} = \dot{Q}_{\text{respiration}} + \dot{Q}_{\text{strawberry}} = 1044 + 139,573 = 140,617 \text{ kJ/h}$$

Therefore, the percentage error involved in ignoring the boxes is $2122/142,739 \times 100 = 1.5\%$, which is negligible.

17-45 Lettuce is to be vacuum cooled in an insulated spherical vacuum chamber. The final pressure in the vacuum chamber, the amount of moisture removed from the lettuce, and the error involved in neglecting heat transfer through the wall of the chamber are to be determined.

Assumptions **1** The thermal properties of lettuce are constant. **2** Heat transfer through the walls of the vacuum chamber is negligible. **3** All the air in the chamber is sucked out by the vacuum pump so that there is only vapor in the chamber.

Properties The thermal conductivity of urethane insulation is given to be $k = 0.020 \text{ W/m}\cdot^\circ\text{C}$. The specific heat of the lettuce is $4.02 \text{ kJ/kg}\cdot^\circ\text{C}$. The saturation pressure of water at 2°C is 0.712 kPa . At the average temperature of $(24 + 2)/2 = 13^\circ\text{C}$, the latent heat of vaporization of water is $h_{fg} = 2470 \text{ kJ/kg}$ (Table A-9).

Analysis (a) The final vapor pressure in the vacuum chamber will be the saturation pressure at the final temperature of 2°C , which is determined from the saturated water tables to be

$$P_{\text{final}} = P_{\text{sat @ } 2^\circ\text{C}} = \mathbf{0.712 \text{ kPa}}$$

Assuming all the air in the chamber is already sucked out by the vacuum pump, this vapor pressure will be equivalent to the final pressure in the chamber.

(b) The amount of heat transfer to cool 5,000 kg of lettuce from 24 to 2°C is determined from

$$Q_{\text{lettuce}} = (mc_p \Delta T)_{\text{lettuce}} = (5000 \text{ kg})(4.02 \text{ kJ/kg}\cdot^\circ\text{C})(24 - 2)^\circ\text{C} = 442,200 \text{ kJ}$$

Each kg of water in lettuce absorbs 2470 kJ of heat as it evaporates. Disregarding any heat gain through the walls of the vacuum chamber, the amount of moisture removed is determined to be

$$Q_{\text{lettuce}} = m_{\text{evap}} h_{fg} \rightarrow m_{\text{evap}} = \frac{Q_{\text{lettuce}}}{h_{fg}} = \frac{442,200 \text{ kJ}}{2470 \text{ kJ/kg}} = \mathbf{179.0 \text{ kg}}$$

To determine the maximum amount of heat transfer to the vacuum chamber through its shell, we assume the heat transfer coefficients at the inner and outer surfaces to be infinity so that the inner and outer surface temperatures of the shell are equal to the temperatures of medium surrounding them. We also neglect the thermal resistance of the metal plates. Using the average chamber temperature for the inner surface, the rate of heat gain is determined to be

$$\dot{Q}_{\text{gain}} = \frac{k4\pi r_{\text{out}} r_{\text{in}} (T_{\text{out}} - T_{\text{in,avg}})}{r_{\text{out}} - r_{\text{in}}} = \frac{(0.02 \text{ W/m}\cdot^\circ\text{C})4\pi(2 \text{ m})(1.97 \text{ m})(24 - 3)^\circ\text{C}}{(2 - 1.97) \text{ m}} = 363 \text{ W} = 0.363 \text{ kW}$$

Then the amount of heat gain in 45 min becomes

$$Q_{\text{gain}} = \dot{Q}_{\text{gain}} \Delta t = (0.363 \text{ kJ/s})(45 \times 60 \text{ s}) = 980 \text{ kJ}$$

which is $980/442,200 = 0.0022$ or 0.22% of the heat removed from the lettuce. Therefore, the claim that heat gain through the chamber walls is negligible is **reasonable** since its effect is much less than 2%.

17-46 Spinach is to be vacuum cooled in an insulated spherical vacuum chamber. The final pressure in the vacuum chamber, the amount of moisture removed from the lettuce, and the error involved in neglecting heat transfer through the wall of the chamber are to be determined.

Assumptions **1** The thermal properties of spinach are constant. **2** Heat transfer through the walls of the vacuum chamber is negligible. **3** All the air in the chamber is sucked out by the vacuum pump so that there is only vapor in the chamber.

Properties The thermal conductivity of urethane insulation is given to be $k = 0.020 \text{ W/m}\cdot^\circ\text{C}$. The specific heat of the spinach is $3.96 \text{ kJ/kg}\cdot^\circ\text{C}$. The saturation pressure of water at 3°C is 0.764 kPa . At the average temperature of $(27 + 3)/2 = 15^\circ\text{C}$, the latent heat of vaporization of water is $h_{fg} = 2466 \text{ kJ/kg}$ (Table A-9).

Analysis (a) The final vapor pressure in the vacuum chamber will be the saturation pressure at the final temperature of 3°C , which is determined from the saturated water tables to be

$$P_{\text{final}} = P_{\text{sat @ } 3^\circ\text{C}} = 0.764 \text{ kPa}$$

Assuming all the air in the chamber is already sucked out by the vacuum pump, this vapor pressure will be equivalent to the final pressure in the chamber.

(b) The amount of heat transfer to cool $6,500 \text{ kg}$ of spinach from 27 to 3°C is

$$Q_{\text{lettuce}} = (mc_p \Delta T)_{\text{lettuce}} = (6500 \text{ kg})(3.96 \text{ kJ/kg}\cdot^\circ\text{C})(27 - 3)^\circ\text{C} = 617,760 \text{ kJ}$$

Each kg of water in lettuce absorbs 2466 kJ of heat as it evaporates. Disregarding any heat gain through the walls of the vacuum chamber, the amount of moisture removed is determined to be

$$Q_{\text{spinach}} = m_{\text{evap}} h_{fg} \rightarrow m_{\text{evap}} = \frac{Q_{\text{spinach}}}{h_{fg}} = \frac{617,760 \text{ kJ}}{2466 \text{ kJ/kg}} = \mathbf{250.5 \text{ kg}}$$

To determine the maximum amount of heat transfer to the vacuum chamber through its shell, we assume the heat transfer coefficients at the inner and outer surfaces to be infinity so that the inner and outer surface temperatures of the shell are equal to the temperatures of medium surrounding them. We also neglect the thermal resistance of the metal plates. Then using the average chamber temperature for the inner surface, the rate of heat gain is determined to be

$$\dot{Q}_{\text{gain}} = \frac{k4\pi r_{\text{out}} r_{\text{in}} (T_{\text{out}} - T_{\text{in,avg}})}{r_{\text{out}} - r_{\text{in}}} = \frac{(0.02 \text{ W/m}\cdot^\circ\text{C})4\pi(2.5 \text{ m})(2.475 \text{ m})(27 - 3)^\circ\text{C}}{(2.5 - 2.475) \text{ m}} = 970 \text{ W} = 0.970 \text{ kW}$$

Then the amount of heat gain in 50 min becomes

$$Q_{\text{gain}} = \dot{Q}_{\text{gain}} \Delta t = (0.970 \text{ kJ/s})(50 \times 60 \text{ s}) = 2910 \text{ kJ}$$

which is $2910/617,760 = 0.0047$ or 0.47% of the heat removed from the lettuce. Therefore, the claim that heat gain through the chamber walls is negligible is **reasonable** since its effect is much less than 2% .

Refrigeration of Meats, Poultry, and Fish

17-47C About 70 percent of the beef carcass is water, and the carcass is cooled mostly by evaporative cooling as a result of moisture migration towards the surface where evaporation occurs. This may cause up to 2 percent of the total mass of the carcass to evaporate during an overnight chilling. This weight loss can be minimized by washing or spraying the carcass with water prior to cooling.

17-48C Cooling the carcass with refrigerated air is at -10°C would certainly reduce the cooling time, but this proposal should be rejected since it will cause the outer parts of the carcasses to freeze, which is undesirable. Also, the refrigeration unit will consume more power to reduce the temperature to -10°C , and thus it will have a lower efficiency.

17-49C The freezing time could be decreased by (a) lowering the temperature of the refrigerated air, (b) increasing the velocity of air, (c) increasing the capacity of the refrigeration system, and (d) decreasing the size of the meat boxes.

17-50C The rate of freezing can affect color, tenderness, and drip. Rapid freezing increases tenderness and reduces the tissue damage and the amount of drip after thawing.

17-51C This claim is reasonable since the lower the storage temperature, the longer the storage life of beef, as can be seen from Table 17-7. This is because some water remains unfrozen even at subfreezing temperatures, and the lower the temperature, the smaller the unfrozen water content of the beef.

17-52C A refrigerated shipping dock is a refrigerated space where the orders are assembled and shipped out. Such docks save valuable storage space from being used for shipping purpose, and provide a more acceptable working environment for the employees. The refrigerated shipping docks are usually maintained at 1.5°C , and therefore the air that flows into the freezer during shipping is already cooled to about 1.5°C . This reduces the refrigeration load of the cold storage rooms.

17-53C (a) The heat transfer coefficient during immersion cooling is much higher, and thus the cooling time during immersion chilling is much lower than that during forced air chilling. (b) The cool air chilling can cause a moisture loss of 1 to 2 percent while water immersion chilling can actually cause moisture absorption of 4 to 15 percent. (c) The chilled water circulated during immersion cooling encourages microbial growth, and thus immersion chilling is associated with more microbial growth. The problem can be minimized by adding chloride to the water.

17-54C The proper storage temperature of frozen poultry is about -18°C or below. The primary freezing methods of poultry are the air blast tunnel freezing, cold plates, immersion freezing, and cryogenic cooling.

17-55C The factors, which affect the quality of frozen, fish are the condition of the fish before freezing, the freezing method, and the temperature and humidity during storage and transportation, and the length of storage time.

17-56 The chilling room of a meat plant with a capacity of 350 beef carcasses is considered. The cooling load and the air flow rate are to be determined.

Assumptions 1 Steady operating conditions exist. 2 Specific heats of beef carcass and air are constant.

Properties The density and specific heat of air at 0°C are given to be 1.28 kg/m³ and 1.0 kJ/kg·°C. The specific heat of beef carcass is given to be 3.14 kJ/kg·°C.

Analysis (a) The amount of beef mass that needs to be cooled per unit time is

$$\begin{aligned}\dot{m}_{beef} &= (\text{Total beef mass cooled})/(\text{cooling time}) \\ &= (350 \times 220 \text{ kg/carcass})/(12 \text{ h} \times 3600 \text{ s}) = 1.782 \text{ kg/s}\end{aligned}$$

The product refrigeration load can be viewed as the energy that needs to be removed from the beef carcass as it is cooled from 35 to 16°C at a rate of 2.27 kg/s, and is determined to be

$$\begin{aligned}\dot{Q}_{beef} &= (\dot{m}c_p \Delta T)_{beef} \\ &= (1.782 \text{ kg/s})(3.14 \text{ kJ/kg} \cdot ^\circ\text{C})(35 - 16)^\circ\text{C} = 106 \text{ kW}\end{aligned}$$

Then the total refrigeration load of the chilling room becomes

$$\dot{Q}_{\text{total, chilling room}} = \dot{Q}_{beef} + \dot{Q}_{fan} + \dot{Q}_{lights} + \dot{Q}_{heat\ gain} = 106 + 22 + 2 + 14 = \mathbf{144 \text{ kW}}$$

(b) Heat is transferred to air at the rate determined above, and the temperature of air rises from -2.2°C to 0.5°C as a result. Therefore, the mass flow rate of air is

$$\dot{m}_{air} = \frac{\dot{Q}_{air}}{(c_p \Delta T)_{air}} = \frac{144 \text{ kW}}{(1.0 \text{ kJ/kg} \cdot ^\circ\text{C})[0.5 - (-2.2)^\circ\text{C}]} = 53.3 \text{ kg/s}$$

Then the volume flow rate of air becomes

$$\dot{V}_{air} = \frac{\dot{m}_{air}}{\rho_{air}} = \frac{53.3 \text{ kg/s}}{1.28 \text{ kg/m}^3} = \mathbf{41.7 \text{ m}^3/\text{s}}$$

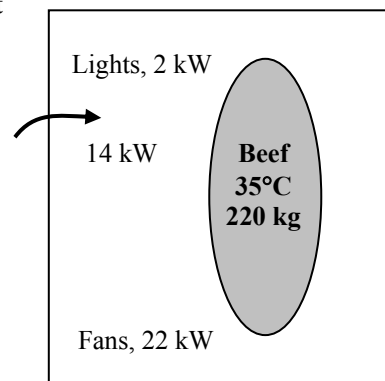

17-57 Turkeys are to be frozen by submerging them into brine at -29°C . The time it will take to reduce the temperature of turkey breast at a depth of 3.8 cm to -18°C and the amount of heat transfer per turkey are to be determined.

Assumptions 1 Steady operating conditions exist. 2 The thermal properties of turkeys are constant.

Properties It is given that the specific heats of turkey are 2.98 and 1.65 kJ/kg $\cdot^{\circ}\text{C}$ above and below the freezing point of -2.8°C , respectively, and the latent heat of fusion of turkey is 214 kJ/kg.

Analysis The time required to freeze the turkeys from 1°C to -18°C with brine at -29°C can be determined directly from Fig. 17-31 to be

$$t \cong 180 \text{ min.} \cong \mathbf{3 \text{ hours}}$$

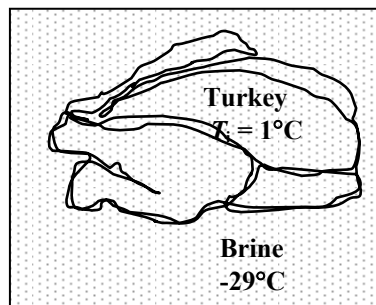

(a) Assuming the entire water content of turkey is frozen, the amount of heat that needs to be removed from the turkey as it is cooled from 1°C to -18°C is

$$\text{Cooling to } -2.8^{\circ}\text{C}: Q_{\text{cooling,fresh}} = (mc_p \Delta T)_{\text{fresh}} = (7 \text{ kg})(2.98 \text{ kJ/kg}\cdot^{\circ}\text{C})[1 - (-2.8)^{\circ}\text{C}] = 79.3 \text{ kJ}$$

$$\text{Freezing at } -2.8^{\circ}\text{C}: Q_{\text{freezing}} = mh_{\text{latent}} = (7 \text{ kg})(214 \text{ kJ/kg}) = 1498 \text{ kJ}$$

$$\text{Cooling } -18^{\circ}\text{C}: Q_{\text{cooling,frozen}} = (mc_p \Delta T)_{\text{frozen}} = (7 \text{ kg})(1.65 \text{ kJ/kg}\cdot^{\circ}\text{C})[-2.8 - (-18)]^{\circ}\text{C} = 175.6 \text{ kJ}$$

Therefore, the total amount of heat removal per turkey is

$$Q_{\text{total}} = Q_{\text{cooling,fresh}} + Q_{\text{freezing}} + Q_{\text{cooling,frozen}} = 79.3 + 1498 + 175.6 \cong \mathbf{1753 \text{ kJ}}$$

(b) Assuming only 90 percent of the water content of turkey is frozen, the amount of heat that needs to be removed from the turkey as it is cooled from 1°C to -18°C is

$$\text{Cooling to } -2.8^{\circ}\text{C}: Q_{\text{cooling,fresh}} = (mc_p \Delta T)_{\text{fresh}} = (7 \text{ kg})(2.98 \text{ kJ/kg}\cdot^{\circ}\text{C})[1 - (-2.98)^{\circ}\text{C}] = 79.3 \text{ kJ}$$

$$\text{Freezing at } -2.8^{\circ}\text{C}: Q_{\text{freezing}} = mh_{\text{latent}} = (7 \times 0.9 \text{ kg})(214 \text{ kJ/kg}) = 1348 \text{ kJ}$$

$$\text{Cooling } -18^{\circ}\text{C}: Q_{\text{cooling,frozen}} = (mc_p \Delta T)_{\text{frozen}} = (7 \times 0.9 \text{ kg})(1.65 \text{ kJ/kg}\cdot^{\circ}\text{C})[-2.8 - (-18)]^{\circ}\text{C} = 158 \text{ kJ}$$

$$Q_{\text{cooling,unfrozen}} = (mc_p \Delta T)_{\text{fresh}} = (7 \times 0.1 \text{ kg})(2.98 \text{ kJ/kg}\cdot^{\circ}\text{C})[-2.8 - (-18)^{\circ}\text{C}] = 31.7 \text{ kJ}$$

Therefore, the total amount of heat removal per turkey is

$$Q_{\text{total}} = Q_{\text{cooling,fresh}} + Q_{\text{freezing}} + Q_{\text{cooling,frozen\&unfrozen}} = 79.3 + 1348 + 158 + 31.7 = \mathbf{1617 \text{ kJ}}$$

17-58E Chickens are to be frozen by refrigerated air. The cooling time of the chicken is to be determined for the cases of cooling air being at -40°F and -80°F .

Assumptions 1 Steady operating conditions exist. 2 The thermal properties of chickens are constant.

Analysis The time required to reduce the inner surface temperature of the chickens from 32°F to 25°F with refrigerated air at -40°F is determined from Fig. 17-30 to be

$$t \cong 2.3 \text{ hours}$$

If the air temperature were -80°F , the freezing time would be

$$t \cong 1.4 \text{ hours}$$

Therefore, the time required to cool the chickens to 25°F is reduced considerably when the refrigerated air temperature is decreased.

17-59 Chickens are to be cooled by chilled water in an immersion chiller. The rate of heat removal from the chicken and the mass flow rate of water are to be determined.

Assumptions 1 Steady operating conditions exist. 2 The thermal properties of chickens are constant.

Properties The specific heat of chicken are given to be $3.54 \text{ kJ/kg}\cdot^{\circ}\text{C}$. The specific heat of water is $4.18 \text{ kJ/kg}\cdot^{\circ}\text{C}$ (Table A-9).

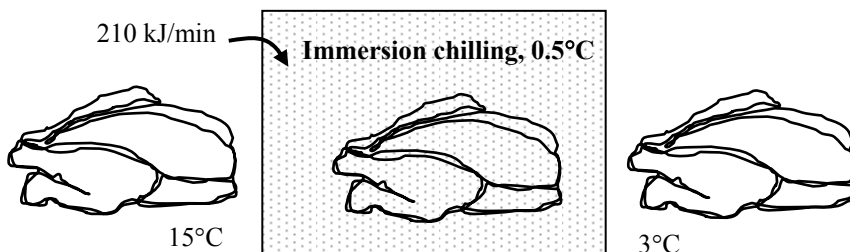

Analysis (a) Chickens are dropped into the chiller at a rate of 500 per hour. Therefore, chickens can be considered to flow steadily through the chiller at a mass flow rate of

$$\dot{m}_{\text{chicken}} = (500 \text{ chicken/h})(2.2 \text{ kg/chicken}) = 1100 \text{ kg/h} = 0.3056 \text{ kg/s}$$

Then the rate of heat removal from the chickens as they are cooled from 15°C to 3°C at this rate becomes

$$\dot{Q}_{\text{chicken}} = (\dot{m}c_p\Delta T)_{\text{chicken}} = (0.3056 \text{ kg/s})(3.54 \text{ kJ/kg}\cdot^{\circ}\text{C})(15 - 3)^{\circ}\text{C} = \mathbf{13.0 \text{ kW}}$$

(b) The chiller gains heat from the surroundings as a rate of $210 \text{ kJ/min} = 3.5 \text{ kJ/s}$. Then the total rate of heat gain by the water is

$$\dot{Q}_{\text{water}} = \dot{Q}_{\text{chicken}} + \dot{Q}_{\text{heat gain}} = 13.0 + 3.5 = 16.5 \text{ kW}$$

Noting that the temperature rise of water is not to exceed 2°C as it flows through the chiller, the mass flow rate of water must be at least

$$\dot{m}_{\text{water}} = \frac{\dot{Q}_{\text{water}}}{(c_p\Delta T)_{\text{water}}} = \frac{16.5 \text{ kW}}{(4.18 \text{ kJ/kg}\cdot^{\circ}\text{C})(2^{\circ}\text{C})} = \mathbf{1.97 \text{ kg/s}}$$

If the mass flow rate of water is less than this value, then the temperature rise of water will have to be more than 2°C .

17-60 The center temperature of meat slabs is to be lowered by chilled air to below 5°C while the surface temperature remains above -1°C to avoid freezing. The average heat transfer coefficient during this cooling process is to be determined.

Assumptions **1** The meat slabs can be approximated as very large plane walls of half-thickness $L = 5\text{-cm}$. **2** Heat conduction in the meat slabs is one-dimensional because of symmetry about the centerplane. **3** The thermal properties of the meat slab are constant. **4** The heat transfer coefficient is constant and uniform over the entire surface. **5** The Fourier number is $\tau > 0.2$ so that the one-term approximate solutions (or the transient temperature charts) are applicable (this assumption will be verified).

Properties The thermal properties of the beef slabs are given to be $\rho = 1090\text{ kg/m}^3$, $c_p = 3.54\text{ kJ/kg}\cdot^{\circ}\text{C}$, $k = 0.47\text{ W/m}\cdot^{\circ}\text{C}$, and $\alpha = 0.13 \times 10^{-6}\text{ m}^2/\text{s}$.

Analysis The lowest temperature in the steak will occur at the surfaces and the highest temperature at the center at a given time since the inner part of the steak will be last place to be cooled. In the limiting case, the surface temperature at $x = L = 5\text{ cm}$ from the center will be -1°C while the mid plane temperature is 5°C in an environment at -12°C . Then from Fig. 4-15b we obtain

$$\left. \begin{aligned} \frac{x}{L} = \frac{5\text{ cm}}{5\text{ cm}} = 1 \\ \frac{T(L, t) - T_{\infty}}{T_o - T_{\infty}} = \frac{-1 - (-12)}{5 - (-12)} = 0.65 \end{aligned} \right\} \frac{1}{\text{Bi}} = \frac{k}{hL} = 0.95$$

which gives

$$h = \frac{1}{0.95} \frac{k}{L} = \frac{0.47\text{ W/m}\cdot^{\circ}\text{C}}{1.5(0.05\text{ m})} = \mathbf{9.9\text{ W/m}^2\cdot^{\circ}\text{C}}$$

Therefore, the convection heat transfer coefficient should be kept below this value to satisfy the constraints on the temperature of the steak during refrigeration. We can also meet the constraints by using a lower heat transfer coefficient, but doing so would extend the refrigeration time unnecessarily.

Discussion We could avoid the uncertainty associated with the reading of the charts and obtain a more accurate result by using the one-term solution relation for an infinite plane wall, but it would require a trial and error approach since the Bi number is not known.

Refrigeration of Eggs, Milk, and Bakery Products

17-61C The density of fresh eggs (1080 kg/m^3) is larger than that of water, and thus fresh eggs settle at the bottom of a water filled cup. The density of old eggs, however, is usually lower than the density of water, and thus old eggs float on the water. Note that an egg loses moisture as it ages if the pores on the shell are not sealed, and the space vacated by water is filled with air.

17-62C Standardization is the process of bringing the milk-fat content of the milk to the desired level. During standardization, the stored milk at about 4.4°C is heated to about 20 to 33°C in warm milk separators where only a portion of the milk is separated. The remaining milk is standardized by adding skim milk or milkfat.

17-63C Milk is pasteurized to kill microorganisms in it by heating it to a minimum temperature of 62.8°C by hot water or steam, and holding it at that temperature for at least 30 min. The pasteurization time can be minimized by heating the milk to higher temperatures. It is only 15 s at 71.7°C . A regenerator is a heat exchanger in which cold raw milk is preheated by the hot pasteurized milk, saving a considerable amount of energy and money.

17-64C The homogenization of milk is the process of breaking up the large fat globules into smaller ones to give the milk a “homogeneous” appearance. Milk is homogenized by heating it to 56°C or above at a high pressure (usually 8 to 17 MPa), and then forcing it through homogenizing valves.

17-65C Yeast is usually stored between 1 and 7°C since it is inactive in that temperature range. The optimum dough temperature ranges from 27 to 38°C because yeast is most active in this temperature range.

17-66C The heat released when dry flour absorbs water is called the heat of hydration. The temperature rise of dough due to this heat of hydration can be prevented by precooling the water to 2 to 4°C or by cooling the walls of the mixing chamber by circulating chilled water through water jackets during kneading.

17-67 A regenerator is considered to save heat during the cooling of milk in a dairy plant. The amounts of fuel and money such a generator will save per year are to be determined.

Assumptions 1 Steady operating conditions exist. **2** The properties of the milk are constant.

Properties The average density and specific heat of milk can be taken to be $\rho_{\text{milk}} \cong \rho_{\text{water}} = 1000 \text{ kg/m}^3$ and $c_{p, \text{milk}} = 3.98 \text{ kJ/kg}\cdot^\circ\text{C}$ (Table A-7b).

Analysis The mass flow rate of the milk is

$$\dot{m}_{\text{milk}} = \rho \dot{V}_{\text{milk}} = (1000 \text{ kg/m}^3)(12 \text{ L/s}) = 12 \text{ kg/s} = 60,120 \text{ lbm/h}$$

To heat the milk from 4 to 72°C as being done currently, heat must be transferred to the milk at a rate of

$$\dot{Q}_{\text{current}} = [\dot{m} c_p (T_{\text{pasturization}} - T_{\text{refrigeration}})]_{\text{milk}} = (12 \text{ kg/s})(3.98 \text{ kJ/kg}\cdot^\circ\text{C})(72 - 4)^\circ\text{C} = 3,248 \text{ kJ/s}$$

The proposed regenerator has an effectiveness of $\varepsilon = 0.82$, and thus it will save 82 percent of this energy. Therefore,

$$\dot{Q}_{\text{saved}} = \varepsilon \dot{Q}_{\text{current}} = (0.82)(3,248 \text{ kJ/s}) = 2663 \text{ kJ/s}$$

Noting that the boiler has an efficiency of $\eta_{\text{boiler}} = 0.82$, the energy savings above correspond to fuel savings of

$$\text{Fuel Saved} = \frac{\dot{Q}_{\text{saved}}}{\eta_{\text{boiler}}} = \frac{(2,663 \text{ kJ/s})}{(0.82)} \frac{(1 \text{ therm})}{(105,500 \text{ kJ})} = 0.03078 \text{ therm/s}$$

Noting that 1 year = 365×24=8760 h and unit cost of natural gas is \$1.05/therm, the annual fuel and money savings will be

$$\text{Fuel Saved} = (0.03078 \text{ therms/s})(8760 \times 3600 \text{ s}) = \mathbf{970,780 \text{ therms/yr}}$$

$$\begin{aligned} \text{Money saved} &= (\text{Fuel saved})(\text{Unit cost of fuel}) \\ &= (970,680 \text{ therm/yr})(\$1.05/\text{therm}) = \mathbf{\$1,019,200/\text{yr}} \end{aligned}$$

17-68 A polypropylene box made of polypropylene contains 30 white breads that are to be frozen by refrigerated air. The total amount of heat that must be removed from the breads and their box and the average rate of heat removal are to be determined.

Assumptions 1 Steady operating conditions exist. **2** The properties of the bread and the box are constant.

Properties The specific heat of polypropylene box is given to be $c_p = 1.9 \text{ kJ/kg}\cdot^\circ\text{C}$. The enthalpy of the bread is given to be 137 kJ/kg at 0°C and 56 kJ/kg at -12°C. The average specific heat of the bread above 0°C is given to be $c_p = 2.60 \text{ kJ/kg}\cdot^\circ\text{C}$.

Analysis (a) Noting that a box contains 30 breads, 0.45 kg each, the total mass of the breads in one box is

$$m_{\text{bread}} = (30 \text{ breads/box})(0.45 \text{ kg/bread}) = 13.5 \text{ kg/box}$$

The amount of heat removed as the breads are cooled from 20 to 0°C and then frozen 0 to -12°C are

$$\dot{Q}_{\text{bread, cooling}} = (\dot{m} c_p \Delta T)_{\text{bread}} = (13.5 \text{ kg})(2.6 \text{ kJ/kg}\cdot^\circ\text{C})(20 - 0)^\circ\text{C} = 702 \text{ kJ}$$

$$\dot{Q}_{\text{bread, freezing}} = \dot{m}_{\text{bread}} (h_1 - h_2) = (13.5 \text{ kg})(137 - 56) \text{ kJ/kg} = 1094 \text{ kJ}$$

The amount of heat removed as the box is cooled from 20 to -12°C is

$$\dot{Q}_{\text{box}} = (\dot{m} c_p \Delta T)_{\text{box}} = (1.5 \text{ kg})(1.9 \text{ kJ/kg}\cdot^\circ\text{C})[(20 - (-12))^\circ\text{C}] = 91 \text{ kJ}$$

Then the total heat removed as the breads and their box are cooled from 20 to -12°C becomes

$$Q_{\text{total}} = Q_{\text{bread, cooling}} + Q_{\text{bread, freezing}} + Q_{\text{box}} = 702 + 1094 + 91 = \mathbf{1887 \text{ kJ}}$$

(b) Noting that the refrigeration time is 3 h, the average rate of heat removal from the breads and the box to the air becomes

$$\dot{Q}_{\text{avg}} = \frac{Q_{\text{total}}}{\Delta t} = \frac{1887 \text{ kJ}}{3 \times 3600 \text{ s}} = \mathbf{0.175 \text{ kW}}$$

17-69 The center temperature of eggs is to be lowered to 12°C during cooling. The cooling time, the temperature difference between the center and the surface of the eggs, and the amount of heat transfer per egg are to be determined.

Assumptions 1 The eggs are spherical in shape with a radius of $r_0 = 3$ cm. **2** Heat conduction in the eggs is one-dimensional in the radial direction because of the symmetry about the midpoint. **3** The thermal properties of the eggs are constant. **4** The heat transfer coefficient is constant and uniform over the entire surface. **5** The Fourier number is $\tau > 0.2$ so that the one-term approximate solutions (or the transient temperature charts) are applicable (this assumption will be verified).

Properties The properties of the eggs are given to be $\rho = 1.08$ g/cm³, $k = 0.56$ W/m·°C, $c_p = 3.34$ kJ/kg·°C, and $\alpha = 0.14 \times 10^{-6}$ m²/s.

Analysis The radius of the egg is determined from

$$r = \left(\frac{3}{4\pi} \frac{m_{\text{egg}}}{\rho_{\text{egg}}} \right)^{1/3} = \left(\frac{3}{4\pi} \frac{70 \text{ g}}{1.08 \text{ g/cm}^3} \right)^{1/3} = 2.49 \text{ cm}$$

Then the time required to cool the mid section of the potatoes to $T_0 = 12^\circ\text{C}$ is determined from the one-term solution relation for spheres presented in Chap. 4. First we find the Biot number:

$$\text{Bi} = \frac{hr_0}{k} = \frac{(45 \text{ W/m}^2 \cdot ^\circ\text{C})(0.0249 \text{ m})}{0.56 \text{ W/m} \cdot ^\circ\text{C}} = 2.00$$

From Table 4-2 we read, for a sphere, $\lambda_1 = 2.0288$ and $A_1 = 1.4793$. Substituting these values into the one-term solution gives

$$\theta_0 = \frac{T_0 - T_\infty}{T_i - T_\infty} = A_1 e^{-\lambda_1^2 \tau} \rightarrow \frac{12 - 2}{32 - 2} = 1.4793 e^{-(2.0288)^2 \tau} \rightarrow \tau = 0.362$$

which is greater than 0.2 and thus the one-term solution is applicable. Then the cooling time becomes

$$\tau = \frac{\alpha t}{r_0^2} \rightarrow t = \frac{r_0^2 \tau}{\alpha} = \frac{(0.362)(0.0249 \text{ m})^2}{0.14 \times 10^{-6} \text{ m}^2/\text{s}} = 1603 \text{ s} = \mathbf{26.7 \text{ min}}$$

The lowest temperature during cooling will occur on the surface ($r/r_0 = 1$), and is determined to be

$$\frac{T(r) - T_\infty}{T_i - T_\infty} = A_1 e^{-\lambda_1^2 \tau} \frac{\sin(\lambda_1 r / r_0)}{\lambda_1 r / r_0} \rightarrow \frac{T(r_0) - T_\infty}{T_i - T_\infty} = \frac{T_0 - T_\infty}{T_i - T_\infty} \frac{\sin(\lambda_1 r_0 / r_0)}{\lambda_1 r_0 / r_0}$$

$$\text{Substituting,} \quad \frac{T(r_0) - 2}{32 - 2} = \frac{12 - 2}{32 - 2} \frac{\sin(2.0288 \text{ rad})}{2.0288} \rightarrow T(r_0) = 6.4^\circ\text{C}$$

Therefore, the temperature difference between the center and the surface is

$$\Delta T = T_0 - T(r_0) = 12 - 6.4 = \mathbf{5.6^\circ\text{C}}$$

The maximum heat transfer from the egg is

$$Q_{\text{max}} = mc_p (T_i - T_\infty) = (0.07 \text{ kg})(3.34 \text{ kJ/kg} \cdot ^\circ\text{C})(32 - 2)^\circ\text{C} = 7.01 \text{ kJ}$$

Also,

$$\frac{Q}{Q_{\text{max}}} = 1 - 3\theta_0 \frac{\sin \lambda_1 - \lambda_1 \cos \lambda_1}{\lambda_1^3} = 1 - 3 \times 0.333 \frac{\sin(2.0288 \text{ rad}) - 2.0288 \cos(2.0288 \text{ rad})}{2.0288^3} = 0.785$$

Then the heat transfer from the egg becomes

$$Q = \frac{Q}{Q_{\text{max}}} Q_{\text{max}} = 0.785 \times (7.01 \text{ kJ}) = \mathbf{5.50 \text{ kJ}}$$

Alternative solution We could also solve this problem using transient temperature charts. There may be a slight difference between the two results, however, because of the reading errors of the chart.

17-70E A refrigeration system is to cool eggs by chilled air at a rate of 10,000 eggs per hour. The rate of heat removal from the eggs, the required volume flow rate of air, and the size of the compressor of the refrigeration system are to be determined.

Assumptions **1** Steady operating conditions exist. **2** The eggs are at uniform temperatures before and after cooling. **3** The cooling section is well-insulated.

Properties The properties of the eggs are given to $\rho = 67.4 \text{ lbm/ft}^3$, $k = 0.32 \text{ Btu/h}\cdot\text{ft}\cdot^\circ\text{F}$, $c_p = 0.80 \text{ Btu/lbm}\cdot^\circ\text{F}$, and $\alpha = 1.5 \times 10^{-6} \text{ ft}^2/\text{s}$. The density and specific heat of air at room conditions are $\rho = 0.075 \text{ lbm/ft}^3$ and $c_p = 0.24 \text{ Btu/lbm}\cdot^\circ\text{F}$ (Table A-15E).

Analysis (a) Noting that eggs are cooled at a rate of 10,000 eggs per hour, eggs can be considered to flow steadily through the cooling section at a mass flow rate of

$$\dot{m}_{\text{egg}} = (10,000 \text{ eggs/h})(0.14 \text{ lbm/egg}) = 1400 \text{ lbm/h} = 0.3056 \text{ kg/s}$$

Then the rate of heat removal from the eggs as they are cooled from 90°F to 50°F at this rate becomes

$$\dot{Q}_{\text{egg}} = (\dot{m} c_p \Delta T)_{\text{egg}} = (1400 \text{ lbm/h})(0.80 \text{ Btu/lbm}\cdot^\circ\text{F})(90 - 50)^\circ\text{F} = \mathbf{44,800 \text{ Btu/h}}$$

(b) All the heat released by the eggs is absorbed by the refrigerated air, and the temperature rise of air is not to exceed 10°F. The minimum mass flow and volume flow rates of air are determined to be

$$\dot{m}_{\text{air}} = \frac{\dot{Q}_{\text{air}}}{(c_p \Delta T)_{\text{air}}} = \frac{44,800 \text{ Btu/h}}{(0.24 \text{ Btu/lbm}\cdot^\circ\text{F})(10^\circ\text{F})} = 18,667 \text{ lbm/h}$$

$$\dot{V}_{\text{air}} = \frac{\dot{m}_{\text{air}}}{\rho_{\text{air}}} = \frac{18,666.6 \text{ lbm/h}}{0.075 \text{ lbm/ft}^3} = \mathbf{248,888 \text{ ft}^3/\text{h}}$$

(c) For a COP of 3.5, the size of the compressor of the refrigeration system must be

$$\dot{W}_{\text{comp}} = \frac{\dot{Q}_{\text{air}}}{\text{COP}} = \frac{44,800 \text{ Btu/h}}{3.5} \left(\frac{1 \text{ kW}}{3412 \text{ Btu/h}} \right) = \mathbf{3.75 \text{ kW}}$$

17-71 Dough is made with refrigerated water in order to absorb the heat of hydration and thus to control the temperature rise during kneading. The temperature to which the city water must be cooled before mixing with flour is to be determined to avoid temperature rise during kneading.

Assumptions **1** Steady operating conditions exist. **2** The eggs are at uniform temperatures before and after cooling. **3** The cooling section is well-insulated.

Properties The specific heats of the flour and the water are given to be 1.76 and 4.18 kJ/kg·°C, respectively. The heat of hydration of dough is given to be 15 kJ/kg.

Analysis It is stated that 2 kg of flour is mixed with 1 kg of water, and thus 3 kg of dough is obtained from each kg of water. Also, 15 kJ of heat is released for each kg of dough kneaded, and thus $3 \times 15 = 45 \text{ kJ}$ of heat is released from the dough made using 1 kg of water.

In order for water to absorb all of this heat and end up at a temperature of 15°C, its temperature before entering the mixing section must be reduced to

$$Q = mc_p(T_2 - T_1) \rightarrow T_1 = T_2 - \frac{Q}{mc_p} = 15^\circ\text{C} - \frac{45 \text{ kJ}}{(1 \text{ kg})(4.18 \text{ kJ/kg}\cdot^\circ\text{C})} = \mathbf{4.2^\circ\text{C}}$$

That is, the water must be precooled to 4.2°C before mixing with flour in order to absorb the entire heat of hydration.

Refrigeration Load of Cold Storage Rooms

17-72C The refrigeration load of a cold storage room represents the total rate of heat transfer by all mechanisms under peak conditions. The refrigeration load consists of transmission load, infiltration load, internal load, product load, and refrigeration equipment load.

17-73C Transmission load is the heat transfer to a cold storage room by conduction. It is transmitted through the wall, the floor, and the ceiling of the cold storage room. The transmission load is determined from

$$\dot{Q}_{\text{transmission}} = UA_o\Delta T$$

where A_o is outside surface area, ΔT is the temperature difference between the outside air and the refrigerated space, and U is the overall heat transfer coefficient. Transmission load can be minimized by insulation.

17-74C Infiltration heat gain for cold storage rooms is the heat gain due to air exchange between the refrigerated space and the surrounding medium. The infiltration heat gain can be minimized by sealing any cracks and openings around the refrigerated room shell.

17-75C The heat removed from the food products as they are cooled to the refrigeration temperature and the heat released as the fresh fruits and vegetables respire in storage constitute the *product load* of the refrigeration system. The three primary components of the product load can be determined from

$$Q_{\text{cooling, fresh}} = mc_{p, \text{fresh}}(T_1 - T_{\text{freeze}})$$

$$Q_{\text{freezing}} = mh_{\text{latent}}$$

$$Q_{\text{cooling, frozen}} = mc_{p, \text{frozen}}(T_{\text{freeze}} - T_2)$$

where m is the mass of the food product, c_p is the specific heat, and T is the temperature.

17-76C The internal load of the refrigeration system is the heat generated by the people, lights, electric motors and other heat dissipating equipment.

17-77C Locating the motors inside the refrigeration room increases the refrigeration load of the room since the heat dissipated by the motors also becomes part of the internal load. Heat in the amount of $(1 - \eta_{\text{motor}})\dot{W}_{\text{fan}}$ (where η_{motor} is the motor efficiency and \dot{W}_{fan} is the fan power) is rejected to the room that houses the motor.

17-78 A box of shrimp is to be frozen in a freezer. The amount of heat that needs to be removed is to be determined.

Assumptions **1** The thermal properties of fresh and frozen shrimp are constant. **2** The entire water content of the shrimps freezes during the process.

Properties For shrimp, the freezing temperature is -2.2°C , the latent heat of fusion is 277 kJ/kg , the specific heat is $3.62\text{ kJ/kg}\cdot^{\circ}\text{C}$ above freezing and $1.89\text{ kJ/kg}\cdot^{\circ}\text{C}$ below freezing. The specific heat of polyethylene box is given to be $2.33\text{ kJ/kg}\cdot^{\circ}\text{C}$.

Analysis The total amount of heat that needs to be removed (the cooling load of the freezer) is the sum of the latent heat and the sensible heats of the shrimp before and after freezing as well as the sensible heat of the box, and is determined as follows:

Cooling fresh shrimp from 8°C to -2.2°C :

$$Q_{\text{cooling, fresh}} = (mc_p \Delta T)_{\text{fresh}} = (40\text{ kg})(3.62\text{ kJ/kg}\cdot^{\circ}\text{C})[8 - (-2.2)]^{\circ}\text{C} = 1477\text{ kJ}$$

Freezing shrimp at -2.2°C :

$$Q_{\text{freezing}} = mh_{\text{latent}} = (40\text{ kg})(277\text{ kJ/kg}) = 11,080\text{ kJ}$$

Cooling frozen shrimp from -2.2°C to -18°C :

$$Q_{\text{cooling, frozen}} = (mc_p \Delta T)_{\text{frozen}} = (40\text{ kg})(1.89\text{ kJ/kg}\cdot^{\circ}\text{C})[-2.2 - (-18)]^{\circ}\text{C} = 1195\text{ kJ}$$

Cooling the box from 8°C to -18°C :

$$Q_{\text{box}} = (mc_p \Delta T)_{\text{box}} = (1.2\text{ kg})(1.4\text{ kJ/kg}\cdot^{\circ}\text{C})[8 - (-18)]^{\circ}\text{C} = 44\text{ kJ}$$

Therefore, the total amount of cooling that needs to be done is

$$Q_{\text{total}} = Q_{\text{cooling, fresh}} + Q_{\text{freezing}} + Q_{\text{cooling, frozen}} + Q_{\text{box}} = 1477 + 11,080 + 1195 + 44 = \mathbf{13,796\text{ kJ}}$$

Discussion Note that most of the cooling load (80 percent of it) is due to the removal of the latent heat during the phase change process. Also, the cooling load due to the box is negligible (less than 1 percent).

17-79E The infiltration rate of a cold storage room is given to be 0.4 ACH. The total infiltration load of the room is to be determined.

Assumptions The moisture in the air is condensed at an average temperature of $(90+35)/2 = 66^\circ\text{F}$.

Properties The heat of vaporization of water at the average temperature of 66°F is 1057 Btu/lbm (Table A-9). The properties of the cold air in the room and the ambient air are determined from the psychrometric chart to be

$$\left. \begin{array}{l} T_{\text{ambient}} = 90^\circ\text{F} \\ \phi_{\text{ambient}} = 90\% \end{array} \right\} \begin{array}{l} \omega_{\text{ambient}} = 0.028\text{lbm/lbmdryair} \\ h_{\text{ambient}} = 52.5\text{Btu/lbm dry air} \end{array}$$

$$\left. \begin{array}{l} T_{\text{room}} = 35^\circ\text{F} \\ \phi_{\text{room}} = 95\% \end{array} \right\} \begin{array}{l} \omega_{\text{room}} = 0.004\text{lbm/lbmdryair} \\ h_{\text{room}} = 12.5\text{Btu/lbm dry air} \\ \nu_{\text{room}} = 12.55\text{ft}^3/\text{lbmdry air} \end{array}$$

Analysis Noting that the infiltration of ambient air will cause the air in the cold storage room to be changed 0.4 times every hour, the air will enter the room at a mass flow rate of

$$\dot{m}_{\text{air}} = \frac{\nu_{\text{room}}}{\nu_{\text{room}}} \text{ACH} = \frac{12 \times 15 \times 30\text{ft}^3}{12.5\text{ft}^3/\text{lbmdry air}} (0.4\text{h}^{-1}) = 172.8\text{ lbm/h}$$

Then the sensible and latent infiltration heat gains of the room become

$$\dot{Q}_{\text{infiltration,sensible}} = \dot{m}_{\text{air}} (h_{\text{ambient}} - h_{\text{room}}) = (172.8\text{ lbm/h})(52.5 - 12.5)\text{Btu/lbm} = 88,560\text{Btu/h}$$

$$\dot{Q}_{\text{infiltration,latent}} = (\omega_{\text{ambient}} - \omega_{\text{room}}) \dot{m}_{\text{air}} h_{fg} = (0.028 - 0.004)(172.8\text{ lbm/h})(1,057\text{Btu/lbm}) = 4,384\text{Btu/h}$$

Therefore,

$$\dot{Q}_{\text{infiltration}} = \dot{Q}_{\text{infiltration,sensible}} + \dot{Q}_{\text{infiltration,latent}} = 88,560 + 4,384 = \mathbf{92,944\text{ Btu/h}}$$

Discussion Note that the refrigeration system of this cold storage room must be capable of removing heat at a rate of 92,944 Btu/h to meet the infiltration load. Of course, the total refrigeration capacity of the system will have to be larger to meet the transmission, product, etc. loads as well.

17-80 A holding freezer with R -3 walls is maintained at -25°C in an environment at 15°C . The amount of electrical energy and money this facility will save per year by increasing the insulation value of the walls to the recommended level of R -6.5 is to be determined. Also to be determined is the percent error involved in the wall resistance if the convection resistances on both sides of the wall are ignored.

Assumptions **1** Steady operating conditions exist. **2** The thermal properties of refrigerator walls are constant. **3** The heat transfer coefficients on the inner and outer surfaces of the walls are constant and uniform.

Properties The walls of the refrigerator have an R -value of $3\text{ m}^2\cdot^{\circ}\text{C}/\text{W}$.

Analysis The outside surface area of the walls of the holding freezer is

$$A_o = 2 \times (7\text{ m})(80 + 25\text{ m}) = 1470\text{ m}^2$$

The current rate of heat gain through the walls is

$$\dot{Q}_{\text{current}} = \frac{A_o(T_o - T_i)}{\frac{1}{h_i} + R_{\text{wall}} + \frac{1}{h_o}} = \frac{(1470\text{ m}^2)[15 - (-25)]^{\circ}\text{C}}{\left(\frac{1}{10} + 3 + \frac{1}{20}\right)\text{ m}^2\cdot^{\circ}\text{C}/\text{W}} = 18,667\text{ W}$$

The rate of heat gain through the walls after insulation is installed is

$$\dot{Q}_{\text{insulated}} = \frac{A_o(T_o - T_i)}{\frac{1}{h_i} + R_{\text{wall,insulated}} + \frac{1}{h_o}} = \frac{(1470\text{ m}^2)[15 - (-25)^{\circ}\text{C}]}{\left(\frac{1}{10} + 6.5 + \frac{1}{20}\right)\text{ m}^2\cdot^{\circ}\text{C}/\text{W}} = 8842\text{ W}$$

Therefore, the rates of heat and electricity saved due to insulation are

$$\begin{aligned}\dot{Q}_{\text{saved}} &= \dot{Q}_{\text{current}} - \dot{Q}_{\text{insulated}} = 18,667 - 8842 = 9825\text{ W} \\ \dot{E}_{\text{electric,saved}} &= \dot{Q}_{\text{saved}} / \text{COP} = (9825\text{ W}) / 1.3 = 5814\text{ W}\end{aligned}$$

Noting that the unit cost of electricity is $\$0.10/\text{kWh}$ and assuming year-around continual operation, the amount of electricity and money saved per year due to insulation are

$$\text{Electricity saved} = \dot{E}_{\text{electric,saved}} \times (\text{Operating hours}) = (5.814\text{ kW})(365 \times 24\text{ h/yr}) = \mathbf{50,930\text{ kW/yr}}$$

$$\text{Moneysaved} = (\text{Electricity saved})(\text{Unit cost of electricity}) = (50,930\text{ kWh/yr})(\$0.10/\text{kWh}) = \mathbf{\$5093/\text{yr}}$$

The total thermal resistance of the wall is

$$R_{\text{total}} = \frac{1}{h_i} + R_{\text{ins}} + \frac{1}{h_o} = \frac{1}{10} + 3 + \frac{1}{20} = 3.15\text{ m}^2\cdot^{\circ}\text{C}/\text{W}$$

Discussion If the convection resistances on both sides are neglected, the total resistance would simply be the wall resistance, which is $R_{\text{wall}} = 3\text{ m}^2\cdot^{\circ}\text{C}/\text{W}$. Therefore, neglecting the convection resistances would cause an error of $(3.15 - 3.0)/3.15 = 0.048$ or 4.8%, which is acceptable for most engineering purposes. The error in the insulated wall case would be half as much.

17-81 A chiller room is maintained at -2°C in an environment at 18°C . The amount of electrical energy and money this facility will save per year by increasing the insulation value of the roof to the recommended level of $R-7$ are to be determined.

Assumptions **1** Steady operating conditions exist. **2** The thermal properties of the roof are constant. **3** The heat transfer coefficients on the inner and outer surfaces of the walls are constant and uniform.

Properties The roof of the room has an R -value of $2\text{ m}^2\cdot^{\circ}\text{C}/\text{W}$.

Analysis The outside surface area of the roof of the chilling room is

$$A_o = (30\text{ m})(60\text{ m}) = 1800\text{ m}^2$$

The current rate of heat gain through the roof is

$$\dot{Q}_{\text{current}} = \frac{A_o(T_o - T_i)}{\frac{1}{h_i} + R_{\text{roof}} + \frac{1}{h_o}} = \frac{(1800\text{ m}^2)[18 - (-2)^{\circ}\text{C}]}{\left(\frac{1}{10} + 2 + \frac{1}{25}\right)\text{ m}^2\cdot^{\circ}\text{C}/\text{W}} = 16,822\text{ W}$$

The rate of heat gain through the walls after insulation is installed is

$$\dot{Q}_{\text{insulated}} = \frac{A_o(T_o - T_i)}{\frac{1}{h_i} + R_{\text{roof,insulated}} + \frac{1}{h_o}} = \frac{(1800\text{ m}^2)[18 - (-25)]^{\circ}\text{C}}{\left(\frac{1}{10} + 7 + \frac{1}{25}\right)\text{ m}^2\cdot^{\circ}\text{C}/\text{W}} = 5042\text{ W}$$

Therefore, the rates of heat and electricity saved due to insulation are

$$\begin{aligned}\dot{Q}_{\text{saved}} &= \dot{Q}_{\text{current}} - \dot{Q}_{\text{insulated}} = 16,822 - 5042 = 11,780\text{ W} \\ \dot{E}_{\text{electric,saved}} &= \dot{Q}_{\text{saved}} / \text{COP} = (11,780\text{ W}) / 2.4 = 4908\text{ W}\end{aligned}$$

Noting that the unit cost of electricity is $\$0.09/\text{kWh}$ and assuming year-around continual operation, the amount of electricity and money saved per year due to insulation are

$$\text{Electricity saved} = \dot{E}_{\text{electric,saved}} \times (\text{Operating hours}) = (4.908\text{ kW})(365 \times 24\text{ h/yr}) = \mathbf{42,997\text{ kW/yr}}$$

$$\text{Moneysaved} = (\text{Electricity saved})(\text{Unit cost of electricity}) = (42,997\text{ kWh/yr})(\$0.09/\text{kWh}) = \mathbf{\$3870/\text{yr}}$$

17-82 A cold storage room with an infiltration rate of 0.2 ACH is maintained at 6°C in an environment at 20°C. The internal load of this cold storage room and the infiltration load are to be determined. The amount of electrical energy and money this facility will save per year as a result of switching to fluorescent lighting are also to be determined.

Assumptions **1** Steady operating conditions exist. **2** The thermal properties of the roof are constant. **3** The heat transfer coefficients on the inner and outer surfaces of the walls are constant and uniform. **4** The condensation of moisture is disregarded.

Properties The roof of the room has an R -value of $2 \text{ m}^2 \cdot \text{°C}/\text{W}$. The specific heat of air is $c_p = 1.0 \text{ kJ}/\text{kg} \cdot \text{°C}$ (Table A-9).

Analysis (a) The internal heat load of this cold storage room consists of the heat generated by the people, lights, and electric motors that are determined to be

$$\dot{Q}_{\text{people}} = (\text{Number of People})[270 - 6T(\text{°C}) \text{ W}] = (15)(270 - 6 \times 6 \text{ W}) = 3510 \text{ W}$$

$$\dot{Q}_{\text{light}} = (\text{Number of lights})(\text{Wattage}) = (150)(100 \text{ W}) = 15,000 \text{ W}$$

A total of 25 kW is dissipated through the fans and the motors as heat to the storage room. Therefore, the heat dissipation caused by the motors is 25 kW. Then the total internal heat load becomes

$$\dot{Q}_{\text{total}} = \dot{Q}_{\text{people}} + \dot{Q}_{\text{light}} + \dot{Q}_{\text{motor}} = 3510 + 15,000 + 25,000 = 43,510 \text{ W} = \mathbf{43.51 \text{ kW}}$$

(b) Noting that the infiltration of ambient air will cause the air in the cold storage room to be changed 0.2 times every hour, the air will enter the room at a mass flow rate of

$$\dot{m}_{\text{air}} = \frac{V_{\text{room}}}{v_{\text{room}}} \text{ACH} = \frac{50 \times 30 \times 7 \text{ m}^3}{0.796 \text{ m}^3/\text{kg dry air}} (0.2 \text{ h}^{-1}) = 2,638 \text{ kg/h} = 0.733 \text{ kg/s}$$

The condensation of moisture in the air and thus the latent heat load is said to be negligible. Then the sensible infiltration heat gain of the room is determined to be

$$\dot{Q}_{\text{infiltration}} = \dot{m}_{\text{air}} c_p (T_o - T_i) = (0.733 \text{ kg/s})(1.0 \text{ kJ}/\text{kg} \cdot \text{°C})(20 - 6) \text{°C} = \mathbf{10.3 \text{ kW}}$$

The electrical energy consumed by the proposed fluorescent lamps is

$$\dot{Q}_{\text{light, proposed}} = (\text{Number of lights})(\text{Wattage}) = (40)(110 \text{ W}) = 4400 \text{ W}$$

Noting that the electricity consumed by the current lighting is 15,000 W and that the lights are on 15 h a day, the total electrical energy (from direct lighting and refrigeration) saved by switching to fluorescent lamps per year is

$$\begin{aligned} E_{\text{lighting, saved}} &= (\text{Current lighting energy} - \text{Proposed lighting energy})(\text{Operating hours}) \\ &= (15,000 \text{ W} - 4400 \text{ W})(15 \text{ h/day} \times 365 \text{ days/yr}) \\ &= 58,036 \text{ kWh/yr} \end{aligned}$$

$$E_{\text{refrigeration, saved}} = E_{\text{lighting, saved}} / \text{COP} = (58,036 \text{ kWh/yr}) / 2.8 = 20,727 \text{ kWh/yr}$$

$$E_{\text{saved, total}} = E_{\text{lighting, saved}} + E_{\text{refrigeration, saved}} = 58,036 + 20,727 = \mathbf{78,763 \text{ kWh/yr}}$$

Noting that the unit cost of electricity is \$0.09/kWh, the amount of money saved is

$$\begin{aligned} \text{Cost Savings} &= (\text{Energy Savings})(\text{Unit cost of energy}) \\ &= (78,793 \text{ kWh/yr})(\$0.09/\text{kWh}) \\ &= \mathbf{\$7,089/\text{yr}} \end{aligned}$$

Transportation of Refrigerated Foods

17-83C Refrigerated trucks are insulated in order to reduce the rate of heat gain into the refrigerated space. A very thick layer of insulation in the walls of a refrigerated truck reduces the rate of heat gain into the refrigerated space, but it also costs more and reduces the available cargo space.

17-84C Transporting some highly perishable products by airplanes is worthwhile at times of short supply and higher prices. Flowers, strawberries, fresh meats, sea foods, and early season fruits and vegetables are commonly shipped by air.

17-85C Trucks are precooled before they are loaded to minimize the temperature rise of the refrigerated food products during loading and transit. Refrigerated trucks need to be equipped with heating systems to protect food products from freezing in winter.

17-86C Liquid drinks such as orange juice have very large heat capacities, and thus they can absorb a large quantity of heat with a small temperature rise. Field experience shows that precooled orange juice can be transported safely in insulated trucks without any refrigeration. Therefore, the claim is reasonable.

17-87E Precooled orange range juice is to be transported in a cylindrical tank by a truck. It is to be determined if the orange juice can be transported without any refrigeration.

Assumptions Thermal properties of the orange juice and insulation are constant.

Properties The thermal conductivity of urethane is given to be $k = 0.017 \text{ Btu/h}\cdot\text{ft}\cdot^\circ\text{F}$. The density and specific heat of refrigerated orange juice at temperatures near 0°C are given to be $\rho_{\text{juice}} = 62.4 \text{ lbm/ft}^3$ and $c_{p,\text{juice}} = 0.90 \text{ Btu/lbm}\cdot^\circ\text{F}$.

Analysis Problems of this kind that involve “checking” are best solved by performing the calculations under the worst conditions, with the understanding that if the performance is satisfactory under those conditions, it will surely be satisfactory under any conditions.

We take the average ambient temperature to be 92°F , which is the highest possible, and raise it by 12°F to 104°F to account for the radiation from the sun and the pavement. We also assume the metal sheets to offer no resistance to heat transfer, and assume the convection resistances on the inner and outer sides of the tank wall to be negligible. Under those conditions, the inner and outer surface temperatures of the insulation will be equal to the orange juice and ambient temperatures, respectively. Further, we take the orange juice temperature to be 35°F during heat transfer calculations (to maximize the temperature difference), and take the heat transfer area to be the outer surface area of the tank (instead of the smaller inner surface area) which is determined to be

$$A = 2A_{\text{base}} + A_{\text{side}} = 2(\pi D_o^2 / 4) + (\pi D_o)L_o = 2\pi(6.3\text{ft})^2 / 4 + \pi(6.3\text{ft})(27\text{ft}) = 596.7 \text{ ft}^2$$

Then the rate of heat transfer through the insulation into the orange juice becomes

$$\dot{Q} = k_{\text{ins}} A \frac{\Delta T_{\text{ins}}}{L_{\text{ins}}} = (0.015 \text{ Btu/h}\cdot\text{ft}\cdot^\circ\text{F})(596.7 \text{ ft}^2) \frac{(104 - 35)^\circ\text{C}}{1/12 \text{ ft}} = \mathbf{7411 \text{ Btu/h}}$$

This is the highest possible rate of heat transfer into the orange juice since it is determined under the most favorable conditions for heat transfer.

At an average velocity of 35 mph, transporting the orange juice 1250 miles will take

$$\Delta t = \frac{\text{Distance traveled}}{\text{Average velocity}} = \frac{1250 \text{ miles}}{35 \text{ mph}} = 35.7 \text{ h}$$

Then the total amount of heat transfer to the orange juice during this long trip becomes

$$Q = \dot{Q}\Delta t = (7411 \text{ Btu/h})(35.7 \text{ h}) = 264,570 \text{ Btu}$$

Noting that the thickness of insulation is 1-in on all sides, the volume and mass of the orange juice in a full tank are

$$V_{\text{orange juice}} = (\pi D_i^2 / 4)L_i = [\pi(6.134 \text{ ft})^2 / 4](26.83 \text{ ft}) = 792.8 \text{ ft}^3$$

$$m_{\text{orange juice}} = \rho V_{\text{orange juice}} = (62.4 \text{ lbm/ft}^3)(792.8 \text{ ft}^3) = 49,471 \text{ lbm}$$

Then the transfer of 264,570 Btu of heat into the orange juice will raise its temperature to

$$Q = mc_p(T_2 - T_1) \rightarrow T_2 = T_1 + \frac{Q}{mc_p} = 35^\circ\text{F} + \frac{264,570 \text{ Btu}}{(49,471 \text{ lbm})(0.90 \text{ Btu/lbm}\cdot^\circ\text{F})} = 40.9^\circ\text{F}$$

That is, the temperature of the orange juice will rise from 35 to 40.9°F during this long trip under the most adverse conditions, which is well below the 46°F limit. Therefore, the orange juice can be transported even longer distances without any refrigeration.

17-88 A large truck is to transport 30,000 kg of oranges. The refrigeration load of the truck and the amount of ice needed to meet this need for a 20 h long trip are to be determined.

Assumptions 1 Infiltrating air exits the truck saturated at 4°C. **2** The moisture in the air is condensed out at the exit temperature of 4°C.

Properties The humidity ratio of air is given to be 0.0205 kg water vapor/kg dry air at 27°C and 90 percent relative humidity, and 0.0047 at 3°C and 100 percent relative humidity. The latent heat of vaporization of water at 15°C is given to be 2466 kJ/kg. The density of air is given to be 1.15 kg/m³, and its specific heat at the ambient temperature of 27°C is $c_p = 1.0$ kJ/kg·°C (Table A-11). The latent heat of ice is 333.7 kJ/kg.

Analysis The total refrigeration load of the truck is due to the heat gain by transmission, infiltration, and respiration. Noting that UA is given to be 80 W/°C, the rate of heat gain by transmission is determined to be

$$\dot{Q}_{\text{transmission}} = UA\Delta T = (80 \text{ W/}^\circ\text{C})(27 - 4)^\circ\text{C} = 1840 \text{ W}$$

The rate of heat generation by the oranges as a result of respiration is

$$\dot{Q}_{\text{respiration}} = mh_{\text{respiration}} = (30,000 \text{ kg})(0.017 \text{ W/kg}) = 510 \text{ W}$$

The ambient air enters the truck at a rate of 4 L/s, which corresponds to a mass flow rate of

$$\dot{m}_{\text{air}} = \rho \dot{V}_{\text{air}} = (1.15 \text{ kg/m}^3)(0.04 \text{ m}^3/\text{s}) = 0.0046 \text{ kg/s}$$

Noting that an equal amount of air at 4°C must leave the truck, the sensible heat gain due to infiltration is

$$\dot{Q}_{\text{infiltration, sensible}} = (mc_p \Delta T)_{\text{air}} = (0.0046 \text{ kg/s})(1.0 \text{ kJ/kg}\cdot^\circ\text{C})(27 - 4)^\circ\text{C} = 0.106 \text{ kJ/s} = 106 \text{ W}$$

Each kg of ambient air is said to contain 0.0205 kg of water vapor which condenses in the truck and is drained out as a liquid, releasing $h_{fg} = 2466$ kJ/kg of latent heat. Then the latent heat gain of the truck becomes

$$\dot{Q}_{\text{infiltration}} = \dot{m}_{\text{water}} h_{fg} = (0.0205 \text{ kg/kg dry air})(0.0046 \text{ kg/s})(2466 \text{ kJ/kg}) = 233 \text{ W}$$

Note that the latent heat part of the infiltration is about twice as large as the sensible part. Then the refrigeration load or the total rate of heat gain by the truck becomes

$$\dot{Q}_{\text{total}} = \dot{Q}_{\text{transmission}} + \dot{Q}_{\text{respiration}} + \dot{Q}_{\text{infiltration}} = 1,840 + 510 + (106 + 233) = \mathbf{2689 \text{ W}}$$

The total amount of heat gain during the 15 h long trip is

$$Q_{\text{total}} = \dot{Q}_{\text{total}} \Delta t = (2689 \text{ J/s})(15 \times 3600 \text{ s}) = 145,206,000 \text{ J} = 145,206 \text{ kJ}$$

Then the amount of ice needed to meet this refrigeration load is determined from

$$m_{\text{ice}} = \frac{Q_{\text{total}}}{h_{\text{latent, ice}}} = \frac{145,206 \text{ kJ}}{334 \text{ kJ/kg}} = \mathbf{435 \text{ kg}}$$

Discussion Note that about half of a ton ice (1.5 percent of the mass of the load) is sufficient in this case to maintain the oranges at 4°C.

17-89 A walls of a large freezer truck is made of 2.5-cm thick urethane insulation, which is to be upgraded to 8-cm thick insulation. The reduction in the transmission heat gain and the reduction in the cargo space of the truck are to be determined.

Assumptions 1 The convection heat transfer coefficients remain constant. **2** The properties of insulation are constant. **3** The thermal resistances of metal plates are negligible.

Properties The thermal conductivity of insulation is given to be $k = 0.026 \text{ W/m}\cdot\text{C}$.

Analysis The outside surface area of the freezer truck is

$$A_o = 2 \times (14 \times 4 + 4 \times 2.5 + 14 \times 2.5) \text{ m}^2 = 202 \text{ m}^2$$

The current rate of heat gain through the walls is

$$\dot{Q}_{\text{current}} = \frac{A_o (T_o - T_i)}{\frac{1}{h_i} + \frac{L_{\text{ins}}}{k_{\text{ins}}} + \frac{1}{h_o}} = \frac{(202 \text{ m}^2)[25 - (-18)]^\circ\text{C}}{\frac{1}{8 \text{ W/m}^2 \cdot \text{C}} + \frac{0.025 \text{ m}}{0.026 \text{ W/m}\cdot\text{C}} + \frac{1}{40 \text{ W/m}^2 \cdot \text{C}}} = 7814 \text{ W}$$

The rate of heat gain through the walls after insulation is added will be

$$\dot{Q}_{\text{insulated}} = \frac{A_o (T_o - T_i)}{\frac{1}{h_i} + \frac{L_{\text{ins}}}{k_{\text{ins}}} + \frac{1}{h_o}} = \frac{(202 \text{ m}^2)[25 - (-18)]^\circ\text{C}}{\frac{1}{8 \text{ W/m}^2 \cdot \text{C}} + \frac{0.08 \text{ m}}{0.026 \text{ W/m}\cdot\text{C}} + \frac{1}{40 \text{ W/m}^2 \cdot \text{C}}} = 2692 \text{ W}$$

Therefore, the reduction in the refrigeration load due to added insulation is

$$\dot{Q}_{\text{reduction}} = \dot{Q}_{\text{current}} - \dot{Q}_{\text{insulated}} = 7814 - 2692 = \mathbf{5122 \text{ W}}$$

The reduction in the cargo load of the truck as a result of increasing the thickness of insulation from 2.5 cm to 8 cm while holding the outer dimensions constant is

$$\begin{aligned} \mathcal{V}_{\text{reduced}} &= \mathcal{V}_{\text{current}} - \mathcal{V}_{\text{insulated}} \\ &= (14 - 0.05)(2.5 - 0.05)(4 - 0.05) - (14 - 0.18)(2.5 - 0.16)(4 - 0.16) = 10.8 \text{ m}^3 \\ m_{\text{reduced}} &= \rho_{\text{gross}} \mathcal{V}_{\text{reduced}} = (600 \text{ kg/m}^3)(10.8 \text{ m}^3) = \mathbf{6480 \text{ kg}} \end{aligned}$$

17-90 The cargo space of a refrigerated truck is to be cooled from 25°C to an average temperature of 5°C . The time it will take for an 8-kW refrigeration system to precool the truck is to be determined.

Assumptions 1 The ambient conditions remain constant during precooling. **2** The doors of the truck are tightly closed so that the infiltration heat gain is negligible. **3** The air inside is sufficiently dry so that the latent heat load on the refrigeration system is negligible.

Properties The density of air is given to be 1.2 kg/m^3 , and its specific heat at the average temperature of 15°C is $c_p = 1.0 \text{ kJ/kg}\cdot\text{C}$ (Table A-15).

Analysis The mass of air in the truck is

$$m_{\text{air}} = \rho_{\text{air}} \mathcal{V}_{\text{truck}} = (1.2 \text{ kg/m}^3)(12 \text{ m} \times 2.3 \text{ m} \times 3.5 \text{ m}) = 116 \text{ kg}$$

The amount of heat removed as the air is cooled from 25 to 5°C

$$Q_{\text{cooling,air}} = (mc_p \Delta T)_{\text{air}} = (116 \text{ kg})(1.0 \text{ kJ/kg}\cdot\text{C})(25 - 5)^\circ\text{C} = 2320 \text{ kJ}$$

Noting that UA is given to be 80 W/C and the average air temperature in the trunk during precooling is $(25+5)/2 = 15^\circ\text{C}$, the average rate of heat gain by transmission is determined to be

$$\dot{Q}_{\text{transmission,ave}} = UA\Delta T = (80 \text{ W/C})(25 - 15)^\circ\text{C} = 800 \text{ W} = 0.80 \text{ kJ/s}$$

Therefore, the time required to cool the truck from 25 to 5°C is determined to be

$$\dot{Q}_{\text{refrig.}} \Delta t = Q_{\text{cooling,air}} + \dot{Q}_{\text{transmission}} \Delta t \rightarrow \Delta t = \frac{Q_{\text{cooling,air}}}{\dot{Q}_{\text{refrig.}} - \dot{Q}_{\text{transmission}}} = \frac{2320 \text{ kJ}}{(8 - 0.8) \text{ kJ/s}} = 322 \text{ s} \cong \mathbf{5.4 \text{ min}}$$

Review Problems

17-91 Broccoli is to be vacuum cooled in an insulated spherical vacuum chamber. The final mass of broccoli after cooling and the error involved in neglecting heat transfer through the walls of the chamber are to be determined.

Assumptions 1 The thermal properties of broccoli are constant. **2** Heat transfer through the walls of the vacuum chamber is negligible. **3** All the air in the chamber is sucked out by the vacuum pump so that there is only vapor at the end.

Properties The thermal conductivity of urethane insulation is given to be $k = 0.026 \text{ W/m}\cdot^\circ\text{C}$. The specific heat of broccoli near freezing temperatures is $3.86 \text{ kJ/kg}\cdot^\circ\text{C}$ (Table A-7). At the average temperature of $(25 + 4)/2 = 14.5^\circ\text{C}$, the latent heat of vaporization of water is $h_{fg} = 2464 \text{ kJ/kg}$ (Table A-9).

Analysis (a) The amount of heat transfer to cool 6,000 kg of broccoli from 25 to 4°C is

$$Q_{\text{broccoli}} = (mc_p \Delta T)_{\text{broccoli}} = (6000 \text{ kg})(3.86 \text{ kJ/kg}\cdot^\circ\text{C})(25 - 4)^\circ\text{C} = 486,400 \text{ kJ}$$

Noting that each kg of water in broccoli absorbs 2464 kJ of heat as it evaporates, and disregarding any heat gain through the walls of the vacuum chamber, the amount of moisture removed is determined to be

$$Q_{\text{broccoli}} = m_{\text{evap}} h_{fg} \rightarrow m_{\text{evap}} = \frac{Q_{\text{broccoli}}}{h_{fg}} = \frac{486,400 \text{ kJ}}{2464 \text{ kJ/kg}} = 197 \text{ kg}$$

Therefore, the final mass of the wet broccoli is

$$m_{\text{broccoli,final}} = m_{\text{broccoli,initial}} - m_{\text{evap}} = 6000 - 197 = \mathbf{5803 \text{ kg}}$$

To determine the maximum amount of heat transfer to the vacuum chamber through its shell, we assume the heat transfer coefficients at the inner and outer surfaces to be infinity so that the inner and outer surface temperatures of the shell are equal to the temperatures of medium surrounding them. We also neglect the thermal resistance of the metal plates. Then using the average chamber temperature for the inner surface, the rate of heat gain is determined to be

$$\dot{Q}_{\text{gain}} = \frac{k4\pi r_{\text{out}} r_{\text{in}} (T_{\text{out}} - T_{\text{in,avg}})}{r_{\text{out}} - r_{\text{in}}} = \frac{(0.026 \text{ W/m}\cdot^\circ\text{C})4\pi(2 \text{ m})(197 \text{ m})(25 - 14.5)^\circ\text{C}}{(2 - 1.97) \text{ m}} = 451 \text{ W} = 0.451 \text{ kW}$$

Then the amount of heat gain in 1 h becomes

$$Q_{\text{gain}} = \dot{Q}_{\text{gain}} \Delta t = (0.451 \text{ kW})(3600 \text{ s}) = 1624 \text{ kJ}$$

which is $1624/486,400 = 0.0033$ or 0.33% of the heat removed from the broccoli. Therefore, the claim that heat gain through the chamber walls is less than 5 percent is reasonable.

17-92 The center temperature of apples is to be lowered to 8°C during cooling by chilled air or chilled water. The cooling time and temperature difference between the center and the surface of the apples for both cases are to be determined.

Assumptions 1 The apples are spherical in shape with a radius of $r_o = 3.25$ cm. **2** Heat conduction in the apples is one-dimensional in the radial direction because of symmetry about the midpoint. **3** The thermal properties of apples are constant. **4** The heat transfer coefficient is constant and uniform over the entire surface. **5** The Fourier number is $\tau > 0.2$ so that the one-term approximate solutions (or the transient temperature charts) are applicable (this assumption will be verified).

Properties The thermal conductivity and thermal diffusivity of apples are given to be $k = 0.42$ W/m $\cdot^\circ\text{C}$ and $\alpha = 0.14 \times 10^{-6}$ m 2 /s.

Analysis (a) For air cooling, the time required to cool the mid section of the apples to $T_o = 8^\circ\text{C}$ is determined from the one-term solution relation for spheres presented in Chap. 4. First we find the Biot number:

$$\text{Bi} = \frac{hr_o}{k} = \frac{(45 \text{ W/m}^2 \cdot ^\circ\text{C})(0.0325 \text{ m})}{0.42 \text{ W/m} \cdot ^\circ\text{C}} = 3.482$$

From Table 4-2 we read, for a sphere, $\lambda_1 = 2.369$ and $A_1 = 1.670$. Substituting these values into the one-term solution gives

$$\theta_0 = \frac{T_o - T_\infty}{T_i - T_\infty} = A_1 e^{-\lambda_1^2 \tau} \rightarrow \frac{8-1}{22-1} = 1.670 e^{-(2.369)^2 \tau} \rightarrow \tau = 0.287$$

which is greater than 0.2 and thus the one-term solution is applicable. Then the cooling time becomes

$$\tau = \frac{\alpha t}{r_o^2} \rightarrow t = \frac{r_o^2 \tau}{\alpha} = \frac{(0.0325 \text{ m})^2 (0.287)}{0.14 \times 10^{-6} \text{ m}^2/\text{s}} = 2165 \text{ s} = \mathbf{36.1 \text{ min}}$$

The lowest temperature during cooling will occur on the surface ($r/r_o = 1$), and is determined to be

$$\frac{T(r) - T_\infty}{T_i - T_\infty} = A_1 e^{-\lambda_1^2 \tau} \frac{\sin(\lambda_1 r / r_o)}{\lambda_1 r / r_o} \rightarrow \frac{T(r_o) - T_\infty}{T_i - T_\infty} = \frac{T_o - T_\infty}{T_i - T_\infty} \frac{\sin(\lambda_1 r_o / r_o)}{\lambda_1 r_o / r_o}$$

Substituting,

$$\frac{T(r_o) - 1}{22 - 1} = \frac{8 - 1}{22 - 1} \frac{\sin(2.369 \text{ rad})}{2.369} \rightarrow T(r_o) = 3.6^\circ\text{C}$$

Therefore, the temperature difference between the center and the surface of the apples is

$$\Delta T = T_{\text{center}} - T_{\text{surface}} = 8 - 3.6 = \mathbf{4.4^\circ\text{C}}$$

(b) For water cooling, the time required to cool the mid section of the apples to $T_o = 8^\circ\text{C}$ is determined similarly:

$$\text{Bi} = \frac{hr_o}{k} = \frac{(80 \text{ W/m}^2 \cdot ^\circ\text{C})(0.0325 \text{ m})}{0.42 \text{ W/m} \cdot ^\circ\text{C}} = 6.190 \xrightarrow{\text{Table 4-2}} \lambda_1 = 2.666 \text{ and } A_1 = 1.840.$$

Substituting,

$$\theta_0 = \frac{T_o - T_\infty}{T_i - T_\infty} = A_1 e^{-\lambda_1^2 \tau} \rightarrow \frac{8-1}{22-1} = 1.840 e^{-(2.666)^2 \tau} \rightarrow \tau = 0.240$$

which is greater than 0.2. Then the cooling time becomes

$$\tau = \frac{\alpha t}{r_o^2} \rightarrow t = \frac{r_o^2 \tau}{\alpha} = \frac{(0.0325 \text{ m})^2 (0.240)}{0.14 \times 10^{-6} \text{ m}^2/\text{s}} = 1811 \text{ s} = \mathbf{30.2 \text{ min}}$$

Also,
$$\frac{T(r_o) - 1}{22 - 1} = \frac{8 - 1}{22 - 1} \frac{\sin(2.666 \text{ rad})}{2.666} \rightarrow T(r_o) = 2.2^\circ\text{C}$$

Therefore, the temperature difference between the center and the surface of the apples in this case is

$$\Delta T = T_{\text{center}} - T_{\text{surface}} = 8 - 2.2 = \mathbf{5.8^\circ\text{C}}$$

17-93E Cod fish in a polypropylene box is to be frozen in 4 h. The total amount of heat removed from the fish and the box, the remaining amount of unfrozen water in fish, and the average rate of heat removal are to be determined.

Assumptions The box and the fish are at uniform temperatures at the beginning and at the end of the process.

Properties At a water content of 83.6 percent, the specific heat of the cod fish above freezing is given to be 0.89 Btu/lbm.°F. The specific heat of the box is given to be 0.45 Btu/h.ft.°F. The enthalpies of fish at 32 and -4°F are given to be $h_{\text{initial}} = 145$ Btu/lbm and $h_{\text{final}} = 18$ Btu/lbm. Also, the unfrozen water content of the fish at -4°F is given to be 9%.

Analysis (a) The amounts of heat removed as the cod fish is cooled from 60 to 32°F and then from 32°F to -4°F are

$$Q_{\text{cooling}} = mc_p (\Delta T)_{\text{cooling}} = (70 \text{ lbm})(0.89 \text{ Btu/lbm.}^\circ\text{F})(60 - 32)^\circ\text{F} = 1744 \text{ Btu}$$

$$Q_{\text{freezing}} = m(h_{\text{initial}} - h_{\text{final}}) = (70 \text{ lbm})[(145 - 18) \text{ Btu/lbm}] = 8890 \text{ Btu}$$

Also, the amount of heat removed as the box is cooled from 60 to -4°F is

$$Q_{\text{box}} = mc_p (\Delta T)_{\text{cooling}} = (3.5 \text{ lbm})(0.45 \text{ Btu/lbm.}^\circ\text{F})[60 - (-4)^\circ\text{F}] = 101 \text{ Btu}$$

Then the total amount of heat removed from the package as it is cooled from 60 to -4°F becomes

$$Q_{\text{total}} = Q_{\text{fish}} + Q_{\text{box}} = 1744 + 8890 + 101 = \mathbf{10,735 \text{ Btu}}$$

(b) The water content of the cod fish at -4°F is given to be 9%. Therefore, the total amount of unfrozen water in fish at -4°F is

$$m_{\text{unfrozen}} = (m_{\text{total}})(\% \text{ unfrozen}) = (70 \text{ lbm})(0.09) = \mathbf{6.3 \text{ lbm}}$$

(c) Noting that 10,735 Btu of heat is removed in 4 h, the average rate of heat removal from the fish and its container is determined to be

$$\dot{Q}_{\text{avg}} = \frac{Q_{\text{total}}}{\Delta t} = \frac{10,735 \text{ Btu}}{4 \text{ h}} = \mathbf{2684 \text{ Btu/h}}$$

17-94 Fresh carrots in polypropylene boxes are to be frozen at a rate of 50 boxes/h. The rate of heat removal from the carrots and the boxes and the rate at which the water in carrots freezes during this process are to be determined.

Assumptions The carrots and their boxes are at uniform temperatures at the beginning and at the end of the process.

Properties At a water content of 87.3 percent, the specific heat of carrots above freezing is given to be 3.90 kJ/kg.°C. The specific heat of the box is given to be 2.3 kJ/kg.°C. The enthalpies of carrots at 0 and -18°C are given to be $h_{\text{initial}} = 361$ kJ/kg and $h_{\text{final}} = 51$ kJ/kg. Also, the unfrozen water content of the carrots at -18°C is given to be 7%.

Analysis (a) Noting that the carrots are cooled at a rate of 50 boxes per hour, the carrots can be considered to be cooled steadily at a rate of

$$\dot{m}_{\text{carrots}} = (\text{Mass per box})(\text{No. of boxes per h}) = (30 \text{ kg/box})(50 \text{ boxes/h}) = 1,500 \text{ kg/h}$$

$$\dot{m}_{\text{box}} = (\text{Mass per box})(\text{No. of boxes per h}) = (1.4 \text{ kg/box})(50 \text{ boxes/h}) = 70 \text{ kg/h}$$

Then the rates of heat removed as the carrots are cooled from 22 to 0°C and then from 0°C to -18°C become

$$\dot{Q}_{\text{cooling}} = \dot{m}c_p(\Delta T)_{\text{cooling}} = (1500 \text{ kg/h})(3.90 \text{ kJ/kg}\cdot^{\circ}\text{C})(22 - 0)^{\circ}\text{C} = 128,700 \text{ kJ/h}$$

$$\dot{Q}_{\text{freezing}} = \dot{m}(h_{\text{initial}} - h_{\text{final}}) = (70 \text{ kg})[(361 - 51) \text{ kJ/kg}] = 465,000 \text{ kJ/h}$$

Also, the amount of heat removed as the box is cooled from 22 to -18°C is

$$\dot{Q}_{\text{box}} = \dot{m}c_p(\Delta T)_{\text{cooling}} = (70 \text{ kg/h})(2.3 \text{ kJ/kg}\cdot^{\circ}\text{C})[22 - (-18)^{\circ}\text{C}] = 6440 \text{ kJ/h}$$

Then the rate of total heat removal from the carrots and their boxes becomes

$$\dot{Q}_{\text{total}} = \dot{Q}_{\text{carrots}} + \dot{Q}_{\text{box}} = 128,700 + 465,000 + 6440 = 600,140 \text{ kJ/h} = \mathbf{166.7 \text{ kW}}$$

(b) The unfrozen water content of the carrots reduces from 87.5% (the entire water content) at 22°C to 7 percent at -18°C. Therefore, the rate at which water in the carrots freezes is

$$\dot{m}_{\text{water, frozen}} = (\dot{m}_{\text{water, total}})(\% \text{ frozen}) = (1,500 \text{ kg/h})(0.875 - 0.07) = 1208 \text{ kg/h} = \mathbf{0.336 \text{ kg/s}}$$

17-95 The chilling room of a meat plant with a capacity of 350 beef carcasses is considered. The refrigeration load, the volume flow rate of air, and the heat transfer area of the evaporator are to be determined.

Assumptions 1 Steady operating conditions exist. 2 Properties of beef carcass and air are constant.

Properties The density and specific heat of air are given to be 1.28 kg/m^3 and $1.0 \text{ kJ/kg}\cdot^\circ\text{C}$. The specific heat of beef carcass is given to be $3.14 \text{ kJ/kg}\cdot^\circ\text{C}$. The heat of fusion of water is given to be 334 kJ/kg , and the heat of vaporization of water is given to be 2490 kJ/kg .

Analysis (a) The amount of beef mass that needs to be cooled per unit time is

$$\dot{m}_{\text{beef}} = (\text{Total beef mass cooled}) / (\text{cooling time}) = (350 \times 280 \text{ kg}) / (10 \times 3600 \text{ s}) = 2.72 \text{ kg/s}$$

The product refrigeration load can be viewed as the energy that needs to be removed from the beef carcass as it is cooled from 35 to 16°C at a rate of 2.72 kg/s , and is determined to be

$$\dot{Q}_{\text{beef}} = (\dot{m} c_p \Delta T)_{\text{beef}} = (2.72 \text{ kg/s})(3.14 \text{ kJ/kg}\cdot^\circ\text{C})(35 - 16)^\circ\text{C} = 162 \text{ kW}$$

Then the total refrigeration load of the chilling room becomes

$$\dot{Q}_{\text{total, chilling room}} = \dot{Q}_{\text{beef}} + \dot{Q}_{\text{fan}} + \dot{Q}_{\text{lights}} + \dot{Q}_{\text{heat gain}} = 162 + 22 + 2 + 11 = \mathbf{197 \text{ kW}}$$

(b) Heat is transferred to air at the rate determined above, and the temperature of air rises from -2.2°C to 0.5°C as a result. Therefore, the mass and volume flow rates of air are

$$\dot{m}_{\text{air}} = \frac{\dot{Q}_{\text{air}}}{(c_p \Delta T)_{\text{air}}} = \frac{197 \text{ kW}}{(1.0 \text{ kJ/kg}\cdot^\circ\text{C})[0.5 - (-2.2)^\circ\text{C}]} = 72.9 \text{ kg/s}$$

$$\dot{V}_{\text{air}} = \frac{\dot{m}_{\text{air}}}{\rho_{\text{air}}} = \frac{72.9 \text{ kg/s}}{1.28 \text{ kg/m}^3} = \mathbf{56.9 \text{ m}^3/\text{s}}$$

(c) Normally the heat transfer load of evaporator is the same as the refrigeration load. But in this case the water which enter the evaporator as a liquid is frozen as the temperature drops to -2.2°C , and the evaporator must also remove the latent heat of freezing which is determined from

$$\dot{Q}_{\text{freezing}} = (\dot{m} h_{\text{latent}})_{\text{water}} = (0.080 \text{ kg/s})(334 \text{ kJ/kg}) = 27 \text{ kW}$$

Therefore, the total rate of heat removal at the evaporator is

$$\dot{Q}_{\text{evaporator}} = \dot{Q}_{\text{total, chill room}} + \dot{Q}_{\text{freezing}} = 197 + 27 = \mathbf{224 \text{ kW}}$$

Then the heat transfer surface area of the evaporator on the air side is determined from

$$\dot{Q}_{\text{evaporator}} = (UA)_{\text{airside}} \Delta T,$$

$$A = \frac{\dot{Q}_{\text{evaporator}}}{U \Delta T} = \frac{224,000 \text{ W}}{(22 \text{ W/m}^2\cdot^\circ\text{C})(5.5^\circ\text{C})} = \mathbf{1851 \text{ m}^2}$$

Obviously a finned surface must be used to provide such a large surface area on the air side.

17-96 Turkeys are to be cooled by chilled water in an immersion chiller. The rate of heat removal from the turkeys and the mass flow rate of water are to be determined.

Assumptions **1** Steady operating conditions exist. **2** The thermal properties of turkeys are constant.

Properties The specific heat of turkeys is given to be $3.28 \text{ kJ/kg}\cdot^\circ\text{C}$. The specific heat of water is $4.18 \text{ kJ/kg}\cdot^\circ\text{C}$ (Table A-9).

Analysis (a) Turkeys are dropped into the chiller at a rate of 200 per hour. Therefore, turkeys can be considered to flow steadily through the chiller at a mass flow rate of

$$\dot{m}_{\text{turkey}} = (200 \text{ turkey/h})(7.5 \text{ kg/chicken}) = 1500 \text{ kg/h} = 0.4167 \text{ kg/s}$$

Then the rate of heat removal from the turkeys as they are cooled from 14°C to 4°C at this rate becomes

$$\dot{Q}_{\text{turkey}} = (\dot{m}c_p\Delta T)_{\text{turkey}} = (0.4167 \text{ kg/s})(3.28 \text{ kJ/kg}\cdot^\circ\text{C})(14 - 4)^\circ\text{C} = \mathbf{13.7 \text{ kW}}$$

The chiller gains heat from the surroundings as a rate of $120 \text{ kJ/min} = 2.0 \text{ kJ/s}$. Then the total rate of heat gain by the water is

$$\dot{Q}_{\text{water}} = \dot{Q}_{\text{turkey}} + \dot{Q}_{\text{heat gain}} = 13.7 + 2.0 = 15.7 \text{ kW}$$

Noting that the temperature rise of water is not to exceed 2.5°C as it flows through the chiller and that the specific heat of water is $4.18 \text{ kJ/kg}\cdot^\circ\text{C}$, the mass flow rate of water must be at least

$$\dot{m}_{\text{water}} = \frac{\dot{Q}_{\text{water}}}{(c_p\Delta T)_{\text{water}}} = \frac{15.7 \text{ kW}}{(4.18 \text{ kJ/kg}\cdot^\circ\text{C})(2.5^\circ\text{C})} = \mathbf{1.50 \text{ kg/s}}$$

If the mass flow rate of water is less than this value, then the temperature rise of water will have to be more than 2.5°C .

17-97E In a chicken processing plant, the center temperature of whole chickens is to be lowered by chilled air below 40°F while the surface temperature remains above 33°F to avoid freezing. The average heat transfer coefficient during this cooling process is to be determined.

Assumptions **1** Chickens can be approximated as spheres. **2** Heat conduction in the chickens is one-dimensional in the radial direction because of symmetry about the midpoint. **3** The thermal properties of chickens are constant. **4** The heat transfer coefficient is constant and uniform over the entire surface. **5** The Fourier number is $\tau > 0.2$ so that the one-term approximate solutions (or the transient temperature charts) are applicable (this assumption will be verified).

Properties The thermal properties of the chickens are given to be $\rho = 65.5 \text{ lbm/ft}^3$, $c_p = 0.85 \text{ Btu/lbm}\cdot^\circ\text{F}$, $k = 0.27 \text{ Btu/h}\cdot\text{ft}\cdot^\circ\text{F}$, and $\alpha = 1.4 \times 10^{-6} \text{ ft}^2/\text{s}$.

Analysis The equivalent radius of the chickens is

$$r = \left(\frac{3}{4\pi} \mathcal{V} \right)^{1/3} = \left(\frac{3}{4\pi} \frac{m_{\text{chicken}}}{\rho_{\text{chicken}}} \right)^{1/3} = \left(\frac{3}{4\pi} \frac{5 \text{ lbm}}{65.5 \text{ lbm/ft}^3} \right)^{1/3} = 0.263 \text{ ft}$$

The lowest temperature in the chickens will occur at the surfaces and the highest temperature at the center at a given time since the inner part of the chickens will be last place to be cooled. In the limiting case, the surface temperature at $r = r_o = 0.263 \text{ ft}$ from the center will be 33°F while the center temperature is 40°F in an environment at 5°F. Then from Fig. 4-17b we obtain

$$\left. \begin{aligned} \frac{r}{r_o} &= \frac{0.263 \text{ ft}}{0.263 \text{ ft}} = 1 \\ \frac{T(r_o, t) - T_\infty}{T_o - T_\infty} &= \frac{33 - 5}{40 - 5} = 0.80 \end{aligned} \right\} \frac{1}{\text{Bi}} = \frac{k}{hr_o} = 2.1$$

which gives

$$h = \frac{1}{2.1} \frac{k}{r_o} = \frac{0.53 \text{ Btu/h}\cdot\text{ft}\cdot^\circ\text{F}}{2.1(0.263 \text{ ft})} = \mathbf{0.96 \text{ Btu/h}\cdot\text{ft}^2\cdot^\circ\text{F}}$$

Therefore, the convection heat transfer coefficient should be kept below this value to satisfy the constraints on the temperature of the chickens during refrigeration. We can also meet the constraints by using a lower heat transfer coefficient, but doing so would extend the refrigeration time unnecessarily.

17-98 A person puts a few peaches into the freezer to cool them quickly. The center and surface temperatures of the peaches in 45 minutes as well as the amount of heat transfer from each peach are to be determined.

Assumptions 1 The peaches are spherical in shape with a radius of $r_o = 4$ cm. **2** Heat conduction in the peaches is one-dimensional in the radial direction because of symmetry about the midpoint. **3** The thermal properties of the peaches are constant. **4** The heat transfer coefficient is constant and uniform over the entire surface. **5** The Fourier number is $\tau > 0.2$ so that the one-term approximate solutions (or the transient temperature charts) are applicable (this assumption will be verified).

Properties The properties of peaches are given to be $\rho = 960$ kg/m³, $c_p = 3.9$ kJ/kg·°C, $k = 0.53$ W/m·°C, and $\alpha = 0.14 \times 10^{-6}$ m²/s.

Analysis (a) The Biot and Fourier numbers become

$$\text{Bi} = \frac{hr_o}{k} = \frac{(18 \text{ W/m}^2 \cdot \text{°C})(0.04 \text{ m})}{0.53 \text{ W/m} \cdot \text{°C}} = 1.358$$

$$\tau = \frac{\alpha t}{r_o^2} = \frac{(0.14 \times 10^{-6} \text{ m}^2/\text{s})(45 \times 60 \text{ s})}{(0.04 \text{ m})^2} = 0.236$$

Note that $\tau = 0.236 > 0.2$, and thus the one-term solution is applicable. From Table 4-2 we read, for a sphere, $\lambda_1 = 1.735$ and $A_1 = 1.347$. Substituting these values into the one-term solution, the center temperature of the peaches 45 min after the start of the cooling is determined to be

$$\theta_0 = \frac{T_o - T_\infty}{T_i - T_\infty} = A_1 e^{-\lambda_1^2 \tau} \rightarrow \frac{T_o - (-18)}{20 - (-18)} = 1.347 e^{-(1.735)^2 (0.236)} = 0.662 \rightarrow T_o = 7.2^\circ\text{C}$$

The lowest temperature during cooling will occur on the surface ($r/r_o = 1$), and is determined to be

$$\frac{T(r) - T_\infty}{T_i - T_\infty} = A_1 e^{-\lambda_1^2 \tau} \frac{\sin(\lambda_1 r / r_o)}{\lambda_1 r / r_o} \rightarrow \frac{T(r_o) - T_\infty}{T_i - T_\infty} = \frac{T_o - T_\infty}{T_i - T_\infty} \frac{\sin(\lambda_1 r_o / r_o)}{\lambda_1 r_o / r_o}$$

$$\text{Substituting, } \frac{T(r_o) - (-18)}{20 - (-18)} = 0.662 \frac{\sin(1.735 \text{ rad})}{1.735} \rightarrow T(r_o) = -3.7^\circ\text{C}$$

Note that the outer parts of the peaches will freeze during this process. The maximum heat transfer from the peach is

$$m = \rho V = \rho \left(\frac{4}{3} \pi r_o^3 \right) = (960 \text{ kg/m}^3) \left(\frac{4}{3} \pi (0.04 \text{ m})^3 \right) = 0.257 \text{ kg}$$

$$Q_{\max} = mc_p (T_i - T_\infty) = (0.257 \text{ kg})(3.90 \text{ kJ/kg} \cdot \text{°C})[20 - (-18)]^\circ\text{C} = 38.1 \text{ kJ}$$

Also,

$$\frac{Q}{Q_{\max}} = 1 - 3\theta_0 \frac{\sin \lambda_1 - \lambda_1 \cos \lambda_1}{\lambda_1^3} = 1 - 3 \times 0.662 \frac{\sin(1.735 \text{ rad}) - 1.735 \cos(1.735 \text{ rad})}{1.735^3} = 0.517$$

Then the heat transfer from each peach becomes

$$Q = \frac{Q}{Q_{\max}} Q_{\max} = 0.517 \times (38.1 \text{ kJ}) = 19.7 \text{ kJ}$$

Alternative solution We could also solve this problem using transient temperature charts. There may be a slight difference between the two results, however, because of the reading errors of the chart.

17-99 A refrigeration system is to cool bread loaves at a rate of 500 per hour by refrigerated air at -30°C . The rate of heat removal from the breads, the required volume flow rate of air, and the size of the compressor of the refrigeration system are to be determined.

Assumptions **1** Steady operating conditions exist. **2** The thermal properties of the bread loaves are constant. **3** The cooling section is well-insulated so that heat gain through its walls is negligible.

Properties The average specific and latent heats of bread are given to be $2.93 \text{ kJ/kg}\cdot^{\circ}\text{C}$ and 109.3 kJ/kg , respectively. The gas constant of air is $0.287 \text{ kPa}\cdot\text{m}^3/\text{kg}\cdot\text{K}$ (Table A-1), and the specific heat of air at the average temperature of $(-30 + -22)/2 = -26^{\circ}\text{C} \approx 250 \text{ K}$ is $c_p = 1.0 \text{ kJ/kg}\cdot^{\circ}\text{C}$ (Table A-15).

Analysis (a) Noting that the breads are cooled at a rate of 500 loaves per hour, breads can be considered to flow steadily through the cooling section at a mass flow rate of

$$\dot{m}_{\text{bread}} = (500 \text{ breads/h})(0.45 \text{ kg/bread}) = 225 \text{ kg/h} = 0.3056 \text{ kg/s}$$

Then the rate of heat removal from the breads as they are cooled from 22°C to -10°C and frozen becomes

$$\dot{Q}_{\text{bread}} = (\dot{m}c_p\Delta T)_{\text{bread}} = (225 \text{ kg/h})(2.93 \text{ kJ/kg}\cdot^{\circ}\text{C})[(22 - (-10))^{\circ}\text{C}] = 21,096 \text{ kJ/h}$$

$$\dot{Q}_{\text{freezing}} = (\dot{m}h_{\text{latent}})_{\text{bread}} = (225 \text{ kg/h})(109.3 \text{ kJ/kg}) = 24,593 \text{ kJ/h}$$

and $\dot{Q}_{\text{total}} = \dot{Q}_{\text{bread}} + \dot{Q}_{\text{freezing}} = 21,096 + 24,593 = \mathbf{45,689 \text{ kJ/h}}$

(b) All the heat released by the breads is absorbed by the refrigerated air, and the temperature rise of air is not to exceed 8°C . The minimum mass flow and volume flow rates of air are determined to be

$$\dot{m}_{\text{air}} = \frac{\dot{Q}_{\text{air}}}{(c_p\Delta T)_{\text{air}}} = \frac{45,689 \text{ kJ/h}}{(1.0 \text{ kJ/kg}\cdot^{\circ}\text{C})(8^{\circ}\text{C})} = 5,711 \text{ kg/h}$$

$$\rho = \frac{P}{RT} = \frac{101.3 \text{ kPa}}{(0.287 \text{ kPa}\cdot\text{m}^3/\text{kg}\cdot\text{K})(-30 + 273) \text{ K}} = 1.45 \text{ kg/m}^3$$

$$\dot{V}_{\text{air}} = \frac{\dot{m}_{\text{air}}}{\rho_{\text{air}}} = \frac{5,711 \text{ kg/h}}{1.45 \text{ kg/m}^3} = \mathbf{3939 \text{ m}^3/\text{h}}$$

(c) For a COP of 1.2, the size of the compressor of the refrigeration system must be

$$\dot{W}_{\text{refrig}} = \frac{\dot{Q}_{\text{refrig}}}{\text{COP}} = \frac{45,689 \text{ kJ/h}}{1.2} = 38,074 \text{ kJ/h} = \mathbf{10.6 \text{ kW}}$$

17-100 A holding freezer is maintained at -23°C in an environment at 14°C . The amount of electricity and money saved per year by increasing the insulation value of the walls to the recommended level of $R-8.5$ and the percent error involved in the total thermal resistance of the roof in neglecting the convection resistances are to be determined.

Assumptions **1** The convection heat transfer coefficients remain constant. **2** The properties of insulation are constant. **3** The thermal resistances of metal plates are negligible.

Properties The thermal resistance of the wall is given to be $R_{\text{roof}} = 4 \text{ m}^2 \cdot ^{\circ}\text{C}/\text{W}$.

Analysis The roof area of the freezer is

$$A_o = (70 \text{ m})(22 \text{ m}) = 1540 \text{ m}^2$$

The current rate of heat gain through the roof is

$$\dot{Q}_{\text{current}} = \frac{A_o (T_o - T_i)}{\frac{1}{h_i} + R_{\text{wall}} + \frac{1}{h_o}} = \frac{(1540 \text{ m}^2)[14 - (-23)^{\circ}\text{C}]}{\left(\frac{1}{12} + 4 + \frac{1}{30}\right) \text{ m}^2 \cdot ^{\circ}\text{C}/\text{W}} = 13,840 \text{ W}$$

The rate of heat gain through the roof after insulation is installed is

$$\dot{Q}_{\text{insulated}} = \frac{A_o (T_o - T_i)}{\frac{1}{h_i} + R_{\text{wall,insulated}} + \frac{1}{h_o}} = \frac{(1540 \text{ m}^2)[14 - (-23)^{\circ}\text{C}]}{\left(\frac{1}{12} + 8.5 + \frac{1}{30}\right) \text{ m}^2 \cdot ^{\circ}\text{C}/\text{W}} = 6613 \text{ W}$$

Therefore, the rates of heat and electricity saved due to insulation are

$$\dot{Q}_{\text{saved}} = \dot{Q}_{\text{current}} - \dot{Q}_{\text{insulated}} = 13,840 - 6613 = 7227 \text{ W}$$

$$\dot{E}_{\text{electric,saved}} = \dot{Q}_{\text{saved}} / \text{COP} = (7227 \text{ W}) / 1.25 = 5782 \text{ W}$$

Noting that the unit cost of electricity is $\$0.07/\text{kWh}$ and assuming year-around continual operation, the amount of electricity and money saved per year due to insulation are

$$\text{Electricity saved} = \dot{E}_{\text{electric,saved}} \times (\text{Operating hours}) = (5.782 \text{ kW})(365 \times 24 \text{ h/yr}) = \mathbf{50,650 \text{ kWh/yr}}$$

$$\text{Money saved} = (\text{Electricity saved})(\text{Unit cost of electricity}) = (50,650 \text{ kWh/yr})(\$0.07/\text{kWh}) = \mathbf{\$3546/\text{yr}}$$

The total thermal resistance of the roof is

$$R_{\text{total}} = \frac{1}{h_i} + R_{\text{ins}} + \frac{1}{h_o} = \frac{1}{12} + 4 + \frac{1}{30} = 4.12 \text{ m}^2 \cdot ^{\circ}\text{C}/\text{W}$$

If the convection resistances on both sides are neglected, the total resistance would simply be the roof resistance, which is $R_{\text{roof}} = 4 \text{ m}^2 \cdot ^{\circ}\text{C}/\text{W}$. Therefore, neglecting the convection resistances would cause an error of $(4.12 - 4.0)/4.12 = 0.029$ or 2.9%, which is acceptable for most engineering purposes. The error in the insulated wall case would be half as much.

17-101 Milk is to be transported in a cylindrical tank by a truck. It is to be determined if the milk can be transported without any refrigeration.

Assumptions Thermal properties of milk and insulation are constant.

Properties The thermal conductivity of urethane is given to be $k = 0.029 \text{ W/m}\cdot\text{C}$. The density and specific heat of refrigerated milk at temperatures near 0°C are $\rho_{\text{milk}} \cong \rho_{\text{water}} = 1000 \text{ kg/m}^3$ and $c_{p, \text{milk}} = 3.79 \text{ kJ/kg}\cdot\text{C}$ (Table A-7).

Analysis Problems of this kind which involve “checking” are best solved by performing the calculations under the worst conditions, with the understanding that if the performance is satisfactory under those conditions, it will surely be satisfactory under any conditions.

We take the average ambient temperature to be 32°C , which is the highest possible, and raise it to 37°C to account for the radiation from the sun and the pavement. We also assume the metal sheets to offer no resistance to heat transfer, and assume the convection resistances on the inner and outer sides of the tank wall to be negligible. Under those conditions, the inner and outer surface temperatures of the insulation will be equal to the milk and ambient temperatures, respectively. Further, we take the milk temperature to be 2°C during heat transfer calculations (to maximize the temperature difference), and take the heat transfer area to be the outer surface area of the tank (instead of the smaller inner surface area) which is determined to be

$$A = 2A_{\text{base}} + A_{\text{side}} = 2(\pi D_o^2 / 4) + (\pi D_o)L_o = 2\pi(2.2 \text{ m})^2 / 4 + \pi(2.2 \text{ m})(8 \text{ m}) = 62.9 \text{ m}^2$$

Then the rate of heat transfer through the insulation into the milk becomes

$$\dot{Q} = k_{\text{ins}} A \frac{\Delta T_{\text{ins}}}{L_{\text{ins}}} = (0.026 \text{ W/m}\cdot\text{C})(62.9 \text{ m}^2) \frac{(37 - 2)^\circ\text{C}}{0.03 \text{ m}} = \mathbf{1908 \text{ W}}$$

This is the highest possible rate of heat transfer into the milk it is determined under the most favorable conditions for heat transfer.

At an average velocity of 60 km/h , transporting the milk 1600 km will take

$$\Delta t = \frac{\text{Distance traveled}}{\text{Average velocity}} = \frac{1600 \text{ km}}{60 \text{ km/h}} = 26.6 \text{ h}$$

Then the total amount of heat transfer to the milk during this long trip becomes

$$Q = \dot{Q}\Delta t = (1,908 \text{ J/s})(26.6 \times 3600 \text{ s}) = 182,710,080 \text{ J} = 182,710 \text{ kJ}$$

Taking the density of the milk to be the same as that of water (1000 kg/m^3) and noting that the thickness of insulation is 0.03 m on all sides, the volume and mass of the milk in a full tank is determined to be

$$V_{\text{milk}} = (\pi D_i^2 / 4)L_i = [\pi(2.14 \text{ m})^2 / 4](7.94 \text{ m}) = 28.55 \text{ m}^3$$

$$m_{\text{milk}} = \rho V_{\text{milk}} = (1000 \text{ kg/m}^3)(28.55 \text{ m}^3) = 28,550 \text{ kg}$$

Noting that the specific heat of the milk is $3.98 \text{ kJ/kg}\cdot\text{C}$, the transfer of $182,710 \text{ kJ}$ of heat into the milk will raise its temperature to

$$Q = mc_p(T_2 - T_1) \rightarrow T_2 = T_1 + \frac{Q}{mc_p} = 2^\circ\text{C} + \frac{182,710 \text{ kJ}}{(28,550 \text{ kg})(3.79 \text{ kJ/kg}\cdot\text{C})} = \mathbf{3.7^\circ\text{C}}$$

That is, the temperature of the milk will rise from 2 to 3.7°C during this long trip under the most adverse conditions, which is well below 5°C limit. Therefore, the milk can be transported even longer distances without any refrigeration.

17-102 17-107 Design and Essay Problems

